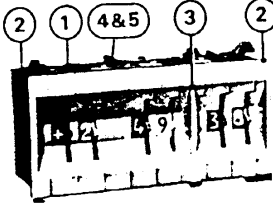
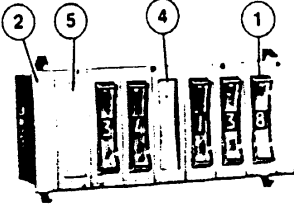
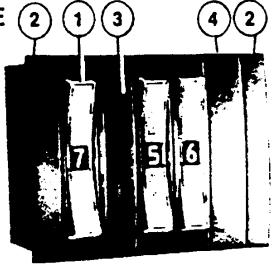
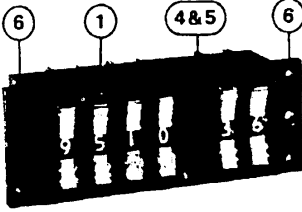
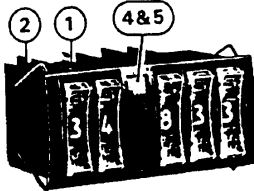
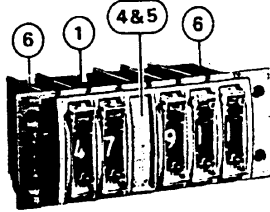
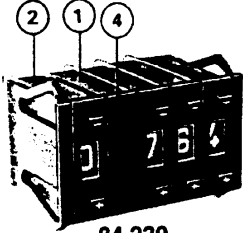
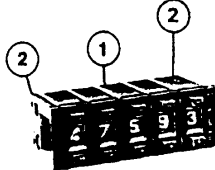
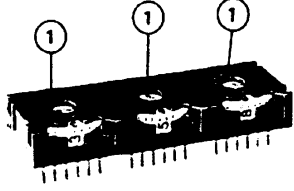

Index

<p>STANDARD</p>  <p>84 210 Thumbwheel Standard – Panel Mount Page 5</p>	<p>STANDARD</p>  <p>84 211 Rocker Standard – Panel Mount Page 6</p>	<p>LARGE</p>  <p>84 212 Rocker Large – Panel Mount Page 7</p>
<p>STANDARD</p>  <p>84 213 Rocker Standard – Rear Mount Page 8</p>	<p>MINIATURE</p>  <p>84 214 Rocker Miniature – Panel Mount Page 9</p>	<p>MINIATURE</p>  <p>84 218 Rocker Miniature – Rear Mount Page 10</p>
<p>MINIATURE</p>  <p>84 230 Push Button Miniature – Panel Mount Page 12</p>	<p>SUBMINIATURE</p>  <p>84 231 Push Button Subminiature – Panel Mount Page 13</p>	 <p>84 235 Thumbwheel PCB – Flat Mount Page 14</p>

- 1 – **Basic Module:** Enable data input in coded form.
- 2 – **End Caps:** Snap into place to complete module assembly. Complete with 4 panel clips.
- 3 – **Separator:** Used to fit 2 switch assemblies into one unit. They come with 2 clips.
- 4 – **Spacer:** Blank module used to replace a module assembly.
- 5 – **Encoded "Dummy" Module:** Enables simultaneous switching to two circuits from one digital switch, it is driven by the adjacent module via a coupling shaft.
- 6 – **End Caps:** For rear mounting of module assembly. They come in pairs.

Other Index Items	Page
General Information	3
Truth Tables	11 & 15
How To Order – (Switches)	16
L.E.D. Readout	17-22
How To Order – (L.E.D. Readouts)	23

Crouzet® Digital Switches

General Information

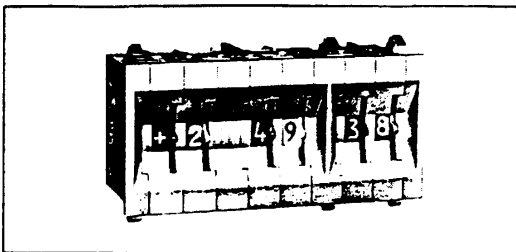

Wheel Marking

- Large size figures or symbols give maximum readability.
- Complies with European Aeronautics standard BN Aë – NF L 70130.
- Special markings are available on request.

Assembly Series: 84210, 84211, 84212, 84213, 84214, 84218

- Modules snap into place – easily disassembled
- No mounting hardware needed

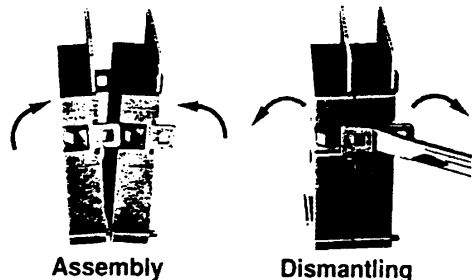

Assembly Series: 84230, 84231, 84235

- Snap fit – No tools, no hardware

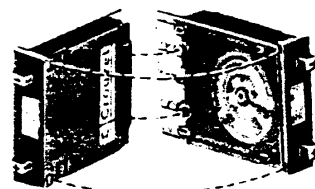

Clip Mounting Series 84210, 84211, 84212, 84213, 84214, 84218

- Two clip assembly combination available: Panel thickness – .06 - .14 in. (1.5 - 3.5mm) Panel thickness – .126 - .24 in. (3.2 - 6mm).
- Clips supplied in pairs with end plates or spacers.

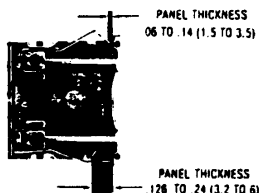

Dimensions in inches (mm)

Series 84230, 84231, 84235

- No clip mounting necessary
- Clips molded in end caps

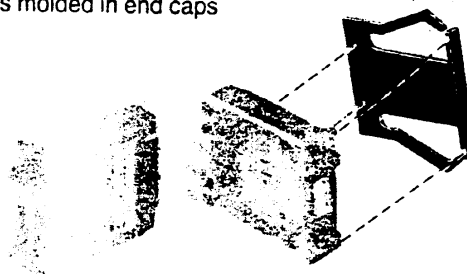

Colors

- Standard modules come in black (grey upon request).
- Standard wheels are black or red with white markings.
- Optional wheels: (except series 84230, 84231, 84235) Green or blue with white markings. Yellow with black markings

Dial Stops

- Limit the rotation of the dial to any number of positions, to be specified when ordering.

Circuit Boards

- All our digital switches are provided with printed circuit boards made of glass-filled P.C. 75 epoxy composite board, .03 in. (.08 mm) thick, covered with copper plated with nickel and gold.
- Two types of circuit boards are available: Short for direct connection or long for component mounting such as resistors or diodes, in series or parallel. (See photos).
- **Note** 84231 – MO1 and MO3: no long circuit board and no hole on circuit available.

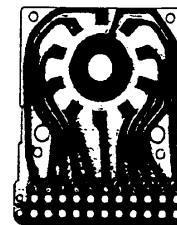
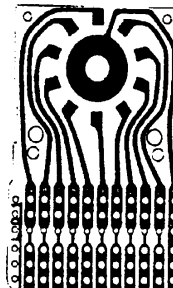
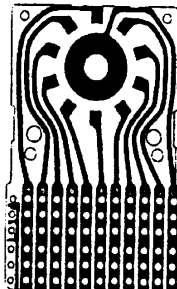

Crouzet® Digital Switches

Switch Terminations and Connectors

Terminals

- Three types of terminations:
 Direct soldering or plug-in for connectors (S)
 Pins for wire wrapping (X2) – Except Series 84230, 84231, 84235
 Pins for P.C. board soldering (X3).

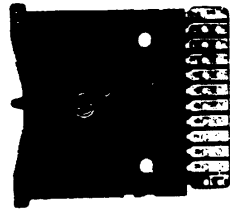

S

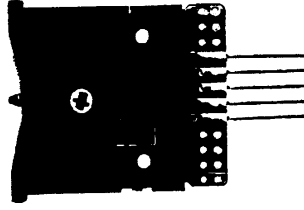

X2

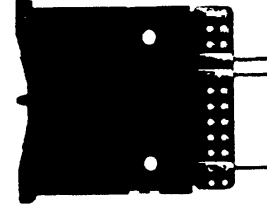

X3

Connectors (for Series 84210, 84211, 84212, 84213)

- Connectors available:
 Solder terminals (W2)
 Wire wrap terminals (X2)
 P.C. board solder terminals (X3).

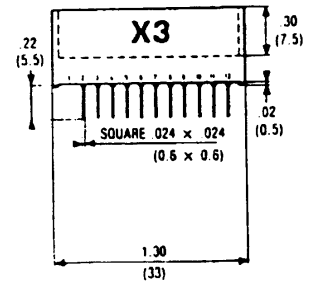
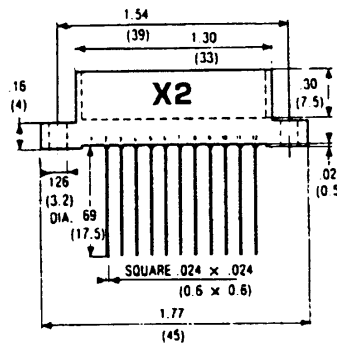
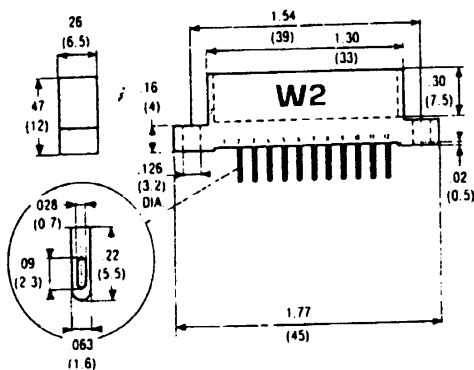
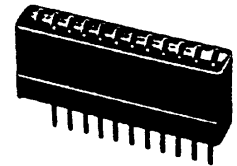
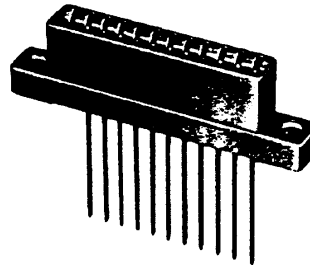
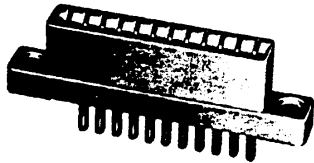

Dimensions in inches (mm)

Crouzet® Digital Switches

Thumbwheel - standard - panel mount Series 84 210

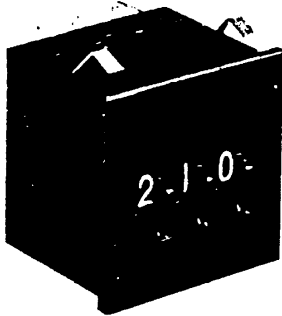

- Large numerals — .18 in. (4.5 mm) high
- All modules easily assembled without hardware
- Black or red wheels standard—other colors on request
- Right-sided circuits — left-sided optional
- Modules will accommodate our L.E.D. readouts

Mechanical & Electrical Specifications		Materials
<p>Operating Voltage: .1 to 250 V AC .1 to 50 V DC</p> <p>Nominal Electrical Load (Resistive Load): .1 mA to 100 mA</p> <p>Maximum Non-Switching Load: 1 A</p> <p>Contact Resistance: 70 mΩ max.</p> <p>Life at 50 V DC, .1 A, Resistive Load: 1 million operations</p> <p>Note: For voltages and currents less than the above values, please consult us.</p>	<p>Dielectric Strength: 600 V</p> <p>Operating Temperatures: —13° F. to 158° F. (—25° C. to 70° C.)</p> <p>Storage Temperatures: —40° F. to 185° F. (—40° C. to 85° C.)</p> <p>Dial Character Dimensions: .18 in. x .11 in. (4.5 mm x 2.8 mm)</p> <p>Operating Torque: 10 oz. (300 g)</p>	<p>Case: Noryl</p> <p>Wheel: Delrin</p> <p>Contacts and Tracks: Copper—Nickel—Gold</p> <p>Brush: Beryllium bronze</p> <p>Printed Circuit Board: Glass-filled epoxy (P.C. 75)</p>

Option: The P.C. boards of the standard 84 210 type modules are mounted on the right side of the module. The decimal and BCD codes can, optionally, be mounted onto the left side of the module. In this case the outputs are as shown below. Please contact us.

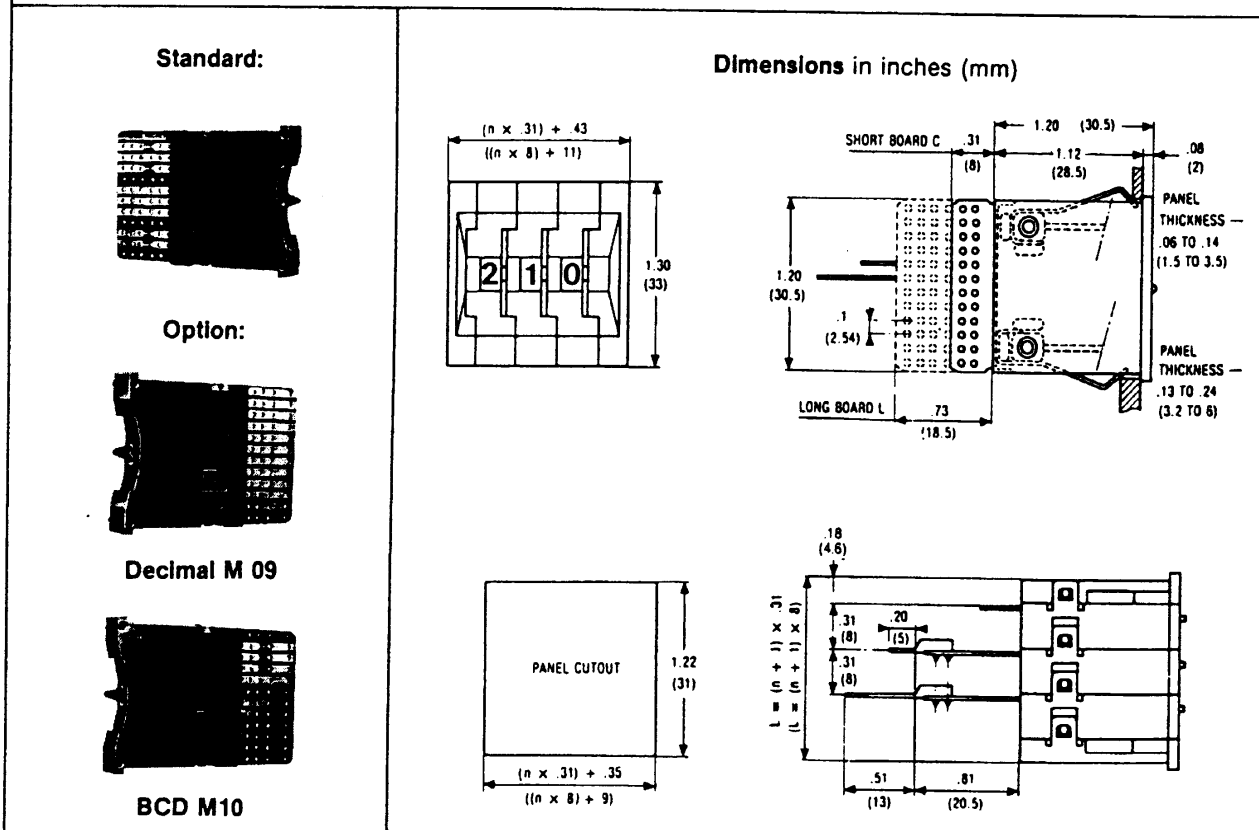



Digital Switches

Rocker Switch - standard - panel mount Series 84 211

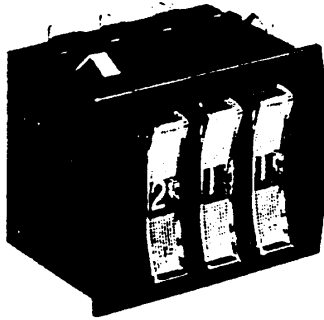

- Fast switching in both directions
- Large numerals — .18 in. (4.5 mm) high
- All modules easily assembled without hardware
- Good looking—easy to read
- Black or red wheels standard — other colors on request

Mechanical & Electrical Specifications

Operating Voltage: .1 to 250 V AC
 .1 to 50 V DC
Nominal Electrical Load (Resistive Load):
 .1 mA to 100 mA
Maximum Non-Switching Load: 1 A
Contact Resistance: 70 mΩ max.
Life at 50 V DC, .1 A, Resistive Load: 1 million operations
Note: For voltages and currents less than the above values, please consult us.

Dielectric Strength: 600 V
Operating Temperatures: —13° F. to 158° F. (—25° C. to 70° C.)
Storage Temperature: —40° F. to 185° F. (—40° C. to 85° C.)
Dial Character Dimensions: .18 in. x .11 in. (4.5 mm x w.8 mm)
Operating Force at End of Rocker: 17 oz. (500 g)

Materials

Case: Noryl
Wheel: Delrin
Rocker Actuator: Makrolon* (Polycarbonate)
Contacts and Tracks: Copper—Nickel—Gold
Brush: Beryllium bronze
Printed Circuit Board: Glass-filled epoxy (P.C. 75)
 *Special elements not used in other manufacturers' products.

Dimensions in inches (mm)

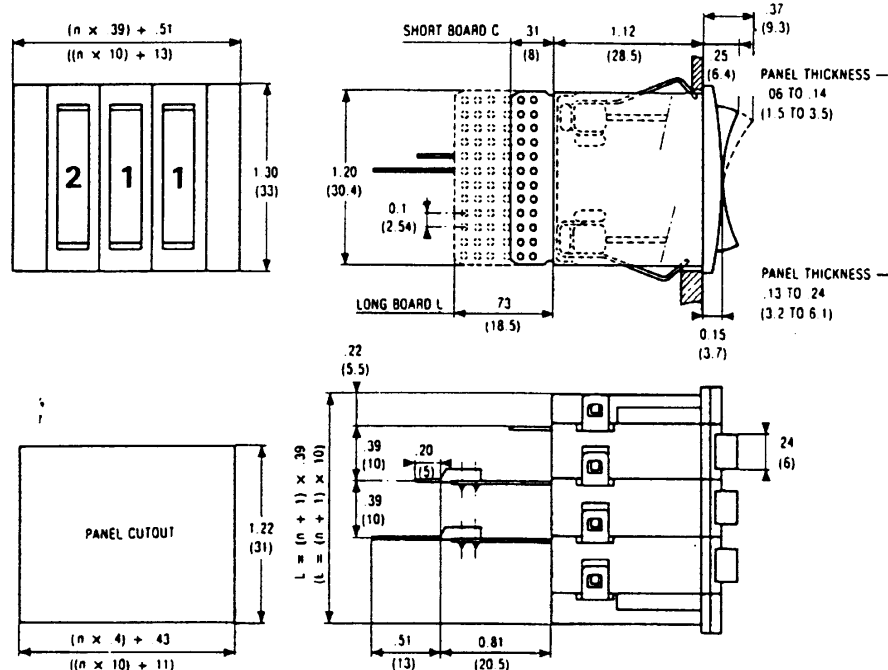

Digital Switches

Rocker Switch - large - panel mount Series 84 212

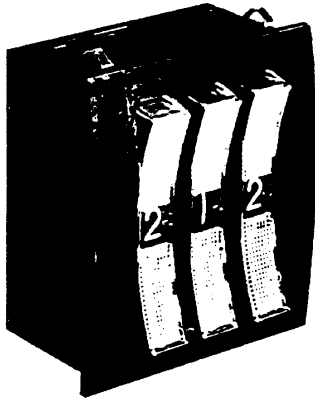

- Fast switching with large rocker actuator
- Extra large numerals — .24 in. (6 mm) high for easy reading
- All modules easily assembled without hardware
- Attractive

Mechanical & Electrical Specifications

Operating Voltage: .1 to 250 V AC
.1 to 50 V DC
Nominal Electrical Load (Resistive Load):
.1 mA to 100 mA
Maximum Non-Switching Load: 1 A
Contact Resistance: 70 mΩ max.
Life at 50 V DC, .1A, Resistive Load: 1 million operations
Note: For voltages and currents less than the above values, please consult us.

Dielectric Strength: 600 V
Operating Temperatures: —13° F. to 158° F. (—25° C. to 70° C.)
Storage Temperatures: —40° F. to 185° F. (—40° C. to 85° C.)
Dial Character Dimensions: .24 in. x .15 in. (6 mm x 3.75 mm)
Operating Force at End of Rocker: 10 oz. (300 g)

Materials

Case: Noryl
Wheel: Delrin
Rocker Actuator: Makrolon* (Polycarbonate)
Contacts and Tracks: Copper—Nickel—Gold
Brush: Beryllium bronze
Printed Circuit Board: Glass-filled epoxy (P.C. 75)
*Special elements not used in other manufacturers' products.

Dimensions in inches (mm)

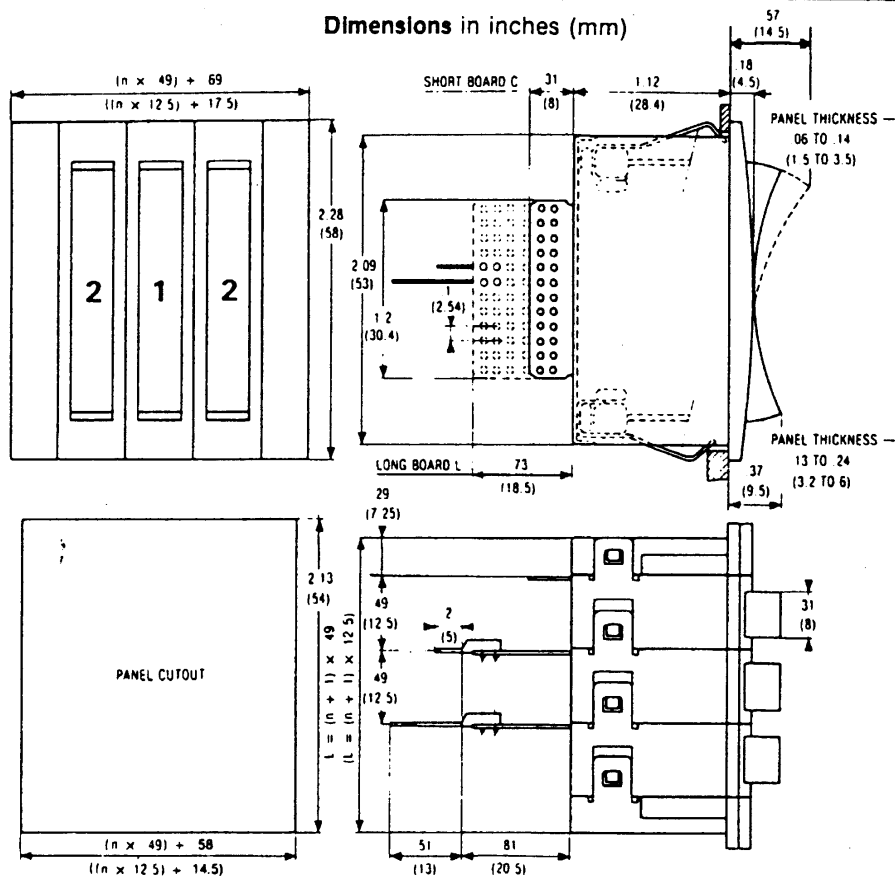

Digital Switches

Rocker Switch - standard - rear mount Series 84 213

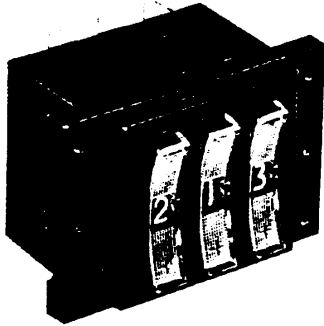

- Fast switching in both directions
- Large numerals — .18 in. (4.5 mm) high
- All modules easily assembled without hardware
- Good looking—easy to read
- Black or red wheels in stock — other colors on request

Mechanical & Electrical Specifications

Operating Voltage: .1 to 250 V AC
.1 to 50 V DC

Nominal Electrical Load (Resistive Load):
1 mA to 100 mA

Maximum Non-Switching Load: 1 A

Contact Resistance: 70 mΩ max.

Life at 50 V DC, .1 A, Resistive Load: 1 million operations

Note: For voltages and currents less than the above values, please consult us.

Dielectric Strength: 600 V

Operating Temperatures: —13° F. to 158° F. (—25° C. to 70° C.)

Storage Temperatures: —40° F. to 185° F. (—40° C. to 85° C.)

Dial Character Dimensions: .18 in. x .11 in. (4.5 mm x 2.8 mm)

Operating Force at End of Rocker: 17 oz. (500 g)

Materials

Case: Noryl

Wheel: Delrin

Rocker Actuator: Makrolon* (Polycarbonate)

Contacts and Tracks: Copper—Nickel—Gold

Brush: Beryllium bronze

Printed Circuit Board: Glass-filled epoxy (P.C. 75)

*Special elements not used in other manufacturers' products.

Dimensions in inches (mm)

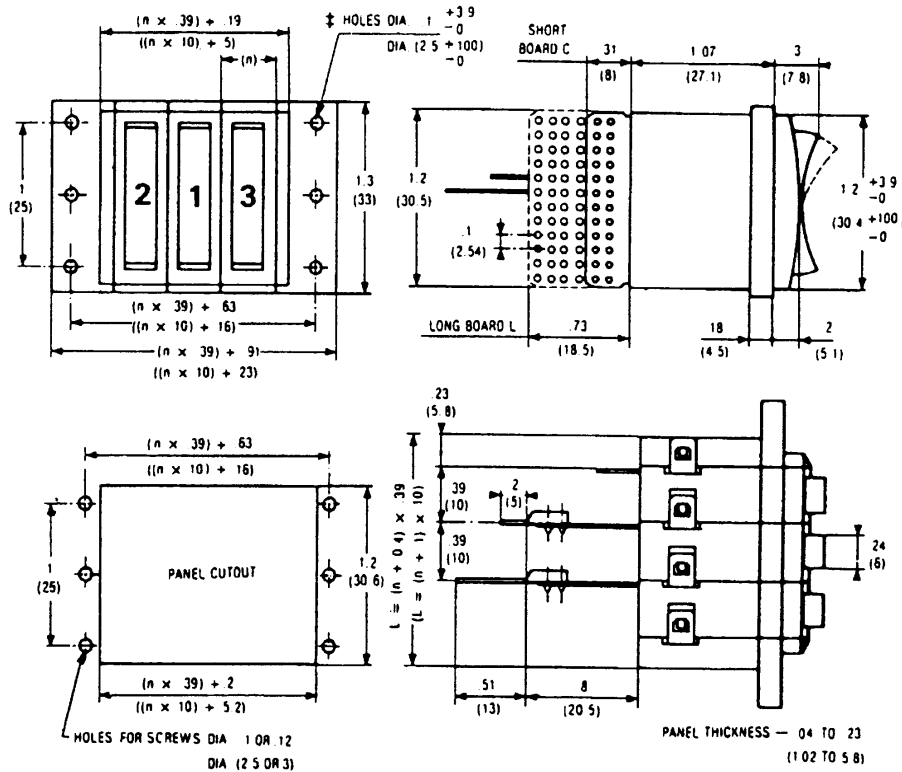

†Note: Mounting by screws and nuts .09 in. (2.5 mm) dia. or self-tapping screws .11 in. (3 mm) dia.

● Rocker Switches

Rocker Switch - miniature - panel mount Series 84 214

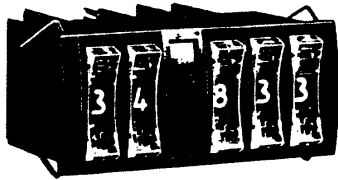

- Fast switching in both directions
- Large numerals — .16 in. (4.0 mm) high
- All modules easily assembled without hardware
- Good looking—easy to read
- Black wheels standard — other colors on request

Mechanical & Electrical Specifications

Operating Voltage: .1 to 250 V AC
.1 to 50 V DC

Nominal Electrical Load (Resistive Load):
.1 mA to 100 mA

Maximum Non-Switching Load: 1 A

Contact Resistance: 120 mΩ max.

Life at 50 V DC, .1A, Resistive Load: 1 million operations

Note: For voltages and currents less than the above values, please consult us.

Dielectric Strength: 600 V

Operating Temperatures: —13° F to 158° F. (—25° C. to 70° C.)

Storage Temperatures: —40° F. to 185° F. (—40° C. to 85° C.)

Dial Character Dimensions: .16 in. x .10 in. (4.0 mm x 2.5 mm)

Operating Force at End of Rocker: 17 oz. (500 g)

Materials

Case: Noryl

Wheel: Delrin

Rocker Actuator: Makrolon® (Polycarbonate)

Contacts and Tracks: Copper—Nickel—Gold

Brush: Beryllium bronze

Printed Circuit Board: Glass-filled epoxy (P.C. 75)

*Special elements not used in other manufacturers' products.

Dimensions in inches (mm)

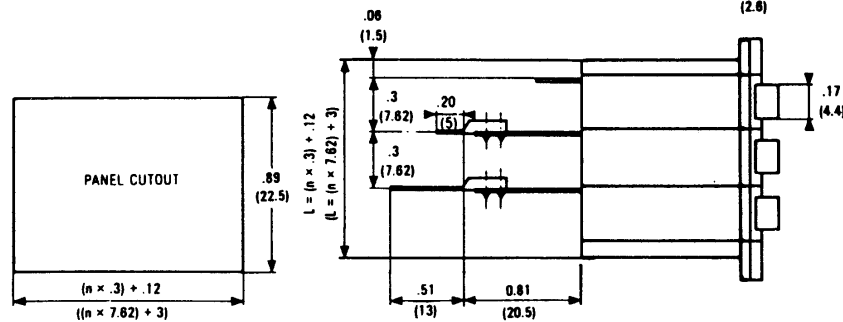
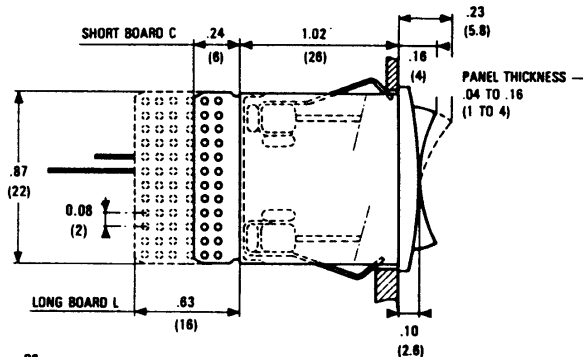
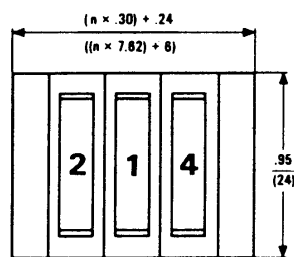

Rocker Switches

Rocker Switch - miniature - rear mount Series 84 218

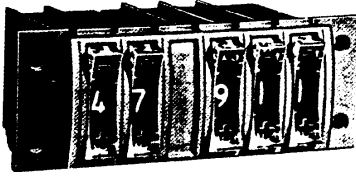

- Fast switching in both directions
- Large numerals — .16 in. (4.0 mm) high
- All modules easily assembled without hardware
- Good looking—easy to read
- Black wheels in stock — other colors on request

Mechanical & Electrical Specifications

Operating Voltage: .1 to 250 V AC
.1 to 50 V DC

Nominal Electrical Load (Resistive Load):
.1 mA to 100 mA

Maximum Non-Switching Load: 1 A

Contact Resistance: 120 mΩ max.

Life at 50 V DC, .1 A, Resistive Load: 1 million operations

Note: For voltages and currents less than the above values, please consult us.

Dielectric Strength: 600 V

Operating Temperatures: —13° F. to 158° F. (—25° C. to 70° C.)

Storage Temperatures: —40° F. to 185° F. (—40° C. to 85° C.)

Dial Character Dimensions: .16 in. x .10 in. (4.0 mm x 2.5 mm)

Operating Force at End of Rockers: 17 oz. (500 g)

Materials

Case: Noryl

Wheel: Delrin

Rocker Actuator: Makrolon® (Polycarbonate)

Contacts and Tracks: Copper—Nickel—Gold

Brush: Beryllium bronze

Printed Circuit Board: Glass-filled epoxy (P.C. 75)

*Special elements not used in other manufacturers' products.

Dimensions in inches (mm)

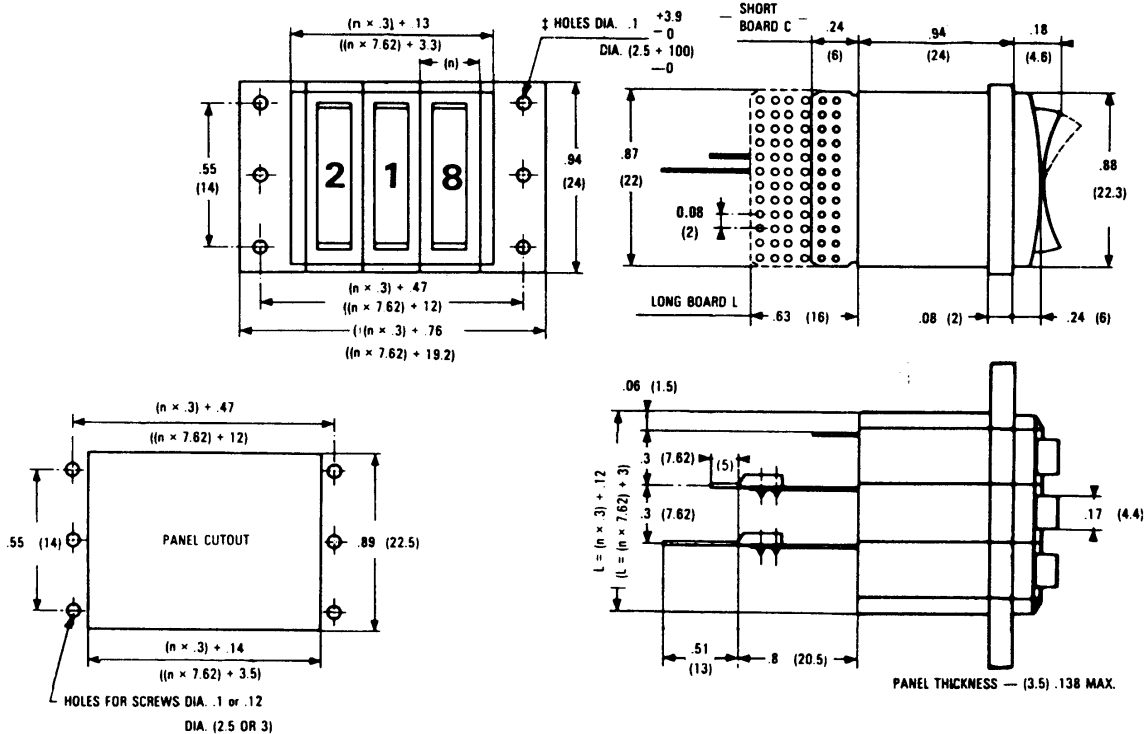

‡Note: Mounting by screws and nuts .09 in. (2.5 mm) dia. or self-tapping screws .11 in. (3 mm) dia.

Crouzet® Digital Switches

Truth Tables - Series 84 210 - 84 211 - 84 212 - 84 213 - 84 214 - 84 218

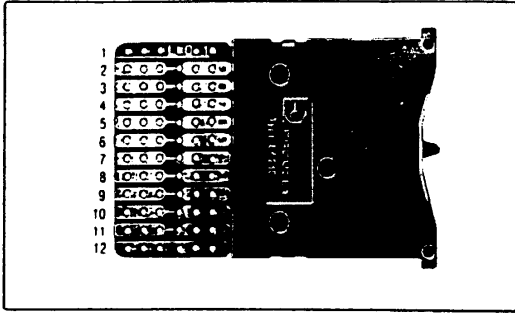

This photograph shows the numbering of each terminal for location purposes only.

The dots indicate the inter-connected tracks for each of the dial settings.

Decimal M01—M13—M14 (see note)

		C	0	1	2	3	4	5	6	7	8	9
Location on PC Board		12	11	10	9	8	7	6	5	4	3	2
Dial Setting	0	•	•									
	1	•		•								
	2	•			•							
	3	•				•						
	4	•					•					
	5	•						•				
	6	•							•			
	7	•								•		
	8	•									•	
	9	•										•

B.C.D.—M02

		C	1	2	4	8
Location on PC Board		9	8	7	6	5
Dial Setting	0	•				
	1	•	•			
	2	•		•		
	3	•	•	•		
	4	•			•	
	5	•	•	•	•	
	6	•				•
	7	•	•	•	•	
	8	•				•
	9	•	•			•

B.C.D. + Complement—M03

		C	1	2	4	8	$\bar{1}$	$\bar{2}$	$\bar{4}$	$\bar{8}$
Location on PC Board		7	6	5	4	3	11	10	9	8
Dial Setting	0	•					•	•	•	•
	1	•	•					•	•	•
	2	•		•				•	•	•
	3	•	•	•					•	•
	4	•			•			•	•	•
	5	•	•	•	•				•	•
	6	•				•		•	•	•
	7	•	•	•	•	•			•	•
	8	•					•	•	•	•
	9	•	•				•	•	•	•

2 Position Repeating—M04

		Type of Track	C	1	2
Location on PC Board		2	9	8	
Dial Setting (To be specified)	+ 5	•	•		
	- 0			•	
	+ 5	•	•		
	- 0			•	
	+ 5	•	•		
	- 0			•	
	+ 5	•	•		
	- 0			•	
	+ 5	•	•		
	- 0			•	

B.C.D. Complement—M07

		Type of Track	C	$\bar{1}$	$\bar{2}$	$\bar{4}$	$\bar{8}$
Location on PC Board		3	4	11	2	10	
Dial Setting	0	•	•	•	•	•	•
	1	•		•	•	•	•
	2	•		•	•	•	•
	3	•		•	•	•	•
	4	•	•	•	•	•	•
	5	•		•	•	•	•
	6	•		•	•	•	•
	7	•		•	•	•	•
	8	•	•	•	•	•	•
	9	•		•	•	•	•

B.C.D. EXCESS 6 + Complement—M08

		Type of Track	C	1	2	4	8	$\bar{1}$	$\bar{2}$	$\bar{4}$	$\bar{8}$
Location on PC Board		7	6	5	4	3	11	10	9	8	
Dial Setting	0	•		•	•		•			•	
	1	•	•	•	•						•
	2	•				•	•	•	•		
	3	•	•	•			•	•	•		
	4	•		•			•	•	•		
	5	•	•	•	•			•	•		
	6	•			•	•	•			•	
	7	•	•	•	•	•				•	
	8	•		•	•	•	•				•
	9	•	•	•	•	•					•

Hexadecimal B.C.D. - M 29*

		C	1	2	4
Location on PC Board		7	11	9	2
Dial Setting	0	•			
	1	•	•		
	2	•		•	
	3	•	•	•	
	4	•			•
	5	•	•	•	•
	6	•			•
	7	•	•	•	•
	8	•			•
	9	•	•	•	•
	10	•			•
	11	•	•	•	•
	12	•			•
	13	•	•	•	•
	14	•			•
15	•	•	•	•	

*84 210 only

Note: In decimal and BCD the following alternatives are available.*

	Short Board	Long Board for Mounting of Resistors or Diodes	
		In Series on Each Track (Interrupted Tracks)	In Parallel from Track to Track (Non-Interrupted Tracks)
Break Before Make	MO 1-C (Decimal) MO 2-C (BCD)	MO 1-L (Decimal) MO 2-L (BCD)	M 14-L (Decimal) M 15-L (BCD Complement)
Make Before Break (on Request)	M 13-C (Decimal)	M 13-L (Decimal)	

*Please consult us for special codes.

Digital Switches

Push Button - miniature - panel mount Series 84 230

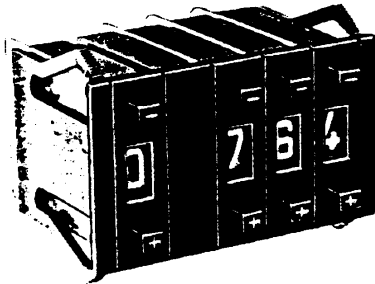

- Long circuit boards have track interruption to allow series mounting of components
- All modules easily assembled without hardware
- Black wheel standard – white wheel with black marking on request
- Fast, smooth switching action

Mechanical & Electrical Specifications

Max. operating voltage:
switched 50 VAC
unswitched 120 VAC

Rated amperage: switched 1-50mA

Max. amperage: unswitched 500mA

Min. contact resistance: .1 ohm

Min. insulation resistance: 100,000 megohms

Dielectric strength:
between tracks: 500 VAC
between tracks and ground: 2,500 VAC

Operating temperature:
+ 15°F to + 160°F (-10°C to + 70°C)

Storage temperature:
-40°F to + 185°F (-40°C to + 85°C)

Mechanical life:
500,000 operations

Materials

Case and wheel: polycarbonate

Push Buttons and thumbwheel: Delrin

Printed circuit board: epoxy glass

Printed contact: gold deposit

Contacts: tin plated

Panel cutout and front face dimensions in inches (mm)

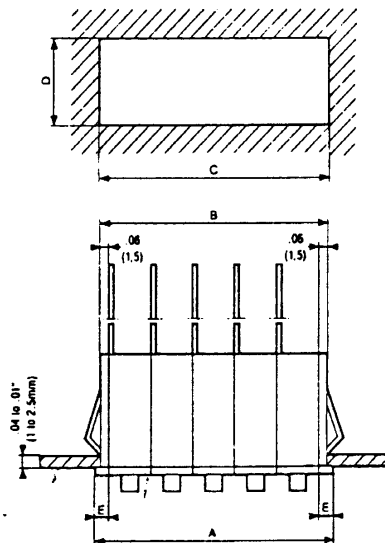

Dimensions in inches (mm)

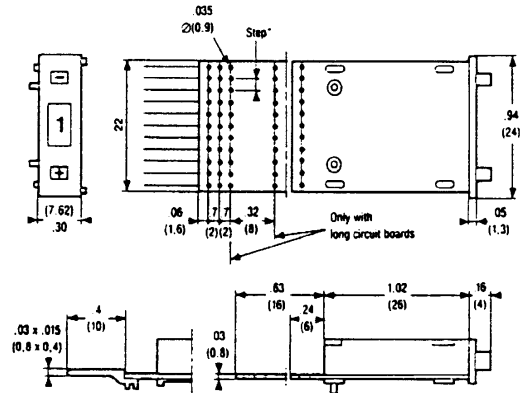

*Step: 08 (2) – M01, M03, M04, M30
Step: 1 (2.54) – M29 – M31
Step: 2 (5.08) – M02 – M07

Series 84 230

A (.30 x n) + .24 inches	(7.62 x n) + 6mm
B (.30 x n) + .12 inches	(7.62 x n) + 3mm
C (.30 x n) + .14 inches	(7.62 x n) + 3.5mm
D .89 inches	22.5mm
E .12 inches	3mm

Digital Switches

Push Button - subminiature - panel mount Series 84 231

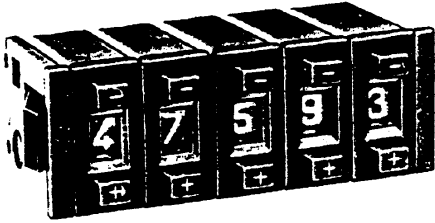

- Subminiature size – only .59 inch high
- All modules easily assembled without hardware
- Black wheel standard – white wheel with black markings on request
- Fast, smooth switching action

Mechanical & Electrical Specifications

Max. operating voltage:
switched 50 VAC
unswitched 120 VAC

Rated amperage: switched 1-50mA

Max. amperage: unswitched 500mA

Min. contact resistance: .1 ohm

Min. insulation resistance: 1,000 megohms

Dielectric strength:
between tracks: 500 VAC
between tracks and ground: 2,500 VAC

Operating temperature:
+ 15°F to + 160°F (–10°C to + 70°C)

Storage temperature:
–40°F to + 185°F (–40°C to + 85°C)

Mechanical life:
500,000 operations

Materials

Case and wheel: polycarbonate
Push Buttons and thumbwheel: Delrin
Printed circuit board: epoxy glass
Printed contact: gold deposit
Contacts: tin plated

Panel cutout and front face dimensions in inches (mm)

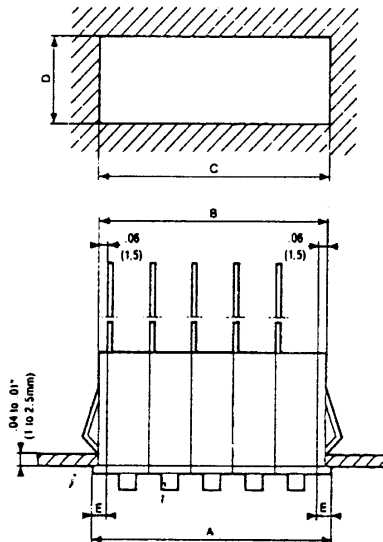

Dimensions in inches (mm)

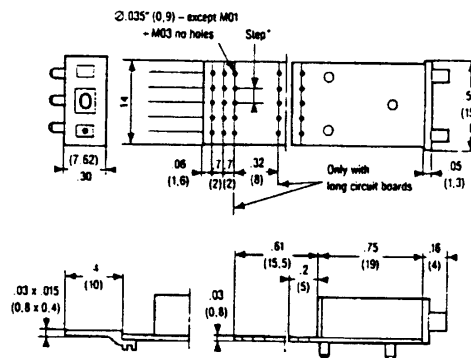

*Step: .08 (2) – M01
Step: .1 (2.54) – M02, M03, M04, M07

Series 84 231

A (.30 x n) + .20 inches	(7.62 x n) + 5.08mm
B (.30 x n) + .12 inches	(7.62 x n) + 3mm
C (.30 x n) + .14 inches	(7.62 x n) + 3.5mm
D .57 inches	14.5mm
E .10 inches	2.54mm

Digital Switches

Thumbwheel - flat PCB mount Series 84 235

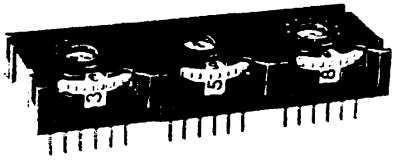

- Low profile – specially designed for PCB mounting
- All modules easily assembled without hardware
- Black or red wheels standard – white wheel with black marking on request
- Fast, smooth switching action

Mechanical & Electrical Specifications

Max. operating voltage:
 36 VDC/150 VAC
Rated amperage: switched 1-100mA
Max. amperage: unswitched 500mA
Min. contact resistance: .1 ohm
Min. insulation resistance: 1,000 megohms
Dielectric strength:
 between tracks: 500 VAC
 between tracks and ground: 2,500 VAC

Operating temperature:
 + 15°F to + 160°F (-10°C to + 70°C)
Storage temperature:
 -40°F to + 185°F (-40°C to + 85°C)
Mechanical life:
 250,000 operations

Materials

Case and wheel: polycarbonate
Thumbwheel: Delrin
Printed circuit board: epoxy glass
Printed contact: gold deposit
Contacts: tin plated

Dimensions in inches (mm)

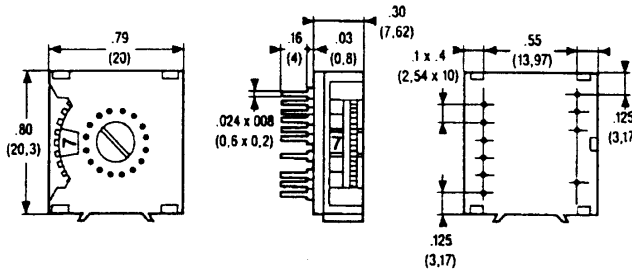

Crouzet® Digital Switches

Truth Tables - Series 84 230, 84 231, and 84 235

The dots indicate the inter-connected tracks for each of the dial settings.

B.C.D.		B.C.D. + Complement		B.C.D. Complement		2 Position Repeating																							
		M02				M03				M07				M04															
		C	1	2	4	8	C	1	2	4	8	1	2	4	8	C	1	2	4	8	10	C	1	2	4	8	C	1	2
Location on PC Board	84 230	10	2	4	6	8	10	2	4	6	8	3	5	7	9	4	2	6	8	10	4	2	6	8	10	1	2	11	
	84 231	5	1	2	3	4	5	10	9	8	7	1	2	3	4	5	1	2	3	4	5	1	2	3	4	2	3	4	
	84 235	7	12	10	8	4	2	8	12	11	3	5	1	9	4	8	12	10	4	2	8	12	10	4	2	7	4	8	
Dial Setting	0	•					•				•	•	•	•	•	•	•	•	•	•	•	•	•	•	•	•	•		
	1	•	•				•	•			•	•	•	•	•	•	•	•	•	•	•	•	•	•	•	•	•		
	2	•		•			•		•		•		•		•		•		•	•		•		•	•		•		
	3	•			•		•			•		•		•	•		•		•	•		•		•	•		•		
	4	•				•	•				•		•		•		•		•	•		•		•	•		•		
	5	•				•	•				•		•		•		•		•	•		•		•	•		•		
	6	•				•	•				•		•		•		•		•	•		•		•	•		•		
	7	•				•	•				•		•		•		•		•	•		•		•	•		•		
	8	•				•	•				•		•		•		•		•	•		•		•	•		•		
	9	•				•	•				•		•		•		•		•	•		•		•	•		•		

Hexadecimal B.C.D.		Hexadecimal B.C.D. + Complement		Hexadecimal B.C.D. Complement Only		Decimal																										
		M29				M30				M31				M01																		
		C	1	2	4	8	C	1	2	4	8	1	2	4	8	C	1	2	4	8	C	8	1	2	3	4	5	6	7	8	9	10
Location on PC Board	84 230	5	4	7	6	8	10	3	5	9	7	4	2	8	6	8	4	6	7	5	1	11	2	3	4	5	6	7	8	9	10	
	84 231	8	12	2	10	4	4	10	11	12	8	3	2	1	5	8	12	2	10	4	9	6	1	11	2	10	3	8	4	7	5	
	84 235	7					6									7					7	5	12	11	10	9	8	1	2	3	4	
Dial Setting	0	•					•				•	•	•	•	•	•	•	•	•	•	•	•	•	•	•	•	•	•	•	•	•	•
	1	•	•				•	•			•	•	•	•	•	•	•	•	•	•	•	•	•	•	•	•	•	•	•	•	•	
	2	•		•			•		•		•		•		•		•		•	•		•		•		•		•		•		
	3	•			•		•			•		•		•	•		•		•	•		•		•		•		•		•		
	4	•				•	•				•		•		•		•		•	•		•		•		•		•		•		
	5	•				•	•				•		•		•		•		•	•		•		•		•		•		•		
	6	•				•	•				•		•		•		•		•	•		•		•		•		•		•		
	7	•				•	•				•		•		•		•		•	•		•		•		•		•		•		
	8	•				•	•				•		•		•		•		•	•		•		•		•		•		•		
	9	•				•	•				•		•		•		•		•	•		•		•		•		•		•		
	A	•				•	•				•		•		•		•		•	•		•		•		•		•		•		
	B	•				•	•				•		•		•		•		•	•		•		•		•		•		•		
	C	•				•	•				•		•		•		•		•	•		•		•		•		•		•		
	D	•				•	•				•		•		•		•		•	•		•		•		•		•		•		
	E	•				•	•				•		•		•		•		•	•		•		•		•		•		•		
	F	•				•	•				•		•		•		•		•	•		•		•		•		•		•		

Terminal Configuration

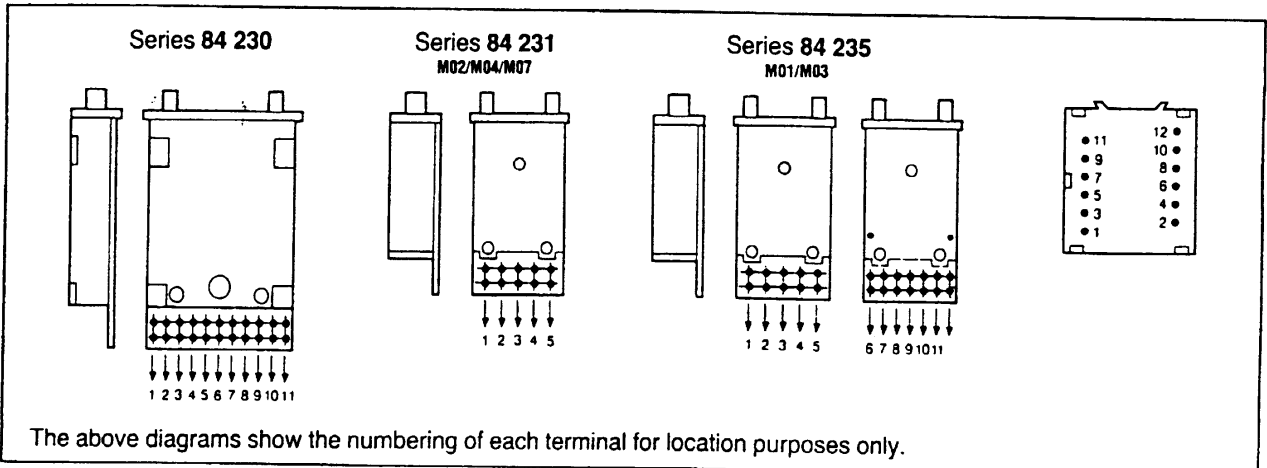

How to Order

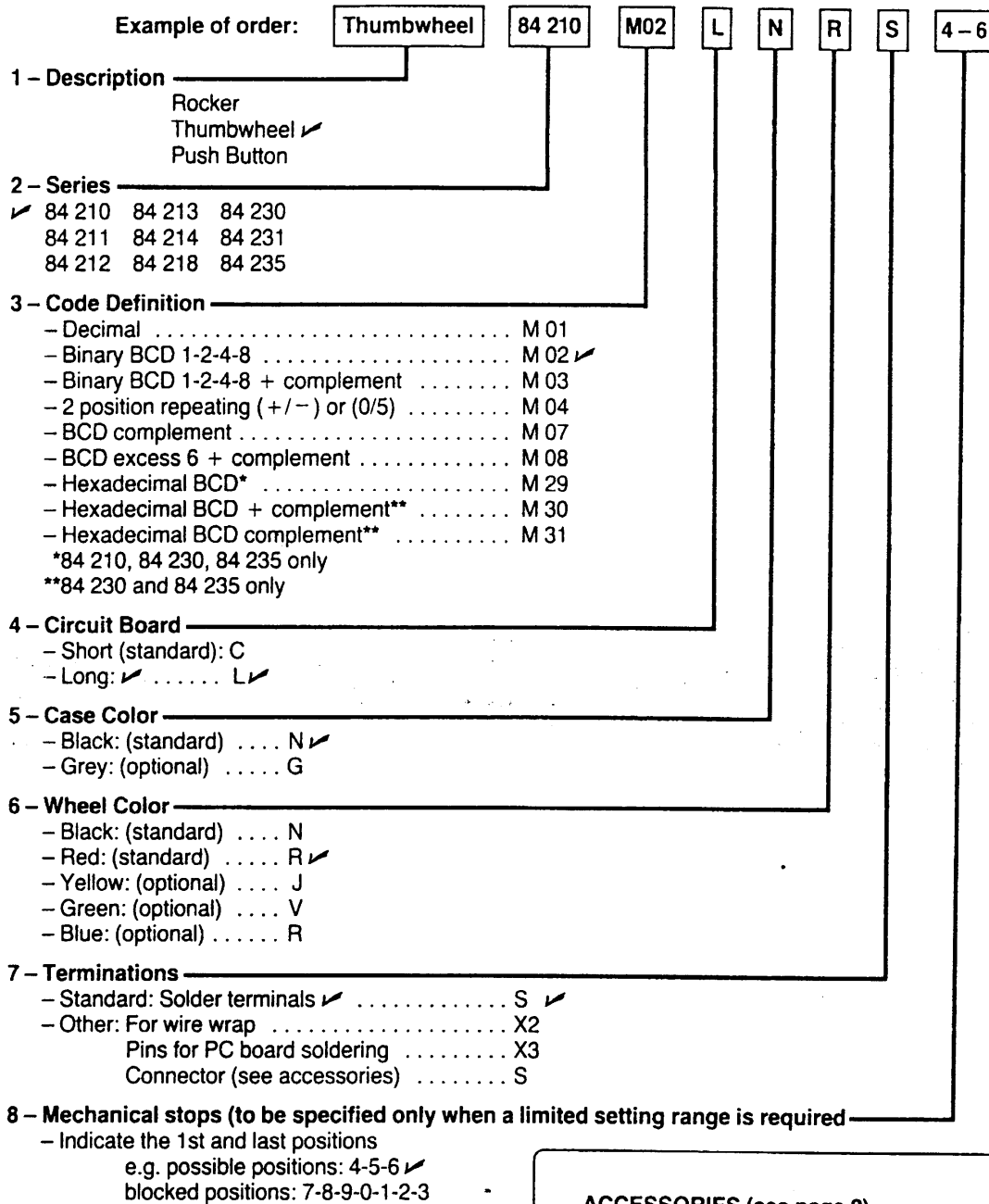

Above example to be read as:

- 1 - Thumbwheel switch
- 2 - 84 210
- 3 - binary BCD 1-2-4-8 - M 02
- 4 - Long circuit board
- 5 - Black case
- 6 - Red wheel
- 7 - Standard solder terminals
- 8 - Possible positions 4-5-6

ACCESSORIES (see page 2)
 (specify digital switch series number)

- **Pair of End Caps including Clips.** JE/
 (color: N - black: standard G - grey: optional)
- **Spacer:** MI
- **Encoded "Dummy" Module:** MC - also specify code, circuit board, color connections
- **Separator including Clips:** MS
- **Connector for Plugging of Circuit C:**
 CR/W2-Solder Terminals
 CR/X2-Wire Wrapping Terminals
 CR/X3-PC Board Pins

Digital Switches

L.E.D. Readouts - 3 main families

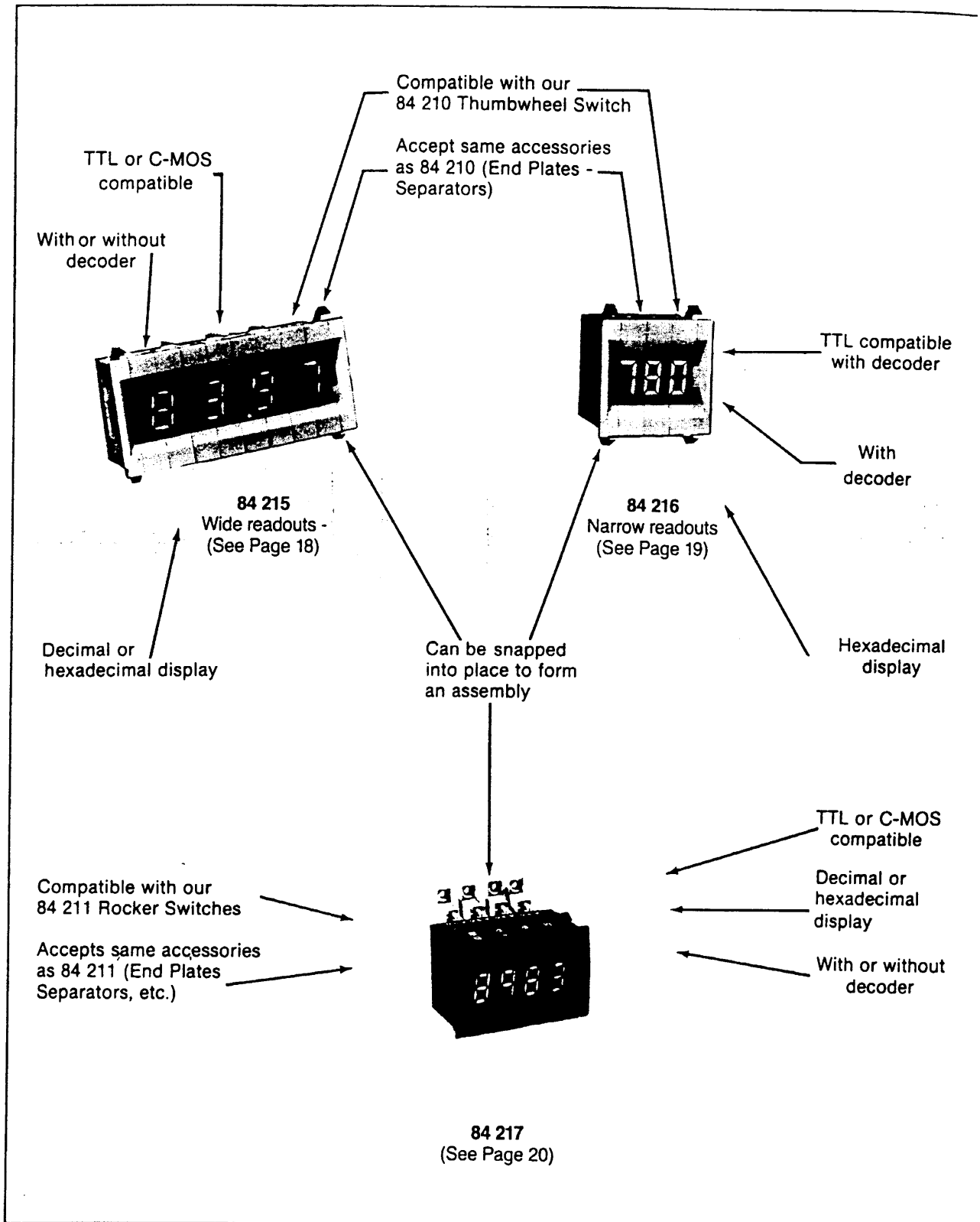

L.E.D. Readouts - wide readout - panel mount Series 84 215

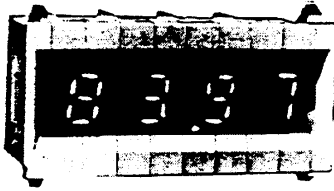

- The L.E.D. readout modules type 84 215 can work alongside our Thumbwheel switches, 84 210 Series.
- The same accessories (end plates, separators, etc.) can be used. This allows the assembly of counting and programming systems, offering a consistent design in a small size.
- As with our Thumbwheel switches, these modules can be snapped into place to form an assembly.
- Choice of decoders (TTL or C-MOS), memory, voltages.
- Three versions are available.

Common Specifications

Figure Height: .433 in. (11 mm)
Module Width: .62 in. (16 mm)
Color: Red
Operating Temperature: +32° F to +140° F. (0° C. to 60° C.)
Case Color: Black (standard) or grey (upon request)

Current Per Segment: 7 mA
Display: H.P. 5082 - 7653
RBI - RBO output on all modules (except A1)
Common Cathode

Particular Specifications

Code	BCD Decoder		LT Output (Lamp Test)	EL Output (Memory)	Position of Decimal Point		Typical Consumption of Decoder at 75° F (25° C)	Voltages Available	Type of Display
	C-MOS	TTL			Left	Right			
A1	No	No	Yes	No		•	N.A.	5 V (standard) 12-15-24 V (on request)	According to User's decoder
A3	MM74 C48	No	Yes	No		•	0.05 μ A	5 V (standard) 12-15 V (on request)	Decimal
A6	No	9368	No	Yes		•	45 mA	5 V	Hexadecimal

Terminations

Dimensions in inches (mm)

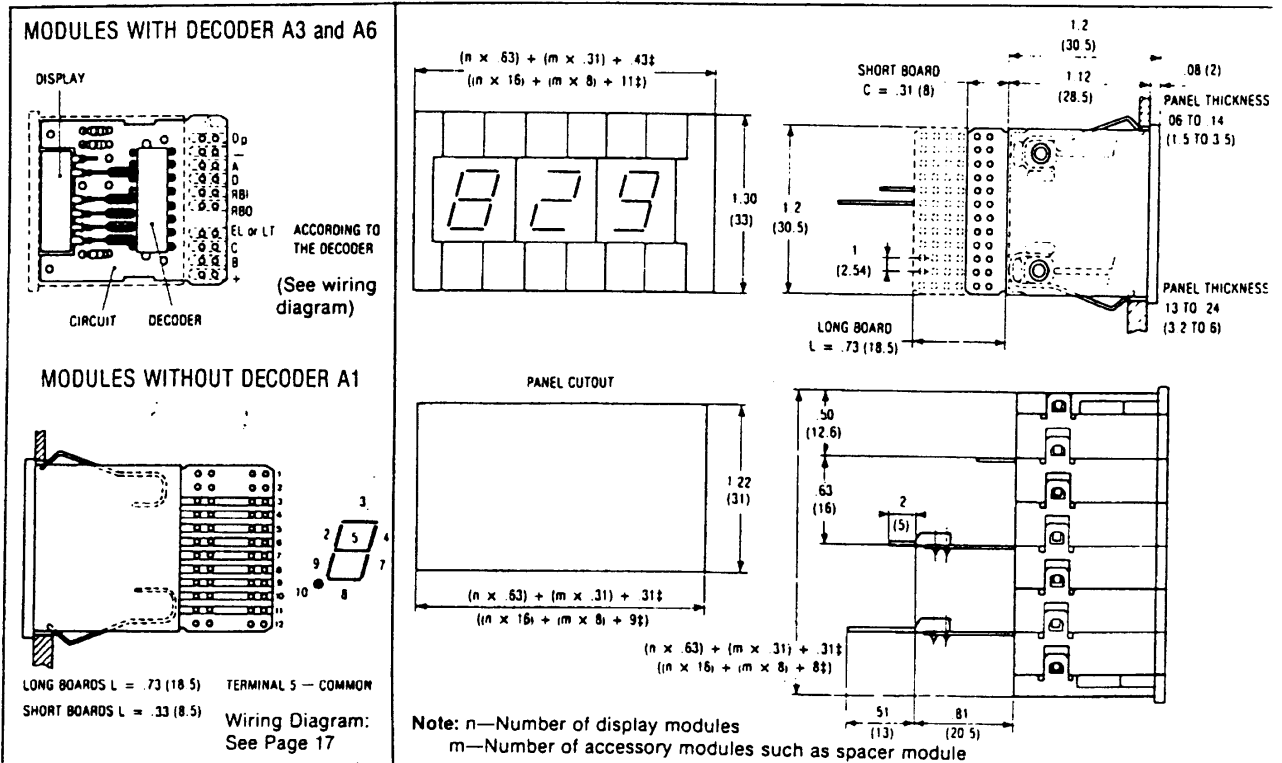

L.E.D. Readout Modules

L.E.D. Readouts - narrow readout - panel mount Series 84 216

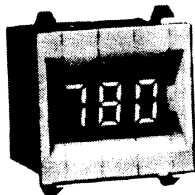

With Memory

- The L.E.D. readout modules type 84 216 can be mounted together with the 84 215 L.E.D. and/or 84 210 Thumbwheel.
- Therefore, the same accessories (end plates and separators) are used.
- The thickness of these modules is .31 in. (8 mm)
- The clip mounting offers a consistent design in a small size.
- Snap on assembly requires no hardware.
- Our modules are equipped with a decoder BCD compatible with TTL technology.

Specifications

Voltage: 5 V
Current: 16 to 22 mA per segment
Decoding: BCD with TTL technology (decoder 9368)
Display: 7 segment L.E.D. (Fairchild)
Figure Height: .35 in. (9 mm)
Module Width: .31 in. (8 mm)
Color: Red
Case Color: Black (standard) or grey (upon request)
Operating Temperature: +32° F. to +95° F. (0° C to +35° C.)

EL (Enable Latch) output
RBI - RBO outputs
Decoder Consumption at 75° F. (25° C) = 45 mA
Common Cathode
Hexadecimal Display
Position of Decimal Point: right

Terminations

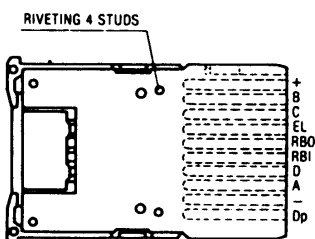

Wiring Diagram
 See Page 21

Dimensions in inches (mm)

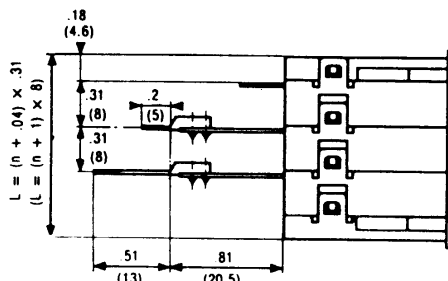
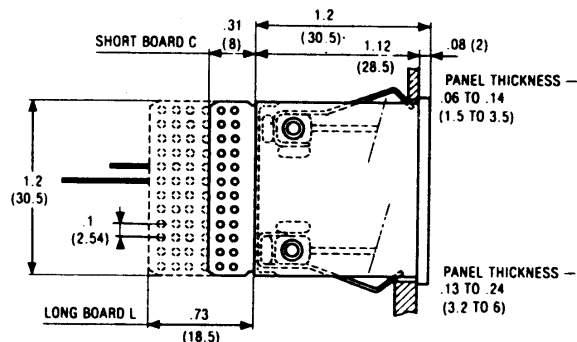
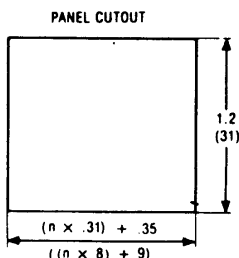
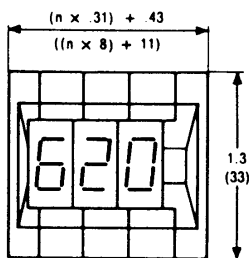

L.E.D. Readout Modules

L.E.D. Readouts - panel mount Series 84 217 - compatible with Rocker Switches

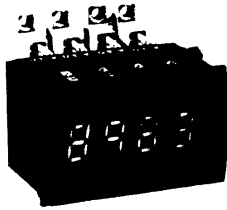

- The L.E.D. readout modules type 84 217 can be mounted together with our 84 211 Rocker switches.
- The same accessories (end plates, separators, etc.) can be used.
- As with our Rocker switches, these modules can be snapped into place to form an assembly.
- Choice of decoders, (TTL or C-MOS), memory (EL), voltages etc.
- Six versions are available.

Common Specifications

Figure Height: .39 in (10 mm)
Module Width: .39 in (10 mm)
Color: Orange
Operating Temperature: +32° F to +140° F. (0° C. to 60° C.)
Case Color: Black (standard) or grey (upon request)

Current Per Segment: 7 mA
Display: MAN 4640 (except 84 217-A11: MAN 4605)
Common Cathode
Position of Decimal Point: right

Particular Specifications

Code	BCD Decoder		LT Output (Lamp Test)	EL Output (Memory)	RBI-RBO Outputs	Typical Consumption of Decoder at 75° F. (25° C.)	Voltages Available	Type of Display
	C-MOS	TTL						
A1	No Decoder	No Decoder	No	No	No	Not Applicable	5 V (standard) 12-15-24 V (on request)	Depends upon User's Decoder
A3	MM 74C48		Yes	No	Yes	0.05 μ A	5 V (standard) 12-15 V (on request)	Decimal
A6		9368	No	Yes	Yes	45 mA	5 V	Decimal
A8	MC 14511		Yes	Yes	No	0.015 μ A	5 V (standard) 12-15-24 V (on request)	Decimal
A10	MC 14495		No	Yes	No	0.05 μ A	5 V (standard) 12-15-24 V (on request)	Hexadecimal
A11	MC 14511		Yes	Yes	No	0.015 μ A	5 V (standard) 12-15-24 V (on request)	± 1

Terminations

MODULES WITHOUT DECODER A1

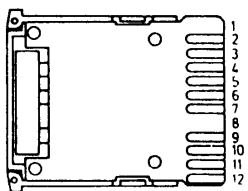

Common: Terminal 11

MODULES WITH DECODER (A2 to A8 and A11)

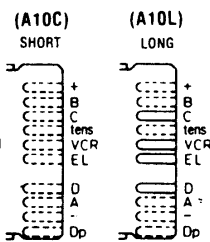
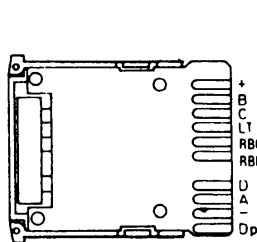

Wiring Diagram: See Page 21

ACCORDING TO THE DECODER (SEE WIRING DIAGRAM)

Dimensions in inches (mm)

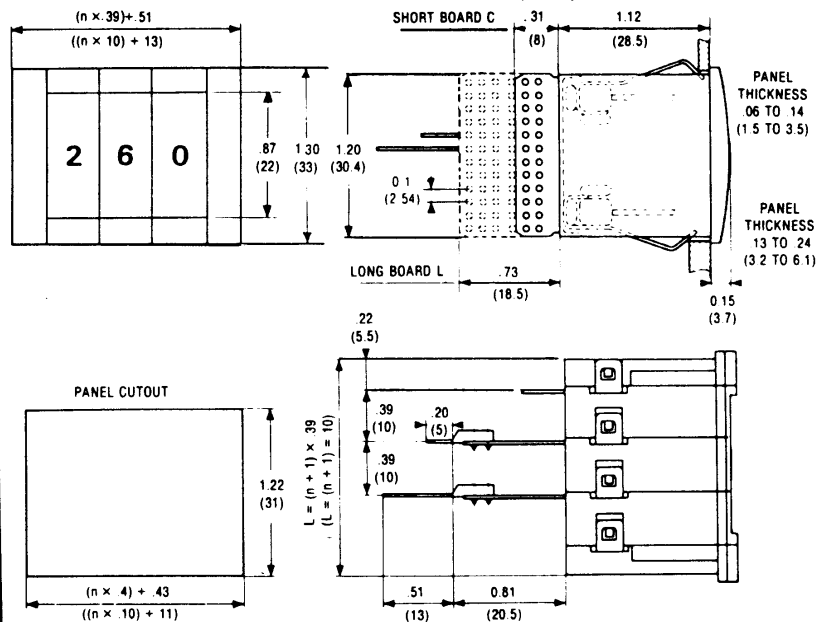

L.E.D. Readouts - Wiring Diagrams

84 215 - A3

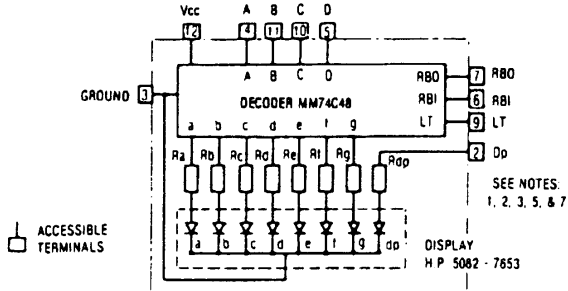

84 215 - A6

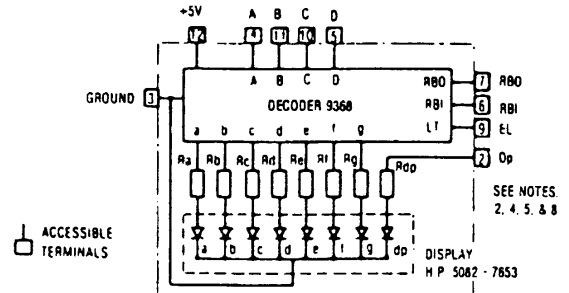

84 216

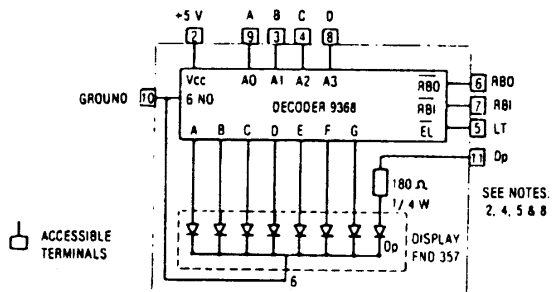

84 217 - A3

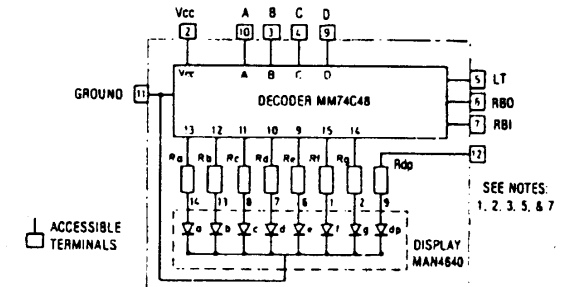

84 217 - A6

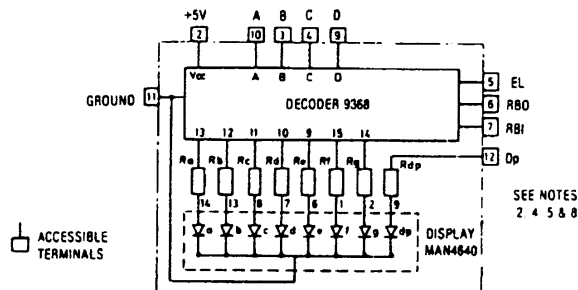

84 217 - A8

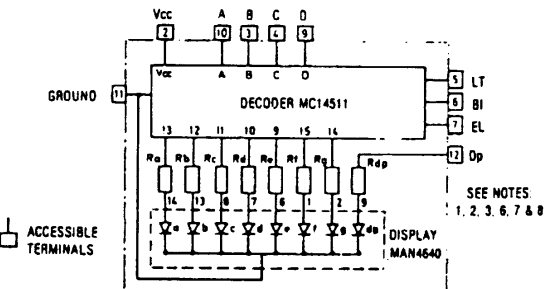

84 217 - A10

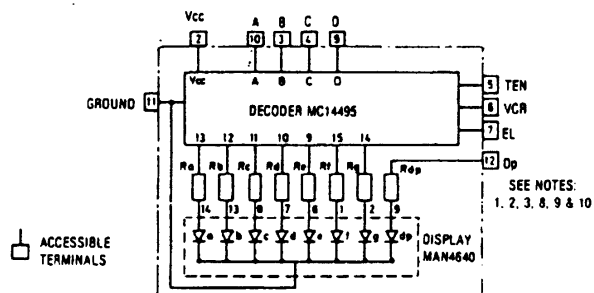

84 217 - A11

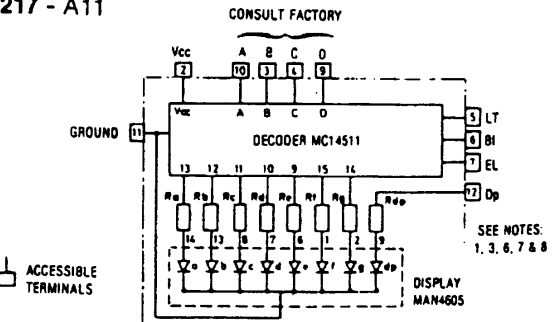

L.E.D. Readouts - Wiring Diagrams

Notes:

1. Vcc = 5, 12, 15 or 24 V according to the model (5 V standard - 12, 15 and 24 V on request).
2. A, B, C and D correspond respectively to 1, 2, 4 and 8 of BCD code.
3. In all C-MOS decoders, it is mandatory that all inputs be connected at ALL times either to the + or the ground (except RBI-RBO - see note 5). The use of bias resistors is therefore necessary (see diagram). Should an input not be used at all, it may be directly connected either to the + or the ground (depending on the function).
4. For TTL decoders, should an input not be connected to either the + or the ground, the decoder might not work properly (while not connected), but it would not be destroyed.
5. The non-significant zeros are cancelled when RBI (Ripple Blanking Input) is connected to the ground, if several modules are connected together the RBI of the module adjacent to the module of the units (eg: ten or tenth) must be connected to the RBO (Ripple Blanking Output) of the next unit (hundred or hundredth) etc. The first RBO's (ten and tenth) as well as the unit's are left unconnected. (the zero of the unit is never cancelled).

If the zero cancellation is not required, the RBI inputs must be connected to the + of the power supply and RBO must be left unconnected.

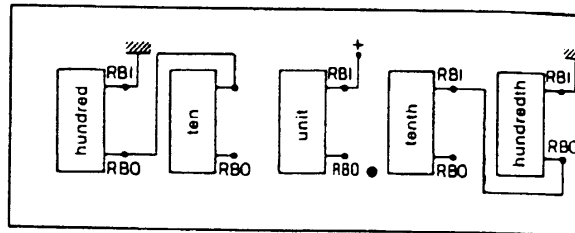

6. Connecting BI (Blanking Input) to the ground cancels the display (otherwise connect BI to + of supply)
7. Connecting LT (Lamp Test) input to ground make possible to control all segments (otherwise connect to + of supply).
8. Connecting EL (Enable Latch) to + of supply keeps display in memory. Otherwise connect EL to ground
9. TEN output is in state "0" when digits from 0 to 9 displayed and in state "1" when digits from A to F displayed.
10. VCR output is open for displays from 0 to E. When displayed the state is "0".

Example of Control of a Readout Module with a Thumbwheel Switch.

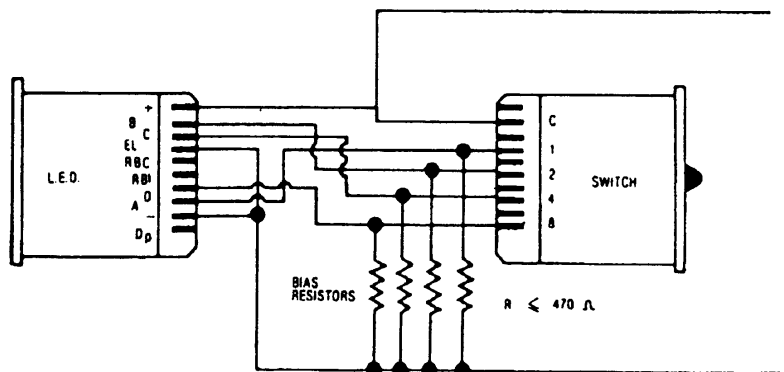

Digital Switches

L.E.D. Readouts - How to Order

Example of order: **Readout Module** **84 215** **A3** **O** **L** **N** **R** **S**

1—Description _____

2—Type _____

✓ 84 215: width - .62 in. (16 mm), figure height - .43 in. (11 mm)
 84 216: width - .31 in. (8 mm), figure height - .35 in (9 mm)
 84 217: width - .39 in. (10 mm), figure height - .39 in. (10 mm)

3—Code Definition _____

84 215: Display + resistors (no decoder) A1
 84 215: Display + C-MOS decoder A3 ✓
 84 215: Display + TTL, and memory decoder A6
 84 216: Display + TTL, and memory decoder B
 84 217: Display + resistors (no decoder) A1
 84 217: Display + C-MOS decoder A3
 84 217: Display + TTL, memory decoder A6
 84 217: Display + C-MOS, memory decoder A8
 84 217: Display + C-MOS, memory decoder A10
 84 217: Display +1 + C-MOS, memory decoder A11

4—Voltages _____

—5 volts: 0 ✓
 —12 volts: 1
 —15 volts: 2
 —24 volts: 3

5—Circuit board _____

—Short: C (except for 24 V versions)
 —Long: L ✓

6—Case color _____

—Black: N (standard) ✓
 —Grey: G (optional)

7—Color of Display _____

—Red: R (for 84 215 and 84 216) ✓
 —Orange: O (for 84 217)

8—Terminations _____

—Standard: Solder terminals: S ✓
 —Other: for wire wrap: X2 (please consult us)
 pins for P.C. Board soldering: X3 (please consult us)
 connector (see digital switches: S)

Above example to be read as:

- 1—Readout module
- 2—84 215 - width .62 in. (16 mm); figure height .43 in. (11 mm)
- 3—C-MOS decoder
- 4—5 volts
- 5—Long circuit board
- 6—Black case
- 7—Red display
- 8—Standard solder terminals