

Series 05, 05-6



Typical Applications

- Annunciator panels for transit equipment
- Broadcast equipment
- Audio and intercom panels



actual size



Features

- Single and double pole
- Momentary and maintained action
- Contacts are silver-plated
- .110 quick disconnect or PC board terminals
- Variety of colored lens caps
- Approvals: UL, CSA

Mounting Information

It is recommended the switch cut-out be punched from front of panel.

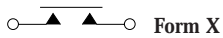

SPST N.O. (FORM X)
05- NON-BEZEL VERSION

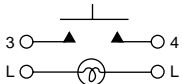

DPST N.O. (FORM XX)
05- BEZEL VERSION

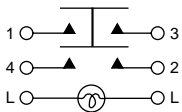

OBSERVE PROPER
TERMINAL IDENTIFICATION

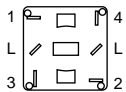

05

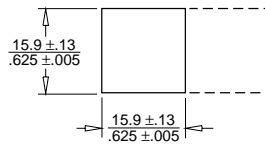

ADD $\frac{17.5}{.690}$ FOR EACH ADDITIONAL UNIT

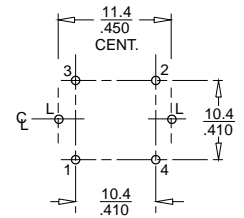

PANEL THICKNESS RANGE
 $.81 - 2.39$
 $.032 - .094$

05-6

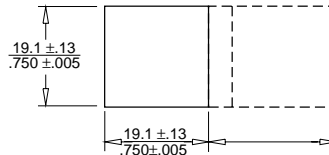

ADD $\frac{20.39}{.803}$ FOR EACH ADDITIONAL UNIT

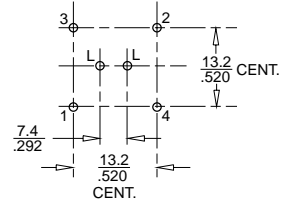

PANEL THICKNESS RANGE
 $1.57 - 3.18$
 $.062 - .125$

millimeters
inches

ALL P.C. BOARD HOLE SIZE
 $1.0 \pm .05$
 $.040 \pm .002$ DIA.

05

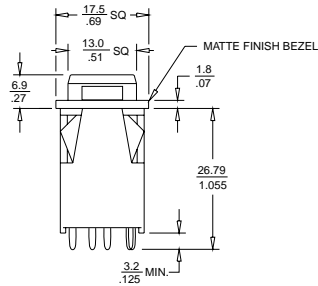

millimeters
inches

Circuitry Options:
05 – SPST-NO, SPDT, DPST-NO
05-6 – SPST-NO, DPST-NO, SPDT

Ratings:
05 & 05-6: Lighted and non-lighted
Lighted 05: T1-3/4 wedge base incandescent lamp
Lighted 05-6: T1-3/4 flange base incandescent lamp only

05-6

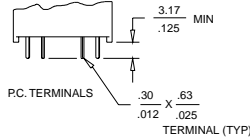
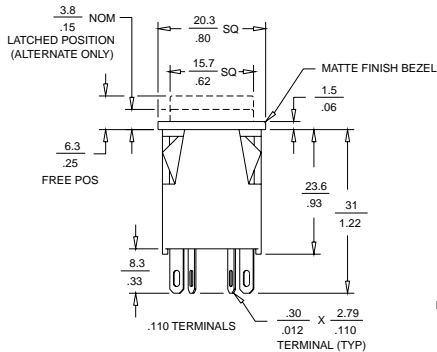

Electrical Characteristics

Series	Current	Voltage
05	1 amp Res	125 VAC
05-6	1 or 3 amps	125 VAC max

Ordering Information – Switch Specifications

05 Switches						
Part Number	LampType	Terminal	Amp Rating	Circuit/Action	Mounting	
05-115	Incandescent	.110 QC	1A	SPST-NO/mom	Snap-in-Bezel	
05-135	Incandescent	.110 QC	1A	SPDT/mom	Snap-in-Bezel	
05-145	Incandescent	.110 QC	1A	SPDT/maint	Snap-in-Bezel	
05-165	Incandescent	PCB	1A	SPST-NO/mom	Snap-in-Bezel	
05-166	Incandescent	PCB	1A	SPST-NO/mom	Non-Bezel	
05-175	Incandescent	PCB	1A	DPST-NO/mom	Snap-in-Bezel	
05-215	None	.110 QC	1A	SPST-NO/mom	Snap-In-Bezel	
05-6 Switches						
05-621250	Incandescent	.110 QC	1A	SPST-NO/mom	Snap-In-Bezel	
05-623250	Incandescent	.110 QC	1A	SPDT/mom	Snap-In-Bezel	
05-651250	Incandescent	PCB	1A	SPST-NO/mom	Snap-in-Bezel	
05-652250	Incandescent	PCB	1A	DPST-NO/mom	Snap-In-Bezel	

05 Buttons

Part Number	LampType	Color
80-050007	Incandescent	White
80-050008	Incandescent	Red
80-050009	Incandescent	Green
80-050011	Incandescent	Yellow
80-050012	Incandescent	Amber
05-6 Buttons		
80-050602	Incandescent	White
80-050603	Incandescent	Red
80-050604	Incandescent	Green
80-050606	Incandescent	Yellow
80-050607	Incandescent	Amber

MATTE FINISH PER RAWAL # MT-1055 (TOP AND (4) 15° ANGLE SURFACES ONLY)

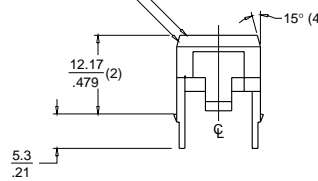

MATTE FINISH PER RAWAL # MT-1055 (TOP AND (4) TO .200 FROM TOP)

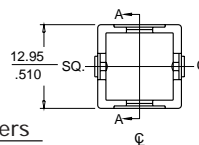
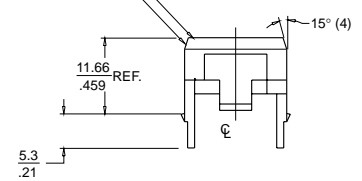

millimeters
inches

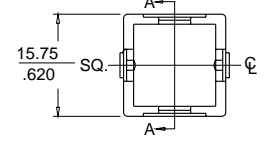

1-800-544-3354