

**Amphenol**  
SINESYSTEMS

# RT360™

Circular Connectors



**INTERCONNECTING YOUR WORLD**



We are Amphenol Sine Systems.

We are a global leader in providing you with interconnection options and solutions.

We fulfill the needs of Industrial, Factory Automation, Heavy Duty and Custom-design markets.

Amphenol Sine Systems, with its 42 year history, 325+ employees worldwide and 3 global facilities, draws on the extensive worldwide resources of Amphenol Corporation to find solutions for our customers. Our engineers design innovative combinations of industry standard connectors and application specific shielding components to create assembly systems that set the standards for performance, reliability, and cost effectiveness. Our engineering, materials, and manufacturing organizations meet the high standards imposed by ISO 9001 as well as many customer specific quality systems. Our performance has earned us ship to stock and world class performance awards from many major OEMs.



Amphenol Sine Systems is a division of **Amphenol Corporation** ([www.amphenol.com](http://www.amphenol.com)), one of the largest interconnect solution suppliers in the world. Amphenol Corporation supplies a wide range of product solutions worldwide. Amphenol Corporation, and all its subsidiaries, design, manufacture and market electrical, electronic and fiber-optic connectors, interconnect systems and coaxial and specialty cable. Amphenol has a diversified presence in high growth markets including: Information Technology and Data Communications Equipment, Mobile Devices, Mobile Networks, Broadband Communication, Military and Commercial Aerospace, Industrial and Automotive.



## Table of Contents

|   |            |
|---|------------|
| Description.....  | 1          |
| Features & Benefits.....  | 1          |
| Part Ordering Guide - RT & RTHP Series Plugs and Receptacles .....  | 2          |
| Part Ordering Guide - RT Series Machined Contacts .....             | 3          |
| Part Ordering Guide - RT Series Stamped & Formed Contacts .....     | 4          |
| Radsok® Technical Information .....                                 | 5          |
| Part Ordering Guide - RTHP Series Machined Contacts.....            | 6          |
| RTHP Series Typical Product Picture and Installation Dimension..... | 6          |
| Insert Configurations .....   | 7          |
| Box and Wall Mounts .....   | 8          |
| Straight Plugs .....  | 8          |
| Jam Nut Receptacle .....  | 9          |
| Cord Grips.....   | 9          |
| Metal Cable Clamp Cord Grip .....                                   | 10         |
| Wall Mounted Receptacle for Flat Hole Tail .....                    | 11         |
| Straight Cable Plug with Cord Grip Solution.....                    | 11         |
| Straight Cable Plug with End Cap .....                              | 12         |
| Straight Cable Plug with 90° Cord Grip Solution .....               | 12         |
| Accessories & Tooling -   |            |
| Dust Caps.....  | 13         |
| Sealing Plugs.....  | 13         |
| Universal Hand Crimp Tool.....                                      | 13         |
| Stamp Contact Tool .....  | 13         |
| Contact Extraction Tool .....                                       | 13         |
| Crimp Die .....   | 14         |
| Pneumatic Crimp Tool.....   | 14         |
| Gaskets.....  | 14         |
| Worldwide Company Locations .....                                   | Back Cover |

© 2011 Amphenol Sine Systems Corporation. Every effort has been made to ensure that the information contained in this catalog is accurate at the time of publication. Specifications or information stated in this publication are subject to change without notice.

## Description

RT360™ industrial circular connectors are multiway connector available in 6 shell sizes and 22 insert arrangements with a variety of wire gauge options. RT360 industrial circular connectors were designed to be intermateable with other industrial connector families.

|  |  |
|--|--|
| Shells                                   | Zinc Alloy   |
| Backshells and Cable Glands              |  |
| Coupling Ring                            | Aluminum   |
| Coupling Spring                          | Spring Stainless Steel   |
| Interfacial Seal                         | Standard: NBR / Optional: Silicone   |
| Insert                                   | Glass-filled Thermoplast UL94-V0   |
| Finish                                   | Nickel   |
| RoHS Compliant                           | Yes  |
| Operating Temp                           | NBR: -40°C to +105°C / Silicone: -45°C to +125°C   |
| Insulation Resistance                    | 5000 MΩ min.   |
| Durability                               | 500 matings and unmatings  |
| Vibration Resistance                     | per MIL-STD202 method 204  |
| Thermal Shock                            | per MIL-STD202 method 207  |
| Corrosion                                | Salt spray per MIL-STD 202, method 101; 48h (standard version), 96h (black anodized coupling ring) <b>*Higher salt spray resistance (200/500h) upon request.</b> |
| Degree of Water Protection per DIN 40050 | IP67 in mated condition and in combination with sealed back shell.<br>*Consult Factory for additional Degree of Protection                                       |

## Features & Benefits



RT Series



RTHP Series

### RT Series - 20AWG

- High density arrangements from 6-41 contacts
- 6 shell sizes and 6 insert configurations
- Operating voltage of 150V
- Current rating of 7.5A with machined contacts and 5A with stamped and formed contacts
- Alternate keying positions available
- Plastic inserts with flammability rating of UL94-V0
- RoHS compliant

### RT Series - 16AWG

- 16AWG and mixed Power and Signal arrangements from 4-28 contacts
- 6 shell sizes and 11 insert configurations
- Operating voltage of 300V
- Current rating: 13A(signal contacts)
- Alternate keying positions available
- Plastic inserts with flammability rating of UL94-V0
- RoHS compliant

### RTHP Series

- Single pole High Power arrangements
- 4 shell sizes and 5 insert configurations
- 3.6mm-10mm contact sizes
- Operating voltage of 630V
- Current rating at 80°C: 86A-342A
- Plastic inserts with flammability rating of UL94-V0
- RoHS compliant

# Part Ordering Guide - RT & RTHP Series Plugs & Receptacles

| SERIES | STYLE | SHELL TYPE | INSERT ARRANGEMENT | TYPE OF CONTACTS | INSERT POLARIZATION | APPLICATION | DESIGN VARIATION | PLATING | INTERFACIAL SEAL VARIATION |
|--------|-------|------------|--------------------|------------------|---------------------|-------------|------------------|---------|----------------------------|
| *      | *     | *          | *                  | *                | *                   | *           | *                | *       | *                          |

## RT SERIES

### SERIES

- RT

### SHELL TYPE

- 0: Wall mount recep.
- 1: Inline receptacle
- 6: Cable plug
- 7: Jam nut recep. / rear panel mount

### SHELL SIZE

- 10, 12, 14, 16, 18, 20

### INSERT ARRANGEMENT

- See Page 7

### TYPE OF CONTACTS

- P: Pin contacts
- S: Socket contacts

### INSERT POLARIZATION (See Detail below)

- N: Standard version
- W, X, Y, Z: Custom orientation (consult Factory)

### APPLICATION

- Blank: Standard version (no o-ring)
- H: Standard version, water protection IP67

### DESIGN VARIATION

- Blank: Standard version
- EC: End cap & standard seal for wire 18~14AWG
- MM: End cap & reduced seal for wire 24~20AWG

### PLATING

- Blank: Standard is nickel plating (48hr salt spray)
- 1: Black anodized, jam nut (96hr salt spray)
- 2: Black anodized coupling ring (96hr salt spray)

### INTERFACIAL SEAL VARIATION

- Blank: Standard version, NBR
- 03: O-ring and seal gasket is silicone rubber
- 04: O-ring and seal gasket is Viton

## RTHP SERIES

### SERIES

- RT

### SHELL TYPE

- 0: Wall mount recep.
- 1: Inline receptacle
- 6: Cable plug
- 7: Jam nut recep. / rear panel mount

### SHELL SIZE

- 12, 14, 16, 20

### INSERT ARRANGEMENT

- See Page 7

### TYPE OF CONTACTS

- P: Pin contacts
- S: Socket contacts

### INSERT POLARIZATION

- N: Standard version

### APPLICATION

- Blank: Standard version (no o-ring)
- H: Standard version, water protection IP67

### DESIGN VARIATION

- Blank: Standard version
- EC: End cap

### PLATING

- Blank: Standard is nickel plating (48hr salt spray)
- 1: Black anodized, jam nut (96hr salt spray)
- 2: Black anodized coupling ring (96hr salt spray)

### INTERFACIAL SEAL VARIATION

- Blank: Standard version, NBR
- 03: O-ring and seal gasket is silicone rubber
- 04: O-ring and seal gasket is Viton

### Detail

Mating Face View of Pin Inserts

The five positions (W, X, Y, Z and Normal) differ in degree of rotation for various sizes and arrangements.

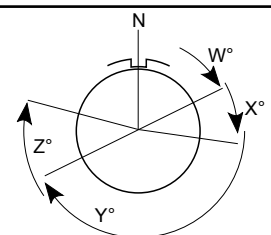

**Note:** Higher salt spray resistance (200/500h) upon request.

# Part Ordering Guide - RT Series Machined Contacts

| SERIES | WIRE SIZE | CONTACT SIZE | CONTACT PACKAGING | DESIGN VARIATION | GROUNDING CONTACT | PLATING |
|--------|-----------|--------------|-------------------|------------------|-------------------|---------|
| *      | *         | *            | *                 | *                | *                 | *       |

## SERIES

- **MP:** Male; **MS:** Female

## WIRE SIZE

- **14:** 14AWG (2.5mm); **16:** 18-16AWG (.75-1.5mm); **20:** 22-20AWG (.34-.50mm);
- **24:** 26-24AWG (.14-.25mm); **28:** 30-28AWG (.05-.08mm); **8:** 10-8AWG (6-10mm)

## CONTACT SIZE

- **M:** Size 16; **W:** Size 20; **A:** Size 8 Power Contact

## CONTACT PACKAGING

- **BP:** Bulk Pack only

## DESIGN VARIATION

- **23:** Crimp Barrel; **12E0xx:** PCB tail, for RT00( wall mouting receptacle) **xx** is outer length of PCB tail; **12E7xx:** PCB tail, for RT07( Jam Nut Receptacle) **xx** is outer length of PCB tail; **RS8:** Radsok 3.6mm, crimp barrel

## GROUNDING CONTACT

- **GE1:** For Male GND contacts (1 mm longer) add **GE1** to the part number (ex: MP16M23GE1G15); **GE1:** For Female GND contacts (1.5 mm longer) add **GE1** to the p/n (ex: MS16M23GE1G15); **GE7:** For Female Last Mate contacts (0.6 mm shorter) add **GE7** to the part number (ex: MS16M23GE7G15)

## PLATING

- **T:** Tin; **F:** Gold Flash; **G:** Gold Plate [Thickness: 10u"]; **G30:** Gold Plate [Thickness: 30u"]; **N:** Nickel; **S:** Plating Silver (5um)



| Contact Size | Wire Range |         | Plating    | Male P/N   | Female P/N |
|--------------|------------|---------|------------|------------|------------|
|              | AWG        | mm      |            |            |            |
| 8            | 10-8       | 6-10    | Silver     | MP8A23S    | MS8A23S    |
| 16           | 14         | 2.5     | Silver     | MP14M23S   | MS14M23S   |
|              |            |         | Gold Flash | MP14M23F   | MS14M23F   |
|              |            |         | Gold 30u"  | MP14M23G30 | MS14M23G30 |
| 16           | 18-16      | .75-1.5 | Silver     | MP16M23S   | MS16M23S   |
|              |            |         | Gold Flash | MP16M23F   | MS16M23F   |
|              |            |         | Gold 30u"  | MP16M23G30 | MS16M23G30 |
| 16           | 22-20      | .34-.50 | Silver     | MP20M23S   | MS20M23S   |
|              |            |         | Gold Flash | MP20M23F   | MS20M23F   |
|              |            |         | Gold 30u"  | MP20M23G30 | MS20M23G30 |
| 16           | 26-24      | .14-.25 | Silver     | MP24M23S   | MS24M23S   |
|              |            |         | Gold Flash | MP24M23F   | MS24M23F   |
|              |            |         | Gold 30u"  | MP24M23G30 | MS24M23G30 |
| 20           | 22-20      | .34-.50 | Silver     | MP20W23S   | MS20W23S   |
|              |            |         | Gold Flash | MP20W23F   | MS20W23F   |
|              |            |         | Gold 30u"  | MP20W23G30 | MS20W23G30 |
| 20           | 30-28      | .05-.08 | Silver     | MP28W23S   | MS28W23S   |
|              |            |         | Gold Flash | MP28W23F   | MS28W23F   |
|              |            |         | Gold 30u"  | MP28W23G30 | MS28W23G30 |



- Longer contact life
- Lower contact resistance
- Immunity to shock and vibration
- Low insertion and extraction forces
- Contact area extends 360° around pins

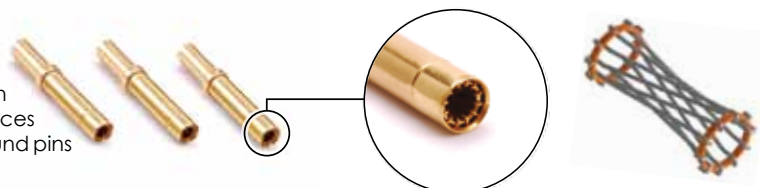



# Part Ordering Guide - RT Series Stamped & Formed Contacts

| SERIES | WIRE SIZE<br>AWG CRIMP | CONTACT SIZE | CONTACT PACKAGING | DESIGN VARIATION | PLATING |
|--------|------------------------|--------------|-------------------|------------------|---------|
| *      | *                      | *            | *                 | *                | *       |

## SERIES

- **SP:** Male; **SS:** Female

## WIRE SIZE

- **2.5mm:** 2.5mm; **16:** 18-16AWG (.75-1.5mm); **20:** 22-20AWG (.34-.50mm); **24:** 26-24AWG (.14-.25mm); **28:** 30-28AWG (.05-.08mm)

## CONTACT SIZE

- **M:** Size 16; **W:** Size 20; **A:** 2.5mm contact

## CONTACT PACKAGING

- **Blank:** 3,000 pc reel; **L:** Loose Piece

## DESIGN VARIATION

- **1:** Crimp type

## PLATING

- **T:** Tin; **F:** Gold Flash; **G:** Gold Plate [Thickness: 10u"]; **G30:** Gold Plate [Thickness: 30u"]; **N:** Nickel; **S:** Silver



| Contact Size | Wire Range |         | Plating    | Male P/N  | Female P/N |
|--------------|------------|---------|------------|-----------|------------|
|              | AWG        | mm      |            |           |            |
| 2.5mm        | NA         | 2.5     | Tin        | SP12A1T   | SS12A1T    |
| 16           | 14         | 2.5     | Gold Flash | SP14M1F   | SS14M1F    |
|              |            |         | Gold 10u"  | SP14M1G10 | SS14M1G10  |
|              |            |         | Gold 30u"  | SP14M1G30 | SS14M1G30  |
| 16           | 18-16      | .75-1.5 | Gold Flash | SP16M1F   | SS16M1F    |
|              |            |         | Gold 10u"  | SP16M1G10 | SS16M1G10  |
|              |            |         | Gold 30u"  | SP16M1G30 | SS16M1G30  |
| 16           | 22-20      | .34-.50 | Gold Flash | SP20M1F   | SS20M1F    |
|              |            |         | Gold 10u"  | SP20M1G10 | SS20M1G10  |
|              |            |         | Gold 30u"  | SP20M1G30 | SS20M1G30  |
| 16           | 26-24      | .14-.25 | Gold Flash | SP24M1F   | SS24M1F    |
|              |            |         | Gold 10u"  | SP24M1G10 | SS24M1G10  |
|              |            |         | Gold 30u"  | SP24M1G30 | SS24M1G30  |
| 20           | 22-20      | .34-.50 | Gold Flash | SP20W1F   | SS20W1F    |
|              |            |         | Gold 10u"  | SP20W1G10 | SS20W1G10  |
|              |            |         | Gold 30u"  | SP20W1G30 | SS20W1G30  |
| 20           | 26-24      | .14-.25 | Gold Flash | SP24W1F   | SS24W1F    |
|              |            |         | Gold 10u"  | SP24W1G10 | SS24W1G10  |
|              |            |         | Gold 30u"  | SP24W1G30 | SS24W1G30  |

# RADSOK® Technical Information

## High Reliability

Unique RADSOK® design and construction technology create an electrical contact interface that exceeds typical interconnect requirements. Applications in Aerospace, Medical, Industrial, Automotive, Mining, Offshore and other harsh environments depend on high reliability of the Amphenol RADSOK® technology.

## Low Contact Engagement/Separation Forces

The hyperbolic lamella socket contact construction distributes normal forces over a high percentage of the mating surface. This creates a smooth, even engagement effort. This force distribution also contributes to excellent performance in vibration applications with resistance to typical fretting corrosion.

## Low Contact Resistance

The large interface between the socket lamella and pin surface result in very low contact resistance, enabling the RADSOK® contacts' high current ratings compared to traditional power contact designs.

## High Mating Cycle Durability

RADSOK® contacts with typical silver plating finishes have demonstrated survival of 20,000 mating cycles. Specialized plating and contact lubricants can extend cycle life to 200,000 mating or higher. Even with continuous exposure to harsh environmental abuse (salt, sand and high humidity), RADSOK® contacts have been tested to maintain low contact resistance beyond 10,000 mating cycles.



| RTHP RADSOK®              | 3.6mm   | 6mm  | 8mm   |
|---------------------------|---|--|---|
| Current<br>(DIN EN 60512) | 115A (23°C)<br>107A (40°C)<br>86A (80°C)<br>56A (120°C) | 155A (23°C)<br>148A (40°C)<br>116A (80°C)<br>77A (120°C) | 240A (23°C)<br>235A (40°C)<br>185A (80°C)<br>120A (120°C) |
| Contact Resistance        | = 0.15mΩ  | = 0.11mΩ   | = 0.08mΩ  |
| Mating Force              | = 10NV  | = 20N  | = 50N   |
| m                         | 1.5g  | 5.6g   | 14.5g   |
| l                         | 13.2mm  | 21.9mm   | 25.7mm  |
| di                        | 3.6mm   | 6mm  | 8mm   |
| da                        | 6mm   | 9.5mm  | 13.5mm  |
| Plating                   | Grid: Silver<br>Sleeve: Silver                          | Grid: Silver<br>Sleeve: Tinned                           | Grid: Silver<br>Sleeve: Tinned                            |

**Note:** The given electrical values correspond to a single contact. With the addition of a housing, an increased number of poles or other modifications, the values must be adjusted downwards accordingly.

# Part Ordering Guide - RTHP Series Machined Contacts

| SERIES | WIRE SIZE | CONTACT SIZE | CONTACT PACKAGING | DESIGN VARIATION | PLATING |
|--------|-----------|--------------|-------------------|------------------|---------|
| *      | *         | *            | *                 | *                | *       |

**SERIES**

- **HP:** Male; **HS:** Female

**WIRE SIZE**

- **10:** 8-10mm<sup>2</sup>; **16:** 13-16mm<sup>2</sup>; **25:** 20-25mm<sup>2</sup>; **35:** 30-35mm<sup>2</sup>; **50:** 40-50mm<sup>2</sup>; **75:** 70-75mm<sup>2</sup>

**CONTACT SIZE**

- **A:** 3.6mm; **B:** 6mm; **C:** 8mm; **D:** 10mm

**CONTACT PACKAGING**

- **BP:** Bulk Pack Only

**DESIGN VARIATION**

- **C:** Crimp Barrel; **P:** PCB Tail; **S:** Screw Tail; **W:** Soldier Tail; **H:** Flat Hole Tail

**PLATING**

- **T:** Tin; **F:** Gold Flash; **G:** Gold Plate [Thickness: 10u"]; **G30:** Gold Plate [Thickness: 30u"]; **N:** Nickel; **S:** Plating Silver (5um)



| Contact Size | Wire Range | Plating | Male P/N | Female P/N | Type          |
|--------------|------------|---------|----------|------------|---------------|
| 3.6mm        | 8-10mm     | Silver  | HP10ACS  | HS10ACS    | Crimp         |
|              |            |         | HP10ASS  | HS10ASS    | Screwtail     |
|              |            |         | HP10AHS  | HS10AHS    | Flathole Tail |
| 6mm          | 20-25mm    | Silver  | HP25BCS  | HS25BCS    | Crimp         |
|              |            |         | HP25BSS  | HS25BSS    | Screwtail     |
|              |            |         | HP25BHS  | HS25BHS    | Flathole Tail |
| 8mm          | 30-35mm    | Silver  | HP35CCS  | HS35CCS    | Crimp         |
|              |            |         | HP35CSS  | HS35CSS    | Screwtail     |
|              |            |         | HP35CHS  | HS35CHS    | Flathole Tail |
| 10mm         | 40-50mm    | Silver  | HP50DCS  | HS50DCS    | Crimp         |
|              |            |         | HP50DSS  | HS50DSS    | Screwtail     |
|              |            |         | HP50DHS  | HS50DHS    | Flathole Tail |

Consult Factory for additional Touch Proof options.

## Typical Product Picture and Installation Dimension - RTHP Series



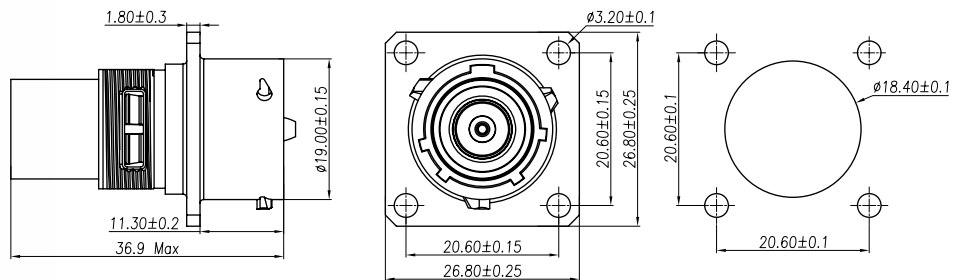

To be used within HV and EV when enduring large current and high voltage

Wall Mounting Receptacle for Crimp Barrel

Part Number: RTHP0121PNH-16C

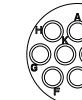
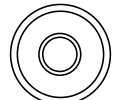
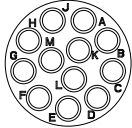
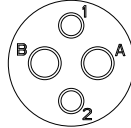
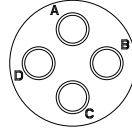
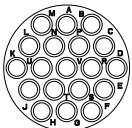
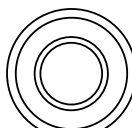
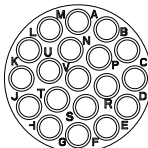
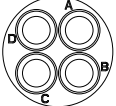
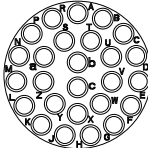
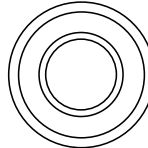
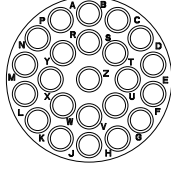
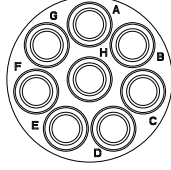
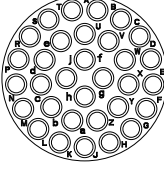
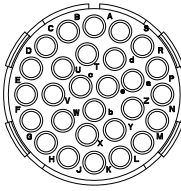
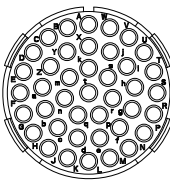
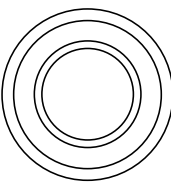

# Insert Configuration

| RTO   |   |  |   |  | RTHP Radsok®   |
|---|---|--|---|--|--|
| #16 Contacts (1.6mm)<br>13A/250V  | VDE Versions<br>Mixed Power/Signal  | Contacts<br>(2.5mm)  | #20 Contacts<br>(1.0mm)<br>5A/150V <b>(1)</b><br>7.5A/150V <b>(2)</b>   | Single<br>Pin Power  |  |
| <b>Note:</b> Specific to RTO, <b>(1)</b> refers to Stamped and Formed contacts; <b>(2)</b> refers to Machined contacts. |   |  |   |  |  |
| Shell<br>10   | <br>10-4             | <br>10-2<br>2x#16(13A)/2X#20(5A)<br>350V AC/DC  | N/A   | <br>10-6    | N/A  |
| Shell<br>12   | <br>12-3             | N/A  | N/A   | <br>12-10   | <br>12-1<br>1x3.6mm (86A)<br>600V AC/DC   |
| Shell<br>14   | <br>14-12<br>1x3.6mm | <br>14-2<br>2x2.5(23A)/2x#16(13A)<br>350V AC/DC | <br>14-4<br>(23A)<br>350V AC/DC | <br>14-19   | <br>14-1<br>1x6mm (116A)<br>600V AC/DC    |
| Shell<br>16   | <br>16-19          | <br>16-4<br>4x3.6(46A)<br>400 AC/DC           | N/A   | <br>16-26 | <br>16-1<br>1x8mm (185A)<br>600V AC/DC  |
| Shell<br>18   | <br>18-23          | N/A  | <br>18-8<br>(23A) 375V AC/DC  | <br>18-32 | N/A  |
| Shell<br>20   | <br>20-28          | N/A  | N/A   | <br>20-41 | <br>20-1<br>1x10mm (342A)<br>600V AC/DC |

All dimensions are in mm. Face Views are not actual size and are only meant as a representation.

## Box and Wall Mounts

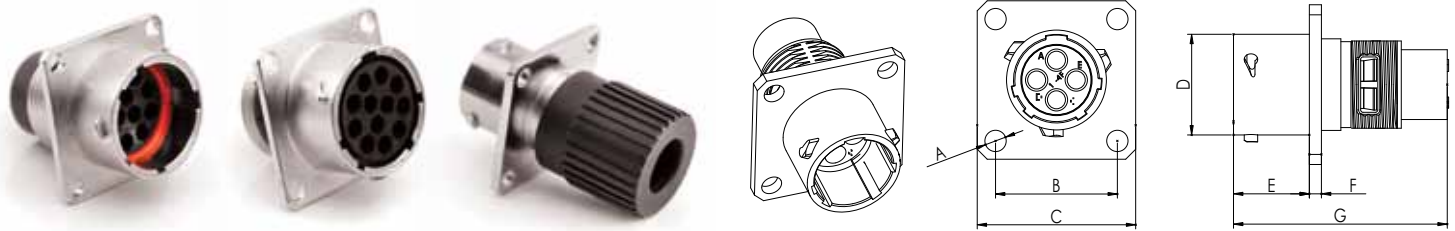

|          | A    | B     | C     | D     | E     | F    | G     | G + End Cap Male | G + End Cap Female |
|----------|------|-------|-------|-------|-------|------|-------|------------------|--------------------|
| Shell 10 | 3.20 | 18.30 | 23.80 | 15.00 | 11.30 | 1.80 | 31.85 | 40.65            | 32.70              |
| Shell 12 | 3.20 | 20.62 | 26.20 | 19.00 | 11.30 | 1.80 | 31.85 |                  |                    |
| Shell 14 | 3.20 | 23.00 | 28.60 | 22.20 | 11.30 | 1.80 | 31.85 |                  |                    |
| Shell 16 | 3.20 | 24.60 | 31.00 | 25.30 | 11.30 | 1.80 | 31.85 |                  |                    |
| Shell 18 | 3.20 | 26.95 | 33.30 | 28.55 | 11.30 | 1.80 | 31.85 |                  |                    |
| Shell 20 | 3.20 | 29.50 | 36.50 | 31.70 | 14.55 | 2.40 | 33.65 |                  |                    |

## Straight Plugs

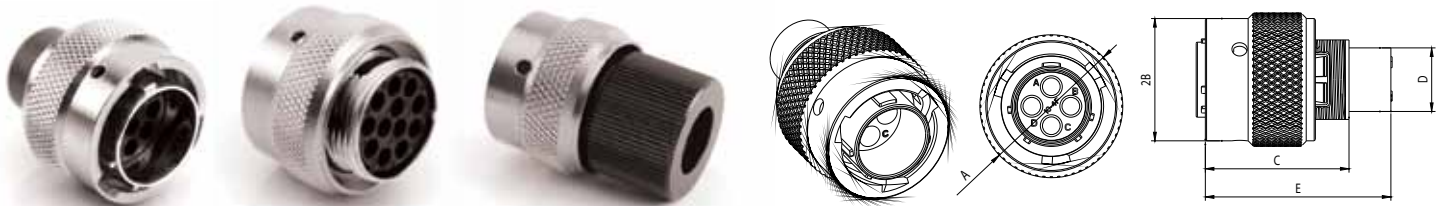

|          | A     | B     | C     | D     | E     | H + End Cap Male | H + End Cap Female |
|----------|-------|-------|-------|-------|-------|------------------|--------------------|
| Shell 10 | 21.80 | 20.00 | 23.50 | 10.40 | 30.35 | 40.65            | 32.70              |
| Shell 12 | 26.10 | 23.60 | 23.50 | -     | 30.35 |                  |                    |
| Shell 14 | 29.30 | 26.80 | 25.32 | 16.65 | 32.17 |                  |                    |
| Shell 16 | 32.45 | 30.00 | 23.50 | 19.50 | 30.35 |                  |                    |
| Shell 18 | 35.25 | 33.30 | 23.50 | 21.90 | 30.45 |                  |                    |
| Shell 20 | 38.55 | 36.55 | 25.80 | 25.20 | 30.65 |                  |                    |

## Jam Nut Receptacle



|          | A     | B     | C     | D     | E    | F     | G     | G + End Cap Male | G + End Cap Female |
|----------|-------|-------|-------|-------|------|-------|-------|------------------|--------------------|
| Shell 10 | 22.20 | 27.00 | 16.23 | 15.00 | 2.20 | 19.30 | 33.00 | 40.70            | 40.70              |
| Shell 12 | 20.50 | 27.00 | 31.75 | 19.00 | 2.20 | 19.30 | 33.00 |                  |                    |
| Shell 14 | 23.60 | 30.20 | 34.90 | 22.20 | 2.20 | 19.30 | 33.00 |                  |                    |
| Shell 16 | 26.85 | 33.30 | 38.10 | 25.30 | 3.70 | 19.30 | 33.30 |                  |                    |
| Shell 18 | 29.86 | 36.50 | 41.30 | 28.55 | 2.50 | 19.30 | 33.00 |                  |                    |
| Shell 20 | 33.95 | 39.70 | 46.10 | 31.70 | 3.60 | 24.70 | 38.55 |                  |                    |

## Cord Grips

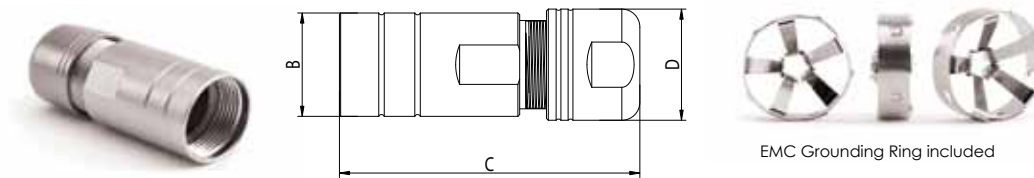

|          | Amphenol P/N | Cable Range | A (Thread)      | B    | C     |
|----------|--------------|-------------|-----------------|------|-------|
| Shell 10 | RTOL-10CG-S1 | 3 to 6.5    | 9/16-24 UNEF    | 50   | 18.50 |
|          | RTOL-10CG-S2 | 5 to 8.5    |                 |      |       |
| Shell 12 | RTOL-12CG-S1 | 6 to 10.5   | 11/16-24 UNEF   | 54   | 23.00 |
|          | RTOL-12CG-S2 | 8 to 12.5   |                 |      |       |
| Shell 14 | RTOL-14CG-S1 | 6 to 10.5   | 13/16-20 UNEF   | 54   | 23.00 |
|          | RTOL-14CG-S2 | 8 to 12.5   |                 |      |       |
| Shell 16 | RTOL-16CG-S1 | 9.5 to 14.5 | 15/16-20 UNEF   | 60   | 26.50 |
|          | RTOL-16CG-S2 | 13.5 to 18  |                 |      |       |
| Shell 18 | RTOL-18CG-S1 | 9.5 to 14.5 | 1" 1/16-18 UNEF | 60   | 28.20 |
|          | RTOL-18CG-S2 | 13.5 to 18  |                 |      |       |
| Shell 20 | RTOL-20CG-S1 | 16.5 to 22  | 1" 3/16-18 UNEF | 63.5 | 33    |
|          | RTOL-20CG-S2 | 21.5 to 24  |                 |      |       |

All dimensions are in mm.

## Metal Cable Clamp Cord Grip

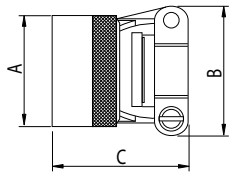

|          | Amphenol P/N | Max. Cable Diam. | A (Thread)      | B    | C    |
|----------|--------------|------------------|-----------------|------|------|
| Shell 10 | RT10SR       | 5.0              | 9/16-24 UNEF    | 21.6 | 31.0 |
| Shell 12 | RT12SR       | 8.2              | 11/16-24 UNEF   | 25.0 | 31.5 |
| Shell 14 | RT14SR       | 10.0             | 13/16-20 UNEF   | 27.4 | 34.0 |
| Shell 16 | RT16SR       | 13.0             | 15/16-20 UNEF   | 29.4 |      |
| Shell 18 | RT18SR       | 16.0             | 1" 1/16-18 UNEF | 35.2 | 31.4 |
| Shell 20 | RT20SR       | 21.0             | 1" 3/16-18 UNEF | 37.6 | 32.0 |

**Metal Cable Clamp Cord Grip Plating Options Example:** RT10SR( ); RT10SR1; RT10SR2

( ): Standard is nickel plating (48hr salt spray)

1: Black anodized (96hr salt spray)

2: Black anodized (96hr salt spray)



## Wall Mounted Receptacle for Flat Hole Tail

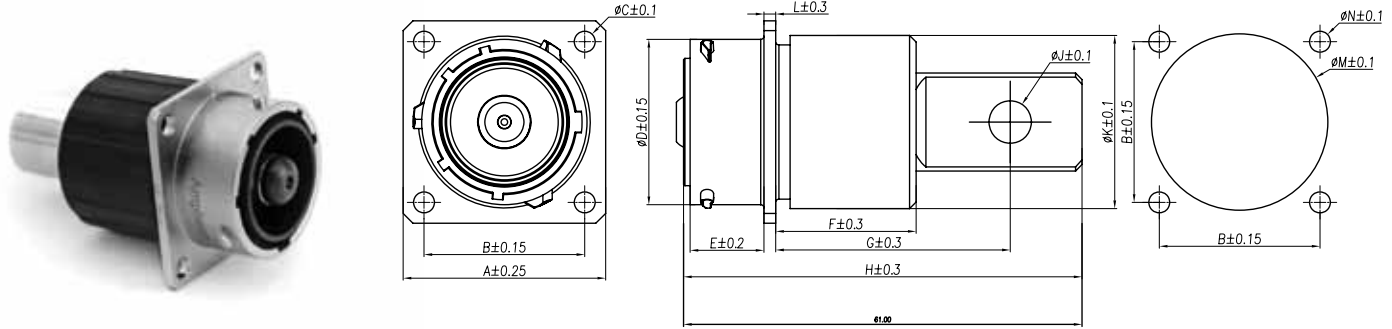

| Amphenol P/N |               | A    | B    | ΦC  | ΦD   | E     | F    | G    | H    | J   | K    | L   | ΦN  | ΦM   |
|--------------|---------------|------|------|-----|------|-------|------|------|------|-----|------|-----|-----|------|
| Shell 12     | RTHP0121PN-H1 | 26.8 | 20.6 | 3.2 | 19.0 | 11.35 | 19.6 | 34.0 | 55.1 | 5.5 | 21.8 | 1.8 | 3.2 | 22.5 |
| Shell 14     | RTHP0141PN-H1 | 23.0 | 28.6 |     | 22.2 |       | 17.2 | 28.5 | 53.1 | 5.5 | 23.9 |     |     | 24.5 |
| Shell 16     | RTHP0161PN-H1 | 24.6 | 31.0 |     | 25.3 |       | 21.5 | 35.9 | 61.0 | 6.5 | 26.5 |     |     | 27.0 |
| Shell 20     | RTHP0201PN-H1 | 29.4 | 26.5 | 4.2 | 31.7 | 14.55 | 22.2 | 40.1 | 72.0 | 8.5 | 33.5 | 2.4 | 4.2 | 34.0 |

## Straight Cable Plug with Cord Grip Solutions

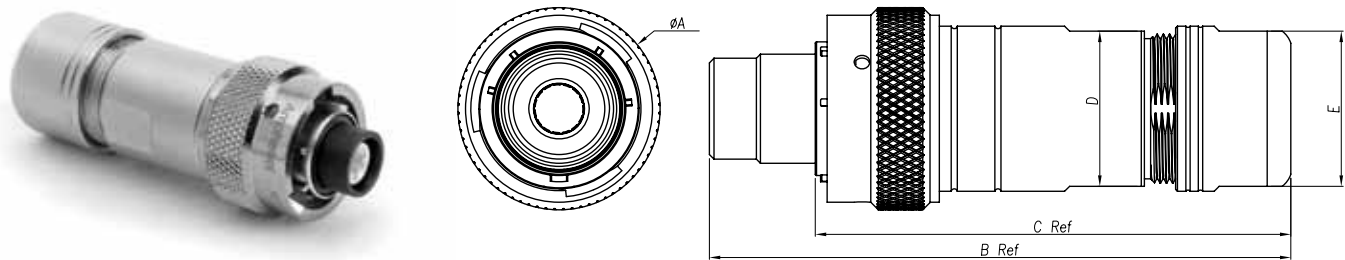

| Amphenol P/N |                  | A    | B     | C    | D    | E    | Wire size             | Cable max. |
|--------------|------------------|------|-------|------|------|------|-----------------------|------------|
| Shell 12     | RTHP6121SNH-16S2 | 26.1 | 79.3  | 73.3 | 19.9 | 21.9 | 13-16 mm <sup>2</sup> | 12.5 mm    |
| Shell 14     | RTHP6141SNH-25S2 | 29.3 | 86.4  | 72.3 | 19.9 | 21.9 | 20-25 mm <sup>2</sup> | 12.5 mm    |
| Shell 16     | RTHP6161SNH-35S2 | 32.5 | 93.3  | 76.3 | 24.9 | 24.9 | 30-35 mm <sup>2</sup> | 17.5 mm    |
| Shell 20     | RTHP6201SNH-70S2 | 38.6 | 100.9 | 80.8 | 28.9 | 28.9 | 70-75 mm <sup>2</sup> | 20.0 mm    |

All dimensions are in mm.



## Straight Cable Plug with End Cap

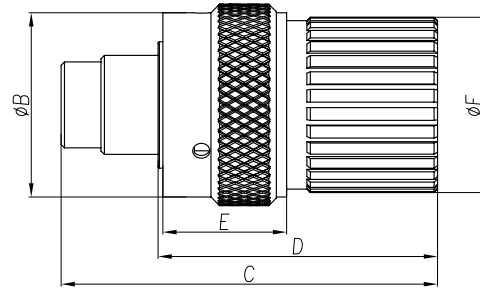
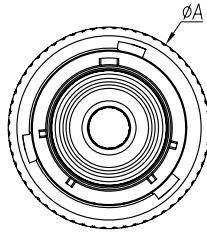

|          | Amphenol P/N     | A    | B    | C    | D    | E    | ΦF   | Wire size             | Cable max. |
|----------|------------------|------|------|------|------|------|------|-----------------------|------------|
| Shell 12 | RTHP6121SNH-16EC | 26.1 | 23.6 | 38.7 | 32.7 | 18.0 | 21.8 | 13-16 mm <sup>2</sup> | 12.5 mm    |
| Shell 14 | RTHP6141SNH-25EC | 29.3 | 26.8 | 54.8 | 40.7 |      | 25.5 | 20-25 mm <sup>2</sup> | 12.5 mm    |
| Shell 16 | RTHP6161SNH-35EC | 32.5 | 30.0 | 57.7 | 40.7 |      | 27.5 | 30-35 mm <sup>2</sup> | 17.5 mm    |
| Shell 20 | RTHP6201SNH-70EC | 38.6 | 36.6 | 62.7 | 42.7 | 19.0 | 34.5 | 70-75 mm <sup>2</sup> | 20.0 mm    |

## Straight Cable Plug with 90° Cord Grip Solutions

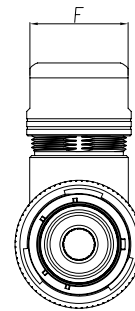
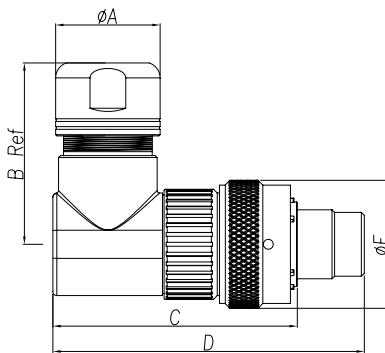

|          | Amphenol P/N      | A    | B    | C    | D    | ΦE   | ΦF   | Wire size             | Cable max. |
|----------|-------------------|------|------|------|------|------|------|-----------------------|------------|
| Shell 12 | RTHP6121SNH-16BS2 | 23.0 | 43.0 | 58.7 | 64.7 | 26.1 | 21.9 | 13-16 mm <sup>2</sup> | 12.5 mm    |
| Shell 14 | RTHP6141SNH-25BS2 | 26.5 | 46.0 | 62.0 | 76.1 | 29.3 | 24.9 | 20-25 mm <sup>2</sup> | 12.5 mm    |
| Shell 16 | RTHP6161SNH-35BS2 | 26.5 | 46.0 | 62.0 | 79.0 | 29.3 | 24.9 | 30-35 mm <sup>2</sup> | 17.5 mm    |
| Shell 20 | RTHP6201SNH-70BS2 | 31.0 | 54.3 | 75.0 | 95.0 | 26.6 | 29.0 | 70-75 mm <sup>2</sup> | 20.0 mm    |

## Accessories & Tooling

### Dust Caps

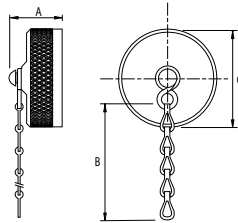

### Sealing Plugs



|          | Amphenol P/N | A max. | B     | C max. |
|----------|--------------|--------|-------|--------|
| Shell 10 | RT010DCG     | 21.8   | 42.00 | 30.20  |
| Shell 12 | RT012DCG     | 24.6   |       |        |
| Shell 14 | RT014DCG     | 27.8   |       |        |
| Shell 16 | RT016DCG     | 31.0   |       |        |
| Shell 18 | RT018DCG     | 35.3   |       |        |
| Shell 20 | RT020DCG     | 38.6   |       |        |

|       | Amphenol P/N | mm  |
|-------|--------------|-----|
| 16AWG | CA-4016-59   | 1.5 |
| 20AWG | CA-4020-59   | 0.5 |

### Stamp Contact Tool

(Stamped and Formed Contacts)



|       | Amphenol P/N |
|-------|--------------|
| 16AWG | MFX-3954     |
| 20AWG | MFX-3958     |
| 2.5mm | MFX-3962     |

### Universal Hand Crimp Tool

(Machined Contacts)



|  | Amphenol P/N |
|--|--------------|
|  | MFX-3959     |

### Contact Extraction Tool



|       | Amphenol P/N |
|-------|--------------|
| 16AWG | QXRT16       |
| 20AWG | QXRT20       |
| 2.5mm | QXRT12S      |

All dimensions are in mm.

## Crimp Die (Stamped and Formed Contacts)



| Amphenol P/N |          |
|--------------|----------|
| 16AWG        | MFX-3957 |
| 20AWG        | MFX-3964 |
| 2.5mm        | MFX-3965 |

## Pneumatic Crimp Tool (Machined Contacts)



| Amphenol P/N |
|--------------|
| MFX-3960     |

## Gaskets

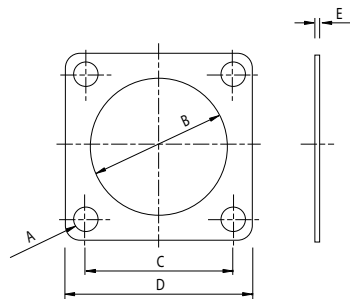

| Amphenol P/N |         | $\varnothing A \pm 0.1$ | $\varnothing B \pm 0.01$ | $C \pm 0.25$ | $D \pm 0.25$ | $E \pm 0.2$ |
|--------------|---------|-------------------------|--------------------------|--------------|--------------|-------------|
| Shell 10     | RTFD10B | 3.3                     | 15.9                     | 18.3         | 23.8         | 0.8         |
| Shell 12     | RTFD12B |                         | 19.0                     | 20.6         | 26.2         |             |
| Shell 14     | RTFD14B |                         | 22.2                     | 23.0         | 28.6         |             |
| Shell 16     | RTFD16B |                         | 25.4                     | 24.6         | 31.0         |             |
| Shell 18     | RTFD18B |                         | 28.6                     | 27.0         | 33.3         |             |
| Shell 20     | RTFD20B |                         | 31.8                     | 29.4         | 36.5         |             |

Gasket material is NBR. For other options, please consult factory.

## NORTH AMERICA

### Amphenol Sine Systems MICHIGAN

44724 Morley Drive  
Clinton Township, MI 48036  
Toll-Free: 1-800-394-7732  
Fax: 1-586-465-1216  
Email: sine\_info@sineco.com

## EUROPE

### Amphenol Air LB

29, voie d' Yvois  
F-08110 Blagny, France  
Phone: 33-3-2422-7849  
Fax: 33-3-2422-7875  
Email: accueil@amphenol-airlb.fr

### Amphenol AIR LB GmbH

Am Kleinbahnhof 4  
Saarlouis D-66740, Germany  
Phone: 49-6831-981-00  
Fax: 49-6831-981-030  
Email: info@amphenol-airlb.de

### Amphenol BENELUX

Zadelmaker 121  
NL-2401PD Alphen aan den Rijn  
The Netherlands  
Phone: (31) 172 444903  
Fax: (31) 172 240254  
E-mail: info@amphenol-nl.com

### Amphenol CENTER EAST EUROPE, POLAND and AUSTRIA

Wiener Gasse 68  
2380 Perchtoldsdorf, Austria  
Phone: 43-699-10396071  
Fax: 43-699-40396071  
Email: c.czesch@amphenol-roe.eu

## ASIA

### Amphenol Sine Systems CHINA

2/F Building A5, Hua Feng Technology Park  
Guan Tian, Bei Huan Road, Shi Yan Street  
Bao An District, Shenzhen, China 518108  
Tel: 86-755-8173-8000 ext. 8098  
Fax: 86-755-8173-8180  
Email: fount.nee@amphenolpcd.com.cn

### Amphenol INTERCONNECT INDIA PRIVATE LTD

105 Bhosari Industrial Area  
Pune 411 026, India  
Phone: 91-20-712-0363/0463/0155  
Fax: 91-20-712-0581

## OTHER LOCATIONS

### Amphenol MEXICO

Prolongacion Reforma 61-6 B2  
Col. Paseo de las Lomas  
C.P. 01330 Mexico DF, Mexico  
Phone: 52-55-5258-9984  
Fax: 52-55-5081-6890  
Email: www.amphenolmexico.com

### Amphenol ARGENTINA

Avenida Callao 930  
2nd floor Office B Plaza  
C1023AAP Buenos Aires, Argentina  
Phone: 54-11-4815-6886  
Fax: 54-11-4814-5779

### Amphenol BRASIL LTDA

Rua Diogo Moreira, 132  
20 Andar, Rooms 2001-2-3  
CEP 05423-101  
Sao Paulo- SP, Brazil  
Phone: 55-11-3815-1003  
Fax: 55-11-3815-1629  
Email: vendas@amphenol.com.br

### Amphenol ESPANA

Edificio Burgosol, Oficina N 55  
C/Comunidad de Madrid, 35 bis  
Las Rozas (Madrid), 28230  
Phone: 34-91-6407302  
Mobile: 34-629054629  
Fax: 34-91-6407307  
Email: e.bendix@amphenol-roe.eu

### Amphenol ITALIA

Via Barbaiana 5  
20020 Lainate, Milano, Italy  
Phone: 39-02-932541  
Fax: 39-02-9325444  
Email: r.buscone@amphenol-roe.eu

### Amphenol NORDIC

Appelboms vag 2  
SE-18642 Vallentuna, Sweden  
Phone: 46-76-8418600  
Fax: 46-70-2203197  
Email: f.weden@amphenol-roe.eu

### Amphenol SOCAPEX

948, Promenade de l'Arve - BP 29  
74311 Thyez CEDEX, France  
Phone: 33(0)4-50-89-28-40  
Fax: 33(0)4-50-96-29-75  
Email: jocelyne.anthoine@amphenol-socapex.fr

### Amphenol DAESHIN

558, Songnae-2 Dong, SoSa-Gu  
Bucheon City, Gyeonggi-do, Korea 422-818  
Phone: 81-32-610-3800  
Fax: 81-32-673-2507  
Email: info@amphenol.co.kr

### Amphenol JAPAN

471-1, Deba, Ritto-city  
shiga 520-3041, Japan  
Phone: 81-77-553-8501  
Fax: 81-77-551-2200

### Amphenol SOUTH AFRICA

30 Impala Road  
2196 Sandton, Chislehurst  
South Africa  
Phone: 27-11-783-9517  
Fax: 27-11-783-9519  
Email: amphenol\_africa@csi.com

### Amphenol AUSTRALIA PTY LIMITED

2 Fiveways Blvd., Keysborough  
Melbourne, Victoria 3173 Australia  
Phone: 613-8796-8888  
Fax: 613-8796-8801

### Amphenol TURKEY

Ayazaga Mah. Meyden Sk. No. 28  
Beybi Giz Plaza, Kat. 26  
34396 Maslak/Istanbul, Turkey  
Phone: 90-212-335-2501  
Fax: 90-212-335-25-00

### Amphenol SWITZERLAND & SOUTH CENTER EUROPE

Switzerland, Slovenia, Serbia, Montenegro,  
Yugoslavia, Greece, Bulgaria  
948, Promenade de l'Arve - BP29  
74311 Thyez - France  
Phone: 33-4-50-89-28-00  
Fax: 33-4-50-96-29-75

### Amphenol TUCHEL GmbH

August-Haeusser-Strasse 10  
Heilbronn, 74080  
Germany  
Phone: 49(0)-7131-929-0  
Fax: 49(0)-7131-929-486  
Email: info@amphenol.de

### Amphenol LIMITED

Thanet Way, Whitstable  
Kent CT5 3JF, United Kingdom  
Phone: 44-1-227-773200  
Fax: 44-1-227-276571

### Amphenol TERRIER TECHNOLOGIES

Unif 14, Northlake Industrial Park  
Malcolm Moodie Crescent, Jet Park  
Gauteng, South Africa  
Phone: 27-11-397-6069  
Fax: 27-11-397-8874

### Amphenol BAR TEC LTD

4 Hagavish St., PO Box 279  
Kfar Saba 44102, Israel  
Phone: 972-9-767-4097  
Fax: 972-9-767-4324

### Amphenol RUSSIA

8 Yaroslavskaja Street  
Floor 2 129164 Moscow, Russia  
Phone: 7495-937-6341  
Fax: 7495-937-6319  
Email: russia@amphenol.com