

FLUKE

DP120
Differential Voltage Probe

Instruction Sheet

Introducing the DP120

The DP120 is a safety designed differential voltage probe for floating high voltage measurements. The probe can be used on electronic high-power converters, motor speed controls, switch mode power supplies, and other high voltage circuits.

Unpacking

- Check that the following items are included with the DP120:
- **DP120** - Differential Voltage Probe
 - **AC85A** - Large Jaw Alligator Clips (red and black)
 - **AC83** - Pin-Grabber Test Clips (red and black)
 - 9V Alkaline Battery

Using the DP120 Safely

In this manual a **Warning** identifies conditions and actions that pose hazards to the user. Symbols used on the DP120 and in this instruction sheet are explained in the next table.

	See explanation in manual		Conformité Européenne
	Double Insulation (Protection class)		UL3111 listed
			Recycle

Warning

Do the following to avoid electrical shock or fire if the probe is connected to more than 42V peak (30V rms):

- Use only Fluke power adapter, model PM8907 (option).
- Connect the power adapter to the AC outlet before connecting it to the DP120.
- Do not insert metal objects in the power adapter connector.
- Use 600V rated test lead adapters. The maximum allowable input voltage is 600V, Category III.

Powering the DP120

Follow the procedure (steps 1 to 3) to power the probe from a standard ac outlet.

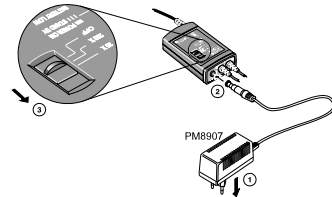

LIMITED WARRANTY & LIMITATION OF LIABILITY

This Fluke product will be free from defects in material and workmanship for one year from the date of purchase. This warranty does not cover fuses, disposable batteries or damage from accident, neglect, misuse or abnormal conditions of operation or handling. Resellers are not authorized to extend any other warranty on Fluke's behalf. To obtain service during the warranty period, send your defective product to the nearest Fluke Authorized Service Center with a description of the problem.

THIS WARRANTY IS YOUR ONLY REMEDY. NO OTHER WARRANTIES, SUCH AS FITNESS FOR A PARTICULAR PURPOSE, ARE EXPRESSED OR IMPLIED. FLUKE IS NOT LIABLE FOR ANY SPECIAL, INDIRECT, INCIDENTAL OR CONSEQUENTIAL DAMAGES OR LOSSES, ARISING FROM ANY CAUSE OR THEORY.

Since some states or countries do not allow the exclusion or limitation of an implied warranty or of incidental or consequential damages, this limitation of liability may not apply to you.

Fluke Corporation
P.O. Box 9090
Everett WA
98206-9090, USA

Fluke Industrial B.V.
P.O. Box 680
7600 AR Almelo
The Netherlands

April 1997, Rev. 5, 4/99
© 1997, 1999 Fluke Corporation
All rights reserved.
Printed in the Netherlands
All product names are trademarks of their respective companies.



Using the DP120

To use the differential voltage probe, do the following:

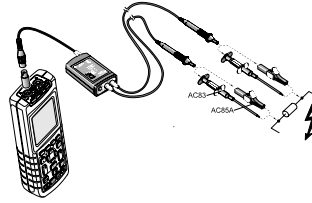

- 1 Connect the probe's output cable to the desired input on the test tool. For Fluke 123, use the black banana-to-BNC adapter (BB120).
- 2 On the probe, select the 200x range. Ensure that the green POWER ON-indicator is lit.
- 3 On the test tool, ensure that the probe correction is set to 200:1. If not available, set to 100:1.
- 4 Connect both probe inputs to the measuring points.
- 5 When the test tool is not in auto range, adjust the vertical range for optimal display.
- 6 When using the 100:1 probe correction, multiply the voltage reading on the screen by 2x.
- 7 At completion, be sure to set the range selection switch to OFF again.

Measurement tips:

- Use the 20x range on the differential voltage probe for smaller signals, such as ripple on a high voltage reference lead.
- At 20x range, set the test tool range to 20:1 (or 10:1).
- When the probe is battery operated, the red LED indicates that the battery level is low and the battery needs to be replaced.
- When battery operated, the probe automatically goes to standby mode after 30 minutes to conserve battery power. A blinking green LED indicates that the probe is in standby mode. To continue operation, turn the range selection switch from OFF to 20x or 200x.
- Connect the red probe cable to a higher voltage level than the black probe cable.
- For a dual measurement on test tool inputs A and B, connect the common to earth ground. This ensures optimal measurement accuracy on all inputs. For operating and grounding principles of the differential voltage probe, see the next figure.

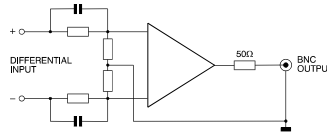

Application of Testing an Adjustable Speed Drive Timing Circuit

One of the tasks of the control inverter in an adjustable speed drive (ASD) is timing of the output inverter switching. The voltage waveform of the pulse width modulated (PWM) output inverter is a series of pulses of constant magnitude (height), but varying width. The control circuitry manages the timing of these pulses.

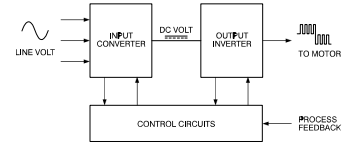

When one of the stages of the output inverter does not function properly, check the following:

- the output stage
- the control circuitry

The figure below shows how to connect a ScopeMeter® test tool and a DP120 to the circuitry.

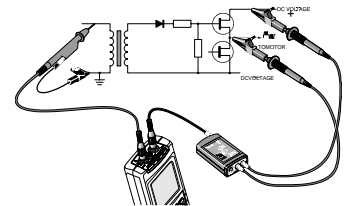

Note that the timing circuit for the FET (Field Effect Transistor) drive is referenced to earth ground. The gate drive signal is isolated with a transformer coupling to the FET, which is connected to the DC-voltage.

An example of comparing the timing signal to the signal at the drive output can be seen in the screen below.

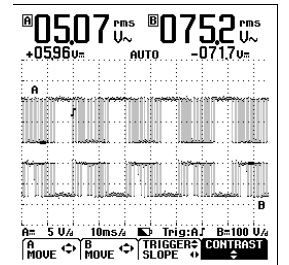

Installing or Replacing the Battery

Replace the battery when the red LED lights, or when both red and green LEDs are off when the probe is turned on.

Warning

To avoid electrical shock, disconnect the differential voltage probe from any conductor, and disconnect the Scopeliter™ test tool or oscilloscope before replacing the battery.

Follow the procedure (steps 1 to 5) to install or replace the battery.

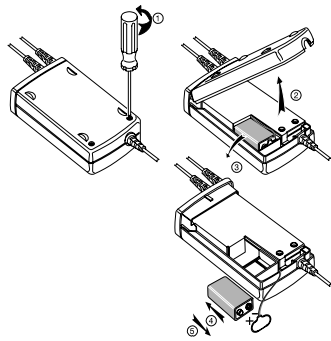

Characteristics

FLUKE guarantees the properties expressed in numerical values with the stated tolerance. Specified non-tolerance numerical values indicate those that could be nominally expected from the mean of a range of identical differential voltage probes.

Input Characteristics

Input Probe Tip Style: Shrouded banana probe tip

Probe Cable Length: 1.5 meter (60 inch)

Maximum Input Voltage to Ground:

600V CAT III
1000V CAT II

Installation Category III refers to distribution level and fixed installation circuits inside a building. Installation Category II refers to local level, which is applicable for appliances, and portable equipment.

Maximum Differential Input Voltage:

1000 VDC, or
1000 Vrms, or
1200V (DC+AC peak)

Note

(DC+AC peak) limit is determined by the point at which the differential voltage probe starts clipping.

For derating of each input probe (red or black), see figure below.

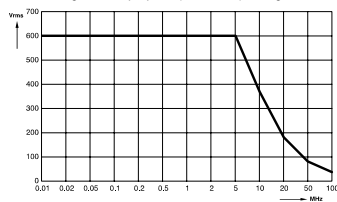

Output Characteristics

Output Cable: Safety designed BNC cable

Cable Length: 0.5 meter (20 inch)

Max. Output Voltage Range: ±6.5V into 1 MΩ

Electrical Characteristics

Attenuation: 200x and 20x

Bandwidth: (into 1 MΩ, 50 pF)

200x: DC to 20 MHz (-3 dB)

20x: DC to 20 MHz (-3 dB)

Accuracy: ±2.5% into 1 MΩ

Rise time:

200x: 17.5 ns

20x: 17.5 ns

CMRR:

200x: @60Hz= >80 dB, @1 MHz= >50 dB

20x: @60Hz= >70 dB, @1 MHz= >40 dB

Input Impedance:

Between each input to shielding BNC: 5 MΩ, 6 pF

Between the inputs: 10 MΩ, 5 pF

Output impedance: 50Ω

Noise:

200x: <2 mVrms

20x: <3 mVrms

Offset: ≤10 mV into 1 MΩ

Switch positions: OFF, 200x, 20x

Power

External:

Via power adapter PM8907 (optional)

Internal:

Battery Power: Alkaline 9V, IEC6LR61

Battery Life: 8 hour operation

400 hour in auto standby

Battery life measured @ 25 °C with Duracell® alkaline battery. (Delivered with probe.)

Power indicators:

Green LED: ON at normal operation.

blinks at standby.

To change from standby to normal operation turn switch from OFF to 20x or 200x.

Red LED: ON when battery needs to be replacing.

Auto Stand By:

After 30 minutes, only when battery operated.

Environmental

Meets requirements of:

MIL-T-28800E, Type III, Class 3.

EN 50081-1, Electromagnetic Compatibility Generic Emission Standard: EN55022 and EN60555-2.

EN 50082-2, Electromagnetic Compatibility Generic Immunity Standard: IEC801-2, -3, -4, -5. (see also Tables 1 and 2)

This product is in conformity with Electromagnetic Compatibility Directive 89/336/EEC and Low Voltage Directive 73/23/EEC.

This conformity is indicated by the symbol CE , i.e. "Conformité Européenne".

Temperature:

Operating: 0°C to +50°C (+32°F to +122°F)

Storage: -10°C to +60°C (+14°F to +140°F)

Altitude:

Operating: 3 km (9850 feet)

Storage: 12 km (40 000 feet)

Safety Specifications

Meets requirements of:

EN61010-2-31 (IEC1010-2-31).

Compliant with:

UL3111-1 (including listing)

CSA C22.2 No.1010, 1-92 (including approval)

Max. Floating Output Voltage:

600V Category III, up to 400 Hz. (From shielding to ground.)

The DP120 conforms with the EEC directive 89/336 for EMC immunity, as defined by IEC801-3, with the addition of the following tables.

Table 1

Frequency range:	Susceptibility (in % of full dynamic range)	
	E = 3 V/m	E = 10 V/m
10 kHz to 25 MHz	<1%	<1%
20x	<1%	<1%
200x	<1%	<1%

Table 2

Frequency range:	Susceptibility (in % of full dynamic range)	
	E = 3 V/m	E = 10 V/m
25 MHz to 1 GHz	≤1%	≤2%
20x	≤1%	≤2%
200x	≤1%	≤2%

Servicing the DP120

For service information, contact your Fluke service center. To locate an authorized service center, visit us on the World Wide Web:

<http://www.fluke.com>

or call Fluke using any of the phone numbers listed below:

+1-888-993-5853 in U.S.A. and Canada

+31-402-678-200 in Europe

+1-425-356-5500 from other countries

Available power adapters:

Model	Description
PM8907/801	Universal Europe 230V, 50 Hz
PM8907/803	North America 120V, 60 Hz
PM8907/804	United Kingdom 240V, 50 Hz
PM8907/806	Japan 100V, 60 Hz
PM8907/807	Australia 240V, 50 Hz
PM8907/808	Universal 115V/230V

Note

The 230V rating of the PM8907/808 is not for use in North America. A line plug adapter complying with the applicable National Requirements may be provided to alter the blade configurations for a specific country.

Service sheet:

Ordering Number: 4822 872 05374