

ANTI-VANDAL SWITCHES
 DETECTOR SWITCHES
 DIP SWITCHES
 KEYLOCK SWITCHES
 NAVIGATION SWITCHES
 PUSHBUTTON SWITCHES
 ROCKER SWITCHES
 ROTARY SWITCHES
 SLIDE SWITCHES
 SNAP ACTION SWITCHES
 TACTILE SWITCHES
 TOGGLE SWITCHES
 CAP OPTIONS

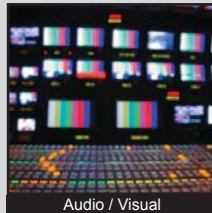

APPLICATIONS / MARKETS



Audio / Visual



Computer Peripherals

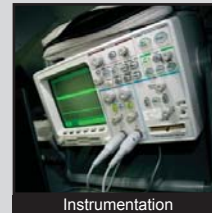

Instrumentation

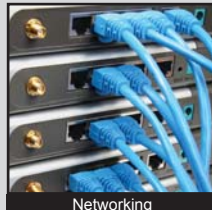

Networking



Telecommunication

RoHS

SPECIFICATIONS

Electrical Rating: 100mA, 20VDC
Life Expectancy: 50,000,000 Cycles
Contact Resistance: 150mΩ Max.
Insulation Resistance: 10MΩ Min. at 500VDC
Dielectric Strength: 500VAC for 1 Minute
Operating Temperature: -5°C to 60°C
Operating Force: 250gf ± 50gf
Total Travel: 3.3mm ± 0.3mm

Functions: SPST, Off-(On)

FEATURES & BENEFITS

- 50,000,000 cycle life expectancy
- Long 3.3mm travel
- Illumination options
- 2 cap sizes
- Price competitive

PART NUMBER CONFIGURATOR

Series	Function Style	Circuit	Cap Size	Cap Configuration	Cap Color	Diffuser Color	LED Color Options
LP16	OA	1 - SPST	A - 12.2mm Sq. B - 14.6mm Sq.	S - Sculptured	T - Transparent* R - Red G - Green B - Blue Y - Yellow	W - White R - Red G - Green B - Blue Y - Yellow T - Transparent**	N - No LED R - Red G - Green Y - Yellow B - Blue

* Always used when a diffuser color is defined
 ** Always used when a cap color is defined

Specifications subject to change without notice



E-SWITCH®



www.e-switch.com

800.867.2717

1

LP16 - "A" CAP SIZE

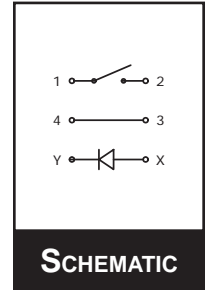
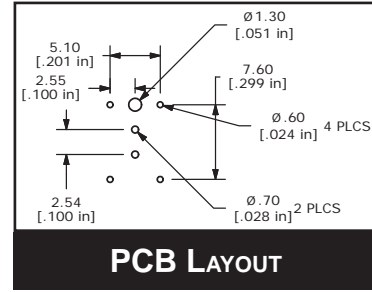
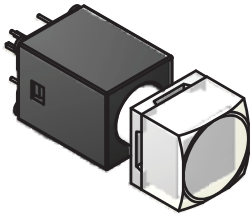

CLEAR CAP WITH WHITE DIFFUSER

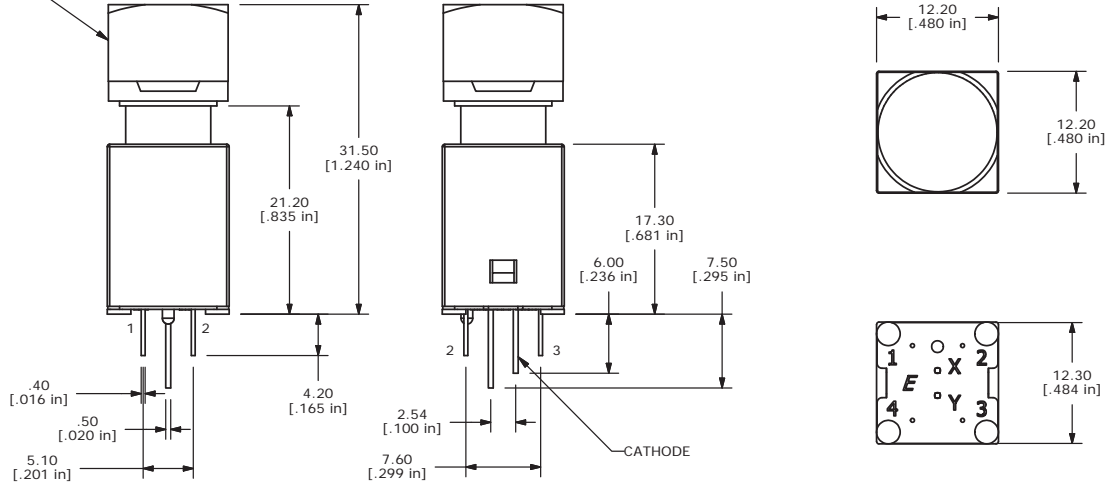

LP16 - "B" CAP SIZE

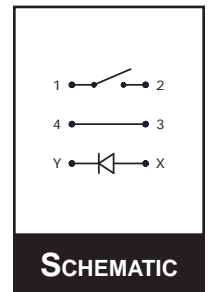
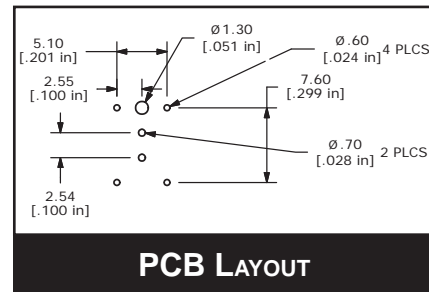
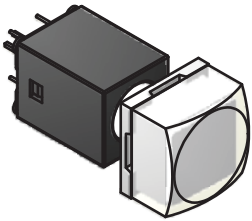

CLEAR CAP WITH WHITE DIFFUSER

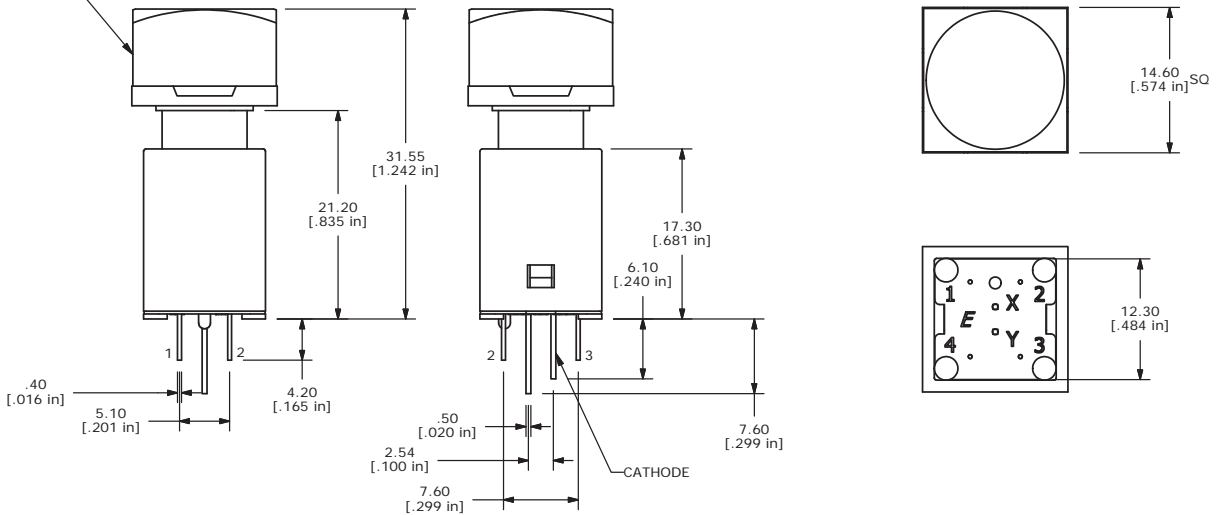

E-SWITCH®



www.e-switch.com

800.867.2717

2

ANTI-VANDAL SWITCHES
DETECTOR SWITCHES
DIP SWITCHES
KEYLOCK SWITCHES
NAVIGATION SWITCHES
PUSHBUTTON SWITCHES
ROCKER SWITCHES
ROTARY SWITCHES
SLIDE SWITCHES
SNAP ACTION SWITCHES
TACTILE SWITCHES
TOGGLE SWITCHES
CAP OPTIONS