

# POSISTOR® for Circuit Protection

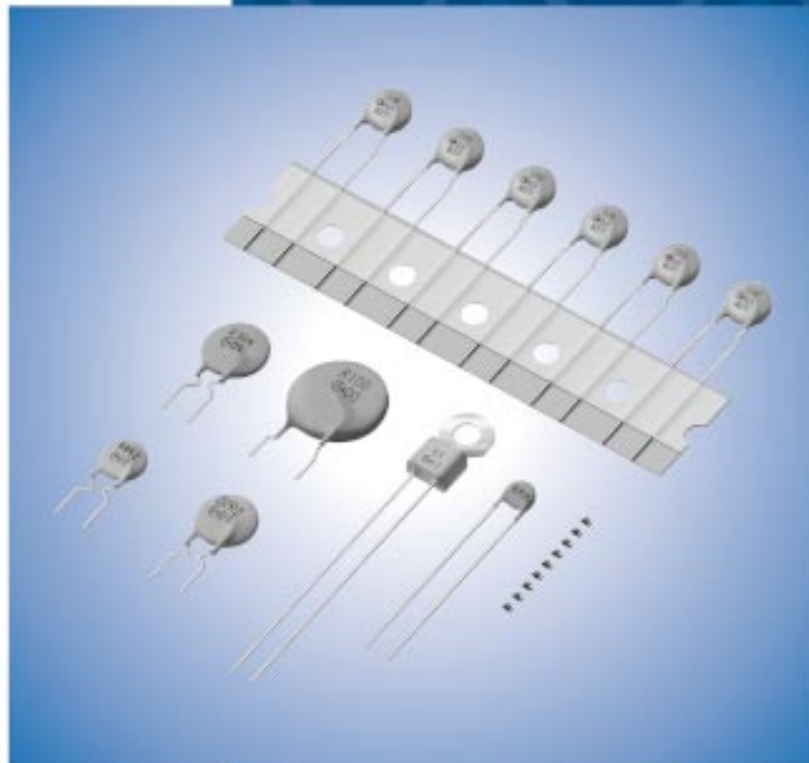

**muRata** *Innovator  
in Electronics*

Murata  
Manufacturing Co., Ltd.

Cat.No.R90E-9

# CONTENTS

POSISTOR® and "POSISTOR" in this catalog are the trademarks of Murata Manufacturing Co., Ltd.

<b>1</b>	<b>For Overcurrent Protection Chip Type</b>	12	<b>1</b>
●	Chip Type Specifications and Test Methods	17	<b>5</b>
<b>2</b>	<b>For Overcurrent Protection Narrow Current Band 30V Series</b>	19	<b>2</b>
<b>3</b>	<b>For Overcurrent Protection Narrow Current Band 51/60V Series</b>	22	<b>3</b>
<b>4</b>	<b>For Overcurrent Protection Narrow Current Band 140V Series</b>	27	<b>4</b>
<b>5</b>	<b>For Overcurrent Protection 24/30/32V Series</b>	30	<b>7</b>
<b>6</b>	<b>For Overcurrent Protection 56/80V Series</b>	37	<b>8</b>
<b>7</b>	<b>For Overcurrent Protection 125/140V Series</b>	43	<b>8</b>
<b>8</b>	<b>For Overcurrent Protection 250/265V Series</b>	50	<b>9</b>
	<b>PTGL Series Narrow Current Band Specifications and Test Methods</b>	58	<b>9</b>
	<b>PTGL Series Specifications and Test Methods</b>	60	<b>10</b>
<b>9</b>	<b>For Overheat Sensing Chip Type</b>	61	<b>10</b>
<b>10</b>	<b>For Overheat Sensing Chip Type Tight-tolerance Type</b>	62	<b>11</b>
	<b>For Overheat Sensing Chip Type (Reference Data)</b>	63	<b>11</b>
	<b>Chip Type (Ref. Only)</b>	64	
	<b>Chip Tight Tolerance Type (Ref. Only)</b>	66	
	<b>Chip Type Specifications and Test Methods (PRF15 Series)</b>	67	
	<b>Chip Type Specifications and Test Methods (PRF18/21 Series)</b>	68	
	<b>Chip Tight Tolerance Type Specifications and Test Methods</b>	69	
<b>11</b>	<b>For Overheat Sensing Lead Type</b>	70	
●	For Temperature Sensor Lead Type Specifications and Test Methods	74	
	<b>⚠Caution/Notice</b>	75	
	<b>PRG/PRF Series Package</b>	79	
	<b>Lead Type PTGL Series Package</b>	80	

## ● Part Numbering

### PTC Thermistors (POSISTOR®) for Circuit Protection

(Part Number) 

PR	G	18	BB	470	M	B1	RB
①	②	③	④	⑤	⑥	⑦	⑧

#### ① Product ID

Product ID	
<b>PR</b>	PTC Thermistors Chip Type

#### ② Series

Code	Series
<b>G</b>	for Overcurrent Protection

#### ③ Dimensions (L×W)

Code	Dimensions (L×W)
<b>18</b>	1.60×0.80mm
<b>21</b>	2.00×1.25mm

#### ④ Temperature Characteristics

Code	Temperature Characteristics
<b>BB</b>	Curie Point 100°C
<b>BC</b>	Curie Point 90°C

#### ⑤ Resistance

Expressed by three-digit alphanumerics. The unit is ohm ( $\Omega$ ). The first and second figures are significant digits, and the third figure expresses the number of zeros which follow the two figures. If there is a decimal point, it is expressed by the capital letter "R". In this case, all figures are significant digits.

Ex.)

Code	Resistance
<b>470</b>	47 $\Omega$
<b>471</b>	470 $\Omega$

#### ⑥ Resistance Tolerance

Code	Resistance Tolerance
<b>M</b>	±20%
<b>Q</b>	Special Tolerance

#### ⑦ Individual Specifications

Code	Individual Specifications
<b>B1</b>	Structure, others

#### ⑧ Packaging

Code	Packaging
<b>RA</b>	Embossed Taping (4mm Pitch) (4000 pcs.)
<b>RB</b>	Paper Taping (4mm Pitch) (4000 pcs.)
<b>RK</b>	Embossed Taping (4mm Pitch) (3000 pcs.)

### PTC Thermistors (POSISTOR®) for Overheat Sensing Chip Type

(Part Number) 

PR	F	18	BB	471	Q	B1	RB
①	②	③	④	⑤	⑥	⑦	⑧

#### ① Product ID

Product ID	
<b>PR</b>	PTC Thermistors Chip Type

#### ② Series

Code	Series
<b>F</b>	for Overheat Sensing

#### ③ Dimensions (L×W)

Code	Dimensions (L×W)
<b>15</b>	1.00×0.50mm
<b>18</b>	1.60×0.80mm
<b>21</b>	2.00×1.25mm

#### ④ Temperature Characteristics

Code	Temperature Characteristics
<b>AR</b>	Curie Point 120°C
<b>AS</b>	Curie Point 130°C
<b>BA</b>	Curie Point 110°C
<b>BB</b>	Curie Point 100°C
<b>BC</b>	Curie Point 90°C
<b>BD</b>	Curie Point 80°C
<b>BE</b>	Curie Point 70°C
<b>BF</b>	Curie Point 60°C
<b>BG</b>	Curie Point 50°C

#### ⑤ Resistance

Expressed by three figures. The unit is ohm ( $\Omega$ ). The first and second figures are significant digits, and the third figure expresses the number of zeros which follow the two figures.

Ex.)

Code	Resistance
<b>471</b>	470 $\Omega$

#### ⑥ Resistance Tolerance

Code	Resistance Tolerance	Sensing Temp. Tolerance
<b>Q</b>	Special Tolerance	±5°C
<b>R</b>	Special Tolerance	±3°C

#### ⑦ Individual Specifications

Code	Individual Specifications
<b>B1</b>	Structure, others

#### ⑧ Packaging

Code	Packaging
<b>RA</b>	Embossed Taping (4mm Pitch) (4000 pcs.)
<b>RB</b>	Paper Taping (4mm Pitch) (4000 pcs.)
<b>RC</b>	Paper Taping (2mm Pitch) (10000 pcs.)

## PTC Thermistors (POSISTOR®) for Circuit Protection / for Overheat Sensing Lead Type

(Part Number)

<b>PT</b>	<b>GL</b>	<b>07</b>	<b>AR</b>	<b>220</b>	<b>M</b>	<b>3P51</b>	<b>A0</b>
①	②	③	④	⑤	⑥	⑦	⑧

### ① Product ID

Product ID	
<b>PT</b>	PTC Thermistors

### ② Series

Code	Series
<b>FL</b>	for Overheat Sensing Lead Type
<b>FM</b>	for Overheat Sensing with Lug-terminal
<b>GL</b>	for Circuit Protection Lead Type

### ③ Dimensions

Code	Dimensions
<b>04</b>	Nominal Body Diameter 4mm Series
<b>05</b>	Nominal Body Diameter 5mm Series
<b>07</b>	Nominal Body Diameter 7mm Series
<b>09</b>	Nominal Body Diameter 9mm Series
<b>10</b>	Nominal Body Diameter 10mm Series
<b>12</b>	Nominal Body Diameter 12mm Series
<b>13</b>	Nominal Body Diameter 13mm Series
<b>14</b>	Nominal Body Diameter 14mm Series
<b>16</b>	Nominal Body Diameter 16mm Series
<b>18</b>	Nominal Body Diameter 18mm Series

### ④ Temperature Characteristics

Code	Temperature Characteristics
<b>AS</b>	Curie Point 130°C
<b>AR</b>	Curie Point 120°C
<b>BA</b>	Curie Point 110°C
<b>BB</b>	Curie Point 100°C
<b>BC</b>	Curie Point 90°C
<b>BD</b>	Curie Point 80°C
<b>BE</b>	Curie Point 70°C
<b>BF</b>	Curie Point 60°C
<b>BG</b>	Curie Point 50°C
<b>BH</b>	Curie Point 40°C

### ⑤ Resistance

Expressed by three-digit alphanumerics. The unit is ohm ( $\Omega$ ). The first and second figures are significant digits, and the third figure expresses the number of zeros which follow the two figures. If there is a decimal point, it is expressed by the capital letter "R". In this case, all figures are significant digits.

Ex.)

Code	Resistance
<b>R22</b>	0.22 $\Omega$
<b>2R2</b>	2.2 $\Omega$
<b>220</b>	22 $\Omega$

### ⑥ Resistance Tolerance

Code	Resistance Tolerance
<b>H</b>	$\pm 25\%$
<b>K</b>	$\pm 10\%$
<b>M</b>	$\pm 20\%$
<b>N</b>	$\pm 30\%$
<b>Q</b>	Special Tolerance

### ⑦ Individual Specifications

Code	Individual Specifications
<b>3P51</b>	Lead Type, others

### ⑧ Packaging

Code	Packaging
<b>A0</b>	Ammo Pack
<b>B0</b>	Bulk

# Basic Characteristics of POSISTOR®

## Basic Characteristics

POSISTOR® has three main characteristics.

### 1. Resistance - Temperature Characteristics

Although there is a negligible difference between the normal and "Curie Point" temperature, POSISTOR® shows almost constant resistance-temperature characteristics. Yet they have resistance-temperature characteristics that cause resistance to sharply increase when the temperature exceeds the Curie Point. The Curie Point (C.P.) is defined as temperature which the resistance value is twice the one at 25 °C.

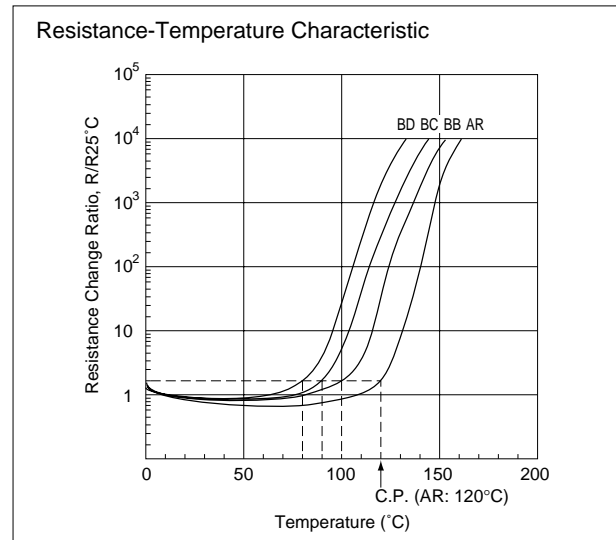

### 2. Current - Voltage Characteristics (Static Characteristic)

This shows the relation between applied voltage when voltage applied to POSISTOR® causes balancing of inner heating and outer thermal dissipation and stabilized current. This has both a maximum point of current and constant output power.

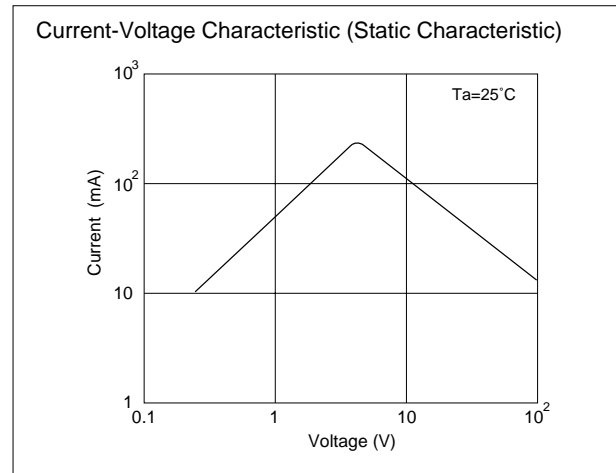

### 3. Current - Time Characteristics (Dynamic Characteristic)

This shows the relation between current and time before inner heating and outer thermal dissipation arrive at equilibrium state. This features having large initial current and abruptly continuous attenuating portion.

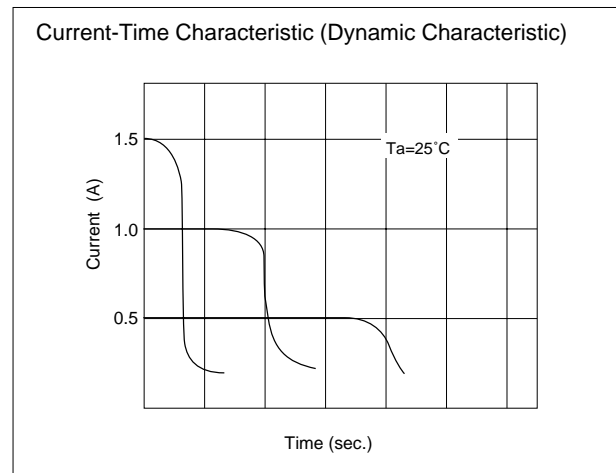

## Basic Characteristics of POSISTOR®

### Technical Terms

#### 1. Protective Threshold Current

The maximum current value is called the "Protective Threshold Current" for Voltage vs. Current characteristics (static).

When smaller than the protective threshold current flows in POSISTOR®, it reaches its stability (as shown in figure on right) at the intersection (A) of the load curve (a) and voltage-current characteristics of POSISTOR®(c). And POSISTOR® works as normal fixed resistor.

However, when larger than protective threshold current flows, it stabilizes at the intersection (B) with the load curve (b).

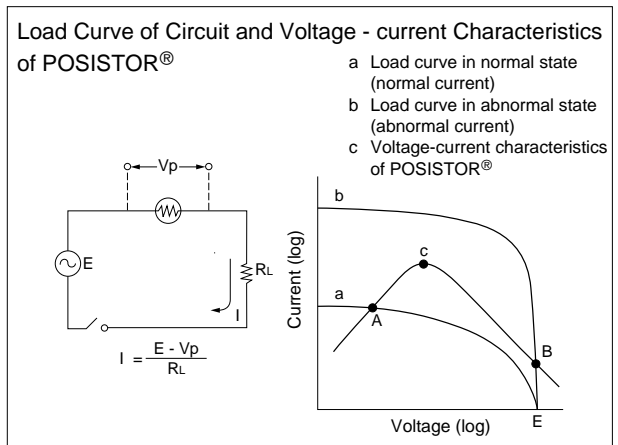

#### 2. Protective Threshold Current Range

Protective threshold current varies depending on the ambient temperature, resistance value, temperature characteristics and shape (Figure of right) The maximum value of trip current and the minimum value of the non-operating current are in the range of ambient temperature -10 to +60°C.

That is, when a current is smaller than the non-operating current, POSISTOR® works only as a fixed resistor. When larger than the trip current flows, however, POSISTOR® protects the circuit from overload.

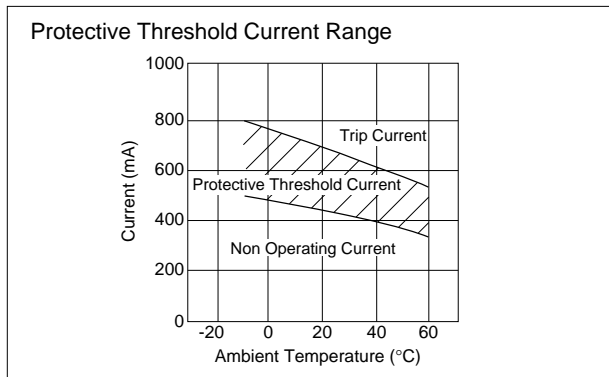

#### 3. Operating Time

A period starting from the voltage input to the moment current itself sharply attenuates is called "Operating Time". Conventionally, operation time ( $t_o$ ) is determined to be the period until inrush current ( $I_o$ ) decreases to a level one half the original inrush current ( $I_o/2$ ).

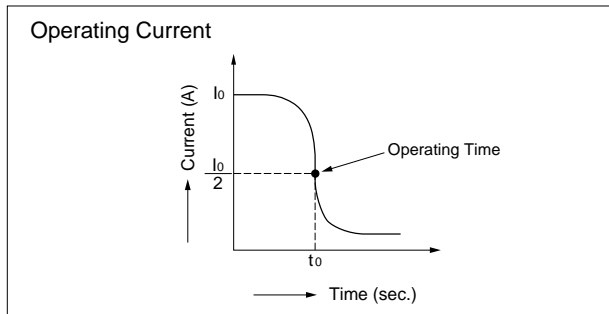

## Selection Guide

Please confirm the parameters according to the following questions.  
 The best selection is the product that is satisfied with three parameters.

● Confirmation Items

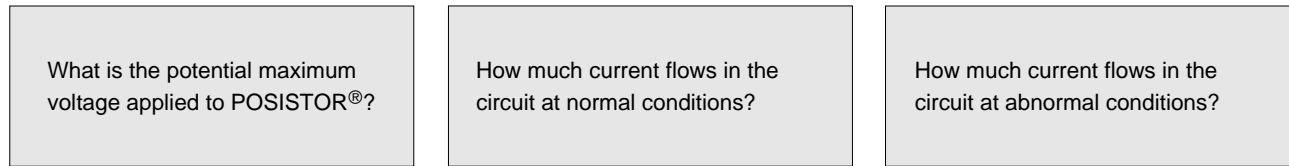

● Example

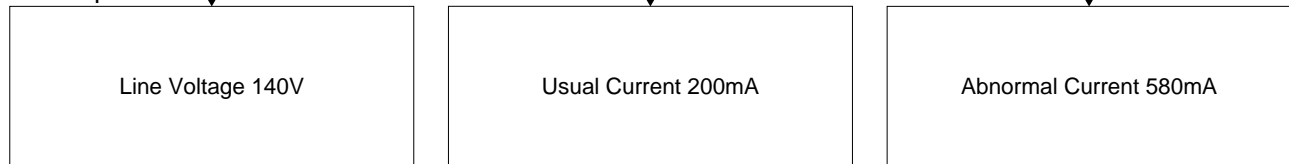

● Selection Standards

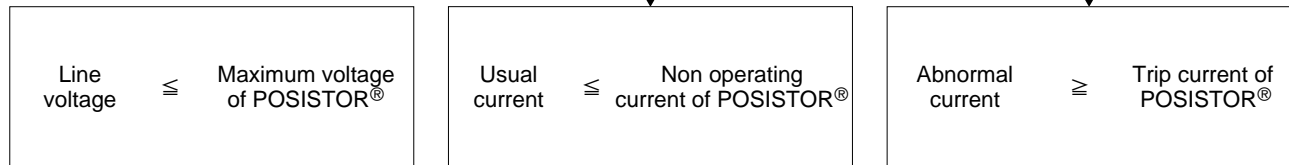

Part Number	Max. Voltage (V)	Non-operating Current at +60°C (mA)	Trip Current at -10°C (mA)	Max. Current (A)	Resistance (at 25°C) (ohm)	Body Diameter (D) (mm)	Thick (T) (mm)
PTGL18AR4R7M6B72B0	125	360	900	1.7	4.7 ±20%	18.5	5.5
PTGL18AR3R3M6B72B0	125	420	1050	2.0	3.3 ±20%	18.5	5.5
PTGL07AR330M6A51B0	140	100	230	0.5	33 ±20%	7.4	6.0
PTGL09AR220M6C61B0	140	140	330	1.0	22 ±20%	9.6	6
PTGL10AR150M6C61B0	140	170	400	1.0	15 ±20%	11.6	
→ PTGL12AR100M6C01B0	140	220	510	1.0	10 ±20%	13.0	
PTGL13AR6R8M6C01B0	140	290	670	1.0	6.8 ±20%	14.0	
PTGL16AR5R6M6C01B0	140	340	780	2.0	5.6 ±20%	17.0	

PTGL12AR100M6C01B0 is the best selection in this case.

## Application Matrix

Application \ Series	Over Current Protection		Overheat Sensing	
	PTGL Series	PRG Series	PTFL Series PTFM Series	PRF Series
Color TV	●	●	●	●
CRT Display	●	●		
VCR	●	●	●	●
Audio	●	●	●	●
Speaker	●			
Refrigerator	●	●	●	●
Vacuum Cleaner	●	●		
Air Conditioner	●	●		●
FAX	●	●	●	●
Personal Computer	●	●		●
USB HUB	●	●		
PDA		●		●
Lighting Equipment	●	●	●	●
STB	●	●	●	●
DSL	●	●	●	●
Exchanger	●	●		
Transceiver	●	●	●	●
Security System	●	●	●	●
Vending Machine	●	●	●	●
Automobile	●	●	●	●
Car Audio	●	●	●	●
Car Navigation	●	●	●	●
Small DC Motor	●	●	●	●
Fan Motor	●	●	●	●
Battery Pack		●		●
Power Supply	●	●	●	●
AC Adaptor	●		●	●
Small Transformer	●	●	●	●



# Application Notes

## ■ Inrush Current Limit for Power Supply

POSISTOR® Lead type: PTGL series

### 1. Applications

POSISTOR® is an integrated solution to work as both current limit resistor and over current fuse. It works as a stable resistor in normal operation and protects itself against over current situation.

- (1) High wattage power supply (Flat display panels etc.)
- (2) Power supply for fluorescent lights
- (3) Other switching power supplies

Replacement idea from a resistor and fuse solution

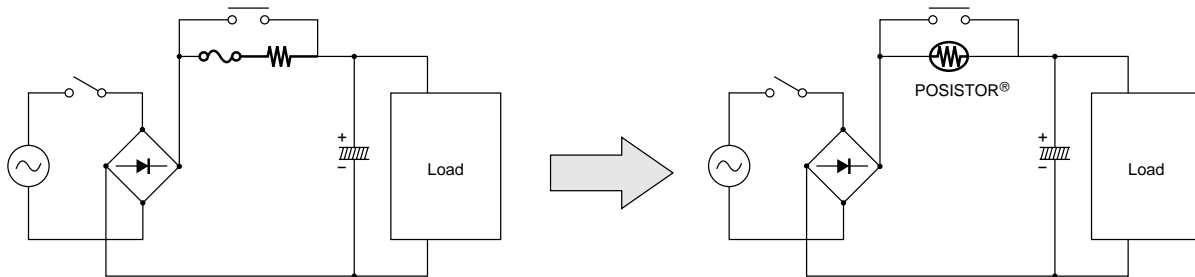

### 2. Benefits

- (1) Protection against over current situation
- (2) Automatic reset from protective trip mode
- (3) Space-saving
- (4) Various characteristics to meet a suitable resistance value

### 3. Recommended part numbers

Choose an appropriate part number based on the resistance value required to the inrush current limit. Review the maximum voltage.

Application	Part Number	Max. Voltage (V)	Resistance (at 25 °C) (ohm)	Body Diameter (mm)	Thickness (mm)	Lead Space (mm)	Lead Diameter (mm)	More Details
For high wattage power supply	<b>PTGL13AR100H8B72B0</b>	265	10 ±25%	14.0	6.0	7.5	0.60	page 51
	<b>PTGL12AR150H8B72B0</b>		15 ±25%	12.5	6.0	7.5	0.60	page 51
	<b>PTGL14AR180M9C01B0</b>		18 ±20%	15.7	6.5	10.0	0.65	page 51
	<b>PTGL09AR250H8B52B0</b>		25 ±25%	10.0	6.0	5.0	0.60	page 51
	<b>PTGL09AR390M9C61B0</b>		39 ±20%	10.0	6.5	6.5	0.65	page 50
For power supply of electronic fluorescent ballasts	<b>PTGL07AR560M9B51A0</b>		56 ±20%	8.2	6.5	5.0	0.60	-
	<b>PTGL07AR820M9B51A0</b>		82 ±20%	8.2	6.5	5.0	0.60	-
	<b>PTGL07AS121M0N51A0</b>		120 ±20%	6.5	6.5	5.0	0.50	-
	<b>PTGL07AS181M0N51A0</b>		180 ±20%	6.5	6.5	5.0	0.50	-

Please ask for details.

# Application Notes

## ■ Over Current Protection for Communication Facility

POSISTOR® Lead type: PTGL series

### 1. Applications

POSISTOR® is an efficient device to protect a telephone line interface (SLIC: Subscriber-Loop-Interface-Circuit) against AC line contact.

- (1) Landline telephones or FAX machines
- (2) Telephone interface of STB, VoIP equipment
- (3) Any other equipment of communication facility having a phone line interface

Replacement idea from a current fuse.

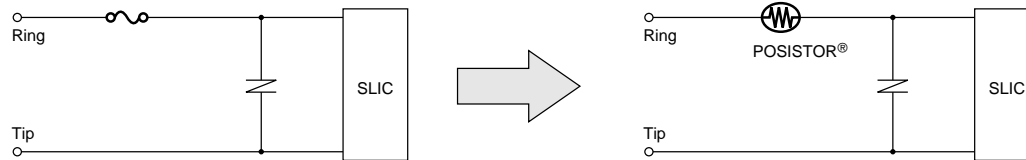

### 2. Benefits

- (1) Automatic reset from protective trip up to 265V AC line contact
- (2) Compatible with the 600V over voltage test by UL60950
- (3) High resistance to the lightning surge (\*A surge absorber is still required to protect SLIC)

### 3. Recommended part numbers

Choose an appropriate part number based on the non-operating current and on the resistance value required to the operation current of SLIC.

Part Numbers	Max. Voltage (V)	Max. Current (A)	Non-Operating Current (at +60 °C) (mA)	Trip-Current (at -10 °C) (mA)	Resistance (at 25 °C) (ohm)	Body Diameter (mm)	Thickness (mm)	Lead Space (mm)	Lead Diameter (mm)	More Details
<b>PTGL07BB220N0B52A0</b>	250	0.5	90	300	22 ±30%	8.0	6.0	5.0	0.6	page 50
<b>PTGL09AR390N0B52A0</b>	250	0.6	100	280	39 ±30%	10.0	6.0	5.0	0.6	page 50
<b>PTGL09AR250H8B52B0</b>	265	1.0	118	330	25 ±25%	10.0	6.0	5.0	0.6	page 51

Please ask for details.

# Application Notes

## ■ Current Limiter for LED

Chip POSISTOR®: PRG series

### 1. Applications

POSISTOR® is an effective current limit solution based on LED's allowable current and temperature characteristic.

- (1) LED lighting instruments
- (2) LED backlight of flat displays

See below figures.

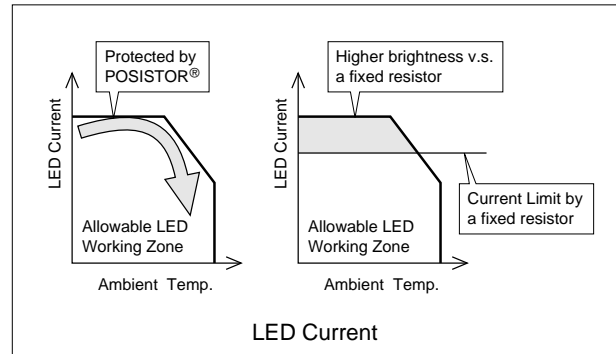
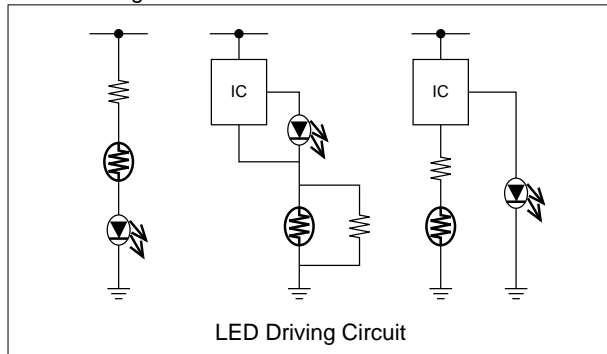

### 2. Benefits

- (1) Higher LED brightness versus a fixed resistor. LED can work in the smaller series resistance with POSISTOR® at normal operation temperature. The number of LED is possibly reduced.
- (2) LED lifetime may be extended due to the current limiting function of the POSISTOR® in cases of overheat or over current situation.
- (3) Small 0805 package allows the POSISTOR® to be placed close to the LED. It offers accurate detection of ambient temperature near LED and increases flexibility of packaging.

### 3. Recommended part numbers

Choose an appropriate part number having max. voltage and resistance value. Review the protective threshold current range based on the operating current and temperature of the LED.

Part number series	Max. Voltage (V)	Max. Current (A)	Non-Operating Current (at +60 °C) (mA)	Trip-Current (at -10 °C) (mA)	Resistance (at 25 °C) (ohm)	Curie Point (°C) *	More Details
PRG21BC0R2MM1RA	6	10	500	2000	0.2 ±20%	90	page 12
PRG21BC6R8MM1RA	20	3.5	80	320	6.8 ±20%	90	page 12
PRG21BC4R7MM1RA	20	5.0	100	400	4.7 ±20%	90	page 12

\*Curie Point means the temperature when the resistance value reaches twice the resistance at 25 °C. Please ask for details.

## Application Notes

### Overheat/Over Current Protection for High Brightness LED

Leaded POSISTOR®: PTGL series & Chip POSISTOR®: PRG series

#### 1. Applications

POSISTOR® is an effective solution to protect the LED against overheat and over current situation.

(1) LED lighting instruments (Appliances, Automotive etc.)

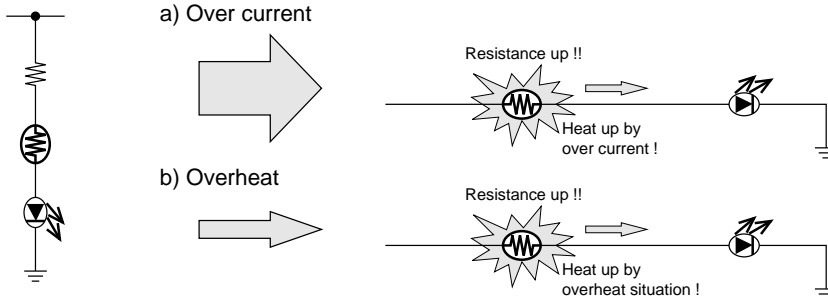

#### 2. Benefits

- (1) Posistor installed in series with LED provides both overheat and over current protection
- (2) No additional driver IC or software required

- (3) Automatic reset from protective trip mode
- (4) 0603 and 0805 SMD type available (smaller than 1/2W or 1W chip resistor)

#### 3. Recommended part numbers

Choose an appropriate part number having max. voltage and resistance value. Review the protective threshold

current range based on the operating current and temperature of the LED.

Type	Part Number Series	Max. Voltage (V)	Max. Current (A)	Non-Operating Current (at +60 °C) (mA)	Trip-Current (at -10 °C) (mA)	Resistance (at 25 °C) (ohm)	Curie Point (°C) *	More Details
SMD type	PRG21BC0R2MM1RA	6	10	500	2000	0.2 ±20%	90	page 12
	PRG21BC6R8MM1RA	20	3.5	80	320	6.8 ±20%	90	page 12
	PRG21BC4R7MM1RA	20	5.0	100	400	4.7 ±20%	90	page 12
	PRG18BB471MB1RB	24	0.06	7	25	470 ±20%	100	page 12
	PRG18BB221MB1RB	24	0.13	10	35	220 ±20%	100	page 12
	PRG18BB101MB1RB	24	0.3	15	55	100 ±20%	100	page 12
	PRG18BB470MB1RB	24	0.63	20	75	47 ±20%	100	page 12
	PRG18BB330MB1RB	24	0.9	25	85	33 ±20%	100	page 12
Lead type	PTGL04AS100K2N51B0	30	1.5	122	240	10 ±10%	130	page 19
	PTGL04AS100K2B51B0	30	2.0	167	330	10 ±10%	130	page 19
	PTGL05AS3R9K2B51B0	30	3.5	269	530	3.9 ±10%	130	page 19
	PTGL07AS2R7K2B51B0	30	4.5	336	663	2.7 ±10%	130	page 19
	PTGL07AS1R8K2B51B0	30	5.0	420	829	1.8 ±10%	130	page 19
	PTGL09AS1R2K2B51B0	30	6.0	556	1097	1.2 ±10%	130	page 19
	PTGL12AS0R8K2B51B0	30	7.0	685	1352	0.8 ±10%	130	page 19
	PTGL04AS100K3B51B0	51	1.0	168	332	10 ±10%	130	page 22
	PTGL05AS6R8K3B51B0	51	1.5	197	388	6.8 ±10%	130	page 22
	PTGL07AS3R3K3B51B0	51	3.0	307	606	3.3 ±10%	130	page 22
	PTGL09AS2R2K3B51B0	51	4.0	412	814	2.2 ±10%	130	page 22
	PTGL12AS1R2K3B51B0	51	5.0	592	1168	1.2 ±10%	130	page 22
	PTGL07AR220M3P51B0	56	1.0	90	240	22 ±20%	120	page 37
	PTGL07AR8R2M3P51B0	56	1.0	130	350	8.2 ±20%	120	page 37
	PTGL09AR150M3B51B0	56	1.2	150	400	15 ±20%	120	page 37
	PTGL10AR3R9M3P51B0	56	2.0	210	550	3.9 ±20%	120	page 37
	PTGL09AR4R7M3B51B0	56	2.0	270	700	4.7 ±20%	120	page 37
	PTGL10AR3R9M3B51B0	56	2.0	300	800	3.9 ±20%	120	page 37
	PTGL14AR3R3M3B71B0	56	2.5	380	980	3.3 ±20%	120	page 37

\* Curie Point means the temperature when the resistance value reaches twice the resistance at 25 °C. Please ask for details.

# POSISTOR<sup>®</sup> for Circuit Protection



## For Overcurrent Protection Chip Type

Overcurrent Protection device with resettable function suitable for current limiting resistor.

This product is chip type PTC thermistor for overcurrent protection which is suitable for the following:

- Countermeasure for short circuit testing
- Current limiting resistor

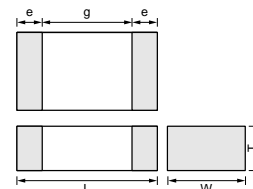

Part Number	Dimensions (mm)				
	L	W	T	e	g
<b>PRG18_RB</b>	1.6±0.15	0.8±0.15	0.8±0.15	0.1 to 0.6	-
<b>PRG21_RA</b>	2.0±0.2	1.25±0.2	0.9±0.2	0.2 min.	0.5 min.
<b>PRG21_RK</b>	2.0±0.2	1.25±0.2	1.25±0.2	0.2 min.	0.5 min.

### ■ Features

1. Rapid operation to protect the circuit in an overcurrent condition abnormality such as a short circuit.  
By removing the overcurrent condition, these products automatically return to the initial condition and can be used repeatedly.
2. Suitable for countermeasure to short circuit test in safety standard
3. Stable resistance after operation due to ceramic PTC
4. Similar size (0603 size) is possible due to the large capacity for electric power.
5. Possible to use these products as current limiting resistors with overcurrent protection functions
6. SMD type is helpful for miniaturizing circuits because of its small size and light weight
7. Lead is not contained in the terminations

Part Number	Max. Voltage (V)	Non-operating Current (at +60°C)(mA)	Trip Current (at -10°C) (mA)	Max. Current (mA)	Resistance (at 25°C) (ohm)
<b>PRG18BB471MB1RB</b>	24	7	25	60	470 ±20%
<b>PRG18BB221MB1RB</b>	24	10	35	130	220 ±20%
<b>PRG18BB101MB1RB</b>	24	15	55	300	100 ±20%
<b>PRG18BB470MB1RB</b>	24	20	75	630	47 ±20%
<b>PRG18BB330MB1RB</b>	24	25	85	900	33 ±20%
<b>PRG21BB220MB1RK</b>	20	30	110	1100	22 ±20%
<b>PRG21BB150MB1RK</b>	20	40	140	1600	15 ±20%
<b>PRG21BC6R8MM1RA</b>	20	80	320	3500	6.8 ±20%
<b>PRG21BC4R7MM1RA</b>	20	100	400	5000	4.7 ±20%
<b>PRG21BC0R2MM1RA</b>	6	500	2000	10000	0.2 ±20%

Please contact us for UL recognized products.

## Standard Land Pattern Dimensions

1

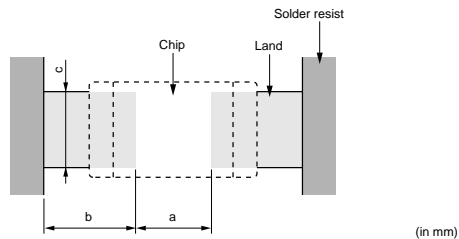

Part Number	Soldering Methods	Dimensions (mm)			
		Chip (L×W)	a	b	c
<b>PRG18</b>	Reflow Soldering	1.6×0.8	0.6-0.8	0.6-0.7	0.6-0.8
<b>PRG21</b>	Reflow Soldering	2.0×1.25	1.0-1.2	0.5-0.7	1.0-1.2

## Protective Threshold Current Range

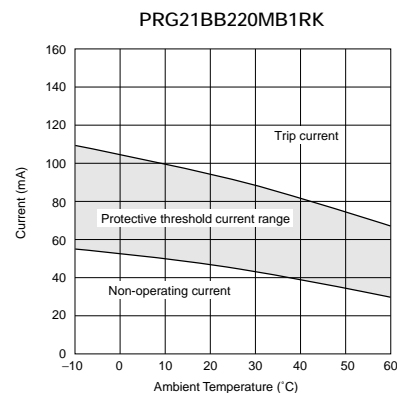
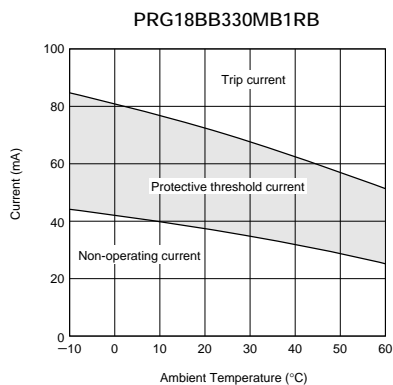
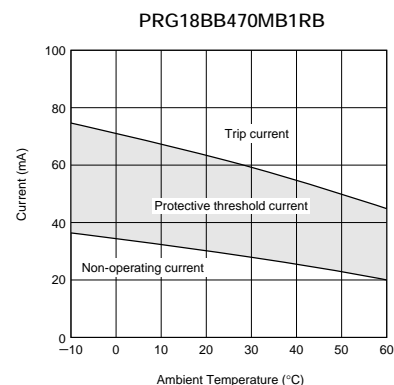
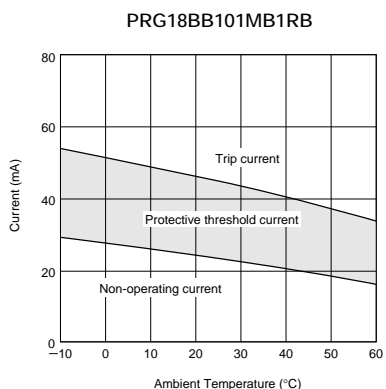
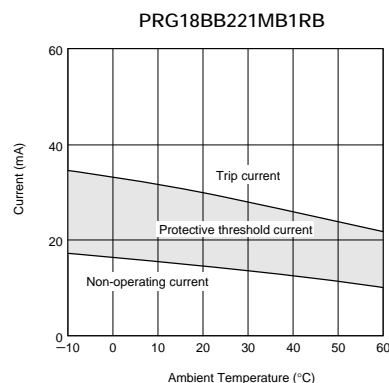
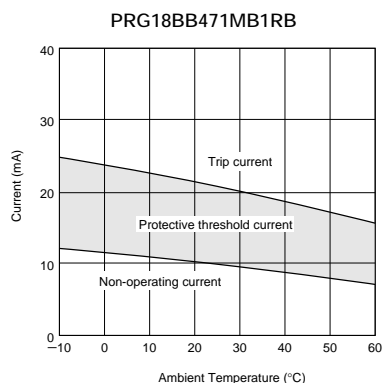

Continued on the following page.

Continued from the preceding page.

1

■ Protective Threshold Current Range

PRG21BB150MB1RK

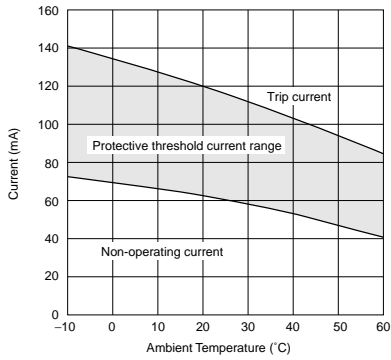

PRG21BC6R8MM1RA

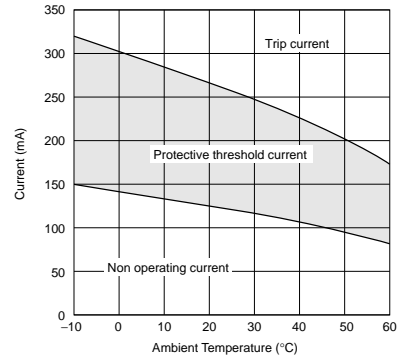

PRG21BC4R7MM1RA

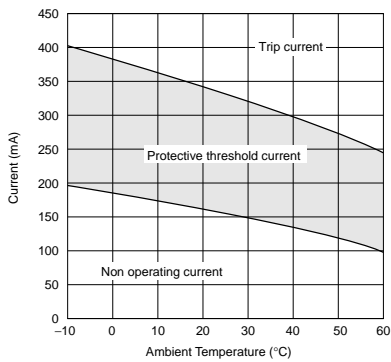

PRG21BC0R2MM1RA

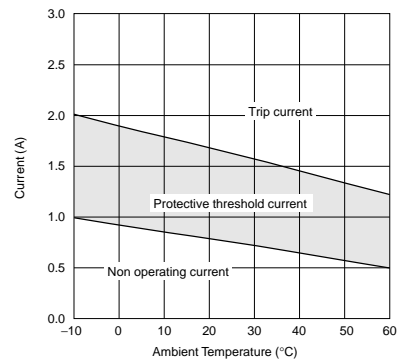

■ Operating Time (Typical Curve)

PRG18BB471MB1RB

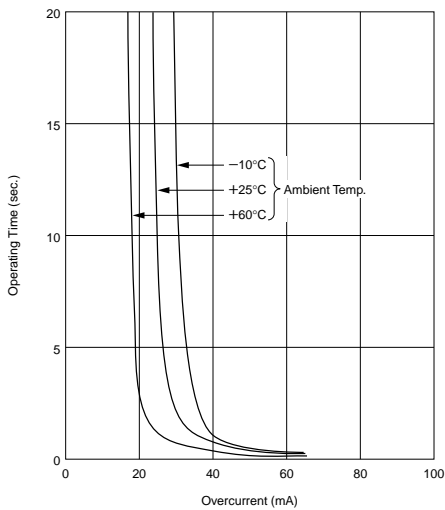

PRG18BB221MB1RB

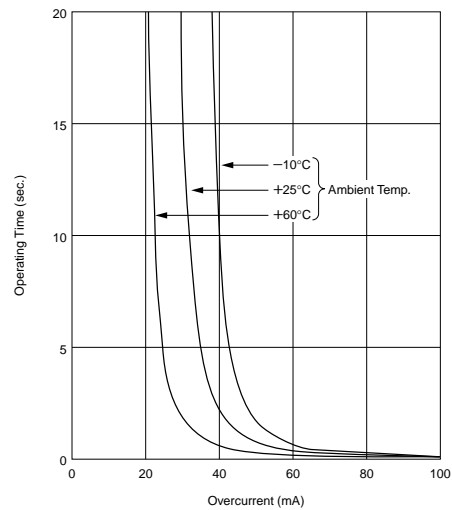

Continued on the following page. ↗

Continued from the preceding page.

■ Operating Time (Typical Curve)

1

PRG18BB101MB1RB

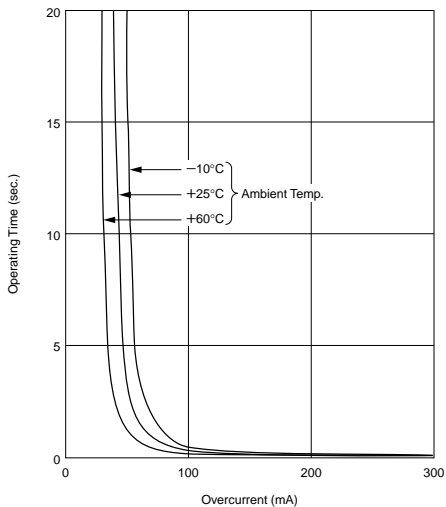

PRG18BB470MB1RB

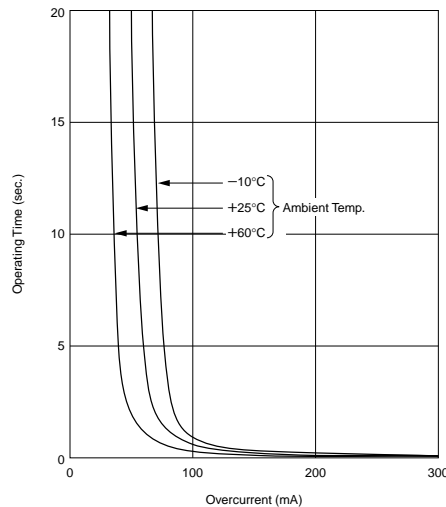

PRG18BB330MB1RB

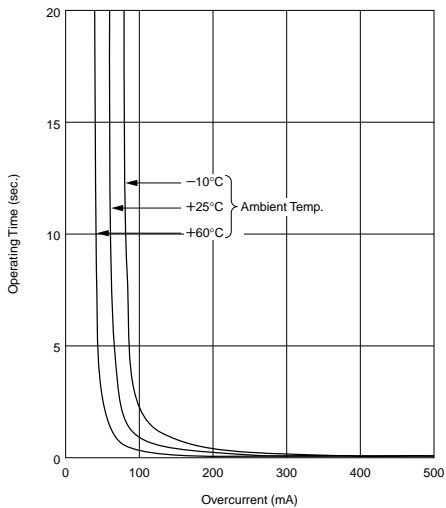

PRG21BB220MB1RK

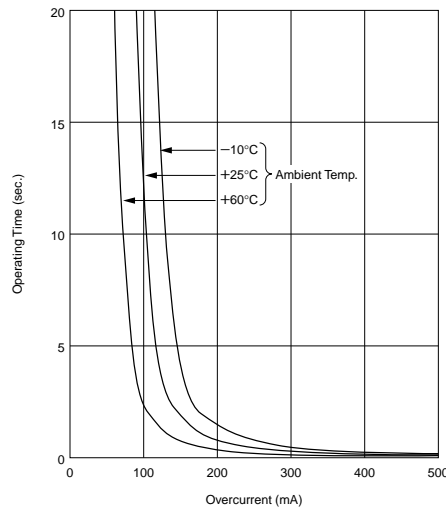

PRG21BB150MB1RK

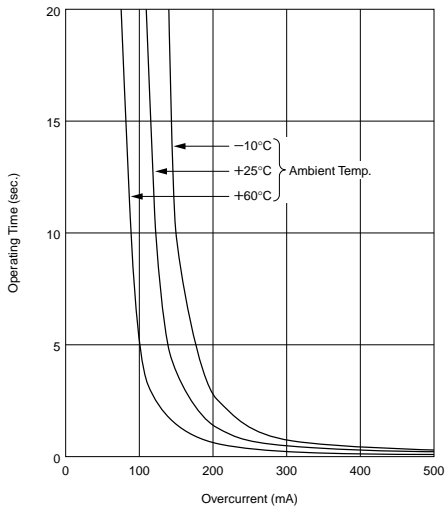

PRG21BC6R8MM1RA

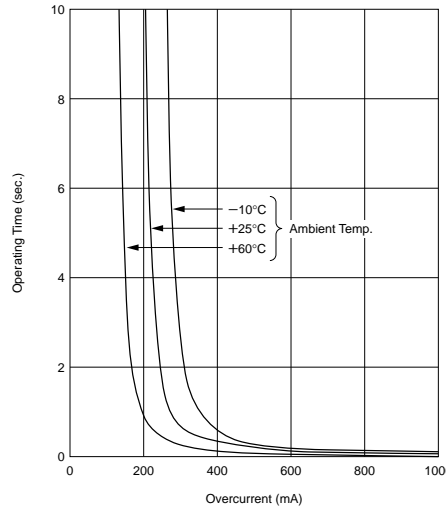

Continued on the following page. ↗



Continued from the preceding page.

1

■ Operating Time (Typical Curve)

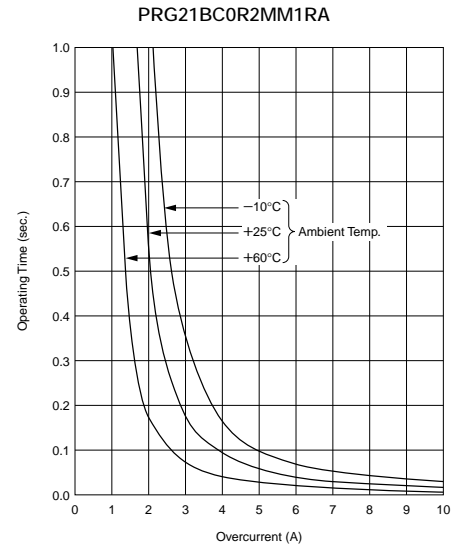
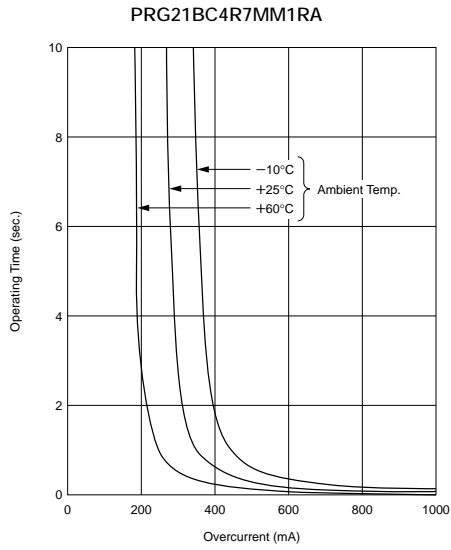

## Chip Type Specifications and Test Methods

1

### ■ PRG18/21BB Series

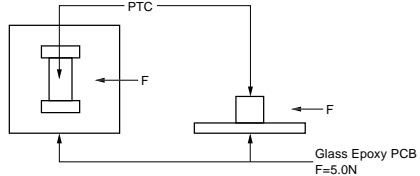
No.	Item	Rating Value	Method of Examination															
1	Operating Temp.	-10 to 60°C	Temperature range with maximum voltage applied to PTC.															
2	Resistance Value (at 25°C)	The resistance value should be within the specified tolerance.	After applying maximum operating voltage for 3 mins. and leaving for 2 hrs. in 25°C, measured by applying voltage of less than 1.5Vdc (by a direct current of less than 10mA).															
3	Withstanding Voltage	Without damage	We apply 120% of the maximum operating voltage to PTC by raising gradually for 180±5 secs. at 25°C. (A protective resistor is to be connected in series, and the inrush current through PTC must be limited below maximum rated value.)															
4	Adhesive Strength	There is no exfoliation sign of electrode.	EIAJ ET-7403 term 9 Soldered PTC to PCB and add the force of 5.0N in the direction as shown below. 															
5	Vibration	Normal appearance Resistance change: not to exceed ±20% (*)	JIS C 5102 term 8.2 Soldered PTC to PCB Vibration: A 10-55-10Hz (1 min.) Width: 1.5mm Vibrate for 2 hrs. in each of 3 mutually perpendicular planes for a total of 6 hrs.															
6	Solderability	Min. 75% electrode is covered with new solder. Resistance change: not to exceed ±20% (*)	JIS C 5102 term 8.4 Solder: Sn 63%/Pb 37% (or 60/40%) Solder temp: 230±5°C Soaking time: 3±0.5 s. Soaking position: Until a whole electrode is soaked															
7	Solder-heatability	Normal appearance Resistance change: not to exceed ±20% (*)	Solder: Sn 63%/Pb 37% (or 60/40%) Flux: Solder paste containing less than 0.2wt% of chlorine. Preheating: 150±5°C 3mins. Peak temp.: 260±5°C 10±5 s. (reflow) PCB: Glass Epoxy PCB (JIS C 6484)															
8	Temperature Cycling	Normal appearance Resistance change: not to exceed ±20% (*)	JIS C 5102 term 9.3 Times: 5 cycles <table border="1" data-bbox="943 1249 1300 1367"> <thead> <tr> <th>Step</th> <th>Temp. (°C)</th> <th>Time (min.)</th> </tr> </thead> <tbody> <tr> <td>1</td> <td>-20 +0, -3</td> <td>30</td> </tr> <tr> <td>2</td> <td>Room temp.</td> <td>10-15</td> </tr> <tr> <td>3</td> <td>+85 +3, -0</td> <td>30</td> </tr> <tr> <td>4</td> <td>Room temp.</td> <td>10-15</td> </tr> </tbody> </table>	Step	Temp. (°C)	Time (min.)	1	-20 +0, -3	30	2	Room temp.	10-15	3	+85 +3, -0	30	4	Room temp.	10-15
Step	Temp. (°C)	Time (min.)																
1	-20 +0, -3	30																
2	Room temp.	10-15																
3	+85 +3, -0	30																
4	Room temp.	10-15																
9	Humidity Test	Normal appearance Resistance change: not to exceed ±20% (*)	JIS C 5102 term 9.5 40±2°C, 90-95%RH leave for 500±4 hrs.															
10	High Temperature Load Test	Normal appearance Resistance change: not to exceed ±20% (*)	JIS C 5102 term 9.10 60±3°C (in air), PTC is applied maximum operating voltage for 1.5 hrs. on and 0.5 hrs. off. This cycle is repeated for 1000±10 hrs.															

(\*) Measure resistance after the test by applying voltage of less than 1.5Vdc by a direct current of less than 10mA after product is left at 25±2°C for 2 hours.

Above mentioned soldering in "4. Adhesive Strength" and "5. Vibration" is done under the following conditions at our site.

- Glass-Epoxy PC board
- Standard land dimension
- Standard solder paste
- Standard solder profile

Above conditions are mentioned in Notice.

# Chip Type Specifications and Test Methods

## ■ PRG21BC Series

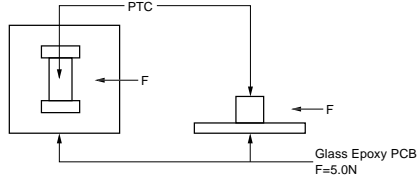
No.	Item	Rating Value	Method of Examination														
1	Operating Temp.	-10 to 60°C	Temperature range with maximum voltage applied to PTC.														
2	Resistance Value (at 25°C)	The resistance value should be within the specified tolerance.	After leaving for 24 hrs. or more in 25°C, it measures by 4 wire measuring methods using the direct-current terminal current of 10mA or less (0.1 or less Vdcs).														
3	Withstanding Voltage	Without damage	We apply 120% of the maximum operating voltage to PTC by raising gradually for 180±5 secs. at 25°C. (A protective resistor is to be connected in series, and the inrush current through PTC must be limited below maximum rated value.)														
4	Adhesive Strength	There is no exfoliation sign of electrode.	EIAJ ET-7403 term 9 Soldered PTC to PCB and add the force of 5.0N in the direction as shown below. 														
5	Vibration	Normal appearance Resistance change: not to exceed ±20% (*)	JIS C 5102 term 8.2 Soldered PTC to PCB Vibration: A 10-55-10Hz (1 min.) Width: 1.5mm Vibrate for 2 hrs. in each of 3 mutually perpendicular planes for a total of 6 hrs.														
6	Solderability	Min. 75% electrode is covered with new solder. Resistance change: not to exceed ±20% (*)	JIS C 5102 term 8.4 Solder: Sn 63%/Pb 37% (or 60/40%) Solder temp: 230±5°C Soaking time: 3±0.5 secs. Soaking position: Until a whole electrode is soaked.														
7	Solder-heatability	Normal appearance Resistance change: not to exceed ±20% (*)	Solder: Sn 63%/Pb 37% (or 60/40%) Flux: Solder paste containing less than 0.2wt% of chlorine. Preheating: 150±5°C 3mins. Peak temp.: 260±5°C 10±5 secs. (reflow) PCB: Glass Epoxy PCB (JIS C 6484)														
8	High Temperature Test	Normal appearance Resistance change: not to exceed ±20% (*)	60±3°C leave for 1000±10 hrs.														
9	Low Temperature Test		-10±3°C leave for 1000±10 hrs.														
10	Humidity Test		60±2°C, 90-95%RH leave for 500±4 hrs.														
11	Temperature Cycling		JIS C 5102 term 9.3 Times: 5 cycles <table border="1" data-bbox="945 1350 1299 1465"> <thead> <tr> <th>Step</th> <th>Temp. (°C)</th> <th>Time (min.)</th> </tr> </thead> <tbody> <tr> <td>1</td> <td>-20 +0, -3</td> <td>30</td> </tr> <tr> <td>2</td> <td>Room temp.</td> <td>10-15</td> </tr> <tr> <td>3</td> <td>+85 +3, -0</td> <td>30</td> </tr> <tr> <td>4</td> <td>Room temp.</td> <td>10-15</td> </tr> </tbody> </table>	Step	Temp. (°C)	Time (min.)	1	-20 +0, -3	30	2	Room temp.	10-15	3	+85 +3, -0	30	4	Room temp.
Step	Temp. (°C)	Time (min.)															
1	-20 +0, -3	30															
2	Room temp.	10-15															
3	+85 +3, -0	30															
4	Room temp.	10-15															
12	High Temperature Load Test		60±3°C (in air), PTC is applied maximum operating voltage for 1.5 hrs. on and 0.5 hrs. off. This cycle is repeated for 500±10 hrs.														

(\*) The resistance measurement after the test.

After leaving for 24 hours. or more in 25±2°C, it measures by 4 wire measuring methods using the direct-current terminal current of 10mA or less (0.1 or less Vdcs).

Above mentioned soldering in "4. Adhesive Strength" and "5. Vibration" is done under the following conditions at our site.

- Glass-Epoxy PC board
- Standard land dimension
- Standard solder paste
- Standard solder profile

Above conditions are mentioned in Notice.

# POSISTOR<sup>®</sup> for Circuit Protection



## For Overcurrent Protection Narrow Current Band 30V Series

This product is leaded type PTC thermistor for overcurrent protection which is suitable for the current limiting resistor.

### ■ Features

1. Small fluctuation in the circuit due to resistance tolerance +/-10%
2. Narrow current range (less than twice) between operating and non-operating current at -10 to 60 degrees C.
3. Quick operating time due to small size compared with conventional products.
4. Best suited to meet the requirements for power supply and motor protector. Error-free operations are assured by rush current.
5. Circuit is protected until current is turned off.
6. Restores the original low resistance value automatically once the overload is removed.
7. Non-contact design leads to long life and no noise. Durable and strong against mechanical vibration and shock because it is a solid element.
8. Lead (Pb) is not contained in the terminations.

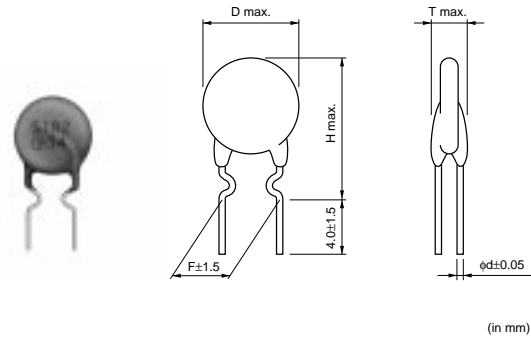

Part Number	Max. Voltage (V)	Non-operating Current (at +60°C)(mA)	Trip Current (at -10°C) (mA)	Max. Current (A)	Resistance (at 25°C) (ohm)	Body Diameter (D) (mm)	Thickness (T) (mm)	Height (H) (mm)	Lead Space (F) (mm)	Lead Diameter (phi d)(mm)
PTGL04AS100K2N51B0	30	122	240	1.5	10 ±10%	4.5	3.5	9.5	5.0	0.5
PTGL04AS100K2B51B0	30	167	330	2.0	10 ±10%	4.5	3.5	9.5	5.0	0.6
PTGL05AS3R9K2B51B0	30	269	530	3.5	3.9 ±10%	5.5	3.5	10.5	5.0	0.6
PTGL07AS2R7K2B51B0	30	336	663	4.5	2.7 ±10%	7.3	3.5	12.3	5.0	0.6
PTGL07AS1R8K2B51B0	30	420	829	5.0	1.8 ±10%	7.3	3.5	12.3	5.0	0.6
PTGL09AS1R2K2B51B0	30	556	1097	6.0	1.2 ±10%	9.3	3.5	14.3	5.0	0.6
PTGL12AS0R8K2B51B0	30	685	1352	7.0	0.8 ±10%	11.5	3.5	16.5	5.0	0.6

Maximum Current shows typical capacities of the transformer which can be used.  
 30V Series are recognized by UL.  
 Taping type is also available.

### ■ Protective Threshold Current Range

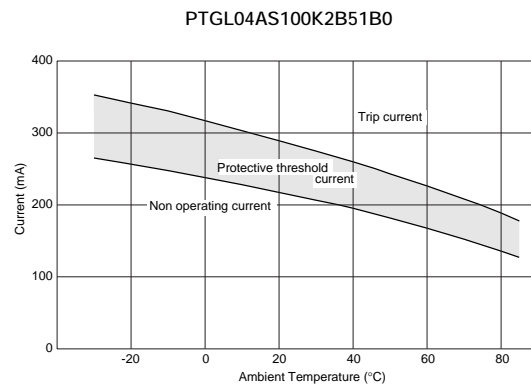
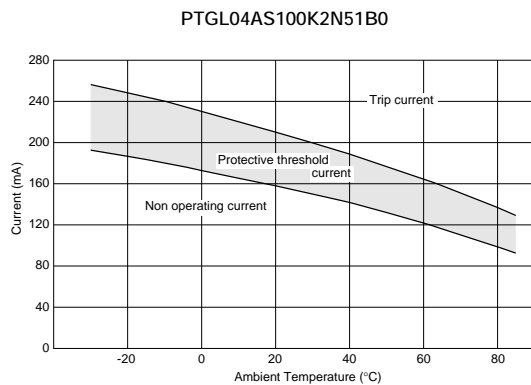

Continued on the following page. ↗

Continued from the preceding page.

■ Protective Threshold Current Range

PTGL05AS3R9K2B51B0

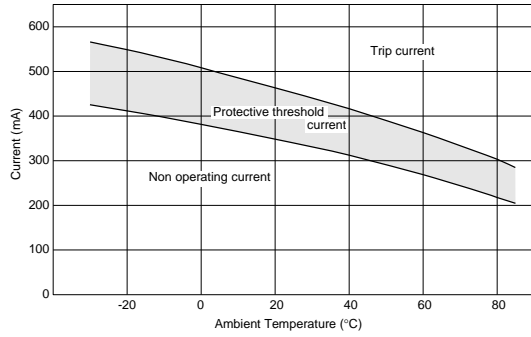

PTGL07AS2R7K2B51B0

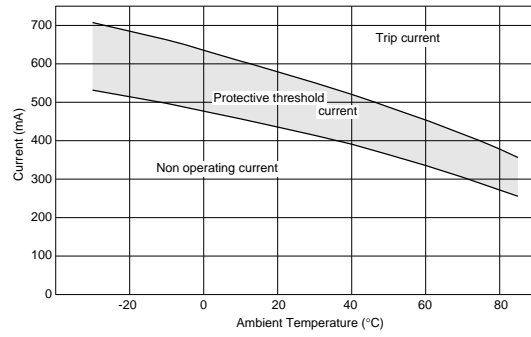

PTGL07AS1R8K2B51B0

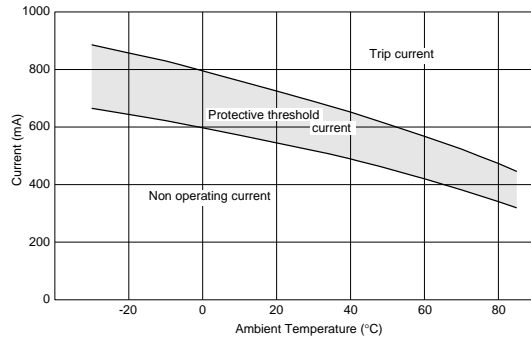

PTGL09AS1R2K2B51B0

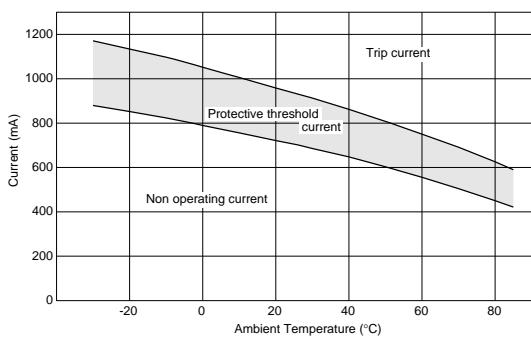

PTGL12AS0R8K2B51B0

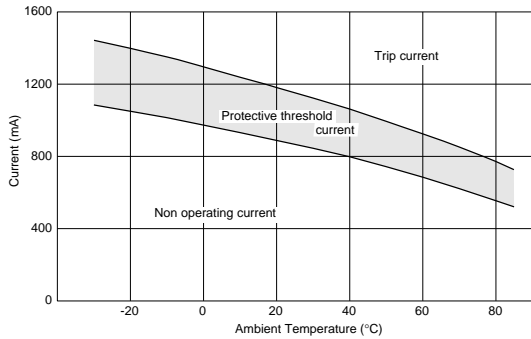

■ Operating Time (Typical Curve)

PTGL04AS100K2N51B0

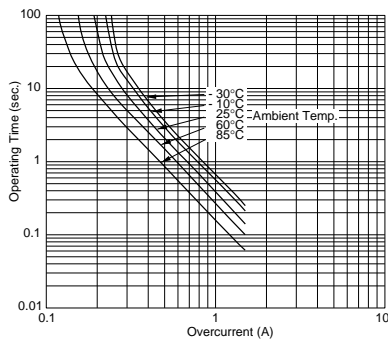

PTGL04AS100K2B51B0

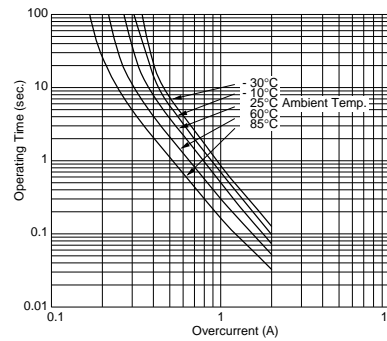

Continued on the following page. ↗

Continued from the preceding page.

■ Operating Time (Typical Curve)

PTGL05AS3R9K2B51B0

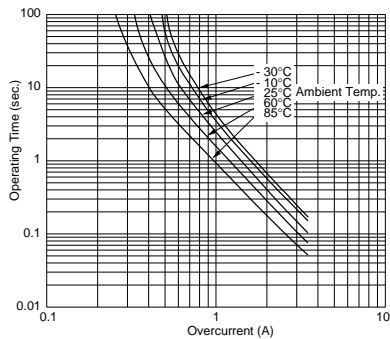

PTGL07AS2R7K2B51B0

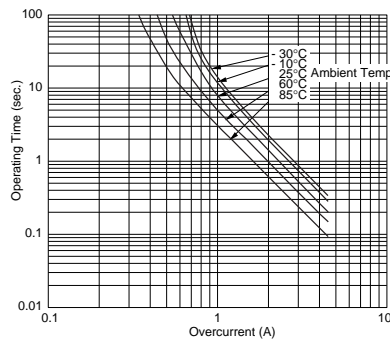

PTGL07AS1R8K2B51B0

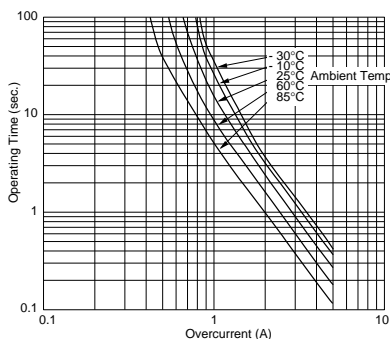

PTGL09AS1R2K2B51B0

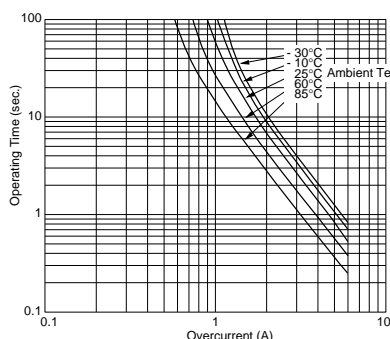

PTGL12AS0R8K2B51B0

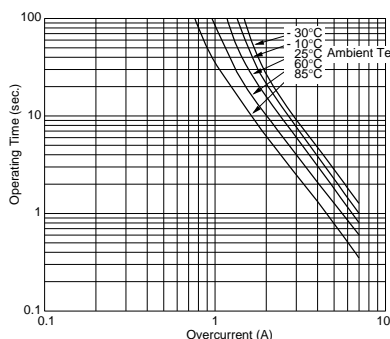

2

# POSISTOR<sup>®</sup> for Circuit Protection



## For Overcurrent Protection Narrow Current Band 51/60V Series

3

This product is leaded type PTC thermistor for overcurrent protection which is suitable for the current limiting resistor.

### ■ Features

1. Small fluctuation in the circuit due to resistance tolerance +/-10%
2. Narrow current range (less than twice) between operating and non-operating current at -10 to 60 degrees C.
3. Quick operating time due to small size compared with conventional products.
4. Best suited to meet the requirements for power supply and motor protector. Error-free operations are assured by rush current.
5. Circuit is protected until current is turned off.
6. Restores the original low resistance value automatically once the overload is removed.
7. Non-contact design leads to long life and no noise. Durable and strong against mechanical vibration and shock because it is a solid element.
8. Lead (Pb) is not contained in the terminations.

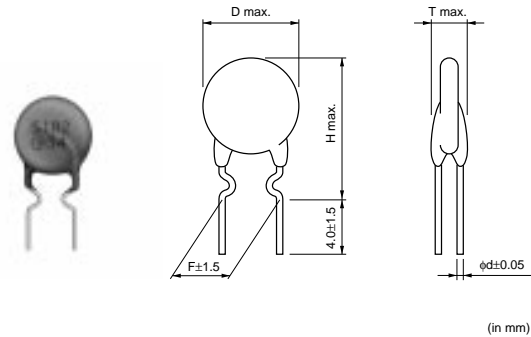

Part Number	Max. Voltage (V)	Non-operating Current (at +60°C)(mA)	Trip Current (at -10°C) (mA)	Max. Current (A)	Resistance (at 25°C) (ohm)	Body Diameter (D) (mm)	Thickness (T) (mm)	Height (H) (mm)	Lead Space (F) (mm)	Lead Diameter (phi d)(mm)
PTGL04AS100K3B51B0	51	168	332	1.0	10 ±10%	4.5	3.5	9.5	5.0	0.6
PTGL05AS6R8K3B51B0	51	197	388	1.5	6.8 ±10%	5.5	3.5	10.5	5.0	0.6
PTGL07AS3R3K3B51B0	51	307	606	3.0	3.3 ±10%	7.3	3.5	12.3	5.0	0.6
PTGL09AS2R2K3B51B0	51	412	814	4.0	2.2 ±10%	9.3	3.5	14.3	5.0	0.6
PTGL12AS1R2K3B51B0	51	592	1168	5.0	1.2 ±10%	11.5	3.5	16.5	5.0	0.6
PTGL04AS220K4N51B0	60	88	175	1.0	22 ±10%	4.5	3.5	9.5	5.0	0.5
PTGL04AS220K4B51B0	60	115	226	1.0	22 ±10%	4.5	3.5	9.5	5.0	0.6
PTGL05AS100K4B51B0	60	170	335	1.5	10 ±10%	5.5	3.5	10.5	5.0	0.6
PTGL07AS5R6K4N51B0	60	186	368	2.2	5.6 ±10%	7.3	3.5	12.3	5.0	0.5
PTGL07AS5R6K4B51B0	60	229	452	3.0	5.6 ±10%	7.3	3.5	12.3	5.0	0.6
PTGL09AS3R3K4B51B0	60	333	656	4.0	3.3 ±10%	9.3	3.5	14.3	5.0	0.6
PTGL12AS2R2K4B51B0	60	439	867	5.0	2.2 ±10%	11.5	3.5	16.5	5.0	0.6

Maximum Current shows typical capacities of the transformer which can be used.  
 51/60V Series are recognized by UL.  
 Taping type is also available.

### ■ Protective Threshold Current Range (51V Series)

PTGL04AS100K3B51B0

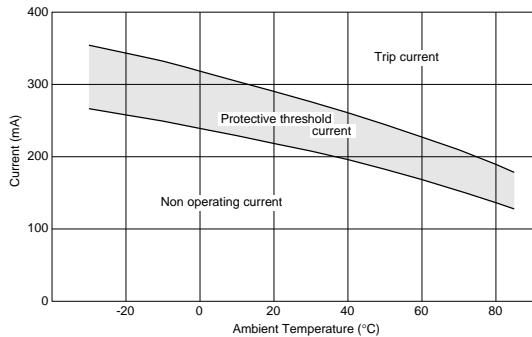

PTGL05AS6R8K3B51B0

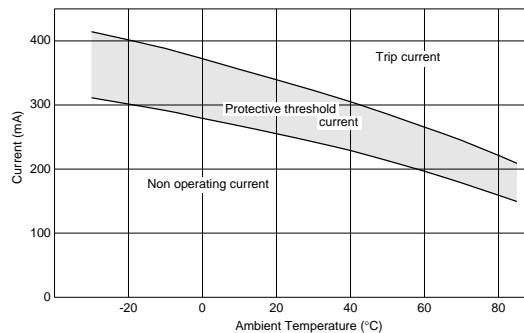

3

PTGL07AS3R3K3B51B0

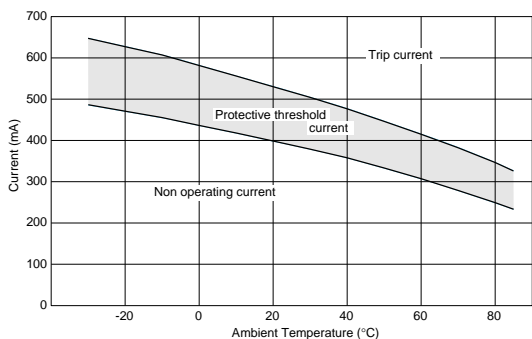

PTGL09AS2R2K3B51B0

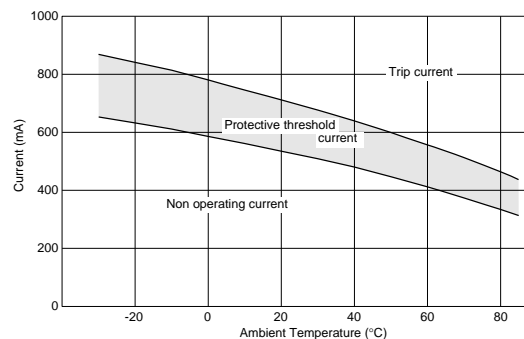

PTGL12AS1R2K3B51B0

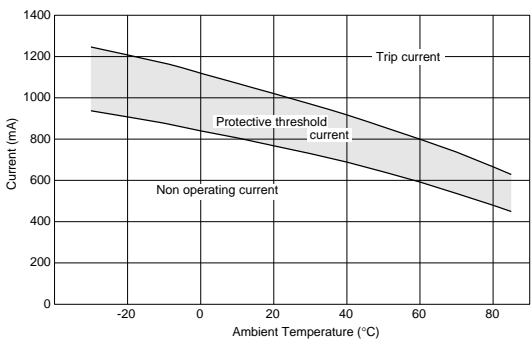

### ■ Protective Threshold Current Range (60V Series)

PTGL04AS220K4N51B0

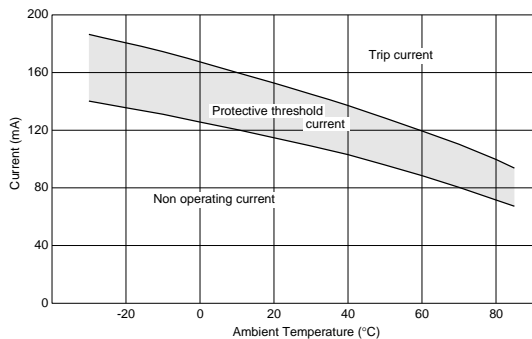

PTGL04AS220K4B51B0

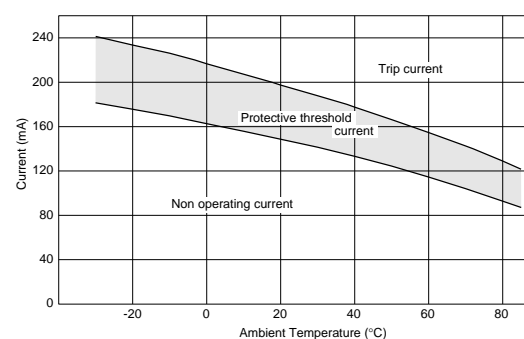

Continued on the following page. ↗



Continued from the preceding page.

■ Protective Threshold Current Range (60V Series)

PTGL05AS100K4B51B0

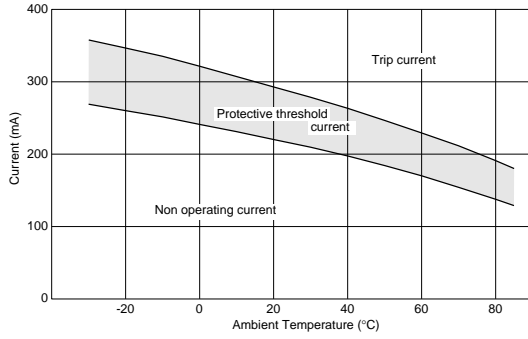

PTGL07AS5R6K4N51B0

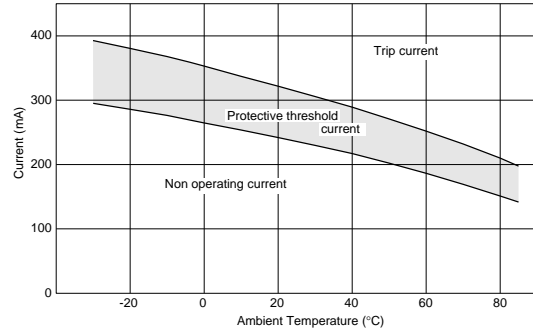

PTGL07AS5R6K4B51B0

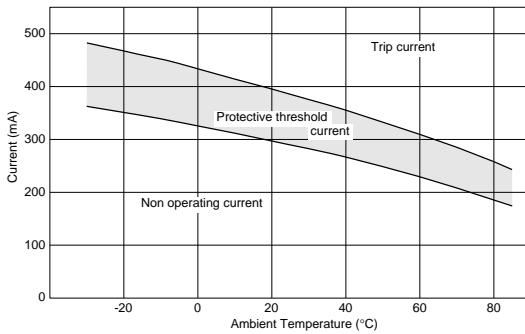

PTGL09AS3R3K4B51B0

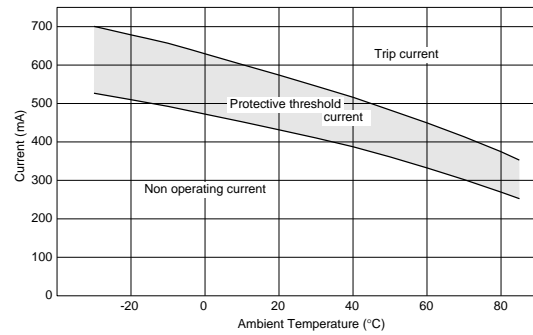

PTGL12AS2R2K4B51B0

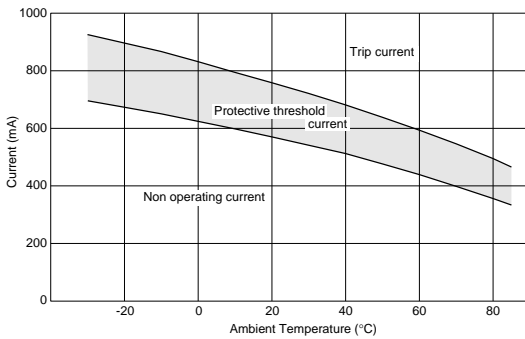

■ Operating Time 51V Series (Typical Curve)

PTGL04AS100K3B51B0

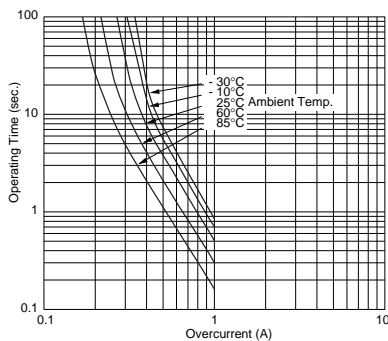

PTGL05AS6R8K3B51B0

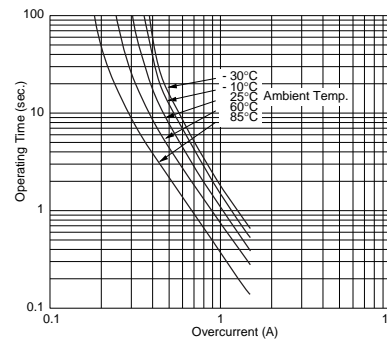

Continued on the following page. ↗

Continued from the preceding page.

■ Operating Time 51V Series (Typical Curve)

PTGL07AS3R3K3B51B0

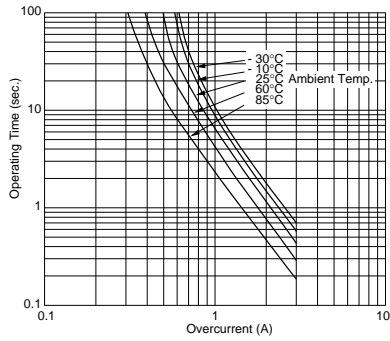

PTGL09AS2R2K3B51B0

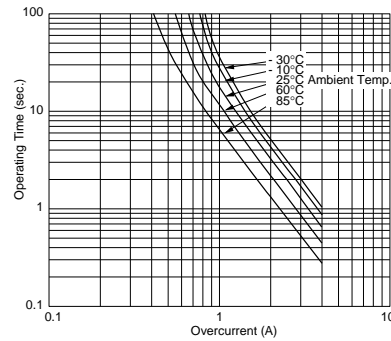

PTGL12AS1R2K3B51B0

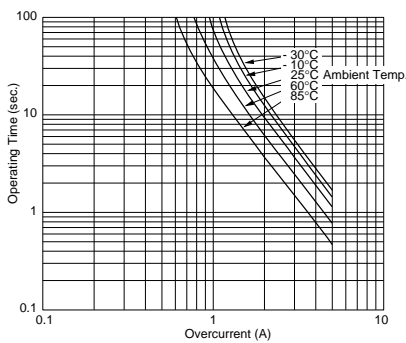

■ Operating Time 60V Series (Typical Curve)

PTGL04AS220K4N51B0

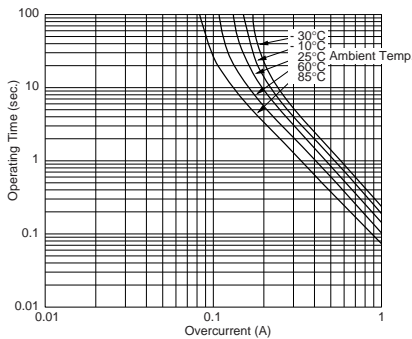

PTGL04AS220K4B51B0

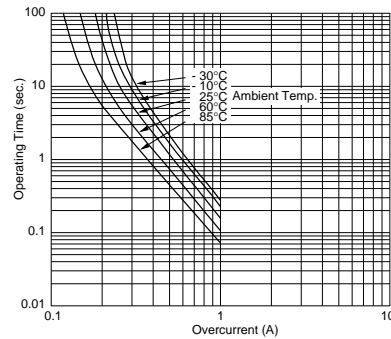

PTGL05AS100K4B51B0

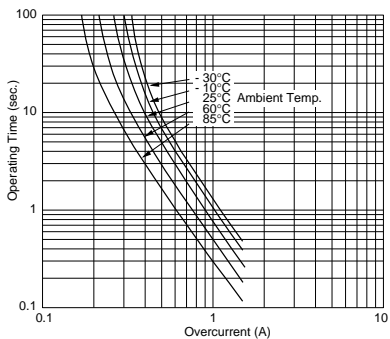

PTGL07AS5R6K4N51B0

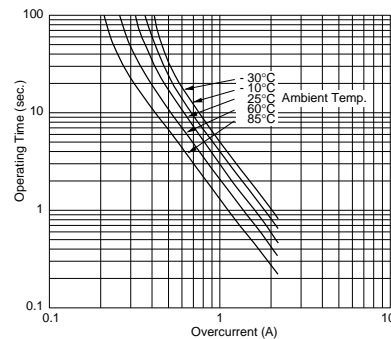

Continued on the following page.

Continued from the preceding page.

### Operating Time 60V Series (Typical Curve)

PTGL07AS5R6K4B51B0

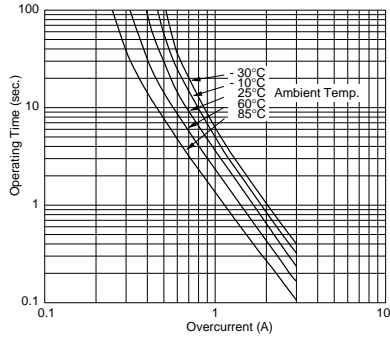

PTGL09AS3R3K4B51B0

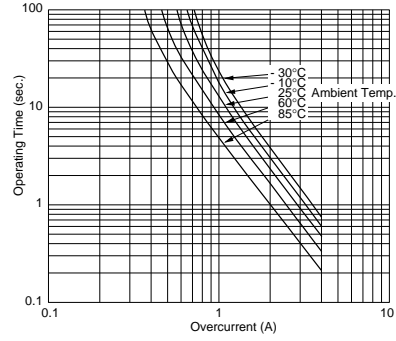

PTGL12AS2R2K4B51B0

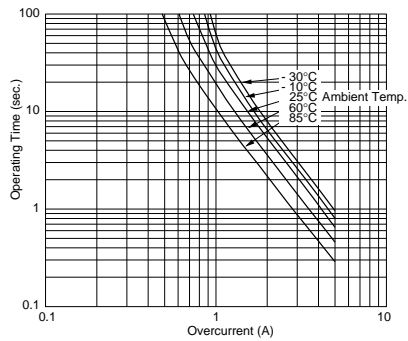

3

# POSISTOR<sup>®</sup> for Circuit Protection



## For Overcurrent Protection Narrow Current Band 140V Series

This product is leaded type PTC thermistor for overcurrent protection which is suitable for the current limiting resistor.

### ■ Features

1. Small fluctuation in the circuit due to resistance tolerance +/-10%
2. Narrow current range (less than twice) between operating and non-operating current at -10 to 60 degrees C.
3. Quick operating time due to small size compared with conventional products.
4. Best suited to meet the requirements for power supply and motor protector. Error-free operations are assured by rush current.
5. Circuit is protected until current is turned off.
6. Restores the original low resistance value automatically once the overload is removed.
7. Non-contact design leads to long life and no noise. Durable and strong against mechanical vibration and shock because it is a solid element.
8. Lead (Pb) is not contained in the terminations.

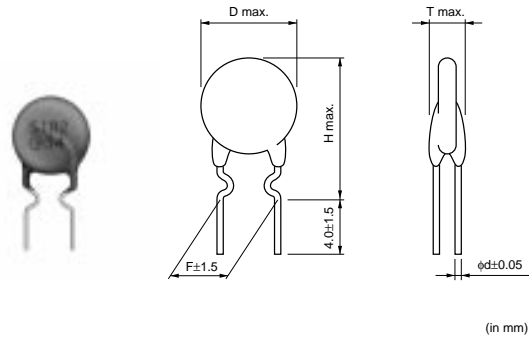

4

Part Number	Max. Voltage (V)	Non-operating Current (at +60°C)(mA)	Trip Current (at -10°C) (mA)	Max. Current (A)	Resistance (at 25°C) (ohm)	Body Diameter (D) (mm)	Thickness (T) (mm)	Height (H) (mm)	Lead Space (F) (mm)	Lead Diameter (phi d)(mm)
PTGL04AS560K6B51B0	140	74	147	0.5	56 ±10%	5.5	4.5	10.5	5.0	0.6
PTGL05AS270K6B51B0	140	106	209	1.0	27 ±10%	5.5	4.5	10.5	5.0	0.6
PTGL07AS150K6B51B0	140	148	292	1.5	15 ±10%	7.3	4.5	12.3	5.0	0.6
PTGL09AS120K6B51B0	140	192	380	2.0	12 ±10%	9.3	4.5	14.3	5.0	0.6
PTGL09AS7R6K6B51B0	140	227	447	2.2	7.6 ±10%	9.3	4.5	14.3	5.0	0.6
PTGL12AS4R7K6B51B0	140	310	613	3.5	4.7 ±10%	11.5	4.5	16.5	5.0	0.6

Maximum Current shows typical capacities of the transformer which can be used.  
 140V Series are recognized by UL.  
 Taping type is also available.

### ■ Protective Threshold Current Range

PTGL04AS560K6B51B0

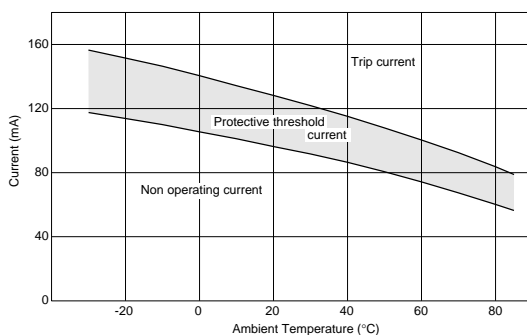

PTGL05AS270K6B51B0

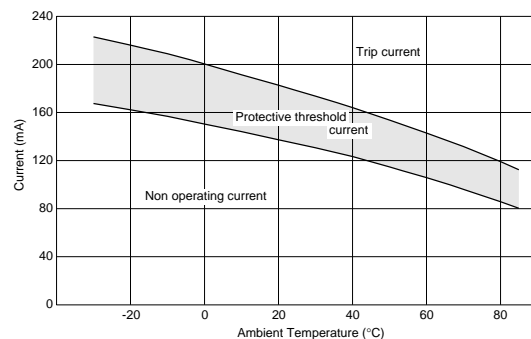

Continued on the following page. ↗

Continued from the preceding page.

■ Protective Threshold Current Range

PTGL07AS150K6B51B0

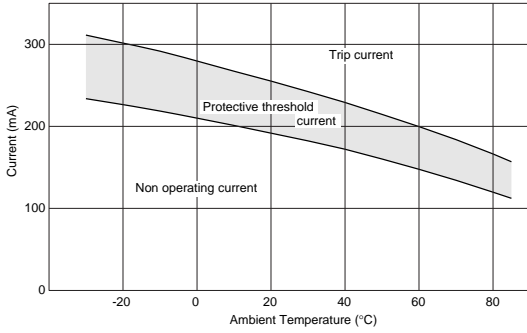

PTGL09AS120K6B51B0

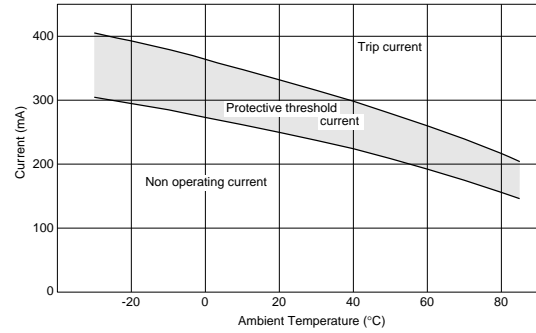

PTGL09AS7R6K6B51B0

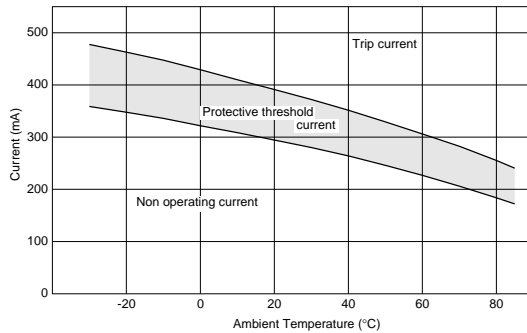

PTGL12AS4R7K6B51B0

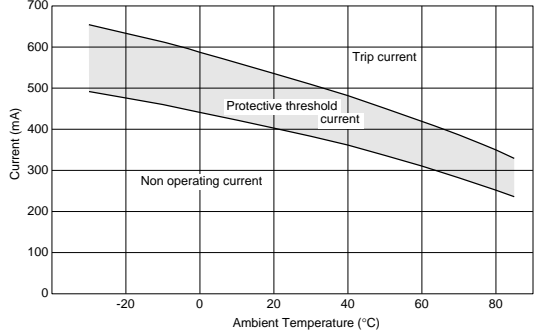

■ Operating Time (Typical Curve)

PTGL04AS560K6B51B0

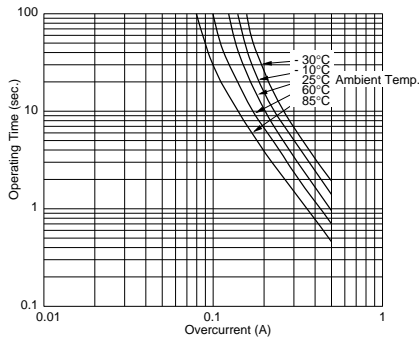

PTGL05AS270K6B51B0

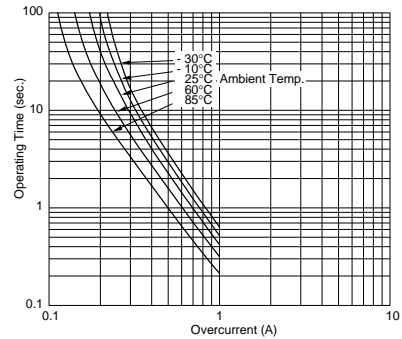

PTGL07AS150K6B51B0

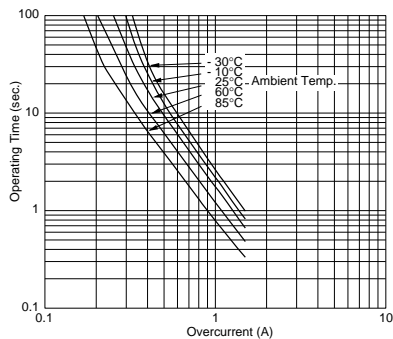

PTGL09AS120K6B51B0

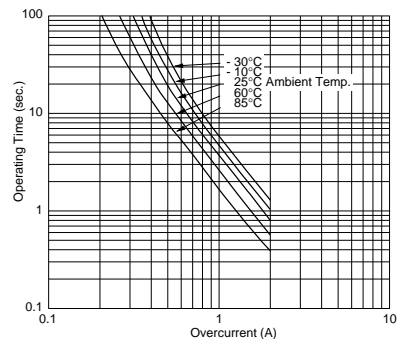

Continued on the following page. ↗

Continued from the preceding page.

### ■ Operating Time (Typical Curve)

PTGL09AS7R6K6B51B0

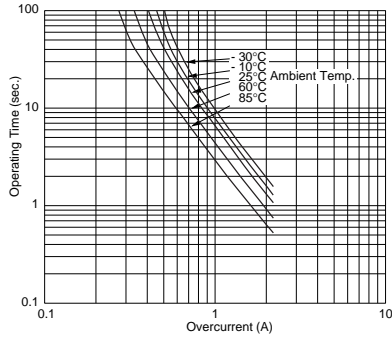

PTGL12AS4R7K6B51B0

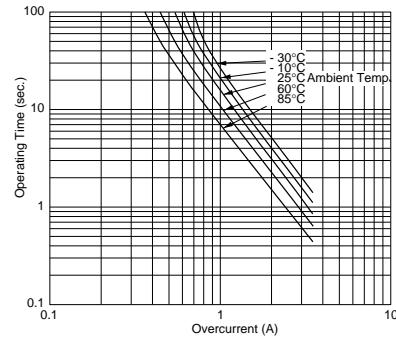

4

# POSISTOR<sup>®</sup> for Circuit Protection



## For Overcurrent Protection 24/30/32V Series

Safety resistor "POSISTOR" is most suited to meet the requirements of the safety standard short-circuit tests such as IEC, VDE, BS, UL, CSA etc. all over the world.

### ■ Features

1. Best suited to meet the requirements of the short-circuit test. Quick response compared with current fuse and resistor and error-free operation are assured.
2. Small size does not need a large space. Capable of being mounted to any place because replacement is not required.
3. Actuates by excessive current during the short-circuit test to restrain abnormal heat generation in other circuit components and printed boards. This state will be maintained until the abnormal state is removed or power is turned off to reset the "POSISTOR" to the original state. Surface temperature of "POSISTOR" is kept low, below a certain value, during the actuation.
4. Non-contact design leads to long life and no noise. Durable and strong against mechanical vibration and shock because it is a solid element.

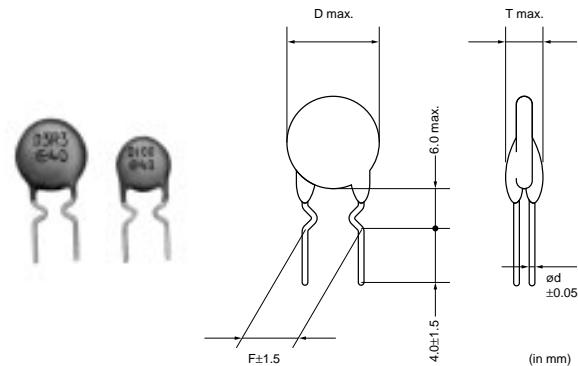

5

Part Number	Max. Voltage (V)	Non-operating Current (at +60°C)(mA)	Trip Current (at -10°C) (mA)	Max. Current (A)	Resistance (at 25°C) (ohm)	Body Diameter (D) (mm)	Thickness (T) (mm)	Lead Space (F) (mm)	Lead Diameter (phi d)(mm)
PTGL07BD100N2B51B0	24	80	320	2.0	10 ±30%	7.4	4.0	5.0	0.6
PTGL07BD6R8N2B51B0	24	90	370	2.0	6.8 ±30%	7.4	4.0	5.0	0.6
PTGL09BD4R7N2B51B0	24	120	500	2.0	4.7 ±30%	9.5	4.0	5.0	0.6
PTGL09BD3R3N2B51B0	24	140	580	2.0	3.3 ±30%	9.5	4.0	5.0	0.6
PTGL09BD2R2N2B51B0	24	180	710	2.0	2.2 ±30%	9.5	4.0	5.0	0.6
PTGL04AR130H2B51B0	30	145	400	0.7	13 ±25%	5.5	4.0	5.0	0.6
PTGL07AR4R6H2B51B0	30	250	700	2.0	4.6 ±25%	7.4	4.0	5.0	0.6
PTGL09AR1R8H2B51B0	30	410	1120	3.0	1.8 ±25%	9.5	4.0	5.0	0.6
PTGL12AR1R2H2B51B0	30	520	1420	4.3	1.2 ±25%	12.0	4.0	5.0	0.6
PTGL13AR0R8H2B71B0	30	680	1900	5.5	0.8 ±25%	13.5	4.0	7.5	0.6
PTGL07BD470N3B51B0	32	30	140	1.5	47 ±30%	7.4	4.0	5.0	0.6
PTGL07BD330N3B51B0	32	40	170	1.5	33 ±30%	7.4	4.0	5.0	0.6
PTGL07BD220N3B51B0	32	45	200	1.5	22 ±30%	7.4	4.0	5.0	0.6
PTGL07BD150N3B51B0	32	60	240	1.5	15 ±30%	7.4	4.0	5.0	0.6

Maximum Current shows typical capacities of the transformer which can be used.  
 24/30/32V Series are recognized by UL. (except PTGL13AR0R8H2B71B0)  
 PTGL\_51B0 series are available in taping type.

■ Protective Threshold Current Range (24V Series)

PTGL07BD100N2B51B0

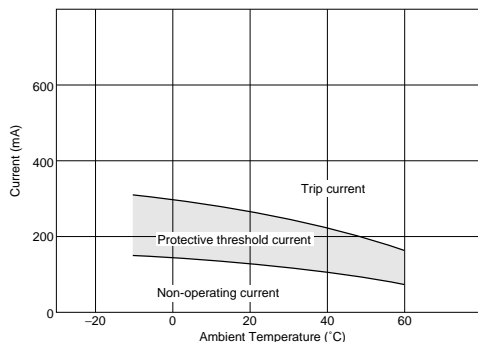

PTGL07BD6R8N2B51B0

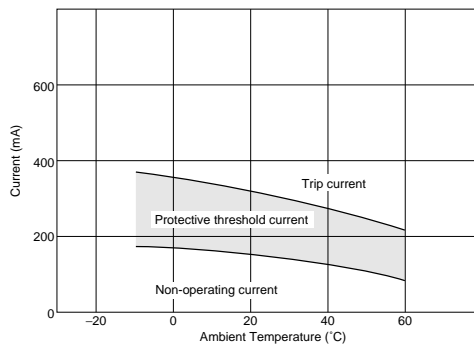

PTGL09BD4R7N2B51B0

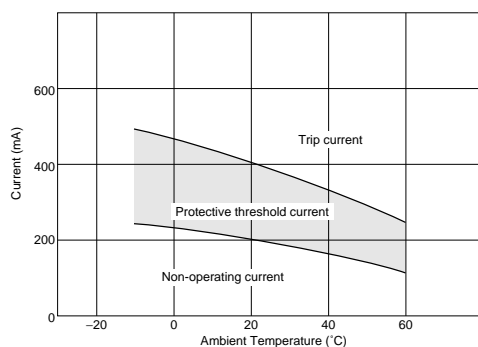

PTGL09BD3R3N2B51B0

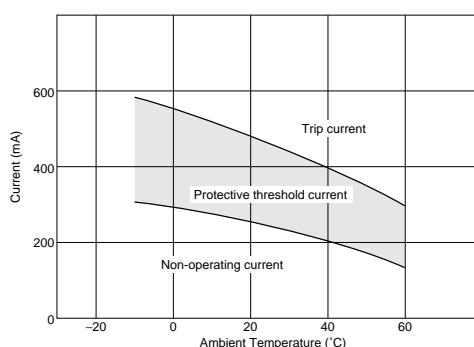

PTGL09BD2R2N2B51B0

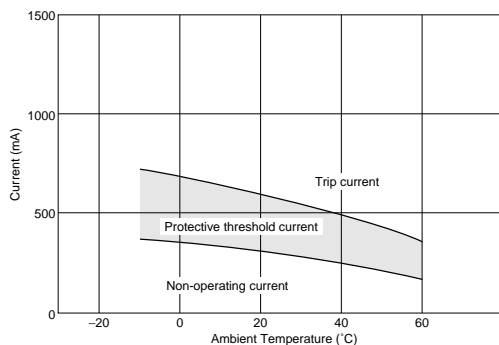

■ Protective Threshold Current Range (30V Series)

PTGL04AR130H2B51B0

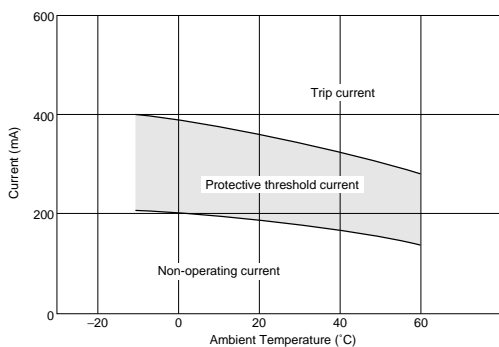

PTGL07AR4R6H2B51B0

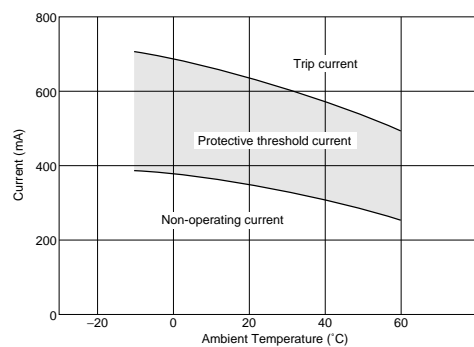

5



Continued from the preceding page.

■ Protective Threshold Current Range (30V Series)

PTGL09AR1R8H2B51B0

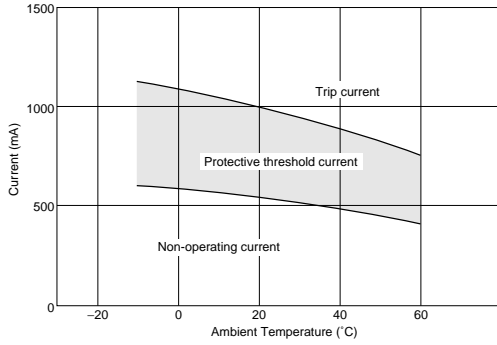

PTGL12AR1R2H2B51B0

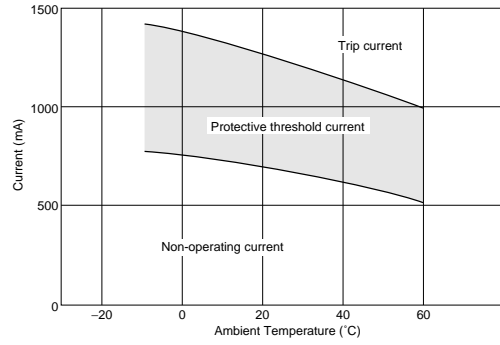

PTGL13AR0R8H2B71B0

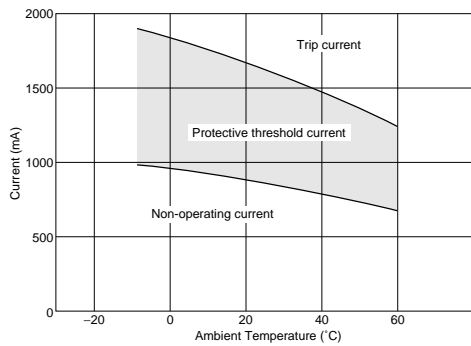

■ Protective Threshold Current Range (32V Series)

PTGL07BD470N3B51B0

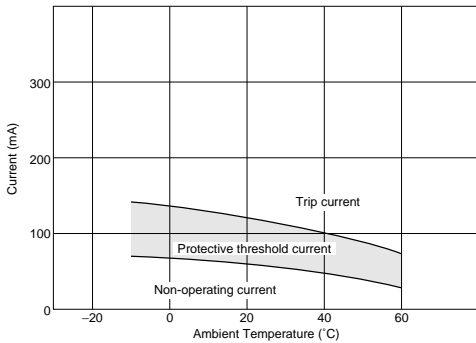

PTGL07BD330N3B51B0

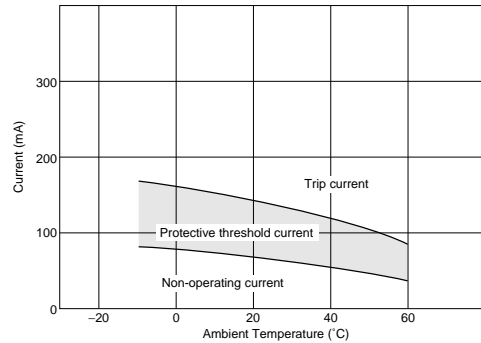

PTGL07BD220N3B51B0

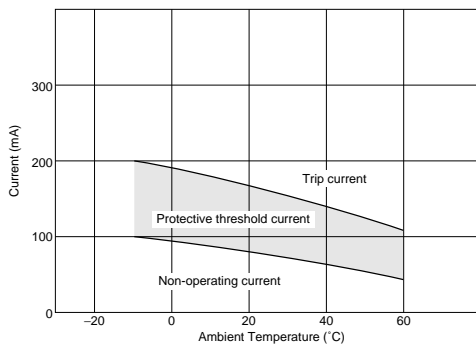

PTGL07BD150N3B51B0

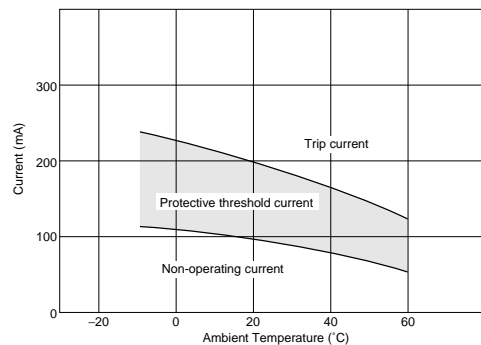

■ Operating Time 24V Series (Typical Curve)

PTGL07BD100N2B51B0

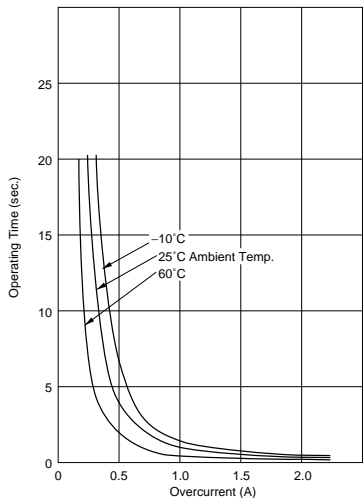

PTGL07BD6R8N2B51B0

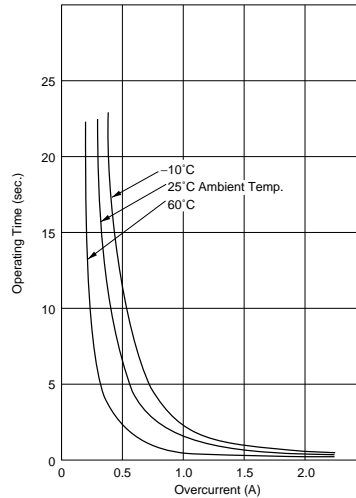

PTGL09BD4R7N2B51B0

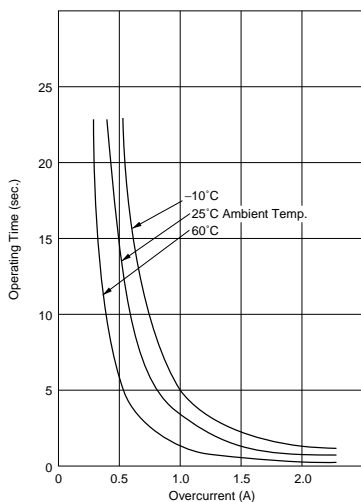

PTGL09BD3R3N2B51B0

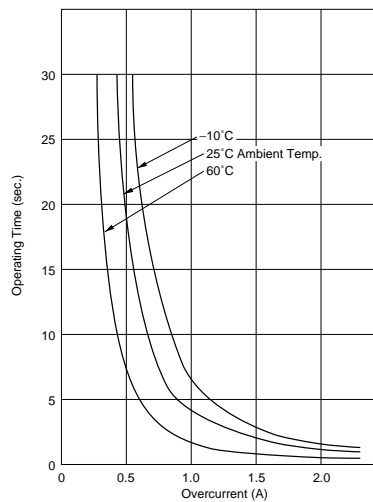

PTGL09BD2R2N2B51B0

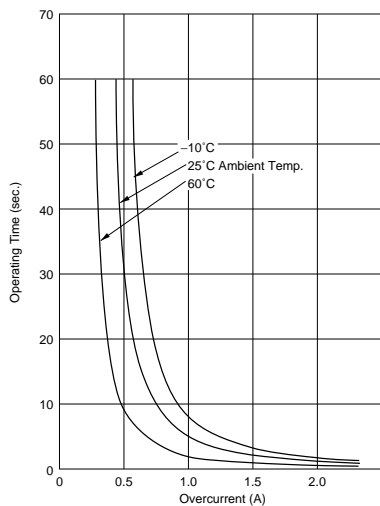

5

■ Operating Time 30V Series (Typical Curve)

PTGL04AR130H2B51B0

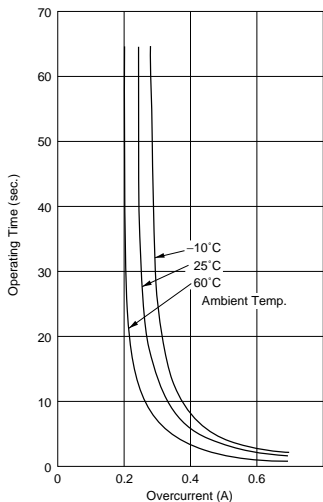

PTGL07AR4R6H2B51B0

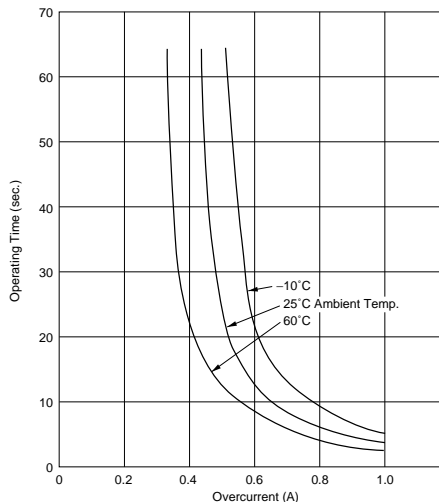

PTGL09AR1R8H2B51B0

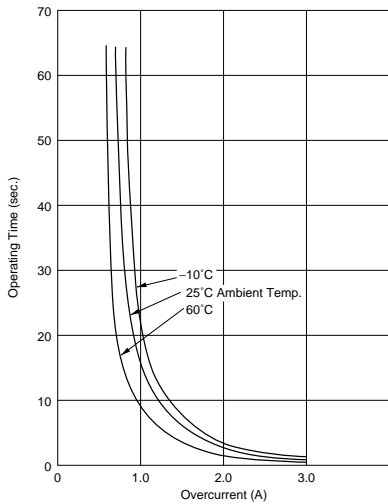

PTGL12AR1R2H2B51B0

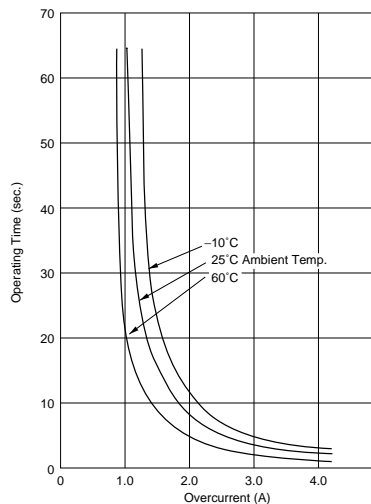

PTGL13AR0R8H2B71B0

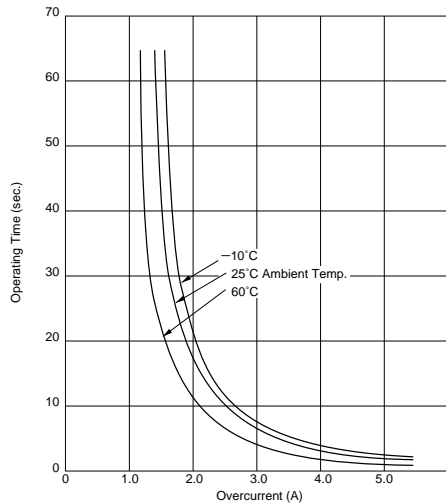

## ■ Operating Time 32V Series (Typical Curve)

PTGL07BD470N3B51B0

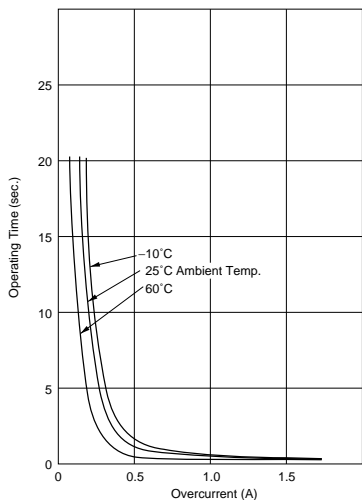

PTGL07BD330N3B51B0

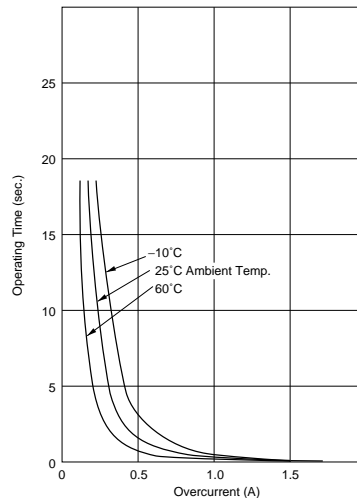

PTGL07BD220N3B51B0

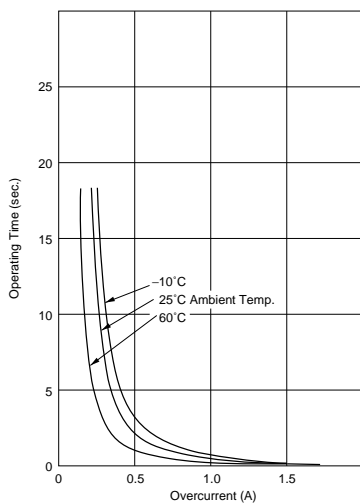

PTGL07BD150N3B51B0

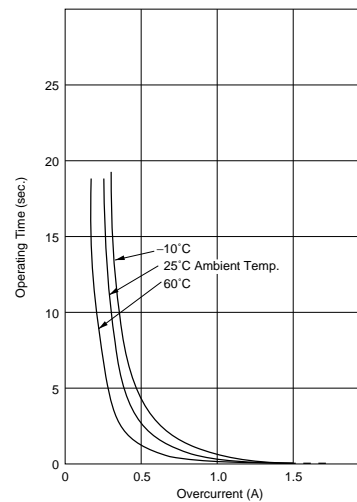

## ■ Application Circuit

(1) Short-Circuit Test of Transistor

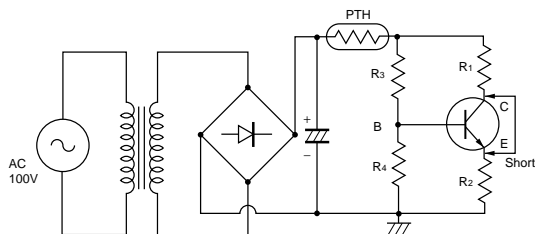

(2) Short-Circuit Test of Diode

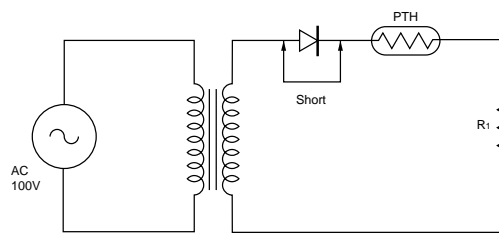

Continued on the following page. ↗

Continued from the preceding page.

## Application Circuit

(3) Short-Circuit Test of IC

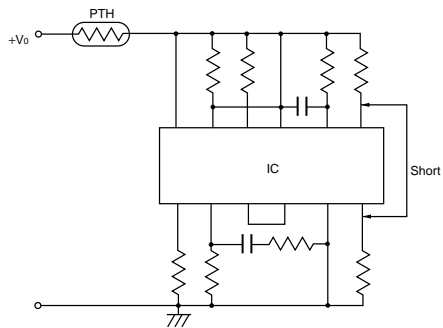

(4) Short-Circuit Test of Electrolytic Capacitor

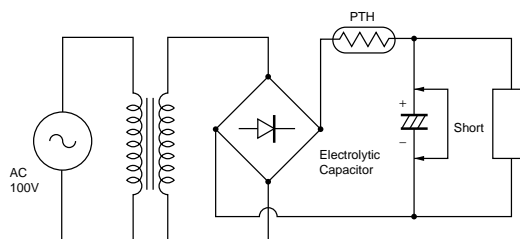

5

(5) Lock Test of Motor

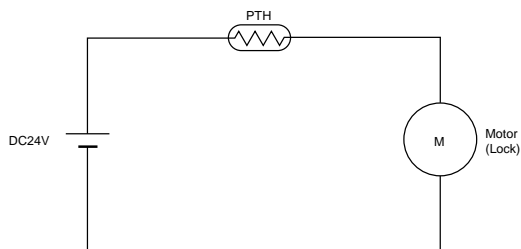

(6) Transistor Protection Circuit

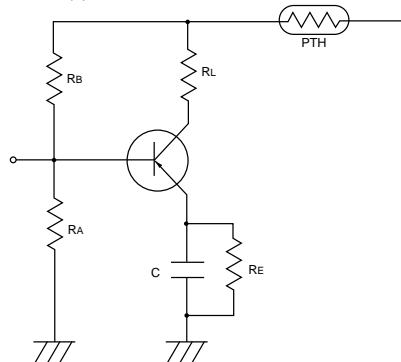

(7) Transformer Protection Circuit

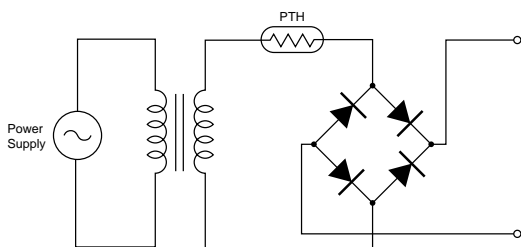

# POSISTOR<sup>®</sup> for Circuit Protection



## For Overcurrent Protection 56/80V Series

"POSISTOR" is a circuit protector whose resistance value in normal operation is very low and in abnormal situations like overcurrent or overheating, will be increased to restrain overcurrent. "POSISTOR" can be used for overcurrent protection against current fuse or temperature fuse, due to its ability to return to its initial condition when overcurrent is removed.

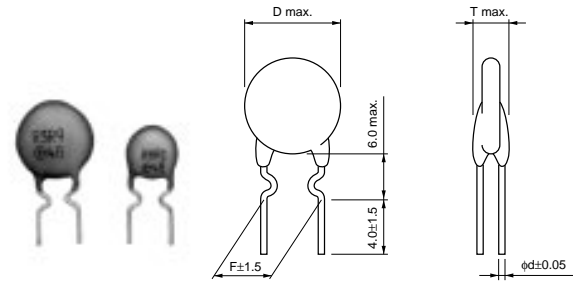

(in mm)

### ■ Features

1. Best suited to meet the requirements for power supply and motor protector. Error-free operations are assured by rush current.
2. Circuit is protected until current is turned off.
3. Restores the original low resistance value automatically once the overload is removed.
4. Non-contact design leads to long life and no noise. Durable and strong against mechanical vibration and shock because it is a solid element.

### ■ Applications

1. DC cooling fan motors in office equipment, e.g., computers, facsimiles, floppy disk drives and power units.
2. DC drive motors in VTRs and cassette tape recorders. Power transformers (at secondary winding)

Part Number	Max. Voltage (V)	Non-operating Current (at +60°C)(mA)	Trip Current (at -10°C) (mA)	Max. Current (A)	Resistance (at 25°C) (ohm)	Body Diameter (D) (mm)	Thickness (T) (mm)	Lead Space (F) (mm)	Lead Diameter (phi d)(mm)
PTGL07AR220M3P51B0	56	90	240	1.0	22 ±20%	7.4	4.0	5.0	0.6
PTGL07AR8R2M3P51B0	56	130	350	1.0	8.2 ±20%	7.4	4.0	5.0	0.6
PTGL09AR150M3B51B0	56	150	400	1.2	15 ±20%	9.5	4.0	5.0	0.6
PTGL10AR3R9M3P51B0	56	210	550	2.0	3.9 ±20%	10.5	4.0	5.0	0.6
PTGL09AR4R7M3B51B0	56	270	700	2.0	4.7 ±20%	9.5	4.0	5.0	0.6
PTGL10AR3R9M3B51B0	56	300	800	2.0	3.9 ±20%	10.5	4.0	5.0	0.6
PTGL14AR3R3M3B71B0	56	380	980	2.5	3.3 ±20%	14.5	4.0	7.5	0.6
PTGL05AR550H4P51B0	80	50	135	0.7	55 ±25%	5.5	4.5	5.0	0.6
PTGL07AR250H4B51B0	80	110	300	1.0	25 ±25%	7.4	4.5	5.0	0.6
PTGL09AR9R4H4B51B0	80	190	530	3.0	9.4 ±25%	9.5	4.5	5.0	0.6
PTGL12AR5R6H4B71B0	80	270	760	4.3	5.6 ±25%	12.0	4.5	7.5	0.6
PTGL13AR3R7H4B71B0	80	310	860	5.5	3.7 ±25%	13.5	4.5	7.5	0.6

Maximum Current shows typical capacities of the transformer which can be used.  
 Please contact us for UL recognized products.  
 PTGL\_51B0 series are available in taping type.

## ■ Protective Threshold Current Range (56V Series)

PTGL07AR220M3P51B0

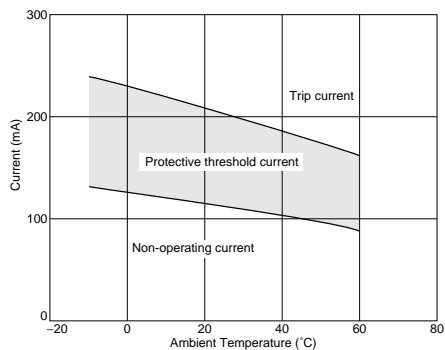

PTGL07AR8R2M3P51B0

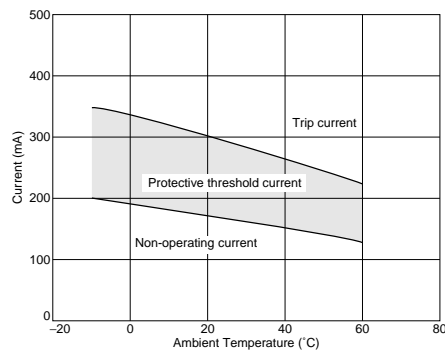

PTGL09AR150M3B51B0

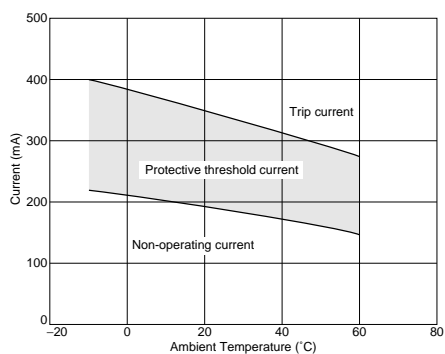

PTGL10AR3R9M3P51B0

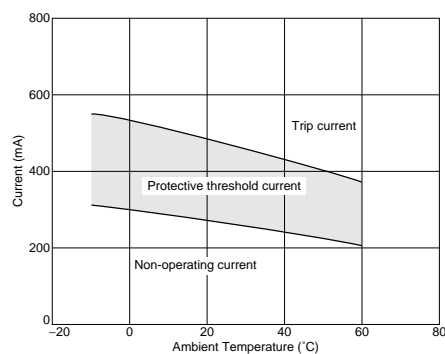

PTGL09AR4R7M3B51B0

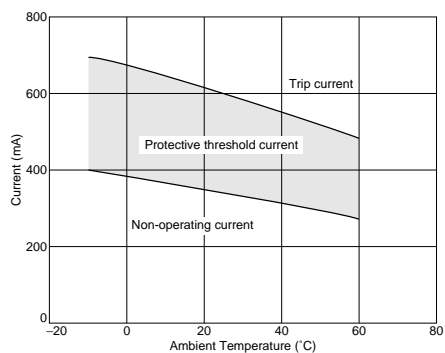

PTGL10AR3R9M3B51B0

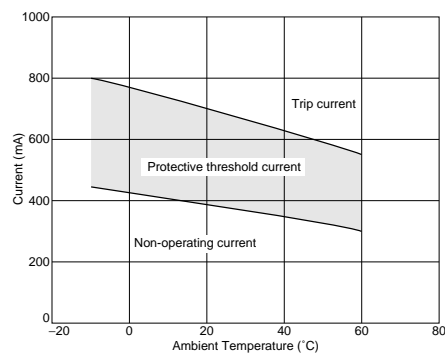

PTGL14AR3R3M3B71B0

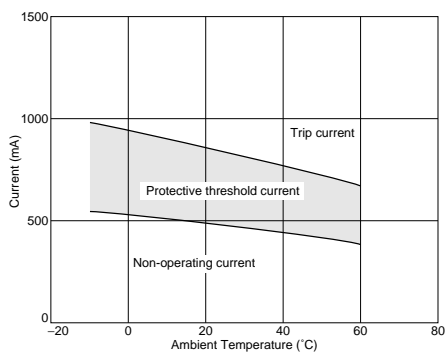

6

■ Protective Threshold Current Range (80V Series)

PTGL05AR550H4P51B0

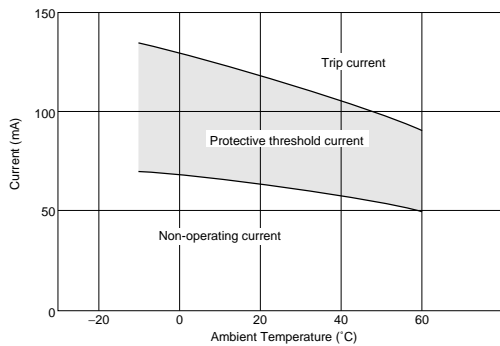

PTGL07AR250H4B51B0

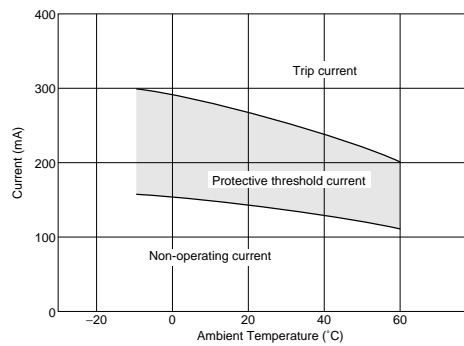

PTGL09AR9R4H4B51B0

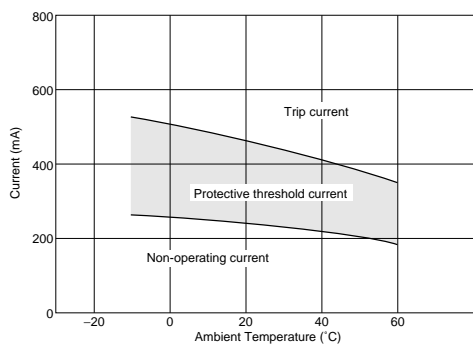

PTGL12AR5R6H4B71B0

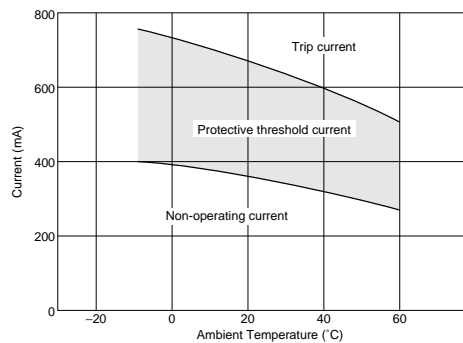

PTGL13AR3R7H4B71B0

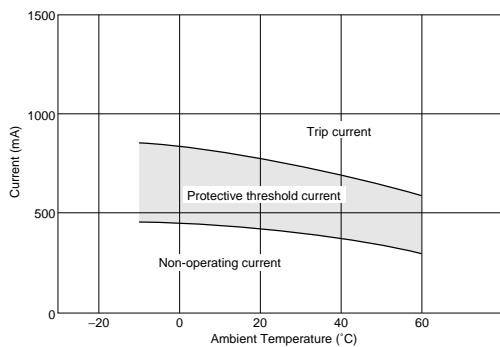

6



■ Operating Time 56V Series (Typical Curve)

PTGL07AR220M3P51B0

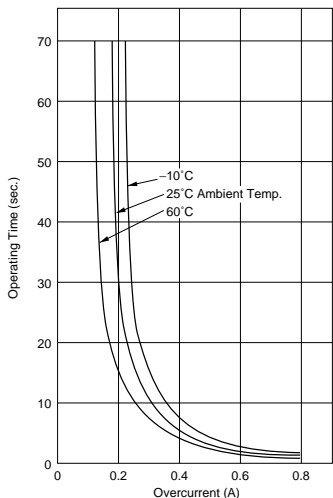

PTGL07AR8R2M3P51B0

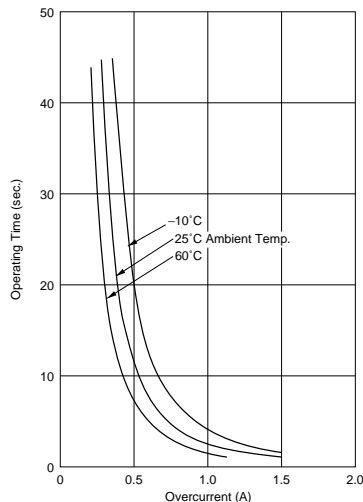

PTGL09AR150M3B51B0

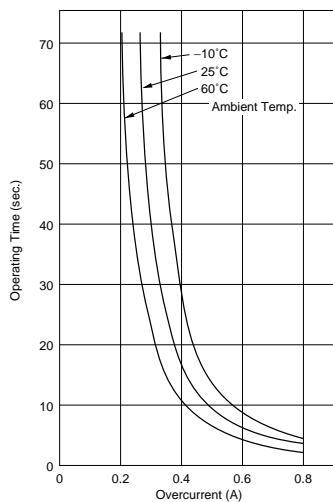

PTGL10AR3R9M3P51B0

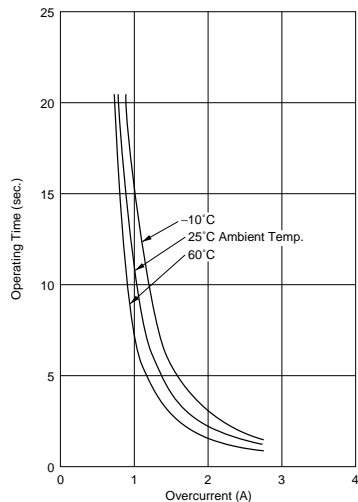

PTGL09AR4R7M3B51B0

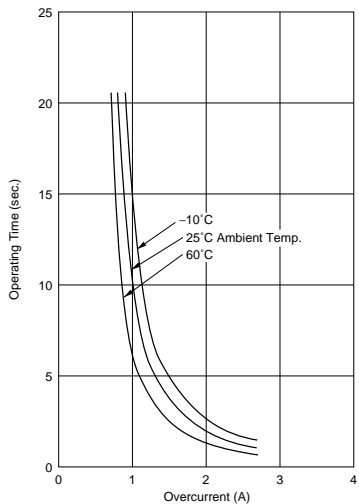

PTGL10AR3R9M3B51B0

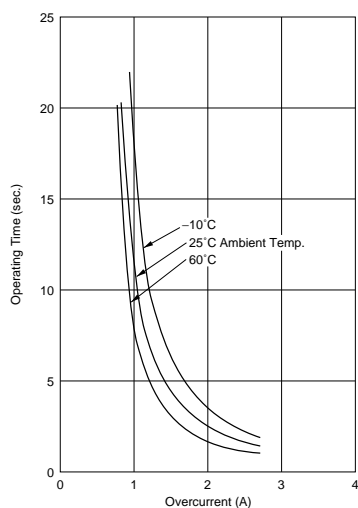

Continued from the preceding page.

### Operating Time 56V Series (Typical Curve)

PTGL14AR3R3M3B71B0

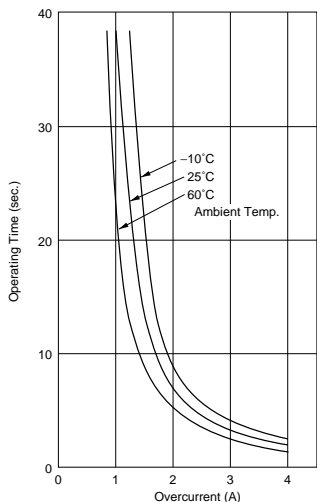

### Operating Time 80V Series (Typical Curve)

PTGL05AR550H4P51B0

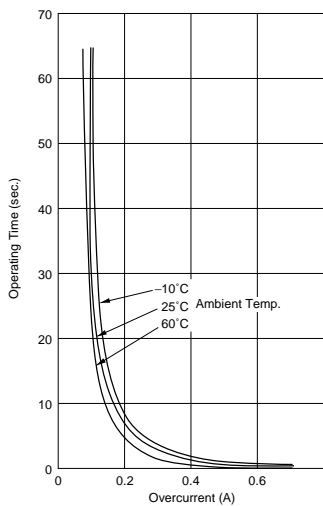

PTGL07AR250H4B51B0

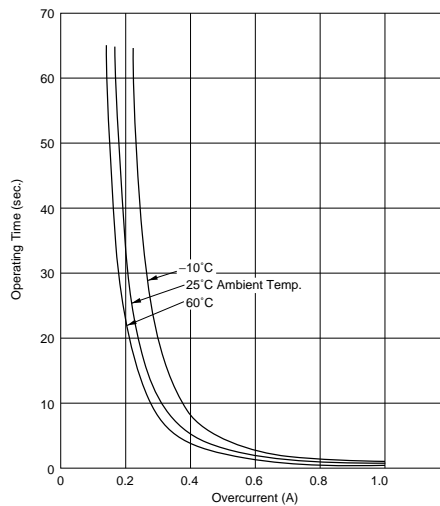

PTGL09AR9R4H4B51B0

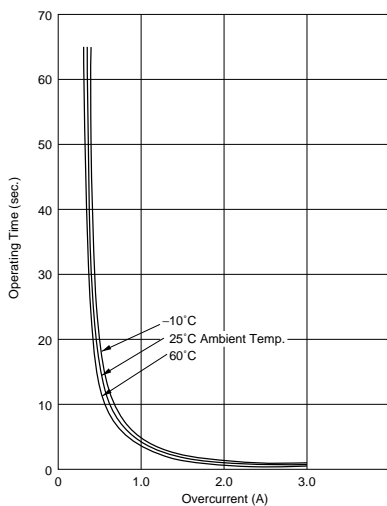

PTGL12AR5R6H4B71B0

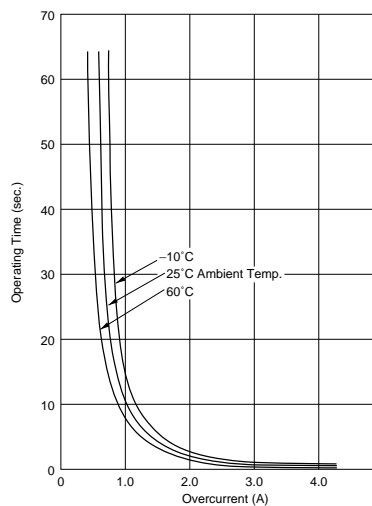

6

Continued on the following page.

Continued from the preceding page.

## Operating Time 80V Series (Typical Curve)

PTGL13AR3R7H4B71B0

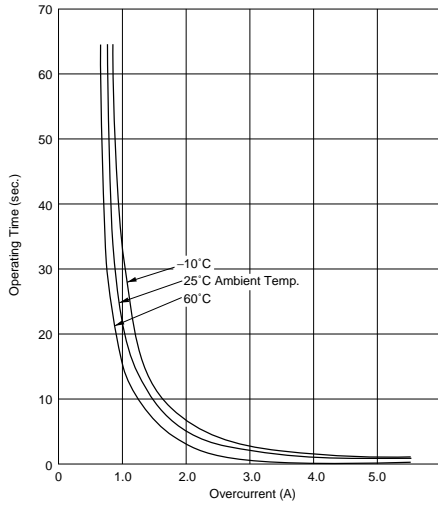

## 6

### Application Circuit

(1) DC Motor Protection Circuit

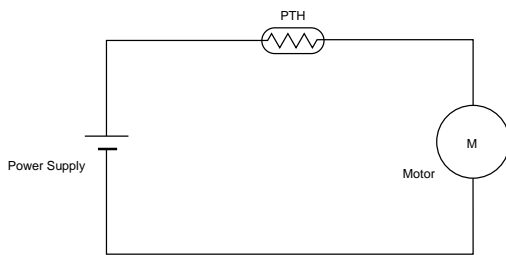

(2) Transistor Protection Circuit

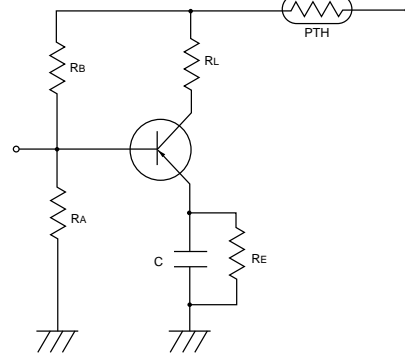

(3) Transformer Protection Circuit

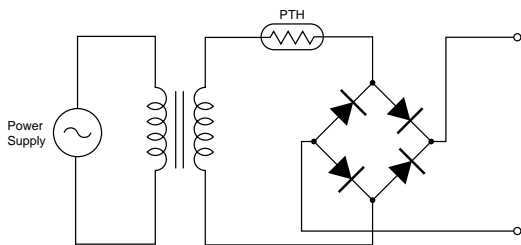

# POSISTOR<sup>®</sup> for Circuit Protection



## For Overcurrent Protection 125/140V Series

"POSISTOR" is a circuit protector whose resistance value in normal operation is very low and in abnormal situations like overcurrent or overheating, will be increased to restrain overcurrent. "POSISTOR" can be used for overcurrent protection against current fuse or temperature fuse, due to its ability to return to its initial condition when overcurrent is removed.

### ■ Features

1. Best suited to meet the requirements for power supply and motor protector. Error-free operations are assured by rush current.
2. Circuit is protected until current is turned off.
3. Restores the original low resistance value automatically once the overload is removed.
4. Non-contact design leads to long life and no noise. Durable and strong against mechanical vibration and shock because it is a solid element.

### ■ Applications

Circuit Protection:

1. Transformers
2. Transistors
3. Fluorescent Lamps

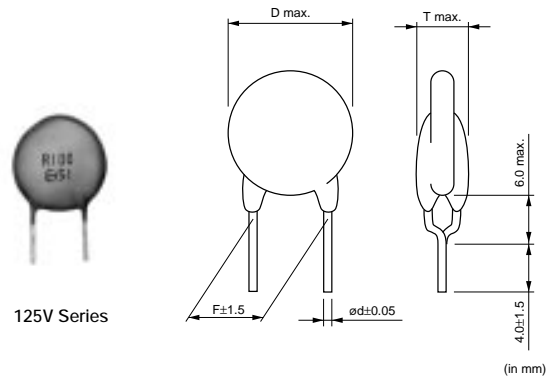

125V Series

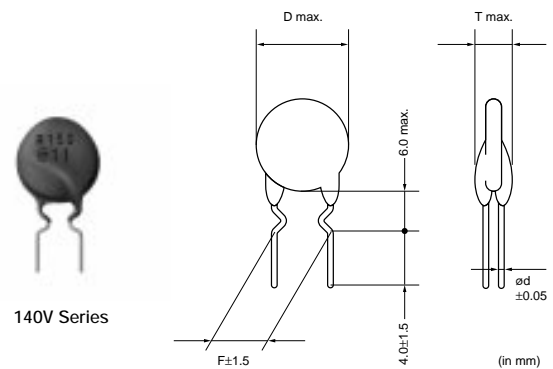

140V Series

7

Part Number	Max. Voltage (V)	Non-operating Current (at +60°C)(mA)	Trip Current (at -10°C) (mA)	Max. Current (A)	Resistance (at 25°C) (ohm)	Body Diameter (D) (mm)	Thickness (T) (mm)	Lead Space (F) (mm)	Lead Diameter (phi d)(mm)
PTGL05AR181M7P52B0	125	30	75	0.3	180 ±20%	6.0	5.0	5.0	0.6
PTGL07AR750M7B52B0	125	65	165	0.3	75 ±20%	8.0	6.0	5.0	0.6
PTGL09AR470M6B52B0	125	90	230	0.5	47 ±20%	10.0	5.5	5.0	0.6
PTGL09AR220M6B52B0	125	135	340	0.8	22 ±20%	10.0	5.5	5.0	0.6
PTGL12AR150M6B72B0	125	175	440	1.0	15 ±20%	12.5	5.5	7.5	0.6
PTGL14AR100M6B72B0	125	220	550	1.2	10 ±20%	15.0	5.5	7.5	0.6
PTGL18AR6R8M6B72B0	125	300	750	1.4	6.8 ±20%	18.5	5.5	7.5	0.6
PTGL18AR4R7M6B72B0	125	360	900	1.7	4.7 ±20%	18.5	5.5	7.5	0.6
PTGL18AR3R3M6B72B0	125	420	1050	2.0	3.3 ±20%	18.5	5.5	7.5	0.6
PTGL07AR330M6A51B0	140	100	230	0.5	33 ±20%	7.4	6.0	5.0	0.5
PTGL09AR220M6C61B0	140	140	330	1.0	22 ±20%	9.6	6.0	6.5	0.65
PTGL10AR150M6C61B0	140	170	400	1.0	15 ±20%	11.6	6.0	6.5	0.65
PTGL12AR100M6C01B0	140	220	510	1.0	10 ±20%	13.0	6.0	10.0	0.65
PTGL13AR6R8M6C01B0	140	290	670	1.0	6.8 ±20%	14.0	6.0	10.0	0.65
PTGL16AR5R6M6C01B0	140	340	780	2.0	5.6 ±20%	17.0	6.0	10.0	0.65

Maximum Current shows typical capacities of the transformer which can be used.  
 Please contact us for UL recognized products.  
 PTGL\_52B0 series are available in taping type.

## ■ Protective Threshold Current Range (125V Series)

PTGL05AR181M7P52B0

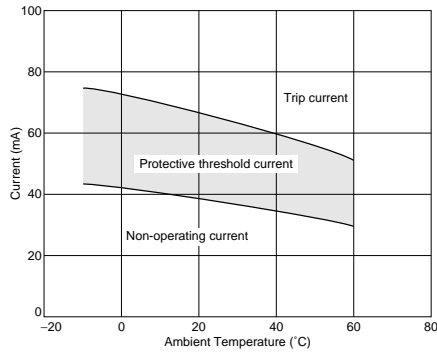

PTGL07AR750M7B52B0

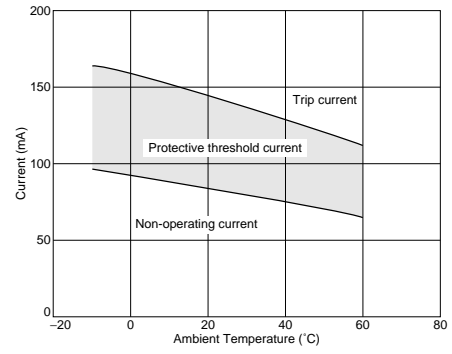

PTGL09AR470M6B52B0

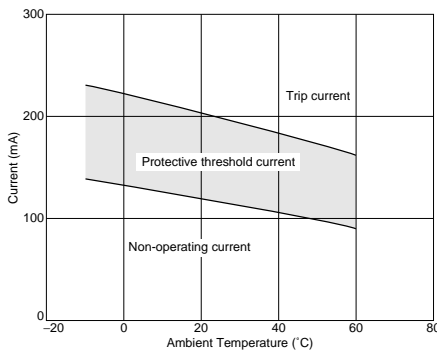

PTGL09AR220M6B52B0

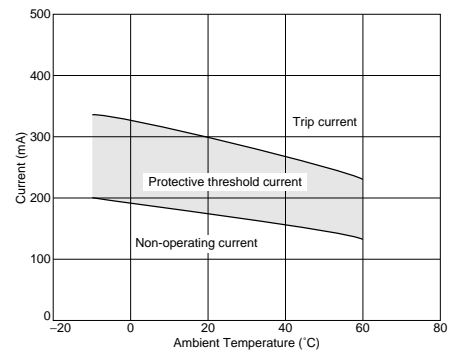

PTGL12AR150M6B72B0

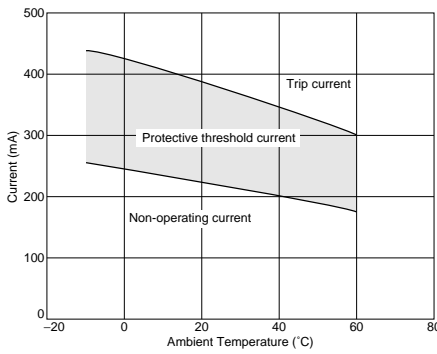

PTGL14AR100M6B72B0

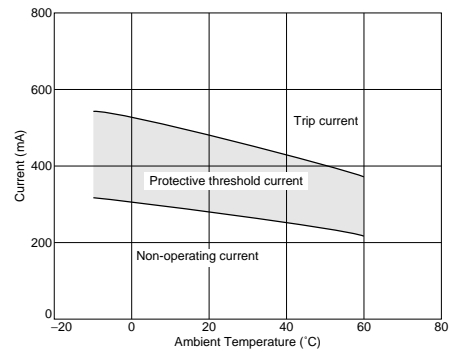

PTGL18AR6R8M6B72B0

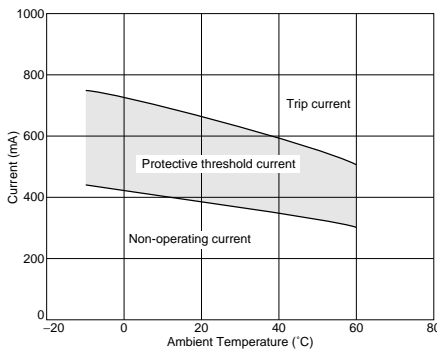

PTGL18AR4R7M6B72B0

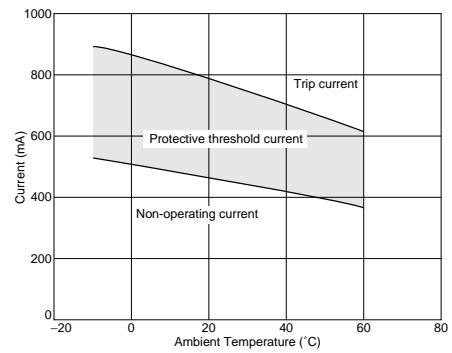

Continued from the preceding page.

■ Protective Threshold Current Range (125V Series)

PTGL18AR3R3M6B72B0

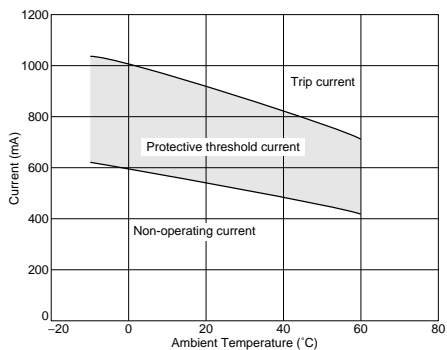

■ Protective Threshold Current Range (140V Series)

PTGL07AR330M6A51B0

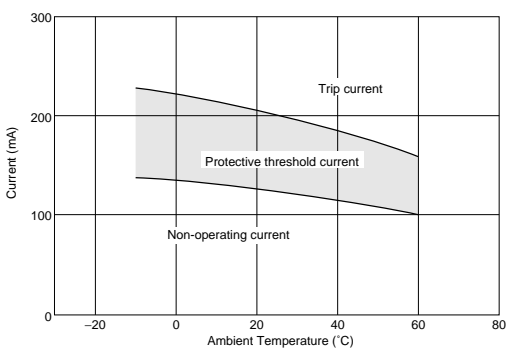

PTGL09AR220M6C61B0

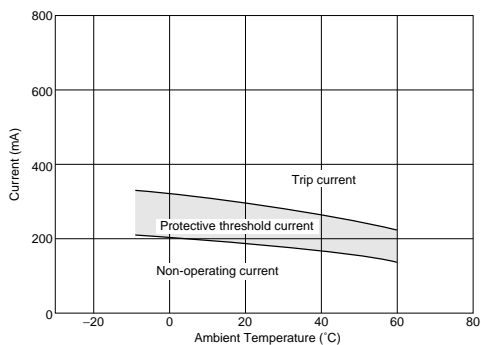

7

PTGL10AR150M6C61B0

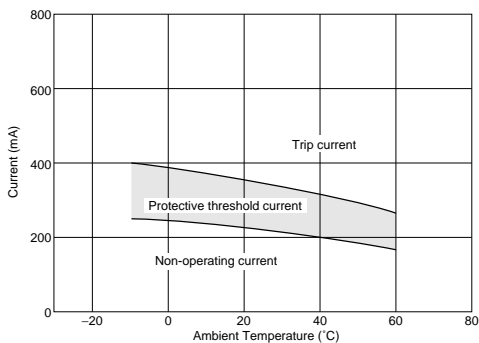

PTGL12AR100M6C01B0

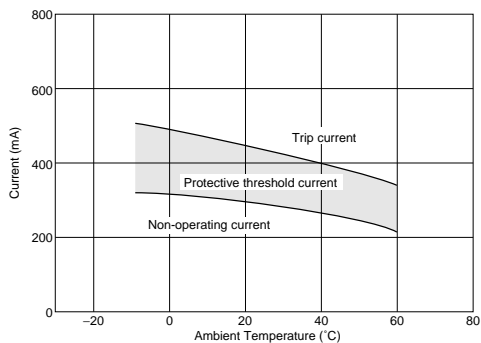

PTGL13AR6R8M6C01B0

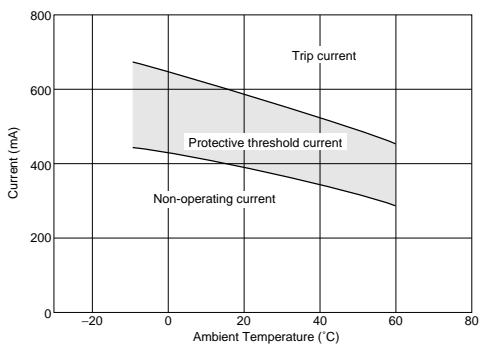

PTGL16AR5R6M6C01B0

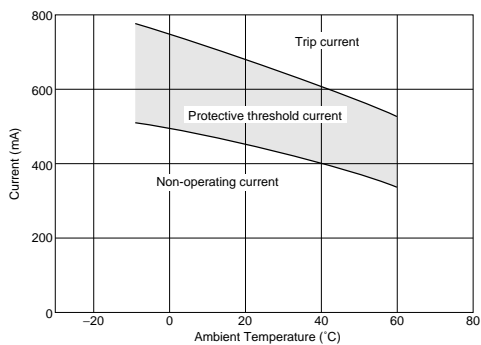

■ Operating Time 125V Series (Typical Curve)

PTGL05AR181M7P52B0

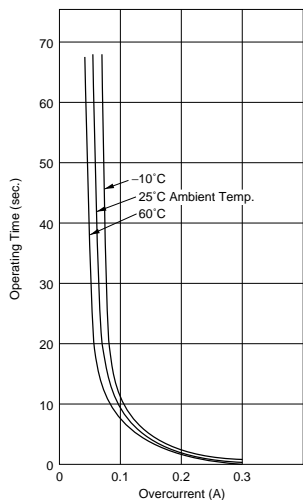

PTGL07AR750M7B52B0

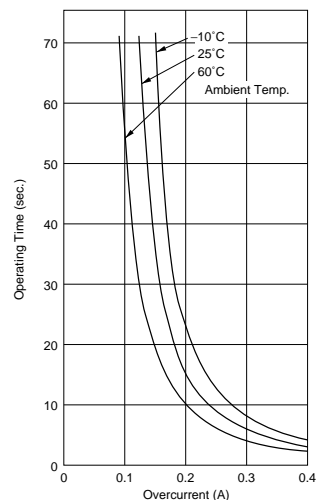

PTGL09AR470M6B52B0

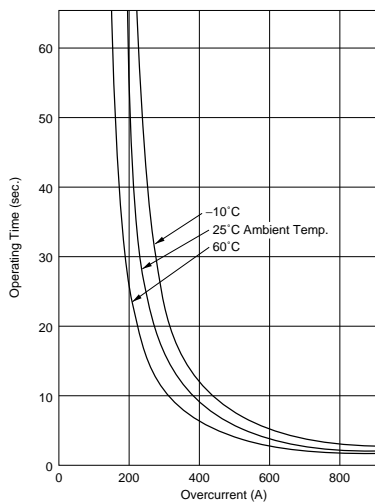

PTGL09AR220M6B52B0

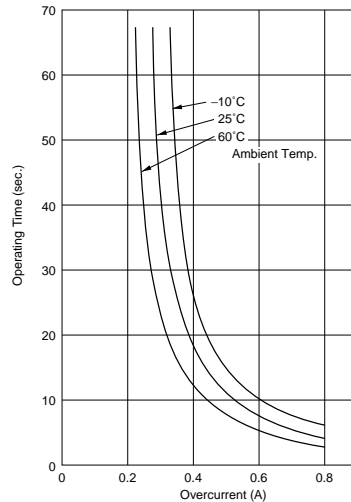

PTGL12AR150M6B72B0

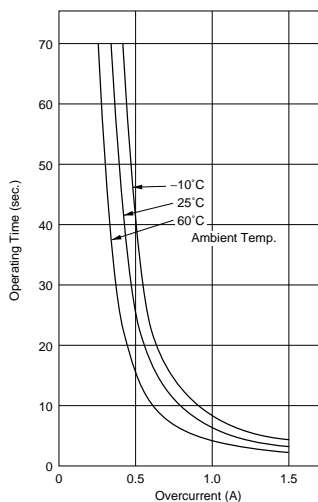

PTGL14AR100M6B72B0

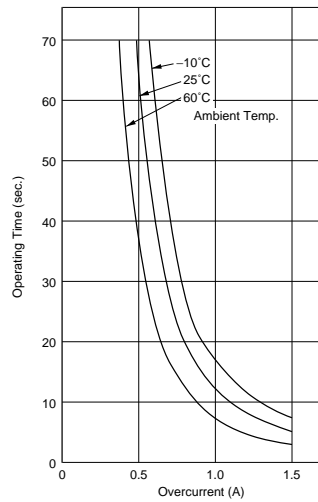

7

Continued from the preceding page.

### ■ Operating Time 125V Series (Typical Curve)

PTGL18AR6R8M6B72B0

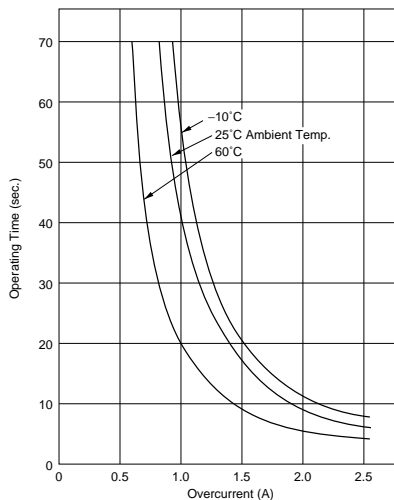

PTGL18AR4R7M6B72B0

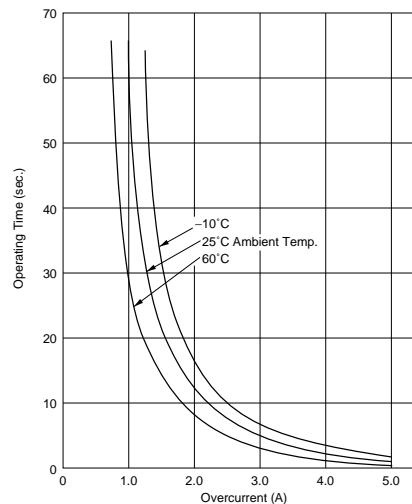

PTGL18AR3R3M6B72B0

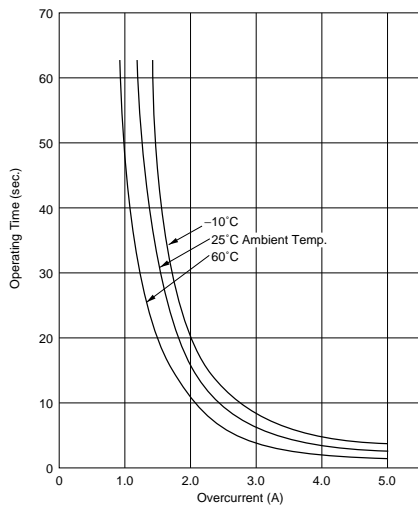

7

### ■ Operating Time 140V Series (Typical Curve)

PTGL07AR330M6A51B0

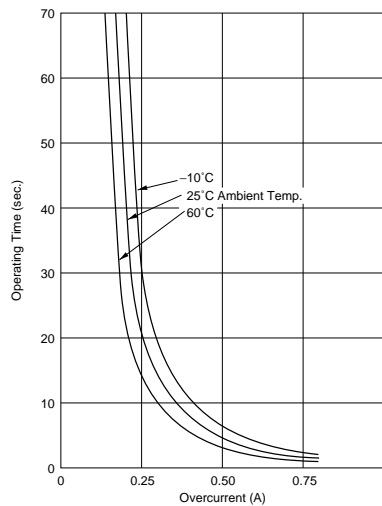

PTGL09AR220M6C61B0

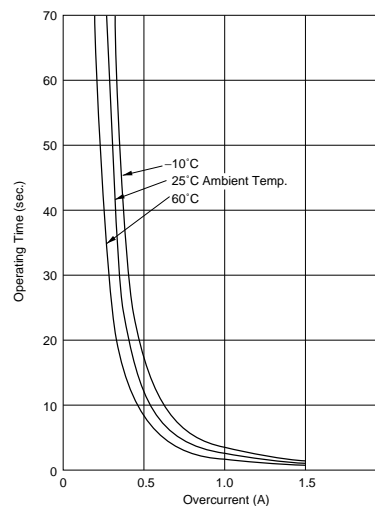

Continued on the following page.



Continued from the preceding page.

■ Operating Time 140V Series (Typical Curve)

PTGL10AR150M6C61B0

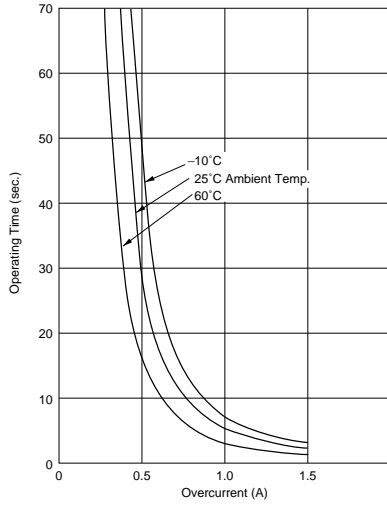

PTGL12AR100M6C01B0

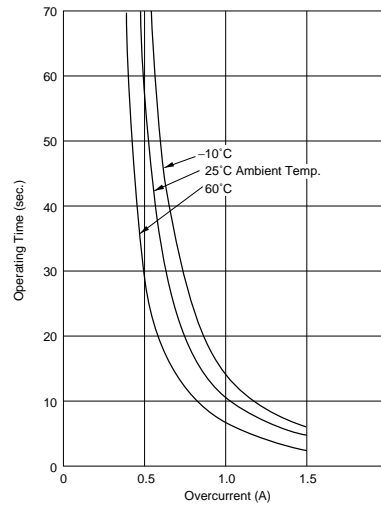

PTGL13AR6R8M6C01B0

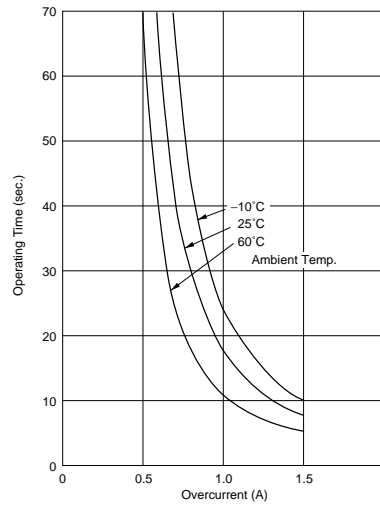

PTGL16AR5R6M6C01B0

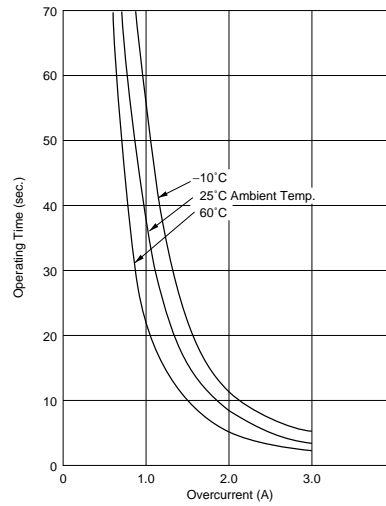

## Application Circuit

(1) Transformer Protection Circuit 1

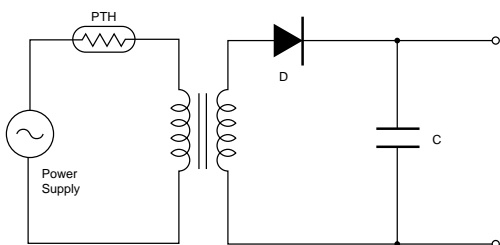

(2) Transformer Protection Circuit 2

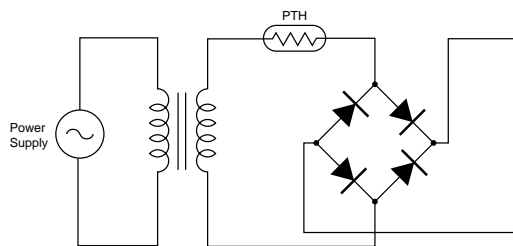

(3) Transistor Protection Circuit

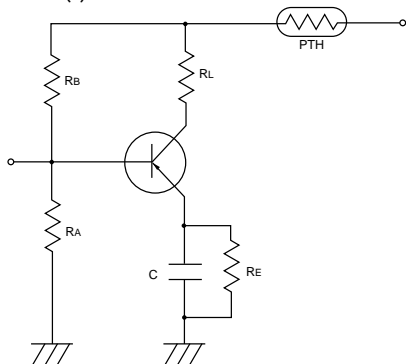

(4) Fluorescent Lamp Protection Circuit

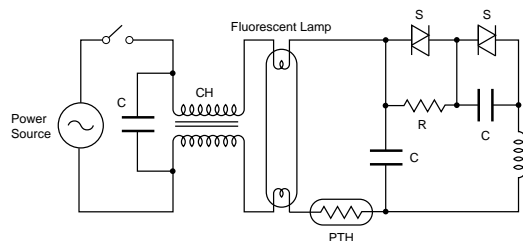

7

# POSISTOR<sup>®</sup> for Circuit Protection



## For Overcurrent Protection 250/265V Series

"POSISTOR" is a circuit protector whose resistance value in normal operation is very low and in abnormal situations like overcurrent or overheating, will be increased to restrain overcurrent. "POSISTOR" can be used for overcurrent protection against current fuse or temperature fuse, due to its ability to return to its initial condition when overcurrent is removed.

### ■ Features

1. Best suited to meet the requirements for power supply and motor protector. Error-free operations are assured by rush current.
2. Circuit is protected until current is turned off.
3. Restores the original low resistance value automatically once the overload is removed.
4. Non-contact design leads to long life and no noise. Durable and strong against mechanical vibration and shock because it is a solid element.

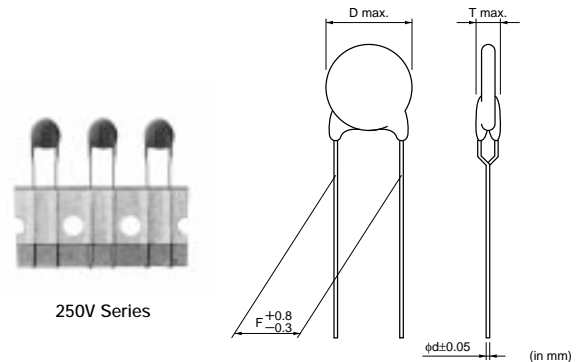

250V Series



265V Series (PTGL\_1B0)



265V Series (PTGL\_2B0)

Part Number	Max. Voltage (V)	Non-operating Current (at +60°C)(mA)	Trip Current (at -10°C) (mA)	Max. Current (A)	Resistance (at 25°C) (ohm)	Body Diameter (D) (mm)	Thickness (T) (mm)	Lead Space (F) (mm)	Lead Diameter (phi d)(mm)
PTGL07BB220N0B52A0	250	90	300	0.5	22 ±30%	8.0	6.0	5.0	0.6
PTGL10BB120N0P52A0	250	90	300	0.6	12 ±30%	11.0	6.0	5.0	0.6
PTGL09AR390N0B52A0	250	100	280	0.6	39 ±30%	10.0	6.0	5.0	0.6
PTGL05AR151H8P52B0	265	28	78	0.2	150 ±25%	6.0	6.0	5.0	0.6
PTGL05AR181M9N51B0	265	29	70	0.3	180 ±20%	6.5	6.5	5.0	0.5
PTGL05AR121M9N51B0	265	35	85	0.3	120 ±20%	6.5	6.5	5.0	0.5
PTGL07AR820M9A51B0	265	60	150	0.5	82 ±20%	8.2	6.5	5.0	0.5
PTGL07AR700H8B52B0	265	66	185	0.4	70 ±25%	8.0	6.0	5.0	0.6
PTGL07AR650H8B52B0	265	68	190	1.0	65 ±25%	8.0	6.0	5.0	0.6
PTGL07AR450H8B52B0	265	80	220	1.0	45 ±25%	8.0	6.0	5.0	0.6
PTGL07AR560M9A51B0	265	80	190	0.8	56 ±20%	8.2	6.5	5.0	0.5
PTGL09AR390M9C61B0	265	100	240	1.2	39 ±20%	10.0	6.5	6.5	0.65

Continued on the following page.

Continued from the preceding page.

Part Number	Max. Voltage (V)	Non-operating Current (at +60°C)(mA)	Trip Current (at -10°C) (mA)	Max. Current (A)	Resistance (at 25°C) (ohm)	Body Diameter (D) (mm)	Thickness (T) (mm)	Lead Space (F) (mm)	Lead Diameter (phi d)(mm)
PTGL09AR250H8B52B0	265	118	330	1.0	25 ±25%	10.0	6.0	5.0	0.6
PTGL12AR270M9C01B0	265	150	360	1.5	27 ±20%	14.0	6.5	10.0	0.65
PTGL12AR150H8B72B0	265	165	460	1.5	15 ±25%	12.5	6.0	7.5	0.6
PTGL14AR180M9C01B0	265	180	440	1.8	18 ±20%	15.7	6.5	10.0	0.65
PTGL13AR100H8B72B0	265	200	560	2.2	10 ±25%	14.0	6.0	7.5	0.6
PTGL18AR6R0H8B72B0	265	300	830	4.1	6.0 ±25%	18.5	6.0	7.5	0.6

Maximum Current shows typical capacities of the transformer which can be used.  
 Please contact us for UL recognized products.  
 PTGL\_5\*B0 series are available in taping type.

### Protective Threshold Current Range (250V Series)

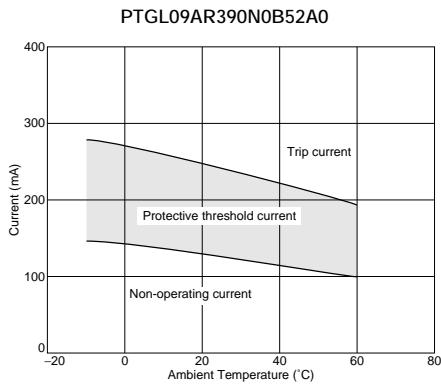
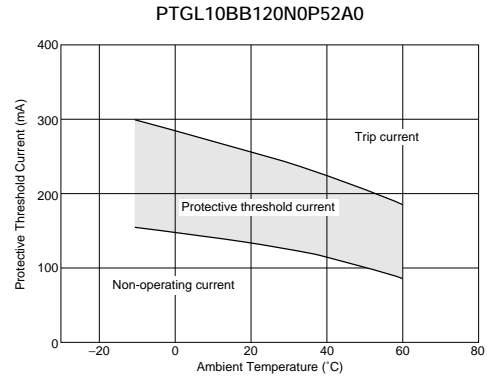
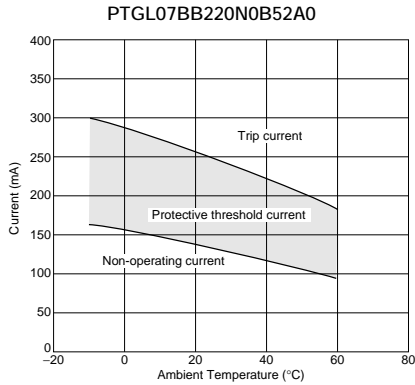

### Protective Threshold Current Range (265V Series)

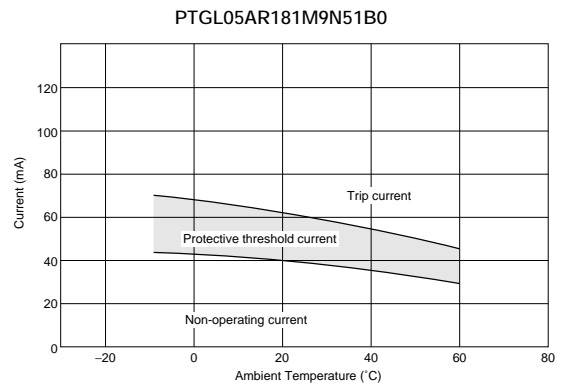
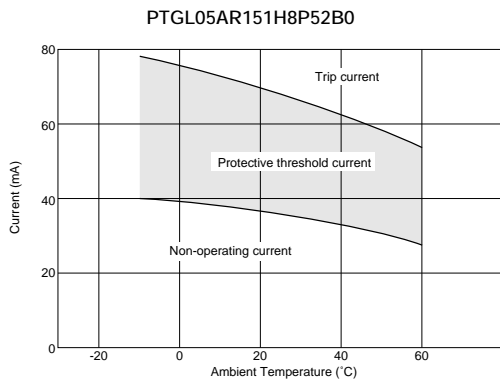

Continued on the following page. ↗

Continued from the preceding page.

■ Protective Threshold Current Range (265V Series)

PTGL05AR121M9N51B0

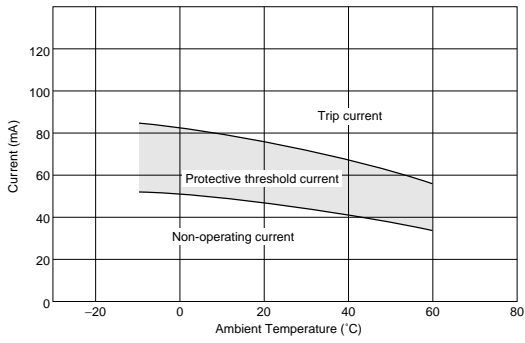

PTGL07AR820M9A51B0

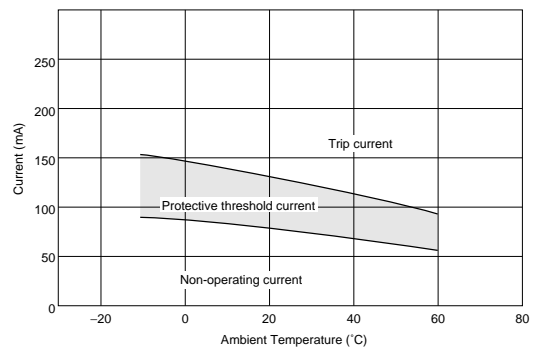

PTGL07AR700H8B52B0

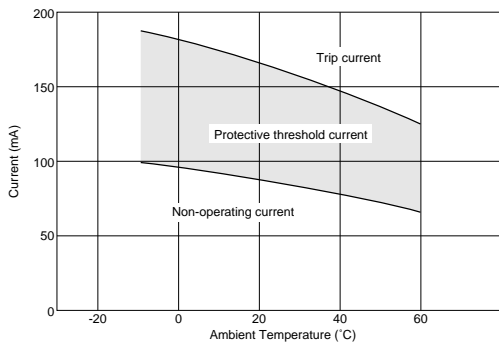

PTGL07AR650H8B52B0

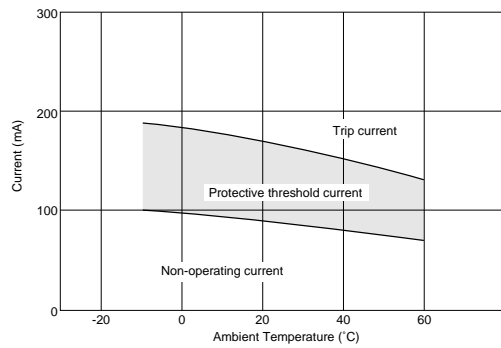

PTGL07AR450H8B52B0

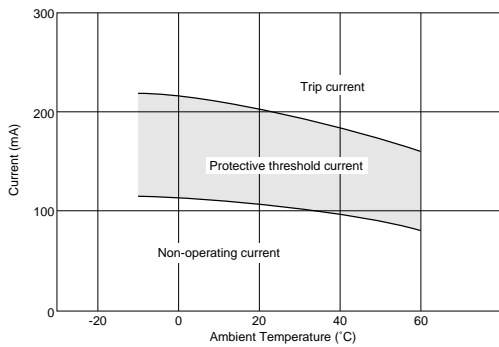

PTGL07AR560M9A51B0

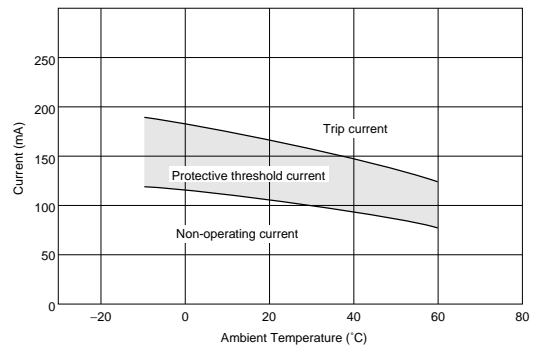

PTGL09AR390M9C61B0

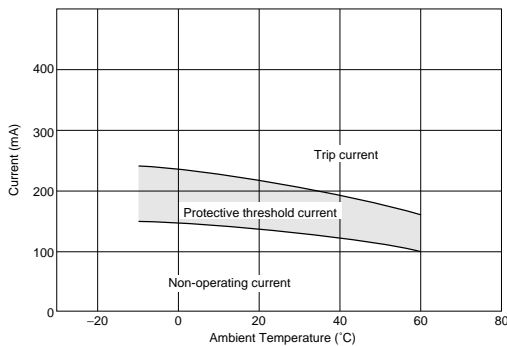

PTGL09AR250H8B52B0

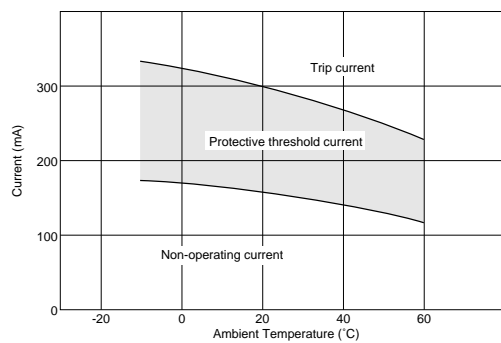

Continued from the preceding page.

■ Protective Threshold Current Range (265V Series)

PTGL12AR270M9C01B0

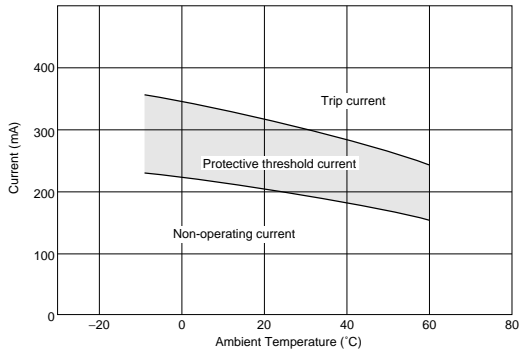

PTGL12AR150H8B72B0

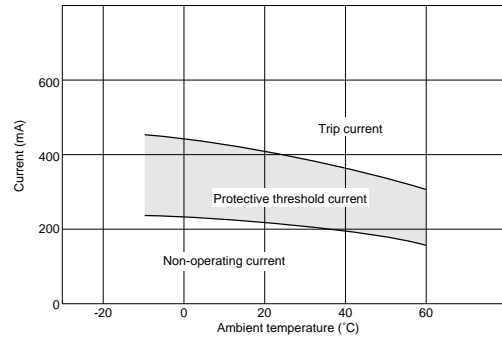

PTGL14AR180M9C01B0

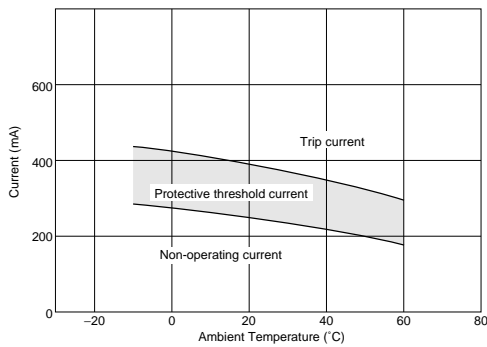

PTGL13AR100H8B72B0

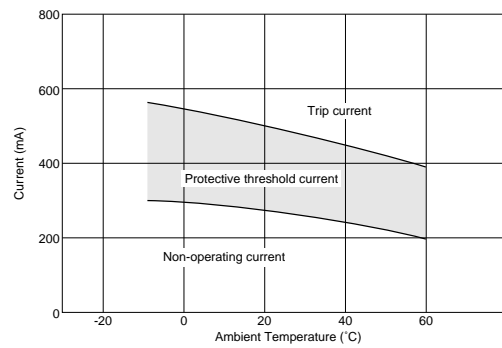

PTGL18AR6R0H8B72B0

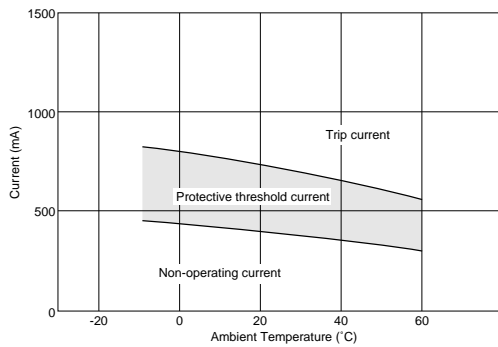

■ Operating Time 250V Series (Typical Curve)

PTGL07BB220N0B52A0

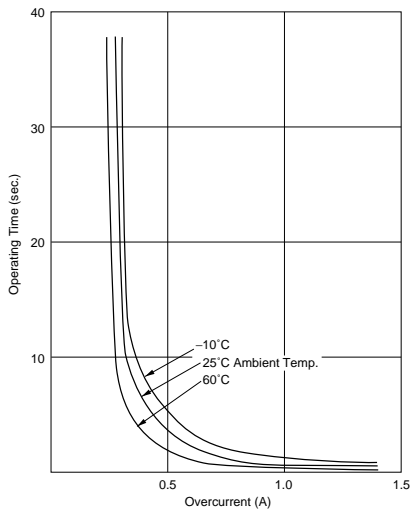

PTGL10BB120N0P52A0

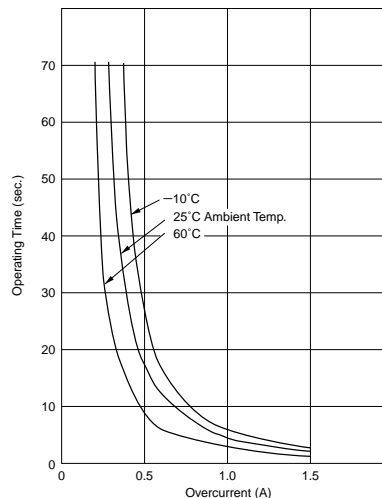

PTGL09AR390N0B52A0

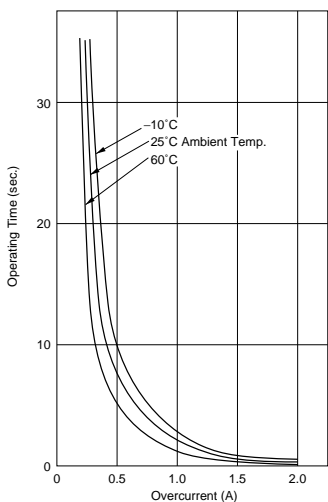

8

■ Operating Time 265V Series (Typical Curve)

PTGL05AR151H8P52B0

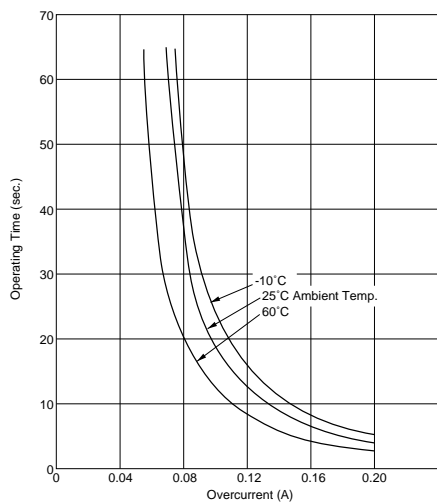

PTGL05AR181M9N51B0

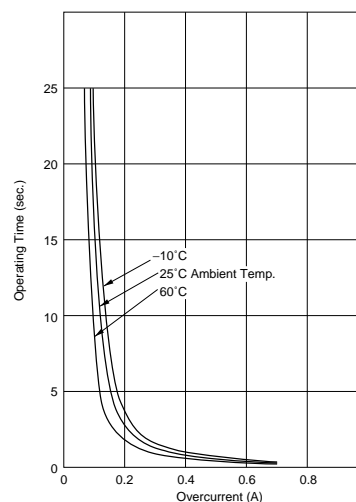

Continued on the following page. ↗

Continued from the preceding page.

### Operating Time 265V Series (Typical Curve)

PTGL05AR121M9N51B0

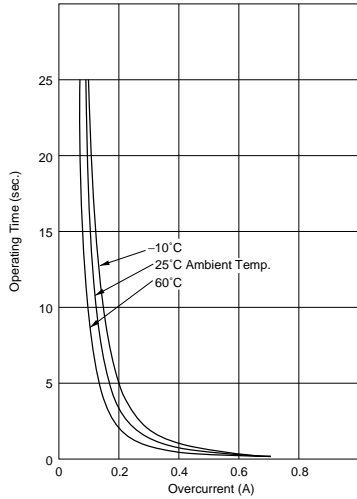

PTGL07AR820M9A51B0

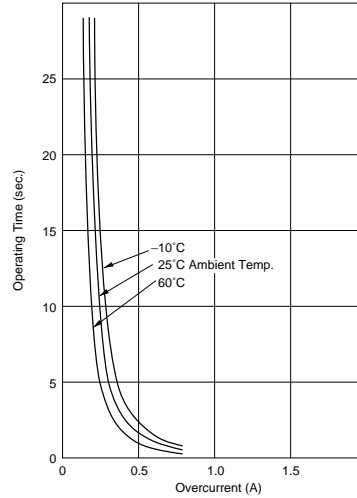

PTGL07AR700H8B52B0

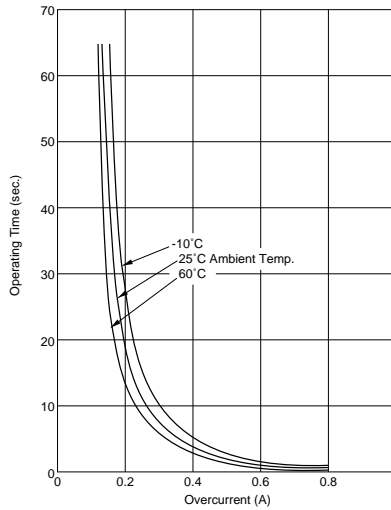

PTGL07AR650H8B52B0

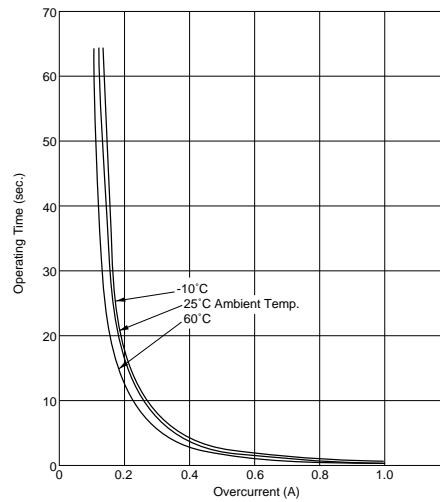

PTGL07AR450H8B52B0

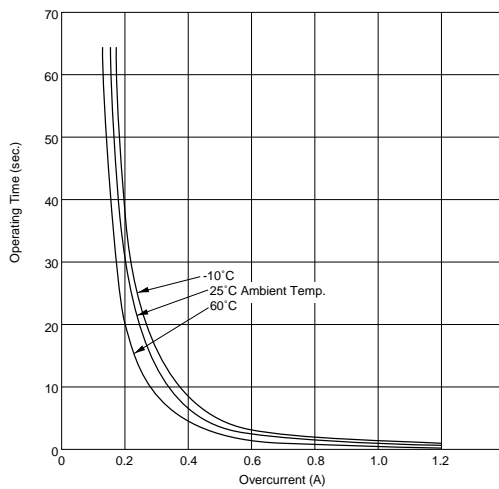

PTGL07AR560M9A51B0

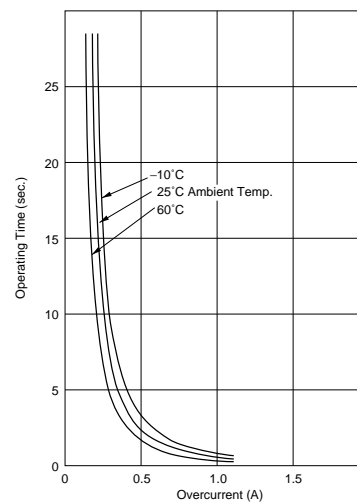



Continued from the preceding page.

Operating Time 265V Series (Typical Curve)

PTGL09AR390M9C61B0

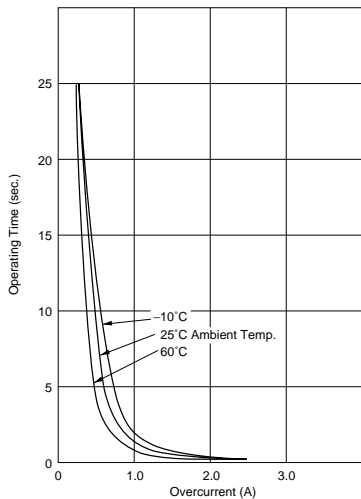

PTGL09AR250H8B52B0

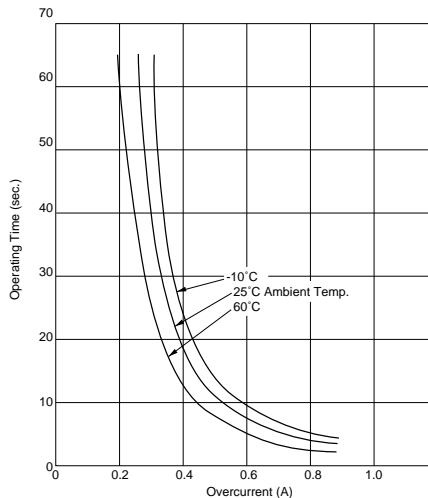

PTGL12AR270M9C01B0

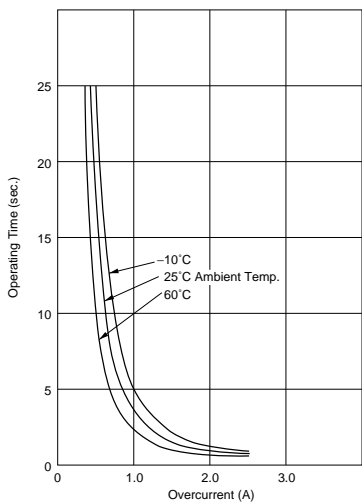

PTGL12AR150H8B72B0

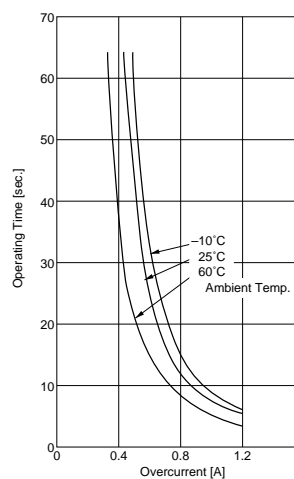

PTGL14AR180M9C01B0

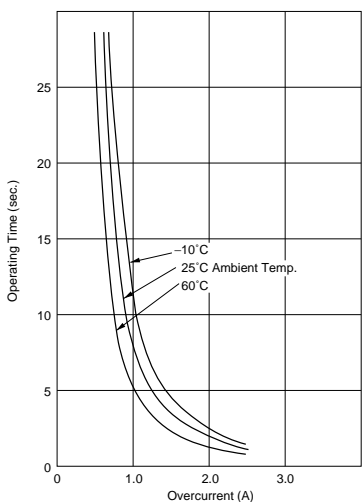

PTGL13AR100H8B72B0

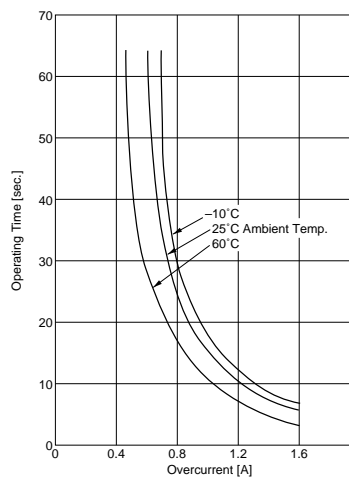

Continued from the preceding page.

### Operating Time 265V Series (Typical Curve)

PTGL18AR6R0H8B72B0

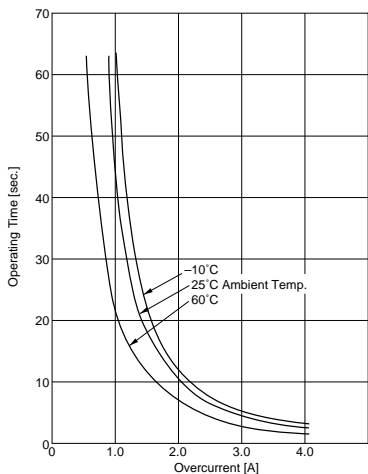

### Application Circuit

(1) Transistor Protection Circuit

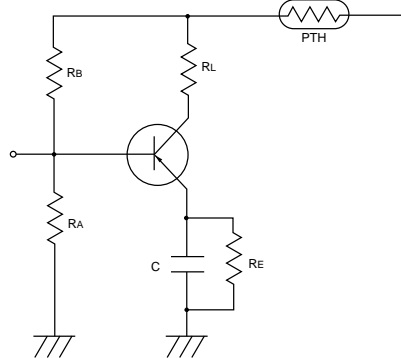

(2) Transformer Protection Circuit 1

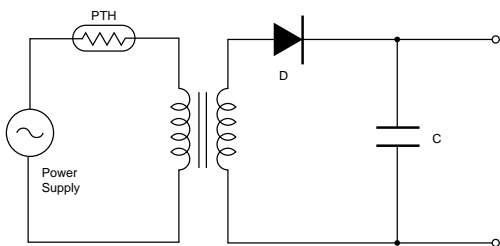

(3) Transformer Protection Circuit 2

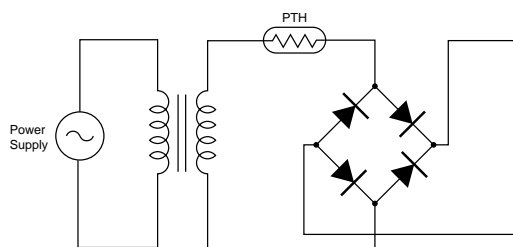

(4) Fluorescent Lamp Protection Circuit

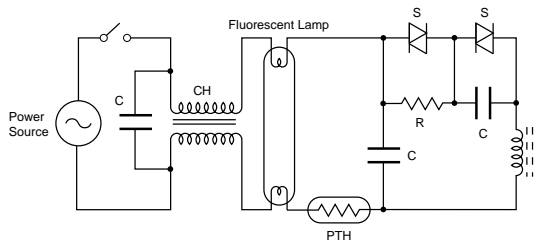

(5) Telecommunication Circuit

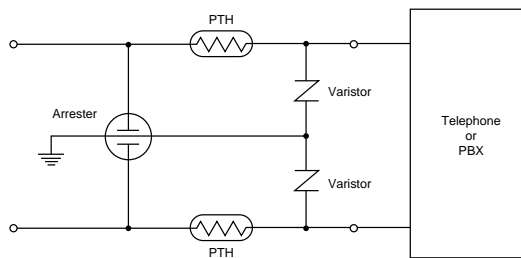

## PTGL Series Narrow Current Band Specifications and Test Methods

No.	Item	Rating Value	Method of Examination						
1	Operating Temperature	-30 to +85°C	The temperature range with maximum voltage applied to the POSISTOR®.						
2	Storage Temperature	-40 to +125°C	The temperature range with zero voltage.						
3	Resistance Value (at 25°C)	Satisfies ratings	Resistance value is measured by applying voltage under 1.0Vdc (by a direct current of less than 10mA) at 25°C. (But it must be measured after maximum voltage is applied for 180 seconds and then is left for 2 hours at 25°C.)						
4	Withstanding Voltage	No problem	We apply AC voltage 120% that of the maximum voltage to POSISTOR® by raising voltage gradually for 180±5 seconds at 25°C. (A protective resistor is to be connected in series, and the inrush current through POSISTOR® must be limited below maximum rated value.)						
5	Protective Threshold Current	Satisfies ratings (Trip Current, Non-operating Current)	Maximum current measured in this examination. Voltage is applied to POSISTOR® in 3 minutes step by step on still air based on "Protective Threshold Current Test Conditions" shown in next page. Stable current is measured at each step.						
6	Tensile Strength of Lead Wire Terminal	No damage	The load is gradually applied to each terminal of POSISTOR® until the force of the following table in the axial direction with fixing POSISTOR®'s body itself and this load is kept for 10 seconds. <table border="1" style="margin-left: auto; margin-right: auto;"> <thead> <tr> <th>Lead Diameter</th> <th>Force</th> </tr> </thead> <tbody> <tr> <td>ø0.60mm max.</td> <td>4.90N</td> </tr> <tr> <td>ø0.65mm min.</td> <td>9.80N</td> </tr> </tbody> </table>	Lead Diameter	Force	ø0.60mm max.	4.90N	ø0.65mm min.	9.80N
Lead Diameter	Force								
ø0.60mm max.	4.90N								
ø0.65mm min.	9.80N								
7	Bending Strength of Lead Wire Terminal	Lead wire does not come off	POSISTOR® is held so that it is perpendicular to the lead wire with the following lead hanging in the axial direction of the lead wire. The lead wire is slowly bent toward 90° and returned. Then it is slowly bent in the opposite direction and returned to original state. <table border="1" style="margin-left: auto; margin-right: auto;"> <thead> <tr> <th>Lead Diameter</th> <th>Force</th> </tr> </thead> <tbody> <tr> <td>ø0.60mm max.</td> <td>2.45N</td> </tr> <tr> <td>ø0.65mm min.</td> <td>4.90N</td> </tr> </tbody> </table>	Lead Diameter	Force	ø0.60mm max.	2.45N	ø0.65mm min.	4.90N
Lead Diameter	Force								
ø0.60mm max.	2.45N								
ø0.65mm min.	4.90N								
8	Solderability	Solder is applied around the lead wire covering 3/4 or more of the circumference without gap in the axial direction.	The Lead wire of POSISTOR® is soaked in an Isopropyl Alcohol (JIS K 8839) solution (about 25wt%) of colophony (JIS K 5902) for 5-10 sec. Each lead wire is soaked in Molten solder (JIS Z 3282 H60A) at 235±5°C from the bottom to a point of 2.0-2.5mm for 2±0.5 seconds.						
9	Terminal Durability of Soldering	$\Delta R/R_{25} \leq \pm 15\%$	The lead wire of POSISTOR® is soaked in Molten solder (JIS Z 3282 H60A) at 350±10°C from the bottom to a point of 2.0-2.5mm for 3.5±0.5 seconds. After the device is left at room temperature (25°C) for 24±4 hours, the resistance is then measured.						
10	Humidity Test	$\Delta R/R_{25} \leq \pm 20\%$	POSISTOR® is set in an environmental chamber at 60±2°C and 90-95% humidity for 500±4 hours. After the device is left at room temperature (25°C) for one hour, the resistance measurement is then performed.						
11	Load Test at High Temperature	$\Delta R/R_{25} \leq \pm 20\%$	POSISTOR® is set in an environmental chamber at 85±3°C with maximum voltage applied for 500±4 hours. After the device is left at room temperature (25°C) for one hour, the resistance measurement is performed. (A protective resistor is to be connected in series and the inrush current through POSISTOR® must be limited below maximum rated value.)						
12	Load Cycle Test at Room Temperature	$\Delta R/R_{25} \leq \pm 20\%$	POSISTOR® is set in a room temperature at 25±2°C with maximum voltage applied for 1 minute and then is left without voltage applied for 5 minutes. This cycle is repeated for 100 cycles, and after the device is left at room temperature (25°C) for one hour, the resistance measurement is performed. (A protective resistor is to be connected in series and the inrush current through POSISTOR® must be limited below maximum rated value.)						

Continued on the following page.

## PTGL Series Narrow Current Band Specifications and Test Methods

☒ Continued from the preceding page.

### ■ Protective Threshold Current Test Conditions

#### 1. Substrate

Materials: Phenol

Size: 50x50x1.6mm

Land Pattern: Cu land without through hole

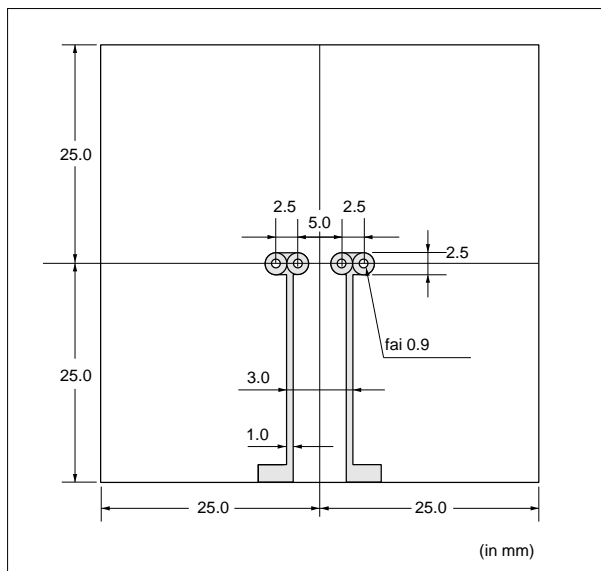

#### 2. Measurement condition

Solder POSISTOR® on the substrate, then put the cover (150mm cubed) surround POSISTOR® to prevent flow of wind.

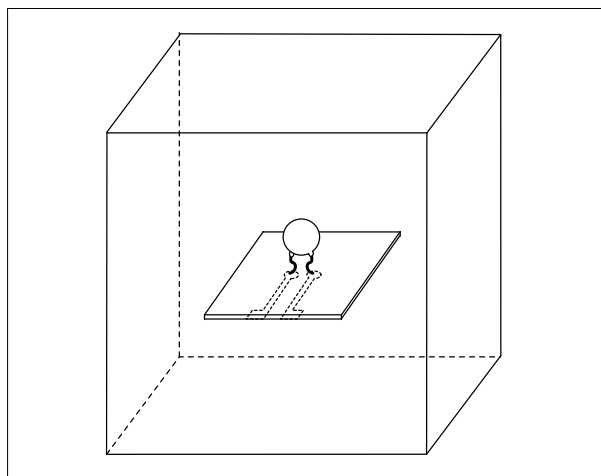

#### 3. Measurement circuit

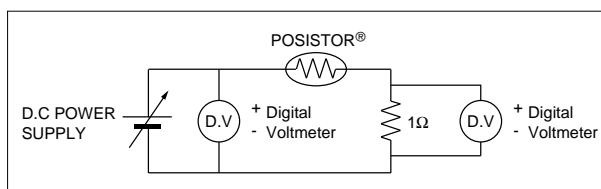

## PTGL Series Specifications and Test Methods

Item	Rating Value	Method of Examination						
Continuous Operating Temperature	-10 to +60 °C	The temperature range with maximum voltage applied to the POSISTOR®.						
Resistance Value (at 25°C)	Satisfies ratings	Resistance value is measured by applying voltage under 1.5Vdc (by a direct current of less than 10mA) at 25°C. (But it must be measured after maximum voltage is applied for 180 seconds and then is left for 2 hours at 25°C.)						
Withstanding Voltage	No problem	We apply AC voltage 120% that of the maximum voltage to POSISTOR® by raising voltage gradually for 180±5 seconds at 25°C. (A protective resistor is to be connected in series, and the inrush current through POSISTOR® must be limited below max. rated value.)						
Tensile Strength of Lead Wire Terminal	No damage	The load is gradually applied to each terminal of POSISTOR® until the force of the following table in the axial direction with fixing POSISTOR®'s body itself and this load is being kept for 10 seconds. <table border="1" style="margin-left: auto; margin-right: auto;"> <thead> <tr> <th>Lead Diameter</th> <th>Force</th> </tr> </thead> <tbody> <tr> <td>ø0.60mm max.</td> <td>4.90N</td> </tr> <tr> <td>ø0.65mm min.</td> <td>9.80N</td> </tr> </tbody> </table>	Lead Diameter	Force	ø0.60mm max.	4.90N	ø0.65mm min.	9.80N
Lead Diameter	Force							
ø0.60mm max.	4.90N							
ø0.65mm min.	9.80N							
Bending Strength of Lead Wire Terminal	Lead wire does not come off.	POSISTOR® is held so that it is perpendicular to the lead wire with the following lead hanging in the axial direction of the lead wire. The lead wire is slowly bent toward 90° and returned. Then it is slowly bent in the opposite direction and returned to original state. <table border="1" style="margin-left: auto; margin-right: auto;"> <thead> <tr> <th>Lead Diameter</th> <th>Force</th> </tr> </thead> <tbody> <tr> <td>ø0.60mm max.</td> <td>2.45N</td> </tr> <tr> <td>ø0.65mm min.</td> <td>4.90N</td> </tr> </tbody> </table>	Lead Diameter	Force	ø0.60mm max.	2.45N	ø0.65mm min.	4.90N
Lead Diameter	Force							
ø0.60mm max.	2.45N							
ø0.65mm min.	4.90N							
Solderability	Solder is applied around the lead wire covering 3/4 or more of the circumference without gap in the axial direction.	The Lead wire of POSISTOR® is soaked in an Isopropyl alcohol (JIS K 8839) or ethanol (JIS K 8101) solution (about 25wt%) of colophony (JIS K 5902) for 5 to 10 sec. And, each lead wire is soaked in Molten solder (JIS Z 3282 H60A) at 235±5°C from the bottom to a point of 2.0 to 2.5mm for 2±0.5 sec.						
Terminal Durability of Soldering	$\Delta R/R25 \leq \pm 15\%$	The lead wire of POSISTOR® is soaked in Molten solder (JIS Z 3282 H60A) at 350±10°C from the bottom to a point of 2.0 to 2.5mm for 3.5±0.5 sec. And, after the device is being left at room temperature (25°C) for 24±4 hours, the resistance is measured.						
Humidity Test	$\Delta R/R25 \leq \pm 20\%$	POSISTOR® is set in an environmental chamber at 40±2°C and 90 to 95% humidity for 500±4 hours. And after the device is being left at room temperature (25°C) for one hour, the resistance measurement is performed.						
Load Cycle Test at High Temperature	$\Delta R/R25 \leq \pm 20\%$	POSISTOR® is set in an environmental chamber at 60±3°C with maximum voltage applied for 1.5 hours and then is left without voltage applied for 0.5 hours. This cycle is repeated for 1000±10 hours, and after the device is left at room temperature (25°C) for one hour, the resistance measurement is performed. (A protective resistor is to be connected in series and the inrush current through POSISTOR® must be limited below max. rated value.)						

# POSISTOR<sup>®</sup> for Circuit Protection



## For Overheat Sensing Chip Type

This chip PTC Thermistor is reflow soldering SMD type for overheat sensing for power transistors, power diodes and power ICs in hybrid circuits.

### ■ Features

1. SMD type is helpful for miniaturizing circuits because of its small size and light weight.
2. Excellent thermal response due to small size
3. Solid-state construction provides excellent mechanical vibration and impact resistance.
4. Contactless operation provides noiseless operation.
5. Lead is not contained in the terminations.

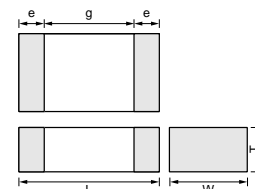

Part Number	Dimensions (mm)				
	L	W	T	e	g
PRF15_RC	1.0±0.05	0.5±0.05	0.5±0.05	0.15 to 0.4	0.3 min.
PRF18_RB	1.6±0.15	0.8±0.15	0.8±0.15	0.1 to 0.6	-
PRF21_RA	2.0±0.2	1.25±0.2	0.9±0.2	0.2 min.	0.5 min.

### Chip Type 0402 (1005) Size

Part Number	Sensing Temperature (at 4.7k ohm) (°C)	Maximum Voltage (V)	Resistance (at 25°C) (ohm)	Temperature Range (°C)
PRF15BC471QB1RC	105 ±5°C	32	470 ±50%	-20 to 120
PRF15BB471QB1RC	115 ±5°C	32	470 ±50%	-20 to 130
PRF15BA471QB1RC	125 ±5°C	32	470 ±50%	-20 to 140

This product is applied to reflow soldering.

### Chip Type 0603 (1608) Size

Part Number	Sensing Temperature (at 4.7k ohm) (°C)	Maximum Voltage (V)	Resistance (at 25°C) (ohm)	Temperature Range (°C)
PRF18BG471QB1RB	65 ±5°C	32	470 ±50%	-20 to 80
PRF18BF471QB1RB	75 ±5°C	32	470 ±50%	-20 to 90
PRF18BE471QB1RB	85 ±5°C	32	470 ±50%	-20 to 100
PRF18BD471QB1RB	95 ±5°C	32	470 ±50%	-20 to 110
PRF18BC471QB1RB	105 ±5°C	32	470 ±50%	-20 to 120
PRF18BB471QB1RB	115 ±5°C	32	470 ±50%	-20 to 130
PRF18BA471QB1RB	125 ±5°C	32	470 ±50%	-20 to 140
PRF18AR471QB1RB	135 ±5°C	32	470 ±50%	-20 to 150
PRF18AS471QB1RB	145 ±5°C	32	470 ±50%	-20 to 160

This product is applied to reflow soldering. Please consult us for flow soldering usage.  
Please contact us for UL recognized products.

### Chip Type 0805 (2012) Size

Part Number	Sensing Temperature (at 4.7k ohm) (°C)	Maximum Voltage (V)	Resistance (at 25°C) (ohm)	Temperature Range (°C)
PRF21BE471QB1RA	85 ±5°C	32	470 ±50%	-20 to 100
PRF21BD471QB1RA	95 ±5°C	32	470 ±50%	-20 to 110
PRF21BC471QB1RA	105 ±5°C	32	470 ±50%	-20 to 120
PRF21BB471QB1RA	115 ±5°C	32	470 ±50%	-20 to 130
PRF21BA471QB1RA	125 ±5°C	32	470 ±50%	-20 to 140
PRF21AR471QB1RA	135 ±5°C	32	470 ±50%	-20 to 150
PRF21AS471QB1RA	145 ±5°C	32	470 ±50%	-20 to 160

This product is applied to reflow soldering. Please consult us for flow soldering usage.  
This product is recognized by UL.

# POSISTOR<sup>®</sup> for Circuit Protection



## For Overheat Sensing Chip Type Tight-tolerance Type

PRF18\_RB1RB series is an improvement on sensing accuracy from existing PRF18\_QB1RB series.

### ■ Features

1. Sensing accuracy +/-3 deg.C which is highest of PTC Thermistor and the same level as NTC at sensing point.
2. Same resistance-temperature characteristics as PRF18\_QB1RB series.  
Easy to use higher accurate sensing type.
3. SMD type is helpful for miniaturizing circuits because of its small size and light weight.
4. Excellent thermal response due to small size
5. Solid-state construction provides excellent mechanical vibration and impact resistance.
6. Contactless operation provides noiseless operation.
7. Lead is not contained in the terminations.

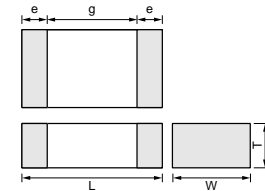

Part Number	Dimensions (mm)				
	L	W	T	e	g
PRF15_RC	1.0±0.05	0.5±0.05	0.5±0.05	0.15 to 0.4	0.3 min.
PRF18_RB	1.6±0.15	0.8±0.15	0.8±0.15	0.1 to 0.6	-
PRF21_RA	2.0±0.2	1.25±0.2	0.9±0.2	0.2 min.	0.5 min.

### Chip Tight Tolerance Type 0603 (1608) Size

Part Number	Sensing Temperature (at 4.7k ohm) (°C)	Maximum Voltage (V)	Resistance (at 25°C) (ohm)	Temperature Range (°C)
PRF18BE471RB1RB	85 ±3°C	32	470 ±50%	-20 to 100
PRF18BD471RB1RB	95 ±3°C	32	470 ±50%	-20 to 110
PRF18BC471RB1RB	105 ±3°C	32	470 ±50%	-20 to 120
PRF18BB471RB1RB	115 ±3°C	32	470 ±50%	-20 to 130

This product is applied to reflow soldering. Please consult us for flow soldering usage.

## For Overheat Sensing Chip Type (Reference Data)

### ■ Standard Land Pattern Dimensions

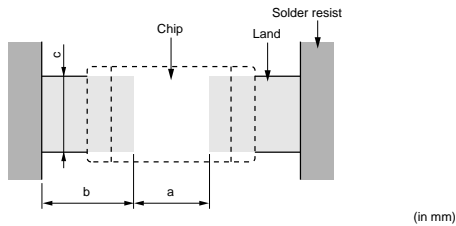

Part Number	Soldering Methods	Dimensions (mm)			
		Chip (L×W)	a	b	c
PRF15	Reflow Soldering	1.0×0.5	0.5	0.4-0.5	0.5
PRF18		1.6×0.8	0.6-0.8	0.6-0.7	0.6-0.8
PRF21		2.0×1.25	1.0-1.2	0.5-0.7	1.0-1.2

### ■ Resistance - Temperature Characteristics (Typical)

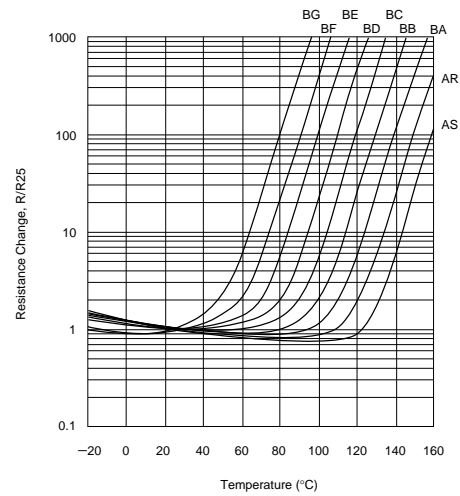

### ■ Overheat Protection Circuit

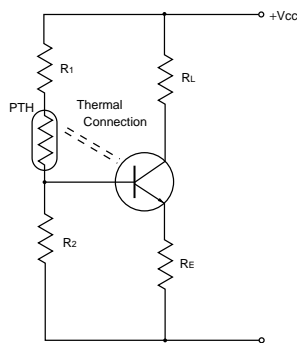

### ■ Temperature Sensing Circuit

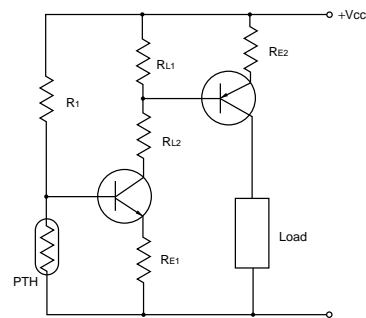



## Chip Type (Ref. Only)

### ■ Resistance - Temperature Characteristics Range

PRF15BC471QB1RC

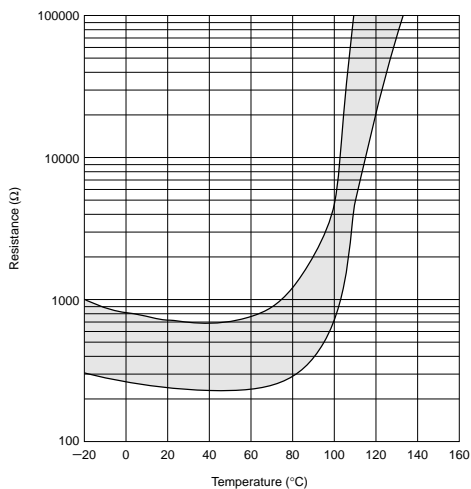

PRF15BB471QB1RC

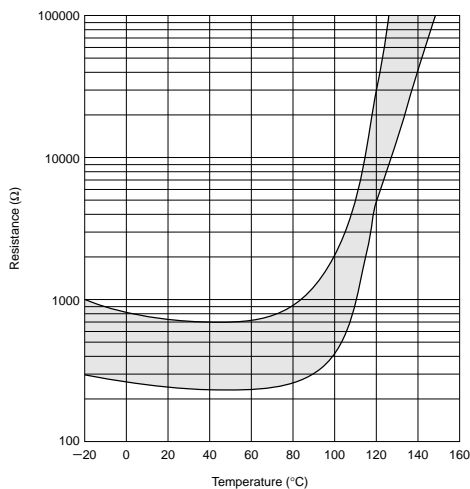

PRF15BA471QB1RC

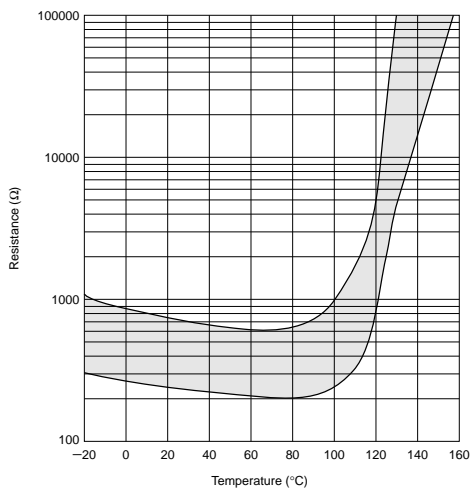

PRF18/21BG471Q Type

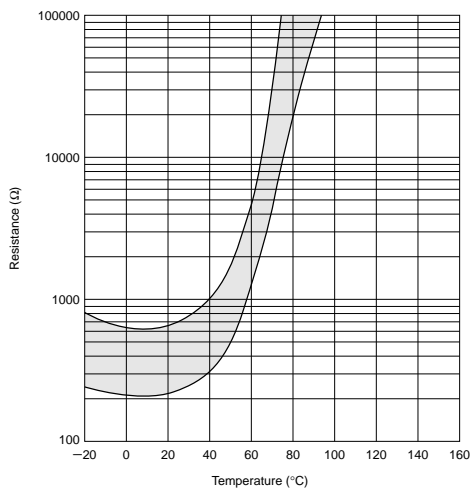

PRF18/21BF471Q Type

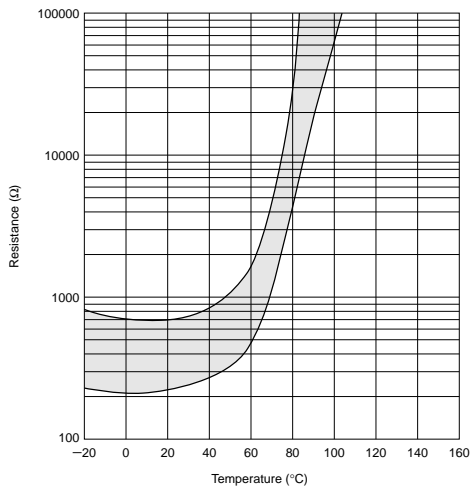

PRF18/21BE471Q Type

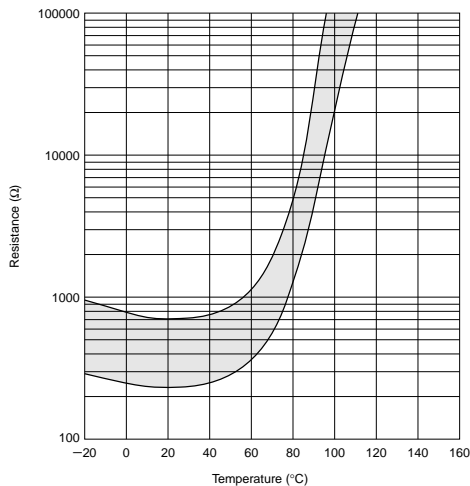

Continued on the following page. ↗

## Chip Type (Ref. Only)

Continued from the preceding page.

### Resistance - Temperature Characteristics Range

PRF18/21BD471Q Type

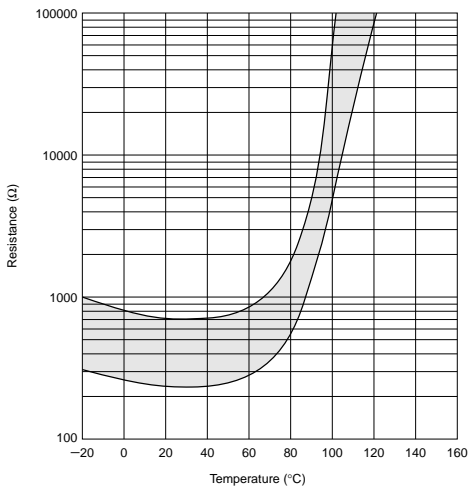

PRF18/21BC471Q Type

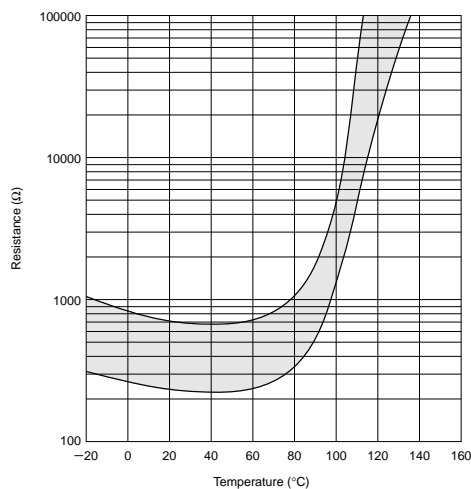

PRF18/21BB471Q Type

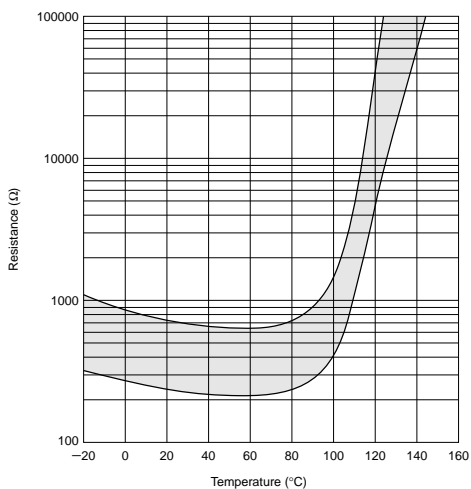

PRF18/21BA471Q Type

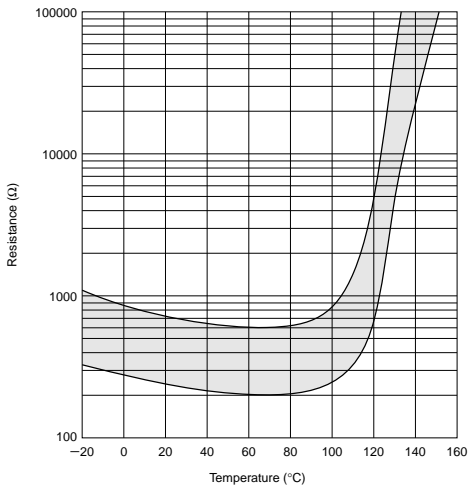

PRF18/21AR471Q Type

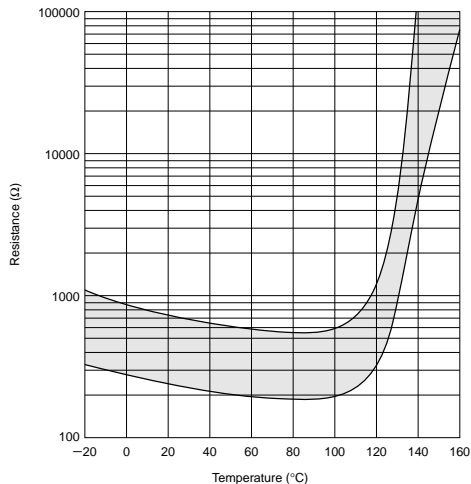

PRF18/21AS471Q Type

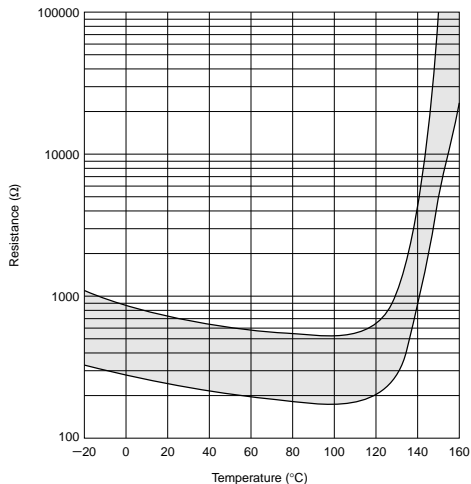

## Chip Tight Tolerance Type (Ref. Only)

### ■ Resistance - Temperature Characteristics Range

PRF18BE471RB1RB

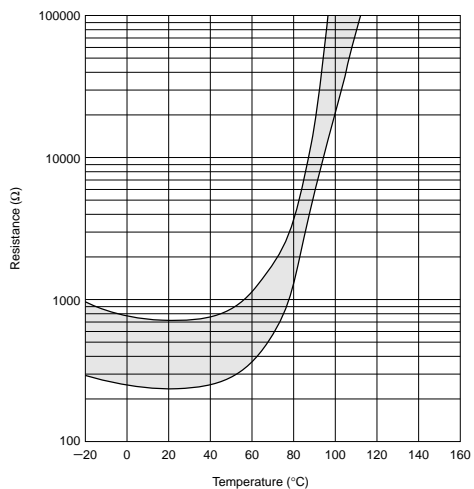

PRF18BD471RB1RB

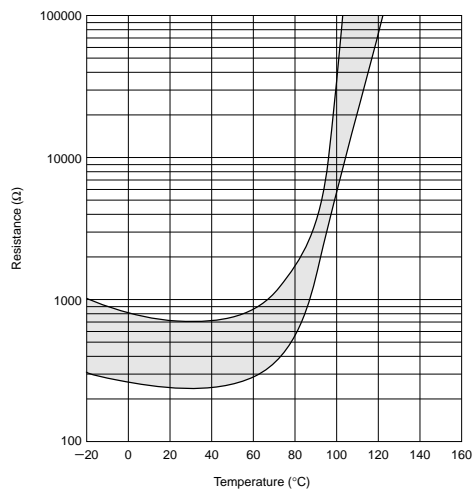

PRF18BC471RB1RB

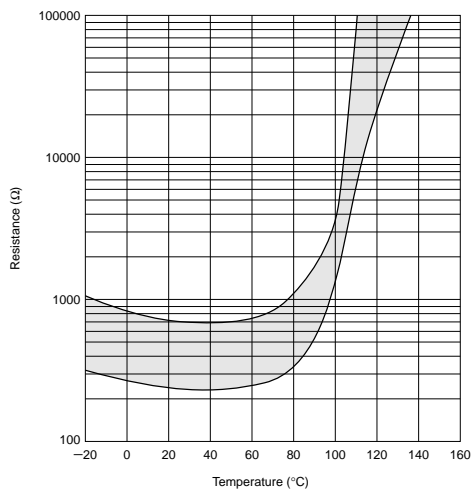

PRF18BB471RB1RB

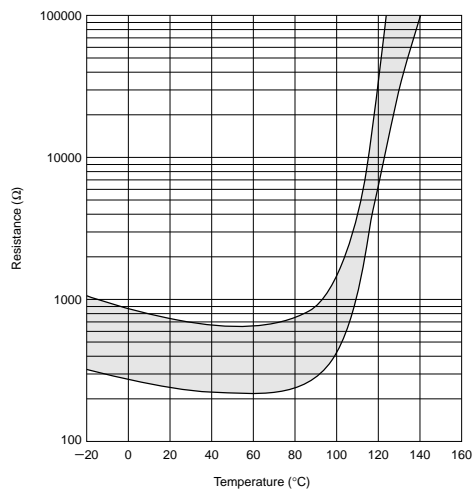

## Chip Type Specifications and Test Methods (PRF15 Series)

### ■ PRF15 Series

No.	Item	Rating Value	Method of Examination															
1	Resistance Value (at 25°C)	The resistance value should be within the specified tolerance.	After applying maximum operating voltage for 3 minutes and leaving for 2 hours at 25°C, measured by applying voltage of less than 1.5Vdc (by a direct current of less than 10mA).															
2	Vibration	Normal appearance Resistance change: not to exceed ±20% (*)	JIS C 5102 term 8.2 Soldered PTC to PCB Vibration: 10-55-10Hz (1 min.) Width: 1.5mm Vibrate for 2 hours in each of 3 mutually perpendicular planes for a total of 6 hours.															
3	Solderability	Min. 75% electrode is covered with new solder. Resistance change: not to exceed ±20% (*)	JIS C 5102 term 8.4 Solder: Sn 63%/Pb 37% (or 60/40%) Solder temp: 230±5°C Soaking time: 3±0.5 seconds. Soaking position: Until a whole electrode is soaked.															
4	Solder-heatability	Normal appearance Resistance change: not to exceed ±20% (*)	Solder: Sn 63%/Pb 37% (or 60/40%) Flux: Solder paste containing less than 0.2wt% of chlorine. Preheating: 150±5°C 3 minutes. Peak temp.: 260±5°C 10±5 seconds. (reflow) PCB: Glass Epoxy PCB (JIS C 6484)															
5	Temperature Cycling	Normal appearance Resistance change: not to exceed ±20% (*)	JIS C 5102 term 9.3 Times: 5 cycles <table border="1" style="margin-left: auto; margin-right: auto;"> <thead> <tr> <th>Step</th> <th>Temp. (°C)</th> <th>Time (minute)</th> </tr> </thead> <tbody> <tr> <td>1</td> <td>-20 +0, -3</td> <td>30</td> </tr> <tr> <td>2</td> <td>Room temp.</td> <td>10-15</td> </tr> <tr> <td>3</td> <td>+150 +3, -0</td> <td>30</td> </tr> <tr> <td>4</td> <td>Room temp.</td> <td>10-15</td> </tr> </tbody> </table>	Step	Temp. (°C)	Time (minute)	1	-20 +0, -3	30	2	Room temp.	10-15	3	+150 +3, -0	30	4	Room temp.	10-15
Step	Temp. (°C)	Time (minute)																
1	-20 +0, -3	30																
2	Room temp.	10-15																
3	+150 +3, -0	30																
4	Room temp.	10-15																
6	Humidity Test	Normal appearance Resistance change: not to exceed ±20% (*)	JIS C 5102 term 9.5 40±2°C, 90-95%RH leave for 500±8 hours.															
7	High Temperature Load Test	Normal appearance Resistance change: not to exceed ±20% (*)	JIS C 5102 term 9.10 85±5°C (in air), load maximum operating voltage for 1000±12 hours.															

(\*) Measurement resistance after the test by applying voltage of less than 1.5Vdc by a direct current of less than 10mA after product is left at 25±2°C for 2 hours.

Above mentioned soldering in "2. Vibration" is done following condition at our side.

- Glass-Epoxy PC board
- Standard land dimension
- Standard solder paste
- Standard solder profile

Above conditions are mentioned in Notice.

## Chip Type Specifications and Test Methods (PRF18/21 Series)

### ■ PRF18/21 Series

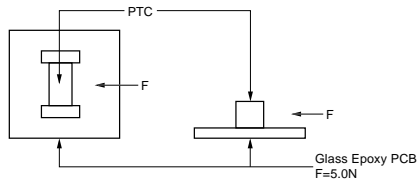
No.	Item	Rating Value	Method of Examination															
1	Resistance Value (at 25°C)	The resistance value should be within the specified tolerance.	After applying maximum operating voltage for 3 minutes and leaving for 2 hours at 25°C, measured by applying voltage of less than 1.5Vdc (by a direct current of less than 10mA).															
2	Adhesive Strength	There is no sign of electrode exfoliation	EIAJ ET-7403 term 9 Solder PTC to PCB and add a force of 5.0N in the direction shown below. 															
3	Vibration	Normal appearance Resistance change: not to exceed ±20% (*)	JIS C 5102 term 8.2 Soldered PTC to PCB Vibration: 10-55-10Hz (1 min.) Width: 1.5mm Vibrate for 2 hours in each of 3 mutually perpendicular planes for a total of 6 hours.															
4	Solderability	Min. 75% electrode is covered with new solder. Resistance change: not to exceed ±20% (*)	JIS C 5102 term 8.4 Solder: Sn 63%/Pb 37% (or 60/40%) Solder temp: 230±5°C Soaking time: 3±0.5 seconds. Soaking position: Until a whole electrode is soaked.															
5	Solder-heatability	Normal appearance Resistance change: not to exceed ±20% (*)	Solder: Sn 63%/Pb 37% (or 60/40%) Flux: Solder paste containing less than 0.2wt% of chlorine. Preheating: 150±5°C 3 minutes. Peak temp.: 260±5°C 10±5 seconds. (reflow) PCB: Glass Epoxy PCB (JIS C 6484)															
6	Temperature Cycling	Normal appearance Resistance change: not to exceed ±20% (*)	JIS C 5102 term 9.3 Times: 5 cycles <table border="1" data-bbox="943 1115 1300 1234"> <thead> <tr> <th>Step</th> <th>Temp. (°C)</th> <th>Time (minute)</th> </tr> </thead> <tbody> <tr> <td>1</td> <td>-20 +0, -3</td> <td>30</td> </tr> <tr> <td>2</td> <td>Room temp.</td> <td>10-15</td> </tr> <tr> <td>3</td> <td>+150 +3, -0</td> <td>30</td> </tr> <tr> <td>4</td> <td>Room temp.</td> <td>10-15</td> </tr> </tbody> </table>	Step	Temp. (°C)	Time (minute)	1	-20 +0, -3	30	2	Room temp.	10-15	3	+150 +3, -0	30	4	Room temp.	10-15
Step	Temp. (°C)	Time (minute)																
1	-20 +0, -3	30																
2	Room temp.	10-15																
3	+150 +3, -0	30																
4	Room temp.	10-15																
7	Humidity Test	Normal appearance Resistance change: not to exceed ±20% (*)	JIS C 5102 term 9.5 40±2°C, 90-95%RH leave for 500±8 hours.															
8	High Temperature Load Test	Normal appearance Resistance change: not to exceed ±20% (*)	JIS C 5102 term 9.10 85±5°C (in air), load maximum operating voltage for 1000±12 hours.															

(\*) Measurement resistance after the test by applying voltage of less than 1.5Vdc by a direct current of less than 10mA after product is left at 25±2°C for 2 hours.

Above mentioned soldering in "2. Adhesive Strength" and "3. Vibration" is done following condition at our side.

- Glass-Epoxy PC board
- Standard land dimension
- Standard solder paste
- Standard solder profile

Above conditions are mentioned in Notice.

## Chip Tight Tolerance Type Specifications and Test Methods

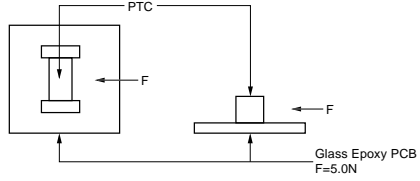
No.	Item	Rating Value	Method of Examination															
1	Resistance Value (at 25°C)	The resistance value should be within the specified tolerance.	After applying maximum operating voltage for 3 minutes and leaving for 2 hours at 25°C, measured by applying voltage of less than 1.5Vdc. (by a direct current of less than 10mA).															
2	Adhesive Strength	There is no sign of electrode exfoliation	EIAJ ET-7403 term 9 Solder PTC to PCB and add a force of 5.0N in the direction shown below. 															
3	Vibration	Normal appearance Resistance change: not to exceed ±20% (*1)	JIS C 5102 term 8.2 Soldered PTC to PCB Vibration: 10-55-10Hz (1 min.) Width: 1.5mm Vibrate for 2 hours in each of 3 mutually perpendicular planes for a total of 6 hours.															
4	Solderability	Min. 75% electrode is covered with new solder. Resistance change: not to exceed ±20% (*1)	JIS C 5102 term 8.4 Solder: Sn 63%/Pb 37% (or 60/40%) Solder temp: 230±5°C Soaking time: 3±0.5 seconds. Soaking position: Until a whole electrode is soaked															
5	Solder-heatability	Normal appearance Resistance change: not to exceed ±20% (*1)	Solder: Sn 63%/Pb 37% (or 60/40%) Flux: Solder paste containing less than 0.2wt% of chlorine. Preheating: 150±5°C 3 minutes. Peak temp.: 260±5°C 10±5 seconds. (reflow) PCB: Glass Epoxy PCB (JIS C 6484)															
6	Temperature Cycling	Normal appearance Resistance change: not to exceed ±20% (*1, 2)	JIS C 5102 term 9.3 Times: 5 cycles <table border="1" style="margin-left: auto; margin-right: auto; border-collapse: collapse; text-align: center;"> <thead> <tr style="background-color: #f2f2f2;"> <th>Step</th> <th>Temp. (°C)</th> <th>Time (minute)</th> </tr> </thead> <tbody> <tr> <td>1</td> <td>-20 +0, -3</td> <td>30</td> </tr> <tr> <td>2</td> <td>Room temp.</td> <td>10-15</td> </tr> <tr> <td>3</td> <td>+150 +3, -0</td> <td>30</td> </tr> <tr> <td>4</td> <td>Room temp.</td> <td>10-15</td> </tr> </tbody> </table>	Step	Temp. (°C)	Time (minute)	1	-20 +0, -3	30	2	Room temp.	10-15	3	+150 +3, -0	30	4	Room temp.	10-15
Step	Temp. (°C)	Time (minute)																
1	-20 +0, -3	30																
2	Room temp.	10-15																
3	+150 +3, -0	30																
4	Room temp.	10-15																
7	Humidity Test	Normal appearance Resistance change: not to exceed ±20% (*1, 2)	JIS C 5102 term 9.5 40±2°C, 90-95%RH leave for 500±8 hours.															
8	High Temperature Load Test	Normal appearance Resistance change: not to exceed ±20% (*1, 2)	JIS C 5102 term 9.10 85±5°C (in air), load maximum operating voltage for 1000±12 hours.															

(\*1) Measurement resistance after the test by applying voltage of less than 1.5Vdc by a direct current of less than 10mA after product is left at 25±2°C for 2 hours.  
 (\*2) Sensing temp. change: not to exceed ±1°C

Above mentioned soldering in "2. Adhesive Strength" and "3. Vibration" is done following condition at our side.

- Glass-Epoxy PC board
- Standard land dimension
- Standard solder paste
- Standard solder profile

Above conditions are mentioned in Notice.

# POSISTOR<sup>®</sup> for Circuit Protection



## For Overheat Sensing Lead Type

PTFM type has been developed for protecting power transistors, stereo main amplifiers, etc. from overheating, and also for sensing the temperature of other components which may be overheated. The "POSISTOR" offers an excellent temperature sensing ability, exhibiting a steep change in electrical resistivity near the temperature setting. PTFL type is suitable for use as an air temperature sensor.

### ■ Features

1. PTFM type is a screw-fixing type and PTFL type is a lead type, therefore mounting is easy.
2. Compact and light design as well as excellent thermal response.
3. Solid-state construction withstands mechanical vibration and impact sufficiently.
4. Contactless operation provides a prolonged service life, yet permits noiseless operation.
5. The operating point of "POSISTOR" is set on the steepest point along the resistance-temperature characteristic curve, thus performing the overheat protective operation securely.
6. PTFM type and PTFL type have the same temperature characteristic, providing a selection depending on the mounting method.

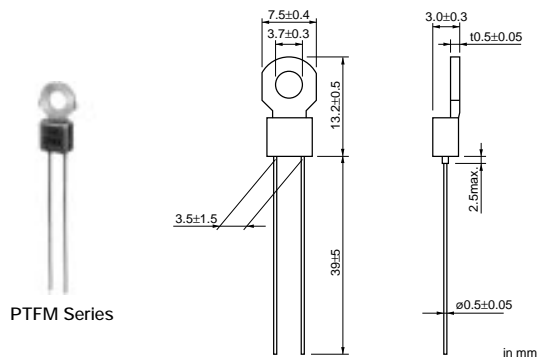
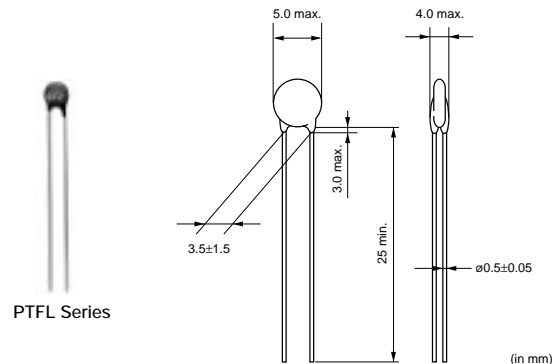

Part Number	Max. Voltage (V)	Sensing Temp. (TS) (°C)	Resistance Value at 25°C (max.) (ohm)	Resistance Value (at Sensing Temp. -10°C) (max.)	Resistance Value (at Sensing Temp. TS°C) (min.)
PTF□04BH471Q2N34B0	16	60	100	330ohm	470ohm
PTF□04BG471Q2N34B0	16	70	100	330ohm	470ohm
PTF□04BF471Q2N34B0	16	80	100	330ohm	470ohm
PTF□04BE471Q2N34B0	16	90	100	330ohm	470ohm
PTF□04BD471Q2N34B0	16	100	100	330ohm	470ohm
PTF□04BC471Q2N34B0	16	110	100	330ohm	470ohm
PTF□04BB471Q2N34B0	16	120	100	330ohm	470ohm
PTF□04BH222Q2N34B0	16	60	330	1.5k ohm	2.2k ohm
PTF□04BG222Q2N34B0	16	70	330	1.5k ohm	2.2k ohm
PTF□04BF222Q2N34B0	16	80	330	1.5k ohm	2.2k ohm
PTF□04BE222Q2N34B0	16	90	330	1.5k ohm	2.2k ohm
PTF□04BD222Q2N34B0	16	100	330	1.5k ohm	2.2k ohm
PTF□04BC222Q2N34B0	16	110	330	1.5k ohm	2.2k ohm
PTF□04BB222Q2N34B0	16	120	330	1.5k ohm	2.2k ohm

A blank is filled with type codes. (L: Lead type, M: with Lug-terminal)

11

### ■ Resistance - Temperature Characteristics

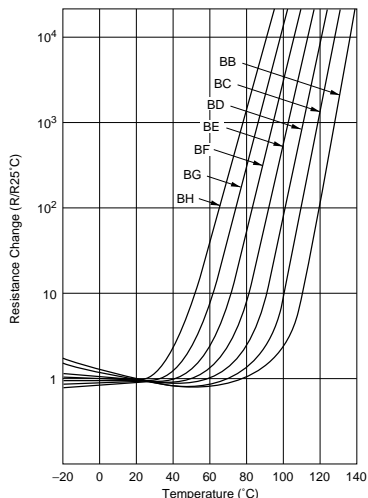

### ■ Example of Thermal Response Time

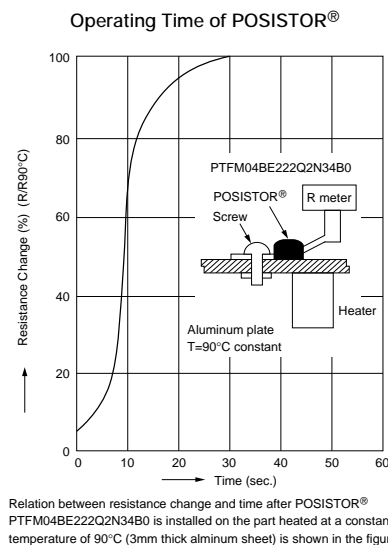

### ■ Overheat Protection Circuit

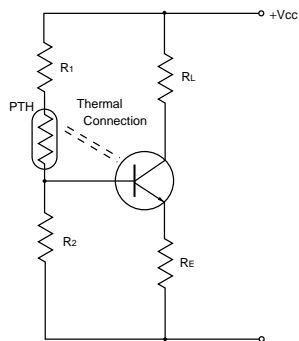

### ■ Overheat Sensing Circuit

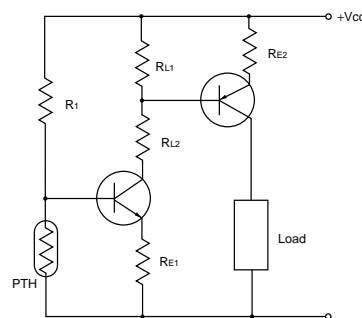

### ■ Resistance - Temperature Characteristics Range (Ref. Only)

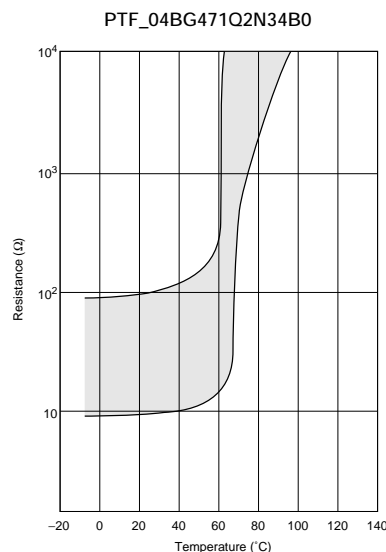
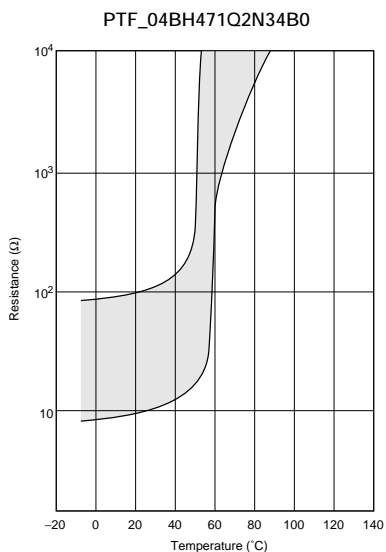

Continued on the following page. ↗



Continued from the preceding page.

■ Resistance - Temperature Characteristics Range (Ref. Only)

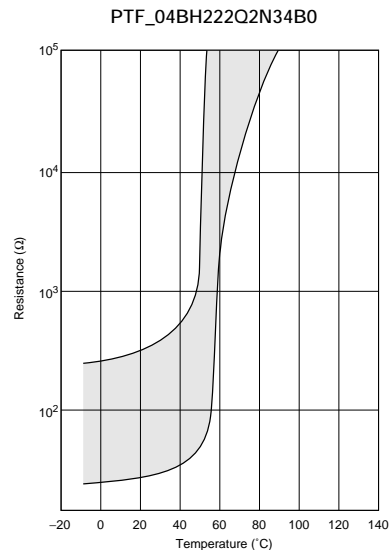
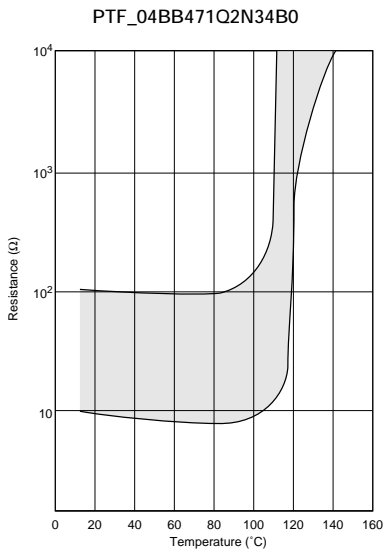
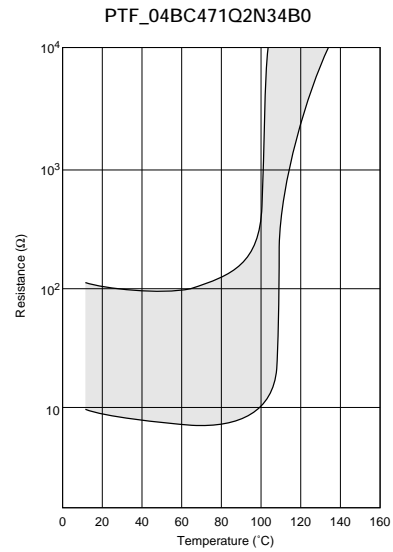
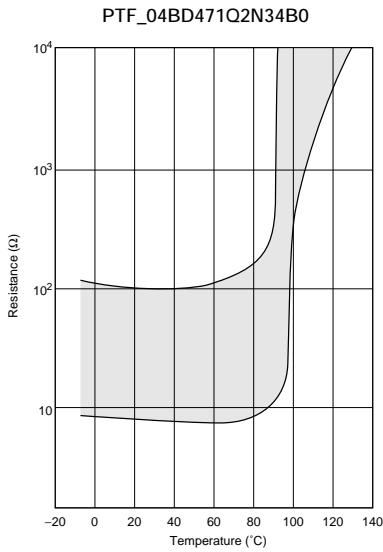
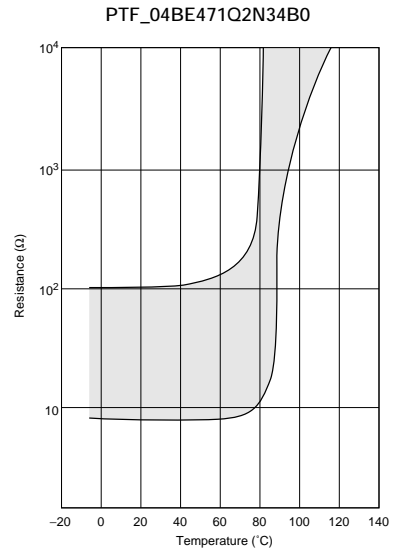
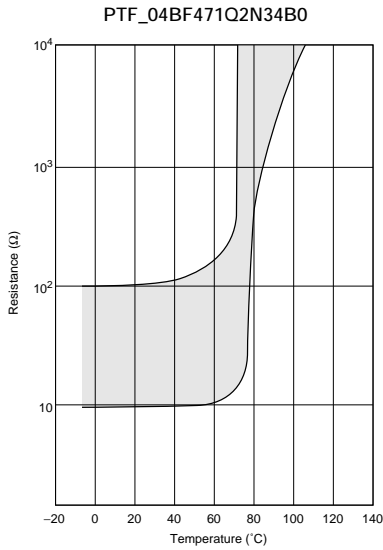

11

Continued from the preceding page.

■ Resistance - Temperature Characteristics Range (Ref. Only)

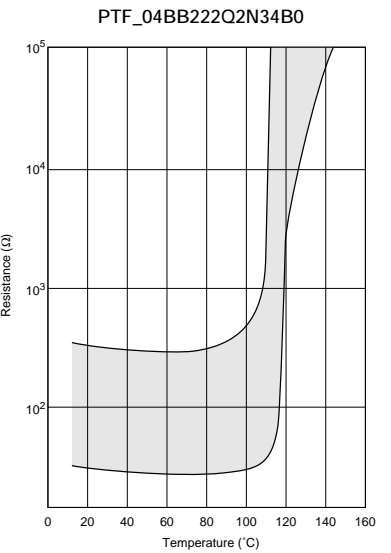
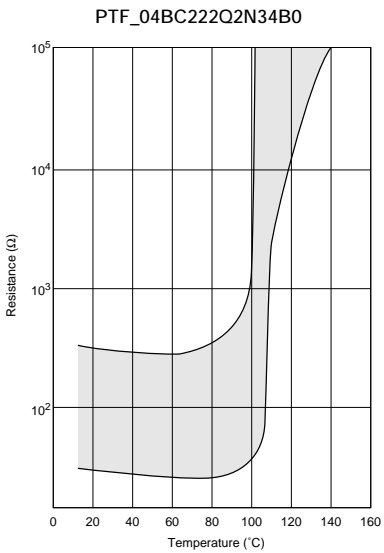
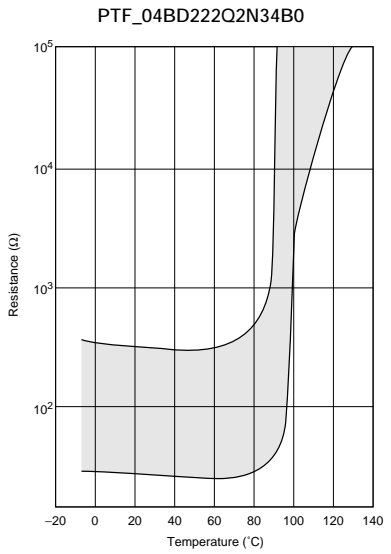
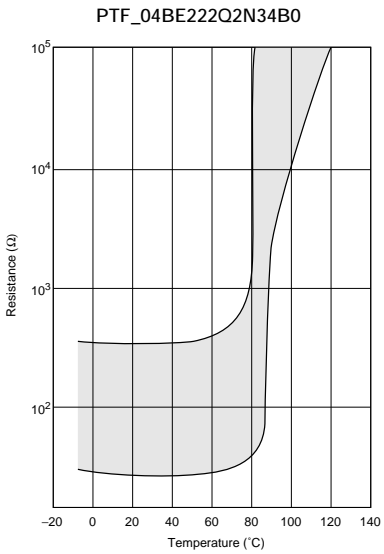
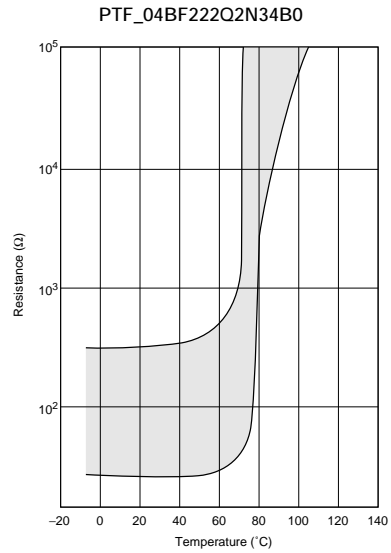
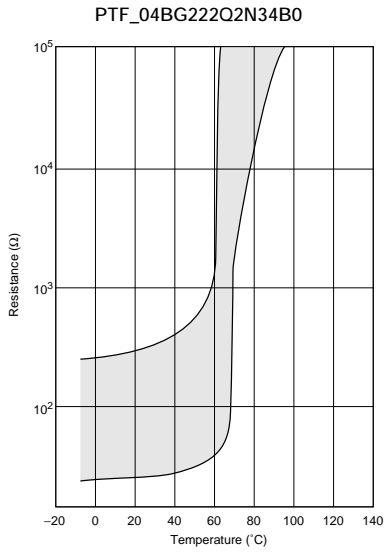

## For Temperature Sensor Lead Type Specifications and Test Methods

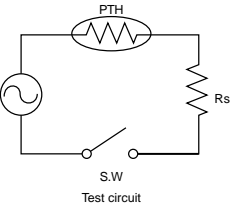
No.	Item	Rating Value	Method of Examination						
1	Resistance Value	Satisfies specification	Resistance value is measured by applying voltage under 1.5Vdc (by a direct current of less than 10mA) in a silicone oil vessel.						
2	Withstanding Voltage	No problem	We apply AC voltage 120% that of the maximum voltage to POSISTOR® by raising voltage gradually for 180±5 seconds at 25°C. (A protective resistor is to be connected in series, and the inrush current through POSISTOR® must be limited below max. rated value.)						
3	Tensile Strength of Lead Wire Terminal	No damage	The load is gradually applied to each terminal of POSISTOR® until the force of the following table in the axial-direction with fixing POSISTOR®'s body itself and this load is kept for 10 seconds. <table border="1" style="margin-left: auto; margin-right: auto;"> <thead> <tr> <th>Series</th> <th>Force</th> </tr> </thead> <tbody> <tr> <td>PTFL</td> <td>4.90N</td> </tr> <tr> <td>PTFM</td> <td>9.80N</td> </tr> </tbody> </table>	Series	Force	PTFL	4.90N	PTFM	9.80N
Series	Force								
PTFL	4.90N								
PTFM	9.80N								
4	Bending Strength of Lead Wire Terminal	Lead wire does not come off.	POSISTOR® is held so that it is perpendicular to the lead wire with the following load hanging in the axial direction of the lead wire. The lead wire is slowly bent toward 90° and returned; then it is slowly bent in the opposite direction and returned to original state. (Above mentioned procedure is done slowly with one cycle.) <table border="1" style="margin-left: auto; margin-right: auto;"> <thead> <tr> <th>Series</th> <th>Force</th> </tr> </thead> <tbody> <tr> <td>PTFL</td> <td>2.45N</td> </tr> <tr> <td>PTFM</td> <td>4.90N</td> </tr> </tbody> </table>	Series	Force	PTFL	2.45N	PTFM	4.90N
Series	Force								
PTFL	2.45N								
PTFM	4.90N								
5	Solderability	Solder is applied around the lead wire covering 3/4 or more of the circumference without gap in the axial-direction.	The lead wire of POSISTOR® is soaked in a Isopropyl Alcohol (JIS K 8839) or ethanol (JIS K 8101) solution (about 25wt%) of colophony (JIS K 5902) for 5-10 sec. And, each lead wire is soaked in molten solder (JIS Z 3282 H60A) at 235±5°C from the bottom to a point of 2.0-2.5mm for 2±0.5 seconds.						
6	Terminal Durability of Soldering	$\Delta R/R25 \leq \pm 15\%$	The lead wire of POSISTOR® is soaked in molten solder (JIS Z 3282 H60A) at 350±10°C from the bottom to a point of 2.0-2.5 mm for 3.5±0.5 seconds. And, after the device is left at room temperature (25°C) for 24±4 hours, the resistance is measured.						
7	Humidity Test	$\Delta R/R25 \leq \pm 20\%$	POSISTOR® is set in an environmental chamber at 40±2°C and 90-95% humidity for 500±4 hours. And after the device is left at room temperature (25°C) for one hour, the resistance measurement is performed.						
8	Load Cycle Test at High Temperature	$\Delta R/R25 \leq \pm 20\%$  <p style="text-align: center;">Test circuit</p>	POSISTOR® is set in an environmental chamber at 85±3°C with maximum voltage applied for 1.5 hours and then is left without voltage applied for 0.5 hours. This cycle is repeated for 1000±10 hours, and after the device is left at room temperature (25°C) for one hour, the resistance measurement is performed. (A protective resistor is to be connected in series and the inrush current through POSISTOR® must be limited below max. rated value.)						

## ! Caution/Notice

### ■ ! Caution (Storage and Operating Condition)

This product is designed for application in an ordinary environment (normal room temperature, humidity and atmospheric pressure). Do not use under the following conditions because all these factors can deteriorate the characteristics or cause product failure and burn-out.

1. Corrosive gas or deoxidizing gas (Chlorine gas, Hydrogen sulfide gas, Ammonia gas, Sulfuric acid gas, Nitric oxide gas, etc.)
2. Volatile or flammable gas
3. Dusty conditions
4. Under vacuum, or under high or low-pressure
5. Wet or humid conditions
6. Places with salt water, oils, chemical liquids or organic solvents
7. Strong vibrations
8. Other places where similar hazardous conditions exist

### ■ ! Caution (Other)

Be sure to provide an appropriate fail-safe function on your product to prevent secondary damage that may be caused by the abnormal function or the failure of our product.

### ■ Notice (Storage and Operating Condition)

To keep solderability of product from declining, following storage condition is recommended.

1. Storage condition:
  - Temperature -10 to +40 degrees C
  - Humidity less than 75%RH (not dewing condition)
2. Storage term:
  - Use this product within 6 months after delivery by first-in and first-out stocking system.
3. Handling after unpacking:
  - After unpacking, promptly reseal this product or store it in a sealed container with a drying agent.
4. Storage place:
  - Do not store this product in corrosive gas (sulfuric acid, chlorine, etc.) or in direct sunlight.

### ■ Notice (Soldering and Mounting)

#### PTGL Series

When the lead of this product is soldered, pay attention as follows to avoid the decline of element characteristics or break-down of the element.

1. Use Rosin type flux or non-activated flux
2. Do not dip the body into flux.  
(flux should be coated to lead wire only for soldering.)
3. Be sure that preheating does not melt the soldering of this product.

### ■ Notice (Soldering and Mounting)

#### PTFL/PTFM Series

1. PTFM type is to be screwed beside the Power-Transistor on the radiative plate.
2. If PTFL type is to be mounted with thermal cement, the cement should not be of the Cyano Acrylate family.
3. Please bend the lead wire far from the root of the body and do not apply force to the lead wire of the product.
4. When the lead of this product is soldered, pay attention as follows to avoid the decline of element characteristics or break-down of the element.
  - (1) Use Rosin type flux or non-activated flux.
  - (2) Do not dip the body into flux.  
(Flux should be coated to lead wire only for soldering.)
  - (3) Be sure that preheating does not melt the soldering of this product.

## ⚠ Caution/Notice

### ■ Notice (Soldering and Mounting) PRG/PRF Series

#### 1. Solder and Flux

##### (1) Solder Paste

Use solder paste Sn:Pb=63:37wt%.

For your reference, we are using

63Sn/37Pb RMA9086 90-3-M18,

manufactured by Alpha Metals Japan Ltd.

96.5Sn/3.0Ag/0.5Cu M705-221BM5-42-11,

manufactured by Senju Metal Industry Co., LTD for any

Internal tests of this product.

##### (2) Flux

Use rosin-based flux. Do not use strong acidic flux (with halide content exceeding 0.2wt%).

#### 2. Cleaning Conditions and Drying

To remove the flux after soldering, observe the following points in order to avoid deterioration of the characteristics or any change to the external electrodes quality.

##### (1) Cleaning Conditions

Solvent	Dipping Cleaning	Ultrasonic Cleaning
2-propanol	Less than 5 minutes at room temp. or Less than 2 minutes at 40°C max.	Less than 1 minute 20W/L Frequency of several 10kHz to 100kHz.

A sufficient cleaning should be applied to remove flux completely.

##### (2) Drying

After cleaning, promptly dry this product.

#### 3. Soldering Conditions

In your mounting process, observe the following points in order to avoid deterioration of the characteristics or destruction of this product. The mounting quality of this product may also be affected by the mounting conditions, shown in the points below.

This product is for reflow soldering only. Flow soldering should not be allowed.

##### (1) Printing Conditions of Solder Paste

(a) Standard thickness of solder paste printing should be from 0.15 to 0.20 mm.

(b) After soldering, the solder fillet should be a height from 0.2 mm to the thickness of this product (see the figure at right).

(c) Too much solder gives too strong mechanical stress to this product. Such stress may cause cracking or other mechanical damage. Also, it can destroy the electrical performance of this product.

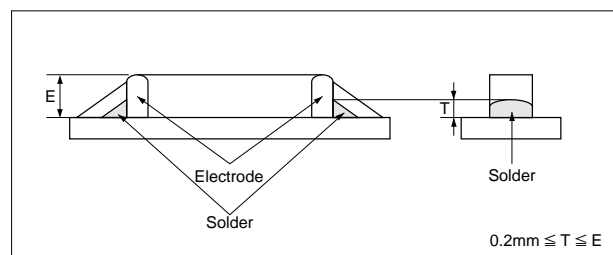

Continued on the following page. ↗

**! Caution/Notice**

Continued from the preceding page.

(2) Allowable Soldering Temperature and Time

- (a) Solder within the temperature and time combinations, indicated by the slanted lines in the graphs at right.
- (b) The excessive soldering conditions may cause dissolution of metallization or deterioration of solder-wetting on the external electrode.
- (c) In the event that soldering is repeated more than twice, the allowable reflow soldering time should be the accumulated soldering time.

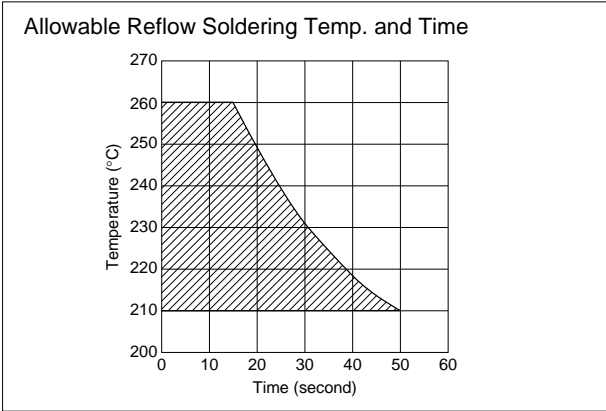

(3) Standard Temperature Profile for Soldering

- (a) Insufficient preheating may cause a crack on ceramic body. Difference between preheating temperature and maximum temperature in the profile should be 100°C.
- (b) Rapid cooling by dipping in solvent or by other means is not recommended.

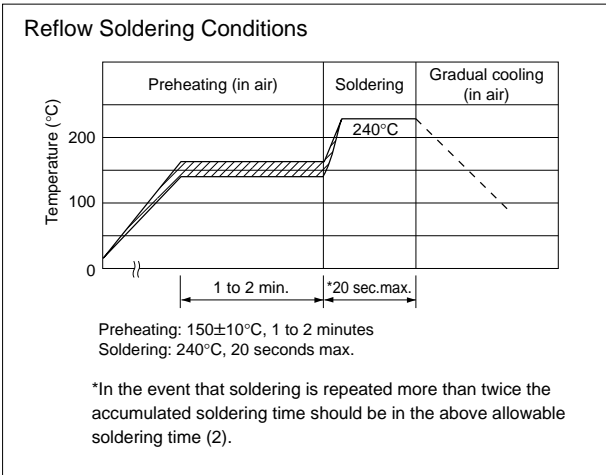

- (4) There may be a risk of unexpected failures (tombstone, insufficient solder-wetting, etc.) in the mounting process, caused by the mounting conditions. Please make sure that this product is correctly mounted under specified mounting conditions.

## Caution/Notice

### ■ Notice (Handling)

#### PTGL Series

1. Do not apply an excessive force to the lead.  
Otherwise, it may cause the junction between lead and element to break, or may crack the element.  
Therefore, holding the element side lead wire is recommended when lead wire is bent or cut.
2. This product does not have waterproof construction. Splashed water may cause failure mode such as decline of characteristics or current leak.
3. When this product is operated, temperature of some area may be over 100 to 160 degrees C. Be sure that surrounding parts and inserting material can withstand the temperature. If the surrounding part and material are kept under such condition, they may deteriorate or produce harmful gas (Chlorine gas, Hydrogen sulfide gas, Ammonia gas, Sulfuric acid gas, Nitric oxide gas, etc.). And such harmful gas may deteriorate the element.

### ■ Notice (Handling)

#### PTFL/PTFM Series

1. Do not apply an excessive force to the lead.  
Otherwise, it may cause the junction between lead and element to break, or may crack the element.  
Therefore, holding the element side lead wire is recommended when lead wire is bent or cut.
2. This product does not have waterproof construction. Splashed water may cause failure mode such as decline of characteristics or current leak.

### ■ Notice (Handling)

#### PRG/PRF Series

1. When this product is operated, temperature of some area may be over 100 to 150 degrees C. Be sure that surrounding parts and inserting material can withstand the temperature. If the surrounding part and material are kept under such condition, they may deteriorate or produce harmful gas (Chlorine gas, Hydrogen sulfide gas, Ammonia gas, Sulfuric acid gas, Nitric oxide gas, etc.). And such harmful gas may deteriorate the element.
2. Do not assemble this product with air-sealing or resin casting. Such sealing may deteriorate element.

## PRG/PRF Series Package

### Minimum Quantity Guide

Part Number	Quantity (pcs.)	
	Paper Tape	Embossed Tape
PRF15_RC	10000	-
PR*18_RB	4000	-
PR*21_RA	-	4000
PR*21_RK	-	3000

### Tape Dimensions

PRF15\_RC Series: Paper Tape

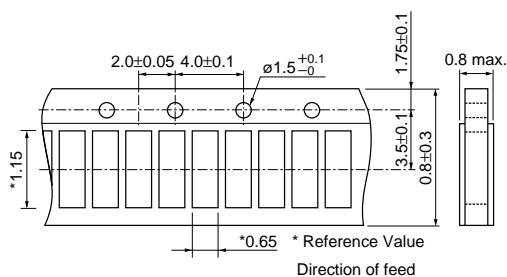

PR\*18\_RB Series: Paper Tape

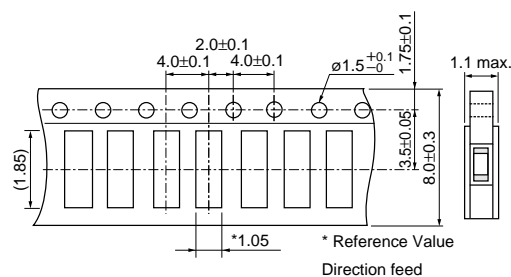

PR\*21\_RA Series: Embossed Tape

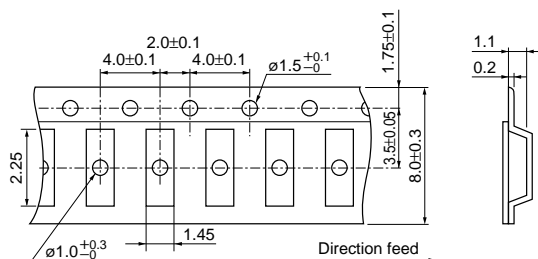

PR\*21\_RK Series: Embossed Tape

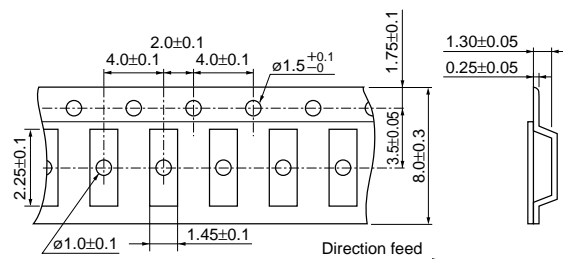

(in mm)

### Reel Dimensions

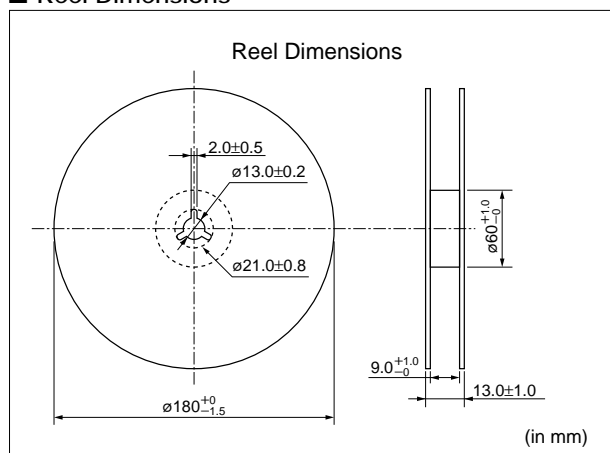



## Lead Type PTGL Series Package

### ■ Minimum Order Quantity

1. Bulk: 100 pcs. (This quantity differs from actual delivery quantity in a package.)

### 2. Taping

Series	Taping Part Number	Minimum Quantity (pcs.)
		Ammo Pack
Narrow Current Band 30V series	PTGL04AS100K2B51A0	1500
	PTGL04AS100K2N51A0	
	PTGL05AS3R9K2B51A0	
	PTGL07AS1R8K2B51A0	
	PTGL07AS2R7K2B51A0	
	PTGL09AS1R2K2B51A0	
	PTGL12AS0R8K2B51A0	
Narrow Current Band 51V series	PTGL04AS100K3B51A0	1500
	PTGL05AS6R8K3B51A0	
	PTGL07AS3R3K3B51A0	
	PTGL09AS2R2K3B51A0	
	PTGL12AS1R2K3B51A0	
Narrow Current Band 60V series	PTGL04AS220K4B51A0	1500
	PTGL04AS220K4N51A0	
	PTGL05AS100K4B51A0	
	PTGL07AS5R6K4B51A0	
	PTGL07AS5R6K4N51A0	
	PTGL09AS3R3K4B51A0	
	PTGL12AS2R2K4B51A0	
Narrow Current Band 140V series	PTGL04AS560K6B51A0	1500
	PTGL05AS270K6B51A0	
	PTGL07AS150K6B51A0	
	PTGL09AS120K6B51A0	
	PTGL09AS7R6K6B51A0	
	PTGL12AS4R7K6B51A0	

Series	Taping Part Number	Minimum Quantity (pcs.)
		Ammo Pack
24V series	PTGL07BD100N2B51A0	1500
	PTGL07BD6R8N2B51A0	
	PTGL09BD4R7N2B51A0	
	PTGL09BD3R3N2B51A0	
	PTGL09BD2R2N2B51A0	
30V series	PTGL04AR130H2B51A0	1500
	PTGL07AR4R6H2B51A0	
	PTGL09AR1R8H2B51A0	
32V series	PTGL07BD470N3B51A0	1500
	PTGL07BD330N3B51A0	
	PTGL07BD220N3B51A0	
	PTGL07BD150N3B51A0	
56V series	PTGL07AR220M3P51A0	1500
	PTGL07AR8R2M3P51A0	
	PTGL09AR150M3B51A0	
	PTGL10AR3R9M3P51A0	
	PTGL09AR4R7M3B51A0	
	PTGL10AR3R9M3B51A0	
80V series	PTGL05AR550H4P51A0	1500
	PTGL07AR250H4B51A0	
	PTGL09AR9R4H4B51A0	
125V series	PTGL05AR181M7P52A0	1000
	PTGL07AR750M7B52A0	
	PTGL09AR470M6B52A0	
	PTGL09AR220M6B52A0	
250V series	PTGL07BB220N0B52A0	1000
	PTGL09AR390N0B52A0	
	PTGL10BB120N0P52A0	
265V series	PTGL05AR151H8P52A0	1000
	PTGL07AR700H8B52A0	
	PTGL07AR650H8B52A0	
	PTGL07AR450H8B52A0	
	PTGL09AR250H8B52A0	

Continued on the following page. 

## Lead Type PTGL Series Package

Continued from the preceding page.

### 24 - 80V/Narrow Current Band 30 - 140V Series Taping Dimensions

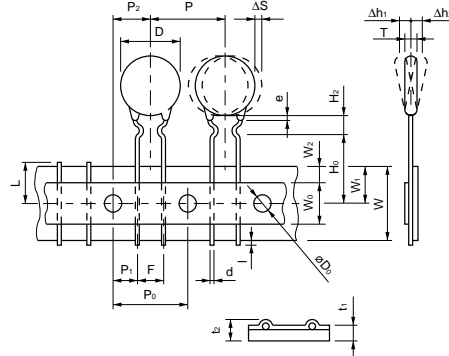

Item	Code	Dimensions (mm)	Note
Pitch of Component	P	12.7	Tolerance is determined by ΔS.
Pitch of Sprocket Hole	P <sub>0</sub>	12.7±0.3	
Lead Spacing	F	5.0 <sup>+0.8</sup> <sub>-0.3</sub>	
Length from Hole Center to Lead	P <sub>1</sub>	3.85±0.8	
Length from Hole Center to Component Center	P <sub>2</sub>	6.35±1.3	Deviation in the feeding direction
Body Diameter	D	Please see in Ratings	
Body Thickness	T	Please see in Ratings	
Deviation along Tape, Left or Right Defect	ΔS	±1.5	Including the inclination caused by lead bending
Carrier Tape Width	W	18.0±0.5	
Position of Sprocket Hole	W <sub>1</sub>	9.0 <sup>+0.5</sup> <sub>-0.75</sub>	Deviation of tape width
Lead Distance between Reference and Bottom Planes	H <sub>0</sub>	16.0±1.0	
	H <sub>2</sub>	6.0 max.	
Protrusion Length	I	+0.5 to -1.0	
Diameter of Sprocket Hole	D <sub>0</sub>	4.0±0.2	
Lead Diameter	d	Please see in Ratings	
Total Tape Thickness	t <sub>1</sub>	0.6±0.3	
Total Thickness of Tape and Lead Wire	t <sub>2</sub>	2.0 max.	
Deviation across Tape	Δh <sub>1</sub> , Δh <sub>2</sub>	1.5 max.	
Portion to cut in Case of Defect	L	11.0 <sup>+0</sup> <sub>-2.0</sub>	
Hold Down Tape Width	W <sub>0</sub>	11.0 min.	
Hold Down Tape Position	W <sub>2</sub>	4.0 max.	
Coating Extension on Lead	e	Up to the center of crimp	

Continued on the following page. ↗

## Lead Type PTGL Series Package

Continued from the preceding page.

### 125/250/265V Series Taping Dimensions

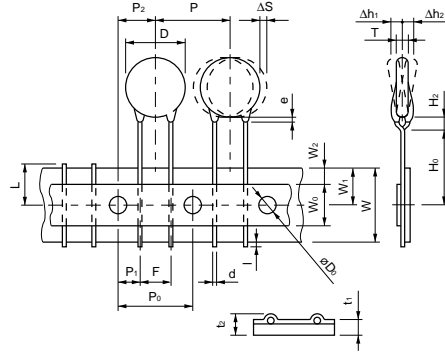

Item	Code	Dimensions (mm)	Note
Pitch of Component	P	12.7	Tolerance is determined by ΔS.
Pitch of Sprocket Hole	P <sub>0</sub>	12.7±0.3	
Lead Spacing	F	5.0 <sup>+0.8</sup> <sub>-0.3</sub>	
Length from Hole Center to Lead	P <sub>1</sub>	3.85±0.8	
Length from Hole Center to Component Center	P <sub>2</sub>	6.35±1.3	Deviation in the feeding direction
Body Diameter	D	Please see Ratings	
Body Thickness	T	Please see Ratings	
Deviation along Tape, Left or Right	ΔS	±1.5	Including the inclination caused by lead bending.
Carrier Tape Width	W	18.0±0.5	
Position of Sprocket Hole	W <sub>1</sub>	9.0 <sup>+0.5</sup> <sub>-0.75</sub>	Deviation of tape width.
Lead Distance between Reference and Bottom Planes	H <sub>0</sub>	16.0±1.0	
	H <sub>2</sub>	6.0 max.	
Protrusion Length	l	+0.5 to -1.0	
Diameter of Sprocket Hole	D <sub>0</sub>	4.0±0.2	
Lead Diameter	d	0.6±0.05	
Total Tape Thickness	t <sub>1</sub>	0.6±0.3	
Total Thickness of Tape and Lead Wire	t <sub>2</sub>	2.0 max.	
Deviation across Tape	Δh <sub>1</sub> , Δh <sub>2</sub>	1.5 max.	
Portion to cut in Case of Defect	L	11.0 <sup>+0</sup> <sub>-2.0</sub>	
Hold Down Tape Width	W <sub>0</sub>	11.0 min.	
Hold Down Tape Position	W <sub>2</sub>	4.0 max.	
Coating Extension on Lead	e	Up to the center of crimp	

**△Note:**

1. Export Control

〈For customers outside Japan〉

No muRata products should be used or sold, through any channels, for use in the design, development, production, utilization, maintenance or operation of, or otherwise contribution to (1) any weapons (Weapons of Mass Destruction (nuclear, chemical or biological weapons or missiles) or conventional weapons) or (2) goods or systems specially designed or intended for military end-use or utilization by military end-users.

〈For customers in Japan〉

For products which are controlled items subject to the "Foreign Exchange and Foreign Trade Law" of Japan, the export license specified by the law is required for export.

2. Please contact our sales representatives or product engineers before using the products in this catalog for the applications listed below, which require especially high reliability for the prevention of defects which might directly damage a third party's life, body or property, or when one of our products is intended for use in applications other than those specified in this catalog.

- |                             |  |
|-----------------------------|--|
| ① Aircraft equipment        | ② Aerospace equipment  |
| ③ Undersea equipment        | ④ Power plant equipment  |
| ⑤ Medical equipment         | ⑥ Transportation equipment (vehicles, trains, ships, etc.)   |
| ⑦ Traffic signal equipment  | ⑧ Disaster prevention / crime prevention equipment   |
| ⑨ Data-processing equipment | ⑩ Application of similar complexity and/or reliability requirements to the applications listed above |

3. Product specifications in this catalog are as of January 2007. They are subject to change or our products in it may be discontinued without advance notice. Please check with our sales representatives or product engineers before ordering. If there are any questions, please contact our sales representatives or product engineers.

4. Please read rating and △CAUTION (for storage, operating, rating, soldering, mounting and handling) in this catalog to prevent smoking and/or burning, etc.

5. This catalog has only typical specifications because there is no space for detailed specifications. Therefore, please approve our product specifications or transact the approval sheet for product specifications before ordering.

6. Please note that unless otherwise specified, we shall assume no responsibility whatsoever for any conflict or dispute that may occur in connection with the effect of our and/or a third party's intellectual property rights and other related rights in consideration of your use of our products and/or information described or contained in our catalogs. In this connection, no representation shall be made to the effect that any third parties are authorized to use the rights mentioned above under licenses without our consent.

7. No ozone depleting substances (ODS) under the Montreal Protocol are used in our manufacturing process.



<http://www.murata.com/>

**Head Office**  
1-10-1, Higashi Kotari, Nagaokakyo-shi, Kyoto 617-8555, Japan  
Phone: 81-75-951-9111

**International Division**  
3-29-12, Shibuya, Shibuya-ku, Tokyo 150-0002, Japan  
Phone: 81-3-5469-6123 Fax: 81-3-5469-6155 E-mail: [intl@murata.co.jp](mailto:intl@murata.co.jp)