

TOSHIBA Photo-IC Silicon Epitaxial Planar

TPS850

Mobile Phones, PHS
 Notebook PCs, PDAs
 Video Cameras, Digital Still Cameras
 Other Equipment Requiring Luminosity Adjustment

The TPS850 is a linear-output photo-IC which incorporates a photodiode and a current amp circuit in a single chip. This photo-IC is current output type, so can set up output voltage freely by arbitrary load resistance.

- High sensitivity: $I_L = 230 \mu\text{A}$
 @ $E_V = 100 \text{ lx}$ (typ.) Using the fluorescent light
- Little fluctuation in light current
 : Width range = $\times 1$ to $\times 1.6$ (typ. $\pm 25\%$)
- Output linearity of illuminance is excellent
- Open-emitter output
- Compact and light surface-mount package

Absolute Maximum Ratings ($T_a = 25^\circ\text{C}$)

Characteristics	Symbol	Rating	Unit
Supply voltage	V_{CC}	-0.5 to 7	V
Output voltage	V_{OUT}	$\leq V_{CC}$	V
Light current	I_L	10	mA
Permissible power dissipation	P	70	mW
Operating temperature range	T_{opr}	-30 to 85	$^\circ\text{C}$
Storage temperature range	T_{stg}	-40 to 100	$^\circ\text{C}$
Soldering temperature range (10 s) (Note 1)	T_{sol}	260	$^\circ\text{C}$

Note: Using continuously under heavy loads (e.g. the application of high temperature/current/voltage and the significant change in temperature, etc.) may cause this product to decrease in the reliability significantly even if the operating conditions (i.e. operating temperature/current/voltage, etc.) are within the absolute maximum ratings and the operating ranges.

Please design the appropriate reliability upon reviewing the Toshiba Semiconductor Reliability Handbook ("Handling Precautions"/"Derating Concept and Methods") and individual reliability data (i.e. reliability test report and estimated failure rate, etc).

Note 1: The reflow time and the recommended temperature profile are shown in the section entitled Handling Precautions.

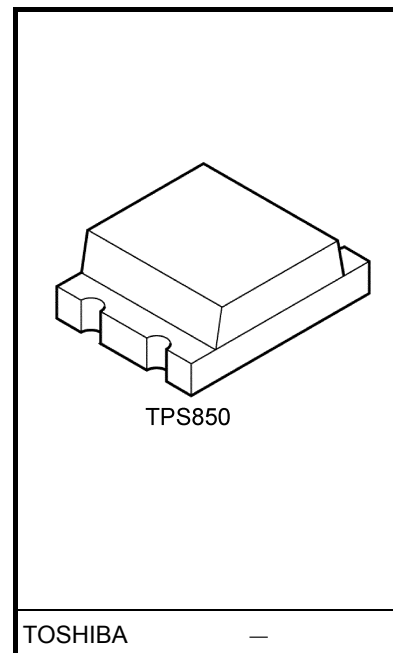

Weight: 0.017 g (typ.)

Electrical and Optical Characteristics (Ta = 25°C)

Characteristics	Symbol	Test Condition	Min	Typ.	Max	Unit
Supply voltage	V _{CC}	—	2.7	—	5.5	V
Supply current	I _{CC}	V _{CC} = 3 V, E _V = 1000 lx, R _L = 250 Ω (Note 2)	—	4	—	mA
Light current (1)	I _L (1)	V _{CC} = 3 V, E _V = 100 lx (Note 2, 4)	—	300	—	μA
Light current (2)	I _L (2)	V _{CC} = 3 V, E _V = 10 lx (Note 3, 4)	18	23	30	
Light current (3)	I _L (3)	V _{CC} = 3 V, E _V = 100 lx (Note 3, 4)	180	230	300	
Light current ratio	$\frac{I_L (1)}{I_L (3)}$		—	1.3	1.7	
Dark current	I _{LEAK}	V _{CC} = 3.3 V, E _V = 0	—	—	0.5	μA
Saturation output voltage	V _o	V _{CC} = 3 V, R _L = 75 kΩ, E _V = 100 lx (Note 3)	2.2	2.35	—	V
Peak sensitivity wavelength	λ _p	—	—	640	—	nm
Switching time	Rise time	V _{CC} = 3 V, R _L = 5 kΩ, (Note 5)	—	0.2	1	ms
	Fall time		—	0.35	2	

Note 2: CIE standard A light source is used (color temperature = 2856K, approximated incandescence light).

Note 3: Fluorescence light is used as light source. However, white LED is substituted in a mass-production process.

Note 4: Light current measurement circuit

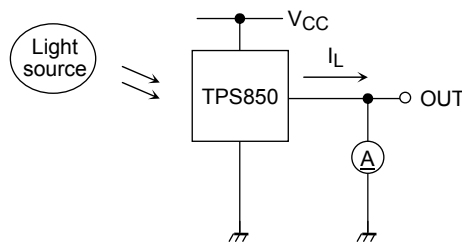

Note 5: Rise time/fall time measurement method

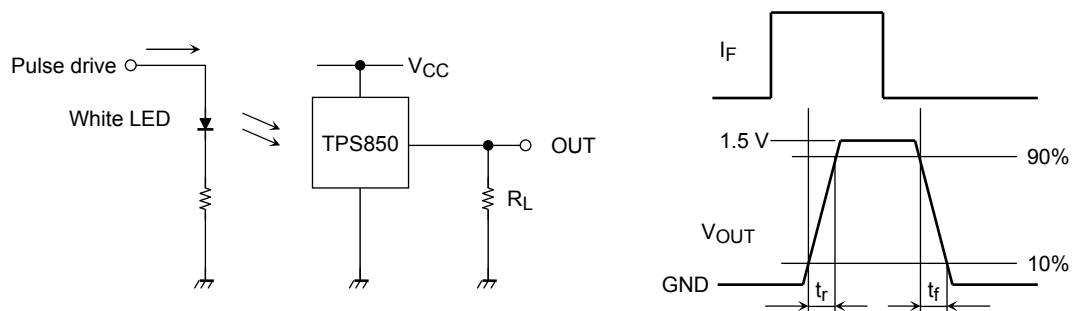

Package Dimensions

TPS850

Unit: mm

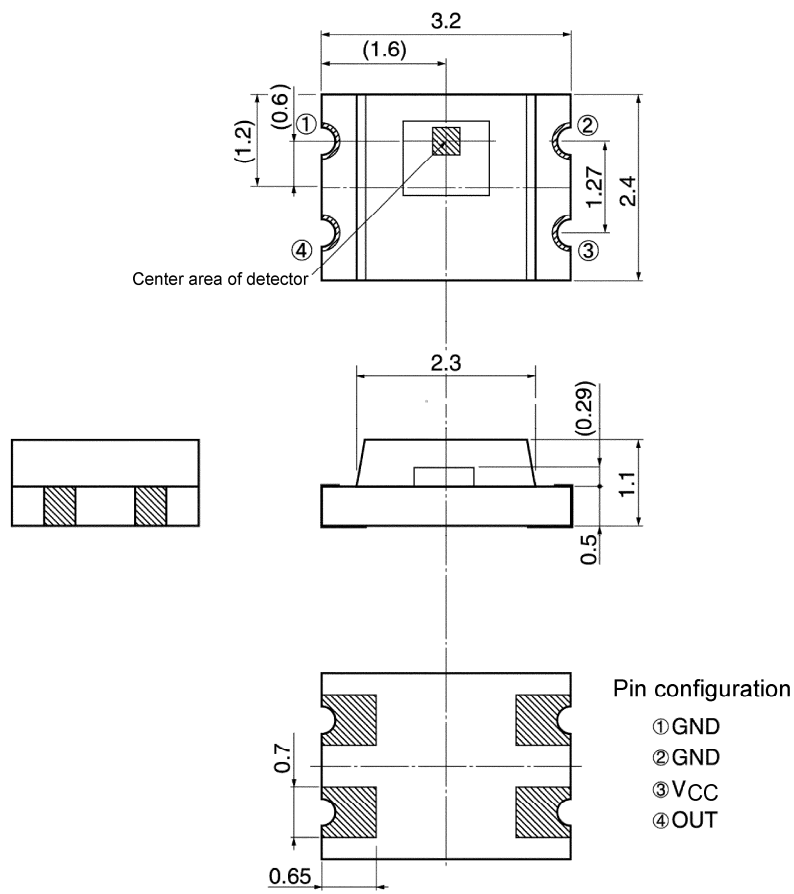

Tolerance: ± 0.2

▨: Sensitive area

Sensitive area: (□0.35)

() : Reference value

Weight: 0.017 g (typ.)

Block Diagram

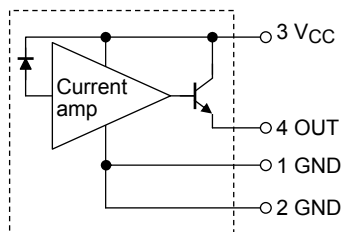

Handling Precautions

At power-on in darkness, the internal circuit takes about 50 ms to stabilize. During this period the output signal is unstable and may change. Please take this into account.

Moisture-Proof Packing

- (1) To avoid moisture absorption by the resin, the product is packed in an aluminum envelope with silica gel.
- (2) Since the optical characteristics of the device can be affected during soldering by vaporization resulting from prior absorption of moisture and they should therefore be stored under the following conditions:

Temperature: 5°C to 30°C, Relative humidity: 60% (max), Time: 168 h

- (3) Baking is required if the devices have been store unopened for more than six months or if the aluminum envelope has been opened for more than 168 h.

These devices are packed on tapes; hence, please avoid baking at high temperature.

Recommended baking conditions: 60°C for 12 h or longer

Mounting Precautions

- (1) Do not apply stress to the resin at high temperature.
- (2) The resin part is easily scratched, so avoid friction with hard materials.
- (3) When installing the assembly board in equipment, ensure that this product does not come into contact with other components.

Mounting Methods

- (1) Reflow soldering
 - Package surface temperature: 260°C (max)
 - Please perform reflow soldering using the following reference temperature profile. Perform reflow soldering no more than twice.

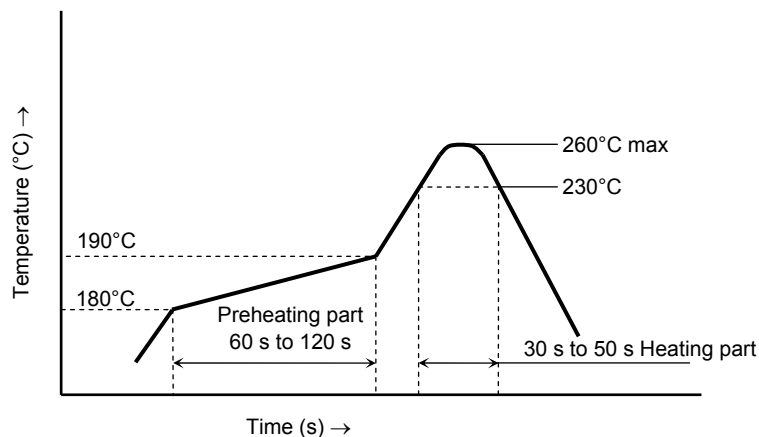

- Please perform the first reflow soldering within 168 h after opening the package with reference to the above temperature profile.
- Second reflow soldering
 - In case of second reflow soldering, it should be performed within 168 h after first reflow under the above conditions.
 - Storage conditions before second reflow soldering: 30°C, 60% RH or lower
- Do not perform flow soldering.
- Make any necessary soldering correction manually.
 - (do not do this more than once for any given pin.)
 - Temperature: no more than 350°C (25 W for soldering iron)
 - Time: within 5 s

(2) Recommended soldering pattern

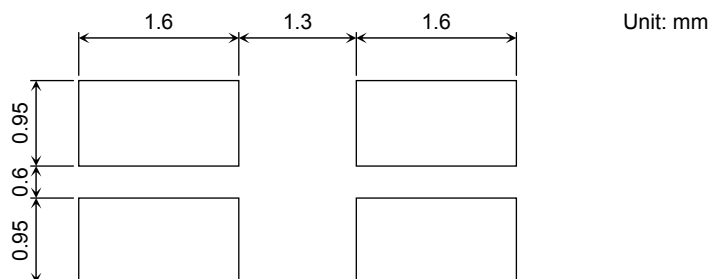

(3) Cleaning conditions

When cleaning is required after soldering

Chemicals: AK225 alcohol

Temperature and time: 50°C × 30 s or : 30°C × 3 minutes

Ultrasonic cleaning: 300 W or less

Packing Specification

(1) Packing quantity

Reel (minimum packing quantity)	3000 devices
Carton	5 reels (15000 devices)

(2) Packing format

An aluminum envelope containing silica gel and reels is deaerated and sealed.

Pack shock-absorbent materials around the aluminum envelopes in the cartons to cushion them.

- Carton specification

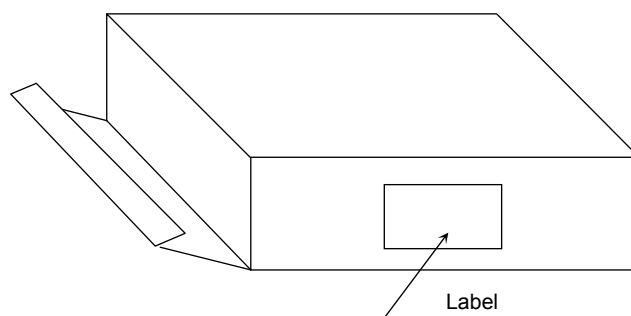

Carton dimensions

(W) 81 mm × (L) 280 mm × (H) 280 mm

Tape Packing Specifications

(1) Reel dimensions

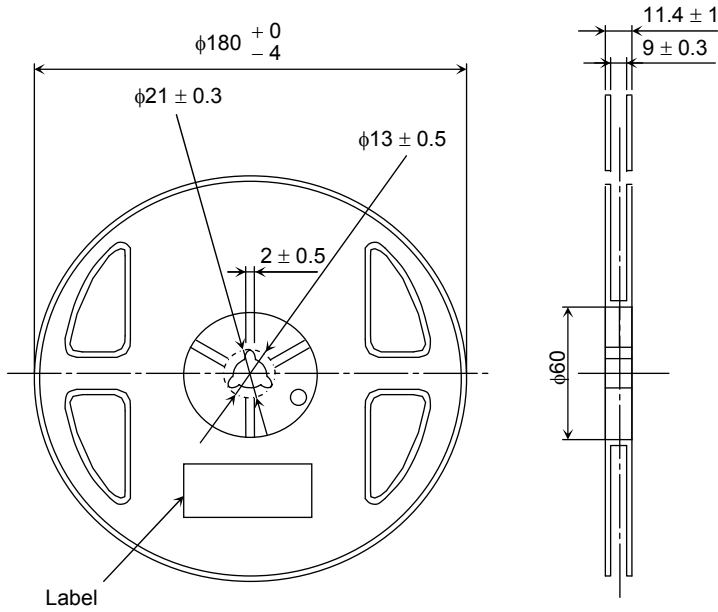

(2) Tape dimensions

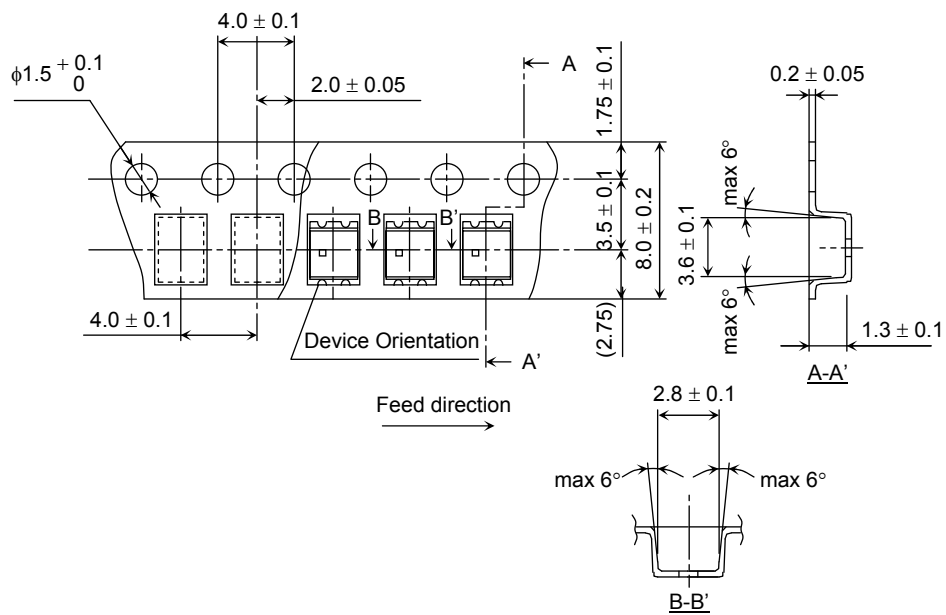

(3) Packing quantity: 3000/reel

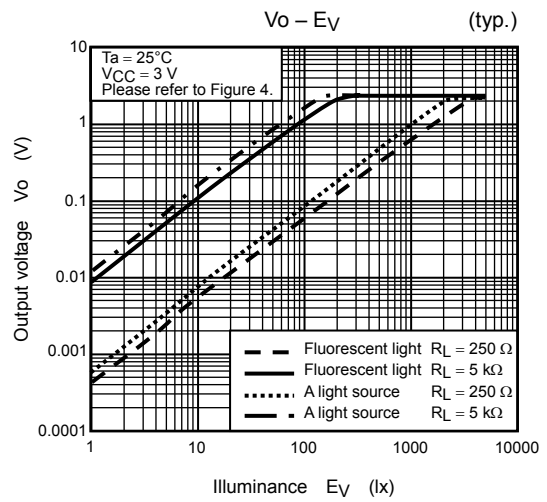
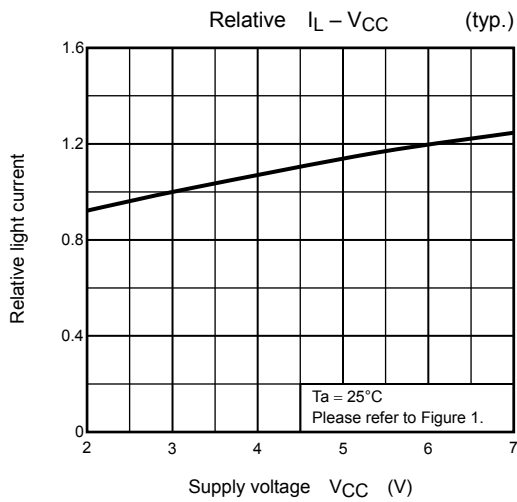
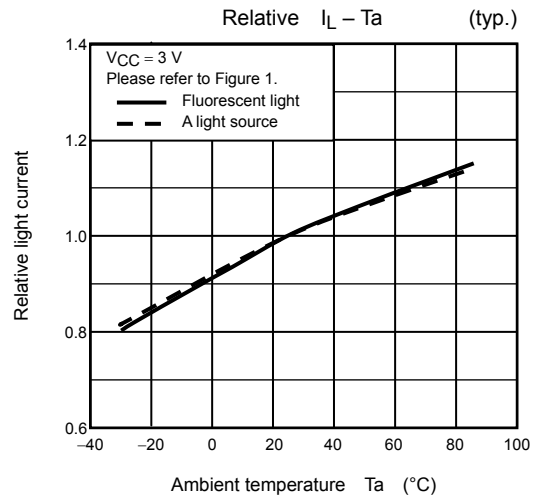
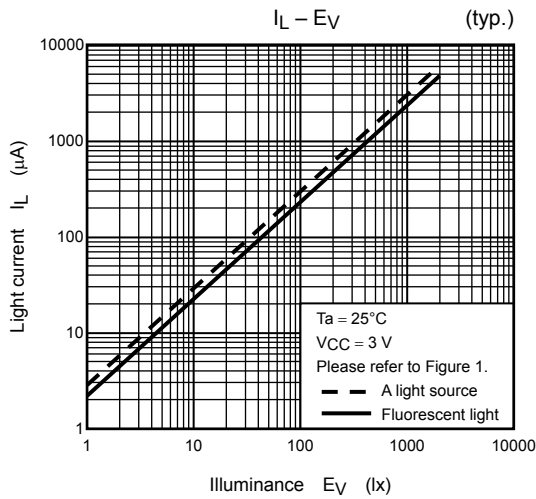
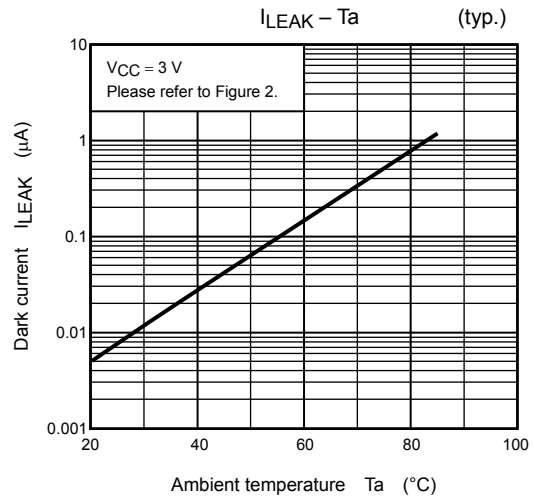
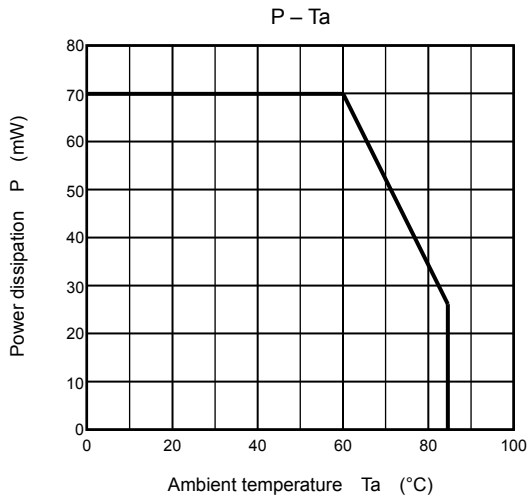

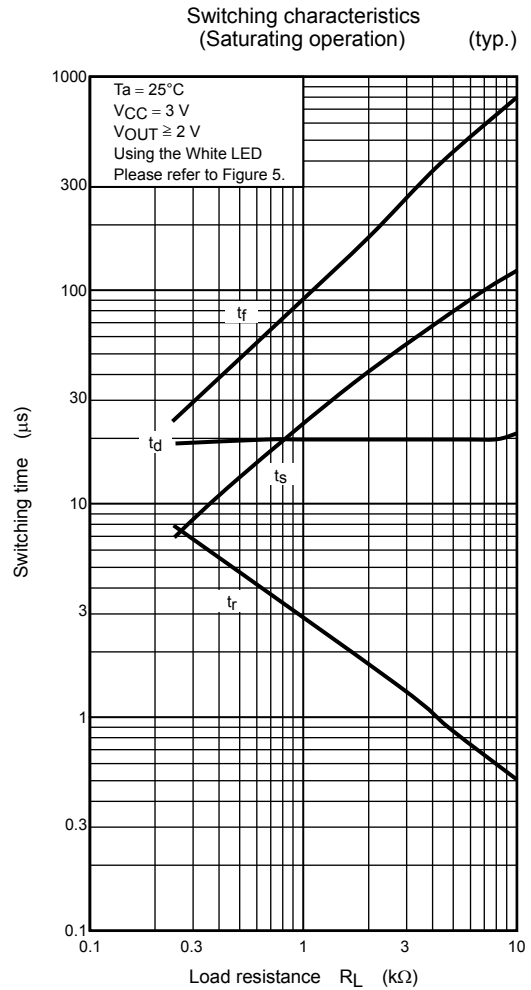
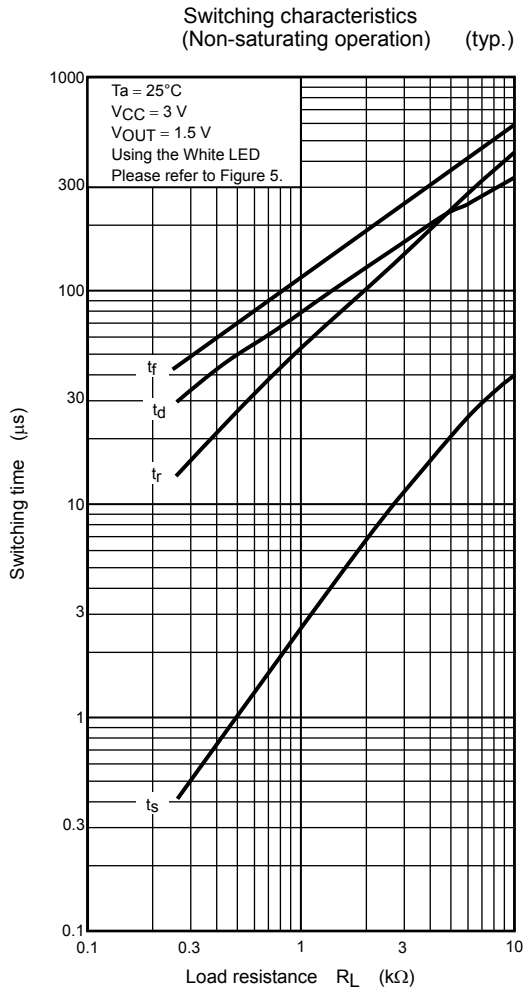
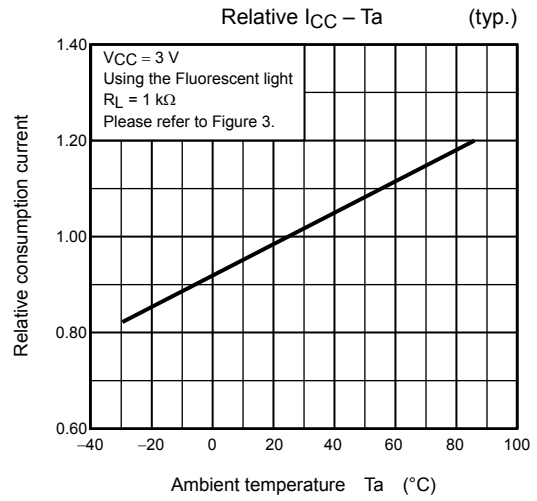
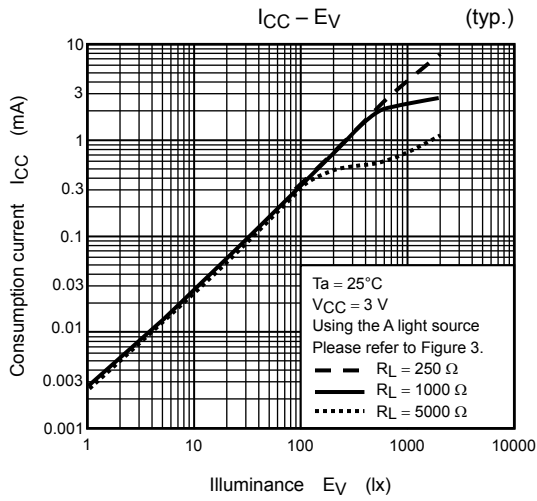

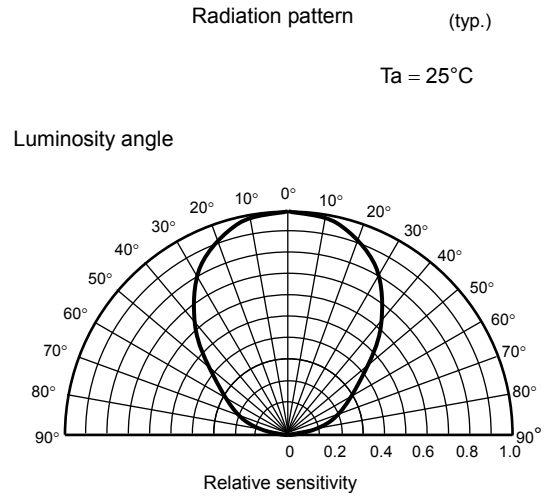
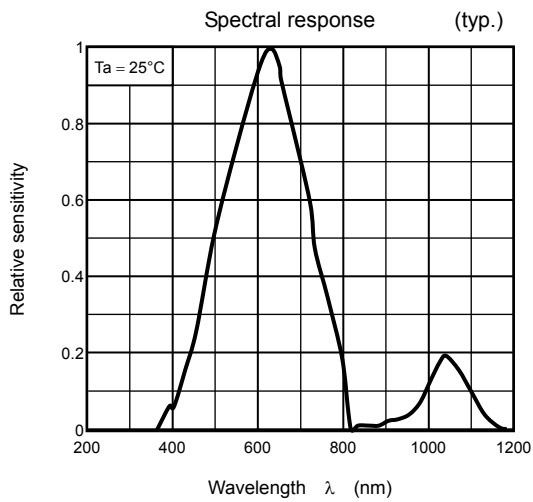

Measurement Circuits

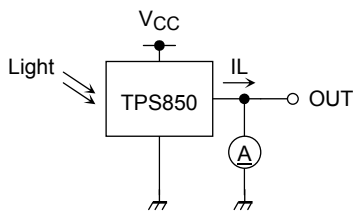

Figure 1 Light current measurement circuit

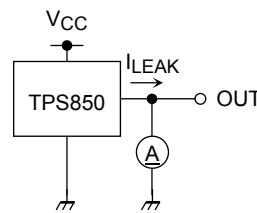

Figure 2 Dark current measurement circuit

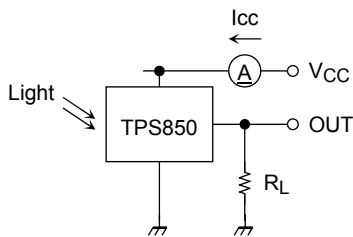

Figure 3 Consumption current measurement circuit

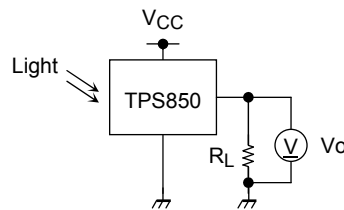

Figure 4 Output voltage measurement circuit

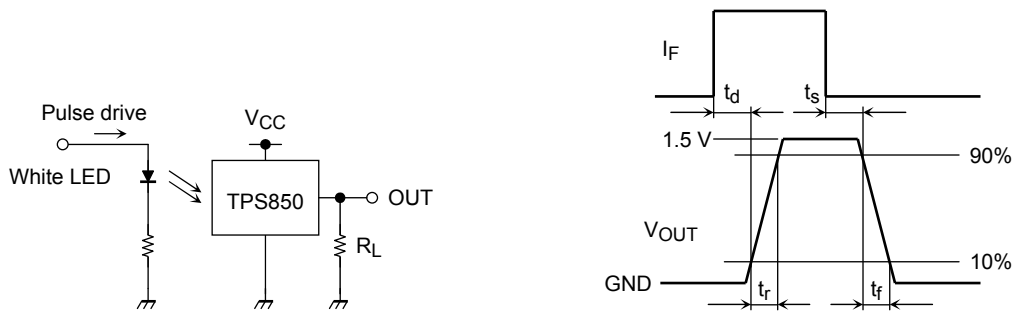

Figure 5 Switching measurement circuit and waveform

RESTRICTIONS ON PRODUCT USE

- Toshiba Corporation, and its subsidiaries and affiliates (collectively "TOSHIBA"), reserve the right to make changes to the information in this document, and related hardware, software and systems (collectively "Product") without notice.
- This document and any information herein may not be reproduced without prior written permission from TOSHIBA. Even with TOSHIBA's written permission, reproduction is permissible only if reproduction is without alteration/omission.
- Though TOSHIBA works continually to improve Product's quality and reliability, Product can malfunction or fail. Customers are responsible for complying with safety standards and for providing adequate designs and safeguards for their hardware, software and systems which minimize risk and avoid situations in which a malfunction or failure of Product could cause loss of human life, bodily injury or damage to property, including data loss or corruption. Before creating and producing designs and using, customers must also refer to and comply with (a) the latest versions of all relevant TOSHIBA information, including without limitation, this document, the specifications, the data sheets and application notes for Product and the precautions and conditions set forth in the "TOSHIBA Semiconductor Reliability Handbook" and (b) the instructions for the application that Product will be used with or for. Customers are solely responsible for all aspects of their own product design or applications, including but not limited to (a) determining the appropriateness of the use of this Product in such design or applications; (b) evaluating and determining the applicability of any information contained in this document, or in charts, diagrams, programs, algorithms, sample application circuits, or any other referenced documents; and (c) validating all operating parameters for such designs and applications. **TOSHIBA ASSUMES NO LIABILITY FOR CUSTOMERS' PRODUCT DESIGN OR APPLICATIONS.**
- Product is intended for use in general electronics applications (e.g., computers, personal equipment, office equipment, measuring equipment, industrial robots and home electronics appliances) or for specific applications as expressly stated in this document. Product is neither intended nor warranted for use in equipment or systems that require extraordinarily high levels of quality and/or reliability and/or a malfunction or failure of which may cause loss of human life, bodily injury, serious property damage or serious public impact ("Unintended Use"). Unintended Use includes, without limitation, equipment used in nuclear facilities, equipment used in the aerospace industry, medical equipment, equipment used for automobiles, trains, ships and other transportation, traffic signaling equipment, equipment used to control combustions or explosions, safety devices, elevators and escalators, devices related to electric power, and equipment used in finance-related fields. Do not use Product for Unintended Use unless specifically permitted in this document.
- Do not disassemble, analyze, reverse-engineer, alter, modify, translate or copy Product, whether in whole or in part.
- Product shall not be used for or incorporated into any products or systems whose manufacture, use, or sale is prohibited under any applicable laws or regulations.
- The information contained herein is presented only as guidance for Product use. No responsibility is assumed by TOSHIBA for any infringement of patents or any other intellectual property rights of third parties that may result from the use of Product. No license to any intellectual property right is granted by this document, whether express or implied, by estoppel or otherwise.
- **ABSENT A WRITTEN SIGNED AGREEMENT, EXCEPT AS PROVIDED IN THE RELEVANT TERMS AND CONDITIONS OF SALE FOR PRODUCT, AND TO THE MAXIMUM EXTENT ALLOWABLE BY LAW, TOSHIBA (1) ASSUMES NO LIABILITY WHATSOEVER, INCLUDING WITHOUT LIMITATION, INDIRECT, CONSEQUENTIAL, SPECIAL, OR INCIDENTAL DAMAGES OR LOSS, INCLUDING WITHOUT LIMITATION, LOSS OF PROFITS, LOSS OF OPPORTUNITIES, BUSINESS INTERRUPTION AND LOSS OF DATA, AND (2) DISCLAIMS ANY AND ALL EXPRESS OR IMPLIED WARRANTIES AND CONDITIONS RELATED TO SALE, USE OF PRODUCT, OR INFORMATION, INCLUDING WARRANTIES OR CONDITIONS OF MERCHANTABILITY, FITNESS FOR A PARTICULAR PURPOSE, ACCURACY OF INFORMATION, OR NONINFRINGEMENT.**
- Do not use or otherwise make available Product or related software or technology for any military purposes, including without limitation, for the design, development, use, stockpiling or manufacturing of nuclear, chemical, or biological weapons or missile technology products (mass destruction weapons). Product and related software and technology may be controlled under the Japanese Foreign Exchange and Foreign Trade Law and the U.S. Export Administration Regulations. Export and re-export of Product or related software or technology are strictly prohibited except in compliance with all applicable export laws and regulations.
- Please contact your TOSHIBA sales representative for details as to environmental matters such as the RoHS compatibility of Product. Please use Product in compliance with all applicable laws and regulations that regulate the inclusion or use of controlled substances, including without limitation, the EU RoHS Directive. TOSHIBA assumes no liability for damages or losses occurring as a result of noncompliance with applicable laws and regulations.