

TPS853

- Mobile Phones, PHS
- Notebook PCs, PDAs
- Video cameras, Digital Still Cameras
- Other Equipment Requiring Luminosity Adjustment

The TPS853 is an ultra-compact surface-mount photo-IC for illuminance sensors which incorporates a photodiode and current amp circuit in a single chip.

The sensitivity is superior to that of a phototransistor, and exhibits little variation.

It has spectral sensitivity closer to luminous efficiency and excellent output linearity.

With its ultra-compact surface-mount package, this photo-IC can be used as the power-saving control for domestic appliances or for backlighting for displays in cellular phones, this device enables low power consumption to be achieved.

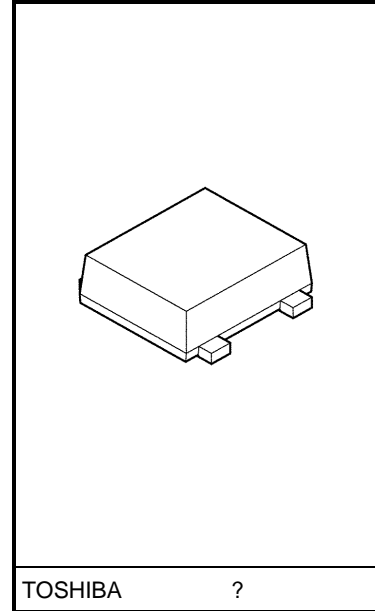

Weight: 0.0054 g (typ.)

- Ultra-compact and light surface-mount package suitable for lead-free soldering and reflow soldering: 2.0 × 2.1 × 0.7 mm
- Excellent output linearity of illuminance
- Little fluctuation in light current and high level of sensitivity
 - : $I_L = 37 \mu\text{A}$ to $74 \mu\text{A}$ @EV = 100 lx using fluorescent light
 - : Light current variation width: ×1.67 (when light current classification is specified.)
 - : Little temperature fluctuation
- Built-in luminous-efficiency correction function, reduced sensitivity variations due to various light sources
 - : I_L (using incandescent light)/ I_L (using fluorescent light) = 1.2 (typ.)
- Low supply voltage, making device suitable for battery-powered equipment: $V_{CC} = 2.2 \text{ V}$ to 5.5 V

Maximum Ratings (Ta = 25°C)

Characteristics	Symbol	Rating	Unit
Supply voltage	V_{CC}	-0.5 to 7	V
Output voltage	V_{OUT}	$\leq V_{CC}$	V
Stand-by voltage	V_{stb}	$\leq V_{CC}$	V
Light current	I_L	5	mA
Permissible power dissipation	P	35	mW
Operating temperature range	T_{opr}	-30 to 85	°C
Storage temperature range	T_{stg}	-40 to 100	°C
Soldering temperature range (Note 1)	T_{sol}	260	°C

Note 1: The reflow time and the recommended temperature profile are shown in the section entitled Handling Precautions.

Recommendation operation conditions

Characteristics	Symbol	Min	Typ.	Max	Unit
Supply voltage	V_{CC}	2.2	—	5.5	V
Stand-by voltage	V_{stb}	2.2	—	V_{CC}	V

Electrical and Optical Characteristics (Ta = 25°C)

Characteristics	Symbol	Test Condition	Min	Typ.	Max	Unit
Supply voltage	V_{CC}	—	2.2	—	5.5	V
Supply current	$I_{CC}+I_{stb}$	$V_{CC} = 3\text{ V}, V_{stb} = 3\text{ V}, E_V = 1000\text{ lx}$ (Note 2)	—	624	—	μA
Supply current	$I_{CC}+I_{stb}$	$V_{CC} = 3\text{ V}, V_{stb} = 0.3\text{ V}, E_V = 1000\text{ lx}$ (Note 2)	—	4.2	—	μA
Light current (1)	$I_L (1)$	$V_{CC} = 3\text{ V}, V_{stb} = 3\text{ V}, E_V = 100\text{ lx}$ (Note 2), (Note 4)	—	62	—	μA
Light current (2)	$I_L (2)$	$V_{CC} = 3\text{ V}, V_{stb} = 3\text{ V}, E_V = 10\text{ lx}$ (Note 3), (Note 4)	3.7	5.2	7.4	μA
Light current (3)	$I_L (3)$	$V_{CC} = 3\text{ V}, V_{stb} = 3\text{ V}, E_V = 100\text{ lx}$ (Note 3), (Note 4)	37	52	74	μA
Light current ratio	$\frac{I_L (1)}{I_L (3)}$	—	—	1.2	1.7	
Dark current	I_{LEAK}	$V_{CC} = 3.3\text{ V}, V_{stb} = 3.3\text{ V}, E_V = 0$	—	—	0.1	μA
Saturation output voltage	V_O	$V_{CC} = 3\text{ V}, V_{stb} = 3\text{ V}, R_L = 150\text{ k}\Omega,$ $E_V = 100\text{ lx}$ (Note 3)	2.2	2.35	—	V
Peak sensitivity wavelength	λ_p	—	—	600	—	nm
Switching time	Rise time	$V_{CC} = 3\text{ V}, R_L = 5\text{ k}\Omega$ (Note 5)	—	0.07	1	ms
	Fall time		—	0.4	2	

Note 2: CIE standard A light source is used (color temperature = 2856K, approximated incandescence light).

Note 3: Fluorescence light is used as light source. However, white LED is substituted in a mass-production process.

I_L classification $I_L (3) \rightarrow A: 39\text{ }\mu\text{A}$ to $65\text{ }\mu\text{A}$

Note 4: Light current measurement circuit

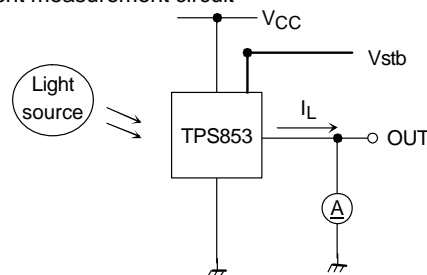

Note 5: Rise time/fall time time measurement method

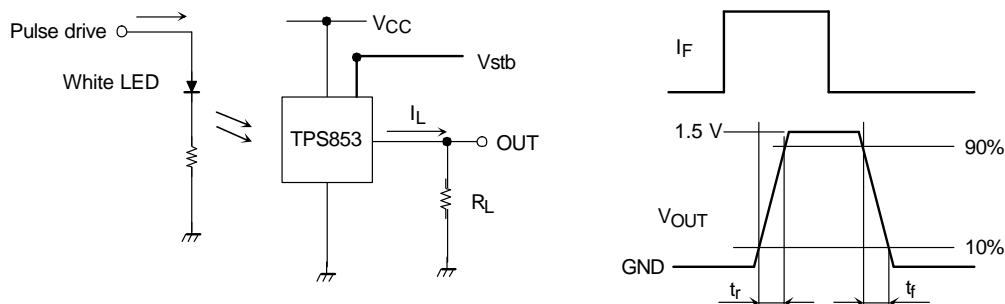

Package Dimensions

Unit: mm
 Tolerance: ± 0.1
 (): Reference value

 : Light-receiving area
 Size of light-receiving area:
 (0.51x0.13 mm)

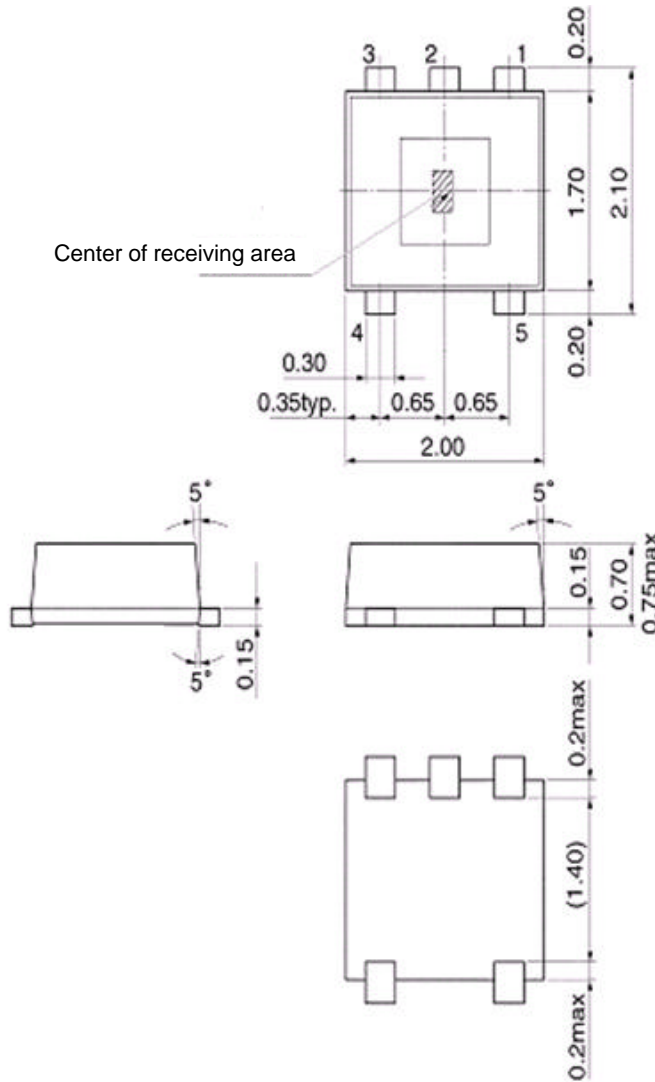

Pin connection

- 1. V_{CC}
- 2. GND
- 3. NC
- 4. V_{stb}
- 5. OUT

Weight: 0.0054 g (typ.)

Block Diagram

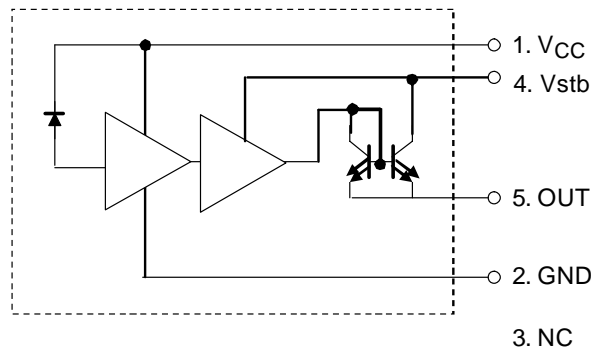

Moisture-Proof Packing

- (1) To avoid moisture absorption by the resin, the product is packed in an aluminum envelope with silica gel.
- (2) Since the optical characteristics of the device can be affected during soldering by vaporization resulting from prior absorption of moisture and they should therefore be stored under the following conditions:
Temperature: 5°C to 30°C, Relative humidity: 70% (max), Time: 168 h (max)
- (3) Baking is required if the devices have been store unopened for more than six months or if the aluminum envelope has been opened for more than 168 h.
These devices are packed on tapes; hence, please avoid baking at high temperature.
Recommended baking conditions: 60°C for 12 h or longer

Mounting Precautions

- (1) Do not apply stress to the resin at high temperature.
- (2) The resin part is easily scratched, so avoid friction with hard materials.
- (3) When installing the assembly board in equipment, ensure that this product does not come into contact with other components.

Mounting Methods

- (1) Reflow soldering
 - Package surface temperature: 260°C (max)
 - Please perform reflow soldering using the following reference temperature profile. Perform reflow soldering no more than twice.

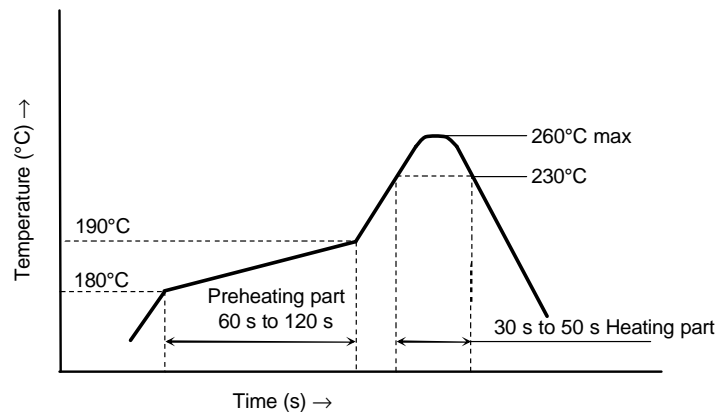

- Please perform the first reflow soldering within 168 h after opening the package with reference to the above temperature profile.
- Second reflow soldering
In case of second reflow soldering, it should be performed within 168 h after first reflow under the above conditions.
Storage conditions before second reflow soldering: 30°C, 70% RH or lower
- Do not perform flow soldering.
- Make any necessary soldering correction manually.
(do not do this more than once for any given pin.)
Temperature: no more than 350°C (25 W for soldering iron)
Time: within 5 s

(2) Recommended soldering pattern

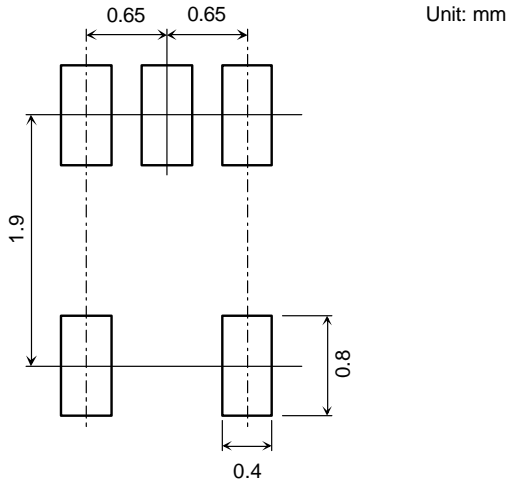

(3) Cleaning conditions

When cleaning is required after soldering

Chemicals: AK225 alcohol

Temperature and time: 50°C × 30 s or 30°C × 3 minutes

Ultrasonic cleaning: 300 W or less

Packing Specification

(1) Packing quantity

Reel (minimum packing quantity)	3,000 devices
Carton	5 reels (15,000 devices)

(2) Packing format

An aluminum envelope containing silica gel and reels is deaerated and sealed.

Pack shock-absorbent materials around the aluminum envelopes in the cartons to cushion them.

- Carton specification

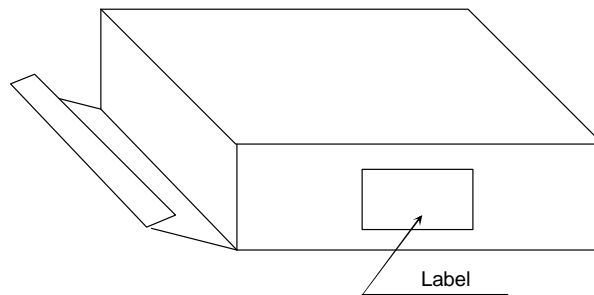

Carton dimensions

(W) 81 mm × (L) 280 mm × (H) 280 mm

Tape Packing Specifications

- (1) Reel dimensions
Reel material: Plastic

Unit: mm

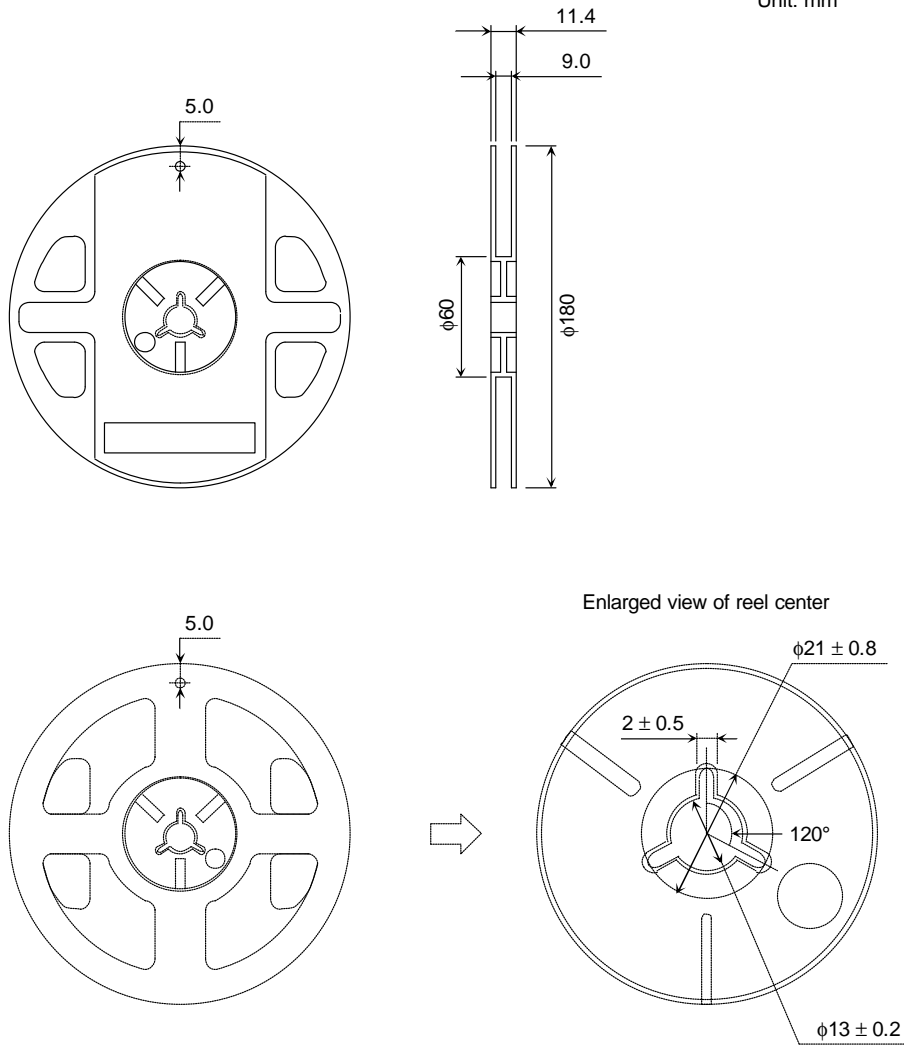

(2) Tape dimensions

Tape material: Plastic (anti-electrostatic)

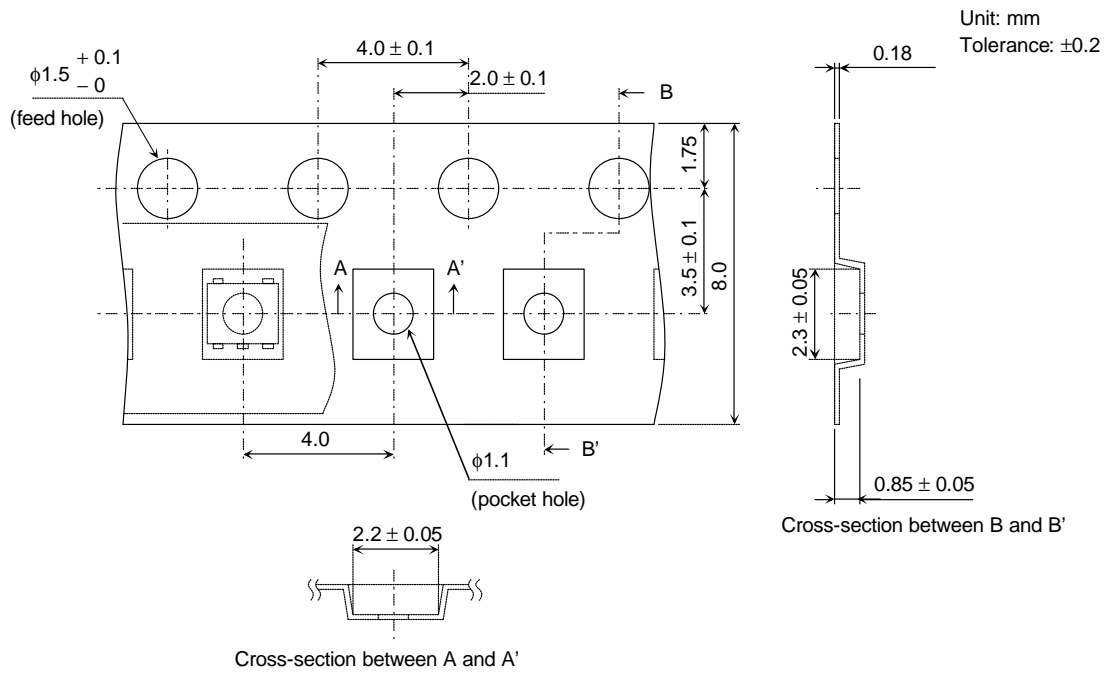

Reel Label

The label markings may include product number, tape type and quantity.

P/N			
TYPE	TPS853		
ADDC		Q'TY	3,000 pcs.
NOTE			

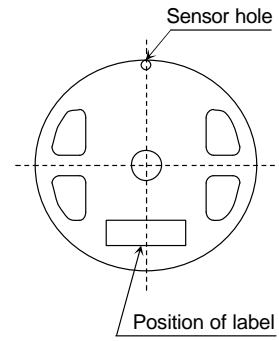

Leader and Trailer Sections of Tape

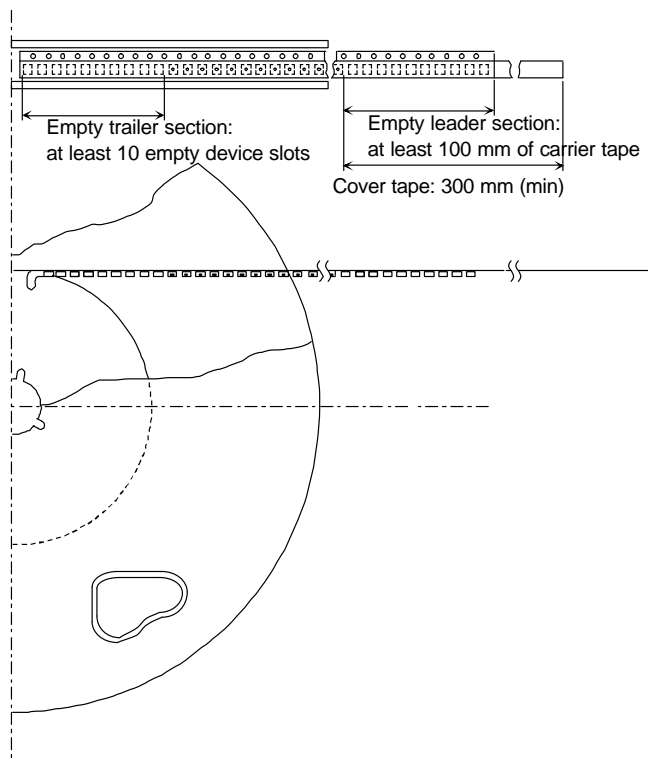

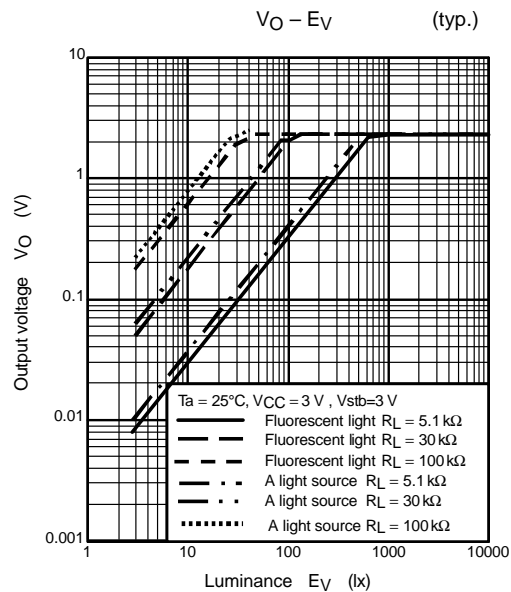
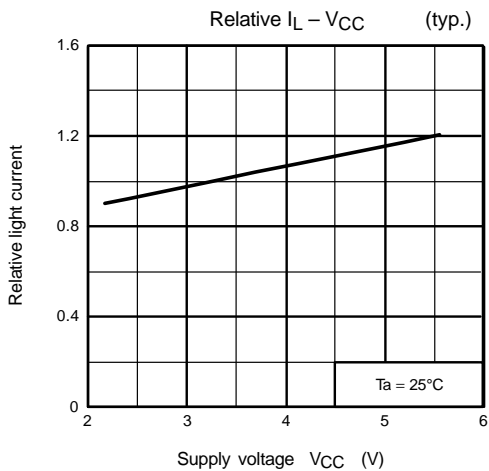
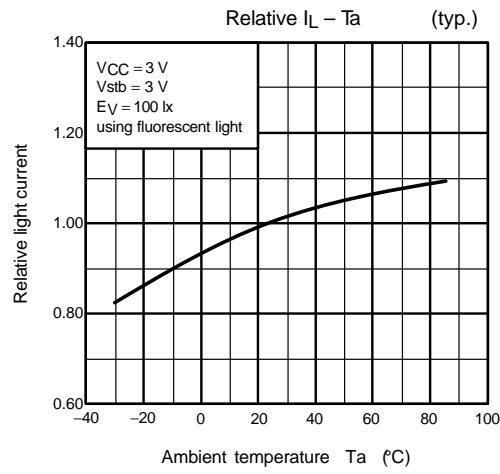
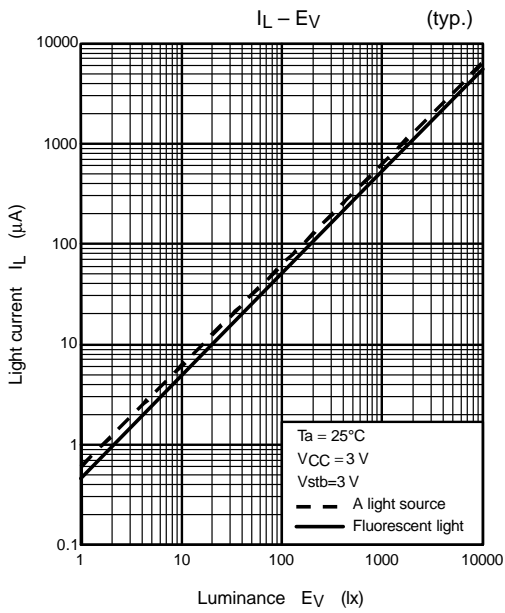
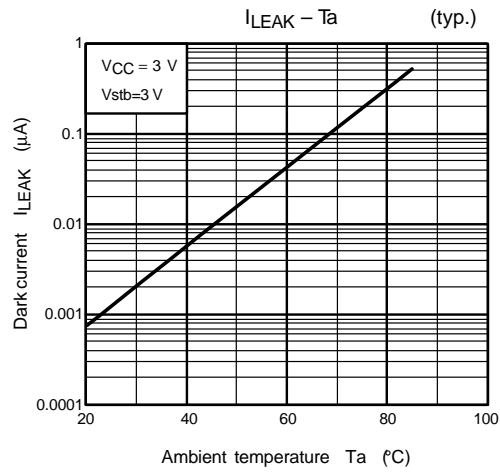
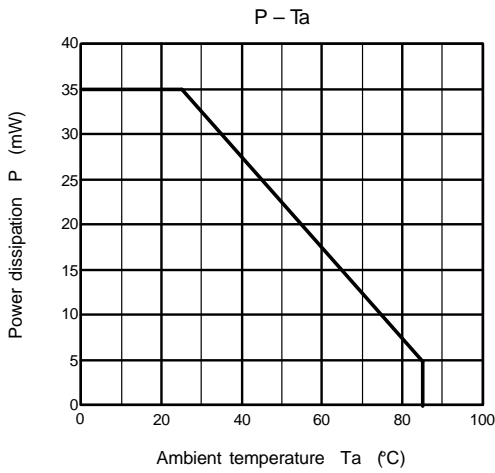

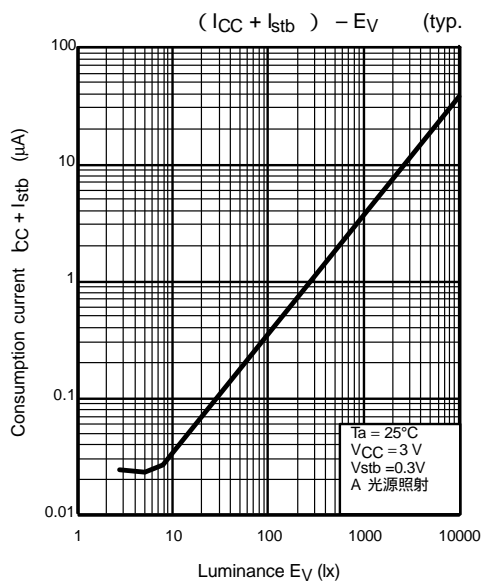
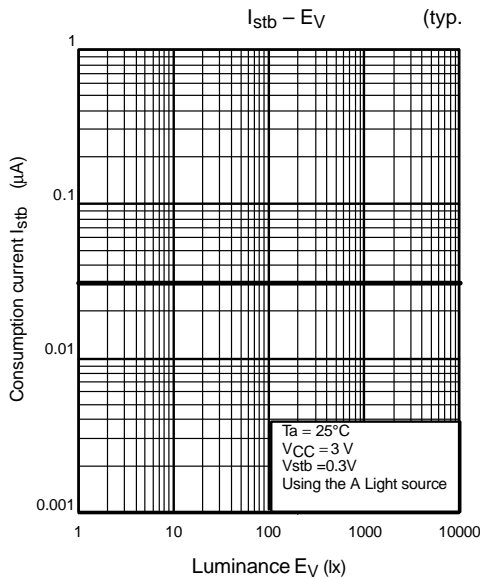
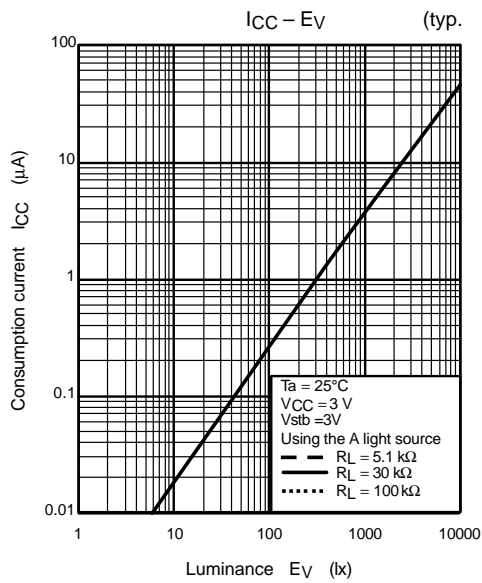
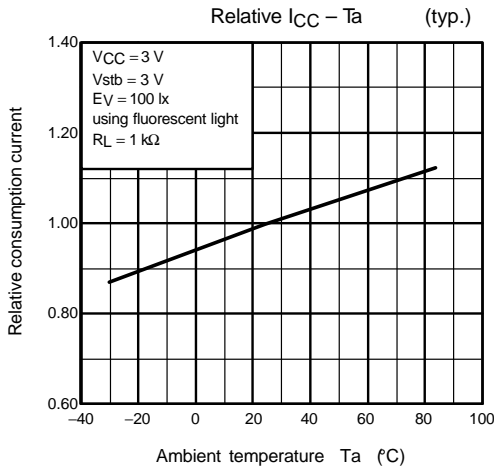
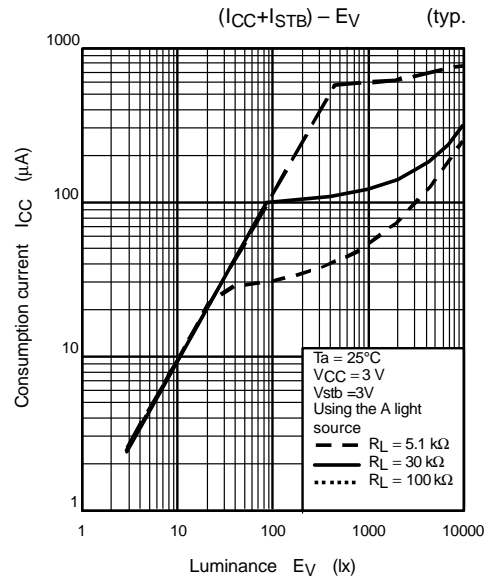
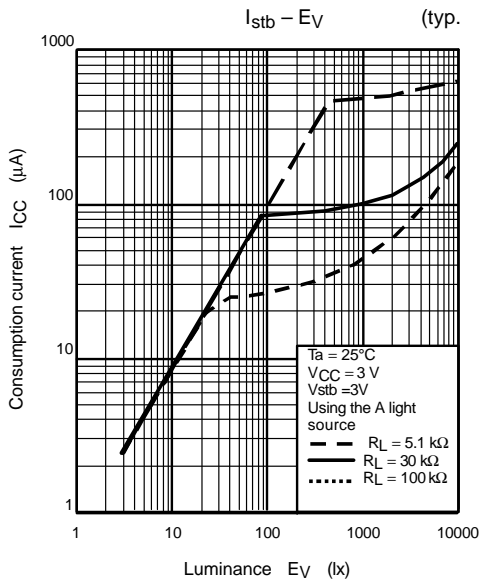

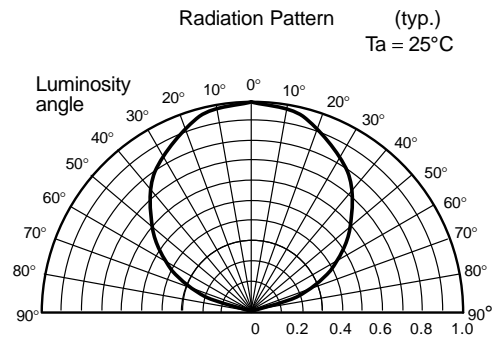
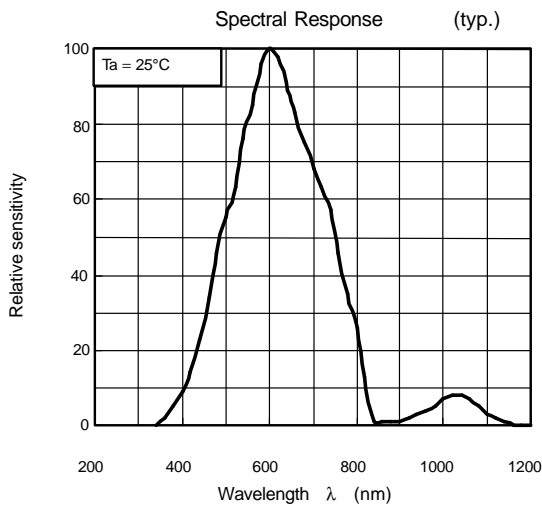
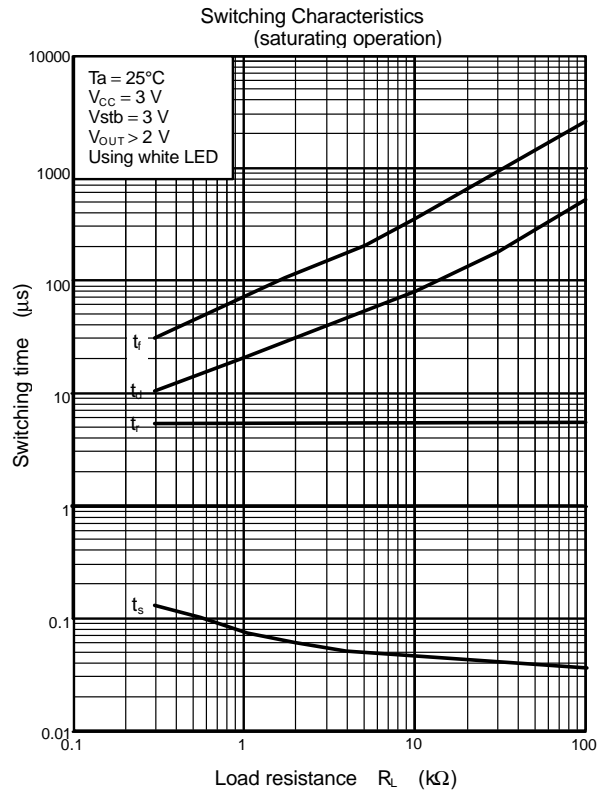
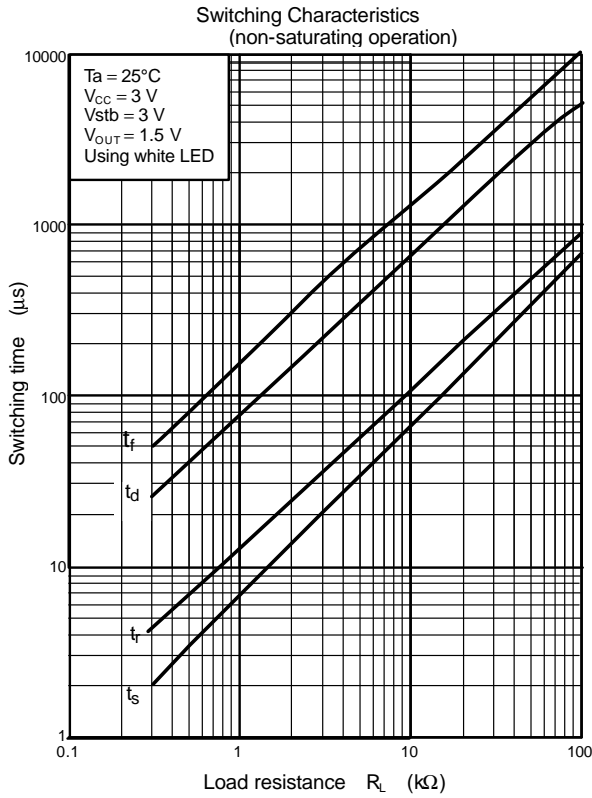

RESTRICTIONS ON PRODUCT USE

030619EBA

- The information contained herein is subject to change without notice.
- The information contained herein is presented only as a guide for the applications of our products. No responsibility is assumed by TOSHIBA for any infringements of patents or other rights of the third parties which may result from its use. No license is granted by implication or otherwise under any patent or patent rights of TOSHIBA or others.
- TOSHIBA is continually working to improve the quality and reliability of its products. Nevertheless, semiconductor devices in general can malfunction or fail due to their inherent electrical sensitivity and vulnerability to physical stress. It is the responsibility of the buyer, when utilizing TOSHIBA products, to comply with the standards of safety in making a safe design for the entire system, and to avoid situations in which a malfunction or failure of such TOSHIBA products could cause loss of human life, bodily injury or damage to property.
In developing your designs, please ensure that TOSHIBA products are used within specified operating ranges as set forth in the most recent TOSHIBA products specifications. Also, please keep in mind the precautions and conditions set forth in the "Handling Guide for Semiconductor Devices," or "TOSHIBA Semiconductor Reliability Handbook" etc..
- The TOSHIBA products listed in this document are intended for usage in general electronics applications (computer, personal equipment, office equipment, measuring equipment, industrial robotics, domestic appliances, etc.). These TOSHIBA products are neither intended nor warranted for usage in equipment that requires extraordinarily high quality and/or reliability or a malfunction or failure of which may cause loss of human life or bodily injury ("Unintended Usage"). Unintended Usage include atomic energy control instruments, airplane or spaceship instruments, transportation instruments, traffic signal instruments, combustion control instruments, medical instruments, all types of safety devices, etc.. Unintended Usage of TOSHIBA products listed in this document shall be made at the customer's own risk.
- The products described in this document are subject to the foreign exchange and foreign trade laws.
- TOSHIBA products should not be embedded to the downstream products which are prohibited to be produced and sold, under any law and regulations.