

Features

- Micropower operation
- Operation with North or South Pole
- 2.5V to 5.5V battery operation
- Inverted Output-on without Magnet present
- Chopper stabilized
 - Superior temperature stability
 - Extremely Low Switch-Point Drift
 - Insensitive to Physical Stress
- Good RF noise immunity
- -40°C to 85°C operating temperature
- Low profile 3 pin SC59 (commonly known as SOT23 in Asia) and DFN2020-3, DFN2020-6 package
- ESD (HBM) > 5KV for DFN2020-3 and DFN2020-6
> 6KV for SC59
- SC59, DFN2020-3 and DFN2020-6: Available in "Green" Molding Compound (No Br, Sb)
- Lead Free Finish / RoHS Compliant (Note 1)

General Description

AH1801 is a Micropower, Ultra-sensitive Hall Effect Switch, which is with two Hall effect plates and a output driver, mainly designed for battery-operation, hand-held equipment (such as Cellular and Cordless Phone, PDA). The total operation power is down to 24uW in the 3V supply.

Either north or south pole of sufficient strength will turn the output off. The output will be turned on under no magnetic field. While the magnetic flux density (**B**) is larger than operate point (**Bop**), the output will be turned off, the output is held until **B** is lower than release point (**Brp**), then turned on.

Applications

- Cellular phone
- PDA
- Cordless phone

Ordering Information

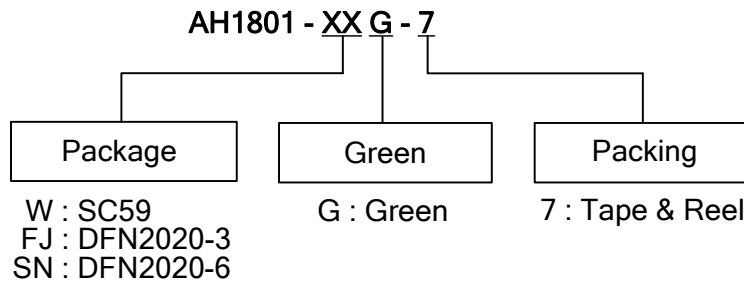

Device	Package Code	Packaging (Note 2)	7" Tape and Reel	
			Quantity	Part Number Suffix
AH1801-WG-7	W	SC59	3000/Tape & Reel	-7
AH1801-FJG-7	FJ	DFN2020-3	3000/Tape & Reel	-7
AH1801-SNG-7	SN	DFN2020-6	3000/Tape & Reel	-7

Notes: 1. EU Directive 2002/95/EC (RoHS). All applicable RoHS exemptions applied. Please visit our website at http://www.diodes.com/products/lead_free.html.
 2. Pad layout as shown on Diodes Inc. suggested pad layout document AP02001, which can be found on our website at <http://www.diodes.com/datasheets/ap02001.pdf>.

Pin Assignment

(1) SC59

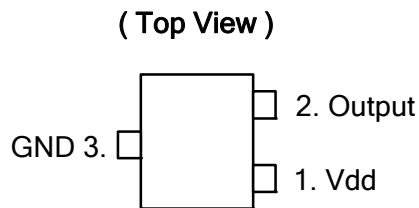

(2) DFN2020-3

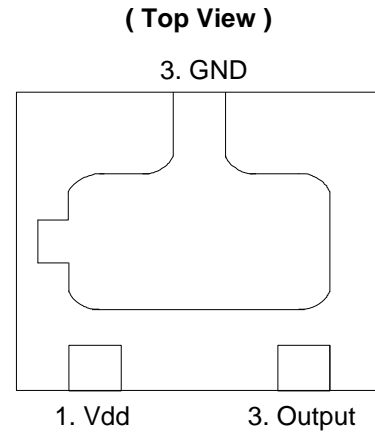

(3) DFN2020-6

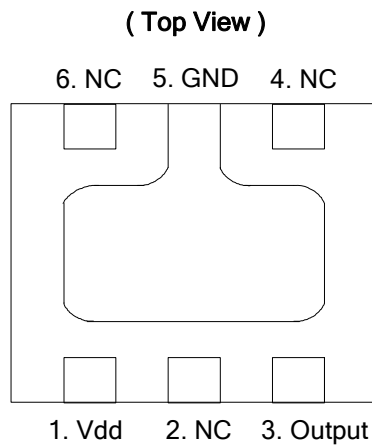

Notes: 3. NC is "No Connection", which is recommended to be tied to ground.

Pin Descriptions

Pin Name	P/I/O	Description
Vdd	P/I	Power Supply Input
GND	P/I	Ground
Output	O	Output Pin
NC		No Connected

Block Diagram

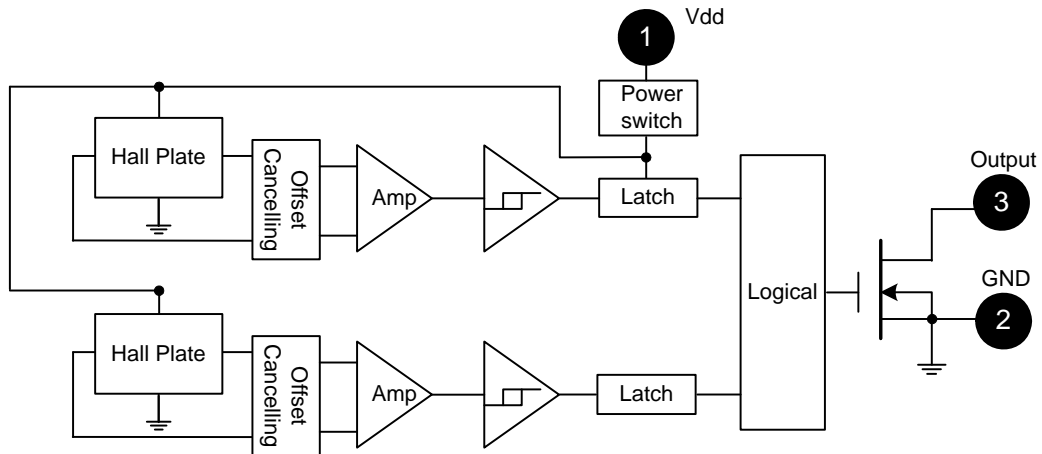

Typical Circuit

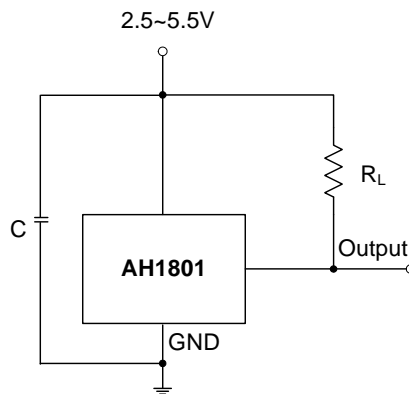

Notes: 4. C is for power stabilization and to strengthen the noise immunity, the recommended capacitance is 10nF~100nF.
R_L is the pull-up resistor, the recommended resistance is 10KΩ~100KΩ.

Absolute Maximum Ratings (at $T_A = 25^\circ\text{C}$)

Symbol	Characteristics	Values	Unit
V _{dd}	Supply voltage	7	V
B	Magnetic flux density	Unlimited	
T _s	Storage Temperature Range	-65 to +150	°C
P _D	Package Power Dissipation	SC59	mW
		DFN2020-3	
		DFN2020-6	
T _J	Maximum Junction Temp	150	°C

Recommended Operating Conditions ($T_A = 25^\circ\text{C}$)

Symbol	Parameter	Conditions	Rating	Unit
V _{dd}	Supply Voltage	Operating	2.5~5.5	V
T _A	Operating Temperature Range	Operating	-40 to +85	°C

Electrical Characteristics (T_A = +25°C, V_{dd} = 3V; unless otherwise specified)

Symbol	Characteristic	Conditions	Min	Typ	Max	Unit
V _{out}	Output On Voltage	I _{out} = 1mA	-	0.1	0.3	V
I _{off}	Output Leakage Current	V _{out} = 5.5V, Output off	-	<0.1	1	μA
I _{dd(en)}	Supply Current	Chip enable, T _A = 25°C, V _{dd} = 3V	-	3	6	mA
		Chip enable, T _A = -40~85°C, V _{dd} = 2.5~5.5V	-	3	9	mA
I _{dd(dis)}		Chip disable, T _A = 25°C, V _{dd} = 3V	-	5	10	μA
		Chip disable, T _A = -40~85°C, V _{dd} = 2.5~5.5V	-	5	18	μA
I _{dd(avg)}		Average supply current, T _A = 25°C, V _{dd} = 3V	-	8	16	μA
		Average supply current, T _A = -40~85°C, V _{dd} = 2.5~5.5V	-	8	27	μA
T _{wake}	Awake Time	(Note 5)	-	75	150	μs
T _{period}	Period	(Note 5)	-	75	150	ms
D.C.	Duty Cycle		-	0.1	-	%

Notes: 5. When power is initially on, the operating V_{dd} (2.5V to 5.5V) must be applied to be guaranteed for the output sampling. The output state is valid after the second operating phase (typical 150ms).

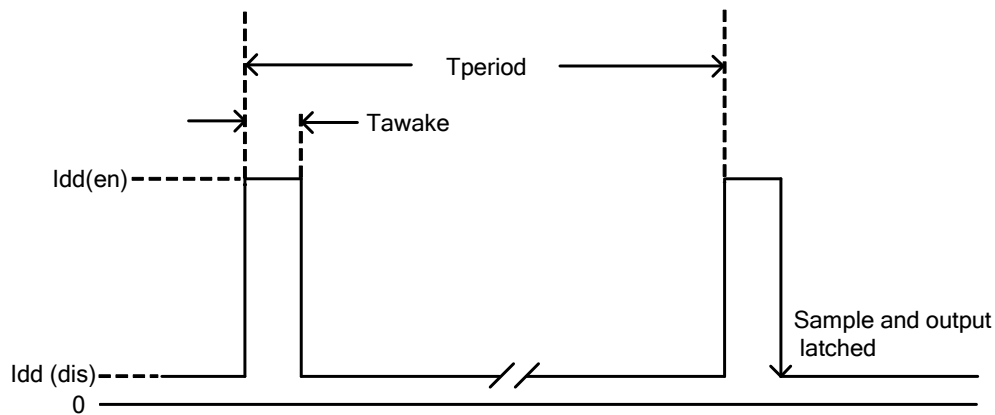

Magnetic Characteristics ($T_A = 25^\circ\text{C}$, $V_{dd} = 3\text{V}$)

(1mT=10 Gauss)

Symbol	Characteristic	Min	Typ	Max	Unit
Bops(south pole to brand side)	Operate Point	-	40	60	Gauss
Bopn(north pole to brand side)		-60	-40	-	
Brps(south pole to brand side)	Release Point	10	30	-	
Brpn(north pole to brand side)		-	-30	-10	
Bhy(Bopx - Brpx)	Hysteresis	-	10	-	

Notes: 6. Typical data is at $T_A=25^\circ\text{C}$, $V_{dd}=3\text{V}$, and for design information only.
7. Operate point and release point will vary with supply voltage and operating temperature.

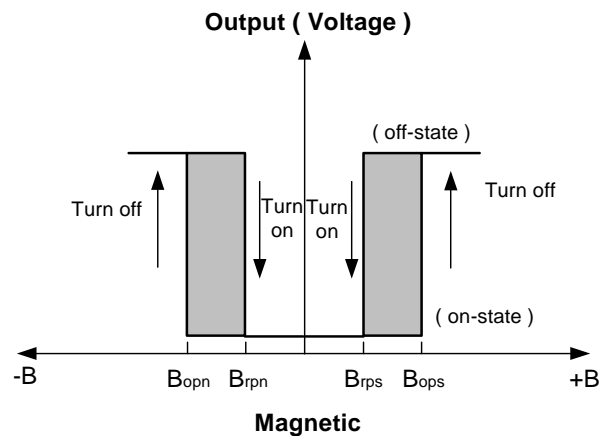

Performance Characteristics

(1) SC59 / DFN2020-3 / DFN2020-6

T_A ($^\circ\text{C}$)	25	50	60	70	80	85	90	100	110	120	130	140	150
P_D (mW)	230	184	166	147	129	120	110	92	74	55	37	18	0

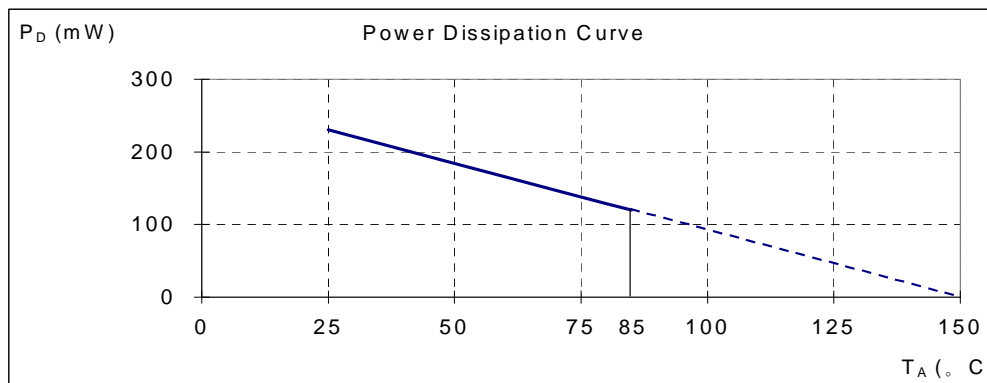

Marking Information

(1) SC59

(Top View)

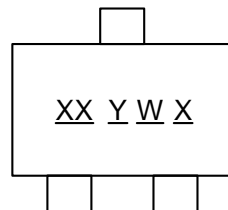

XX : Identification code
Y : Year 0~9
W : Week : A~Z : 1~26 week;
a~z : 27~52 week; z represents
52 and 53 week
X : A~Z : Green

Part Number	Package	Identification Code
AH1801	SC59	KB

(2) DFN2020-3

(Top View)

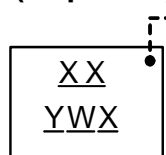

Pin 1 indicator
XX : Identification Code
Y : Year : 0~9
W : Week : A~Z : 1~26 week;
a~z : 27~52 week; z represents
52 and 53 week
X : A~Z : Green

Part Number	Package	Identification Code
AH1801	DFN2020-3	K1

(3) DFN2020-6

(Top View)

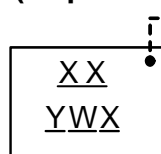

Pin 1 indicator
XX : Identification Code
Y : Year : 0~9
W : Week : A~Z : 1~26 week;
a~z : 27~52 week; z represents
52 and 53 week
X : A~Z : Green

Part Number	Package	Identification Code
AH1801	DFN2020-6	KB

Package Information (All Dimensions in mm)

(1) SC59 (commonly known as SOT23 in Asia)

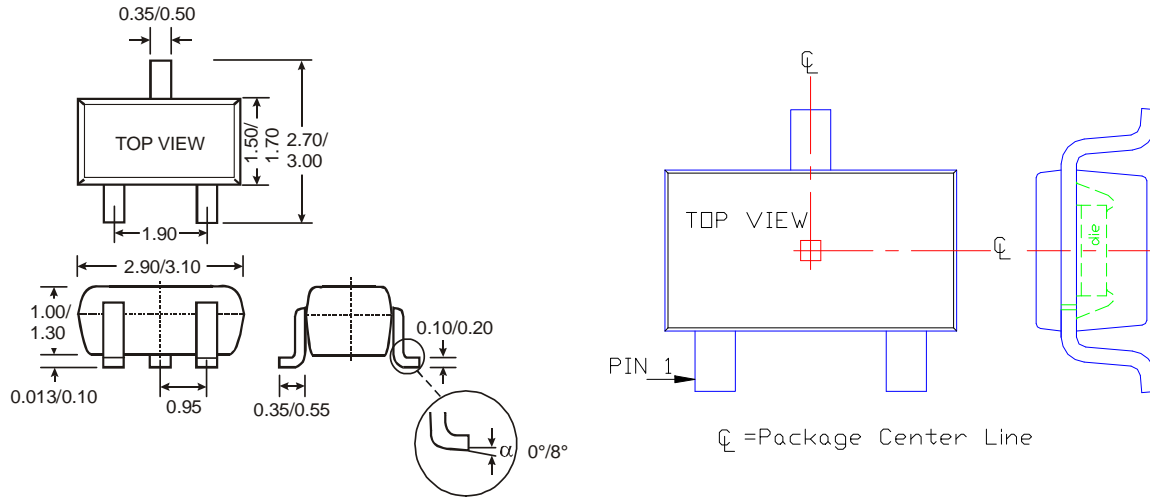

(2) DFN2020-3

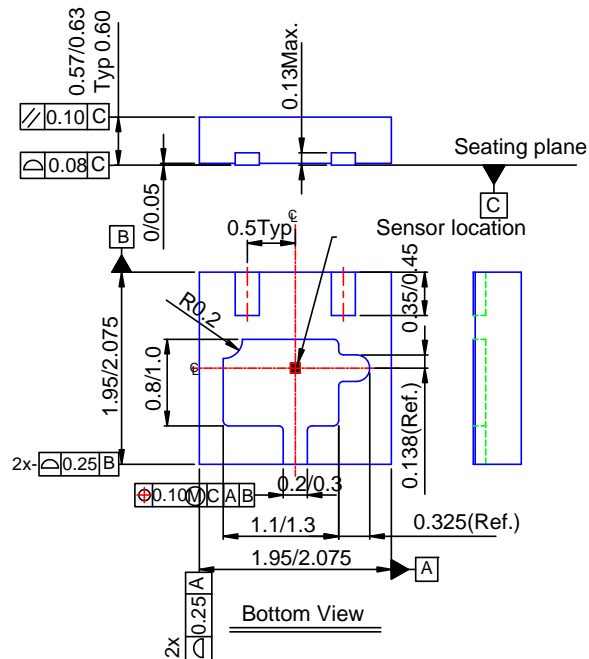

Package Information (Continued)

(3) DFN2020-6

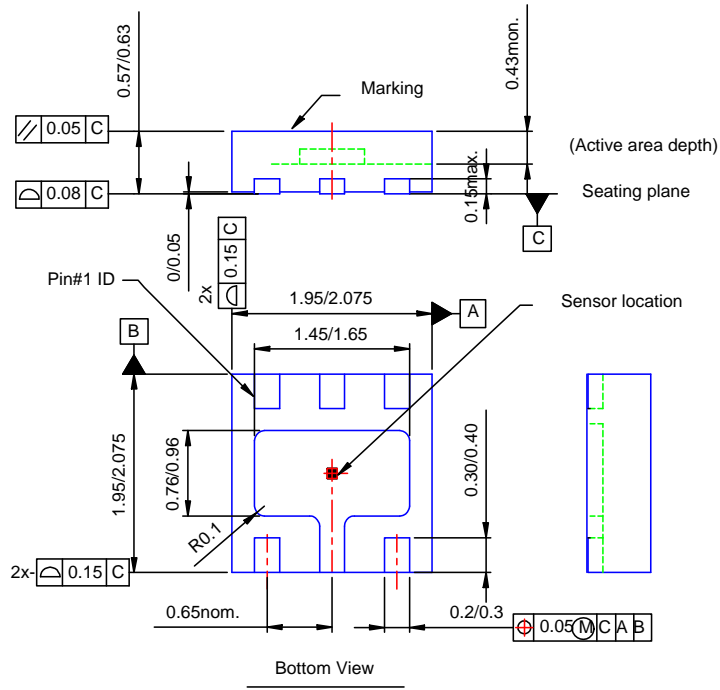

Taping Orientation

(1) DFN2020-3 and DFN2020-6

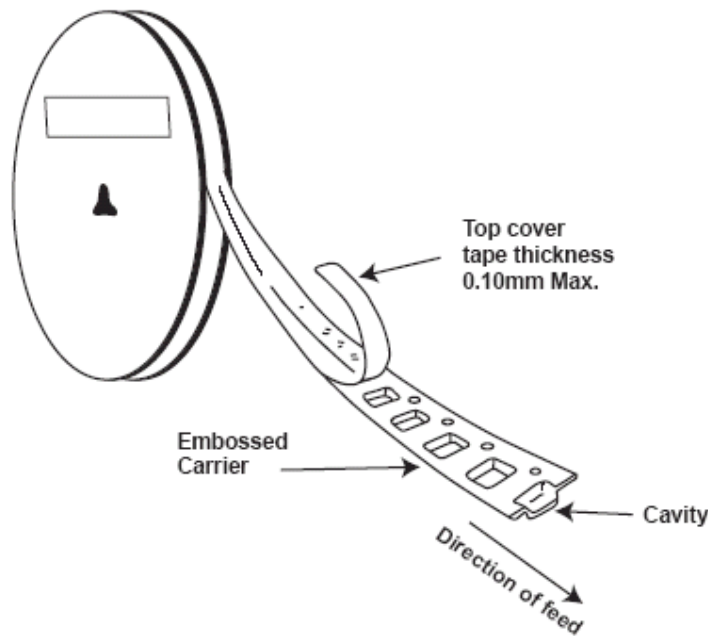
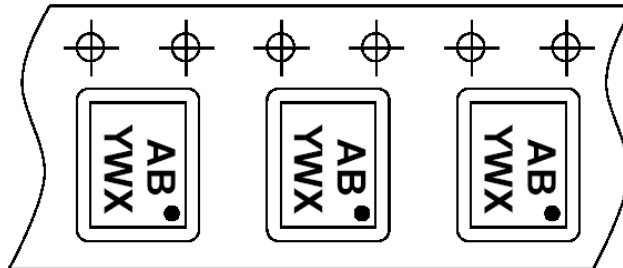

Notes: 8. The taping orientation of the other package type can be found on our website at <http://www.diodes.com/datasheets/ap02007.pdf>.

IMPORTANT NOTICE

Diodes Incorporated and its subsidiaries reserve the right to make modifications, enhancements, improvements, corrections or other changes without further notice to any product herein. Diodes Incorporated does not assume any liability arising out of the application or use of any product described herein; neither does it convey any license under its patent rights, nor the rights of others. The user of products in such applications shall assume all risks of such use and will agree to hold Diodes Incorporated and all the companies whose products are represented on our website, harmless against all damages.

LIFE SUPPORT

Diodes Incorporated products are not authorized for use as critical components in life support devices or systems without the expressed written approval of the President of Diodes Incorporated.