

## AFL-Series Sensors—Low Power, Low Voltage Digital Switches

### Features:

- Low voltage operation to 0.9 V
- Low current consumption
- Digital switch output
- Precise detection of low magnetic fields
- Ultra-small packages (MSOP8 and TDFN6)
- Available in millimeter-scale die
- Cannot be damaged by large magnetic fields

### Description:

NVE’s AFL-Series Sensors are digital switches designed to run at very low voltages and currents. The parts can operate from a single battery. The output is configured as a switch to detect magnetic fields, switching on at a specified magnetic field, and off when the field is removed. Current-sinking or current-sourcing output configurations are available. Both configurations supply up to 100  $\mu$ A. An external pull-up or pull-down resistor is required. The devices are available in MSOP8 or TDFN6 packages, or in die form.

### AFL Product Selection Guide

AFL-Series part numbers follow the general form below. The first “x” in the part number specifies the voltage range, the second “x” denotes the output configuration, the third “x” specifies the magnetic operate point, and the last character pair specifies the package. The following sections define these options.

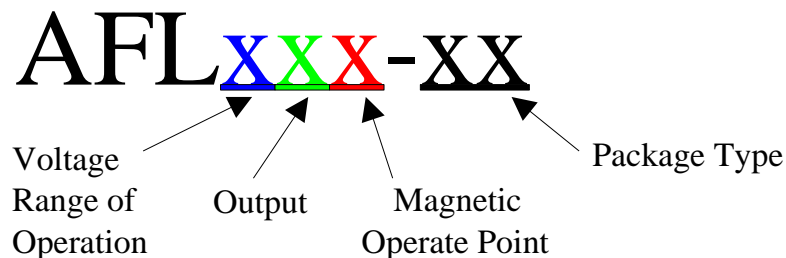

## Voltage Range of Operation

The first numeric digit of the part number in the form AFLxxx-xx specifies the operating voltage range. Four ranges are available:

### NVE AFL xxx-xx

Number	Voltage Range of Operation
0	0.9 V – 1.3 V
1	1.8 V – 2.5 V
2	2.7 V – 3.6 V
3	4.5 V – 5.5 V

The quiescent supply current specifications apply within these ranges. Parts may be operated at higher voltage than shown up to a maximum of 7 V, but the quiescent current will increase. For example, a “1xx-xx” part can be operated up to 3.0 V although it might exceed the quiescent current specification.

NVE can supply custom parts for different voltage ranges. Minimum order quantities, special pricing, NRE charges, and lead times may apply. Please contact NVE with your requirements.

## Output

The second digit of the part number specifies the output configuration. Four output types are available:

### NVE AFL xxx-xx

Number	Output Type
0	Normally Off, Current Sink
1	Normally On, Current Sink
2	Normally On, Current Source
3	Normally Off, Current Source

“Normally Off” means that with no magnetic field applied the output will not provide current; when the magnetic field is applied, the output current will turn on. “Normally On” is opposite. Parts will sink or source up to 100  $\mu$ A. Output current is not included in the quiescent current specification.

## Magnetic Operate Point and Direction of Sensitivity

Standard magnetic operate points are shown in the table below. Non-standard magnetic operate points are available, but special pricing, minimum order quantities, NRE charges, and lead times may apply.

### NVE AFL xx-xx

Number	Magnetic Operate Point
0	10 Oe
1	20 Oe
2	28 Oe
3	40 Oe
4	80 Oe
5	7 Oe

All AFL-Series parts feature cross-axis sensitivity as shown in the following diagrams:

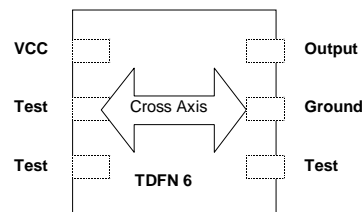
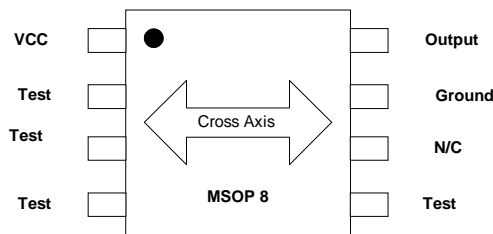

## Package Types

AFL-Series parts are available in two different packages: an 8-pin Micro Small Outline Package (MSOP) and a 6-pin ultra-miniature leadless TDFN package. Parts are also available in die form. Package type part numbers are shown in the table below; drawings are at the end of this specification.

### NVE AFL xxx-xx

Number	Package Type
00	MSOP8
01	IC Only
10	TDFN6

## Available Parts

The following parts in this series are currently available:

AFL000-00E	AFL000-10E	AFL000-01
AFL001-10E	AFL002-10E	AFL005-10E
AFL020-00E	AFL030-00E	AFL100-00E
AFL100-10E	AFL103-01	AFL200-00E
AFL300-00E		

#### Notes:

1. Part types are continuously added. Contact factory for current part availability.
2. The "E" suffix indicates a lead-free, RoHS-compliant package.
3. All die versions (-01 suffix) are lead-free and RoHS compliant.

## Electrical and Magnetic Specifications

Parameter	Min.	Typ.	Max.	Units
Magnetic Operate Point (AFLxx0-xx)	7	10	13	Oersteds
Operate/Release Differential (AFLxx0-xx)	1		6	Oersteds
Magnetic Operate Point (AFLxx1-xx)	15	20	25	Oersteds
Operate/Release Differential (AFLxx1-xx)	3		10	Oersteds
Magnetic Operate Point (AFLxx2-xx)	21	28	34	Oersteds
Operate/Release Differential (AFLxx2-xx)	3		10	Oersteds
Magnetic Operate Point (AFLxx5-xx)	4	7	10	Oersteds
Operate/Release Differential (AFLxx5-xx)	1		6	Oersteds
Operating Voltage (AFL0xx-xx)	0.9	1.1	1.3	Volts
Operating Voltage (AFL1xx-xx)	1.8	2.2	2.5	Volts
Operating Voltage (AFL2xx-xx)	2.7	3.2	3.6	Volts
Operating Voltage (AFL3xx-xx)	4.5	5.0	5.5	Volts
Quiescent Current (AFL000-xx)	20	35	55	μA
Quiescent Current (AFL020-xx)	30	50	75	μA
Quiescent Current (AFL030-xx)	15	35	55	μA
Quiescent Current (AFL100-xx)	25	35	45	μA
Quiescent Current (AFL200-xx)	30	35	45	μA
Quiescent Current (AFL300-xx)	30	40	50	μA
Maximum Output Drive Current (Sink or Source)	100			μA
V <sub>OL</sub> at 100 μA Output Drive Current			0.200	Volts
V <sub>OH</sub> at 100 μA Output Drive Current	V <sub>CC</sub> - 0.150			Volts
Frequency Response	100			KHz
Temperature Range of Operation	-20		85	°C

**Notes:**

1. Large magnetic fields **WILL NOT** damage NVE GMR Sensors
2. One Oersted (Oe) = 1 Gauss in air = 0.1 mT

## Operation

The magnetic field must be applied planar to the package in the direction of sensitivity. When the magnetic field reaches the magnetic operate point, the output will turn on. There should be a pull-up or pull-down resistor on the output terminal.

## Functional Diagrams and Pinout

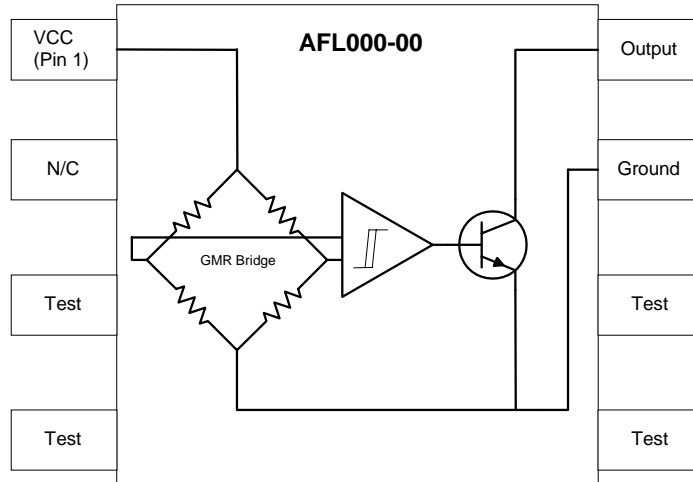

Direction of Sensitivity

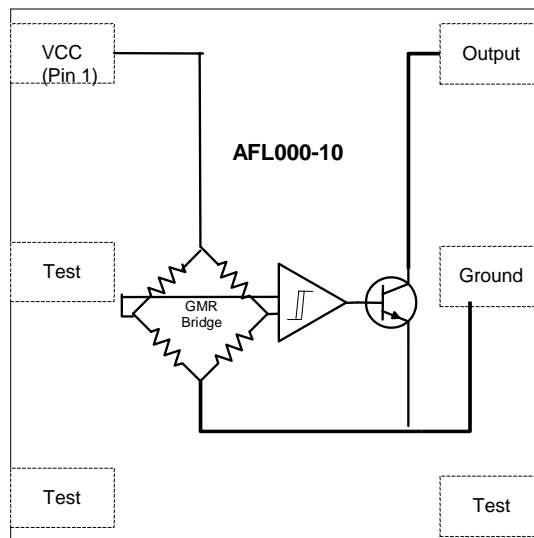



## Package Drawings and Specifications

### MSOP8

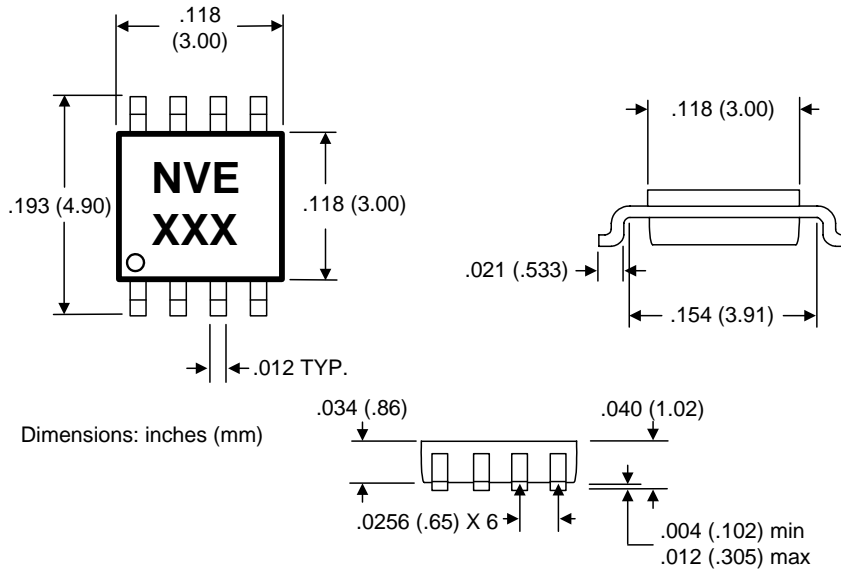

**Notes:**

1. The MSOP8 package has thermal power dissipation of 320°C/Watt in free air.
2. Thermal performance is improved when the package is soldered to a circuit board.

### 2.5 mm x 2.5 mm TDFN6

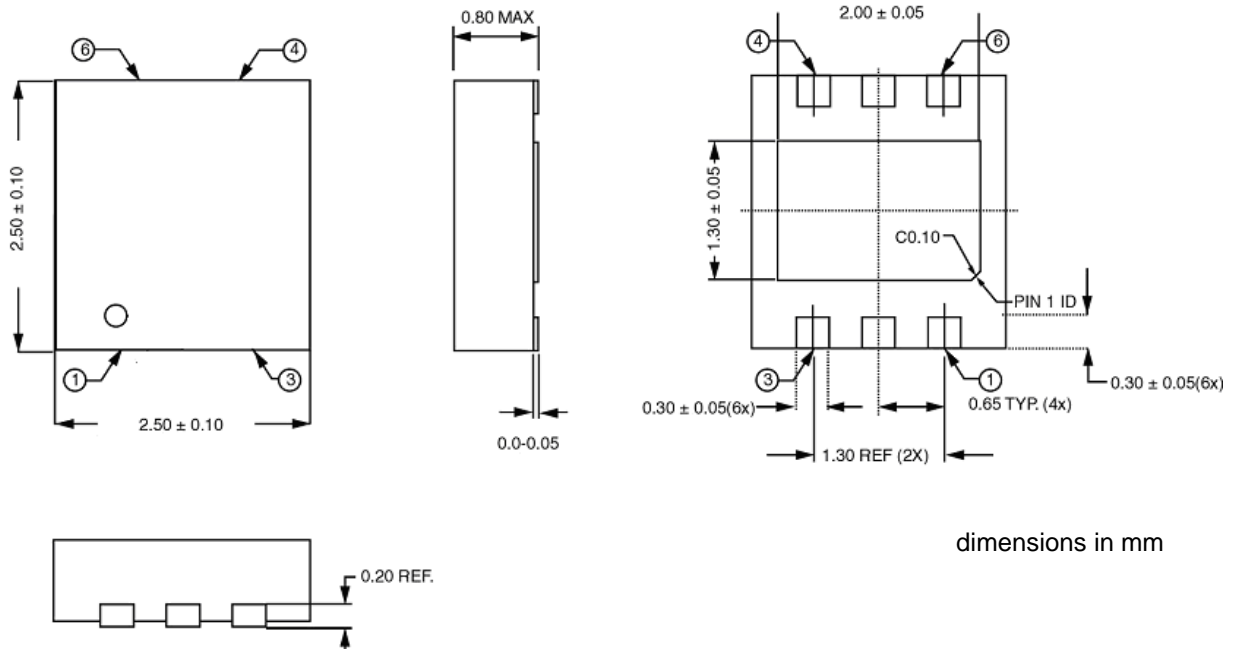

**Notes:**

1. The TDFN6 package has thermal power dissipation of 320°C/Watt in free air.
2. Thermal performance is improved when the package is soldered to a circuit board.

The complete part number will not fit on TDFN6 or MSOP8 packages, so a three-digit code is used. The package codes are listed below:

<b>Part Number</b>	<b>Marking Code</b>
AFL000-00E	PBBe
AFL000-10E	QBBe
AFL001-10E	QBXe
AFL002-10E	QBLLe
AFL005-10E	QBKe
AFL020-00E	PBCe
AFL030-00E	PBDe
AFL100-00E	PBFe
AFL100-10E	QBFe
AFL200-00E	PBGe
AFL300-00E	PBHe