

9000 series

Momentary pushbutton switches

Distinctive features and specifications



- Two case lengths
- Three electrical functions
- Sealing options
- Model X1146 with Ø 16 (.630) bushing

B

ELECTRICAL SPECIFICATIONS

- Max. current/voltage rating with resistive load :
 - silver contact (A) : 0,3A 250VAC - 0,6A 125VAC - 1A 30VDC
 - gold plated contacts (CD) : 100mA 30VDC
- Initial contact resistance : 50 mΩ max.
- Insulation resistance : 1.000 MΩ min. at 500VDC
- Dielectric strength :
 - 1.000 Vrms 50 Hz min. between terminals
 - 1.500 Vrms 50 Hz min. between terminals and frame
- Electrical life : 250.000 cycles

MATERIALS

- Case : thermoplastique UL94-V0
- Actuator : polyamide, glass filled
- Bushing : brass, nickel plated
- Contacts :
 - A : silver
 - CD : brass, gold plated
- Terminal seal : epoxy

GENERAL SPECIFICATIONS

- Total travel :

9600-9400-9400Y		9600N-9400N
Functions 3 and 5	Function 2	Function 3
1,3 mm	2 mm	0,9 mm

- Torque : 1,25 Nm (.922 Ft.lb) max. applied to nut
- Operating temperature : -30°C to +65°C

9000 series

Momentary pushbutton switches

Overview

B

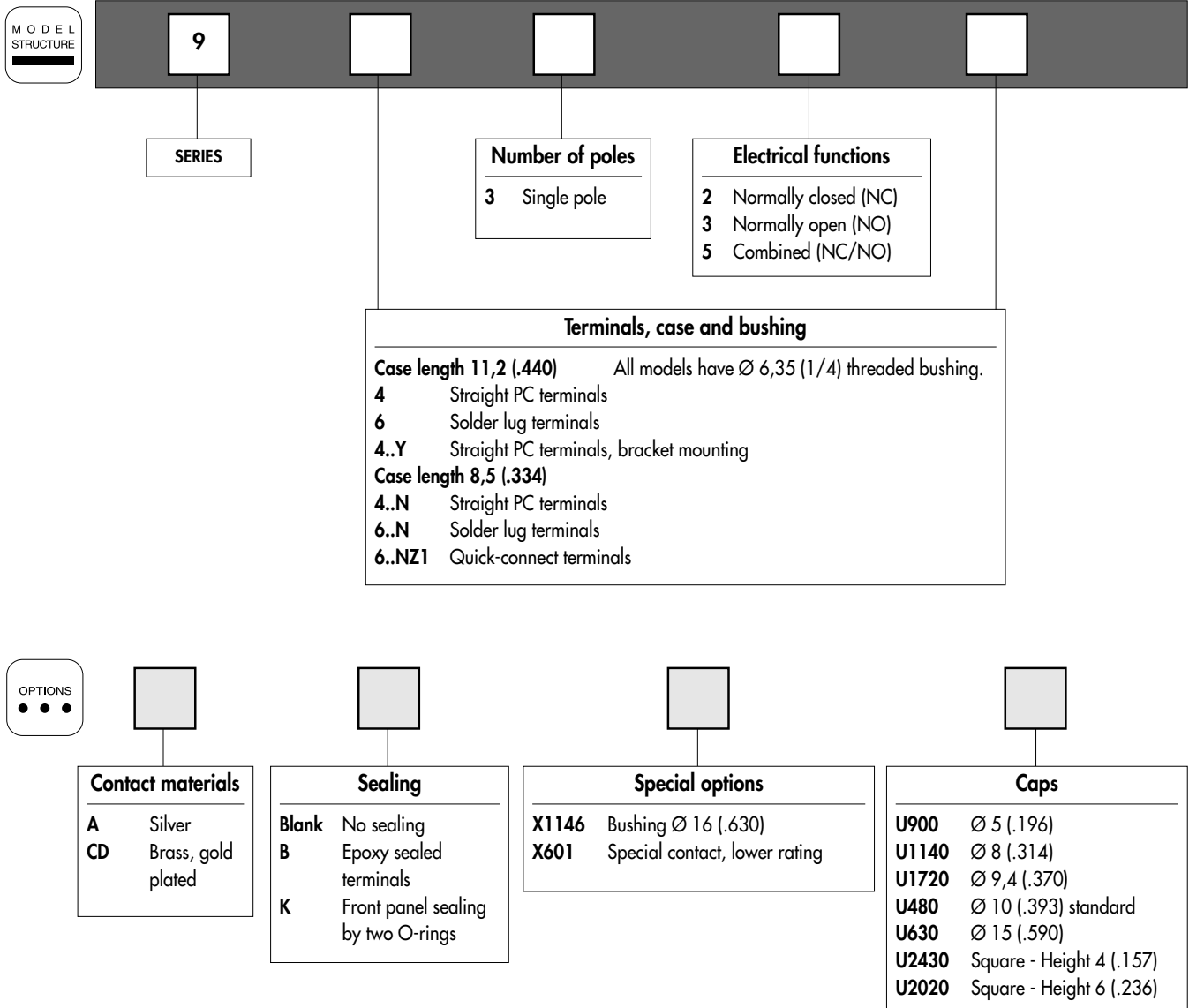

ABOUT THIS SERIES

On the following pages, you will find successively :
- model structure of switches
- their options in the same order as in above chart

Dimensions : first dimensions are in mm while inches are shown as bracketted numbers.



NOTICE : please note that not all combinations of above numbers are available. Refer to the following pages for further information.



Sealing boots are available to protect the switches against dust and water. They are presented in section H.



Mounting accessories : standard hardware supplied with all switches : 2 hex nuts 8 mm (.314) across flats and 1 lockwasher. Standard and special hardware available are presented in section I.



Packaging unit : 50 pieces, except for 9400Y (25 pieces)

9000 series

Momentary pushbutton switches

9600 - 9400 - 9400Y

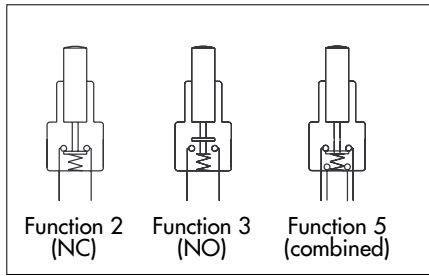

- Single pole
- Solder lug or straight PC terminals

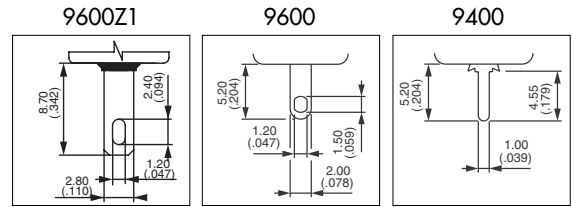

MODEL STRUCTURE

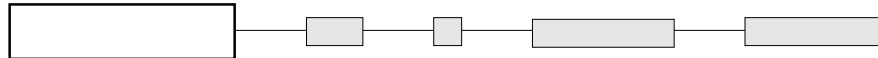

B

Solder lug terminals - case length 11,2 (.440) : 9600



- 9632 Normally Closed
- 9635 Combined function

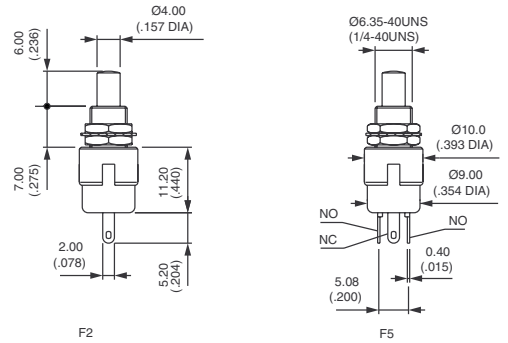

For Normally Open (function 3), see next page.

Straight PC terminals - case length 11,2 (.440) : 9400



- 9432 Normally Closed
- 9433 Normally Open
- 9435 Combined function

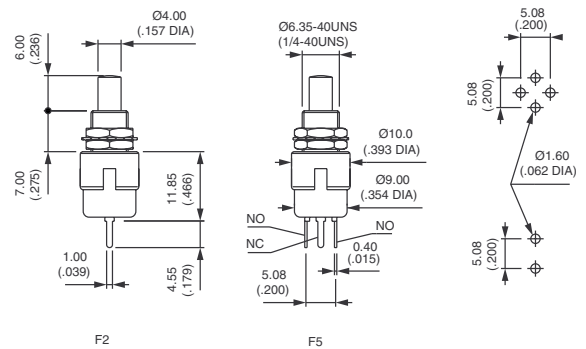

Bracket mounting - case length 11,2 (.440) : 9400Y



- 9432Y Normally Closed
- 9433Y Normally Open
- 9435Y Combined function

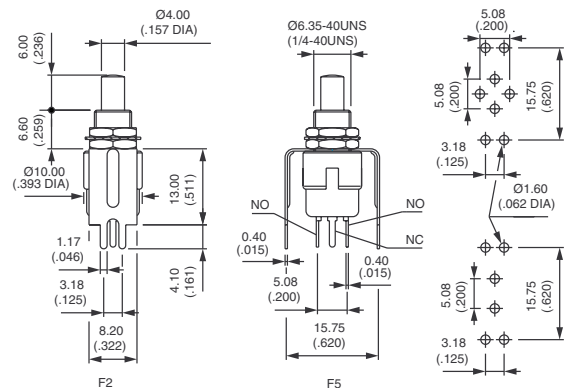

The bracket is not fastened to the switch.



9000 series

Momentary pushbutton switches

9600N - 9400N

Solder lug terminals - case length 8,5 (.334) : 9600N



9633N



Normally Open

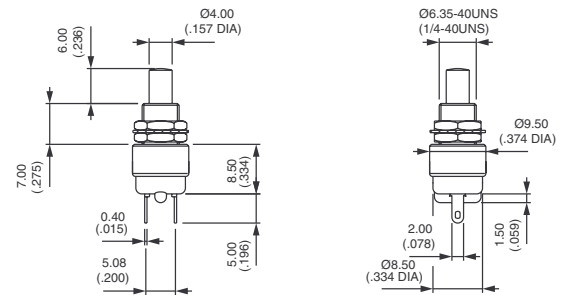

Also available with quick-connect terminals 2,8 x 0,5 mm : 9633NZ1

Straight PC terminals - case length 8,5 (.334) : 9400N



9433N



Normally Open

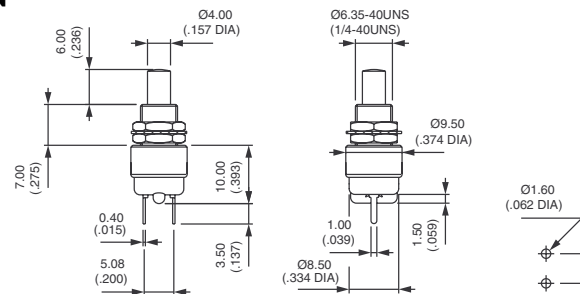

PANEL CUT-OUT

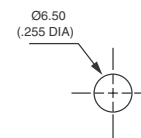

Bushing Ø 16 (.630) - metal button : 9633•X1146



Silver contacts
9633AX1146



Normally open

Gold plated silver contacts
9633ADX1146



Normally open

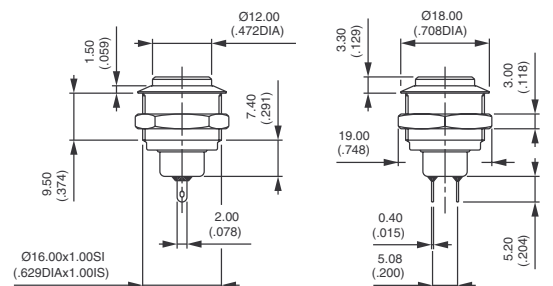

Panel cut-out : Ø 16,2 (.637)

Max. current/voltage rating. : 0,3A 250VAC - 1A 30VDC

Epoxy sealed terminals. Options of the following pages not applicable.

Hex nut 19 (.748) across flats

9000 series

Momentary pushbutton switches

OPTIONS



CONTACT MATERIALS

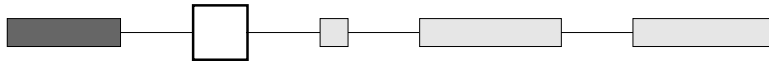

A Silver
CD Brass, gold plated

Special contact, lower rating : see X601 under "Special options".

SEALING

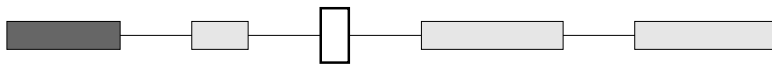

Blank No sealing

B Epoxy sealed terminals

K Front panel sealing by two O-rings. Protects the switch against water and dust.
Panel seal withstands 0,1 bar pressure and remains tight even when switch is operated.

KB Combined sealings

Sealing boots : see section H.

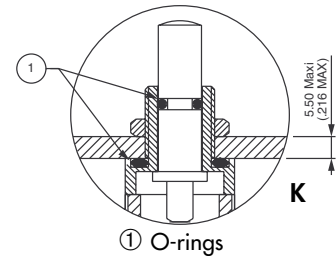
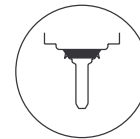

SPECIAL OPTIONS

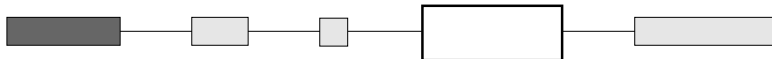

X601 Silver plated brass contacts
Current/voltage rating for an electrical life of 20.000 cycles :
0,2A 250VAC - 0,4A 125VAC - 0,5A 30VDC.
Minimum quantity : 5.000 pieces per model and shipment.

X1146 Model with dia. 16 (.630) bushing and metal plunger
See previous page.



9000 series

Momentary pushbutton switches

B

CAPS

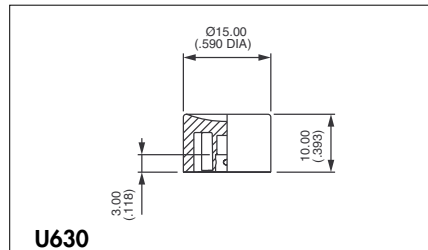
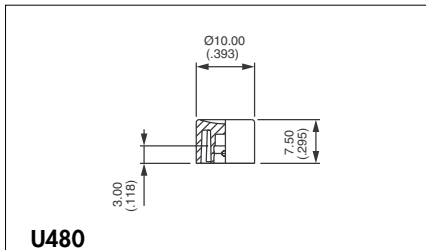
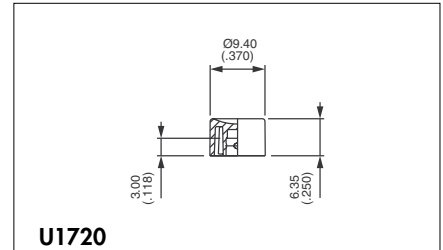
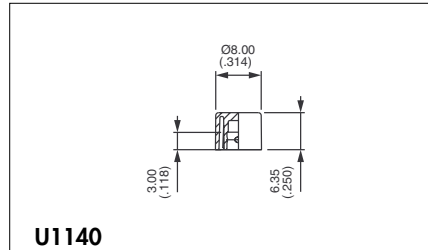
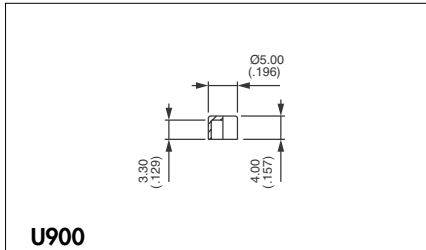
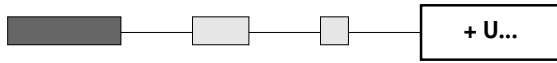

Cap colours	
Replace last "0" by number	
1	blue
1/4	dark blue
2	black
3	green
4	grey
5	yellow
6	red
7	ivory
7/1	white
9	orange

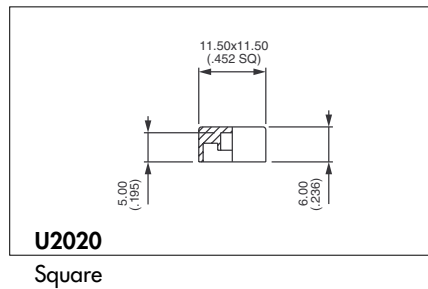
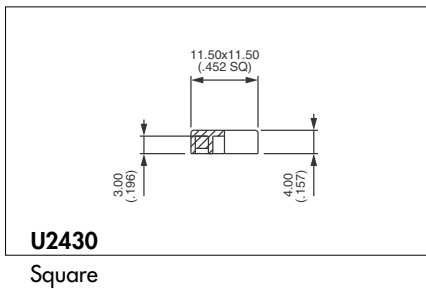

DRESS NUTS

Chrome plated

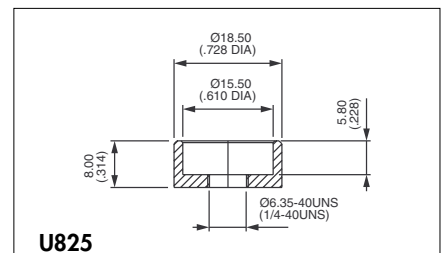
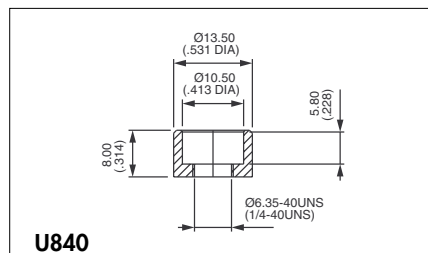
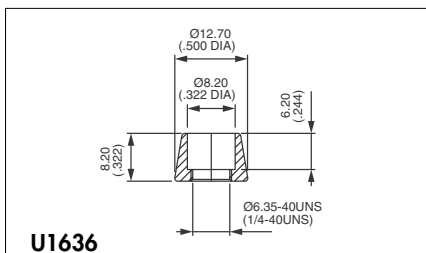

Dress nuts are to be ordered separately.

9000 series

Alternate action or momentary pushbutton switches

Distinctive features and specifications

Bushing Ø 6,35 (1/4) and 11,9 (15/32)

Two electrical functions

B

ELECTRICAL SPECIFICATIONS

- Max. current/voltage rating with resistive load and electrical life :
 - silver contacts (A) : 0,5A 250VAC - 1A 28VDC - 250.000 cycles
 - 1,5A 250VAC - 3A 28VDC - 10.000 cycles
- gold plated contacts (CD) : 0,4VA 20V max. AC or DC
- Initial contact resistance : 10 mΩ max. at 0,1A 3VDC
- Insulation resistance : 10.000 MΩ min.
- Dielectric strength :
1.000 Vrms 50 Hz min.

MATERIALS

- Case : diallyphthalate
- Actuator : nylon
black for series 9630M
white for series 9631
- Bushing : brass, nickel plated
- Contacts :
 - A** : silver
 - CD** : brass, gold plated
- Terminal seal : epoxy

GENERAL SPECIFICATIONS

- Operating temperature : -30°C to +85°C
- Travels : see table below.

MODELS	9631	9633M
Total travel	3,48 (.137)	2,79 (.110)
Pre-travel	0,66 (.026)	-
Over travel	2,69 (.106)	0,51 (.020)

9000 series

Alternate action or momentary pushbutton switches

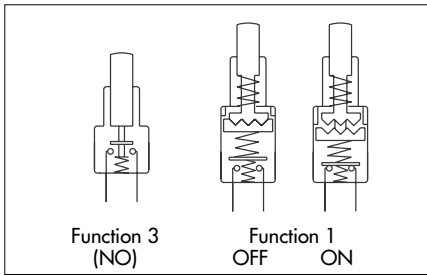

- Single pole
- Solder lug terminals
- Epoxy sealed terminals

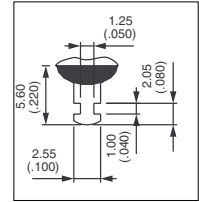

Bushing Ø 6,35 (1/4) - Alternate action - tactile feedback



Gold plated contacts
9631CDB

ON - OFF

Silver contacts
9631AB

ON - OFF

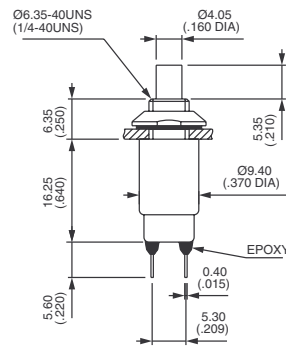

Standard hardware : 1 conic nut and 1 lockwasher

Bushing Ø 11,9 (15/32) - front or rear mounting - NO



9633MCDB



Normally open

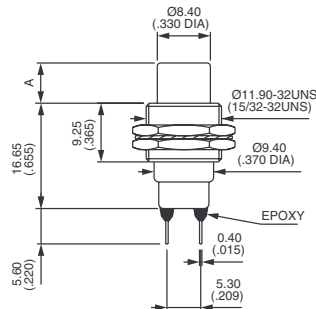

MODEL	A
9633M	6.35 (.250)

Standard hardware : 2 hex nuts 14 mm (.551) cross flats and 1 lockwasher

B