

Dialight

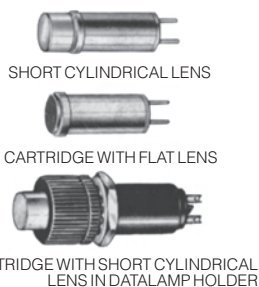

DIALIGHT DATALITES

For data processing equipment, computers and all other applications requiring ultra miniature indicator lights. Datalites consist of (1) **Datalamp Cartridges**—a plug-in, replaceable light source; accommodated by (2) **Datalamp Holders**—made of rugged, light weight aluminum. Datalamp Cartridges consists of T-1-3/4 incandescent lamps, or neon lamps, mounted in aluminum sleeves and capped with plastic lenses. Insulated pins are offset to provide polarization. Clear anodize finish. The neon datalamp cartridges have current limiting resistors.

DIALIGHT INCANDESCENT DATALAMP CARTRIDGES

Cat. No.	Colour	Net Price
SHORT CYLINDRICAL LENS SHAPE		
14.0 VOLT, 0.080 AMP, 750 HOUR LAMP		
507-3913-1471-600	Translucent Red	\$14.35
507-3913-1472-600	Translucent Green	10.80
507-3913-1473-600	Translucent Amber	9.18
SHORT CYLINDRICAL LENS SHAPE		
14.0 VOLT, 0.080 AMP, 50,000 HOUR LONG LIFE LAMP		
507-3914-1437-600	Clear	14.41
SHORT CYLINDRICAL LENS SHAPE		
28 VOLT, 0.040 AMP, 25,000 HOUR LONG LIFE LAMP		
507-3918-1431-600	Transparent Red	8.18
507-3918-1432-600	Transparent Green	13.57
507-3918-1433-600	Transparent Amber	8.65
507-3918-1435-600	Transparent White	8.18
507-3918-1437-600	Clear	7.16
507-3918-1471-600	Translucent Red	7.16
507-3918-1472-600	Translucent Green	6.65
507-3918-1473-600	Translucent Amber	7.16
507-3918-1474-600	Translucent Blue	16.15
507-3918-1475-600	Translucent White	7.16
507-3918-1476-600	Translucent Yellow	14.41
FLAT LENS SHAPE		
28 VOLT, 0.040 AMP, 1000 HOUR LAMP		
507-3917-0371-600*	Translucent Red	13.63
507-3917-0372-600*	Translucent Green	14.41
507-3917-0373-600*	Translucent Amber	14.41
507-3917-1431-600	Transparent Red	14.41
507-3917-1437-600	Clear	14.41
507-3917-1471-600	Translucent Red	7.16
507-3917-1472-600	Translucent Green	7.16
507-3917-1473-600	Translucent Amber	7.16
507-3917-1474-600	Translucent Blue	14.41
507-3917-1475-600	Translucent White	7.53
507-3917-1476-600	Translucent Yellow	14.41

NOTE: All the above use with 508-8738-504 cartridge.

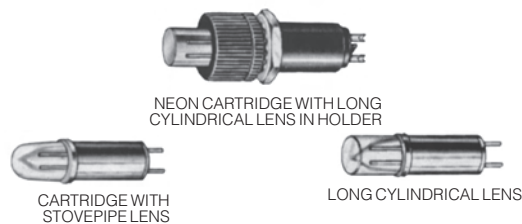

DIALIGHT NEON DATALAMP CARTRIDGES

Cat. No.	Colour	Net Price
STOVEPIPE LENS SHAPE, STANDARD BRIGHTNESS, WITH BUILT-IN 56K RESISTOR (FOR 105-125 VAC)		
507-4537-0931-640	Transparent Red	\$7.98
507-4537-0933-640	Transparent Amber	7.53
507-4537-0937-640	Clear	7.98
STOVEPIPE LENS SHAPE, HIGH BRIGHTNESS, WITH BUILT-IN 22K RESISTOR (FOR 105-125 VAC)		
507-4538-0931-610	Transparent Red	7.53
507-4538-0933-610	Transparent Amber	7.53
507-4538-0935-610	Transparent White	10.26
507-4538-0937-610	Clear	10.26
SHORT CYLINDRICAL LENS SHAPE, STANDARD BRIGHTNESS, WITH BUILT-IN 56K RESISTOR (FOR 105-125 VAC)		
507-4537-1431-640	Transparent Red	16.86
507-4537-1433-640	Transparent Amber	11.84
507-4537-1437-640	Clear	19.73
SHORT CYLINDRICAL LENS SHAPE, HIGH BRIGHTNESS, WITH BUILT-IN 22K RESISTOR (FOR 105-125 VAC)		
507-4538-1431-610	Transparent Red	9.69
507-4538-1433-610	Transparent Amber	18.00
507-4538-1437-610	Clear	16.15
LONG CYLINDRICAL LENS SHAPE, STANDARD BRIGHTNESS, WITH BUILT-IN 56K RESISTOR (FOR 105-125 VAC)		
507-4537-1531-640	Transparent Red	7.98
507-4537-1533-640	Transparent Amber	7.53
507-4537-1537-640	Clear	16.15
SHORT CYLINDRICAL LENS SHAPE, HIGH BRIGHTNESS, WITH BUILT-IN 47K RESISTOR (FOR 105-125 VAC)		
507-4538-1431-630	Transparent Red	8.85
507-4538-1433-630	Transparent Amber	8.41
507-4538-1437-630	Clear	8.85

NOTE: All the above use with 508-7545-504 or 508-8475-504 cartridges.

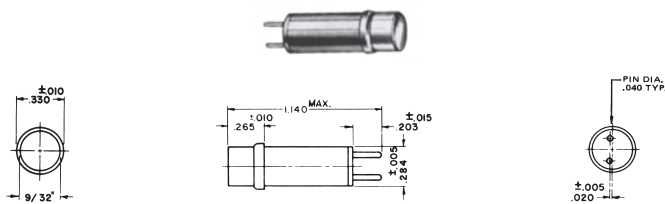

SHORT CYLINDRICAL LENS SHAPE

DIALIGHT 507 SERIES DATALAMP CARTRIDGES WITH LED DIODE-LITES

Light source is a solid state lamp that provides the advantages of low power with extremely long life and reliability. IC compatible; interchangeable with standard incandescent cartridges. Unique lens design features an internal fresnel ring to assure maximum distribution of light output. Cartridge may be mounted with Datalamp Holder or cartridge connector with speed clip.

Cat. No.	Jewel Colour	Volts DC	Maximum Current mA	Net Price
507-4757-3331-500	Red	5	15	\$5.31
507-4757-3731-500	Red	5	15	5.31
507-4759-3331-500	Red	10	15	5.31
507-4760-3331-500	Red	14	20	5.31
507-4760-3731-500	Red	14	20	5.31
507-4761-3331-500	Red	28	15	7.06
507-4857-3332-500	Green	5	20	7.20
507-4859-3332-500	Green	10	20	7.40
507-4860-3332-500	Green	14	20	7.20
507-4860-3732-500	Green	14	20	7.70
507-4861-3332-500	Green	28	20	7.20
507-4861-3732-500	Green	28	20	7.20
507-4957-3333-500	Yellow	5	20	7.20
507-4957-3733-500	Yellow	5	20	7.20
507-4960-3333-500	Yellow	14	20	7.20
507-4961-3333-500	Yellow	28	20	7.20
507-4961-3733-500	Yellow	28	20	7.20

NOTE: All the above use with 508-8738-504 cartridge.



515-0051

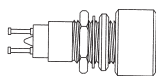

515-0074

DATALAMP HOLDERS AND CARTRIDGES

Ultra-compact—mounts in $\frac{3}{16}$ " clearance hole. Lamp cartridge is easily unplugged from front of panel. Collar, flange ring, and mounting bushing are aluminum with black anodize finish. The holders listed have solder cup terminals and turret terminals. 515-0051 Speed Clip: An effective fastening for use where conventional mounting is not practical. Counter-pressure of Speed Clip and flange of Cartridge secures the unit tightly against the panel. May be used with all Datalamp Cartridges. Self-retaining, dependable, vibration-proof. Made of heat-treated spring steel.

DATALAMP HOLDERS

Cat. No.	Description	Terminals	Back Projection	Net Price
508-7545-504	Cartridge for incandescent & LED	Solder	1 $\frac{1}{32}$ "	\$9.89
508-8745-504	Cartridge for incandescent & LED	Turret	1 $\frac{1}{32}$ "	9.42
508-8738-504	Cartridge for neon	Turret	1 $\frac{1}{8}$ "	8.98

DATALAMP CARTRIDGE CONNECTORS

Cat. No.	Description	Length	Net Price
515-0074	Cartridge Connector	$\frac{3}{16}$ "	\$2.98
515-0051	Speed Clip	—	1.35



111-8430-0111-201
CONVEX LENS CAP



101-3830-0931-201
STOVEPIPE LENS CAP



140-8430-1471-201
CYLINDRICAL LENS CAP



162-8430-0931-502
162 SERIES

DIALIGHT $\frac{15}{32}$ " SUBMINIATURE ASSEMBLIES

Extra compact assemblies for use with T-1 $\frac{3}{4}$ incandescent bulbs ranging from 1.35 to 28 volts. Lens caps unscrew for bulb replacement from front of panel. Lamp, socket and all connections are completely insulated from bushing and panel. Mount in $\frac{15}{32}$ " clearance hole. **3830** series assemblies mount from front or back of panel, with mounting nuts forming a moveable flange. **8430** series mount from front of panel only and have a fixed flange. All except **162** series are brass with black nickel finish. **162** series assemblies are aluminum with black anodize finish, and have anti-rotation tab on flange. Not supplied with lamp.

FOR USE WITH T-1 $\frac{3}{4}$ MIDGET FLANGE INCANDESCENT LAMPS OR BASED LED'S

Cat. No.	Colour	Net Price
FRONT OR BACK INSERTION, MOVEABLE FLANGE, CONVEX LENS CAP—BACK FROSTED		
111-3830-0111-201	Red	\$23.74
FRONT OR BACK INSERTION, MOVEABLE FLANGE, TRANSLUCENT STOVEPIPE LENS CAP		
101-3830-0971-201	Red	13.14
101-3830-0973-201	Green	29.01
101-3830-0975-201	White	14.21

FOR USE WITH T-1 $\frac{3}{4}$ MIDGET FLANGE INCANDESCENT LAMPS OR BASED LED'S (CONTINUED)

Cat. No.	Colour	Net Price
FRONT OR BACK INSERTION, MOVEABLE FLANGE, TRANSPARENT STOVEPIPE LENS CAP		
101-3830-0931-201	Red	\$14.21
101-3830-0932-201	Green	50.40
101-3830-0933-201	Yellow	12.16
101-3830-0935-201	White	14.58
FRONT OR BACK INSERTION, MOVEABLE FLANGE, TRANSLUCENT CYLINDRICAL LENS CAP		
140-3830-1471-201	Red	29.01
140-3830-1472-201	Green	52.26
140-3830-1473-201	Yellow	16.25
140-3830-1475-201	White	10.43
FRONT OF PANEL INSERTION, FIXED FLANGE, CONVEX LENS CAP—BACK FROSTED		
111-8430-0111-201	Red	14.93
FRONT OF PANEL INSERTION, FIXED FLANGE, TRANSLUCENT STOVEPIPE LENS CAP		
101-8430-0931-201	Red	26.39
101-8430-0932-201	Green	26.39
101-8430-0933-201	Yellow	11.97
FRONT OF PANEL INSERTION, FIXED FLANGE, TRANSLUCENT CYLINDRICAL LENS CAP		
140-8430-1471-201	Red	11.77
140-8430-1472-201	Green	14.87
140-8430-1473-201	Yellow	16.06
140-8430-1474-201	Blue	16.06
140-8430-1475-201	Yellow	15.70
FRONT OF PANEL INSERTION, FIXED FLANGE, TRANSLUCENT STOVEPIPE LENS CAP		
162-8430-0971-502	Red	46.40
162-8430-0972-502	Green	26.00
162-8430-0973-502	Yellow	20.76
FRONT OF PANEL INSERTION, FIXED FLANGE, TRANSPARENT STOVEPIPE LENS CAP		
162-8430-0931-502	Red	15.16
162-8430-0932-502	Green	15.16
162-8430-0933-502	Yellow	18.10
162-8430-0935-502	White	21.72
162-8430-0937-502	Clear	18.94
FRONT OF PANEL INSERTION, FIXED FLANGE, TRANSLUCENT CYLINDRICAL LENS CAP		
162-8430-1471-502	Red	22.49
162-8430-1472-502	Green	22.91
162-8430-1473-502	Yellow	22.91
FRONT OF PANEL INSERTION, FIXED FLANGE, TRANSPARENT CYLINDRICAL LENS CAP		
162-8430-1431-502	Red	22.91



DIALIGHT $\frac{15}{32}$ " NEON DATALAMPS

For use with T-2 neon glow lamps and C7A (NE-2D) neon lamps, standard brightness 105-125 VAC.

Cat. No.	Colour	Net Price
FRONT OF PANEL INSERTION, FIXED FLANGE, TRANSPARENT STOVEPIPE LENS		
137-8836-0931-552	Red	\$23.89
137-8836-0933-552	Yellow	23.89
137-8836-0935-552	White	44.70
137-8836-0937-552	Clear	44.24



DIALIGHT 17/32" SUBMINIATURE ASSEMBLIES

For use with T-1-3/4 midget flange incandescent lamps, or based LED's. Front of panel insertion, moveable flange.

Cat. No.	Colour	Net Price
TRANSPARENT STOVEPIPE LENS CAP		
101-5030-0931-201	Red	\$14.87
101-5030-0932-201	Green	13.69
101-5030-0933-201	Amber	13.69
101-5030-0935-201	White	18.00
TRANSLUCENT STOVEPIPE LENS CAP		
101-5030-0971-201	Red	13.80
101-5030-0973-201	Amber	14.87
101-5030-0972-201	Green	14.87



135-0408-1431-142
135-0410-1431-102
CYLINDRICAL LENS CAP

DIALIGHT 1/16" ENCLOSED ASSEMBLIES FOR NEON LAMPS

This series accommodates rugged, long life standard brightness B1A (NE-51) or high brightness B2A (NE-51H) neon glow lamps. The necessary current-limiting resistor is built-in, as an integral part of these assemblies. All types mount in a 1/16" clearance hole. The lens cap affords a 180° light spread for maximum visibility. White nickel finish mounting bushing and lens holder, cadmium iridite finish steel mounting nut and lockwasher. Not supplied with lamp. U/L and CSA listed.

BUILT-IN 56K RESISTOR FOR USE WITH B1A (NE-51) NEON LAMPS 105-125V AC-DC

Cat. No.	Colour	Net Price
SCREW-IN FLUTED STOVEPIPE LENS CAP, SOLDER TERMINALS		
52-0408-0991-142	Red	\$15.06
52-0408-0995-142	White	18.00
SCREW-IN TRANSPARENT CYLINDRICAL LENS CAP, SCREW TERMINALS		
135-1308-1435-142	White	15.83
135-1308-1437-142	Clear	14.85

NOTE: Green jewels not recommended with neon lamps.

BUILT-IN 22K RESISTOR FOR USE WITH B2A (NE-51H) NEON LAMPS 110-125V AC-DC

Cat. No.	Colour	Net Price
SCREW-IN TRANSPARENT STOVEPIPE LENS CAP, SOLDER TERMINALS		
95-0463-0931-112	Red	\$13.21
95-0463-0933-112	Amber	12.27
95-0463-0935-112	White	18.25
SCREW-IN TRANSPARENT CYLINDRICAL LENS CAP, SOLDER TERMINALS		
135-0463-1431-112	Red	17.17
135-0463-1433-112	Amber	13.30
SCREW-IN TRANSPARENT STOVEPIPE LENS CAP, SCREW TERMINALS		
95-1363-0931-112	Red	28.48
SCREW-IN TRANSPARENT CYLINDRICAL LENS CAP, SCREW TERMINALS		
135-1363-1431-112	Red	27.70
135-1363-1433-112	Amber	28.57
135-1363-1437-112	Clear	28.19

NOTE: Green jewels not recommended with neon lamps.



81-0410-0111-102
CONVEX LENS CAP

DIALIGHT 1/16" ENCLOSED ASSEMBLIES FOR INCANDESCENT LAMPS OR BASED LED'S

Indicator lights for T-3/4 bulb with miniature bayonet base. For mounting in 1/16" clearance hole. The lens cap affords a 180° light spread for maximum visibility. White nickel finish mounting bushing and lens holder; iridite finish steel mounting nut and lockwasher. Lamp not supplied.

FOR USE WITH T-3/4 MINIATURE BAYONET INCANDESCENT LAMPS

Cat. No.	Colour	Net Price
SCREW-IN TRANSPARENT STOVEPIPE LENS CAP, SOLDER TERMINALS		
95-0410-0931-102	Red	\$10.78
95-0410-0932-102	Green	10.78
95-0410-0935-102	Amber	10.97
SCREW-IN TRANSPARENT CYLINDRICAL LENS CAP, SOLDER TERMINALS		
135-0410-1431-102	Red	9.99
135-0410-1432-102	Green	10.87
135-0410-1433-102	Amber	9.29
135-0410-1435-102	White	9.57
SCREW-IN TRANSLUCENT CYLINDRICAL LENS CAP, SOLDER TERMINALS		
135-0410-1472-102	Green	10.87
135-0410-1475-102	Red	10.87
SCREW-IN TRANSPARENT STOVEPIPE LENS CAP, SCREW TERMINALS		
95-1310-0931-102	Red	20.35
95-1310-0932-102	Green	20.35
95-1310-0933-102	Amber	20.35
95-1310-0935-102	White	20.60
SCREW-IN FLUTED STOVEPIPE LENS CAP, SCREW TERMINALS		
52-1310-0991-102	Red	20.40
52-1310-0992-102	Green	21.11
52-1310-0993-102	Amber	20.40
SCREW-IN TRANSPARENT CYLINDRICAL LENS CAP, SCREW TERMINALS		
135-1310-1431-102	Red	20.69
135-1310-1432-102	Green	20.69
135-1310-1433-102	Amber	20.44
135-1310-1435-102	White	20.00
135-1310-1437-102	Clear	20.06
SCREW-IN TRANSLUCENT CYLINDRICAL LENS CAP, SCREW TERMINALS		
135-1310-1472-102	Green	20.44
135-1310-1473-102	Amber	20.44
135-1310-1475-102	White	20.44
SCREW-IN CONVEX LENS CAP—BACK FROSTED, SOLDER TERMINALS		
81-0410-0111-102	Red	3.27
81-0410-0112-102	Green	15.00
81-0410-0113-102	Amber	12.09
SCREW-IN FACETED LENS CAP—UNFROSTED, SOLDER TERMINALS		
81-0410-0431-102	Red	15.00
81-0410-0432-102	Green	15.00
81-0410-0433-102	Amber	15.00



Part's indicated with a leaf  are considered RoHS July 2006 compliant based on the manufacturer's confirmation at the time of publishing. For additional information please contact Electro Sonic.

INCANDESCENT PANEL MOUNT ASSEMBLIES

Incandescent panel mount assemblies are available as off the shelf items in 6V, 12V and 28V packages, and are available in other voltages as standard variations. Assemblies are available in a variety of colours, and lens styles, along with your choice of wire leads or quick connect terminals.

NEON PANEL MOUNT ASSEMBLIES

Neon panel mount assemblies are available as off the shelf items in 125V and 250V packages, and are available in other voltages as standard variations. Assemblies are available in a variety of colours, and lens styles, along with your choice of wire leads or quick connect terminals. All CML neon lamp assemblies are UL and CSA approved.

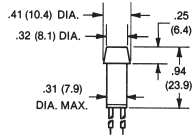

SERIES 2990D

One-piece lens-body 6, 12 and 28 volt incandescent pilot lights. Current ratings for 2990D series: 6V-.200A, 12V-.100A, 28V-.040A.

GLO-DOT SERIES 2990D INCANDESCENT PILOT LIGHTS

Cat. No.	Lens Colour	Net Price
6 VOLT		
2990D1-6V	Red	\$5.99
2990D3-6V	Amber	5.99
2990D4-6V	White	5.99
2990D5-6V	Green	5.99
2990D6-6V	Blue	5.99
12 VOLT		
2990D1-12V	Red	6.33
2990D3-12V	Amber	6.33
2990D4-12V	White	5.99
2990D5-12V	Green	6.33
2990D6-12V	Blue	5.99
26 VOLT		
2990D1-28V	Red	5.99
2990D3-28V	Amber	6.33
2990D4-28V	White	5.99
2990D5-28V	Green	5.99
2990D6-28V	Blue	5.99

Mounting Hole— $\frac{5}{16}$ " Diameter. Supplied with Push-On Speednut.

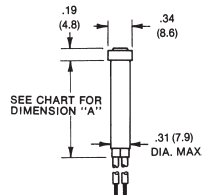
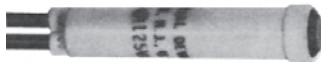

DIMENSION "A"

- $1\frac{3}{64}$ "—for 120 VAC (2110 & 2112 series)
- $\frac{47}{64}$ "—for 12, 28V (2195 series)

GLO-DOT MINIATURE INCANDESCENT PILOT LIGHTS—SERIES 2195A

Cat. No.	Lens Colour	Dim. "A"	Net Price
12 VOLT			
2195A1-12V	Red	.74(18.8)	\$6.36
2195A3-12V	Amber	.74(18.8)	6.36
2195A4-12V	White	.74(18.8)	6.02
2195A5-12V	Green	.74(18.8)	6.36
28 VOLT			
2195A1-28V	Red	.74(18.8)	6.02
2195A3-28V	Amber	.74(18.8)	6.36
2195A4-28V	White	.74(18.8)	6.02
2195A5-28V	Green	.74(18.8)	6.36

GLO-DOT MINIATURE NEON PILOT LIGHTS—SERIES 2110A AND 2112A 120 VAC

Cat. No.	Lens Colour	Net Price
2110A1	Red	\$4.71
2110A2	Clear	4.71
2110A3	Amber	4.71
2110A4	White	4.71
2112A5	Green	7.08
2112A6	Blue	7.08

Mounting Hole— $\frac{5}{16}$ " Diameter. Supplied with Push-On Speednut.

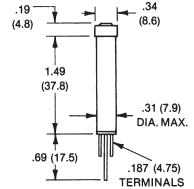

GLO-DOT MINIATURE NEON PILOT LIGHTS—SERIES 2110QA AND 2112QA WITH .187" TERMINALS 120 VAC

Cat. No.	Lens Colour	Net Price
2110QA1	Red	\$5.08
2110QA2	Clear	5.08
2110QA3	Amber	5.08
2110QA4	White	5.08
2112QA5	Green	7.51

Mounting Hole— $\frac{5}{16}$ " Diameter. Supplied with Push-On Speednut.

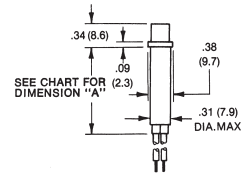

- DIMENSION "A"
- $1\frac{19}{64}$ "—for 120 VAC
 - $\frac{53}{64}$ "—for 12, 28V

GLO-DOT MINIATURE INCANDESCENT PILOT LIGHTS—SERIES 2194A

Cat. No.	Lens Colour	Dim. "A"	Net Price
12 VOLT			
2194A1-12V	Red	.83 (21.1)	\$6.73
2194A3-12V	Amber	.83 (21.1)	6.73
2194A4-12V	White	.83 (21.1)	6.36
2194A5-12V	Green	.83 (21.1)	6.73
28 VOLT			
2194A1-28V	Red	.83 (21.1)	6.73
2194A3-28V	Amber	.83 (21.1)	6.36
2194A4-28V	White	.83 (21.1)	6.36
2194A5-28V	Green	.83 (21.1)	6.73

GLO-DOT MINIATURE NEON PILOT LIGHTS—SERIES 2150A AND 2152A

Cat. No.	Lens Colour	Dim. "A"	Net Price
2150A1	Red	.83 (21.1)	\$5.02
2150A2	Clear	.83 (21.1)	5.02
2150A3	Amber	.83 (21.1)	5.02
2150A4	White	.83 (21.1)	5.02
2152A5	Green	.83 (21.1)	8.04
2152A6	Blue	.83 (21.1)	8.04

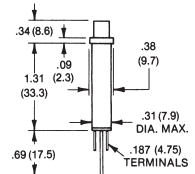

GLO-DOT MINIATURE NEON PILOT LIGHTS—SERIES 2150QA AND 2152QA WITH .187" TERMINALS 120 VAC

Cat. No.	Lens Colour	Net Price
2150QA1	Red	\$5.42
2150QA3	Amber	5.42
2150QA4	White	5.42
2152QA5	Green	8.42

Mounting Hole— $\frac{5}{16}$ " Diameter. Supplied with Push-On Speednut.

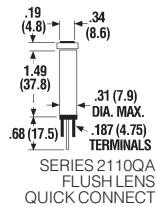
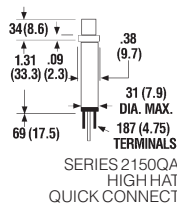

GLO-DOT MINIATURE NEON PILOT LIGHTS SERIES 2150, 2110

These miniature neon pilot lights are engineered for long service reliability. Rugged, unaffected by the shock and vibration. Two lens shapes, flush and high-hat which are available in five colours: red, amber, white, clear and green. Mounting hole is .31" minimum diameter. **Average Operating Life:** 25,000 hours. UL recognized and CSA approved. Supplied with push-on speed nut (SN1287). Units supplied with 4.4"-4.8" wire terminals, stripped 1/2" or .187"-.020" tinned brass terminals.

Cat. No.	Lens Colour	VAC	Net Price
2151A1	Red	208-250	\$5.02
2151A2	Clear	208-250	5.02
2151A3	Amber	208-250	5.02
2151A4	White	208-250	5.02
2153A5*	Green	208-250	8.04
2153A6†	Blue	208-250	8.04
2111A1	Red	208-250	4.71
2111A2	Clear	208-250	4.71
2111A3	Amber	208-250	4.71
2111A4	White	208-250	4.71
2113A5*	Green	208-250	7.08
2113A6†	Blue	208-250	7.08
2151QA1	Red	208-250	5.42
2151QA3	Amber	208-250	5.42
2151QA4	White	208-250	5.42
2153QA5*	Green	208-250	8.42
2111QA1	Red	208-250	5.08
2111QA2	Clear	208-250	5.08
2111QA3	Amber	208-250	5.08
2111QA4	White	208-250	5.08
2113QA5*	Green	208-250	7.51

*Incorporates G2B lamp and resistor.

†Incorporates T2B lamp and resistor.

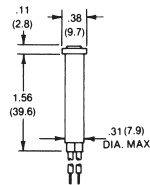
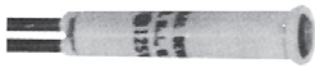

GLO-DOT MINIATURE NEON PILOT LIGHTS WITH WIRE LEADS SERIES 2120A 120 VAC

Cat. No.	Lens Colour	Net Price
2120A1	Red	\$4.71
2120A3	Amber	4.71
2120A4	White	4.71

Mounting Hole—5/16" Diameter. Supplied with Push-On Speednut.

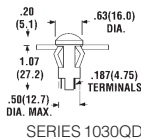
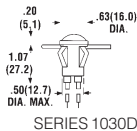

SERIES 1000 NEON LAMPS

PILOT LAMPS WITH LOW-PROFILE LENSES

Cat. No.	Lens Colour	VAC	Net Price
1030D1†	Red	105-125	\$4.74
1030D3†	Amber	105-125	5.11
1030D4†	White	105-125	4.74
1032D5†*	Green	105-125	7.11
1030QD1‡	Red	105-125	5.11
1030QD3‡	Amber	105-125	5.11
1030QD4‡	White	105-125	5.11
1032QD5‡*	Green	105-125	7.54

†With wire leads 4.4/4.8" long, striped .43/.57".

‡With .187"-.020" tinned brass terminals.

*Incorporates G2B lamp and resistor.

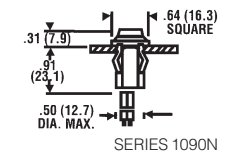
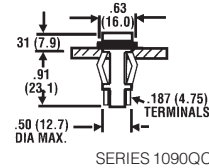
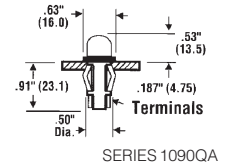
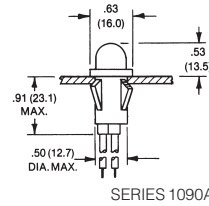
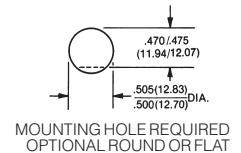
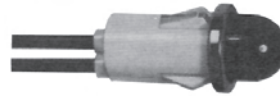

OMNI-GLOW INCANDESCENT PILOT LIGHTS—SERIES 1090A

Cat. No.	Lens Colour	Net Price
6 VOLT		
1090A1-6V	Red	\$6.08
1090A3-6V	Amber	6.08
1090A4-6V	White	6.43
1090A5-6V	Green	6.43
1090A6-6V	Blue	6.08
12 VOLT		
1090A1-12V	Red	6.43
1090A3-12V	Amber	6.43
1090A4-12V	White	6.43
1090A5-12V	Green	6.43
1090A6-12V	Blue	6.43
1090QA1-12V	Red	6.86
1090QA3-12V	Amber	6.86
1090QA4-12V	White	6.86
1090QA5-12V	Green	6.86
1090QA6-12V	Blue	6.86
1090N1-12V	Red	6.86
1090N3-12V	Amber	6.86
1090N4-12V	White	6.86
1090N5-12V	Green	6.86
1090QC1-12V	Red	6.86
1090QC3-12V	Amber	6.86
1090QC4-12V	White	6.86
1090QC5-12V	Green	6.86
28 VOLT		
1090A1-28V	Red	6.43
1090A3-28V	Amber	6.43
1090A4-28V	White	6.43
1090A5-28V	Green	6.43
1090A6-28V	Blue	6.43
1090QA1-28V	Red	6.86
1090QA3-28V	Amber	6.86
1090QA4-28V	White	6.86
1090QA5-28V	Green	6.86
1090QA6-28V	Blue	6.86
1090N1-28V	Red	6.86
1090N3-28V	Amber	6.86
1090N4-28V	White	6.86
1090N5-28V	Green	6.86
1090QC1-28V	Red	6.86
1090QC3-28V	Amber	6.86
1090QC4-28V	White	6.86
1090QC5-28V	Green	6.86
1090QC6-28V	Blue	15.21

Mounting Hole—1/2" Diameter.

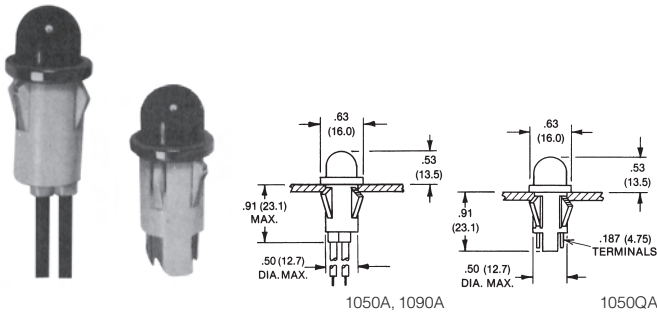

OMNI-GLOW NEON PILOT LIGHTS—SERIES 1050A AND 1050QA

Cat. No.	Lens Colour	Net Price
----------	-------------	-----------

WIRE LEADS

120 VAC

Cat. No.	Lens Colour	Net Price
1050A1	Red	\$4.74
1050A2	Clear	4.74
1050A3	Amber	4.74
1050A4	White	4.74
1052A5	Green	7.11
1052A6	Blue	7.11

250 VAC

Cat. No.	Lens Colour	Net Price
1051A1	Red	2.60
1051A2	Clear	2.60
1051A3	Amber	2.60
1051A4	White	2.60
1053A5	Green	3.87
1053A6	Blue	3.87

WITH .187" TERMINALS

120 VAC

Cat. No.	Lens Colour	Net Price
1050QA1	Red	5.11
1050QA2	Clear	5.11
1050QA3	Amber	5.11
1050QA4	White	5.11
1052QA5	Green	7.54
1052QA6	Blue	7.54

250 VAC

Cat. No.	Lens Colour	Net Price
1051QA1	Red	2.81
1051QA3	Amber	2.81
1051QA4	White	2.81
1053QA5	Green	4.13

Mounting Hole— $\frac{1}{2}$ " Diameter.

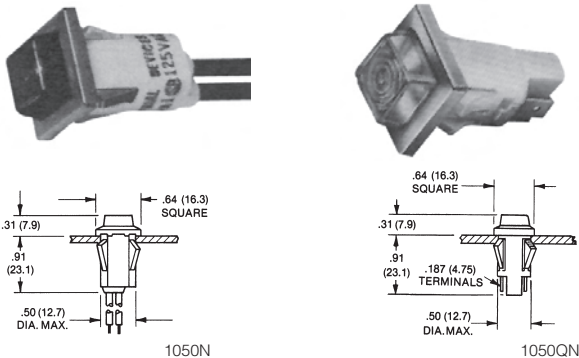

OMNI-GLOW INCANDESCENT PILOT LIGHTS—SERIES 1090N

Cat. No.	Lens Colour	Net Price
----------	-------------	-----------

WITH WIRE LEADS

12 VOLT

Cat. No.	Lens Colour	Net Price
1090N1-12V	Red	\$6.86
1090N3-12V	Amber	6.86
1090N4-12V	White	6.86
1090N5-12V	Green	6.86

28 VOLT

Cat. No.	Lens Colour	Net Price
1090N1-28V	Red	6.86
1090N3-28V	Amber	6.86
1090N4-28V	White	6.86
1090N5-28V	Green	6.86

Mounting Hole— $\frac{1}{2}$ " Diameter.

OMNI-GLOW NEON PILOT LIGHTS—SERIES 1050N AND 1050QN

Cat. No.	Lens Colour	Net Price
----------	-------------	-----------

WITH WIRE LEADS 120 VAC

Cat. No.	Lens Colour	Net Price
1050N1	Red	\$5.11
1050N2	Clear	5.11
1050N3	Amber	5.11
1050N4	White	5.11
1052N5	Green	7.54

WITH .187" TERMINALS 120 VAC

Cat. No.	Lens Colour	Net Price
1050QN1	Red	5.55
1050QN3	Amber	5.55
1050QN4	White	5.55
1052QN5	Green	8.01

Mounting Hole— $\frac{1}{2}$ " Diameter.

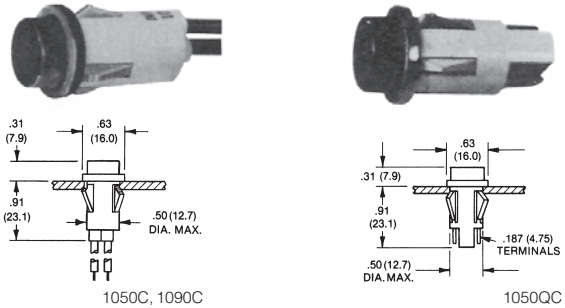

OMNI-GLOW INCANDESCENT PILOT LIGHTS—SERIES 1090C

Cat. No.	Lens Colour	Net Price
----------	-------------	-----------

WITH WIRE LEADS

12 VOLT

Cat. No.	Lens Colour	Net Price
1090C1-12V	Red	\$4.34
1090C3-12V	Amber	4.34
1090C4-12V	White	4.34
1090C5-12V	Green	4.34

28 VOLT

Cat. No.	Lens Colour	Net Price
1090C1-28V	Red	4.34
1090C3-28V	Amber	4.34
1090C4-28V	White	4.34
1090C5-28V	Green	4.34

Mounting Hole— $\frac{1}{2}$ " Diameter.

OMNI-GLOW NEON PILOT LIGHTS—SERIES 1050C AND 1051QC

Cat. No.	Lens Colour	Net Price
----------	-------------	-----------

WIRE LEADS

120 VAC

Cat. No.	Lens Colour	Net Price
1050C1	Red	\$4.74
1050C2	Clear	4.74
1050C3	Amber	4.74
1050C4	White	4.74
1052C5	Green	7.11

250 VAC

Cat. No.	Lens Colour	Net Price
1051C1	Red	4.74
1051C2	Clear	4.74
1051C3	Amber	4.74
1051C4	White	4.74
1053C5	Green	7.11

WITH .187" TERMINALS

120 VAC

Cat. No.	Lens Colour	Net Price
1050QC1	Red	5.11
1050QC2	Clear	5.11
1050QC3	Amber	5.11
1050QC4	White	5.11
1052QC5	Green	7.54

250 VAC

Cat. No.	Lens Colour	Net Price
1051QC1	Red	5.11
1051QC3	Amber	5.11
1051QC4	White	5.11
1053QC5	Green	7.54

Mounting Hole— $\frac{1}{2}$ " Diameter.



Continued on next page....

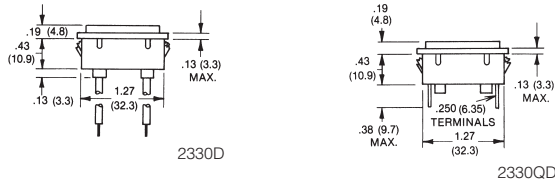

LINE-O-LITE NEON PILOT LIGHTS—SERIES 2330D AND 2330QD

Cat. No.	Lens Colour	Net Price
WITH WIRE LEADS 120 VAC		
2330D1	Red	\$5.64
2330D3	Amber	5.64
2330D4	White	5.64
2332D5	Green	7.86
WITH .250" TERMINALS 120 VAC		
2330QD1	Red	5.70
2330QD3	Amber	5.70
2330QD4	White	5.70
2332QD5	Green	8.07

LINE-O-LITE INCANDESCENT LIGHTS—SERIES 2390QD

Cat. No.	Lens Colour	Net Price
WITH .250" TERMINALS 28V		
2390QD1-28V	Red	\$7.12
2390QD3-28V	Amber	7.12
2390QD4-28V	White	7.12
2390QD5-28V	Green	7.12

Will snap fit into .032/.100" (.81/2.54 mm) thick panel; use speednut SN1963 for other panel thicknesses. Speednut not supplied. Mounting Hole—.395/.400" (10.03/10.16 mm) x 1.276/1.281" (32.41/32.54 mm).

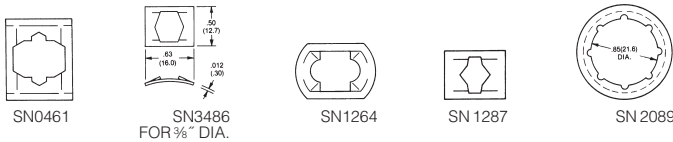

Cat. No.	Lamp Model Series	Net Price
SN0461	1050, 1051, 1090, 3000	\$1.19
SN1287	2110, 2112, 2150, 2152, 2191, 2194, 2195, 2990	.19
SN2089	2620	.31
SN3486	3/8" Dia.	.25



ROUND LENS

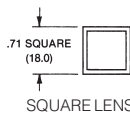

SQUARE LENS

SOLID STATE GLO-DOT 2191L AND 2191U SERIES PILOT LIGHT LENSES FOR 3040-3062 SERIES

MINI-SLIDE individual pilot light lenses are available in 2 shapes; round and square. Lenses are molded polycarbonate and either round or square lens will fit both 3040 and 3062 sockets. Each lens is available in 7 bright colours (see table). Round and square lenses may be supplied hot-stamped with legends as desired. All lenses are keyed to socket for correct orientation.

MINI-SLIDE PILOT LIGHT LENSES 3040 AND 3062 SERIES

Lens Colour	Round-Lens Part No.	Square-Lens Part No.
Red	3111	3121
Clear	3112	3122
Amber	3113	3123
White	3114	
Green	3115	3125
Blue	3116	3126
Yellow	3117	3127

Cat. No.	Net Price
3111 thru 3127	\$1.25

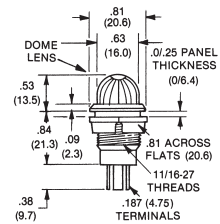
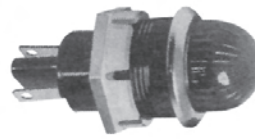

PILOT LIGHT ASSEMBLIES—SERIES 2800

Series 2800 pilot light assemblies are bright, highly visible, beautiful pilot lights styled with either solid black or stainless steel bezels. The units feature round, light diffusing screw-in lenses. They come in a variety of colours and utilize "PSB" Telephone Slide Base lamps in a full range of voltages from 6 to 120 volts. The lenses are molded polycarbonate, and the screw-in design permits easy relamping from the front panel. CSA approved for 120 volt service. Leads can be attached by soldering or with quick-connect receptacles for .205 x .020 tab. Mounts to panel by means of nylon torque-limiting nut. Assemblies mount in an 1/16" diameter hole.

SERIES 2800 SOCKET ASSEMBLIES

Cat. No.	Description	Net Price
2802	All Plastic Black Bezel	\$4.43
2803	Mirror-Finish Stainless Steel Bezel	4.99

SERIES 2800 LENSES

		Lens Colour						Net Price
Red	Clear	Amber	White	Green	Blue	Yellow		
DOME LENS								
2811	2812	2813	2814	2815	2816	2817	\$1.00	
FLAT LENS								
2851	2852	2853	2854	2855	2856	2857	1.00	

MODEL 3062 SERIES SOCKETS

For use with "PSB" Telephone Slide Base Lamps.

MINI-SLIDE Model 3062 assemblies accept "PSB" Telephone Slide Base lamps. Socket molded of black polyester is CSA approved for 120 volt service and takes both round and square lenses. Lenses snap on or off for easy front panel relamping. Mount in either 1/2" round or standard "D" holes and are held in place with push-in speed nuts. Speed nut SN0461 supplied with each socket.

I.D.I. MODEL 3062 SERIES SOCKETS

Cat. No.	Terminal Size	Dim. "A"	Dim. "B"	Net Price
3062	.205 x .020	3/8"	5/64"	\$2.56

MINI-SLIDE 3040 and 3062 sockets mount in either 1/2" round or standard "D" holes and are held in place with push-on Speed Nuts. Speednut #461 supplied.

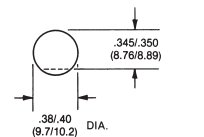
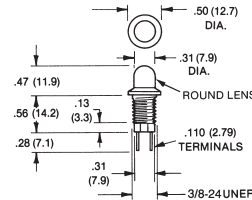

MOUNTING HOLE REQUIRED OPTIONAL ROUND OR FLAT

Cat. No.	Description	Net Price
----------	-------------	-----------

SERIES 4600 SOCKET ASSEMBLIES

4611	Threaded socket with zinc finished hex nut and internal tooth lock washer.	\$3.06
------	--	--------

SERIES 4600 LENS

4621	Red Round Lens	1.34
4623	Amber Round Lens	1.34
4625	Green Round Lens	1.34
4626	Blue Round Lens	1.34
4627	Yellow Round Lens	1.34



INTERNAL STAR
LOCKWASHER



SPLIT
LOCKWASHER

LOCKWASHERS

Cadmium plated.

Cat. No.	Size	Net Price Per 1000
INTERNAL STAR		
54-518-0	2	\$15.50
54-528-0	4	15.75
54-538-0	6	16.42
54-548-0	8	15.50
54-558-0	10	16.42
SPLIT		
54-519-0	2	5.73
54-529-0	4	5.73
54-539-0	6	8.00
54-549-0	8	9.83
54-559-0	10	11.00

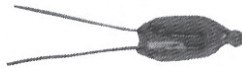

NEON LAMP

Cat. No.	Net Price
55-120-0	\$1.18

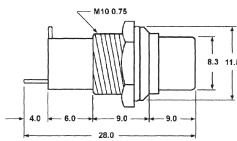

PILOT LAMP BASES

Cat. No.	Colour	Lamp Base	Net Price
55-300-0	Red	5mm screw	\$0.75
55-301-0	Green	5mm screw	.75

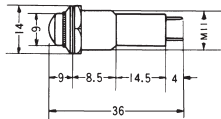

PILOT LAMP BASES

Cat. No.	Colour	Lamp base	Net Price
55-302-0	Red	5mm screw	\$1.08
55-305-0	Green	5mm screw	1.08

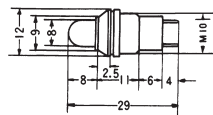

PILOT LAMP BASES

Cat. No.	Colour	Lamp base	Net Price
55-312-0	Red	5mm screw	\$0.75
55-315-0	Green	5mm screw	.75

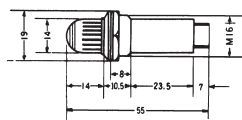

PILOT LAMP BASES

Cat. No.	Colour	Lamp base	Net Price
55-322-0	Red	10mm bayonet	\$1.08
55-325-0	Green	10mm bayonet	1.08

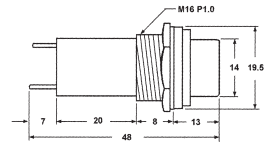
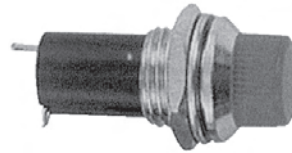

PILOT LAMP BASES

Cat. No.	Colour	Lamp Base	Net Price
55-332-0	Red	10mm screw	\$1.08
55-335-0	Green	10mm screw	1.08
55-339-0	Clear	10mm screw	1.08

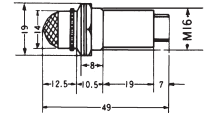

PILOT LAMP BASES

Cat. No.	Colour	Lamp base	Net Price
55-342-0	Red	10mm bayonet	\$1.33
55-343-0	Amber	10mm bayonet	1.33
55-345-0	Green	10mm bayonet	1.33

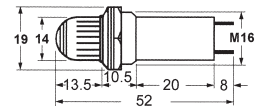

PILOT LAMP BASES

Cat. No.	Colour	Lamp Base	Net Price
55-352-0	Red	10mm screw	\$1.08
55-355-0	Green	10mm screw	1.08

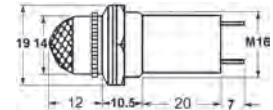

PILOT LAMP BASES

Cat. No.	Colour	Lamp Base	Net Price
55-362-0	Red	10mm screw	\$1.08
55-365-0	Green	10mm screw	1.08
55-369-0	Clear	10mm screw	1.08

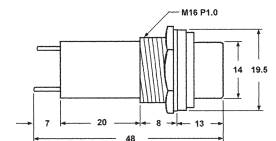
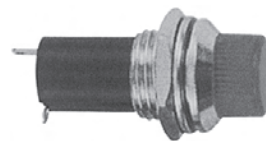

PILOT LAMP BASES

Cat. No.	Colour	Lamp Base	Net Price
55-372-0	Red	10mm screw	\$1.08
55-375-0	Green	10mm screw	1.08
55-379-0	Clear	10mm screw	1.08

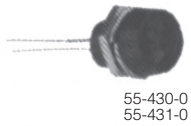

55-430-0
55-431-0



55-432-0
55-433-0

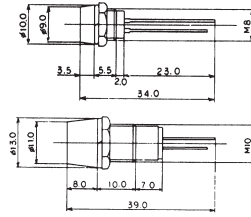

LED PILOT LAMPS

Cat. No.	Colour	Net Price
55-430-0	Red (plastic)	\$1.67
55-431-0	Green (plastic)	1.92
55-432-0	Red (chrome)	1.07
55-433-0	Green (chrome)	1.17

NEON PILOT LAMPS

120VAC with built-in resistor.

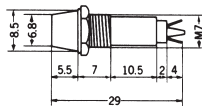

NEON PILOT LAMPS

Cat. No.	Colour	Net Price
55-442-0	Red	\$.78
55-443-0	Amber	.78
55-445-0	Green	.78

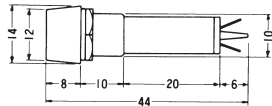

NEON PILOT LAMPS

Cat. No.	Colour	Net Price
55-462-0	Red	\$.75
55-463-0	Amber	.75
55-465-0	Green	.75

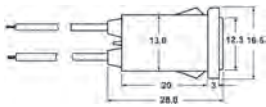

NEON PILOT LAMPS

Cat. No.	Colour	Net Price
55-452-0	Red	\$1.17
55-453-0	Amber	1.17
55-455-0	Green	1.17

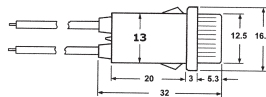

NEON PILOT LAMPS

Cat. No.	Colour	Net Price
55-482-0	Red	\$1.17
55-483-0	Amber	1.40
55-485-0	Green	1.17

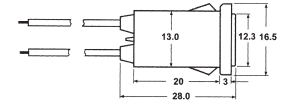

55-472-0
55-473-0
55-475-0

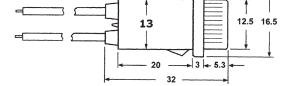

55-492-0
55-493-0
55-495-0

INCANDESCENT PILOT LAMPS

12VDC

Cat. No.	Colour	Net Price
55-472-0	Red	\$1.33
55-473-0	Amber	1.33
55-475-0	Green	1.33
55-492-0	Red	1.33
55-493-0	Amber	1.33
55-495-0	Green	1.33

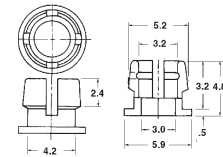

3mm plastic mounting bezel (one piece).

Cat. No.	Net Price Per 1000
55-530-0	\$83.33

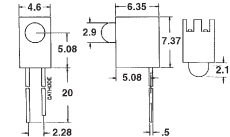

3mm R/A LED's.

Cat. No.	Colour	Description	Net Price Per 100
55-542-0	Red	1.8MCD@10ma	\$17.92
55-543-0	Orange	3.5MCD@10ma	37.67
55-544-0	Yellow	2.7MCD@10ma	37.67
55-545-0	Green	3.2MCD@10ma	20.42

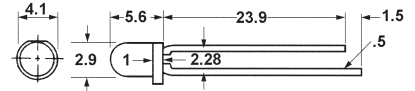

LIGHT EMITTING DIODES

Cat. No.	Size	Colour	Intensity	Net Price Per 100
STANDARD LED'S, RATED @ 10mA				
55-532-0	3mm	Red	3.0mcd	\$7.08
55-533-0	3mm	Orange	3.5mcd	10.33
55-534-0	3mm	Yellow	18mcd	10.33
55-535-0	3mm	Green	18mcd	8.50
HIGH BRIGHTNESS LED'S, RATED @ 20mA				
55-532HB-0	3mm	Red	400-500mcd	13.80
55-534HB-0	3mm	Yellow	400-600mcd	15.00
55-535HB-0	3mm	Green	600-1000mcd	108.00
SUPER BRIGHT LED'S, RATED @ 20mA				
55-532SB-0	3mm	Red	800-1000mcd	27.00
55-534SB-0	3mm	Yellow	1000-1200mcd	33.00
55-535SB-0	3mm	Green	2000-3000mcd	292.00
55-536SB-0	3mm	White	1000-2000mcd	175.00
55-537SB-0	3mm	Blue	800-1000mcd	175.00