

Push Buttons and Operator Interface Specifier's Guide

Catalog
2005

File 9001

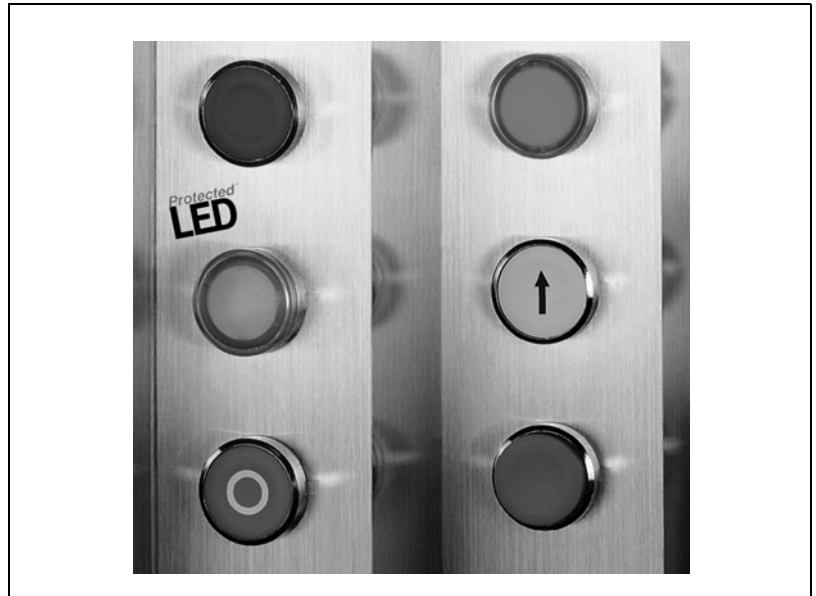

CONTENTS

Description	Page
Type XB6 16 mm Push Buttons	3
Type J, O, and XVL Miniature Pilot Light	31
Type XB4 22 mm Die Cast Chrome Plated Push Buttons	37
Type XB5 22 mm Double Insulated Push Buttons	73
Type XAL Control Stations	109
Type XAP Enclosures	117
Type K and SK 30 mm Push Buttons	123
Type KX 30 mm Push Buttons	161
Type B and 30 mm Control Stations	177
Type BW, SKYP and XACA Pendant Stations	193
Type XVB Illuminated Beacons and Indicating Banks	211
Declaration of Conformity	221
Indexed Catalog Numbers	225

Merlin Gerin
Square D
Telemecanique

Schneider
Electric
Building a New Electric World

Push Buttons and Operator Interface Specifier's Guide Type XB6 16 mm

Catalog
2005

File 9001



CONTENTS



Description	Page
Characteristics	4
Illuminated Push Buttons	6
Pilot Lights	8
Push Buttons	8
Selector Switches	10
Body/Contact Assemblies	11
Pilot Light Modules	12
Separate Contact Blocks	12
Head Assemblies	13
Component Parts	21
Component Parts and Spares	23
Accessories	24
Dimensions	25
Key Sheet - Legend Inserts with Special Markings	29
Key Sheet - Push Button Caps with Special Markings	30
Declaration of Conformity	221



Push Buttons and Operator Interface - XB6 16 mm

Characteristics

Characteristics

Environment		
Conforming to standards	 Marked	IEC 60947-1, IEC 60947-5-1, IEC 60947-5-4, EN 60947-5-1, JIS C 4520 and 852, UL 508, CSA C22.2 No. 14
Product certifications	 File E164353 CCN NKCR  File LR 44087 Class 3211 03	UL, CSA ASE, BV, JIS, RINA, LROS, DNV, GL: pending
Protective treatment Standard version		"TC"
Ambient air temperature around the device	Storage	-40 to +158 °F (-40 to +70 °C)
	Operation	-13 to +158 °F (-25 to +70 °C)
Vibration resistance	Conforming to IEC 60068-2-6	(2 - 500 Hz) 3 mm peak to peak or 5 gn
Shock resistance	Conforming to IEC 60068-2-27	Half sine wave 18 ms, 30 gn
		Half sine wave 11 ms, 50 gn
Electric shock protection	Conforming to IEC 60536 & NF C 20-030	Class II
Degree of protection	Conforming to IEC 60529 & NF C 20-010 Conforming to UL 50 & CSA C22.2 No. 94	IP 65 Type 1, 4, 4X and 12 (not for key selector switches)
Mechanical durability (in operating cycles)	Spring return push buttons	2 million
	Maintained push buttons	300,000
	Key operated selector switches	200,000
	Handle operated selector switches	500,000
Mounting positions		All
Electrical characteristics of LED pilot lights		
Voltage limits		6 - 30 Vac/Vdc
Current Draw		15 mA
Surge withstand	Conforming to IEC 61000-4-5	2/1 kV
Resistance to fast transients	Conforming to IEC 61000-4-4	2 kV
Resistance to electromagnet fields	Conforming to IEC 61000-4-3	10 V/m
Resistance to electrostatic discharges	Conforming to IEC 61000-4-2	8/6 kV
Electromagnetic emission	Conforming to EN 55011	Class B
Service life	At nominal voltage and 25°C ambient	100,000 hrs

Push Buttons and Operator Interface - XB6 16 mm Characteristics

Electrical characteristic of contacts		
Rated operational characteristics	AC-15	B300, U _e = 240 Vac and I _e = 1.5 A or U _e 120 Vac and I _e = 3 A
	DC-13	R300, U _e = 250 Vdc and I _e = 0.1 A or U _e = 125 Vdc and I _e = 0.22 A
Rated insulation voltage	Conforming to IEC 60947-1	U _i = 250 V Degree of pollution 3 (Except pilot lights with incandescent or neon bulb: degree of pollution 2)
Rated impulse withstand voltage	Conforming to IEC 60947-1	U _{imp} = 4 kV
Contact material	Normal environment and usage	Silver alloy
	Chemically corrosive environment or infrequent operation	Gold
Contact operation	N/C or N/O	Slow break, with indication of change of state by tactile feedback on push and audibility
Differential travel of contacts	With push button head	Changing N/C state: 0.04 in (1.0 mm)
		Changing N/O state: 0.08 in (2.0 mm)
		Total travel: 0.14 in (3.5 mm)
Operating force	N/C contact	0.56 lbf (2.5 N)
	N/O contact	0.36 lbf (1.6 N)
	Push button head + N/O contact	0.79 lbf (3.5 N)
	Push button head + N/C contact	1.01 lbf (4.5 N)
Positive operation	Conforming to IEC 60947-5-2	N/C contact with positive opening operation Positive opening force: 3.38 lbf (15 N)
Terminal referencing	Conforming to EN 50005 and EN 50013	
Short-circuit protection	Cartridge fuse mounted upstream	6 A gG, 6 A Class CC, Bussman KTK-R
Electrical reliability	Failure rate Conforming to IEC 60947-5-4	With confidence level of 90%: $\lambda_{90} = 10^{-8}$ 5 V - 1 mA, defect contact voltage drop = 0.5 V
Cabling		By Quick Connectors/Solder tabs 0.11 x 0.02 in (2.8 x 0.5 mm)
		By pins for printed circuit board connection 0.04 x 0.02 in (1 x 0.5 mm)
Electrical durability	Conforming to IEC 947-5-1 Appendix C Utilization category AC-15 and DC-13 Operating rate 3600 operating cycles/h. Load factor 0.5	1 million operating cycles - 200 VA-230 V

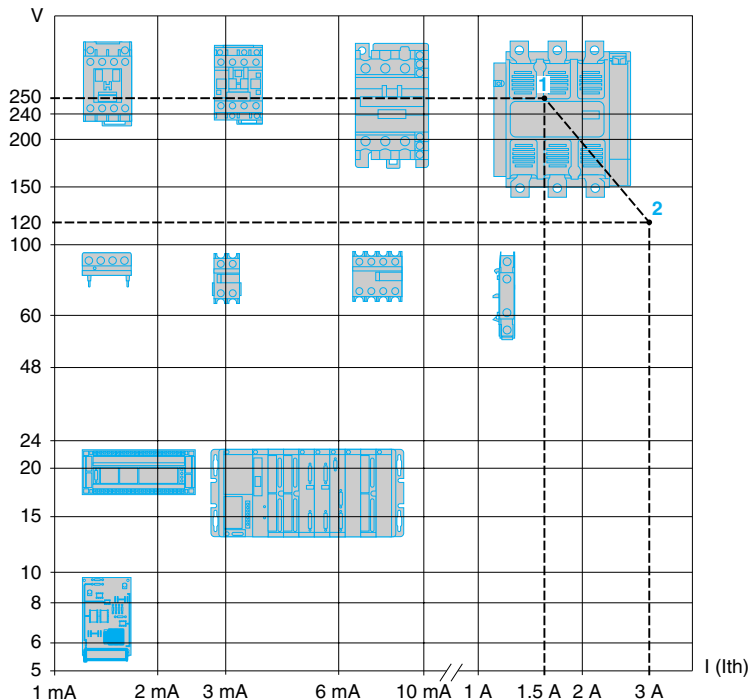

- 1 Switching capacity conforming to IEC 60947-5-1, utilization category AC-15, DC-13

B300	240 Vac	1.5 A
R300	250 Vdc	0.1 A
- 2 Switching capacity conforming to IEC 60947-5-1, utilization category AC-15, DC-13

B300	120 Vac	3 A
R300	125 Vdc	0.22 A

Push Buttons and Operator Interface - XB6 16 mm

Illuminated Push Buttons

Illuminated Push Buttons (12 - 24 VAC/VDC LED included) Complete Units with Quick Connectors/Solder Tabs

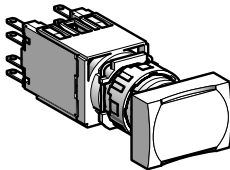
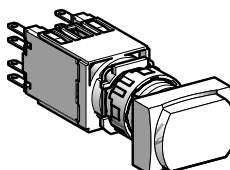
Shape of head	Type of push	Type of Contact		Color	Catalog Number
		N/O	N/C		
 <p>XB6DW***B</p>	Flush, spring return	1	-	White	XB6DW1B1B
				Green	XB6DW3B1B
		Yellow	XB6DW5B1B		
		Blue	XB6DW6B1B		
		-	1	Red	XB6DW4B2B
		1	1	White	XB6DW1B5B
	Green	XB6DW3B5B			
	Red	XB6DW4B5B			
	Yellow	XB6DW5B5B			
	Blue	XB6DW6B5B			
	Flush, maintained	1	-	White	XB6DF1B1B
				Green	XB6DF3B1B
Yellow		XB6DF5B1B			
Blue		XB6DF6B1B			
-		1	Red	XB6DF4B2B	
1		1	White	XB6DF1B5B	
Green	XB6DF3B5B				
Red	XB6DF4B5B				
Yellow	XB6DF5B5B				
Blue	XB6DF6B5B				
Extended, spring return	1	-	White	XB6DE1B1B	
			Green	XB6DE3B1B	
	Yellow	XB6DE5B1B			
	Blue	XB6DE6B1B			
	-	1	Red	XB6DE4B2B	
	1	1	White	XB6DE1B5B	
Green	XB6DE3B5B				
Red	XB6DE4B5B				
Yellow	XB6DE5B5B				
Blue	XB6DE6B5B				
 <p>XB6DE***B</p>	Flush, spring return	1	-	White	XB6CW1B1B
				Green	XB6CW3B1B
		Yellow	XB6CW5B1B		
		Blue	XB6CW6B1B		
		-	1	Red	XB6CW4B2B
		1	1	White	XB6CW1B5B
	Green	XB6CW3B5B			
	Red	XB6CW4B5B			
	Yellow	XB6CW5B5B			
	Blue	XB6CW6B5B			
	Flush, maintained	1	-	White	XB6CF1B1B
				Green	XB6CF3B1B
Yellow		XB6CF5B1B			
Blue		XB6CF6B1B			
-		1	Red	XB6CF4B2B	
1		1	White	XB6CF1B5B	
Green	XB6CF3B5B				
Red	XB6CF4B5B				
Yellow	XB6CF5B5B				
Blue	XB6CF6B5B				
Extended, spring return	1	-	White	XB6CE1B1B	
			Green	XB6CE3B1B	
	Yellow	XB6CE5B1B			
	Blue	XB6CE6B1B			
	-	1	Red	XB6CE4B2B	
	1	1	White	XB6CE1B5B	
Green	XB6CE3B5B				
Red	XB6CE4B5B				
Yellow	XB6CE5B5B				
Blue	XB6CE6B5B				

Push Buttons and Operator Interface - XB6 16 mm Illuminated Push Buttons

Illuminated Push Buttons (12 - 24 VAC/VDC LED included) (continued) Complete Units with Quick Connectors/Solder Tabs

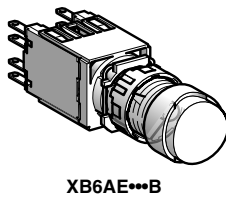
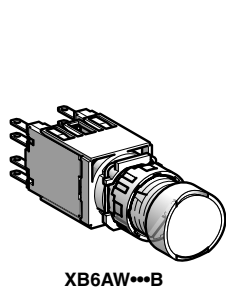

Shape of	Type of push	Type of Contact		Color	Catalog Number
		N/O	N/C		
	Flush, spring return	1	-	White	XB6AW1B1B
				Green	XB6AW3B1B
				Yellow	XB6AW5B1B
				Blue	XB6AW6B1B
		-	1	Red	XB6AW4B1B
		1	1	White	XB6AW1B5B
	Green			XB6AW3B5B	
	Red			XB6AW4B5B	
	Yellow			XB6AW5B5B	
	Blue			XB6AW6B5B	
	Flush, maintained	1	-	White	XB6AF1B1B
				Green	XB6AF3B1B
				Yellow	XB6AF5B1B
		-	1	Blue	XB6AF6B1B
				Red	XB6AF4B1B
White				XB6AF1B5B	
1		1	Green	XB6AF3B5B	
			Red	XB6AF4B5B	
			Yellow	XB6AF5B5B	
Extended, spring return	1	-	Blue	XB6AF6B5B	
			White	XB6AE1B1B	
			Green	XB6AE3B1B	
	-	1	Yellow	XB6AE5B1B	
			Blue	XB6AE6B1B	
			Red	XB6AE4B1B	
1	1	White	XB6AE1B5B		
		Green	XB6AE3B5B		
		Red	XB6AE4B5B		
-	1	Yellow	XB6AE5B5B		
		Blue	XB6AE6B5B		

Push Buttons and Operator Interface - XB6 16 mm

Pilot Lights and Push Buttons

Pilot Lights (12 - 24 VAC/VDC LED included) Complete Units with Quick Connectors/Solder Tabs

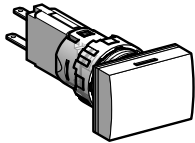

XB6DV•BB

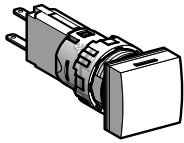

XB6CV•BB

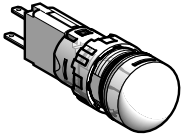

XB6AV•BB

Shape of head		Color	Catalog Number
□		White	XB6DV1BB
		Green	XB6DV3BB
		Red	XB6DV4BB
		Yellow	XB6DV5BB
		Blue	XB6DV6BB
□		White	XB6CV1BB
		Green	XB6CV3BB
		Red	XB6CV4BB
		Yellow	XB6CV5BB
		Blue	XB6CV6BB
●		White	XB6AV1BB
		Green	XB6AV3BB
		Red	XB6AV4BB
		Yellow	XB6AV5BB
		Blue	XB6AV6BB

Trigger Action Emergency Stop Mushroom Head Push Buttons (Color Red)



XB6AS8345B







XB6AS9345B

Shape of head	Type of push	Type of Contact		Diameter of push (mm)	Catalog Number
		N/O	N/C		
●	Turn to release	-	1	30	XB6AS8342B
		1	1	30	XB6AS8345B
●	Key release	-	1	30	XB6AS9342B
		1	1	30	XB6AS9345B

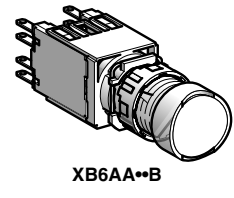
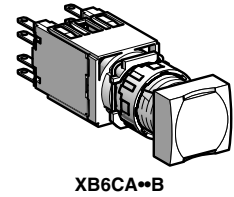
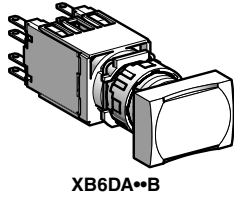
Push Buttons and Operator Interface - XB6 16 mm Push Buttons

Push Buttons Complete Units with Quick Connectors/Solder Tabs



Shape of head	Type of push	Type of Contact		Color	Catalog Number
		N/O	N/C		
	Flush, spring return	1	-	White	XB6DA11B
				Black	XB6DA21B
				Green	XB6DA31B
		-	1	Yellow	XB6DA51B
				Blue	XB6DA61B
				Black	XB6DA22B
		1	1	Red	XB6DA42B
				White	XB6DA15B
				Black	XB6DA25B
Green	XB6DA35B				
Red	XB6DA45B				
Yellow	XB6DA55B				
Blue	XB6DA65B				
	Flush, spring return	1	-	White	XB6CA11B
				Black	XB6CA21B
				Green	XB6CA31B
		-	1	Yellow	XB6CA51B
				Blue	XB6CA61B
				Black	XB6CA22B
		1	1	Red	XB6CA42B
				White	XB6CA15B
				Black	XB6CA25B
Green	XB6CA35B				
Red	XB6CA45B				
Yellow	XB6CA55B				
Blue	XB6CA65B				
	Flush, spring return	1	-	White	XB6AA11B
				Black	XB6AA21B
				Green	XB6AA31B
		-	1	Yellow	XB6AA51B
				Blue	XB6AA61B
				Black	XB6AA22B
		1	1	Red	XB6AA42B
				White	XB6AA15B
				Black	XB6AA25B
Green	XB6AA35B				
Red	XB6AA45B				
Yellow	XB6AA55B				
Blue	XB6AA65B				

Push Buttons and Operator Interface - XB6 16 mm Selector Switches

Selector Switches (Switching Angle: Handle: 60°, Key: 70°) ■ Complete Units with Quick Connectors/Solder Tabs

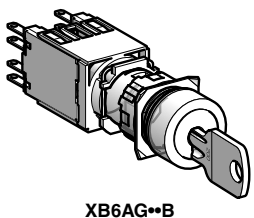
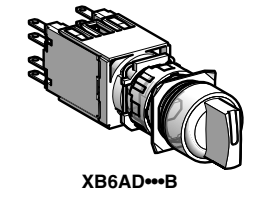
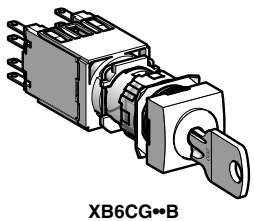
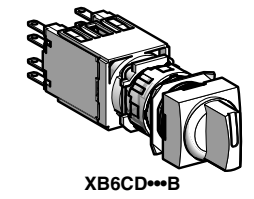
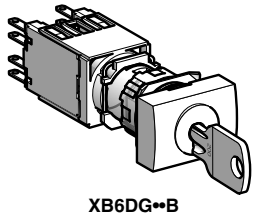
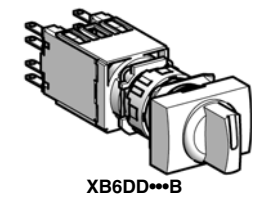

Shape of head	Type of operator	Type of Contact		Number and type of positions		Catalog Number
		N/O	N/C			
	Handle	1	-	2 - maintained		XB6DD221B
		1	1	2 - maintained		XB6DD225B
				3 - maintained		XB6DD235B
	Key	1	1	2 - maintained		XB6DGC5B
				3 - maintained		XB6DGH5B
	Handle	1	-	2 - maintained		XB6CD221B
		1	1	2 - maintained		XB6CD225B
				3 - maintained		XB6CD235B
	Key	1	1	2 - maintained		XB6CGC5B
				3 - maintained		XB6CGH5B
	Handle	1	-	2 - maintained		XB6AD221B
		1	1	2 - maintained		XB6AD225B
				3 - maintained		XB6AD235B
	Key	1	1	2 - maintained		XB6AGC5B
				3 - maintained		XB6AGH5B

Indicates key withdrawal position.
 ■ See selector switch sequence charts on page 20.

Push Buttons and Operator Interface - XB6 16 mm Body/Contact Assemblies

Contact Blocks and Light Modules for Illuminated Push Buttons ■

(To combine with heads, see pages 13 to 19.)

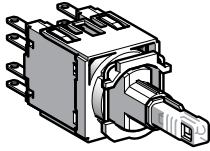

ZB6ZBB**

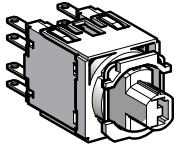

ZB6ZHB**

Description	Supply Voltage	Type of Contact		Color of Light Source	Catalog Number
		N/O	N/C		
Quick connectors/solder tabs					
Integral LED ▲	12-24 Vac or Vdc	1	-	White	ZB6ZB11B
				Green	ZB6ZB31B
				Yellow	ZB6ZB51B
				Blue	ZB6ZB61B
		-	1	Red	ZB6ZB42B
				Yellow	ZB6ZB52B
		1	1	White	ZB6ZB15B
				Green	ZB6ZB35B
				Red	ZB6ZB45B
Yellow	ZB6ZB55B				
Direct for incandescent bulb (not included) ●	3-24 Vac or Vdc	1	-	-	ZB6ZH01B
		-	1	-	ZB6ZH02B
		1	1	-	ZB6ZH05B

Contact Blocks for Push Buttons and Selector Switches

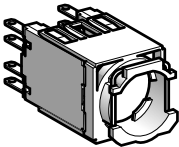

ZB6Z*B

Description	Type of Contact		Catalog Number
	N/O	N/C	
Quick connectors/solder tabs			
Contact blocks with mounting base	1	-	ZB6Z1B
	-	1	ZB6Z2B
	2	-	ZB6Z3B
	-	2	ZB6Z4B
	1	1	ZB6Z5B
	3	-	ZB6Z6B ◆
	-	3	ZB6Z7B ◆
	2	1	ZB6Z8B ◆
	1	2	ZB6Z9B ◆

- It is possible to assemble illuminated selector switches by using a contact block /light module assembly in conjunction with a selector switch head, supplied without handle (see page 17), and a transparent handle (see page 23).
- ▲ The color of the LED must be the same as that of the push button cap.
- Bulbs to be ordered separately (see page 24).
- ◆ Three (3) contact assemblies can only be used with non-illuminated push buttons fitted with a ZB6Y017 link (see page 24).

Push Buttons and Operator Interface - XB6 16 mm Pilot Light Modules and Separate Contact Blocks

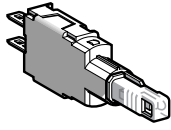

ZB6EB•B

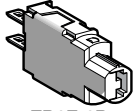

ZB6E•0B

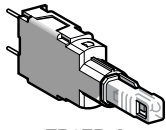

ZB6EB•A

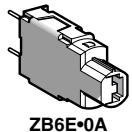

ZB6E•0A

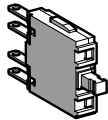

ZB6E•B

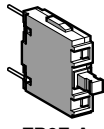

ZB6E•A

Light Modules for Pilot Lights

(To combine with heads, see pages 13 to 19.)

Description	Supply Voltage	Color of Light Source	Catalog Number
Quick connectors/solder tabs			
Integral LED ■	12-24 Vac or Vdc	White	ZB6EB1B
		Green	ZB6EB3B
		Red	ZB6EB4B
		Yellow	ZB6EB5B
		Blue	ZB6EB6B
With resistor for 95 V neon bulb (not included) ▲ ●	110 Vac	–	ZB6EG0B
	230 Vac	–	ZB6EM0B
Direct supply for 0.6 W max. incandescent bulb (not included) ▲	≤ 24 Vac or Vdc	–	ZB6EH0B
Pins for printed circuit boards			
Integral LED ■	12-24 Vac or Vdc	White	ZB6EB1A
		Green	ZB6EB3A
		Red	ZB6EB4A
		Yellow	ZB6EB5A
		Blue	ZB6EB6A
With resistor for 95 V neon bulb (not included) ▲ ●	110 Vac	–	ZB6EG0A
	230 Vac	–	ZB6EM0A
Direct supply for 0.6 W max. incandescent bulb (not included) ▲	3-24 Vac or Vdc	–	ZB6EH0A

Separate Contact Blocks (Maximum of 3 contacts per mounting base.)

Contact Material	For use with mounting base	Type of Contact		Catalog Number
		N/O	N/C	
Silver alloy	Quick connectors/solder tabs	1	–	ZB6E1B
		–	1	ZB6E2B
	Pins for PCBs	1	–	ZB6E1A
		–	1	ZB6E2A
Gold flashed	Quick connectors/solder tabs	1	–	ZB6E1E
		–	1	ZB6E2E
	Pins for PCBs	1	–	ZB6E1D
		–	1	ZB6E2D

■ The color of the LED must be the same as that of the lens.

▲ Bulbs to be ordered separately (see page 24).

● Neon bulb can only be used with red, yellow, or white cap.

Push Buttons and Operator Interface - XB6 16 mm Head Assemblies

Heads for Illuminated Push Buttons

(To combine with complete bodies and contact blocks, see pages 11 and 12.)

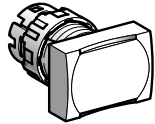

ZB6DW•

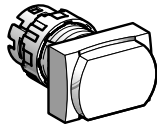

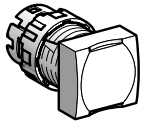

ZB6DE•

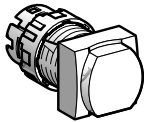

ZB6CW•



ZB6CE•

Shape of head	Type of push	Color of cap	Catalog Number
	Flush, spring return	White	ZB6DW1
		Green	ZB6DW3
		Red	ZB6DW4
		Yellow	ZB6DW5
		Blue	ZB6DW6
		5 colors ■	ZB6DW9
	Without cap ▲	ZB6DW0	
	Flush, maintained	White	ZB6DF1
		Green	ZB6DF3
Red		ZB6DF4	
Yellow		ZB6DF5	
Blue		ZB6DF6	
5 colors ■		ZB6DF9	
Without cap ▲	ZB6DF0		
Extended, spring return	White	ZB6DE1	
	Green	ZB6DE3	
	Red	ZB6DE4	
	Yellow	ZB6DE5	
	Blue	ZB6DE6	
	5 colors ■	ZB6DE9	
Without cap ▲	ZB6DE0		
	Flush, spring return	White	ZB6CW1
		Green	ZB6CW3
		Red	ZB6CW4
		Yellow	ZB6CW5
		Blue	ZB6CW6
		5 colors ■	ZB6CW9
	Without cap ▲	ZB6CW0	
	Flush, maintained	White	ZB6CF1
		Green	ZB6CF3
Red		ZB6CF4	
Yellow		ZB6CF5	
Blue		ZB6CF6	
5 colors ■		ZB6CF9	
Without cap ▲	ZB6CF0		
Extended, spring return	White	ZB6CE1	
	Green	ZB6CE3	
	Red	ZB6CE4	
	Yellow	ZB6CE5	
	Blue	ZB6CE6	
	5 colors ■	ZB6CE9	
Without cap ▲	ZB6CE0		

■ Five (5) separate different color caps included with head (white, green, red, yellow, and blue).

▲ To order the push button caps separately, see page 21.

Push Buttons and Operator Interface - XB6 16 mm Head Assemblies

Heads for Illuminated Push Buttons (continued)

(To combine with complete bodies and contact blocks, see pages 11 and 12.)



ZB6AW•



ZB6AE•

Shape of head	Type of push	Color of cap	Catalog Number
	Flush, spring return	White	ZB6AW1
		Green	ZB6AW3
		Red	ZB6AW4
		Yellow	ZB6AW5
		Blue	ZB6AW6
		5 colors ■	ZB6AW9
	Without cap ▲	ZB6AW0	
	Flush, maintained	White	ZB6AF1
		Green	ZB6AF3
Red		ZB6AF4	
Yellow		ZB6AF5	
Blue		ZB6AF6	
5 colors ■		ZB6AF9	
Without cap ▲	ZB6AF0		
Extended, spring return	White	ZB6AE1	
	Green	ZB6AE3	
	Red	ZB6AE4	
	Yellow	ZB6AE5	
	Blue	ZB6AE6	
	5 colors ■	ZB6AE9	
Without cap ▲	ZB6AE0		

■ Five (5) separate different color caps included with head (white, green, red, yellow, and blue).

▲ To order the push button caps separately, see page 21.

Heads for Pilot Lights

(To combine with light modules, see page 12.)

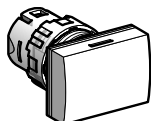

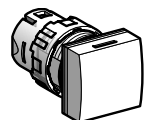

ZB6DV•



ZB6CV•



ZB6AV•

Shape of head	Color of lens	Catalog Number
	White	ZB6DV1
	Green	ZB6DV3
	Red	ZB6DV4
	Yellow	ZB6DV5
	Blue	ZB6DV6
	5 colors ■	ZB6DV9
	Without lens ▲	ZB6DV0
	White	ZB6CV1
	Green	ZB6CV3
	Red	ZB6CV4
	Yellow	ZB6CV5
	Blue	ZB6CV6
	5 colors ■	ZB6CV9
	Without lens ▲	ZB6CV0
	White	ZB6AV1
	Green	ZB6AV3
	Red	ZB6AV4
	Yellow	ZB6AV5
	Blue	ZB6AV6
	5 colors ■	ZB6AV9
	Without lens ▲	ZB6AV0

■ Five (5) separate different color lenses included with head (white, green, red, yellow, and blue).



▲ To order the caps or lenses separately, see pages 21 to 23.

Push Buttons and Operator Interface - XB6 16 mm Head Assemblies

Heads for Push Buttons (non-illuminated)

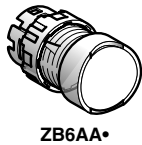
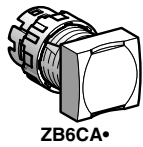
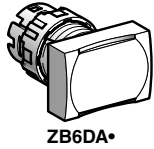
(To combine with complete bodies and contact blocks, see pages 11 and 12.)



Shape of head	Type of push	Color of cap	Catalog Number
	Flush, spring return	White	ZB6DA1
		Black	ZB6DA2
		Green	ZB6DA3
		Red	ZB6DA4
		Yellow	ZB6DA5
		Blue	ZB6DA6
		6 colors ■	ZB6DA9
	Without cap ▲	ZB6DW0	
	Flush, spring return	White	ZB6CA1
		Black	ZB6CA2
		Green	ZB6CA3
		Red	ZB6CA4
		Yellow	ZB6CA5
		Blue	ZB6CA6
		6 colors ■	ZB6CA9
	Without cap ▲	ZB6CW0	
	Flush, spring return	White	ZB6AA1
		Black	ZB6AA2
		Green	ZB6AA3
		Red	ZB6AA4
		Yellow	ZB6AA5
		Blue	ZB6AA6
		6 colors ■	ZB6AA9
	Without cap ▲	ZB6AW0	

■ Six (6) separate different color caps included with head (white, black, green, yellow, red, and blue).

▲ To order the caps or lenses separately, see pages 21 to 23.

Mushroom Heads for Push Buttons (24 mm)





Shape of head	Type of push	Color of cap	Catalog Number
	Spring return	White	ZB6AC1
		Black	ZB6AC2
		Green	ZB6AC3
		Yellow	ZB6AC5
		Blue	ZB6AC6



Mushroom Heads for Trigger Action Push Buttons (30 mm)



Shape of head	Type of push	Color of cap	Catalog Number
	Turn to release	Red	ZB6AS834
	Key release	Red	ZB6AS934

Push Buttons and Operator Interface - XB6 16 mm Head Assemblies

Heads for Handle Operated Selector Switches ■ ●

(To combine with complete bodies and contact blocks, see pages 11 and 12.)

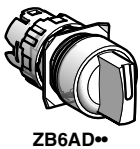
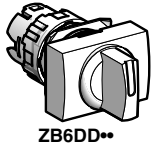

Shape of head	Number and type of positions	Color of handle	Catalog Number
Switching angle: maintained positions 60°, spring return positions 45°			
	2 - maintained	Black	ZB6DD22
	2 - maintained	Black	ZB6DD28 ▲
	3 - maintained	Black	ZB6DD23
	2 - spring return to center	Black	ZB6DD24
	3 - spring return to center	Black	ZB6DD25
	3 - spring return from right to center	Black	ZB6DD26
	3 - spring return from left to center	Black	ZB6DD27
	2 - maintained	Black	ZB6CD22
	2 - maintained	Black	ZB6CD28 ▲
	3 - maintained	Black	ZB6CD23
	2 - spring return to center	Black	ZB6CD24
	3 - spring return to center	Black	ZB6CD25
	3 - spring return from right to center	Black	ZB6CD26
	3 - spring return from left to center	Black	ZB6CD27
	2 - maintained	Black	ZB6AD22
	2 - maintained	Black	ZB6AD28 ▲
	3 - maintained	Black	ZB6AD23
	2 - spring return to center	Black	ZB6AD24
	3 - spring return to center	Black	ZB6AD25
	3 - spring return from right to center	Black	ZB6AD26
	3 - spring return from left to center	Black	ZB6AD27

- For bodies with 2 contact blocks, maximum.
- ▲ Switching angle: maintained positions 90°.
- See selector switch sequence charts on page 20.

Push Buttons and Operator Interface - XB6 16 mm Head Assemblies

Heads for Illuminated Selector Switches, without Handle ■ ●

(To combine with complete bodies and contact blocks, see pages 11 and 12.)

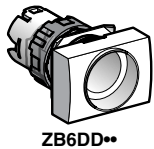

ZB6DD**



ZB6CD0*



ZB6AD0*

Shape of head	Number and type of positions	Catalog Number	
Switching angle: maintained positions 60°, spring return positions 45°			
	2 - maintained	ZB6DD02	
	2 - maintained	ZB6DD08 ▲	
	3 - maintained	↓	ZB6DD03
	2 - spring return to center	↵	ZB6DD204
	3 - spring return to center	↕	ZB6DD05
	3 - spring return from right to center	↘	ZB6DD06
	3 - spring return from left to center	↙	ZB6DD07
	2 - maintained	ZB6CD02	
	2 - maintained	ZB6CD08 ▲	
	3 - maintained	↓	ZB6CD03
	2 - spring return to center	↵	ZB6CD04
	3 - spring return to center	↕	ZB6CD05
	3 - spring return from right to center	↘	ZB6CD06
	3 - spring return from left to center	↙	ZB6CD07
	2 - maintained	ZB6AD02	
	2 - maintained	ZB6AD08 ▲	
	3 - maintained	↓	ZB6AD03
	2 - spring return to center	↵	ZB6AD04
	3 - spring return to center	↕	ZB6AD05
	3 - spring return from right to center	↘	ZB6AD06
	3 - spring return from left to center	↙	ZB6AD07

■ Handle to be ordered separately (see page 23), for bodies with 2 contact blocks maximum.

▲ Switching angle: maintained positions 90°.

● See selector switch sequence charts on page 20.

Push Buttons and Operator Interface - XB6 16 mm Head Assemblies

Heads for Ronis Key Operated Selector Switches ■

(To combine with complete bodies and contact blocks, see pages 11 and 12.)

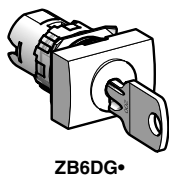

ZB6DG•

Shape of head	Number and type of positions	Key withdrawal	Key withdrawal	Catalog Number
Switching angle: maintained positions 70°, spring return positions 45°				
	2 - maintained		Right-hand position	ZB6DGA
			Center position	ZB6DGB
			Both positions	ZB6DGC
	2 - spring return from right to center		Center position	ZB6DGL
	3 - maintained		Left-hand position	ZB6DGD
			Center position	ZB6DGE
			Left-hand and center position	ZB6DGF
			Right-hand position	ZB6DGG
			All 3 positions	ZB6DGH
			Left-hand and right-hand positions	ZB6DGJ
			Right-hand and center positions	ZB6DGK
	3 - spring return from left to center		Right-hand position	ZB6DGM
			Center position	ZB6DGN
			Right-hand and center position	ZB6DGP
	3 - spring return from right to center		Left-hand position	ZB6DQ
			Center position	ZB6DGR
			Left-hand and center position	ZB6DGS
	3 - spring return to center		Center position	ZB6DGT

Indicates key withdrawal position.

■ See selector switch sequence charts on page 20.







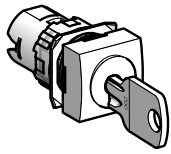











Push Buttons and Operator Interface - XB6 16 mm Head Assemblies

Heads for Ronis Key Operated Selector Switches (continued) ■

(To combine with complete bodies and contact blocks, see pages 11 and 12.)



ZB6CG*

Shape of head	Number and type of positions	Key withdrawal	Catalog Number	
Switching angle: maintained positions 70°, spring return positions 45°				
	2 - maintained		Right-hand position	ZB6CGA
			Center position	ZB6CGB
			Both positions	ZB6CGC
	2 - spring return		Center position	ZB6CGL
	3 - maintained		Left-hand position	ZB6CGD
			Center position	ZB6CGE
			Left-hand and center position	ZB6CGF
			Right-hand position	ZB6CGG
			All 3 positions	ZB6CGH
			Left-hand and right-hand positions	ZB6CGJ
			Right-hand and center positions	ZB6CGK
	3 - spring return from left to center		Right-hand position	ZB6CGM
			Center position	ZB6CGN
			Right-hand and center position	ZB6CGP
	3 - spring return from right to center		Left-hand position	ZB6CGQ
			Center position	ZB6CGR
			Left-hand and center position	ZB6CGS
	3 - spring return to center		Center position	ZB6CGT

 Indicates key withdrawal position.

■ See selector switch sequence charts on page 20.

Push Buttons and Operator Interface - XB6 16 mm Head Assemblies

Heads for Ronis Key Operated Selector Switches (continued) ■ (To combine with complete bodies and contact blocks, see pages 11 and 12.)

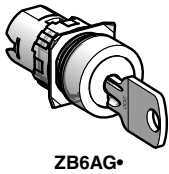

ZB6AG*

	2 - maintained		Right-hand position	ZB6AGA
			Center position	ZB6AGB
			Both positions	ZB6AGC
	2 - spring return from right to center		Center position	ZB6AGL
	3 - maintained		Left-hand position	ZB6AGD
			Center position	ZB6AGE
			Left-hand and center position	ZB6AGF
			Right-hand position	ZB6AGG
			All 3 positions	ZB6AGH
			Left-hand and right-hand positions	ZB6AGJ
			Right-hand and center positions	ZB6AGK
	3 - spring return from left to center		Right-hand position	ZB6AGM
			Center position	ZB6AGN
			Right-hand and center position	ZB6AGP
	3 - spring return from right to center		Left-hand position	ZB6AGQ
			Center position	ZB6AGR
			Left-hand and center position	ZB6AGS
	3 - spring return to center		Center position	ZB6AGT

Indicates key withdrawal position.
 ■ See selector switch sequence charts below.

Selector Switch Sequence (using contact block assemblies, page 11)



2 Position Selector Switch		
		Contact block guide
O	X	1 N.O. (left or right)
X	O	1 N.C. (left or right)
O	X	1 N.O. and
X	O	1 N.C.

3 Position Selector Switch			
			Contact block guide
O	O	X	1 N.O. (left)
X	O	X	2 N.O. wired in PARALLEL, (left and right)
X	O	O	1 N.O. (right)
O	X	X	1 N.C. (right)
X	X	O	1 N.C. (left)
O	X	O	2 N.C. wired in SERIES, (left and right)

Push Buttons and Operator Interface - XB6 16 mm Component Parts

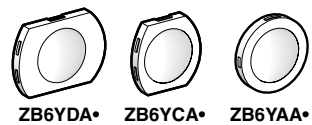
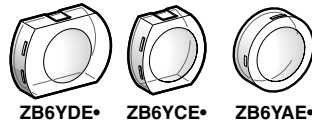

Push Button Caps - Unmarked

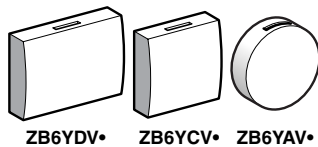

Application	Color	Catalog Number		
		 Head	 Head	 Head
Illuminated push buttons with flush push	White	ZB6YDW1	ZB6YCW1	ZB6YAW1
	Green	ZB6YDW3	ZB6YCW3	ZB6YAW3
	Red	ZB6YDW4	ZB6YCW4	ZB6YAW4
	Yellow	ZB6YDW5	ZB6YCW5	ZB6YAW5
	Blue	ZB6YDW6	ZB6YCW6	ZB6YAW6
	Illuminated push buttons with extended push	White	ZB6YDE1	ZB6YCE1
Green		ZB6YDE3	ZB6YCE3	ZB6YAE3
Red		ZB6YDE4	ZB6YCE4	ZB6YAE4
Yellow		ZB6YDE5	ZB6YCE5	ZB6YAE5
Blue		ZB6YDE6	ZB6YCE6	ZB6YAE6
Non illuminated push buttons		White	ZB6YDA1	ZB6YCA1
	Black	ZB6YDA2	ZB6YCA2	ZB6YAA2
	Green	ZB6YDA3	ZB6YCA3	ZB6YAA3
	Red	ZB6YDA4	ZB6YCA4	ZB6YAA4
	Yellow	ZB6YDA5	ZB6YCA5	ZB6YAA5
	Blue	ZB6YDA6	ZB6YCA6	ZB6YAA6

Lens Caps





Application	Color	Catalog Number		
		 Head	 Head	 Head
Pilot lights	White	ZB6YDV1	ZB6YCV1	ZB6YAV1
	Green	ZB6YDV3	ZB6YCV3	ZB6YAV3
	Red	ZB6YDV4	ZB6YCV4	ZB6YAV4
	Yellow	ZB6YDV5	ZB6YCV5	ZB6YAV5
	Blue	ZB6YDV6	ZB6YCV6	ZB6YAV6

Push Buttons and Operator Interface - XB6 16 mm

Component Parts

Push Button Caps - Marked



Ink Marking Color: White on colored cap. Black on white cap.	Color	Catalog Number		
		 Head	 Head	 Head
For non-illuminated push buttons				
0	White	ZB6YD100	ZB6YC100	ZB6YA100
	Black	ZB6YD200	ZB6YC200	ZB6YA200
1	White	ZB6YD101	ZB6YC101	ZB6YA101
	Black	ZB6YD201	ZB6YC201	ZB6YA201
2	White	ZB6YD102	ZB6YC102	ZB6YA102
	Black	ZB6YD202	ZB6YC202	ZB6YA202
3	White	ZB6YD103	ZB6YC103	ZB6YA103
	Black	ZB6YD203	ZB6YC203	ZB6YA203
4	White	ZB6YD104	ZB6YC104	ZB6YA104
	Black	ZB6YD204	ZB6YC204	ZB6YA204
5	White	ZB6YD105	ZB6YC105	ZB6YA105
	Black	ZB6YD205	ZB6YC205	ZB6YA205
6	White	ZB6YD106	ZB6YC106	ZB6YA106
	Black	ZB6YD206	ZB6YC206	ZB6YA206
7	White	ZB6YD107	ZB6YC107	ZB6YA107
	Black	ZB6YD207	ZB6YC207	ZB6YA207
8	White	ZB6YD108	ZB6YC108	ZB6YA108
	Black	ZB6YD208	ZB6YC208	ZB6YA208
9	White	ZB6YD109	ZB6YC109	ZB6YA109
	Black	ZB6YD209	ZB6YC209	ZB6YA209
I	White	ZB6YD111	ZB6YC111	ZB6YA111
	Green	ZB6YD311	ZB6YC311	ZB6YA311
O	Black	ZB6YD210	ZB6YC210	ZB6YA210
	Red	ZB6YD410	ZB6YC410	ZB6YA410
II	White	ZB6YD112	ZB6YC112	ZB6YA112
	Black	ZB6YD212	ZB6YC212	ZB6YA212
III	White	ZB6YD113	ZB6YC113	ZB6YA113
	Black	ZB6YD213	ZB6YC213	ZB6YA213
+	White	ZB6YD114	ZB6YC114	ZB6YA114
	Black	ZB6YD214	ZB6YC214	ZB6YA214
-	White	ZB6YD115	ZB6YC115	ZB6YA115
	Black	ZB6YD215	ZB6YC215	ZB6YA215
MARCHE	White	ZB6YD116	ZB6YC116	ZB6YA116
	Green	ZB6YD316	ZB6YC316	ZB6YA316
ON	White	ZB6YD117	ZB6YC117	ZB6YA117
	Green	ZB6YD317	ZB6YC317	ZB6YA317
EIN	White	ZB6YD118	ZB6YC118	ZB6YA118
	Green	ZB6YD318	ZB6YC318	ZB6YA318
ARRET	Black	ZB6YD223	ZB6YC223	ZB6YA223
	Red	ZB6YD423	ZB6YC423	ZB6YA423
OFF	Black	ZB6YD224	ZB6YC224	ZB6YA224
	Red	ZB6YD424	ZB6YC424	ZB6YA424
AUS	Black	ZB6YD225	ZB6YC225	ZB6YA225
	Red	ZB6YD425	ZB6YC425	ZB6YA425
R	Blue	ZB6YD426	ZB6YC426	ZB6YA426

Push Buttons and Operator Interface - XB6 16 mm Component Parts and Spares

Push Button Caps - Marked (continued)



ZB6YD•19





ZB6YC•19



ZB6YA•19



ZB6YK•

Marking Color: White on colored cap. Black on white cap.	Color	Catalog Number		
		 Head	 Head	 Head
For non-illuminated push buttons				
MONTEE	White	ZB6YD129	ZB6YC129	ZB6YA129
	Black	ZB6YD229	ZB6YC229	ZB6YA229
UP	White	ZB6YD127	ZB6YC127	ZB6YA127
	Black	ZB6YD227	ZB6YC227	ZB6YA227
DESCENTE	White	ZB6YD130	ZB6YC130	ZB6YA130
	Black	ZB6YD230	ZB6YC230	ZB6YA230
DOWN	White	ZB6YD128	ZB6YC128	ZB6YA128
	Black	ZB6YD228	ZB6YC228	ZB6YA228
AB	White	ZB6YD134	ZB6YC134	ZB6YA134
	Black	ZB6YD234	ZB6YC234	ZB6YA234
FERME	White	ZB6YD133	ZB6YC133	ZB6YA133
	Black	ZB6YD233	ZB6YC233	ZB6YA233
CLOSE	White	ZB6YD132	ZB6YC132	ZB6YA132
	Black	ZB6YD232	ZB6YC232	ZB6YA232
ZU	White	ZB6YD131	ZB6YC131	ZB6YA131
	Black	ZB6YD231	ZB6YC231	ZB6YA231
↑	White	ZB6YD119	ZB6YC119	ZB6YA119
	Black	ZB6YD219	ZB6YC219	ZB6YA219
↓	White	ZB6YD120	ZB6YC120	ZB6YA120
	Black	ZB6YD220	ZB6YC220	ZB6YA220
→	White	ZB6YD121	ZB6YC121	ZB6YA121
	Black	ZB6YD221	ZB6YC221	ZB6YA221
←	White	ZB6YD122	ZB6YC122	ZB6YA122
	Black	ZB6YD222	ZB6YC222	ZB6YA222

Component Parts

Description	Color	Catalog Number
Handles for illuminated selector switches ■	White	ZB6YK1
	Green	ZB6YK3
	Red	ZB6YK4
	Yellow	ZB6YK5
	Blue	ZB6YK6

Spare Parts

Description	Color	Catalog Number
Handles for non-illuminated selector switches	Black	ZB6YD2
	Red	ZB6YD4

■ For use in conjunction with head without handle (see page 17) and body/contact assembly for illuminated push buttons (see page 11).

Push Buttons and Operator Interface - XB6 16 mm Accessories

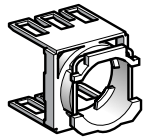

ZB6Y009

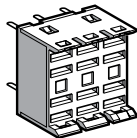

ZB6Y010

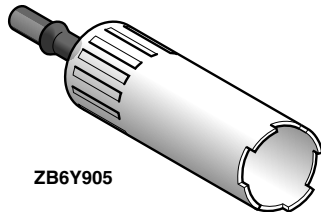

ZB6Y905



ZB6Y002



ZB6Y003

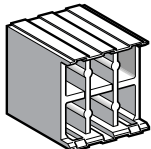

ZB6Y001

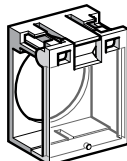

ZB6YA001

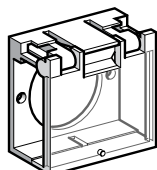

ZB6YD001

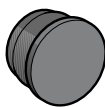

ZB6Y005



ZB6Y007



ZB6Y7330

Accessories

Description	Application	Catalog Number
Body	For fitting contact blocks	ZB6Y009
Plug-in socket adaptor	Printed circuit board mounting	ZB6Y010
Body for printed circuit board	Printed circuit board mounting	ZB6Y011
Bezel tightening tool + bulb extractor	Fixing the switch and changing bulbs	ZB6Y905
Cap extractor	For changing caps	ZB6Y016
Contact block removal tool	For removing contact blocks	ZB6Y018
Three piece tool kit	–	ZB6Y019
Nut	Fixing head to panel	ZB6Y002
Anti-rotation plate	Selector switches	ZB6Y003
Dummy contact block (without contact)	Printed circuit board mounting	ZB6Y006
Adaptor	Flush mounting of circular head push button or pilot light in \varnothing 22 mm cut-out	ZB6YA002
Shroud	Protection of contacts against touching	ZB6Y001
Protective cover	Circular and square head push buttons and switches	ZB6YA001
	Rectangular head push buttons and switches	ZB6YD001
Female Quick connector/Solder tab	Sold in lots of 100 pieces	ZB6Y004
Blanking plug	–	ZB6Y005
Ronis key	Key operated selector switches, emergency stop mushroom, 2 pieces	ZB6Y007
Incandescent bulbs, bayonet T1 1/4	6 V	ZB6YA006
	12 V	ZB6YJ012
	28 V ■	ZB6YB028
Neon bulbs	110/230 V ▲	ZB6YG095
Link	Operation of 3rd contact	ZB6Y017
Sheets of peel-off legends For use with SIS label, size A4, 66 labels per sheet (297 mm x 210 mm)	Pilot lights rectangular	ZB6YD003
	Pilot lights square	ZB6YC003
	Pilot lights circular	ZB6YA003
	Illuminated push buttons rectangular	ZB6YD013
	Illuminated push buttons square	ZB6YC013
	Illuminated push buttons circular	ZB6YA013

■ 28 V bulb supplied, for use on 24 V.

▲ 95 V bulb supplied, for use on 110/230 V.

Circular Legends, 45 mm

Description	Color		Catalog Number
Circular legends, 45 mm	Yellow	Blank	ZB6Y7001
		Emergency stop	ZB6Y7330
		Arrêt d'urgence	ZB6Y7130

Push Buttons and Operator Interface - XB6 16 mm Dimensions

Push Buttons (Illuminated and Non-illuminated)

Rectangular Head

XB6DW***, DF***, DA***

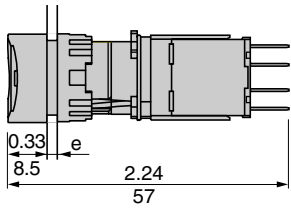

XB6DE***

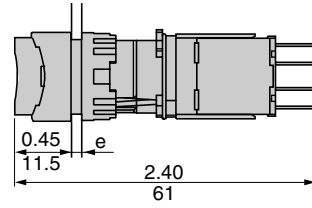

Common Face View

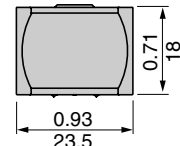

Square Head

XB6CW***, CF***, CA***

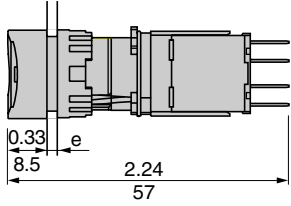

XB6CE***

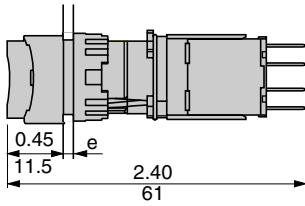

Common Face View

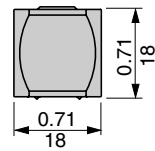

Circular Head

XB6AW***, AF***, AA***

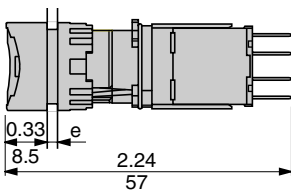

XB6AE***

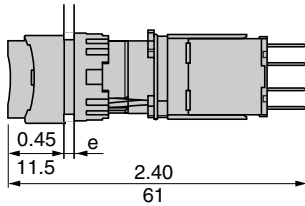

Common Face View



Dual Dimensions $\frac{\text{inches}}{\text{mm}}$

Pilot Lights

Rectangular Head

XB6DV***

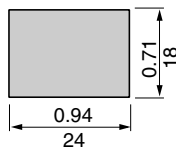
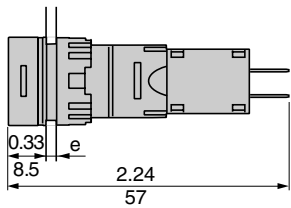

Mushroom Head Push Button

XB6AS834•B

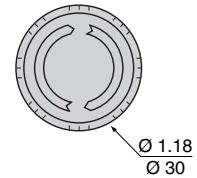
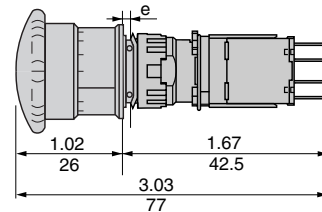

Square Head

XB6CV***

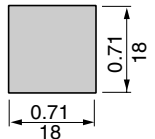
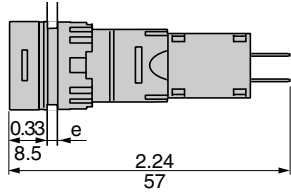

Mushroom Head Push Button

XB6AS934•B

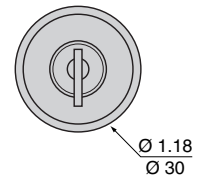
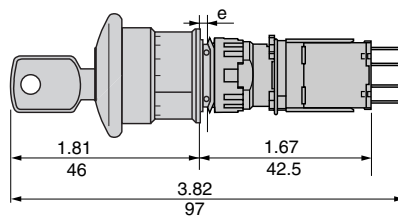

Circular Head

XB6AV***

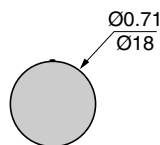
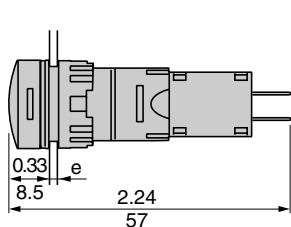

e: panel thickness $\frac{0.04 \text{ to } 0.24 \text{ in}}{1 \text{ to } 6 \text{ mm}}$

Dual Dimensions $\frac{\text{inches}}{\text{mm}}$

Push Buttons and Operator Interface - XB6 16 mm Dimensions

Selector Switches - Handle Operated Rectangular Head XB6DD***

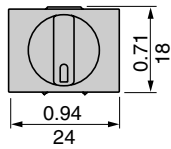
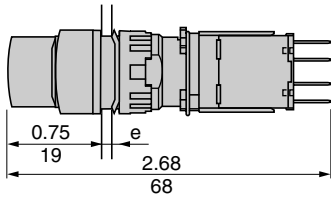

Square Head XB6CD***

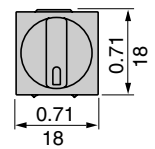
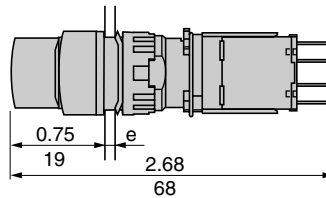

Circular Head XB6AD***

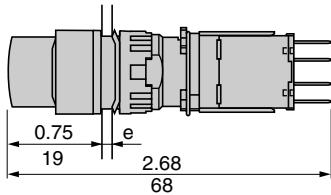

e: panel thickness $\frac{0.04 \text{ to } 0.24 \text{ in}}{1 \text{ to } 6 \text{ mm}}$

Selector Switches - Key Operated Rectangular Head XB6DG***

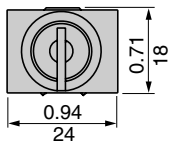
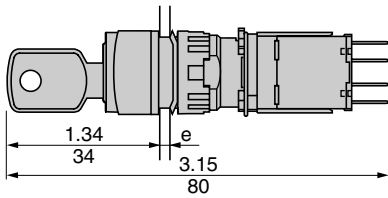

Square Head XB6CG***

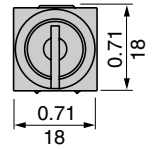
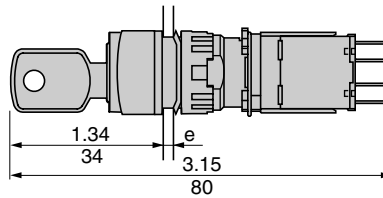

Circular Head XB6AG***

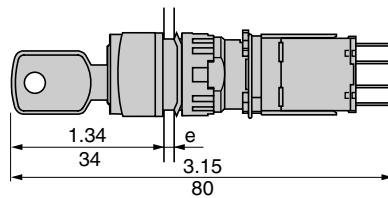

Dual Dimensions $\frac{\text{inches}}{\text{mm}}$

Panel Cut-out Rectangular Head Units

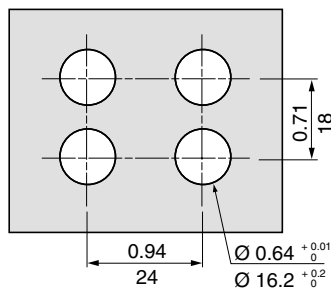

Square and Circular Head Units

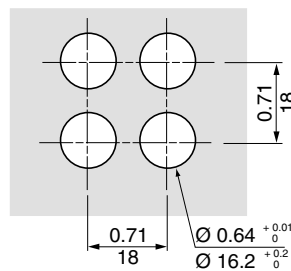

Dual Dimensions $\frac{\text{inches}}{\text{mm}}$

Push Buttons and Operator Interface - XB6 16 mm Dimensions

Push Buttons Body/Contact Assemblies for Illuminated Units ZB6Z••B

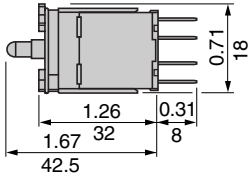

Heads for Illuminated and Non-Illuminated Units Rectangular ZB6DW••, DF•, DA•

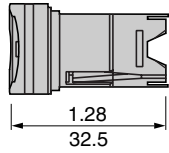

ZB6DE•

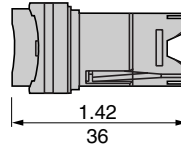

Common Face View

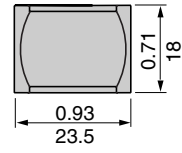

Body/Contact Assemblies for Non-Illuminated Units ZB6Z••B

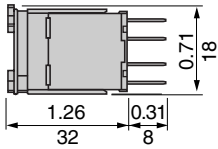

Square ZB6CW••, CF•, CA•

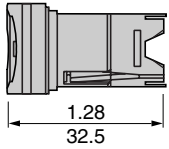

ZB6CE•

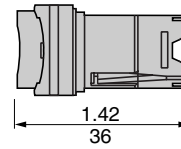

Common Face View

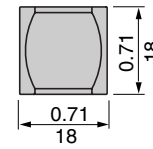

Circular ZB6AW••, AF•, AA•

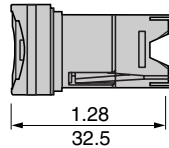

ZB6AE•

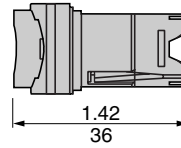

Common Face View

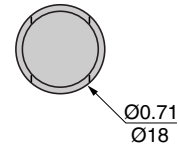

Dual Dimensions $\frac{\text{inches}}{\text{mm}}$

Pilot Lights Bodies ZB6EB••

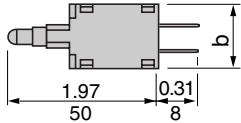

Rectangular Head ZB6DV•

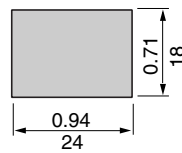
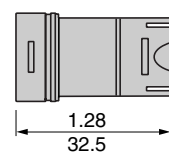

Mushroom Heads Spring Return ZB6AC•

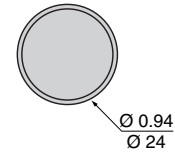
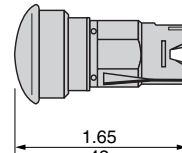

Square Head ZB6CV•

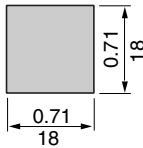
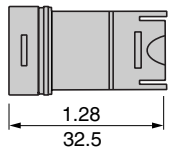

Latching Trigger Action ZB6AS834

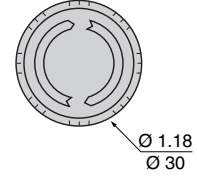
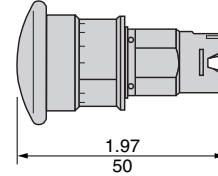

	b	
	in	mm
ZB6EB•B	0.53	13.5
ZB6EB•A	0.61	15.5

Circular Head ZB6AV•

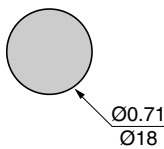
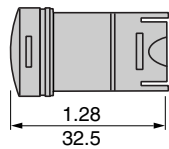

ZB6AS934

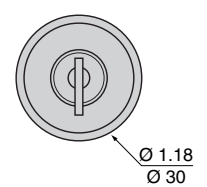
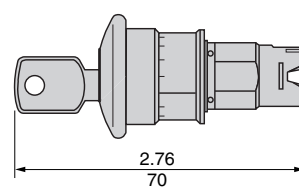

Dual Dimensions $\frac{\text{inches}}{\text{mm}}$

Push Buttons and Operator Interface - XB6 16 mm Dimensions

Selector Switches - Handle Operated Body/Contact Assemblies ZB6Z•B

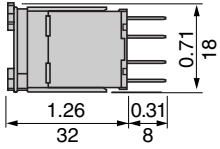

Rectangular Head ZB6DD••

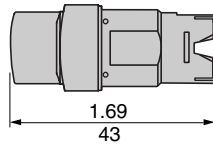

Square Head ZB6CD••

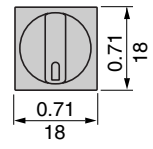
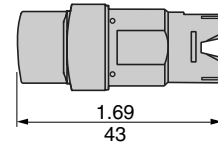
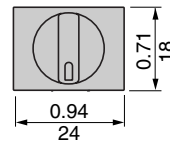

Circular Head ZB6AD••

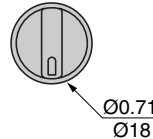
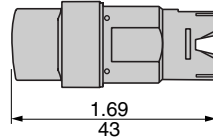

Dual Dimensions $\frac{\text{inches}}{\text{mm}}$

Selector Switches - Key Operated Body/Contact Assemblies ZB6Z•B

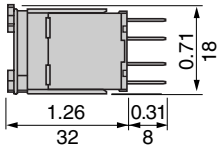

Rectangular Head ZB6DG••

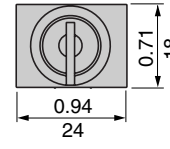
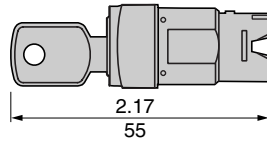

Square Head ZB6CG••

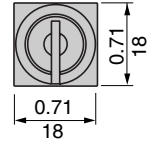
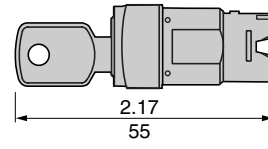

Circular Head ZB6AG••

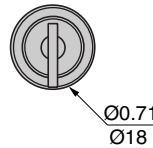
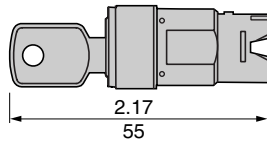

Plug-In Socket Adaptor for Printed Circuit Board Mounting

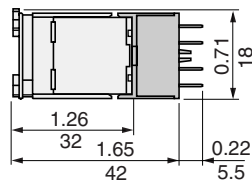

Printed Circuit Board Mounting

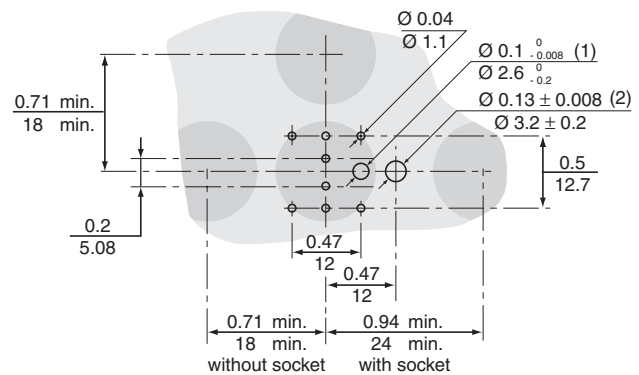

- (1) Locating device.
- (2) This hole can either be drilled on the right or left, depending on the position of the printed circuit board. When mounting several bodies on the same circuit board it is not necessary to screw mount all the bodies.

Dual Dimensions $\frac{\text{inches}}{\text{mm}}$

Push Buttons and Operator Interface - XB6 16 mm Key Sheet - Legend Inserts with Special Markings

Customer			Square D Company	
Company	Order No.	Delivery	Sales Office	Order No.

Part number of legend with special marking	Total number of legends
ZB6XX99 (Per Key Sheet)	

Legend Inserts for Illuminated Push Buttons ZB6Y★W199 (★ = A-Round, C-Square, D-Rectangular)

Rectangular Shape

Specify Text							
Quantity	<input style="width: 30px; height: 15px;" type="text"/>	<input style="width: 30px; height: 15px;" type="text"/>	<input style="width: 30px; height: 15px;" type="text"/>	<input style="width: 30px; height: 15px;" type="text"/>	<input style="width: 30px; height: 15px;" type="text"/>	<input style="width: 30px; height: 15px;" type="text"/>	TOTAL: <input style="width: 30px; height: 15px;" type="text"/>

Square Shape

Specify Text							
Quantity	<input style="width: 30px; height: 15px;" type="text"/>	<input style="width: 30px; height: 15px;" type="text"/>	<input style="width: 30px; height: 15px;" type="text"/>	<input style="width: 30px; height: 15px;" type="text"/>	<input style="width: 30px; height: 15px;" type="text"/>	<input style="width: 30px; height: 15px;" type="text"/>	TOTAL: <input style="width: 30px; height: 15px;" type="text"/>

Circular Shape

Specify Text							
Quantity	<input style="width: 30px; height: 15px;" type="text"/>	<input style="width: 30px; height: 15px;" type="text"/>	<input style="width: 30px; height: 15px;" type="text"/>	<input style="width: 30px; height: 15px;" type="text"/>	<input style="width: 30px; height: 15px;" type="text"/>	<input style="width: 30px; height: 15px;" type="text"/>	TOTAL: <input style="width: 30px; height: 15px;" type="text"/>

Legends for Pilots Lights ZB6Y★V199 (★ = A-Round, C-Square, D-Rectangular)

Rectangular Shape

Specify Text							
Quantity	<input style="width: 30px; height: 15px;" type="text"/>	<input style="width: 30px; height: 15px;" type="text"/>	<input style="width: 30px; height: 15px;" type="text"/>	<input style="width: 30px; height: 15px;" type="text"/>	<input style="width: 30px; height: 15px;" type="text"/>	<input style="width: 30px; height: 15px;" type="text"/>	TOTAL: <input style="width: 30px; height: 15px;" type="text"/>

Square Shape

Specify Text							
Quantity	<input style="width: 30px; height: 15px;" type="text"/>	<input style="width: 30px; height: 15px;" type="text"/>	<input style="width: 30px; height: 15px;" type="text"/>	<input style="width: 30px; height: 15px;" type="text"/>	<input style="width: 30px; height: 15px;" type="text"/>	<input style="width: 30px; height: 15px;" type="text"/>	TOTAL: <input style="width: 30px; height: 15px;" type="text"/>

Circular Shape

Specify Text							
Quantity	<input style="width: 30px; height: 15px;" type="text"/>	<input style="width: 30px; height: 15px;" type="text"/>	<input style="width: 30px; height: 15px;" type="text"/>	<input style="width: 30px; height: 15px;" type="text"/>	<input style="width: 30px; height: 15px;" type="text"/>	<input style="width: 30px; height: 15px;" type="text"/>	TOTAL: <input style="width: 30px; height: 15px;" type="text"/>

Push Buttons and Operator Interface - XB6 16 mm

Key Sheet – Push Button Caps with Special Markings







Customer			Square D Company	
Company	Order No.	Delivery	Sales Office	Order No.

Part number of cap with special marking	Total number of caps
ZB6YXX99 (Per Key Sheet)	







Push Button Caps

Specify Color: 1 – White 2 – Black 3 – Green 4 – Red 5 – Yellow 6 – Blue







Rectangular Shape

Specify Text							
Quantity	<input type="text"/>	<input type="text"/>	<input type="text"/>	<input type="text"/>	<input type="text"/>	<input type="text"/>	TOTAL: <input type="text"/>
Color	<input type="text"/>	<input type="text"/>	<input type="text"/>	<input type="text"/>	<input type="text"/>	<input type="text"/>	

Square Shape

Specify Text							
Quantity	<input type="text"/>	<input type="text"/>	<input type="text"/>	<input type="text"/>	<input type="text"/>	<input type="text"/>	TOTAL: <input type="text"/>
Color	<input type="text"/>	<input type="text"/>	<input type="text"/>	<input type="text"/>	<input type="text"/>	<input type="text"/>	

Circular Shape

Specify Text							
Quantity	<input type="text"/>	<input type="text"/>	<input type="text"/>	<input type="text"/>	<input type="text"/>	<input type="text"/>	TOTAL: <input type="text"/>
Color	<input type="text"/>	<input type="text"/>	<input type="text"/>	<input type="text"/>	<input type="text"/>	<input type="text"/>	

Push Buttons and Operator Interface Specifier's Guide

Type J, O, and XVL – Pilot Lights

File 9001

Catalog
2005



CONTENTS

Description	Page
Type J, Description and Selection	32
Type J, Dimensions and Accessories	33
Type O, Description and Selection	34
Type XVL, Specifications	35
Type XVL, Selection and Accessories	36
Declaration of Conformity	222

Merlin Gerin
Square D
Telemecanique

Schneider
Electric
Building a New Electric World

Push Buttons and Operator Interface Specifiers Guide

Type J Pilot Lights - Description and Selection

Pilot Lights, Push-To-Test and Remote Test Pilot Lights



JP1R29

Class 9001 Type J compact pilot lights are designed to be mounted in a 0.69" (11/16") diameter mounting hole. Each terminal will accept up to two #14 AWG wires (CU only). Type J compact pilot lights meet NEMA Type 4 (watertight) and NEMA Type 13 (oiltight) requirements. Type JT push-to-test pilot lights have contacts built into the encapsulated body. Type JTR remote test pilot lights have dual inputs for one push remote testing – all you need is a push button with a current rating equal to or greater than the total lamp draw. Type JTR remote test pilot lights can also be energized from two separate input signals of the same voltage and polarity. This is done by wiring the "test" terminal to the second input signal.



JTR1R29

Standard Pilot Light

Style/Voltage	Color Cap				Lamp Volt/Amp	Replacement Lamp
	None	Red●	Green●	Yellow●		
Trans/110-120Vac, 50-60 Hz	JP1	JP1R29	JP1G29	JP1Y29	6.3 V, 0.15A	2550101020
Incandescent/120 Vac or dc	JP38	JP38R29	JP38G29	JP38Y29	120 V, 0.015A	2550101040
Incandescent/24-28 Vac or dc	JP35	JP35R29	JP35G29	JP35Y29	28 V, 0.040A	2550101024
Other Voltages*	JP*	JP*R29	JP*G29	JP*Y29		
LED – 24-28 Vac	–	JP35LRR29	JP35LGG29	JP35LYY29	28 V, 0.03A	(1)
LED – 24-28 Vdc	–	JP35DRR29	JP35DGG29	JP35DYY29	28 V, 0.03A	(1)
LED – 120Vac	–	JP38LRR29	JP38LGG29	JP38LYY29	28 V, 0.03A	(1)

Push-To-Test Pilot Light

Style/Voltage	Color Cap				Lamp Volt/Amp	Replacement Lamp
	None	Red●	Green●	Yellow●		
Trans/110-120Vac, 50-60 Hz	JT1	JT1R29	JT1G29	JT1Y29	6.3 V, 0.15A	2550101020
Incandescent/120 Vac or dc	JT38	JT38R29	JT38G29	JT38Y29	120 V, 0.15A	2550101040
Incandescent/24-28 Vac or dc	JT35	JT35R29	JT35G29	JT35Y29	28 V, 0.040A	2550101024
Other Voltages*	JT*	JT*R29	JT*G29	JT*Y29		
LED – 24-28 Vac	–	JT35LRR29	JT35LGG29	JT35LYY29	28 V, 0.03A	(1)
LED – 24-28 Vdc	–	JT35DRR29	JT35DGG29	JT35DYY29	28 V, 0.03A	(1)
LED – 120 Vac	–	JT38LRR29	JT38LGG29	JT38LYY29	28 V, 0.03A	(1)

Remote Test Pilot Light

Style/Voltage	Color Cap				Lamp Volt/Amp	Replacement Lamp
	None	Red●	Green●	Yellow●		
Trans/110-120 Vac, 50-60 Hz	JTR1	JTR1R29	JTR1G29	JTR1Y29	6.3 V, 0.15A	2550101020
Incandescent/120 Vac	JTR38	JTR38R29	JTR38G29	JTR38Y29	120 V, 0.015A	2550101040
Incandescent/24-28 Vac	JTR35	JTR35R29	JTR35G29	JTR35Y29	28 V, 0.040A	2550101024
Other Voltages (ac Only)*	JTR*	JTR*R29	JTR*G29	JTR*Y29		
LED – 24-28 Vac	–	JTR35LRR29	JTR35LGG29	JTR35LYY29	28 V, 0.03A	(1)

(1) See Page 148 for replacement LED lamps. For other voltage LED lamps contact local field office.

- Supplied with "plastic" color caps. If "glass" color caps are desired, substitute G26, R26, etc., for G29, R29, etc. Example: JP1G26, JP1R26, etc. To order a pilot light with color cap not listed above, add the color cap type number from the table below to the basic pilot light number. Example: For a standard 120 volt transformer style pilot light with a plastic amber color cap, order a 9001JP1A29. **LED lamps are only for use with plastic red, green or yellow color caps.**

* Remote test (Type JTR) only is available in AC.

Other Voltages*						
Voltage	JP/JT Code	Replacement Lamp	Volt/Amp	JTR Code	Replacement Lamp	Volt/Amp
Incandescent/6 Vac or dc	31	2550101020	6.3 V, 0.15A	31	2550101003	3 V, 0.16A
Incandescent/12 Vac or dc	32	2550101022	12 V, 0.17A	32	2550101022	12 V, 0.17A
Incandescent/48 Vac or dc	36	2550101025	48 V, 0.053A	36	2550101025	48 V, 0.053A
Incandescent/60 Vac or dc	37	2550101026	60 V, 0.05A	37	2550101026	60 V, 0.05A

Push Buttons and Operator Interface Specifiers Guide

Type J Pilot Lights - Dimensions and Accessories

Legend Plates

Type		Max. No. of Lines	Max. No. of Characters	Catalog Number
Blank	Black Field	2	8	JN100
	Red Field	2	8	JN100R
Special Marking (Specify Marking)	Black Field	2	8	JN199
	Red Field	2	8	JN199R
Blank	Aluminum Field	2	16	JN700
Special Marking (Specify Marking)	Aluminum Field	2	16	JN799

Replacement Color Caps - Class 9001, Type J

Color	Catalog Number	
	Plastic	Glass
Red	R29	R26
Green	G29	G26
Amber	A29	A26
Blue	L29	L26
Clear	C29	C26
White	W29	W26
Yellow	Y29	Y26

Replacement Parts - Class 9001, Type J

Type	Catalog Number
Ring Nut	6512909601
Locking Thrust Washer	6512909201
Trim Washer	6512909301
Rubber Sealing Washer	6512901801

NOTE: Octagonal ringnuts can be tightened with standard tools, or use the reverse end of Square D wrench Class 9001 Type K95.

Type J Dimensions

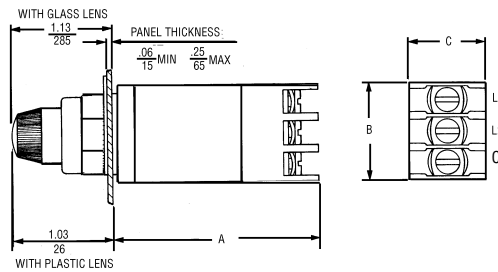

Type	A	B	C
JTR1	2.83"	1.20"	0.93"
JP, JT, JTR31 through JTR38	2.34"	1.11"	0.84"

Push Buttons and Operator Interface Specifiers Guide

Type O Pilot Lights - Description and Selection

Instrument Type Incandescent Pilot Lights – Class 9001, Type O NEMA 13



Type O

Voltage AC/DC	Average Current (Amps)	Color	Catalog Number
12 V	0.170	Red	OR12
		Green	OG12
		Amber	OA12
		Clear	OC12
		Yellow	OY12
		White	OW12
		Blue (Fluted)	FB12
24 V	0.073	Red	OR24
		Green	OG24
		Amber	OA24
		Clear	OC24
		Yellow	OY24
		White	OW24
		Blue (Fluted)	FB24
120 V	0.025	Red	OR120
		Green	OG120
		Amber	OA120
		Clear	OC120
		Yellow	OY120
		White	OW120
		Blue (Fluted)	FB120

Replacement Lamps - Class 9001, Type O

Voltage	Sylvania Lamp Number	Square D Catalog Number
12 V	12PSB	2550105003
24 V	24PSB	2550105004
120 V	120PSB	2550105005

Replacement Lenses* - Class 9001, Type O

Color	Catalog Number
Red	2550420020
Green	2550420040
Amber	2550420060
Clear	2550420010
Yellow	2550420030
White	2550430040
Blue	2550470010

Minimum Order Quantity 10

Approximate Dimensions

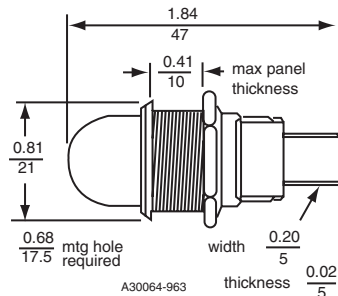

Dual Dimensions $\frac{\text{inches}}{\text{mm}}$

Push Buttons and Operator Interface Specifiers Guide

XVL Miniature LED Pilot Lights - Specifications

General

This new Telemecanique range of LED pilot lights meets the very latest requirements in signalling techniques.

Because of their small size, Ø8 and Ø12 mm fixing pilot lights are particularly suitable for the following applications:

- mounting on small control stations.
- shallow depth mounting.
- large number of signalling units on a control station (low power dissipation).

Small diameter LED pilot lights also have sealed front faces (IP 65 option available). An unsealed Ø8 mm fixing model with protruding LED and black bezel (aesthetic appearance) is also offered.

Advantages:

LED pilot lights have many advantages:

- very long life and so low maintenance costs (bulb test no longer required).
- highly resistant to shocks, vibrations and over-voltage.
- low power consumption which, for example, allows compatibility with programmable controller outputs by parallel connection with the load, to give a direct indication of output state.
- very high reliability.

Quick fixing by means of tags for soldered clips for Ø8 mm type, or threaded connectors Ø12 mm type. Safe connection due to integral ballast resistor and reverse polarity protection device.

Conforming to standards	IEC 60947-5-1, NF C 63-140, VDE 0660-200.
Protective treatment	Standard version: "TC" treatment.
Ambient temperature	Operation: -25 °C to + 70 °C (-13 °F to +158 °F). Storage: -40 °C to + 70 °C (-40 °F to +158 °F).
Electric shock protection	Class III conforming to IEC 60536 and NF C 20-030.
Degree of protection	IP 40 (IP 65 with seal) conforming to IEC 529 and NF C 20-010.
Current consumption	25 mA.
Rated Insulation voltage	50 V conforming to NF C 20-040, VDE 0110.
Life	Can exceed 100,000 hours.
Voltage limits including ripple (==)	0.8 UN ≤ U ≤ 1.2 UN.
Terminal referencing	Polarity marked + – conforming to CENELEC EN 50013.
Cabling	XVLA1●●, XVLA2●●: tags for 2.8 x 0.5 mm quick connectors, also for soldered connections. XVLA3●●: threaded connectors, clamping, capacity: min. 1 - 26 AWG solid or stranded, max. 1 - 16 AWG solid or stranded.

Dimensions

LED pilot lights
Ø8, with black bezel,
visible LED XVL-A1..

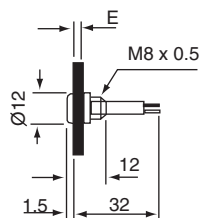

E - mounting plate thickness 1 to 8 mm

Ø 8, with lens incorporated,
protected LED XVL-A2

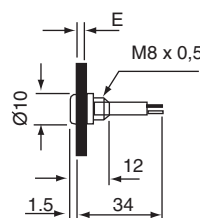

E - mounting plate thickness 1 to 8 mm

Ø 12, with lens incorporated,
protected LED XVL-A3

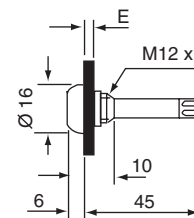

E - mounting plate thickness 1 to 6 mm

All dimensions are in mm. To convert to approximate inches, divide mm by 25.4.



Push Buttons and Operator Interface Specifiers Guide

XVL Miniature LED Pilot Lights - Selection and Accessories

With Black Bezel, Raised LED



XVLA1●●

Description	Supply Voltage DC	Color	Catalog Number
Ø8 mm with integral ballast resistor and reverse polarity protection diode Degree of protection IP 40	5 V	Green	XVLA113
		Red	XVLA114
		Orange-yellow	XVLA115
	12 V	Green	XVLA123
		Red	XVLA124
		Orange-yellow	XVLA125
	24 V	Green	XVLA133
		Red	XVLA134
		Orange-yellow	XVLA135
	48 V	Green	XVLA143
		Red	XVLA144
		Orange-yellow	XVLA145

With Integral Lens Cap, Covered LED



XVLA2●●

Description	Supply Voltage DC	Color	Catalog Number
Ø8 mm ⁽¹⁾ with integral ballast resistor and reverse polarity protection diode Degree of protection IP 40	5 V	Green	XVLA213
		Red	XVLA214
		Orange-yellow	XVLA215
	12 V	Green	XVLA223
		Red	XVLA224
		Orange-yellow	XVLA225
	24 V	Green	XVLA233
		Red	XVLA234
		Orange-yellow	XVLA235
	48 V	Green	XVLA243
		Red	XVLA244
		Orange-yellow	XVLA245



XVLA3●●

Ø12 mm ⁽²⁾ with integral ballast resistor and reverse polarity protection diode Degree of protection IP 40	5 V	Green	XVLA313
		Red	XVLA314
		Orange-yellow	XVLA315
	12 V	Green	XVLA323
		Red	XVLA324
		Orange-yellow	XVLA325
	24 V	Green	XVLA333
		Red	XVLA334
		Orange-yellow	XVLA335
	48 V	Green	XVLA343
		Red	XVLA344
		Orange-yellow	XVLA345

Accessories

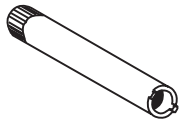

XVLX●●

Description		Catalog Number
Tightening tools (Sold singly)	For Ø8 mm pilot lights	XVLX08
	For Ø12 mm pilot lights	XVLX12
Seals (IP 65) (Sold in lots of 10)	For Ø8 mm pilot lights	XVLZ911
	For Ø12 mm pilot lights	XVLZ912



XVLZ91●

1 Quick Connects (2.8 mm x 0.5 mm)
2 Screw Termination

Push Buttons and Operator Interface Specifier's Guide

XB4 22 mm Die Cast Chrome Plated

Catalog
2005

File 9001



CONTENTS

Description	Page
General Characteristics	38
Complete Devices	42
Non-Illuminated Operators	46
Two Button Operators	48
Emergency Stop Operators and Yellow Contrast Plates	49
Selector Switches	50
Contact Blocks	51
Specialty Operators	52
Pilot Lights and Light Modules	53
Illuminated Operators	54
Illuminated Selector Switches	56
Light Module Assemblies	57
Light Module Assemblies, Contact Blocks, Plug-In Connector Type	59
Printed Circuit Board (PCB) Components	60
Legend Plates	62
Push Button Caps	65
Accessories and Replacement Parts	66
Dimensions	68
Declaration of Conformity	221



Telemecanique

Push Buttons & Operator Interface - XB4 22 mm Die Cast Chrome Plated

General Characteristics

Components for User Assembly ZB4B:

- 1 - Electrical Bodies (pre-assembled)
- 2 - Operator Heads (pre-assembled)

Component Parts and Accessories ZB:



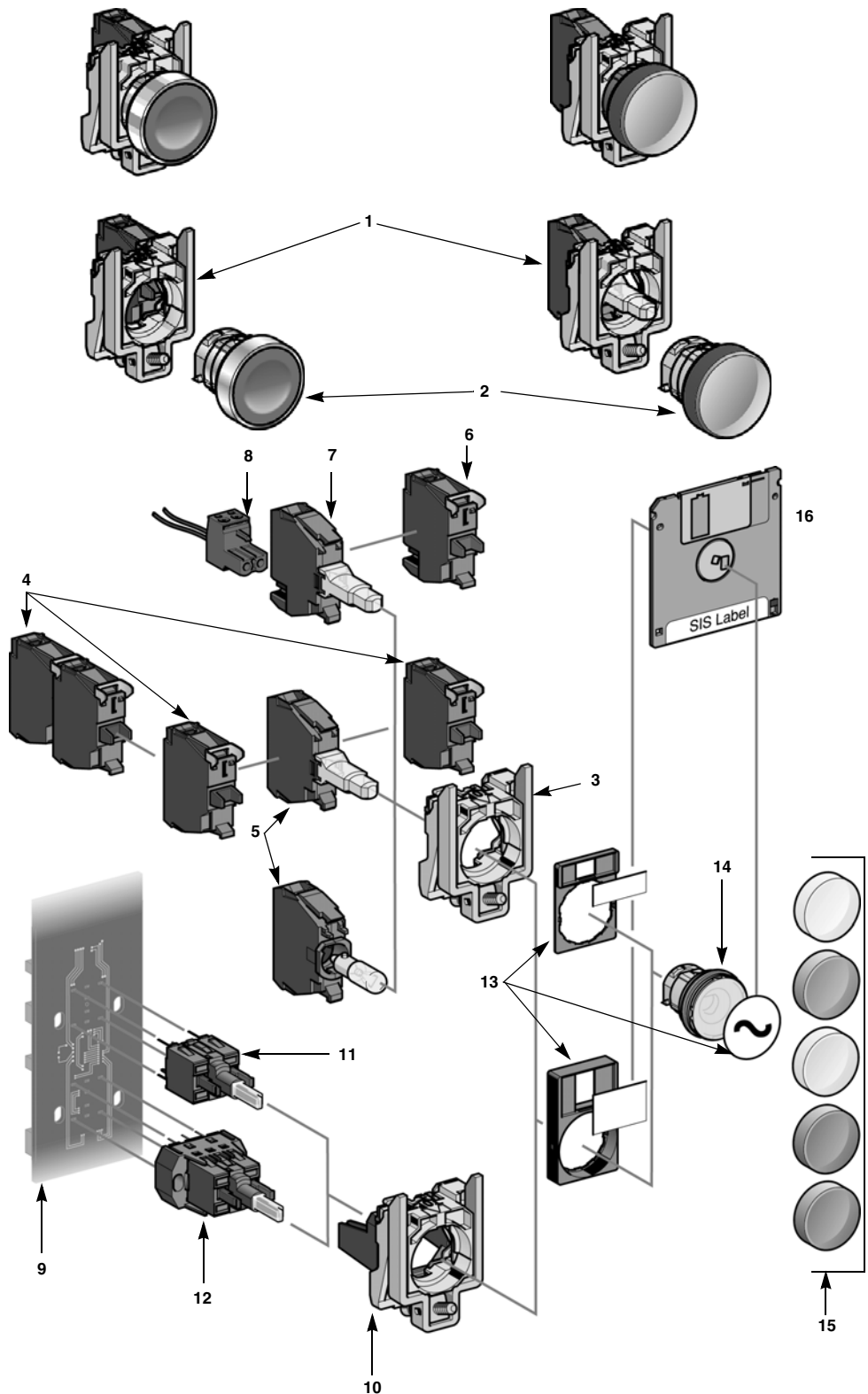

- 3 - Mounting Collar – Standard (ZB4BZ009)
- 4 - Contact Blocks – Screw Clamp Terminal (ZBE10•, ZBE20•)
- 5 - Light Modules – Screw Clamp Terminal (ZBV•) for Protected LED and Ba9 Base Lamps
- 6 - Contact Blocks – Plug-in Connector (ZBE10•)
- 7 - Light Modules – Plug-in Connector (ZBV•) for Protected LED only
- 8 - 2 Pin Connector and Cables for Plug-in Connection Electrical Components (APE1•)
- 9 - Printed Circuit Board (PCB) Application (Typical)
- 10 - Mounting Collar – PCB Application (ZB4BZ009 + ZB4BZ079)
- 11 - Contact Blocks – PCB Application (ZBE70•, ZBE70•6)
- 12 - Light Modules – PCB Application (ZBV•7) for Protected LED only
- 13 - Legend Plates and Holders (ZBY•, ZBZ•)
- 14 - Operator Head (Illuminated or Non-Illuminated)
- 15 - Lenses for Pilot Lights (ZBV•) or Lenses for Illuminated Push Buttons (ZBW•)
- 16 - Labeling Software



Push Buttons & Operator Interface - XB4 22 mm Die Cast Chrome Plated

General Characteristics

Environment

Protective treatment standard version		"TH"
Ambient air temperature around the device	Storage	-40 to +158 °F (- 40 to +70 °C)
	Operation	-13 to +158 °F (- 25 to +70 °C) unless otherwise stated
Electric shock protection	Conforming to IEC 60536	Class I
Degree of protection	Conforming to IEC 60529	IP 65, unless otherwise stated IP 66, for booted push button heads
	Conforming to UL 50 and CSA C22.2 No. 94	Type 1, 2, 3, 4, 4X, 12, and 13, unless otherwise stated
Resistance to high pressure cleaner		1,015 psi (70 x 105 Pa-70 bars); distance: 3.94 in (0.1 m) Temperature: 131 °F (55 °C)
Mechanical shock protection	Conforming to EN 50102	Non illuminated heads: IK 03
		Illuminated heads: IK 05
Conforming to standards		IEC 60947-1, IEC/EN 60947-5-1, IEC 60947-5-4, EN 60947-1, JIS C 4520, UL 508, CSA C22.2 No. 14
Product certifications	UL Listed, CSA Certified	Standard single contacts with screw clamp terminals: A600; Q600 Double contacts with screw clamp terminals: A600; Q600
	 File E164353 CCN NKCR  File LR 44087 Class 3211 03  File E164353 CCN NKCR 2	Contacts with "Quick-Connect": A300; Q300 Light modules with screw clamp terminals JOYSTICK XD4-PA: A600; R300
	UL Recognized, CSA Certified	Standard single contacts for plug-in connector: A300; R300 Standard single contact for printed circuit board: B300; R300
	BV, RINA, LROS, DNV, GL (pending)	Standard single contacts and double contacts with screw clamp terminals
Terminal identification	Conforming to EN 50005 and EN 50013	

Characteristics of Operators and Contact Blocks

Mechanical Characteristics

Contact operation	N/C or N/O	Slow break	
Positive operation	Conforming to IEC/EN 60947-5-1 Appendix K	All functions incorporating a N/C contact are positive opening operation	
Operating travel (to change electrical state)	Push button	Changing N/C state: 0.06 in (1.5 mm) Changing N/O state: 0.11 in (2.6 mm) Total travel: 0.17 in (4.3 mm)	
Operating force	Push button	Changing N/C state: 0.79 lbf (3.5 N) Changing N/O state: 0.85 lbf (3.8 N)	
	Additional contact (extra to change state)	Single N/C contact: 0.45 lbf (2 N) Single N/O contact: 0.52 lbf (2.3 N) Double contact N/C: 0.76 lbf (3.4 N) Double contact N/O: 1.12 lbf (5 N) Double contact N/C + N/O: 1.03 lbf (4.6 N)	
	Emergency stop with N/C + N/O Maintained mushroom head operators Momentary mushroom head operators	Standard push-pull: 10.12 lbf (45 N) Trigger action push-pull: 11.24 lbf (50 N) Standard turn to release and key release: 8.99 lbf (40 N) Trigger action turn to release and key release: 9.89 lbf (44 N)	
Operating torque (to change electrical state)	Selector switches	N/O contact: 1.24 lb-in (0.14 N•m)	
	Additional contact (extra)	N/O contact: 0.44 lb-in (0.05 N•m)	
Mechanical durability (operating cycles)	Push button	Momentary	5 million
		Double-headed	1 million
		Push-push to release	500,000
	Selector switches	Non-illuminated	3 million
		Illuminated	1 million
	Toggle switches		500,000
	Emergency stop push button		300,000
	Joystick		1 million
	Standard blocks		5 million
Low power switching power blocks		500,000	
Vibration resistance	Conforming to IEC 60068-2-6	Frequency (2 to 500 Hz): 5 gn	
Shock resistance	Conforming to IEC 60068-2-27	All functions except mushroom head push buttons– Half sine wave acceleration 11 ms: 50 gn Half sine wave acceleration 18 ms: 30 gn	
		Mushroom head push buttons– Half sine wave acceleration 11 ms: 10 gn	

Push Buttons & Operator Interface - XB4 22 mm Die Cast Chrome Plated

General Characteristics

Electrical Characteristics							
Cabling capacity	Conforming to IEC 60947-1	Screw and captive clamp terminals Min: 1 x 24 AWG (0.22 mm ²) without cable end 1 x 22 AWG (0.34 mm ²) for linking Max: 2 x 16 AWG (1.5 mm ²) with cable end 2 x 14 AWG without cable end Cross headed screw (Pozidrive type 1) slotted for flat 4 and 5.5 mm screwdriver Typical torque: 0.8 N•m (8.55 lb-in) Maximum torque: 1.2 N•m (10.7 lb-in)					
Contact material	Silver alloy (Ag/Ni)	Standard single and double blocks with screw clamp terminals Blocks for plug-in connector Standard blocks for printed circuit board connection					
	Gold flashed (Ag/Ni/Au)	Low power switching contact blocks with screw clamp terminals Low power switching contact blocks for printed circuit board connection					
Short-circuit protection	Conforming to IEC/EN 60947-5-1	Standard blocks with screw clamp terminals: 10 A (gG cartridge fuse conforming to IEC 60269-1) Blocks for plug-in connector: 4 A (gG fuse cartridge conforming to IEC 60269-1) Standard blocks for printed circuit board connection: 4 A (gG cartridge fuse conforming to IEC 60269-1)					
Rated insulation voltage	Conforming to IEC 60947-1	Standard blocks (single or double) with screw clamp terminals: Ui = 600 V, degree of pollution 3 Blocks for plug-in connector: Ui = 250 V, degree of pollution 3 Standard blocks for printed circuit board connection: Ui = 250 V, degree of pollution 3					
Rated impulse withstand voltage	Conforming to IEC 60947-1	Standard block (single or double) with screw clamp terminals: Uimp = 6 kV Blocks for plug-in connector: Uimp = 4 kV Standard blocks for printed circuit board connection: Uimp = 4 kV					
Rated operational characteristics Conforming to IEC/EN 60947-5-1	AC supply: Utilization category AC-15	Standard blocks (single or double) with screw clamp terminals: A600: Ue = 600 Vac and Ie = 1.2 A or Ue = 240 Vac and Ie = 3 A or Ue = 120 Vac and Ie = 6 A Continuous Thermal Current = 10 A Blocks for plug-in connector: A300: Ue = 120 Vac and Ie = 6 A or Ue = 240 Vac and Ie = 3 A Standard blocks for printed circuit board connection: B300: Ue = 120 Vac and Ie = 3 A or Ue = 240 Vac and Ie = 1.5 A					
	DC supply: Utilization category DC-13	Standard single or double blocks with screw clamp terminals: Q600: Ue = 600 Vdc and Ie = 0.1 A or Ue = 250 Vdc and Ie = 0.27 A or Ue = 125 Vdc and Ie = 0.55 A Continuous Thermal Current = 2.5 A Joystick XD4-PA: R300: Ue = 125 Vdc and Ie = 0.22 A or Ue = 250 Vdc and Ie = 0.1 A Blocks for plug-in connector: R300: Ue = 125 Vdc and Ie = 0.22 A or Ue = 250 Vdc and Ie = 0.1 A Standard blocks for printed circuit board connection: R300: Ue = 125 Vdc and Ie = 0.22 A or Ue = 250 Vdc and Ie = 0.1 A					
Rated operational characteristics	AC supply: Resistive load	Low power switching contact blocks with screw clamp terminals or for printed circuit board connection: Max: 24 V Max: 0.1 A					
Electrical durability Conforming to IEC/EN 60947-5-1 Appendix C Operating rate 3600 operating cycles/hour. Load factor: 0.5	AC supply for 1 million operating cycles, utilization category AC-15	Standard blocks for screw clamp terminals:					
		<table border="1"> <tr> <td>24 Vac</td> <td>120 Vac</td> <td>230 Vac</td> </tr> <tr> <td>4 A</td> <td>3 A</td> <td>2 A</td> </tr> </table>	24 Vac	120 Vac	230 Vac	4 A	3 A
	24 Vac	120 Vac	230 Vac				
	4 A	3 A	2 A				
DC supply for 1 million operating cycles, utilization category DC-13	Standard double blocks with screw clamp terminal or plug-in connector:						
	<table border="1"> <tr> <td>24 Vac</td> <td>120 Vac</td> <td>230 Vac</td> </tr> <tr> <td>3 A</td> <td>1.5 A</td> <td>1 A</td> </tr> </table>	24 Vac	120 Vac	230 Vac	3 A	1.5 A	1 A
24 Vac	120 Vac	230 Vac					
3 A	1.5 A	1 A					
Standard single blocks for screw clamp terminals:							
<table border="1"> <tr> <td>24 Vdc</td> <td>110 Vdc</td> </tr> <tr> <td>0.5 A</td> <td>0.2 A</td> </tr> </table>	24 Vdc	110 Vdc	0.5 A	0.2 A			
24 Vdc	110 Vdc						
0.5 A	0.2 A						
Standard double blocks with screw clamp terminal or plug-in connector:							
<table border="1"> <tr> <td>24 Vdc</td> <td>110 Vdc</td> </tr> <tr> <td>0.4 A</td> <td>0.15 A</td> </tr> </table>	24 Vdc	110 Vdc	0.4 A	0.15 A			
24 Vdc	110 Vdc						
0.4 A	0.15 A						
Electrical reliability	Failure rate Conforming to IEC 60947-5-4						
	- In clean environment	Standard blocks: - at 17 V and 5 mA, $\lambda < 10^{-8}$ - at 5 V and 1 mA, $\lambda < 10^{-6}$ Low power switching contact blocks: - at 5 V and 1 mA, $\lambda < 10^{-8}$					
	- In dusty environment	Low power switching contact blocks only: at 5 V and 1 mA, $\lambda < 10^{-6}$					

Push Buttons & Operator Interface - XB4 22 mm Die Cast Chrome Plated

General Characteristics

Characteristics of Light Modules

Mechanical Characteristics		
Vibration resistance	Conforming to IEC 60068-2-6	Frequency (12 to 500 Hz): 5 gn
Shock resistance	Conforming to IEC 60068-2-27	Half sine wave acceleration 11 ms: 50 gn Half sine wave acceleration 18 ms: 30 gn
Electrical Characteristics		
Cabling capacity	Conforming to IEC 60947-1	Screw and captive clamp terminals Min: 1 x 24 AWG (0.22 mm ²) without cable end 1 x 22 AWG (0.34 mm ²) for linking Max: 2 x 16 AWG (1.5 mm ²) with cable end
Rated insulation voltage	Conforming to IEC 60947-1	Direct supply pilot light modules (BA 9s bulbs): U _i = 250 V, degree of pollution 3 Pilot light modules with protected LED: U _i = 250 V, degree of pollution 3 Pilot light modules with transformer: U _i = 600 V, degree of pollution 3
Rated impulse withstand voltage	Conforming to IEC 60947-1	Direct supply pilot light modules (BA 9s bulbs): U _{imp} = 4 kV Pilot light modules with protected LED: U _{imp} = 4 kV Pilot light modules with transformer: U _{imp} = 6 kV

Specific Characteristics of Protected LED Light Modules Only

Voltage limits	Nominal voltage	24 V: 19.2 to 30 Vdc; 21.6 to 24.6 Vac 120 V: 102 to 132 Vac 240 V: 195 to 264 Vac
Current consumption	Applicable to all colors	24 Vac/Vdc supply blocks: 18 mA 120 Vac supply blocks: 14 mA 240 Vac supply blocks: 14 mA
Service life	At nominal voltage and at an ambient temperature of 77 °F (25 °C)	100,000 hours
Surge withstand	Conforming to IEC 61000-4-5	2/1 kV
Resistance to fast transients	Conforming to IEC 61000-4-4	2 kV
Resistance to electromagnetic fields	Conforming to IEC 61000-4-3	10 V/m
Resistance to electrostatic discharges	Conforming to IEC 61000-4-2	8/6 kV
Electromagnetic emission	Conforming to EN 55011	Class B

Push Buttons & Operator Interface - XB4 22 mm Die Cast Chrome Plated Complete Devices



XB4BA31



XB4BA4322



XB4BP51



XB4BL42



XB4BC21

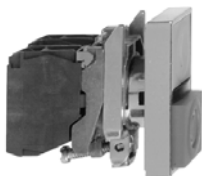

XB4BL845

Non-Illuminated Push Buttons, Momentary (screw clamp terminal connections)

Shape of Head	Type of Push	Type of Contact		Marking	Color of Cap	Catalog Number
		N/O	N/C			
	Flush	1	-	-	Black	XB4BA21 (ZB4BZ101 + ZB4BA2)
					Green	XB4BA31 (ZB4BZ101 + ZB4BA3)
					Yellow	XB4BA51 (ZB4BZ101 + ZB4BA5)
					Blue	XB4BA61 (ZB4BZ101 + ZB4BA6)
		-	1	-	Red	XB4BA42 (ZB4BZ102 + ZB4BA4)
	Flush	1	-	"I" (white)	Green	XB4BA3311 (ZB4BZ101 + ZB4BA331)
	Flush	-	1	"O" (white)	Red	XB4BA4322 (ZB4BZ102 + ZB4BA432)
	Flush with clear silicone boot (color of pusher unobscured)	1	-	-	Black	XB4BP21 (ZB4BZ101 + ZB4BP2)
					Green	XB4BP31 (ZB4BZ101 + ZB4BP3)
					Yellow	XB4BP51 (ZB4BZ101 + ZB4BP5)
					Blue	XB4BP61 (ZB4BZ101 + ZB4BP6)
		-	1	-	Red	XB4BP42 (ZB4BZ102 + ZB4BP4)
	Extended	-	1	-	Red	XB4BL42 (ZB4BZ102 + ZB4BL4)
	Mushroom head Ø 40 mm	1	-	-	Black	XB4BC21 (ZB4BZ101 + ZB4BC2)

Two Button Push Buttons, Momentary (screw clamp terminal connections)

Shape of Head	Type of Push	Type of Contact		Degree of Protection	Catalog Number
		N/O	N/C		
	One flush green push (marked "I") One extended red push (marked "O")	1	1	IP 40	XB4BL845 (ZB4BZ105 + ZB4BL8434)

Push Buttons & Operator Interface - XB4 22 mm Die Cast Chrome Plated Complete Devices



XB4BT845

Non-Illuminated Emergency Stop Mushroom Head Push Buttons, Ø 40 mm (Red) (screw clamp terminal connections)

Shape of Head	Type of Push	Type of Contact		Catalog Number
		N/O	N/C	
	Trigger action push-pull	1	1	XB4BT845 (ZB4BZ105 + ZB4BT84)
	Trigger action turn to release	1	1	XB4BS8445 (ZB4BZ105 + ZB4BS844)
	Trigger action Key release (No. 455)	1	1	XB4BS9445 (ZB4BZ105 + ZB4BS944)
	Push-pull	-	1	XB4BT42 (ZB4BZ102 + ZB4BT4)
	Turn to release	-	1	XB4BS542 (ZB4BZ102 + ZB4BS54)
	Key release (No. 455)	-	1	XB4BS142 (ZB4BZ102 + ZB4BS14)



XB4BS9445



XB4BS542

Non-Illuminated Selector Switches and Key Switches (screw clamp terminal connections)

Shape of Head	Type of Operator	Type of Contact		Number and Type of Positions	Catalog Number
		N/O	N/C		
	Standard lever, black	1	-	2 - maintained	XB4BD21 (ZB4BZ101 + ZB4BD2)
		1	1	2 - maintained	XB4BD25 (ZB4BZ105 + ZB4BD2)
		2	-	3 - maintained	XB4BD33 (ZB4BZ103 + ZB4BD3)
				3 - momentary to center	XB4BD53 (ZB4BZ103 + ZB4BD5)
	Extended lever, black	1	-	2 - maintained	XB4BJ21 (ZB4BZ101 + ZB4BJ2)
		2	-	3 - maintained	XB4BJ33 (ZB4BZ103 + ZB4BJ3)
				3 - momentary to center	XB4BJ53 (ZB4BZ103 + ZB4BJ5)
			Key (No. 455)	1	-
XB4BG41 (ZB4BZ101 + ZB4BG4)					
2 - momentary to left	XB4BG61 (ZB4BZ101 + ZB4BG6)				
2	-			3 - maintained	XB4BG03 (ZB4BZ103 + ZB4BG0)
				XB4BG33 (ZB4BZ103 + ZB4BG3)	

The symbol indicates key withdrawal position(s).

Push Buttons & Operator Interface - XB4 22 mm Die Cast Chrome Plated Complete Devices

Pilot Lights with Protected LED (screw clamp terminal connections)





XB4BV85

Shape of Head	Supply Voltage	Color	Catalog Number
	24 Vac/Vdc	White	XB4BVB1 (ZB4BVB1 + ZB4BV013)
		Green	XB4BVB3 (ZB4BVB3 + ZB4BV033)
		Red	XB4BVB4 (ZB4BVB4 + ZB4BV043)
		Yellow	XB4BVB5 (ZB4BVB5 + ZB4BV053)
		Blue	XB4BVB6 (ZB4BVB6 + ZB4BV063)
	110-120 Vac	White	XB4BVG1 (ZB4BVG1 + ZB4BV013)
		Green	XB4BVG3 (ZB4BVG3 + ZB4BV033)
		Red	XB4BVG4 (ZB4BVG4 + ZB4BV043)
		Yellow	XB4BVG5 (ZB4BVG5 + ZB4BV053)
		Blue	XB4BVG6 (ZB4BVG6 + ZB4BV063)

Pilot lights for BA 9s Bulb (screw clamp terminal connections)



XB4BV64



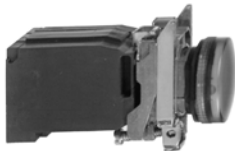

Shape of Head	Supply Voltage	Color	Catalog Number
Direct supply, for BA 9s (incandescent, LED, neon) V ≤ 250 V, 2.4 W bulb (bulb not included)			
	≤ 250 Vac/Vdc	White	XB4BV61 (ZB4BV6 + ZB4BV01)
		Green	XB4BV63 (ZB4BV6 + ZB4BV03)
		Red	XB4BV64 (ZB4BV6 + ZB4BV04)
		Yellow	XB4BV65 (ZB4BV6 + ZB4BV05)
		Transformer type with 1.2 VA, 6 V secondary. BA 9s incandescent bulb included	
	110-120 Vac 50/60 Hz	White	XB4BV31 (ZB4BV3 + ZB4BV01)
		Green	XB4BV33 (ZB4BV3 + ZB4BV03)
		Red	XB4BV34 (ZB4BV3 + ZB4BV04)
		Yellow	XB4BV35 (ZB4BV3 + ZB4BV05)

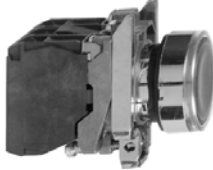

XB4BV33

Push Buttons & Operator Interface - XB4 22 mm Die Cast Chrome Plated Complete Devices

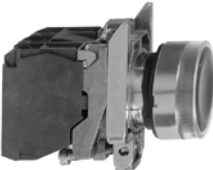
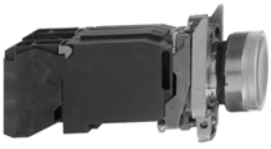
Illuminated Push Buttons, Momentary, Flush

Shape of Head	Description	Type of Contact		Supply Voltage	Color of Push	Catalog Number
		N/O	N/C			
Screw clamp terminal connections						
 XB4BW33B5	 Protected LED	1	1	24 Vac/Vdc	White Green Red Yellow Blue	XB4BW31B5 (ZB4BW0B15 + ZB4BW313) XB4BW33B5 (ZB4BW0B35 + ZB4BW333) XB4BW34B5 (ZB4BW0B45 + ZB4BW343) XB4BW35B5 (ZB4BW0B55 + ZB4BW353) XB4BW36B5 (ZB4BW0B65 + ZB4BW363)
				110-120 Vac	White Green Red Yellow Blue	XB4BW31G5 (ZB4BW0G15 + ZB4BW313) XB4BW33G5 (ZB4BW0G35 + ZB4BW333) XB4BW34G5 (ZB4BW0G45 + ZB4BW343) XB4BW35G5 (ZB4BW0G55 + ZB4BW353) XB4BW36G5 (ZB4BW0G65 + ZB4BW363)
 XB4BW34G5	Direct supply for BA 9s 2.4 W max. bulb Not included	1	1	≤ 250 Vac/Vdc	White Green Red Yellow	XB4BW3165 (ZB4BW065 + ZB4BW31) XB4BW3365 (ZB4BW065 + ZB4BW33) XB4BW3465 (ZB4BW065 + ZB4BW34) XB4BW3565 (ZB4BW065 + ZB4BW35)
				 XB4BW3545	 Transformer type 1.2 VA, 6 V secondary. BA 9s incandescent bulb included	1
230-240 Vac 50/60 Hz	White Green Red Yellow	XB4BW3145 (ZB4BW045 + ZB4BW31) XB4BW3345 (ZB4BW045 + ZB4BW33) XB4BW3445 (ZB4BW045 + ZB4BW34) XB4BW3545 (ZB4BW045 + ZB4BW35)				

Push Buttons & Operator Interface - XB4 22 mm Die Cast Chrome Plated

Non-Illuminated Operators

Non-Illuminated Operators, Momentary - Unmarked



ZB4BA0



ZB4BA4



ZB4BA38



ZB4BP18



ZB4BL1



ZB4BA36

Shape of Head	Type of Push	Color of Cap	Catalog Number
	Flush, without color cap ■	–	ZB4BA0
	Flush, with set of 6 color caps	White Black Green Red Yellow Blue	ZB4BA9
	Flush	White Black Green Red Yellow Blue Grey	ZB4BA1 ZB4BA2 ZB4BA3 ZB4BA4 ZB4BA5 ZB4BA6 ZB4BA8
	Flush with transparent cap, for insertion of legend ▲	White Green Red Yellow Blue	ZB4BA18 ZB4BA38 ZB4BA48 ZB4BA58 ZB4BA68
	Booted (clear) Color of cap unobscured	White Black Green Red Yellow Blue	ZB4BP1 ZB4BP2 ZB4BP3 ZB4BP4 ZB4BP5 ZB4BP6
	Booted (clear) for insertion of legend ▲ Color of cap unobscured	White Green Red Yellow Blue	ZB4BP18 ZB4BP38 ZB4BP48 ZB4BP58 ZB4BP68
	Extended	White Black Green Red Yellow Blue	ZB4BL1 ZB4BL2 ZB4BL3 ZB4BL4 ZB4BL5 ZB4BL6
	Guarded Head	White Black Green Red Yellow Blue	ZB4BA16 ZB4BA26 ZB4BA36 ZB4BA46 ZB4BA56 ZB4BA66

■ Color cap to be ordered separately, see page 65.

▲ For legend ordering information see page 64.

Push Buttons & Operator Interface - XB4 22 mm Die Cast Chrome Plated Non-Illuminated Operators

Non-Illuminated Operators, Momentary - Premarked



ZB4BA331



ZB4BA334



ZB4BL432

Shape of Head	Type of Push	Marking Text	Color	Color of Cap	Catalog Number
	Flush	I	White Black	Green White	ZB4BA331 ZB4BA131
		START	White Black	Green White	ZB4BA333 ZB4BA133
		ON	White Black	Green White	ZB4BA341 ZB4BA141
		O	White	Red Black	ZB4BA432 ZB4BA232
		STOP	White	Red Black	ZB4BA434 ZB4BA234
		OFF	White	Red Black	ZB4BA435 ZB4BA235
		↑ ■	Black White	White Black	ZB4BA334 ZB4BA335
	Extended	O	White	Red Black	ZB4BL432 ZB4BL232
		STOP	White	Red Black	ZB4BL434 ZB4BL234
		OFF	White	Red Black	ZB4BL435 ZB4BL235

■ Cap supplied not clipped-in, allowing orientation of arrow in 4 directions: ↑, ↓, ← or →.



ZB4BC24



ZB4BC2



ZB4BR2

Mushroom Heads, Momentary

Shape of Head	Diameter of Head	Color of Head	Catalog Number	
	30 mm	Black	ZB4BC24	
		Green	ZB4BC34	
		Red	ZB4BC44	
		Yellow	ZB4BC54	
		Blue	ZB4BC64	
		Black	ZB4BC2	
	40 mm	Green	ZB4BC3	
		Red	ZB4BC4	
		Yellow	ZB4BC5	
		Blue	ZB4BC6	
		60 mm	Black	ZB4BR2
			Green	ZB4BR3
	Red		ZB4BR4	
	Yellow		ZB4BR5	
	Blue		ZB4BR6	

Push Buttons & Operator Interface - XB4 22 mm Die Cast Chrome Plated Non-Illuminated and Two Button Operators



ZB4BH02



ZB4BA8134



ZB4BL8312



ZB4BL9312



ZB4BL8412



ZB4BL8434

Non-Illuminated Push-On/Push-Off Operators ■

Shape of Head	Type of Push	Color of Push	Catalog Number
	Flush	White	ZB4BH01
		Black	ZB4BH02
		Green	ZB4BH03
		Red	ZB4BH04
		Yellow	ZB4BH05
		Blue	ZB4BH06
	Extended	White	ZB4BH1
		Black	ZB4BH2
		Green	ZB4BH3
		Red	ZB4BH4
		Yellow	ZB4BH5
		Blue	ZB4BH6

■ Maximum of 1 row of 3 contact blocks on associated body/mounting collar sub-assembly.

Two Head Operators, Momentary

Shape of Head	Description	Color of Pushes	Degree of Protection	Catalog Number
No Marking				
	Two flush	Green Red	IP 40 IP 66	ZB4BA8134 ZB4BA9134
		White Black	IP 40 IP 66	ZB4BA8112 ZB4BA9112
	One flush One extended	Green Red	IP 40 IP 66	ZB4BL8334 ZB4BL9334
		White Black	IP 40 IP 66	ZB4BL8312 ZB4BL9312
Premarked				
	Two flush (marked "I") (marked "O")	Green Red	IP 40 IP 66	ZB4BA8234 ZB4BA9234
		White Black	IP 40 IP 66	ZB4BA8212 ZB4BA9212
	One flush (marked "I") One extended (marked "O")	Green Red	IP 40 IP 66	ZB4BL8434 ZB4BL9434
		White Black	IP 40 IP 66	ZB4BL8412 ZB4BL9412

Push Buttons & Operator Interface - XB4 22 mm Die Cast Chrome Plated Emergency Stop Operators and Yellow Contrast Plates



Mushroom Heads for Maintained Push Buttons

Shape of Head	Type of Push	Diameter of Head	Color	Catalog Number
	Trigger action Push-pull ▲	40 mm	Red	ZB4BT84
	Trigger action Turn to release ▲	30 mm	Red	ZB4BS834
		40 mm	Red	ZB4BS844
	Trigger action Key release (No. 455) ▲	30 mm	Red	ZB4BS934
		40 mm	Red	ZB4BS944 ■
		60 mm	Red	ZB4BS964
	Push-pull	40 mm	Black Red	ZB4BT2 ZB4BT4
		60 mm	Black Red	ZB4BX2 ZB4BX4
		Turn to release	30 mm	Black Red
40 mm	Black Red Yellow		ZB4BS52 ZB4BS54 ZB4BS55	
	Red - Marked "EMO" Yellow - Marked "Robot Stop"		ZB4BS5430 * ZB4BS5550 *	
	60 mm		Black Red	ZB4BS62 ZB4BS64
	Key release (No. 455)	30 mm	Black Red	ZB4BS72 ZB4BS74
		40 mm	Black Red	ZB4BS12 ZB4BS14 ■
		60 mm	Black Red	ZB4BS22 ZB4BS24

■ Other key numbers:

- key No. 421E: add the suffix 12 to the reference.
- key No. 458A: add the suffix 10 to the reference.
- key No. 520E: add the suffix 14 to the reference.
- key No. 3131A: add the suffix 20 to the reference.

Example:

The reference for a Ø 40 mm red mushroom head for a trigger action, maintained push button, with release by key No. 421E becomes: ZB4BS94412.

▲ Maximum number of contact blocks fitted to associated body: 4.

- * Semi S2 compliant emergency machine off, use with guard ZB4BZ1905, see page 66.



ZBY9330

Circular Legends for Emergency Stop Mushroom Heads (yellow background)

Diameter	Text	Catalog Number
60 mm	Blank	ZBY9101
	EMERGENCY STOP	ZBY9330
90 mm	Blank	ZBY8101
	EMERGENCY STOP	ZBY8330

Push Buttons & Operator Interface - XB4 22 mm Die Cast Chrome Plated Selector Switches

Non-Illuminated Selector Switches ■▲



ZB4BD4



ZB4BJ3

Shape of Head	Type of Operator	Number and Type of Positions		Catalog Number		
	Standard lever, black For colored lever add the following code to end of part number: 01 - white 03 - green 04 - red 05 - yellow 06 - blue (Example: ZB4BD204)	2 - maintained		ZB4BD2		
		2 - momentary from right to left		ZB4BD4		
		3 - maintained		ZB4BD3		
		3 - momentary to center		ZB4BD5		
		3 - momentary from left to center		ZB4BD7		
		3 - momentary from right to center		ZB4BD8		
			Extended lever, black	2 - maintained		ZB4BJ2
				2 - momentary from right to left		ZB4BJ4
3 - maintained				ZB4BJ3		
3 - momentary to center				ZB4BJ5		
3 - momentary from left to center				ZB4BJ7		
3 - momentary from right to center				ZB4BJ8		

Non-Illuminated Key Switches



ZB4BG8

Shape of Head	Type of Operator	Number and Type of Positions		Catalog Number ●
	Key (No. 455)	2 - maintained		ZB4BG2
				ZB4BG4
		2 - momentary from right to left		ZB4BG6
			3 - maintained	
				ZB4BG3
				ZB4BG5
				ZB4BG9
				ZB4BG09
		3 - momentary from left to center		ZB4BG1
		3 - momentary to center		ZB4BG7
3 - momentary from right to center		ZB4BG8		
		ZB4BG08		

The symbol indicates key withdrawal position(s).

- For actuation of outside contacts only.
- ▲ See selector switch sequence charts on page 56.
- Other key numbers:
 - key No. 421E: add the suffix 12 to the reference.
 - key No. 458A: add the suffix 10 to the reference.
 - key No. 520E: add the suffix 14 to the reference.
 - key No. 3131A: add the suffix 20 to the reference.

Example:

The catalog number for a head with key No. 421E for a 2 position maintained, lockable selector switch, with key withdrawal from the left-hand position, becomes: ZB4BG212.

Push Buttons & Operator Interface - XB4 22 mm Die Cast Chrome Plated Contact Blocks



ZB4BZ101



ZB4BZ102



ZBE101



ZBE102



ZBE203



ZBE204



ZB4BZ009

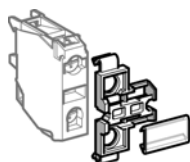

ZBZ001

Contact Blocks (Mounting Base with Contact Blocks)

Description	Type of Contact		Catalog Number
	N/O	N/C	
Screw clamp terminal connections	1	–	ZB4BZ101
	–	1	ZB4BZ102
	2	–	ZB4BZ103
	–	2	ZB4BZ104
	1	1	ZB4BZ105
	1	2	ZB4BZ141
Gold-Flashed Low Power Switching (5 - 24 V, 0.1 - 100 mA) Dust Protected (IP5x per IEC 60529) ▲	1	–	ZB4BZ1016
	–	1	ZB4BZ1026
	2	–	ZB4BZ1036
	–	2	ZB4BZ1046
	1	1	ZB4BZ1056
Quick-Connect (1 x 0.250" or 2 x 0.110")	1	–	ZB4BZ1013
	–	1	ZB4BZ1023
	2	–	ZB4BZ1033
	–	2	ZB4BZ1043
Ring Tongue Compatible (# 8 stud, ≤ 5.8 mm width)	1	–	ZB4BZ1053
	–	1	ZB4BZ1019
	–	1	ZB4BZ1029

Add-On Contact Block (with screw clamp terminal connections) ■

Description	Type of Contact		Catalog Number
	N/O	N/C	
Standard single contact blocks	1	–	ZBE101
	–	1	ZBE102
Standard double contact blocks	2	–	ZBE203
	–	2	ZBE204
	1	1	ZBE205
Special contact blocks (for low power switching and dust protected) ▲	1	–	ZBE1016
	–	1	ZBE1026

Specialty Add-On Contact Blocks ■

Quick-Connect (1 x 0.250" or 2 x 0.110")	1	–	ZBE1013
	–	1	ZBE1023
Ring tongue Compatible (# 8 stud, ≤ 5.8 mm width)	1	–	ZBE1019
	–	1	ZBE1029

Body/Mounting Collar

For use with	Catalog Number
Electrical block (contact or light module)	ZB4BZ009

Clip-on Legend Holders for Electrical Blocks (Contact Blocks and Light Modules) (with screw clamp terminal connections)

Identification of an XB4B control or signalling unit	ZBZ001
--	--------

- The contact blocks enable variable composition of body sub-assemblies and can be stacked to 3 rows, either: 3 rows of 3 single contacts or 1 row of 3 double contacts + 1 row of 3 single contacts (double contact blocks occupy 2 rows).
- ▲ Cannot stack additional contact blocks onto these blocks.

Push Buttons & Operator Interface - XB4 22 mm Die Cast Chrome Plated Specialty Operators

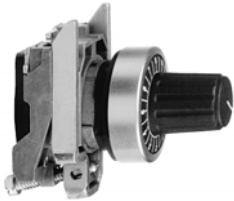

ZB4BD922



Potentiometer Operator (with Mounting Collar)

Shape of Head	Description	Application	Catalog Number
	For potentiometer with shaft length 1.73 to 1.97 in (44 to 50 mm) (potentiometer not included)	For shaft Ø 0.25 in (6.35 mm)	ZB4BD922

Joystick Controllers (54 mm, Extended Operating Shaft) ■



XD4PA12

Description	Contact Operation	Action	Catalog Number
2 direction 	1 step 1 N/O contact per direction	Maintained	XD4PA12
		Spring Return	XD4PA22
4 direction 	1 step 1 N/O contact per direction	Maintained	XD4PA14
		Spring Return	XD4PA24

■ It is not permissible to use standard contact blocks ZBE10* (single) or ZBE20* (double)

Legends for Joystick Controllers

Description	For use with		Catalog Number
Legends 30 x 48 mm for engraving	2 direction	Black one side Red reverse	ZBG2201
		White one side Yellow reverse	ZBG2401
Legends 48 x 48 mm for engraving	4 direction	Black one side Red reverse	ZBG4201
		White one side Yellow reverse	ZBG4401

Two Position Toggle Switch





ZB4BD28

Shape of Head	Color	Type of Positions	Catalog Number
	Black	Maintained	ZB4BD28
	Black	Momentary	ZB4BD48

Reset Operators, Flush, Adjustable Shaft



XB4BA8*1

Shape of Head	Travel	Actuation Distance	Color	Catalog Number
	0.39 in (10 mm)	0.24-0.63 in (6-16 mm)	Black	XB4BA821
			Red	XB4BA841
			Blue	XB4BA861
		0.63-1.02 in (16-26 mm)	Black	XB4BA822
			Red	XB4BA842
			Blue	XB4BA862
	0.55 in (14 mm)	1.18-5.12 in (30-130 mm)	Black	XB4BA921
			Red	XB4BA941
			Blue	XB4BA961
		5.12-10.12 in (130-257 mm)	Black	XB4BA922
			Red	XB4BA942
			Blue	XB4BA962

Push Buttons & Operator Interface - XB4 22 mm Die Cast Chrome Plated Pilot Lights and Light Modules

Pilot Light Heads



ZB4BV063



ZB4BV04

Shape of Head	For Use with Body Comprising Light Module Type	Color of Lens	Catalog Number
	Protected LED only	White	ZB4BV013
		Green	ZB4BV033
		Red	ZB4BV043
		Yellow	ZB4BV053
		Blue	ZB4BV063
	Protected LED only Fresnel lens	White	ZB4BV013S
		Green	ZB4BV033S
		Red	ZB4BV043S
		Yellow	ZB4BV053S
For BA 9s incandescent bulb, neon or LED only	Blue	ZB4BV063S	
	White	ZB4BV01	
	Green	ZB4BV03	
	Red	ZB4BV04	
	Yellow	ZB4BV05	
	Blue	ZB4BV06	
	Clear	ZB4BV07	

Complete Bodies (Mounting Collar + Light Module for BA 9s Incandescent Bulb, Neon or LED)



ZB4BV6

Description	Light Source	Supply Voltage (V)	Catalog Number
Screw clamp terminal connections ▼			
Direct supply	BA 9s bulb 2.4 W max. Not included ●	≤ 250	ZB4BV6
Transformer type 1.2 VA, 6 V secondary	BA 9s incandescent bulb included	110-120 Vac 50/60 Hz	ZB4BV3
		230-240 Vac 50/60 Hz	ZB4BV4
		400-50 Hz	ZB4BV5
		440-480 Vac 60 Hz	ZB4BV8
		550-600 Vac 60 Hz	ZB4BV9

- Bulb can be ordered separately, see page 66, or add voltage (24,120) for bulbs supplied.

Complete Bodies (Mounting Collar + Light Module with Protected LED)

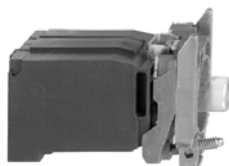















ZB4BV•

Light Source	Supply Voltage	Color of Light Source	Catalog Number		
Screw clamp terminal connections ▼					
	24 Vac or Vdc	White	ZB4BVB1		
		Green	ZB4BVB3		
		Red	ZB4BVB4		
		Yellow	ZB4BVB5		
		Blue	ZB4BVB6		
		White	ZB4BVG1		
	110-120 Vac	Green	ZB4BVG3		
		Red	ZB4BVG4		
		Yellow	ZB4BVG5		
		Blue	ZB4BVG6		
		Protected LED Flashing	24 Vac or Vdc	White	ZB4BV18B1
				Green	ZB4BV18B3
Red	ZB4BV18B4				
Yellow	ZB4BV18B5				
Blue	ZB4BV18B6				
110-120 Vac	White			ZB4BV18G1	
	Green	ZB4BV18G3			
	Red	ZB4BV18G4			
	Yellow	ZB4BV18G5			
	Blue	ZB4BV18G6			

- ▼ For "Quick-Connect" version, add 3 to the end of the part number (Example: ZB4BV63) (1 X 0.250" or 2 x 0.110").

Push Buttons & Operator Interface - XB4 22 mm Die Cast Chrome Plated Illuminated Operators

Heads for Momentary Illuminated Push Buttons

	Shape of Head	Type of Push	Color	Catalog Number
Only use with protected LED light modules				
 ZB4BW333		Flush	White	ZB4BW313
			Green	ZB4BW333
			Red	ZB4BW343
			Yellow	ZB4BW353
			Blue	ZB4BW363
 ZB4BW563		Flush with clear boot	White	ZB4BW513
			Green	ZB4BW533
			Red	ZB4BW543
			Yellow	ZB4BW553
			Blue	ZB4BW563
 ZB4BW113		Flush for insertion of legend (Lens supplied but not installed)	White	ZB4BA18
			Green	ZB4BA38
			Red	ZB4BA48
			Yellow	ZB4BA58
			Blue	ZB4BA68
 ZB4BW113		Extended	White	ZB4BW113
			Green	ZB4BW133
			Red	ZB4BW143
			Yellow	ZB4BW153
			Blue	ZB4BW163
 ZB4BW443		Mushroom (40 mm)	Green	ZB4BW433
			Red	ZB4BW443
			Yellow	ZB4BW453
			Blue	ZB4BW463
			Clear	ZB4BW473
Only use with light modules for a BA 9s incandescent bulb, neon or LED				
 ZB4BW33		Flush	White	ZB4BW31
			Green	ZB4BW33
			Red	ZB4BW34
			Yellow	ZB4BW35
			Blue	ZB4BW36
		Clear	ZB4BW37	
 ZB4BW14		Extended	White	ZB4BW11
			Green	ZB4BW13
			Red	ZB4BW14
			Yellow	ZB4BW15
			Blue	ZB4BW16
		Clear	ZB4BW17	

Push Buttons & Operator Interface - XB4 22 mm Die Cast Chrome Plated Illuminated Operators

Two Button with Pilot Light, Momentary (IP 40) ■ ▲



ZB4BW812743



ZB4BW823743



ZB4BW841723

Shape of Head	Description	Color of Pushes	Color of Pilot Light	Catalog Number
Only use with protected LED light modules (protected LED determines pilot light color)				
	1 flush 1 central pilot light 1 flush	Black	Clear	ZB4BW812743
		Red		
		Green	Clear	ZB4BW813743
		Red		
		White		
Black	Clear	ZB4BW811723		
	1 flush 1 central pilot light 1 extended	Black	Clear	ZB4BW832743
		Red		
		Green	Clear	ZB4BW833743
		Red		
		White		
Black	Clear	ZB4BW831723		
Only use with protected LED light modules (protected LED determines pilot light color) - premarked				
	1 flush (marked "I") 1 central pilot light 1 flush (marked "O")	Black	Clear	ZB4BW822743
		Red		
		Green	Clear	ZB4BW823743
		Red		
		White		
Black	Clear	ZB4BW821723		
	1 flush (marked "I") 1 central pilot light 1 extended (marked "O")	Black	Clear	ZB4BW842743
		Red		
		Green	Clear	ZB4BW843743
		Red		
		White		
Black	Clear	ZB4BW841723		

Heads for Maintained Illuminated Push Buttons



ZB4BW643

Shape of Head	Type of Push	Color	Catalog Number
Only use with protected LED light modules			
	Push / Pull Mushroom (40 mm)	Green	ZB4BW633
		Red	ZB4BW643
		Yellow	ZB4BW653
		Blue	ZB4BW663
		Clear	ZB4BW673

Illuminated "Push-on/Push-off" Operators ●



ZB4BH033



ZB4BH63

Shape of Head	Type of Push	Color of Lens	Catalog Number
Only use with protected LED light modules			
	Flush	White	ZB4BH013
		Green	ZB4BH033
		Red	ZB4BH043
		Yellow	ZB4BH053
		Blue	ZB4BH063
	Extended	White	ZB4BH13
		Green	ZB4BH33
		Red	ZB4BH43
		Yellow	ZB4BH53
		Blue	ZB4BH63

- For IP 66 degree of protection, install clear sealing boot ZBW008, see page 67.
- ▲ Color of centrally positioned pilot light determined by the color of the LED incorporated in the body sub-assembly.
- Maximum of 1 row of 2 contact blocks on associated body/mounting collar sub-assembly.

Push Buttons & Operator Interface - XB4 22 mm Die Cast Chrome Plated Illuminated Selector Switches

Illuminated Selector Switches, Standard Lever



ZB4BK1343

Shape of Head	Number and Type of Positions	Color of Lever	Catalog Number
Only use with protected LED light modules			
	2 - maintained 	White Green Red Yellow Blue	ZB4BK1213 ZB4BK1233 ZB4BK1243 ZB4BK1253 ZB4BK1263
	2 - momentary from right to left 	White Green Red Yellow Blue	ZB4BK1413 ZB4BK1433 ZB4BK1443 ZB4BK1453 ZB4BK1463
	3 - maintained 	White Green Red Yellow Blue	ZB4BK1313 ZB4BK1333 ZB4BK1343 ZB4BK1353 ZB4BK1363
	3 - momentary to center 	White Green Red Yellow Blue	ZB4BK1513 ZB4BK1533 ZB4BK1543 ZB4BK1553 ZB4BK1563
	3 - momentary from right to center 	White Green Red Yellow Blue	ZB4BK1813 ZB4BK1833 ZB4BK1843 ZB4BK1853 ZB4BK1863
	3 - momentary from left to center 	White Green Red Yellow Blue	ZB4BK1713 ZB4BK1733 ZB4BK1743 ZB4BK1753 ZB4BK1763

Selector Switch Sequence (using contact block assemblies, page 51; or complete bodies, page 57)

2 Position Selector Switch		
		Contact block guide
O	X	1 N.O. (left or right)
X	O	1 N.C. (left or right)
O	X	1 N.O. and 1 N.C.
X	O	

3 Position Selector Switch			
			Contact block guide
X	O	O	1 N.O. (left)
O	X	O	2 N.C. wired in SERIES, (left and right)
O	O	X	1 N.O. (right)
X	X	O	1 N.C. (right)
O	X	X	1 N.C. (left)
X	O	X	2 N.O. wired in PARALLEL, (left and right)

Push Buttons & Operator Interface - XB4 22 mm Die Cast Chrome Plated Light Module Assemblies

Complete Bodies (Mounting Collar + Single Contact Block + Light Module with Protected LED)



ZB4BW03**

Light Source	Supply Voltage	Type of Contact		Color	Catalog Number
		N/O	N/C		
Screw clamp terminal connections					
Protected LED Protected LED	24 Vac or Vdc	1	-	White	ZB4BW0B11
				Green	ZB4BW0B31
				Red	ZB4BW0B41
				Yellow	ZB4BW0B51
		Blue	ZB4BW0B61		
		-	1	White	ZB4BW0B12
				Green	ZB4BW0B32
				Red	ZB4BW0B42
	Yellow			ZB4BW0B52	
	Blue	ZB4BW0B62			
	2	-	White	ZB4BW0B13	
			Green	ZB4BW0B33	
			Red	ZB4BW0B43	
			Yellow	ZB4BW0B53	
	Blue	ZB4BW0B63			
	Protected LED Protected LED	110-120 Vac	1	-	White
Green					ZB4BW0G31
Red					ZB4BW0G41
Yellow					ZB4BW0G51
Blue			ZB4BW0G61		
-			1	White	ZB4BW0G12
				Green	ZB4BW0G32
				Red	ZB4BW0G42
	Yellow	ZB4BW0G52			
Blue	ZB4BW0G62				
2	-	White	ZB4BW0G13		
		Green	ZB4BW0G33		
		Red	ZB4BW0G43		
		Yellow	ZB4BW0G53		
Blue	ZB4BW0G63				
1	1	White	ZB4BW0G15		
		Green	ZB4BW0G35		
		Red	ZB4BW0G45		
		Yellow	ZB4BW0G55		
Blue	ZB4BW0G65				

■ Can be fitted with additional contact blocks, see page 58.

Push Buttons & Operator Interface - XB4 22 mm Die Cast Chrome Plated Light Module Assemblies



ZB4BW06



ZB4BW05



ZBVB



ZBE101



ZBE102



ZBE203



ZBE204



ZB4BZ009

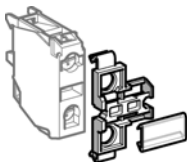

ZBZ001

Contact Block and Light Module (with screw clamp terminal connections) ■

Supply	Light Source	Supply Voltage *	Type of Contact ■		Color of Light Source	Catalog Number
			N/O	N/C		
Screw clamp terminal connections						
Direct supply	BA 9s 2.4 W max. bulb Not included ▲	≤ 250 Vac or Vdc	1	–	–	ZB4BW061
			–	1	–	ZB4BW062
			2	–	–	ZB4BW063
			1	1	–	ZB4BW065
Transformer type 1.2 VA, 6 V secondary	BA 9s incandescent bulb included	110-120 Vac 50/60 Hz	1	–	–	ZB4BW031
			1	1	–	ZB4BW035
		230-240 Vac 50/60 Hz	1	–	–	ZB4BW041
			1	1	–	ZB4BW045
		400 Vac 50 Hz	1	–	–	ZB4BW051
			1	1	–	ZB4BW055

■ Can be fitted with additional contact blocks, see page 58.

▲ Bulb can be ordered separately, see page 66, or add voltage (24, 120) for bulb supplied.

* For additional supply voltages, contact local Square D field office.

Light Modules (with screw clamp terminal connections) □

Description	Supply Voltage	Color of Light Source	Catalog Number
Protected LED 	24 Vac or Vdc	White	ZBVB1
		Green	ZBVB3
		Red	ZBVB4
		Yellow	ZBVB5
		Blue	ZBVB6
		110-120 Vac	White
Green	ZBVG3		
Red	ZBVG4		
Yellow	ZBVG5		
Blue	ZBVG6		
230-240 Vac	White		ZBVM1
	Green	ZBVM3	
	Red	ZBVM4	
	Yellow	ZBVM5	
	Blue	ZBVM6	
	Direct supply for BA 9s 2.4 W max. bulb Not included ▲	≤ 250 Vac or Vdc	–

Add-On Contact Block (with screw clamp terminal connections) ● ▼

Description	Type of Contact		Catalog Number
	N/O	N/C	
Standard single contact blocks	1	–	ZBE101
	–	1	ZBE102
Standard double contact blocks	2	–	ZBE203
	–	2	ZBE204
	1	1	ZBE205
Special contact blocks (for low power switching and dust protected) ◆	1	–	ZBE1016
	–	1	ZBE1026

Body/Mounting Collar

For use with	Catalog Number
Electrical block (contact or light module)	ZB4BZ009

Clip-on Legend Holders for Electrical Blocks (Contact Blocks and Light Modules)

(with screw clamp terminal connections)

Identification of an XB4-B control or signalling unit	ZBZ001
---	--------

Sheet of 50 Blank Legends

Legend holder ZBZ001	ZBY001
----------------------	--------

● The contact blocks enable variable composition of body sub-assemblies and can be stacked to 3 rows, either: 3 rows of 3 single contacts or 1 row of 3 double contacts + 1 row of 3 single contacts (double contact blocks occupy 2 rows).

◆ Cannot stack additional contact blocks onto these blocks.

□ For "Quick-Connect" options, see page 53.

▼ For "Quick-Connect" options, see page 52.

Push Buttons & Operator Interface - XB4 22 mm Die Cast Chrome Plated Light Module Assemblies, Contact Blocks, Plug-In Connector Type

Contact Blocks (Mounting Base with Contact Blocks)



ZB4BZ1014

Description	Type of Contact		Catalog Number
	N/O	N/C	
Plug-in connector	1	–	ZB4BZ1014
	–	1	ZB4BZ1024
	2	–	ZB4BZ1034
	–	2	ZB4BZ1044
	1	1	ZB4BZ1054
	1	2	ZB4BZ1414

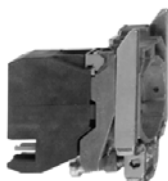

ZB4BZ1024

Contact Blocks for Plug-in Connector

Description	Type of Contacts		Catalog Number
	N/O	N/C	
Standard contact blocks	1	–	ZBE1014
	–	1	ZBE1024



ZBE1014



ZBE1024



ZBVB*4

Light Modules for Plug-in Connector

Description	Supply Voltage	Color of Light Source	Catalog Number	
Protected LED	24 Vac or Vdc	White	ZBVB14	
		Green	ZBVB34	
		Red	ZBVB44	
		Yellow	ZBVB54	
		Blue	ZBVB64	
		110-120 Vac	White	ZBVG14
	110-120 Vac	Green	ZBVG34	
		Red	ZBVG44	
		Yellow	ZBVG54	
		Blue	ZBVG64	
		230-240 Vac	White	ZBVM14
			Green	ZBVM34
	Red		ZBVM44	
	Yellow		ZBVM54	
	Blue		ZBVM64	

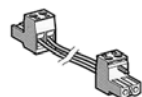

APE1C2250



APE1PAD21

Connecting Cables and Connector

Description	Number of Connector	Wire c.s.a	Length	Catalog Number
Connecting cable with 2-pin connector 0.20 in (5.08 mm)	1	#18 AWG (0.75 mm ²)	19.69 in (500 mm)	APE1C2150
	2	#18 AWG (0.75 mm ²)	19.69 in (500 mm)	APE1C2250
Self-stripping connector	–	#18 AWG (0.75 mm ²)	–	APE1PAD21

Push Buttons & Operator Interface - XB4 22 mm Die Cast Chrome Plated Printed Circuit Board (PCB) Components



ZBE701



ZBE702



ZBVB-7

Contact Blocks for Printed Circuit Board (PCB) Connection ■

Description	Type of Contacts		Catalog Number
	N/O	N/C	
Standard contact blocks	1	–	ZBE701
	–	1	ZBE702
Special contact blocks (for low power switching and dust protected)	1	–	ZBE7016
	–	1	ZBE7026

Protected LED Light Modules for Printed Circuit Board (PCB) Connection ■

Description	Supply Voltage	Color of Light Source	Catalog Number
 Protected LED (For heads with protected LED, see page 53.)	24 Vac or Vdc	White	ZBVB17
		Green	ZBVB37
		Red	ZBVB47
		Yellow	ZBVB57
		Blue	ZBVB67

Adaptor (socket) for Printed Circuit Board (PCB)

For use with	Catalog Number
Electrical block (contact or light module)	ZBZ010



ZB4BZ009

Body/Mounting Collar

For use with	Catalog Number
Electrical block (contact or light module)	ZB4BZ009



ZBZ010

Accessories Specifically for Printed Circuit Boards (PCB) Connection ■

Description	Application	Catalog Number
Pillar	Printed circuit board support	ZB4BZ079
Mounting screw for printed circuit board	Pillar (ZB4BZ079)	ZBZ006

■ For details of support drilling and printed circuit board, see page 61. Must be used in conjunction with ZBZ010 adaptor (socket).



ZB4BZ079 + ZB4BZ009

Push Buttons & Operator Interface - XB4 22 mm Die Cast Chrome Plated PCB Layout and Design

Connecting Control Units to Printed Circuit Boards (PCB)

Panel cut-out (viewed from installers side)

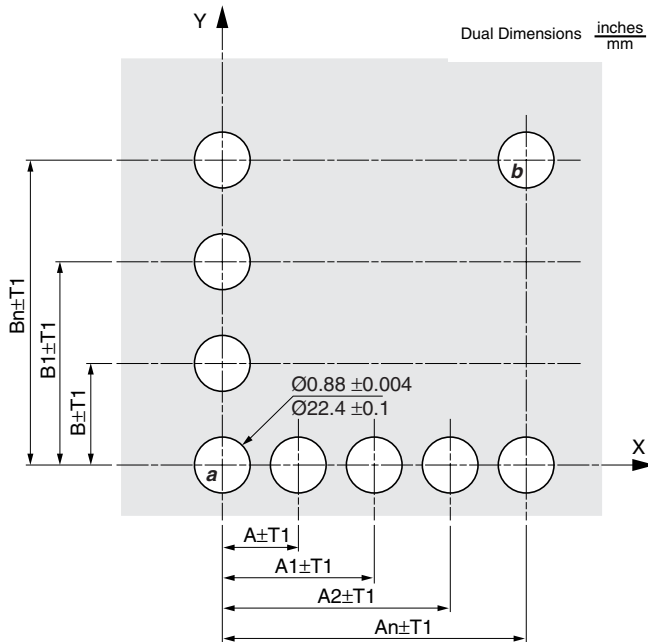

Printed Circuit Board Drilling

(viewed from electrical block side)

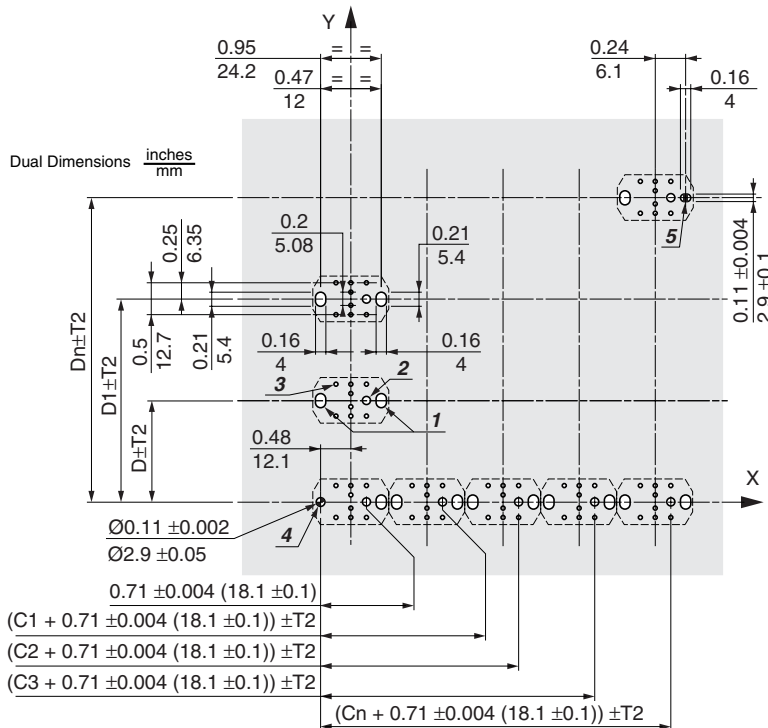

General Tolerances of the Panel and Printed Circuit Board

The cumulative tolerance must not exceed 0.012 inch (0.3 mm): $T1 + T2 = 0.012$ inch (0.3 mm) maximum.

Related to horizontal direction X

Dimensions: A on panel
C + 0.71 inch (18.1 mm) on printed circuit board

Installation Precautions:

1. Minimum circuit board thickness:
0.063 in (1.6 mm)
2. Cut-out diameter:
 0.88 ± 0.004 (22.4 mm ± 0.1)
3. Orientation of body/mounting collar ZB4BZ009:
 $\pm 2^\circ 30'$ (excluding **a** and **b**)
4. Mounting screw ZBZ006 tightening torque:
(0.6 N•m)
5. Allow for pillar ZB4BZ079 and mounting screws every 3.54 inches (90 mm) horizontally (X), and 4.72 inches (120 mm) vertically (Y). (for cut-out with 1.18 x 1.52 inch (30 x 40 mm) centers)
6. The mounting centers marked **a** and **b** are diagonally opposed, in alignment with those on the printed circuit board marked **4** and **5**.

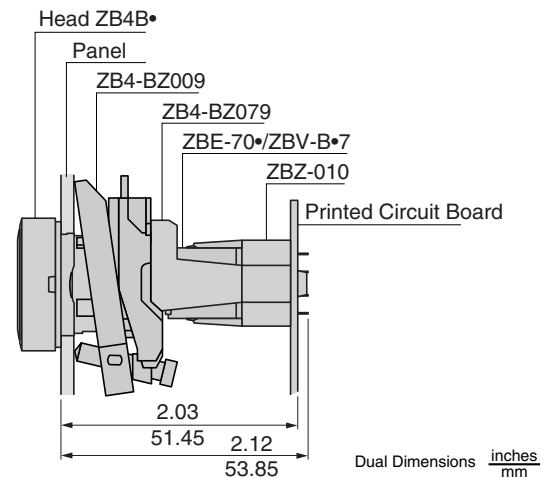

Mounting with adaptor (socket) ZBZ010:

- 1 Two elongated holes for ZBZ006 screw access.
- 2 One - 0.09 inch ± 0.002 (2.4 mm ± 0.05) \varnothing hole to center ZBZ010 adaptor.
- 3 Eight - 0.05 inch (1.2 mm) \varnothing holes.
- 4 One - 0.11 inch ± 0.002 (2.9 mm ± 0.05) \varnothing hole, to center printed circuit board (drilling marked **a**).
- 5 One elongated hole for orientation of printed circuit board (drilling marked **b**).

Push Buttons & Operator Interface - XB4 22 mm Die Cast Chrome Plated Legend Plates

Standard (30 x 40 mm) Legend Plates for 8 x 27 mm Legends ■

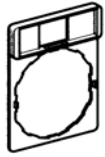

ZBZ32

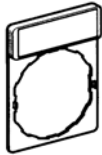

ZBY101



ZBY2303

Description	Legend		Catalog Number
	Color	Text	
Without legend	–	–	ZBZ32
With blank legend (for engraving)	Black or red background	–	ZBY2101
	White or yellow background	–	ZBY4101
Custom Legend (Specify Engraving) 2 lines of 11 characters (including spaces) maximum per line	Black background	White	ZBY2002
	Red background	White	ZBY2004
	White background	Black	ZBY4001
	Yellow background	Black	ZBY4005
With international language marked legend	Black or red background	O (black background)	ZBY2146
		O (red background)	ZBY2931
		I	ZBY2147
		II	ZBY2148
		O-I	ZBY2178
		I-II	ZBY2179
		I-O-II	ZBY2186
		AUTO	ZBY2115
		STOP	ZBY2304
		With English language marked legend	Black or red background ▲
AUTO-O-HAND	ZBY2385		
CLOSE	ZBY2314		
DOWN	ZBY2308		
EMERGENCY STOP	ZBY2330		
FAST	ZBY2328		
FORWARD	ZBY2305		
FOR REV	ZBY2371		
HAND	ZBY2316		
HAND-OFF-AUTO	ZBY2387		
INCH	ZBY2321		
JOG	ZBY2382		
LEFT	ZBY2310		
OFF	ZBY2312		
OFF-ON	ZBY2367		
ON	ZBY2311		
OPEN	ZBY2313		
POWER ON	ZBY2326		
RESET (red background)	ZBY2323		
RESET (black background)	ZBY2322		
REVERSE	ZBY2306		
RIGHT	ZBY2309		
RUN	ZBY2334		
SLOW	ZBY2327		
START	ZBY2303		
STOP-START	ZBY2366		
UP	ZBY2307		

■ For legends, see page 64.

▲ "Start" functions: white letters on black background. "Stop" functions: white letters on red background (unless otherwise specified above).

Push Buttons & Operator Interface - XB4 22 mm Die Cast Chrome Plated Legend Plates

Flush Mounting with Bezel Legend Plates (30 x 40 mm) for 8 x 27 mm Legends



ZBY•H101

Description	Color	Catalog Number
Without legend	–	ZBZ34
With blank legend	Black or red background	ZBY2H101
	White or yellow background	ZBY4H101

Standard (30 x 50 mm) Legend Plates for 18 x 27 mm Legends

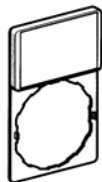

ZBY610•

Description	Color	Catalog Number
Without legend	–	ZBZ33
With blank legend	Black or red background	ZBY6101
	White or yellow background	ZBY6102

Flush Mounting with Legend Plates (30 x 50 mm) for 18 x 27 mm Legends



ZBY6H10•

Description	Color	Catalog Number
Without legend	–	ZBZ35
With blank legend	Black or red background	ZBY6H101
	White or yellow background	ZBY6H102

Legends for Engraving (inserts only)

Description	For use with	Color	Catalog Number
8 x 27 mm	30 x 40 mm legend holders	Black or red background	ZBY0101
		White or yellow background	ZBY0102
18 x 27 mm	30 x 50 mm legend holders	Black or red background	ZBY5101
		White or yellow background	ZBY5102

Custom Engraved (inserts only)

Description	For use with	Color	Text	Catalog Number
8 x 27 mm Custom Legend / Insert only (Specify Engraving) 2 lines of 11 characters (including spaces) maximum per line	30 x 40 mm holder	Black background	White	ZBY01002
		Red background	White	ZBY01004
		White background	Black	ZBY01001
		Yellow background	Black	ZBY01005
18 x 27 mm Custom Legend / Insert only (Specify Engraving) 3 lines of 11 characters (including spaces) maximum per line	30 x 50 mm holder	Black background	White	ZBY05002
		Red background	White	ZBY05004
		White background	Black	ZBY05001
		Yellow background	Black	ZBY05005

Sheets of Peel-Off Legends (with backing board and protective transparent cover)

Description	For use with	Catalog Number
Sheet of 76 8 x 27 mm legends	30 x 40 mm legend holders ZBZ32 and ZBZ34	ZBY4100
Sheet of 40 18 x 27 mm legends	30 x 50 mm legend holders ZBZ33 and ZBZ35	ZBY5100



ZBY9330

Circular Legends for Emergency Stop Mushroom Heads (yellow background)

Diameter	Text	Catalog Number
60 mm	Blank	ZBY9101
	EMERGENCY STOP	ZBY9330
90 mm	Blank	ZBY8101
	EMERGENCY STOP	ZBY8330

Push Buttons & Operator Interface - XB4 22 mm Die Cast Chrome Plated Legend Plates

Marked Legends (8 x 27 mm) (for 30 x 40 mm legend holders ZBZ32 and ZBZ34)



ZBY02178



ZBY0203

Color	Text		Catalog Number
Black or red background ■	International	O (black background) O (red background) I II O-I I-II I-O-II AUTO STOP	ZBY02146 ZBY02931 ZBY02147 ZBY02148 ZBY02178 ZBY02179 ZBY02186 ZBY02115 ZBY02304
	English	AUTO-HAND AUTO-O-HAND CLOSE DOWN EMERGENCY STOP FAST FORWARD FOR REV HAND HAND-OFF-AUTO INCH JOG LEFT OFF OFF-ON ON OPEN POWER ON RESET (red background) RESET (black background) REVERSE RIGHT RUN SLOW START STOP-START UP	ZBY02364 ZBY02385 ZBY02314 ZBY02308 ZBY02330 ZBY02328 ZBY02305 ZBY02371 ZBY02316 ZBY02387 ZBY02321 ZBY02382 ZBY02310 ZBY02312 ZBY02367 ZBY02311 ZBY02313 ZBY02326 ZBY02323 ZBY02322 ZBY02306 ZBY02309 ZBY02334 ZBY02327 ZBY02303 ZBY02366 ZBY02307

■ "Start" functions: white letters on black background. "Stop" functions: white letters on red background (unless otherwise specified above).

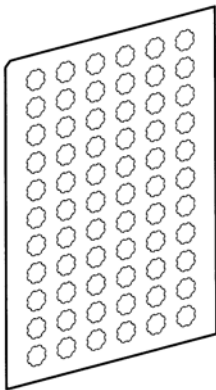

ZBY1101

Sheets of Legends for Push Buttons, Switches, and Pilot Lights

Description	Text		Catalog Number
Sheets of 66 circular peel-off transparent self-adhesive legends	Blank		ZBY1101
	International	O	ZBY1146
		III	ZBY1149
		STOP	ZBY1304
		↑	ZBY1912
English	HAND	ZBY1316	
	OFF	ZBY1312	
	ON	ZBY1311	
	START	ZBY1303	

Push Buttons & Operator Interface - XB4 22 mm Die Cast Chrome Plated Push Button Caps

Push Button Caps - Unmarked



ZBA•



ZBL•

For use with	Type of Push	Color	Catalog Number
ZB4BA0 push button heads supplied with cap	Flush	White Black Green Red Yellow Blue 6 colors ■	ZBA1 ZBA2 ZBA3 ZBA4 ZBA5 ZBA6 ZBA9
	Extended	White Black Green Red Yellow Blue 6 colors ■	ZBL1 ZBL2 ZBL3 ZBL4 ZBL5 ZBL6 ZBL9

Push Button Caps - Marked



ZBA•33

For use with	Type of Push	Marking		Color of Cap	Catalog Number
		Text	Color		
ZB4BA0 push button heads supplied with cap	Flush	I ▲	White	Green	ZBA331
			Black	White	ZBA131
		START ▲	White	Green	ZBA333
			Black	White	ZBA133
		◊	White	Green	ZBA346
		ON	White	Green	ZBA341
			Black	White	ZBA141
		UP ▲	Black	White	ZBA343
		DOWN ▲	White	Black	ZBA344
		⊕ ▲	Black	White	ZBA145
			White	Black	ZBA245
		⊕	White	Green	ZBA345
		↑	Black	White	ZBA334 ☉
			White	Black	ZBA335 ☉
		O ▲	White	Red	ZBA432
				Black	ZBA232
		STOP ▲	White	Red	ZBA434
Black	ZBA234				
OFF	White	Red	ZBA435		
		Black	ZBA235		
R ▲	White	Blue	ZBA639		
Extended	O ▲	White	Red	ZBL432	

- Set of 6 different colored caps: white, black, green, red, yellow, blue.
- ▲ Double injection molded marking.
- ☉ Cap supplied not clipped-in, allowing orientation of arrow ↑, ↓, →, ←.

Push Buttons & Operator Interface - XB4 22 mm Die Cast Chrome Plated Accessories and Replacement Parts



ZBZ160*



ZB4SZ3



ZB5SZ3

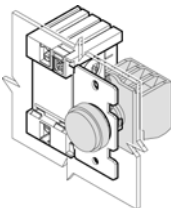

XBZS43



DLCE***



DL1CF***



XBFX13

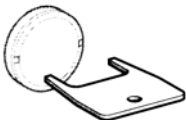

ZBZ8



ZBG455

Accessories

Description	Application	Color	Catalog Number
Metal guards (padlocking possible)	Ø 40 mm Emergency stop and mushroom head push buttons	Black	ZBZ1602
		Red	ZBZ1604
		Yellow	ZBZ1605
		Blue	ZBZ1606
Plastic Guard	Semi S2 Compliant EMO Guard	Yellow	ZB4BZ1905
Pad locking attachment	Prevents operation	Black	ZB4BZ62
Metal blanking plug, round chromium plated ■	For Ø 22 mm control and signalling units		ZB4SZ3
Plastic blanking plug, round black with mounting nut	For Ø 22 mm control and signalling units		ZB5SZ3

■ Requires a ZB4BZ009 body/mounting collar for mounting, see page 51.

Modules for AS-i Interface with Ø 22 mm Control and Signalling Units

Description	Application	Catalog Number
Mounted on panel, with a Harmony style push button		
Profil P 7.0 	4 I/O direct supply for AS-i bus	XBZS43

BA 9s Bulbs and Associated Accessories

Description	Characteristics	Catalog Number
Incandescent bulbs	6 V, 1.2 W	DL1CB006
	12 V, 2 W	DL1CE012
	24 V, 2 W	DL1CE024
	120-130 V, 2.4 W	DL1CE130
Neon bulbs	120-130 V	DL1CF110
	230-240 V	DL1CF220
Bulb extractor		XBFX13
Lens cap tightening tool	Illuminated push buttons with flush push	ZBZ8

Operator Mounting and Wiring Accessories

Description	Characteristics	Catalog Number
Power driver bits for mounting and wiring (package of 5)	Cross headed screw (pozidrive type 1)	ZB4BZ905
Mounting adapter	For mounting 22 mm pushbutton in 30 mm KO	ZBZ41

Replacement Keys for Emergency Stop Push Buttons and Selector Switches

Description	Key Number	Catalog Number
Set of 2 keys	455	ZBG455
	421E	ZBG421E
	458A	ZBG458A
	520E	ZBG520E
	3131A	ZBG3131A

Push Buttons & Operator Interface - XB4 22 mm Die Cast Chrome Plated Accessories and Replacement Parts



ZBP0

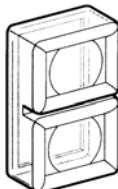

ZBW008



ZBV01-3



ZBV01-1

Clear Boots

Description	For use with	Catalog Number
Single boots	Booted push buttons with circular head (neoprene)	ZBP0
	Booted push buttons with circular head used in food industry applications (silicone)	ZBP0A
Double boots	Double-headed push buttons, with or without pilot light (neoprene)	ZBW008
	Double-headed push buttons used in food industry applications (silicone)	ZBW008A

Lens Caps

For use with	Color	Catalog Number
Lens caps for protected LED light modules		
Pilot lights	White	ZBV0113
	Green	ZBV0133
	Red	ZBV0143
	Yellow	ZBV0153
	Blue	ZBV0163
Illuminated push buttons with flush push	White	ZBW9113
	Green	ZBW9133
	Red	ZBW9143
	Yellow	ZBW9153
	Blue	ZBW9163
Illuminated push buttons with extended push	White	ZBW9313
	Green	ZBW9333
	Red	ZBW9343
	Yellow	ZBW9353
	Blue	ZBW9363
Lens caps for BA 9 light modules		
Pilot lights	White	ZBV011
	Green	ZBV013
	Red	ZBV014
	Yellow	ZBV015
	Blue	ZBV016
	Clear	ZBV017
	Illuminated push buttons with flush push	White
Green		ZBW913
Red		ZBW914
Yellow		ZBW915
Blue		ZBW916
Clear		ZBW917
Illuminated push buttons with extended push	White	ZBW931
	Green	ZBW933
	Red	ZBW934
	Yellow	ZBW935
	Blue	ZBW936
	Clear	ZBW937

Push Buttons & Operator Interface - XB4 22 mm Die Cast Chrome Plated Dimensions

Push Buttons, momentary XB4BA••

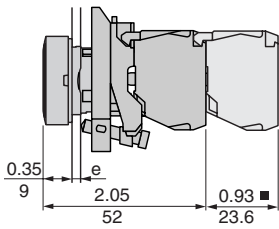

XB4BL••

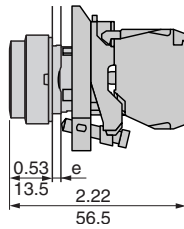

Common face view

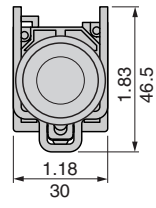

XB4BP••

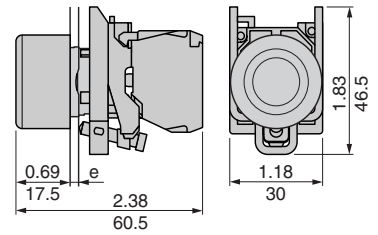

■ Can be fitted with additional contact block.

Mushroom head push buttons, momentary XB4BC21

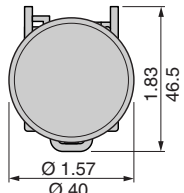
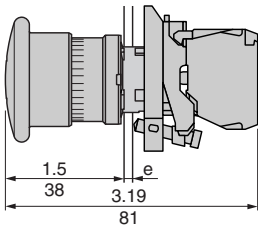

XB4BL•45, BL•4C5

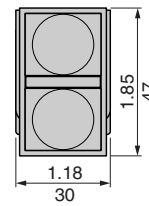
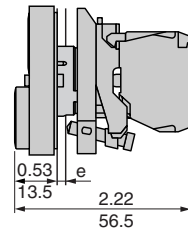

Dual Dimensions $\frac{\text{inches}}{\text{mm}}$

e: Panel thickness, 0.04 to 0.24 in (1 to 6 mm).

Emergency stop and mushroom head push buttons XB4BT42, BT845

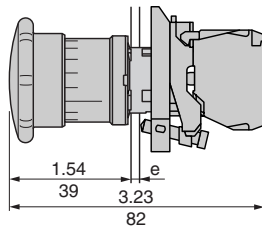
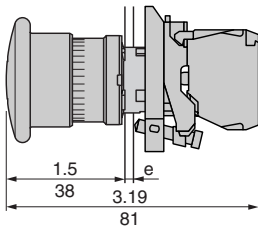

XB4BS142, BS9445

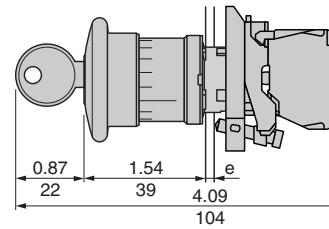

Common face view

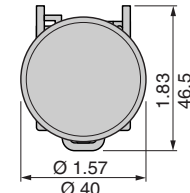

e: Panel thickness, 0.04 to 0.24 in (1 to 6 mm).

Selector switches Standard lever operator XB4BD

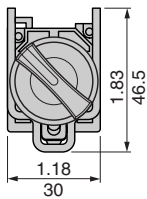
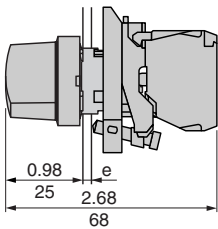

Rectangular Head XB4BJ

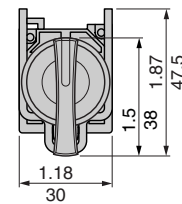
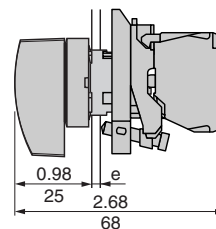

Key switches XB4BG

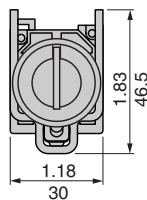
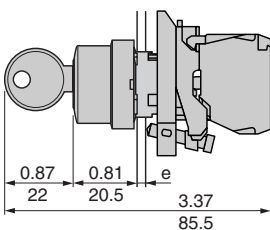

Heads for toggle switches ZB4BD•8

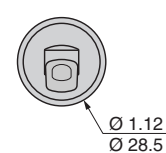
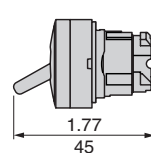

Dual Dimensions $\frac{\text{inches}}{\text{mm}}$

e: Panel thickness, 0.04 to 0.24 in (1 to 6 mm).

Push Buttons & Operator Interface - XB4 22 mm Die Cast Chrome Plated Dimensions

Pilot lights Protected LED XB4BVB•, BVG•, BVM•

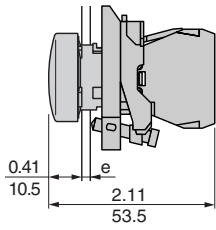

Direct supply XB4BV6

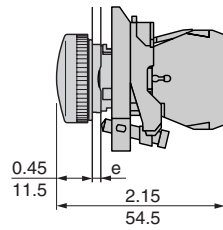

Transformer type XB4BV3•, BV4•

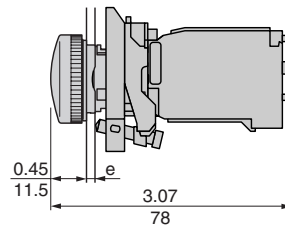

Common face view

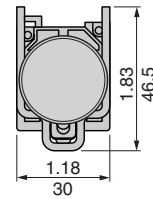

e: Panel thickness, 0.04 to 0.24 in (1 to 6 mm).

Illuminated push buttons Protected LED XB4BW3••5

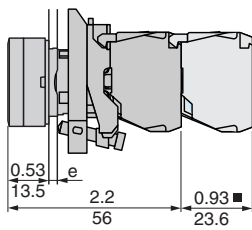

Direct supply XB4BW3•65

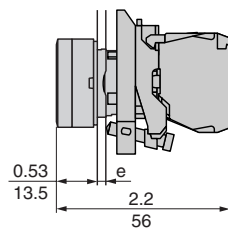

Transformer type XB4BW3••5

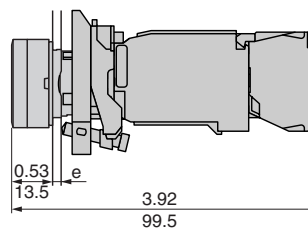

Common face view

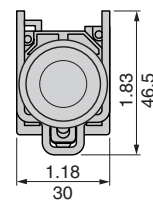

Double headed push buttons with pilot light Protected LED XB4BW84•5

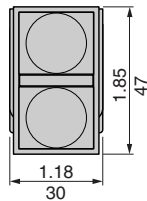
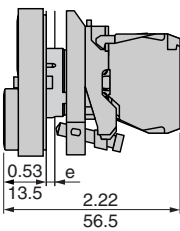

Illuminated selector switches Protected LED XB4BK12••5

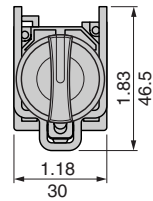
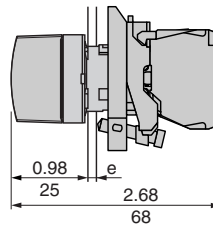

e: Panel thickness, 0.04 to 0.24 in (1 to 6 mm).

■ Can be fitted with additional contact block.

Support panel cut-out (suitable for mounting all types of push buttons and pilot lights)

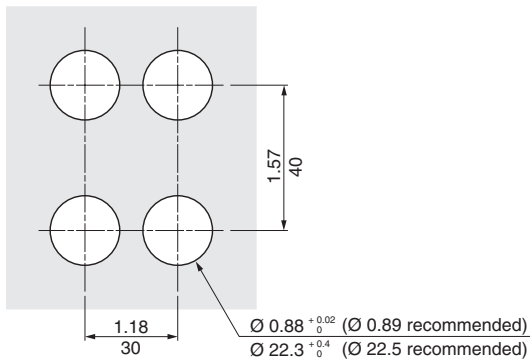

Dual Dimensions $\frac{\text{inches}}{\text{mm}}$

Push Buttons & Operator Interface - XB4 22 mm Die Cast Chrome Plated Dimensions

Heads for push buttons, momentary
ZB4BA•, BA••• **ZB4BL•, BL•••**
ZB4BA•8

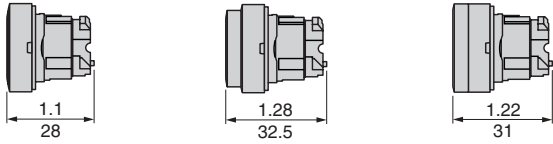

Common face view

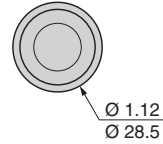

ZB4BP••

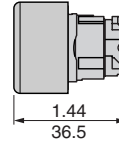

Dual Dimensions $\frac{\text{inches}}{\text{mm}}$

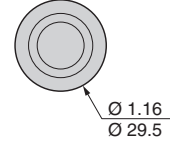

Heads for double-headed push buttons, momentary
ZB4BA81•• **ZB4BL83••**
ZB4BA82•• **ZB4BL84••**

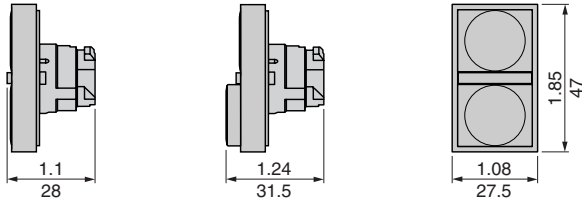

Common face view

ZB4BA91••
ZB4BA92••

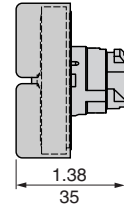

ZB4BL93••
ZB4BL94••

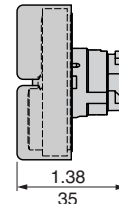

Common face view

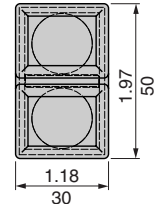

Heads for push buttons
 "Push-push to release"
ZB4BH0•, ZB4BH•

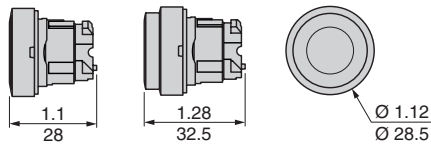

Common face view

Mushroom head
ZB4BC•4

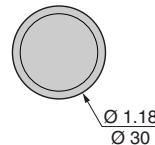
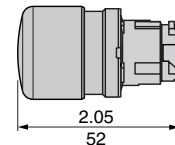

ZB4BC•, BR•

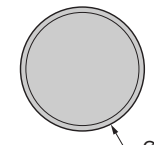
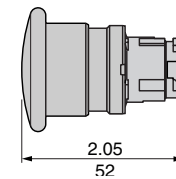

Mushroom heads for push buttons, maintained
 Push-pull
ZB4BT•, BT•4

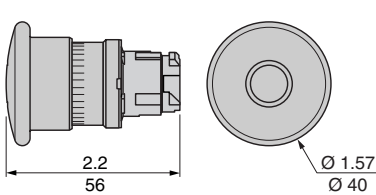

ZB4BX2, BX4

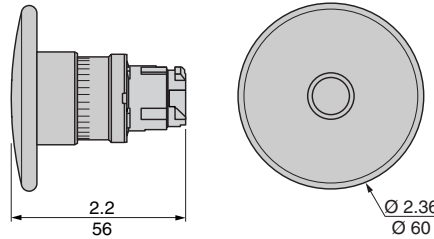

ZB4	Ø
BC•	1.57 in (40 mm)
BR•	2.36 in (60 mm)

Dual Dimensions $\frac{\text{inches}}{\text{mm}}$

Turn to release
ZB4BS4•, BS834

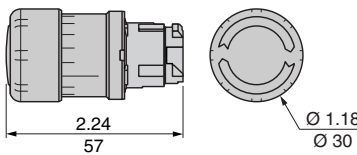

ZB4BS5•, BS844, BS6•

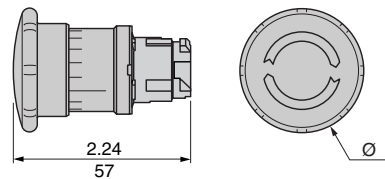

ZB4	Ø
BS5•, BS844	1.57 in (40 mm)
BS6•	2.36 in (60 mm)

Mushroom heads for push buttons, maintained
 Key release
ZB4BS7•, BS934

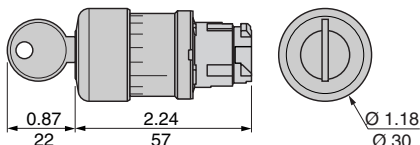

ZB4BS1•, BS2•, BS944, BS964

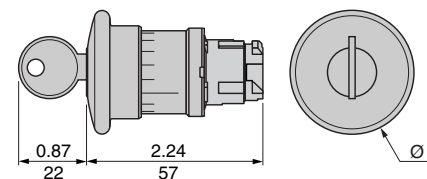

ZB4	Ø
BS1•, BS944	1.57 in (40 mm)
BS2•, BS964	2.36 in (60 mm)

Push Buttons & Operator Interface - XB4 22 mm Die Cast Chrome Plated Dimensions

Heads for selector switches
Standard lever
ZB4BD•

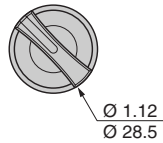
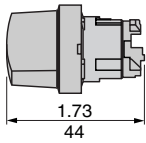

Extended lever
ZB4BJ•

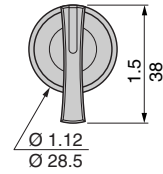
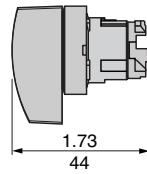

Dual Dimensions $\frac{\text{inches}}{\text{mm}}$

Knurled knob
ZB4BD•9

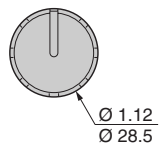
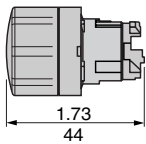

Key switches
ZB4BG•, BG0•

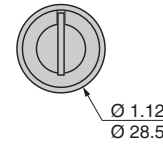
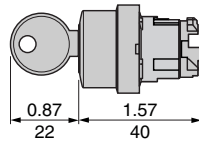

Bodies for push buttons and switches
Screw clamp terminal connections
ZB4BZ10•, BZ141

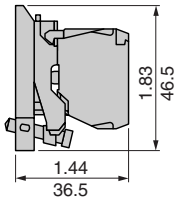

Plug-in connector
ZB4BZ10•4, BZ1414

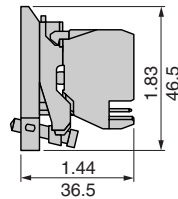

Bodies for pilot lights, plug-in connector
Protected LED
ZB4BV••4

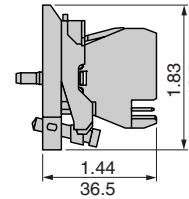

Dual Dimensions $\frac{\text{inches}}{\text{mm}}$

Heads for pilot lights, with light module
Protected LED
ZB4BV0•3

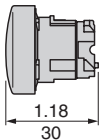

Incandescent, neon or LED
ZB4BV0•

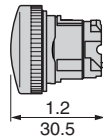

Common face view

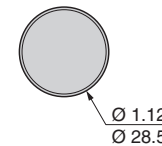

Dual Dimensions $\frac{\text{inches}}{\text{mm}}$

Bodies for pilot lights, screw clamp terminal connections
Protected LED
ZB4BV••

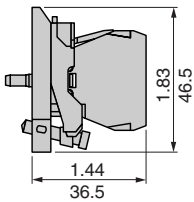

Direct supply, for BA 9s bulb
ZB4BV6

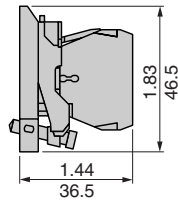

Transformer type, for BA 9s bulb
ZB4BV•, BV•D•

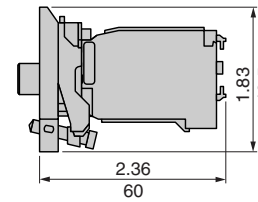

Heads for illuminated push buttons, momentary, for light source
LED

ZB4BW3•3
ZB4BW5•3, BA•8

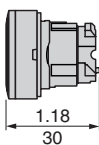

ZB4BW1•3
ZB4BL•8

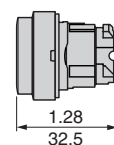

Common face view

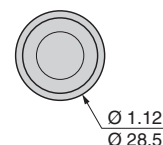

ZB4BW9•3

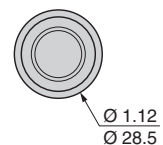
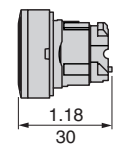

Dual Dimensions $\frac{\text{inches}}{\text{mm}}$

Push Buttons & Operator Interface - XB4 22 mm Die Cast Chrome Plated Dimensions

Incandescent or neon
ZB4BW3•

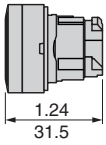

ZB4BW1•

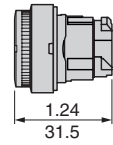

Common face view

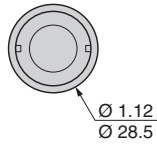

Heads for double-headed push buttons with pilot lights

ZB4BW81•••3
ZB4BW82•••3

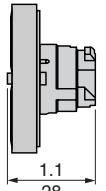

ZB4BW83•••3
ZB4BW84•••3

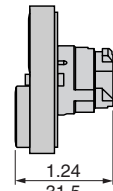

Common face view

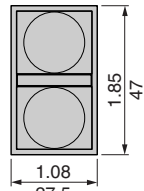

Dual Dimensions $\frac{\text{inches}}{\text{mm}}$

Heads for "push-push to release" illuminated push buttons

ZB4BH0•3

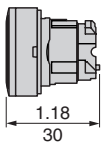

ZB4BH•3

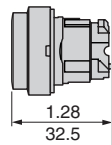

Common face view

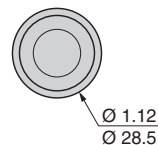

Heads for illuminated selector switches, standard lever

ZB4BK1•••3

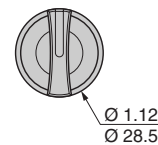
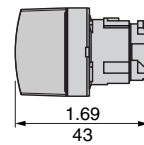

Bodies for illuminated push buttons and selector switches

Screw clamp terminal connections
Protected LED

ZB4BW0•••

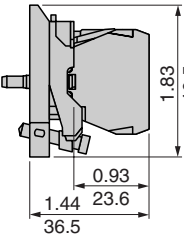

Direct supply
for BA 9s bulb
ZB4BW0••

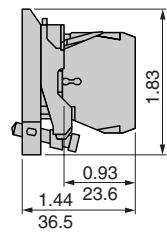

Transformer type
for BA 9s bulb
ZB4BW0••, BW0•D••

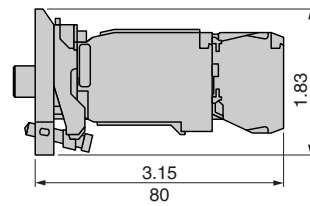

Plug-in connector
Protected LED

ZB4BW0•••4

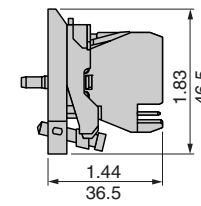

Manual overload reset buttons

XB4BA9••

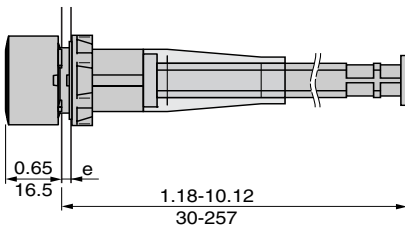

Common face view

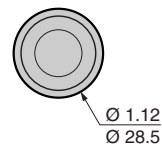

XB4BA8••

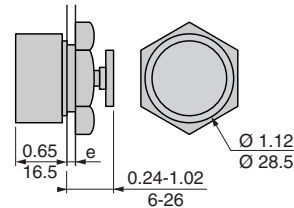

Head + mounting base for potentiometer

ZB4BD9•2

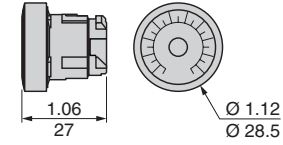

Dual Dimensions $\frac{\text{inches}}{\text{mm}}$

e: Panel thickness, 0.04 to 0.24 in (1 to 6 mm).

Joystick Controller

XD4PA•2

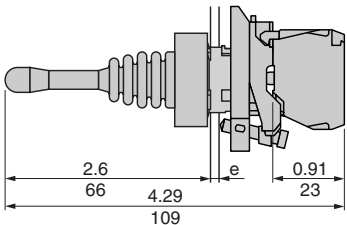

XD4PA•4

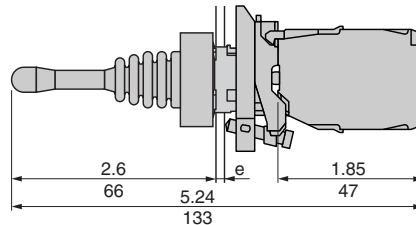

Common face view

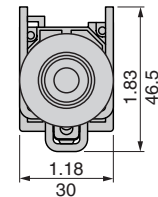

e: Panel thickness, 0.04 to 0.24 in (1 to 6 mm).

Push Buttons and Operator Interface Specifier's Guide

XB5 22 mm Double Insulated

Catalog
2005

File 9001



CONTENTS

Description	Page
General Characteristics	74
Complete Devices	78
Non-Illuminated Operators	81
Two Button Operators	83
Emergency Stop Operators and Yellow Contrast Plates	84
Selector Switches	85
Contact Blocks	86
Specialty Operators	87
Pilot Lights and Light Modules	88
Illuminated Operators	89
Illuminated Selector Switches	91
Light Module Assemblies	92
Light Module Assemblies, Contact Blocks, Plug-In Connector Type	94
Printed Circuit Board (PCB) Components	95
Legend Plates	97
Push Button Caps	100
Accessories and Replacement Parts	101
Dimensions	102
Declaration of Conformity	221



Telemecanique

Push Buttons & Operator Interface - XB5 22 mm Double Insulated

General Characteristics

Components for User Assembly ZB5-B:

- 1 - Electrical Bodies (pre-assembled)
- 2 - Operator Heads (pre-assembled)

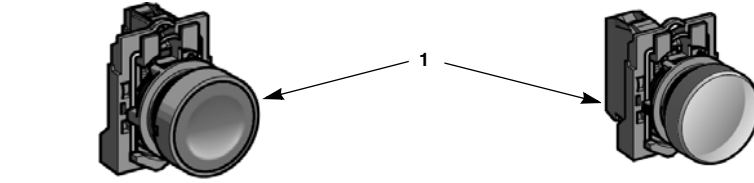

Component Parts and Accessories ZB:

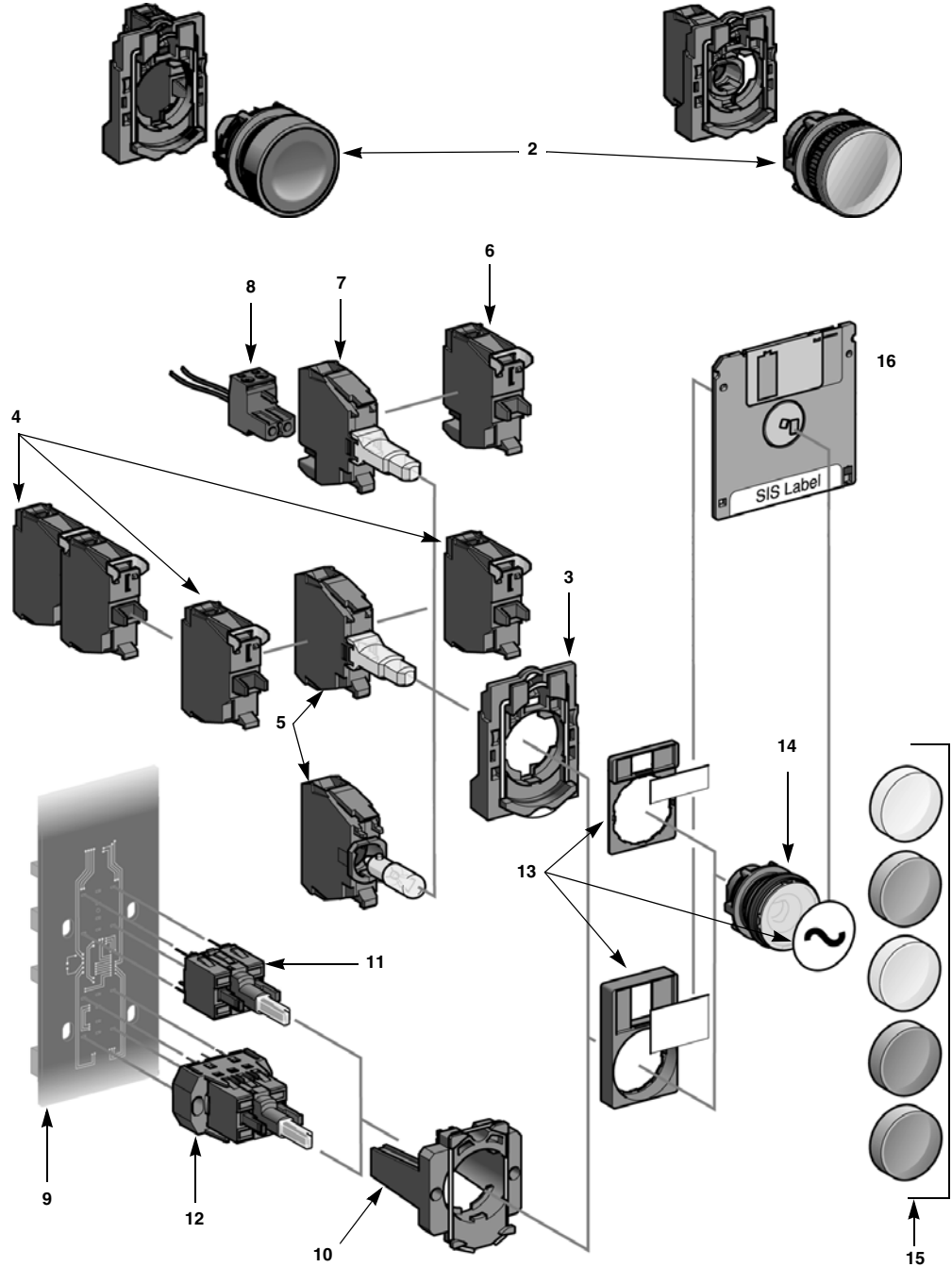

- 3 - Mounting Collar – Standard (ZB5AZ009)
- 4 - Contact Blocks – Screw Clamp Terminal (ZBE10•, ZBE20•)
- 5 - Light Modules – Screw Clamp Terminal (ZBV•) for Protected LED and Ba9 Base Lamps
- 6 - Contact Blocks – Plug-in Connector (ZBE10•)
- 7 - Light Modules – Plug-in Connector (ZBV•) for Protected LED only
- 8 - 2 Pin Connector and Cables for Plug-in Connection Electrical Components (APE1•)
- 9 - Printed Circuit Board (PCB) Application (Typical)
- 10 - Mounting Collar – PCB Application (ZB5BZ009 + ZB4BZ079)
- 11 - Contact Blocks – PCB Application (ZBE70•, ZBE70•6)
- 12 - Light Modules – PCB Application (ZBV•7) for Protected LED only
- 13 - Legend Plates and Holders (ZBY•, ZBZ•)
- 14 - Operator Head – Round or Square (Illuminated or Non-Illuminated)
- 15 - Lenses for Pilot Lights (ZBV•) or Lenses for Illuminated Push Buttons (ZBW•)



Push Buttons & Operator Interface - XB5 22 mm Double Insulated

General Characteristics

Environment

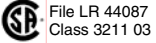
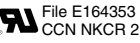
Protective treatment standard version		"TH"
Ambient air temperature around the device	Storage	-40 to +158 °F (- 40 to +70 °C)
	Operation	-13 to +158 °F (- 25 to +70 °C) unless otherwise stated
Electric shock protection	Conforming to IEC 60536	Class II
Degree of protection	Conforming to IEC 60529	IP 65, unless otherwise stated IP 66, for booted push button heads
	Conforming to UL 50 and CSA C22.2 No. 94	Type 1, 2, 3, 4, 4X, 12, and 13, unless otherwise stated
Resistance to high pressure cleaner		1,015 psi (70 x 10 ⁵ Pa-70 bars); distance: 3.94 in (0.1 m) Temperature: 131 °F (55 °C)
Mechanical shock protection	Conforming to EN 50102	Non illuminated heads: IK 03
		Illuminated heads: IK 05
Conforming to standards		IEC 60947-1, IEC/EN 60947-5-1, IEC 60947-5-4, EN 60947-1, JIS C 4520, UL 508, CSA C22.2 No. 14
Product certifications	UL Listed, CSA Certified	Standard single contacts with screw clamp terminals: A600; Q600 Double contacts with screw clamp terminals: A600; Q600 Contacts with "Quick-Connects": A300; Q300 Light modules with screw clamp terminals JOYSTICK XD4-PA: A600; R300
	 File E164353 CCN NKCR  File LR 44087 Class 3211 03  File E164353 CCN NKCR 2	UL Recognized, CSA Certified
	BV, RINA, LROS, DNV, GL (pending)	Standard single contacts for plug-in connector: A300; R300 Standard single contact for printed circuit board: B300; R300
Terminal identification	Conforming to EN 50005 and EN 50013	Standard single contacts and double contacts with screw clamp terminals

Characteristics of Operators and Contact Blocks

Mechanical Characteristics			
Contact operation	N/C or N/O	Slow break	
Positive operation	Conforming to IEC/EN 60947-5-1 Appendix K	All functions incorporating a N/C contact are positive opening operation	
Operating travel (to change electrical state)	Push button	Changing N/C state: 0.06 in (1.5 mm) Changing N/O state: 0.11 in (2.6 mm) Total travel: 0.17 in (4.3 mm)	
Operating force	Push button	Changing N/C state: 0.79 lbf (3.5 N) Changing N/O state: 0.85 lbf (3.8 N)	
	Additional contact (extra to change state)	Single N/C contact: 0.45 lbf (2 N) Single N/O contact: 0.52 lbf (2.3 N) Double contact N/C: 0.76 lbf (3.4 N) Double contact N/O: 1.12 lbf (5 N) Double contact N/C + N/O: 1.03 lbf (4.6 N)	
	Emergency stop with N/C + N/O Maintained mushroom head operators Momentary mushroom head operators	Standard push-pull: 10.12 lbf (45 N) Trigger action push-pull: 11.24 lbf (50 N) Standard turn to release and key release: 8.99 lbf (40 N) Trigger action turn to release and key release: 9.89 lbf (44 N)	
Operating torque (to change electrical state)	Selector switches	N/O contact: 1.24 lb-in (0.14 N•m)	
	Additional contact (extra)	N/O contact: 0.44 lb-in (0.05 N•m)	
Mechanical durability (in operating cycles)	Push button	Momentary	5 million
		Double-headed	1 million
		Push-push to release	500,000
	Selector switches	Non-illuminated	3 million
		Illuminated	1 million
	Toggle switches		500,000
	Emergency stop push button		300,000
	Joystick		1 million
	Standard blocks		5 million
	Low power switching power blocks		500,000
Vibration resistance	Conforming to IEC 60068-2-6	Frequency (2 to 500 Hz): 5 gn	
Shock resistance	Conforming to IEC 60068-2-27	All functions except mushroom head push buttons– Half sine wave acceleration 11 ms: 50 gn Half sine wave acceleration 18 ms: 30 gn	
		Mushroom head push buttons– Half sine wave acceleration 11 ms: 10 gn	

Push Buttons & Operator Interface - XB5 22 mm Double Insulated

General Characteristics

Electrical Characteristics				
Cabling capacity	Conforming to IEC 60947-1	Screw and captive clamp terminals Min: 1 x 24 AWG (0.22 mm ²) without cable end 1 x 22 AWG (0.34 mm ²) for linking Max: 2 x 16 AWG (1.5 mm ²) with cable end 2 x 14 AWG without cable end Cross headed screw (Pozidrive type 1) slotted for flat 4 and 5.5 mm screwdriver Typical torque: 0.8 N•m (8.55 lb-in) Maximum torque: 1.2 N•m (10.7 lb-in)		
Contact material	Silver alloy (Ag/Ni)	Standard single and double blocks with screw clamp terminals Blocks for plug-in connector Standard blocks for printed circuit board connection		
	Gold flashed (Ag/Ni/Au)	Low power switching contact blocks with screw clamp terminals Low power switching contact blocks for printed circuit board connection		
Short-circuit protection	Conforming to IEC/EN 60947-5-1	Standard blocks with screw clamp terminals: 10 A (gG cartridge fuse conforming to IEC 60269-1) Blocks for plug-in connector: 4 A (gG fuse cartridge conforming to IEC 60269-1) Standard blocks for printed circuit board connection: 4 A (gG cartridge fuse conforming to IEC 60269-1)		
Rated insulation voltage	Conforming to IEC 60947-1	Standard blocks (single or double) with screw clamp terminals: Ui = 600 V, degree of pollution 3 Blocks for plug-in connector: Ui = 250 V, degree of pollution 3 Standard blocks for printed circuit board connection: Ui = 250 V, degree of pollution 3		
Rated impulse withstand voltage	Conforming to IEC 60947-1	Standard block (single or double) with screw clamp terminals: Uimp = 6 kV Blocks for plug-in connector: Uimp = 4 kV Standard blocks for printed circuit board connection: Uimp = 4 kV		
Rated operational characteristics Conforming to IEC/EN 60947-5-1	AC supply: Utilization category AC-15	Standard blocks (single or double) with screw clamp terminals: A600: Ue = 600 Vac and Ie = 1.2 A or Ue = 240 Vac and Ie = 3 A or Ue = 120 Vac and Ie = 6 A Continuous thermal current = 10 A Blocks for plug-in connector: A300: Ue = 120 Vac and Ie = 6 A or Ue = 240 Vac and Ie = 3 A Standard blocks for printed circuit board connection: B300: Ue = 120 Vac and Ie = 3 A or Ue = 240 Vac and Ie = 1.5 A		
	DC supply: Utilization category DC-13	Standard single or double blocks with screw clamp terminals: Q600: Ue = 600 Vdc and Ie = 0.1 A or Ue = 250 Vdc and Ie = 0.27 A or Ue = 125 Vdc and Ie = 0.55 A Continuous thermal current = 2.5 A Joystick XD4-PA: R300: Ue = 125 Vdc and Ie = 0.22 A or Ue = 250 Vdc and Ie = 0.1 A Blocks for plug-in connector: R300: Ue = 125 Vdc and Ie = 0.22 A or Ue = 250 Vdc and Ie = 0.1 A Standard blocks for printed circuit board connection: R300: Ue = 125 Vdc and Ie = 0.22 A or Ue = 250 Vdc and Ie = 0.1 A		
Rated operational characteristics	AC supply: Resistive load	Low power switching contact blocks with screw clamp terminals or for printed circuit board connection: Max: 24 Vac Max: 0.1 A		
Electrical durability Conforming to IEC/EN 60947-5-1 Appendix C Operating rate 3600 operating cycles/hour. Load factor: 0.5	AC supply for 1 million operating cycles, utilization category AC-15	Standard blocks for screw clamp terminals:		
		24 Vac	120 Vac	230 Vac
		4 A	3 A	2 A
	DC supply for 1 million operating cycles, utilization category DC-13	Standard double blocks with screw clamp terminal or plug-in connector:		
		24 Vac	120 Vac	230 Vac
		3 A	1.5 A	1 A
Standard single blocks for screw clamp terminals:	24 Vdc	110 Vdc		
	0.5 A	0.2 A		
	Standard double blocks with screw clamp terminal or plug-in connector:			
	24 Vdc	110 Vdc		
0.4 A	0.15 A			
Electrical reliability	Failure rate Conforming to IEC 60947-5-4			
	- In clean environment	Standard blocks: - at 17 V and 5 mA, $\lambda < 10^{-8}$ - at 5 V and 1 mA, $\lambda < 10^{-6}$ Low power switching contact blocks: - at 5 V and 1 mA, $\lambda < 10^{-8}$		
	- In dusty environment	Low power switching contact blocks only: at 5 V and 1 mA, $\lambda < 10^{-6}$		

Push Buttons & Operator Interface - XB5 22 mm Double Insulated

General Characteristics

Characteristics of Light Modules

Mechanical Characteristics		
Vibration resistance	Conforming to IEC 60068-2-6	Frequency (12 to 500 Hz): 5 gn
Shock resistance	Conforming to IEC 60068-2-27	Half sine wave acceleration 11 ms: 50 gn Half sine wave acceleration 18 ms: 30 gn
Electrical Characteristics		
Cabling capacity	Conforming to IEC 60947-1	Screw and captive clamp terminals Min: 1 x 24 AWG (0.22 mm ²) without cable end 1 x 22 AWG (0.34 mm ²) for linking Max: 2 x 16 AWG (1.5 mm ²) with cable end
Rated insulation voltage	Conforming to IEC 60947-1	Direct supply pilot light modules (BA 9s bulbs): Ui = 250 V, degree of pollution 3 Pilot light modules with protected LED: Ui = 250 V, degree of pollution 3 Pilot light modules with transformer: Ui = 600 V, degree of pollution 3
Rated impulse withstand voltage	Conforming to IEC 60947-1	Direct supply pilot light modules (BA 9s bulbs): Uimp = 4 kV Pilot light modules with protected LED: Uimp = 4 kV Pilot light modules with transformer: Uimp = 6 kV

Specific Characteristics of Protected LED Light Modules Only

Voltage limits	Nominal voltage	24 V: 19.2 to 30 Vdc; 21.6 to 24.6 Vac 120 V: 102 to 132 Vac 240 V: 195 to 264 Vac
Current consumption	Applicable to all colors	24 Vac/Vdc supply blocks: 18 mA 120 Vac supply blocks: 14 mA 240 Vac supply blocks: 14 mA
Service life	At nominal voltage and at an ambient temperature of 77 °C (25 °C)	100,000 hours
Surge withstand	Conforming to IEC 61000-4-5	2/1 kV
Resistance to fast transients	Conforming to IEC 61000-4-4	2 kV
Resistance to electromagnetic fields	Conforming to IEC 61000-4-3	10 V/m
Resistance to electrostatic discharges	Conforming to IEC 61000-4-2	8/6 kV
Electromagnetic emission	Conforming to EN 55011	Class B

Specific Characteristics of Hour Counters and Annunciators

Voltage limits	Hour counter and annunciator	± 10% of nominal voltage
Current consumption	Hour counter	XB5DSB: 7 to 15 mA XB5DSG: 8 mA XB5DSM: 8 mA
	Annunciator	5 mA

Push Buttons & Operator Interface - XB5 22 mm Double Insulated Complete Devices



XB5AA31



XB5AA4322



XB5AP51



XB5AA4322



XB5AC21



XB5AL845

Non-Illuminated Push Buttons, Momentary (screw clamp terminal connections)

Shape of Head	Type of Push	Type of Contact		Marking	Color of Cap	Catalog Number
		N/O	N/C			
	Flush	1	-	-	Black Green Yellow Blue	XB5AA21 (ZB5AZ101 + ZB5AA2) XB5AA31 (ZB5AZ101 + ZB5AA3) XB5AA51 (ZB5AZ101 + ZB5AA5) XB5AA61 (ZB5AZ101 + ZB5AA6)
		-	1	-	Red	XB5AA42 (ZB5AZ102 + ZB5AA4)
		1	-	"I" (white)	Green	XB5AA3311 (ZB5AZ101 + ZB5AA331)
		-	1	"O" (white)	Red	XB5AA4322 (ZB5AZ102 + ZB5AA432)
		1	-	-	Black Green Yellow Blue	XB5AP21 (ZB5AZ102 + ZB5AP2) XB5AP31 (ZB5AZ101 + ZB5AP3) XB5AP51 (ZB5AZ101 + ZB5AP5) XB5AP61 (ZB5AZ101 + ZB5AP6)
		-	1	-	Red	XB5AP42 (ZB5AZ102 + ZB5AP4)
	Extended	-	1	-	Red	XB5AL42 (ZB5AZ102 + ZB5AL4)
	Mushroom head Ø 40 mm	1	-	-	Black	XB5AC21 (ZB5AZ101 + ZB5AC2)

Two Button Push Buttons, Momentary (screw clamp terminal connections)

Shape of Head	Type of Push	Type of Contact		Degree of Protection	Catalog Number
		N/O	N/C		
	One flush green push (marked "I") One extended red push (marked "O")	1	1	IP 40	XB5AL845 (ZB5AZ105 + ZB5AL8434)

Push Buttons & Operator Interface - XB5 22 mm Double Insulated Complete Devices

Non-Illuminated Emergency Stop Mushroom Head Push Buttons, Ø 40 mm (Red) (screw clamp terminal connections)



XB5AS9445



XB5AT42



XB5AS542

Shape of Head	Type of Push	Type of Contact		Catalog Number
		N/O	N/C	
	Trigger action push-pull	1	1	XB5AT845 (ZB5AZ105 + ZB5AT84)
	Trigger action turn to release	1	1	XB5AS8445 (ZB5AZ105 + ZB5AS844)
	Trigger action Key release (No. 455)	1	1	XB5AS9445 (ZB5AZ105 + ZB5AS944)
	Push-pull	-	1	XB5AT42 (ZB5AZ102 + ZB5AT4)
	Turn to release	-	1	XB5AS542 (ZB5AZ102 + ZB5AS54)
	Key release (No. 455)	-	1	XB5AS142 (ZB5AZ102 + ZB5AS14)

Non-Illuminated Selector Switches and Key Switches (screw clamp terminal connections)



XB5AD33



XB5AJ33



XB5AG33

Shape of Head	Type of Operator	Type of Contact		Number and Type of Positions	Catalog Number
		N/O	N/C		
	Standard lever, black	1	-	2 - maintained	XB5AD21 (ZB5AZ101 + ZB5AD2)
		2	-	3 - maintained	XB5AD33 (ZB5AZ103 + ZB5AD3)
				3 - momentary to center	XB5AD53 (ZB5AZ103 + ZB5AD5)
	Extended lever, black	1	-	2 - maintained	XB5AJ21 (ZB5AZ101 + ZB5AJ2)
		2	-	3 - maintained	XB5AJ33 (ZB5AZ103 + ZB5AJ3)
				3 - momentary to center	XB5AJ53 (ZB5AZ103 + ZB5AJ5)
	Key (No. 455)	1	-	2 - maintained	XB5AG21 (ZB5AZ101 + ZB5AG2)
					XB5AG41 (ZB5AZ101 + ZB5AG4)
				2 - momentary to left	XB5AG61 (ZB5AZ101 + ZB5AG6)
		2	-		XB5AG03 (ZB5AZ103 + ZB5AG0)
					XB5AG33 (ZB5AZ103 + ZB5AG3)

The symbol indicates key withdrawal position(s).

Push Buttons & Operator Interface - XB5 22 mm Double Insulated Complete Devices

Pilot Lights with Protected LED (screw clamp terminal connections)



XB5AVB1



Shape of Head	Supply Voltage	Color	Catalog Number
	24 Vac/Vdc	White	XB5AVB1 (ZB5AVB1 + ZB5AV013)
		Green	XB5AVB3 (ZB5AVB3 + ZB5AV033)
		Red	XB5AVB4 (ZB5AVB4 + ZB5AV043)
		Yellow	XB5AVB5 (ZB5AVB5 + ZB5AV053)
		Blue	XB5AVB6 (ZB5AVB6 + ZB5AV063)
		110-120 Vac	White
Green	XB5AVG3 (ZB5AVG3 + ZB5AV033)		
Red	XB5AVG4 (ZB5AVG4 + ZB5AV043)		
Yellow	XB5AVG5 (ZB5AVG5 + ZB5AV053)		
Blue	XB5AVG6 (ZB5AVG6 + ZB5AV063)		



XB5AV63

Pilot lights for BA 9s Bulb (screw clamp terminal connections)

Shape of Head	Supply Voltage	Color	Catalog Number
Direct supply, for BA 9s (incandescent, LED, neon) U ≤ 250 V, 2.4 W bulb (bulb not included)			
	≤ 250 Vac/Vdc	White	XB5AV61 (ZB5AV6 + ZB5AV01)
		Green	XB5AV63 (ZB5AV6 + ZB5AV03)
		Red	XB5AV64 (ZB5AV6 + ZB5AV04)
		Yellow	XB5AV65 (ZB5AV6 + ZB5AV05)
Transformer type with 1.2 VA, 6 V secondary. BA 9s incandescent bulb included			
	110-120 Vac 50/60 Hz	White	XB5AV31 (ZB5AV3 + ZB5AV01)
		Green	XB5AV33 (ZB5AV3 + ZB5AV03)
		Red	XB5AV34 (ZB5AV3 + ZB5AV04)
		Yellow	XB5AV35 (ZB5AV3 + ZB5AV05)



XB5AV34

Illuminated Push Buttons, Momentary, Flush (screw clamp terminal connections)



XB5AW31B5



Shape of Head	Description	Type of Contact		Supply Voltage	Color of Push	Catalog Number
		N/O	N/C			
	Protected LED	1	1	24 Vac/Vdc	White	XB5AW31B5 (ZB5AW0B15 + ZB5AW313)
					Green	XB5AW33B5 (ZB5AW0B35 + ZB5AW333)
					Red	XB5AW34B5 (ZB5AW0B45 + ZB5AW343)
					Yellow	XB5AW35B5 (ZB5AW0B55 + ZB5AW353)
					Blue	XB5AW36B5 (ZB5AW0B65 + ZB5AW363)
				110-120 Vac	White	XB5AW31G5 (ZB5AW0G15 + ZB5AW313)
					Green	XB5AW33G5 (ZB5AW0G35 + ZB5AW333)
					Red	XB5AW34G5 (ZB5AW0G45 + ZB5AW343)
					Yellow	XB5AW35G5 (ZB5AW0G55 + ZB5AW353)
					Blue	XB5AW36G5 (ZB5AW0G65 + ZB5AW363)
	Direct supply for BA 9s 2.4 W max. bulb Not included	1	1	≤ 250 Vac/Vdc	White	XB5AW3165 (ZB5AW065 + ZB5AW31)
					Green	XB5AW3365 (ZB5AW065 + ZB5AW33)
					Red	XB5AW3465 (ZB5AW065 + ZB5AW34)
					Yellow	XB5AW3565 (ZB5AW065 + ZB5AW35)
	Transformer type 1.2 VA, 6 V secondary. BA 9s incandescent bulb included	1	1	110-120 Vac 50/60 Hz	White	XB5AW3135 (ZB5AW035 + ZB5AW31)
					Green	XB5AW3335 (ZB5AW035 + ZB5AW33)
					Red	XB5AW3435 (ZB5AW035 + ZB5AW34)
					Yellow	XB5AW3535 (ZB5AW035 + ZB5AW35)
					White	XB5AW3145 (ZB5AW045 + ZB5AW31)
				230-240 Vac 50/60 Hz	Green	XB5AW3345 (ZB5AW045 + ZB5AW33)
					Red	XB5AW3445 (ZB5AW045 + ZB5AW34)
					Yellow	XB5AW3545 (ZB5AW045 + ZB5AW35)



XB5AW3465



XB5AW3335

Push Buttons & Operator Interface - XB5 22 mm Double Insulated Non-Illuminated Operators

Non-Illuminated Operators, Momentary - Unmarked



ZB5AA0



ZB5AA5



ZB5AL3



ZB5AP1



ZB5CA2



ZB5CA5

Shape of Head	Type of Push	Color of Cap	Catalog Number
	Flush, without color cap ■	–	ZB5AA0
	Flush, with set of 6 color caps ▲	6 colors ▲	ZB5AA9
	Flush	White	ZB5AA1
		Black	ZB5AA2
		Green	ZB5AA3
		Red	ZB5AA4
		Yellow	ZB5AA5
		Blue	ZB5AA6
	Grey	ZB5AA8	
	Flush with transparent cap, for insertion of legend ●	White	ZB5AA18
		Green	ZB5AA38
		Red	ZB5AA48
		Yellow	ZB5AA58
	Blue	ZB5AA68	
	Extended	White	ZB5AL1
		Black	ZB5AL2
		Green	ZB5AL3
		Red	ZB5AL4
		Yellow	ZB5AL5
		Blue	ZB5AL6
	Booted (clear) Color of cap unobscured	White	ZB5AP1
		Black	ZB5AP2
		Green	ZB5AP3
		Red	ZB5AP4
		Yellow	ZB5AP5
		Blue	ZB5AP6
	Booted (clear) for insertion of legend ● Color of cap unobscured	White	ZB5AP18
		Green	ZB5AP38
		Red	ZB5AP48
		Yellow	ZB5AP58
	Blue	ZB5AP68	
	Flush Plunger (with high guard)	White	ZB5AA14
		Black	ZB5AA24
		Green	ZB5AA34
		Red	ZB5AA44
		Yellow	ZB5AA54
		Blue	ZB5AA64
	Flush	White	ZB5CA1
		Black	ZB5CA2
		Green	ZB5CA3
		Red	ZB5CA4
		Yellow	ZB5CA5
		Blue	ZB5CA6
	Extended	White	ZB5CL1
		Black	ZB5CL2
		Green	ZB5CL3
		Red	ZB5CL4
		Yellow	ZB5CL5
		Blue	ZB5CL6

■ Color cap to be ordered separately, see page 100.

▲ Six different color caps included with head (white, black, green, red, yellow, blue).

● For legend ordering information see page 99.

Push Buttons & Operator Interface - XB5 22 mm Double Insulated Non-Illuminated Operators

Non-Illuminated Operators, Momentary - Premarked



Shape of Head	Type of Push	Marking Text	Color	Color of Cap	Catalog Number
	Flush	I	White Black	Green White	ZB5AA331 ZB5AA131
		START	White Black	Green White	ZB5AA333 ZB5AA133
		ON	White Black	Green White	ZB5AA341 ZB5AA141
		T	White	Green	ZB5AA345
		O	White	Red Black	ZB5AA432 ZB5AA232
		STOP	White	Red Black	ZB5AA434 ZB5AA234
		OFF	White	Red Black	ZB5AA435 ZB5AA235
		UP	Black	White	ZB5AA343
		DOWN	White	Black	ZB5AA344
		↑ ■	Black White	White Black	ZB5AA334 ZB5AA335
	Extended	O	White	Red Black	ZB5AL432 ZB5AL232
		STOP	White	Red Black	ZB5AL434 ZB5AL234
		OFF	White	Red Black	ZB5AL435 ZB5AL235
	Flush	I	White	Green	ZB5CA331
		O	White	Red	ZB5CA432

■ Cap supplied not clipped-in, allowing orientation of arrow in 4 directions: ↑, ↓, ← or →.

Mushroom Heads, Momentary

Shape of Head	Diameter of Head	Color of Head	Catalog Number
	30 mm	Black	ZB5AC24
		Green	ZB5AC34
		Red	ZB5AC44
		Yellow	ZB5AC54
		Blue	ZB5AC64
	40 mm	Black	ZB5AC2
		Green	ZB5AC3
		Red	ZB5AC4
		Yellow	ZB5AC5
		Blue	ZB5AC6
	60 mm	Black	ZB5AR2
		Green	ZB5AR3
		Red	ZB5AR4
		Yellow	ZB5AR5
		Blue	ZB5AR6

Push Buttons & Operator Interface - XB5 22 mm Double Insulated Non-Illuminated and Two Button Operators

Non-Illuminated Push-On/Push-Off Operators ■



ZB5AH04

Shape of Head	Type of Push	Color of Push	Catalog Number
	Flush	White	ZB5AH01
		Black	ZB5AH02
		Green	ZB5AH03
		Red	ZB5AH04
		Yellow	ZB5AH05
		Blue	ZB5AH06
	Extended	White	ZB5AH1
		Black	ZB5AH2
		Green	ZB5AH3
		Red	ZB5AH4
		Yellow	ZB5AH5
		Blue	ZB5AH6
	Flush	White	ZB5CH01
		Black	ZB5CH02
		Green	ZB5CH03
		Red	ZB5CH04
		Yellow	ZB5CH05
		Blue	ZB5CH06

■ Maximum of 1 row of 3 contact blocks on associated body/mounting collar sub-assembly.



ZB5AL8334



ZB5AL8434



ZB5AL9334

Two Head Operators, Momentary

Shape of Head	Description	Color of Pushes	Degree of Protection	Catalog Number
No Markings				
	Two flush	Green Red	IP 40	ZB5AA8134
			IP 66	ZB5AA9134
		White Black	IP 40	ZB5AA8112
			IP 66	ZB5AA9112
	One flush One extended	Green Red	IP 40	ZB5AL8334
			IP 66	ZB5AL9334
		White Black	IP 40	ZB5AL8312
			IP 66	ZB5AL9312
Premarked				
	Two flush (marked "I") (marked "O")	Green Red	IP 40	ZB5AA8234
			IP 66	ZB5AA9234
		White Black	IP 40	ZB5AA8212
			IP 66	ZB5AA9212
	One flush (marked "I") One extended (marked "O")	Green Red	IP 40	ZB5AL8434
			IP 66	ZB5AL9434
		White Black	IP 40	ZB5AL8412
			IP 66	ZB5AL9412

Push Buttons & Operator Interface - XB5 22 mm Double Insulated Emergency Stop Operators and Yellow Contrast Plates

Mushroom Heads for Maintained Push Buttons



ZB5AS844



ZB5AS934



ZB5AT4



ZB5AS54



ZB5AS64



ZBY9330

Shape of Head	Type of Push	Diameter of Head	Color	Catalog Number	
	Trigger action Push-pull ▲	40 mm	Red	ZB5AT84	
	Trigger action Turn to release ▲	30 mm	Red	ZB5AS834	
		40 mm	Red	ZB5AS844	
	Trigger action Key release (No. 455) ▲	30 mm	Red	ZB5AS934	
		40 mm	Red	ZB5AS944 ■	
		60 mm	Red	ZB5AS964	
	Push-pull	30 mm	Black	ZB5AT24	
			Red	ZB5AT44	
		40 mm	Black	ZB5AT2	
			Red	ZB5AT4	
			Black	ZB5AX2	
			Red	ZB5AX4	
	Turn to release	30 mm	Black	ZB5AS42	
			Red	ZB5AS44	
		40 mm	Black	ZB5AS52	
			Red	ZB5AS54	
			Yellow	ZB5AS55	
			60 mm	Black	ZB5AS62
Red	ZB5AS64				
	Key release (No. 455)	30 mm	Black	ZB5AS72	
			Red	ZB5AS74	
		40 mm	Black	ZB5AS12	
			Red	ZB5AS14 ▲	
			60 mm	Black	ZB5AS22
				Red	ZB5AS24

■ Other key numbers:

- key No. 421E: add the suffix 12 to the reference.
- key No. 458A: add the suffix 10 to the reference.
- key No. 520E: add the suffix 14 to the reference.
- key No. 3131A: add the suffix 20 to the reference.

Example:

The reference for a Ø 40 mm red mushroom head for a trigger action, maintained push button, with release by key No. 421E becomes: ZB5AS94412.

▲ Maximum number of contact blocks fitted to associated body: 4.

Circular Legends for Emergency Stop Mushroom Heads (yellow background)

Diameter	Text	Catalog Number
60 mm	Blank	ZBY9101
	EMERGENCY STOP	ZBY9330
90 mm	Blank	ZBY8101
	EMERGENCY STOP	ZBY8330

Push Buttons & Operator Interface - XB5 22 mm Double Insulated Selector Switches

Non-Illuminated Selector Switches ■ ▲



Shape of Head	Type of Operator	Number and Type of Positions		Catalog Number		
	Standard lever, black For colored lever add the following code to the end of the part number: 01 - white 03 - green 04 - red 05 - yellow 06 - blue (example ZB5AD204)	2 - maintained		ZB5AD2		
		2 - momentary from right to left		ZB5AD4		
		3 - maintained		ZB5AD3		
		3 - momentary to center		ZB5AD5		
		3 - momentary from left to center		ZB5AD7		
		3 - momentary from right to center		ZB5AD8		
			Extended lever, black	2 - maintained		ZB5AJ2
				2 - momentary from right to left		ZB5AJ4
3 - maintained				ZB5AJ3		
3 - momentary to center				ZB5AJ5		
3 - momentary from left to center				ZB5AJ7		
3 - momentary from right to center				ZB5AJ8		

Non-Illuminated Key Switches ■



Shape of Head	Type of Operator	Number and Type of Positions ▲		Catalog Number ●
	Key (No. 455)	2 - maintained		ZB5AG2
				ZB5AG4
		2 - momentary from right to left		ZB5AG6
			3 - maintained	
				ZB5AG3
				ZB5AG5
				ZB5AG9
				ZB5AG09
				ZB5AG9
		3 - momentary from left to center		ZB5AG1
		3 - momentary to center		ZB5AG7
		3 - momentary from right to center		ZB5AG8
	ZB5AG08			

The symbol indicates key withdrawal position(s).

- For actuation of outside contacts only.
- ▲ See selector switch sequence charts on page 91.
- Other key numbers:
 - key No. 421E: add the suffix 12 to the reference.
 - key No. 458A: add the suffix 10 to the reference.
 - key No. 520E: add the suffix 14 to the reference.
 - key No. 3131A: add the suffix 20 to the reference.

Example:

The catalog number for a head with key No. 421E for a 2 position maintained, lockable selector switch, with key withdrawal from the left-hand position, becomes: ZB5AG212.

Push Buttons & Operator Interface - XB5 22 mm Double Insulated Contact Blocks



ZB5AZ101



ZB5AZ102



ZBE101



ZBE102



ZBE203



ZBE204



ZB5AZ009

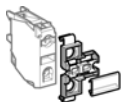

ZBZ001

Contact Blocks (Mounting Base with Contact Blocks)

Description	Type of Contact		Catalog Number
	N/O	N/C	
Screw clamp terminal connections	1	–	ZB5AZ101
	–	1	ZB5AZ102
	2	–	ZB5AZ103
	–	2	ZB5AZ104
	1	1	ZB5AZ105
Gold-Flashed Low Power Switching (5 - 24 V, 0.1 - 100 mA) Dust Protected (IP5x per IEC 60529)	1	–	ZB5AZ1016
	–	1	ZB5AZ1026
	2	–	ZB5AZ1036
	–	2	ZB5AZ1046
	1	1	ZB5AZ1056
Quick-Connect (1 x 0.250" or 2 x 0.110")	1	–	ZB5AZ1013
	–	1	ZB5AZ1023
	2	–	ZB5AZ1033
	–	2	ZB5AZ1043
	1	1	ZB5AZ1053
Ring Tongue Compatible (# 8 stud, ≤ 5.8 mm width)	1	–	ZB5AZ1019
	–	1	ZB5AZ1029

Add-On Contact Block (with screw clamp terminal connections) ■

Description	Type of Contact		Catalog Number
	N/O	N/C	
Standard single contact blocks	1	–	ZBE101
	–	1	ZBE102
Standard double contact blocks	2	–	ZBE203
	–	2	ZBE204
	1	1	ZBE205
Special contact blocks (for low power switching and dust protected) ▲	1	–	ZBE1016
	–	1	ZBE1026

Specialty Add-On Contact Blocks

Quick-Connect (1 x 0.250" or 2 x 0.110")	1	–	ZBE1013
	–	1	ZBE1023
Ring Tongue Compatible (# 8 stud, ≤ 5.8 mm width)	1	–	ZBE1019
	–	1	ZBE1029

Body/Mounting Collar

For use with	Catalog Number
Electrical block (contact or light module)	ZB5AZ009

Clip-on Legend Holders for Electrical Blocks (Contact Blocks and Light Modules) (with screw clamp terminal connections)

Identification of an XB5A control or signalling unit	ZBZ001
--	--------

Sheet of 50 Blank Legends

Legend holder ZBZ001	ZBY001
----------------------	--------

- The contact blocks enable variable composition of body sub-assemblies and can be stacked to 3 rows, either: 3 rows of 3 single contacts or 1 row of 3 double contacts + 1 row of 3 single contacts (double contact blocks occupy 2 rows).
- ▲ Cannot stack additional contact blocks onto these blocks.

Push Buttons & Operator Interface - XB5 22 mm Double Insulated Specialty Operators

Reset Operators



XB5AA

Shape of Head	Actuation Distance	Text	Color	Catalog Number
Flush				
Adjustable Shaft				
	0.67-4.72 in (17-120 mm)	Without	Green	XB5AA831
			Red	XB5AA841
			Blue	XB5AA861
	4.72-10.12 in (120-257 mm)	O	Red	XB5AA84101
		R	Blue	XB5AA86102
			Green	XB5AA832
		Red	XB5AA842	
		Blue	XB5AA862	
	O	Red	XB5AA84201	
	R	Blue	XB5AA86202	
Extended				
	0.67-4.72 in (17-120 mm)	O	Red	XB5AL84101
	4.72-10.12 in (120-257 mm)	O	Red	XB5AL84201

Potentiometer Operator (with Mounting Collar)



XD5PA12

Shape of Head	Description	Application	Catalog Number
	For potentiometer with shaft length 1.73 to 1.97 in (44 to 50 mm) (potentiometer not included)	For shaft Ø 0.25 in (6.35 mm)	ZB5AD922

Joystick Controllers (54 mm, Extended Operating Shaft) ■ *

Description	Operation	Action	Catalog Number
2 direction 	1 step 1 N/O contact per direction	Maintained	XD5PA12
		Momentary	XD5PA22
4 direction 	1 step 1 N/O contact per direction	Maintained	XD5PA14
		Momentary	XD5PA24

■ It is not permissible to use standard contact blocks ZBE100(single) or ZBE20* (double).

* For legend plates see page 52.



XB5DS•

Hour Counters ▲

Characteristics	Supply Voltage	Catalog Number
Indication 0-9999.9	12-24 Vdc or Vac, 50/60 Hz	XB5DSB
	120 Vac, 60 Hz	XB5DSG
	230-240 Vac, 50 Hz	XB5DSM



XB5KS•

Buzzer ▲

Characteristics	Supply Voltage	Catalog Number
80 db buzzer, continuous or intermittent (IP 40 NEMA 1)	12-24 Vdc or Vac, 50/60 Hz	XB5KSB
	120 Vac, 60 Hz	XB5KSG
	230-240 Vac, 50 Hz	XB5KSM

▲ UR Pending



ZB5AD28

Two Position Toggle Switch

Shape of Head	Color	Type of Positions	Catalog Number
	Black	Maintained	ZB5AD28
		Momentary	ZB5AD48

Push Buttons & Operator Interface - XB5 22 mm Double Insulated Pilot Lights and Light Modules



ZB5AV053



ZB5AV01



ZB5CV063



ZB5AV6





ZB5AV3



ZB5AV**

Pilot Light Heads

Shape of Head	For Use with Body Comprising Light Source Type	Color of Lens	Catalog Number
	Protected LED only	White	ZB5AV013
		Green	ZB5AV033
		Red	ZB5AV043
		Yellow	ZB5AV053
		Blue	ZB5AV063
	Protected LED only Fresnel lens	White	ZB5AV013S
		Green	ZB5AV033S
		Red	ZB5AV043S
		Yellow	ZB5AV053S
		Blue	ZB5AV063S
	For BA 9s incandescent bulb, neon or LED only	White	ZB5AV01
		Green	ZB5AV03
Red		ZB5AV04	
Yellow		ZB5AV05	
Blue		ZB5AV06	
Clear		ZB5AV07	
	Protected LED only	White	ZB5CV013
		Green	ZB5CV033
		Red	ZB5CV043
		Yellow	ZB5CV053
		Blue	ZB5CV063

Complete Bodies (Mounting Collar + Light Module for BA 9s Incandescent Bulb, Neon or LED)

Description	Light Source	Supply Voltage	Catalog Number
Screw clamp terminal connections ▼			
Direct supply	BA 9s bulb 2.4 W max. Not included ■	≤ 250 Vac or Vdc	ZB5AV6
Transformer type 1.2 VA, 6 V secondary	BA 9s incandescent bulb included	110-120 Vac, 50/60 Hz	ZB5AV3
		230-240 Vac, 50/60 Hz	ZB5AV4
		400-50 Hz	ZB5AV5
		440-480 Vac, 60 Hz	ZB5AV8
		550-600 Vac, 60 Hz	ZB5AV9

■ Bulb can be ordered separately, see page 101, or add voltage (24, 120) for bulb supplied.

Complete Bodies (Mounting Collar + Light Module with Protected LED)

Light Source	Supply Voltage	Color of Light Source	Catalog Number
Screw clamp terminal connections ▼			
	24 Vac or Vdc	White	ZB5AVB1
		Green	ZB5AVB3
		Red	ZB5AVB4
		Yellow	ZB5AVB5
		Blue	ZB5AVB6
		110-120 Vac	White
Green	ZB5AVG3		
Red	ZB5AVG4		
Yellow	ZB5AVG5		
Blue	ZB5AVG6		

▼ For "Quick-Connect" version, add 3 to the end of the part number (Example: ZB5AV63) (1 x 0.250" or 2 x 0.110").

Push Buttons & Operator Interface - XB5 22 mm Double Insulated Illuminated Operators

Heads for Momentary Illuminated Push Buttons



ZB5AW313



ZB5AW363











ZB5AW143



ZB5CW113







ZB5AW33

Shape of Head	Type of Push	Color	Catalog Number
Only use with protected LED light modules			
	Flush	White	ZB5AW313
		Green	ZB5AW333
		Red	ZB5AW343
		Yellow	ZB5AW353
		Blue	ZB5AW363
	Flush with clear boot	White	ZB5AW513
		Green	ZB5AW533
		Red	ZB5AW543
		Yellow	ZB5AW553
		Blue	ZB5AW563
	Flush for insertion of legend (lens supplied (not installed))	White	ZB5AA18
		Green	ZB5AA38
		Red	ZB5AA48
		Yellow	ZB5AA58
		Blue	ZB5AA68
	Extended	White	ZB5AW113
		Green	ZB5AW133
		Red	ZB5AW143
		Yellow	ZB5AW153
		Blue	ZB5AW163
	Mushroom (40 mm)	Green	ZB5AW433
		Red	ZB5AW443
		Yellow	ZB5AW453
		Blue	ZB5AW463
		Clear	ZB5AW473
	Flush for insertion of legend	White	ZB5CW313
		Green	ZB5CW333
		Red	ZB5CW343
		Yellow	ZB5CW353
		Blue	ZB5CW363
	Extended	White	ZB5CW113
		Green	ZB5CW133
		Red	ZB5CW143
		Yellow	ZB5CW153
		Blue	ZB5CW163
Only use with light modules for a BA 9s incandescent bulb, neon or LED			
	Flush	White	ZB5AW31
		Green	ZB5AW33
		Red	ZB5AW34
		Yellow	ZB5AW35
		Blue	ZB5AW36
		Clear	ZB5AW37
	Extended	White	ZB5AW11
		Green	ZB5AW13
		Red	ZB5AW14
		Yellow	ZB5AW15
		Blue	ZB5AW16
		Clear	ZB5AW17

Push Buttons & Operator Interface - XB5 22 mm Double Insulated Illuminated Operators

Two Button with Pilot Light, Momentary (IP 40) ■ ▲

Shape of Head	Description	Color of Pushes	Color of Pilot Light	Catalog Number
Only use with protected LED light modules (protected LED determines pilot light color)				
	1 flush 1 central pilot light 1 flush	Black	Clear	ZB5AW812743
		Red		
		Green		
		Red	Clear	ZB5AW813743
Black				
	1 flush 1 central pilot light 1 extended	Black	Clear	ZB5AW832743
		Red		
		Green		
		Red	Clear	ZB5AW833743
Black				
Only use with protected LED light modules (protected LED determines pilot light color) - premarked				
	1 flush (marked "I") 1 central pilot light 1 flush (marked "O")	Black	Clear	ZB5AW822743
		Red		
		Green		
		Red	Clear	ZB5AW823743
Black				
	1 flush (marked "I") 1 central pilot light 1 extended (marked "O")	Black	Clear	ZB5AW842743
		Red		
		Green		
		Red	Clear	ZB5AW843743
Black				



ZB5AW833743



ZB5AW823743



ZB5AW843743



Heads for Maintained Illuminated Push Buttons

Shape of Head	Type of Push	Color	Catalog Number
Only use with protected LED light modules			
	Turn to Release Mushroom (40 mm)	Green	ZB5AW733
		Red	ZB5AW743
		Yellow	ZB5AW753
		Blue	ZB5AW763
		Clear	ZB5AW773



ZB5AW753

Illuminated "Push-on/Push-off" Operators ●

Shape of Head	Type of Push	Color of Lens	Catalog Number
Only use with protected LED light modules			
	Flush	White	ZB5AH013
		Green	ZB5AH033
		Red	ZB5AH043
		Yellow	ZB5AH053
		Blue	ZB5AH063
	Extended	White	ZB5AH13
		Green	ZB5AH33
		Red	ZB5AH43
		Yellow	ZB5AH53
		Blue	ZB5AH63

- For IP 66 degree of protection, install clear sealing boot ZBW008, see page 102.
- ▲ Color of centrally positioned pilot light determined by the color of the LED incorporated in the body sub-assembly.
- Maximum of 1 row of 2 contact blocks on associated body/mounting collar sub-assembly.

Push Buttons & Operator Interface - XB5 22 mm Double Insulated Illuminated Selector Switches

Illuminated Selector Switches, Standard Lever



ZB5AK1213



ZB5AK1463

Shape of Head	Number and Type of Positions	Color of Lever	Catalog Number
Only for use with protected LED light modules			
	2 - maintained 	White Green Red Yellow Blue	ZB5AK1213 ZB5AK1233 ZB5AK1243 ZB5AK1253 ZB5AK1263
	2 - momentary from right to left 	White Green Red Yellow Blue	ZB5AK1413 ZB5AK1433 ZB5AK1443 ZB5AK1453 ZB5AK1463
	3 - maintained 	White Green Red Yellow Blue	ZB5AK1313 ZB5AK1333 ZB5AK1343 ZB5AK1353 ZB5AK1363
	3 - momentary to center 	White Green Red Yellow Blue	ZB5AK1513 ZB5AK1533 ZB5AK1543 ZB5AK1553 ZB5AK1563
	3 - momentary from right to center 	White Green Red Yellow Blue	ZB5AK1813 ZB5AK1833 ZB5AK1843 ZB5AK1853 ZB5AK1863
	3 - momentary from left to center 	White Green Red Yellow Blue	ZB5AK1713 ZB5AK1733 ZB5AK1743 ZB5AK1753 ZB5AK1763



Selector Switch Sequence (using contact block assemblies, page 86; or complete bodies, page 92)

2 Position Selector Switch		
		Contact block guide
O	X	1 N.O. (left or right)
X	O	1 N.C. (left or right)
O	X	1 N.O. and
X	O	1 N.C.

3 Position Selector Switch			
			Contact block guide
X	O	O	1 N.O. (left)
O	X	O	2 N.C. wired in SERIES, (left and right)
O	O	X	1 N.O. (right)
X	X	O	1 N.C. (right)
O	X	X	1 N.C. (left)
X	O	X	2 N.O. wired in PARALLEL, (left and right)

Push Buttons & Operator Interface - XB5 22 mm Double Insulated Light Module Assemblies

Complete Bodies (Mounting Collar + Single Contact Block + Light Module with Protected LED)

Light Source	Supply Voltage	Type of Contact ■		Color	Catalog Number
		N/O	N/C		
Screw clamp terminal connections					
Protected LED 	24 Vac or Vdc	1	-	White	ZB5AW0B11
				Green	ZB5AW0B31
				Red	ZB5AW0B41
				Yellow	ZB5AW0B51
				Blue	ZB5AW0B61
		-	1	White	ZB5AW0B12
				Green	ZB5AW0B32
				Red	ZB5AW0B42
				Yellow	ZB5AW0B52
				Blue	ZB5AW0B62
		2	-	White	ZB5AW0B13
				Green	ZB5AW0B33
				Red	ZB5AW0B43
				Yellow	ZB5AW0B53
				Blue	ZB5AW0B63
		1	1	White	ZB5AW0B15
Green	ZB5AW0B35				
Red	ZB5AW0B45				
Yellow	ZB5AW0B55				
Blue	ZB5AW0B65				
Protected LED 	110-120 Vac	1	-	White	ZB5AW0G11
				Green	ZB5AW0G31
				Red	ZB5AW0G41
				Yellow	ZB5AW0G51
				Blue	ZB5AW0G61
		-	1	White	ZB5AW0G12
				Green	ZB5AW0G32
				Red	ZB5AW0G42
				Yellow	ZB5AW0G52
				Blue	ZB5AW0G62
		2	-	White	ZB5AW0G13
				Green	ZB5AW0G33
				Red	ZB5AW0G43
				Yellow	ZB5AW0G53
				Blue	ZB5AW0G63
		1	1	White	ZB5AW0G15
Green	ZB5AW0G35				
Red	ZB5AW0G45				
Yellow	ZB5AW0G55				
Blue	ZB5AW0G65				



ZB5AW0**1

■ Can be fitted with additional contact blocks, see below.

Contact Block and Light Module (with screw clamp terminal connections) ▲

Supply	Light Source	Supply Voltage	Type of Contact ▲		Color of Light Source	Catalog Number
			N/O	N/C		
Screw clamp terminal connections						
Direct supply	BA 9s 2.4 W max. bulb Not included ●	≤ 250 Vac or Vdc	1	-	-	ZB5AW061
			-	1	-	ZB5AW062
			2	-	-	ZB5AW063
			1	1	-	ZB5AW065
Transformer type 1.2 VA, 6 V secondary	BA 9s incandescent bulb included	110-120 Vac 50/60 Hz	1	-	-	ZB5AW031
			1	1	-	ZB5AW035
		230-240 Vac 50/60 Hz	1	-	-	ZB5AW041
			1	1	-	ZB5AW045
		400 Vac 50 Hz	1	-	-	ZB5AW051
			1	1	-	ZB5AW055



ZB5AW065



ZB5AW035

▲ Can be fitted with additional contact blocks, page 93.

● Bulb can be ordered separately, page 101, or add voltage (24, 120) for bulb supplied.

Push Buttons & Operator Interface - XB5 22 mm Double Insulated Light Module Assemblies

Light Modules (with screw clamp terminal connections) ▼



ZBVB•



ZBE101



ZBE102

Description	Supply Voltage	Color of Light Source	Catalog Number
Protected LED Protected LED	24 Vac or Vdc	White	ZBVB1
		Green	ZBVB3
		Red	ZBVB4
		Yellow	ZBVB5
		Blue	ZBVB6
		110-120 Vac	White
Green	ZBVG3		
Red	ZBVG4		
Yellow	ZBVG5		
Blue	ZBVG6		
230-240 Vac	White		ZBVM1
	Green	ZBVM3	
	Red	ZBVM4	
	Yellow	ZBVM5	
	Blue	ZBVM6	
	Direct supply for BA 9s 2.4 W max. bulb Not included ■	≤ 250 Vac or Vdc	–

■ Bulb can be ordered separately, see page 101, or add voltage (24, 120) for bulb supplied.

Add-On Contact Block (with screw clamp terminal connections) ▲ *



ZBE203



ZBE204

Description	Type of Contact		Catalog Number
	N/O	N/C	
Standard single contact blocks	1	–	ZBE101
	–	1	ZBE102
Standard double contact blocks	2	–	ZBE203
	–	2	ZBE204
	1	1	ZBE205
Special contact blocks (for low power switching and dust protected) ●	1	–	ZBE1016
	–	1	ZBE1026

Body/Mounting Collar

For use with	Catalog Number
Electrical block (contact or light module)	ZB5AZ009

Clip-on Legend Holders for Electrical Blocks (Contact Blocks and Light Modules)

(with screw clamp terminal connections)



ZB5AZ009

Identification of an XB5A control or signalling unit	ZBZ001
--	--------

Sheet of 50 Blank Legends

Legend holder ZBZ001	ZBY001
----------------------	--------

- ▲ The contact blocks enable variable composition of body sub-assemblies and can be stacked to 3 rows, either: 3 rows of 3 single contacts or 1 row of 3 double contacts + 1 row of 3 single contacts (double contact blocks occupy 2 rows).
- Cannot stack additional contact blocks onto these blocks.
- ▼ For "Quick-Connect" options see page 88.
- * For "Quick-Connect" options see page 86.

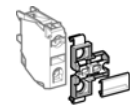

ZBZ001

Push Buttons & Operator Interface - XB5 22 mm Double Insulated Light Module Assemblies, Contact Blocks, Plug-In Connector Type

Contact Blocks (Mounting Base with Contact Blocks)



ZB5AZ1014

Description	Type of Contact		Catalog Number
	N/O	N/C	
Plug-in connector	1	–	ZB5AZ1014
	–	1	ZB5AZ1024
	2	–	ZB5AZ1034
	–	2	ZB5AZ1044
	1	1	ZB5AZ1054
	1	2	ZB5AZ1414



ZB5AZ1024

Contact Blocks for Plug-in Connector

Description	Type of Contacts		Catalog Number
	N/O	N/C	
Standard contact blocks	1	–	ZBE1014
	–	1	ZBE1024



ZBE1014

Light Modules for Plug-in Connector

Description	Supply Voltage	Color of Light Source	Catalog Number
Protected LED 	24 Vac or Vdc	White	ZBVB14
		Green	ZBVB34
		Red	ZBVB44
		Yellow	ZBVB54
		Blue	ZBVB64
	110-120 Vac	White	ZBVG14
		Green	ZBVG34
		Red	ZBVG44
		Yellow	ZBVG54
		Blue	ZBVG64
230-240 Vac	White	ZBVM14	
	Green	ZBVM34	
	Red	ZBVM44	
	Yellow	ZBVM54	
	Blue	ZBVM64	



ZBE1024



ZBVB*4

Connecting Cables and Connector

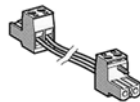

APE1C2250

Description	Number of Connector	Wire c.s.a	Length	Catalog Number
Connecting cable with 2-pin connector 0.20 in (5.08 mm)	1	#18 AWG (0.75 mm ²)	19.69 in (500 mm)	APE1C2150
	2	#18 AWG (0.75 mm ²)	19.69 in (500 mm)	APE1C2250
Self-stripping connector	–	#18 AWG (0.75 mm ²)	–	APE1PAD21



APE1PAD21

Push Buttons & Operator Interface - XB5 22 mm Double Insulated Printed Circuit Board (PCB) Components



ZBE701



ZBE702

Contact Blocks for Printed Circuit Board (PCB) Connection ■

Description	Type of Contacts		Catalog Number
	N/O	N/C	
Standard contact blocks	1	–	ZBE701
	–	1	ZBE702
Special contact blocks (for low power switching and dust protected)	1	–	ZBE7016
	–	1	ZBE7026

Protected LED Light Modules for Printed Circuit Board (PCB) Connection ■



ZBVB-7

Description	Supply Voltage	Color of Light Source	Catalog Number
Protected LED Protected LED (For heads with protected LED, see page 88.)	24 Vac or Vdc	White	ZBVB17
		Green	ZBVB37
		Red	ZBVB47
		Yellow	ZBVB57
		Blue	ZBVB67



ZB5AZ009

Adaptor (socket) for Printed Circuit Board (PCB)

For use with	Catalog Number
Electrical block (contact or light module)	ZBZ010



ZB5AZ079

Body/Mounting Collar

For use with	Catalog Number
Electrical block (contact or light module)	ZB5AZ009

Accessories Specifically for Printed Circuit Boards (PCB) Connection

Description	Application	Catalog Number
Pillar	Printed circuit board support	ZB5AZ079
Mounting screw for printed circuit board	Pillar (ZB5AZ079)	ZBZ006

■ For detail of support drilling and printed circuit board, see page 96. Must be used in conjunction with ZBZ010 adaptor (socket).



ZBZ010

Push Buttons & Operator Interface - XB5 22 mm Double Insulated Printed Circuit Board (PCB) Components

Connecting Control Units to Printed Circuit Boards (PCB) Panel drilling

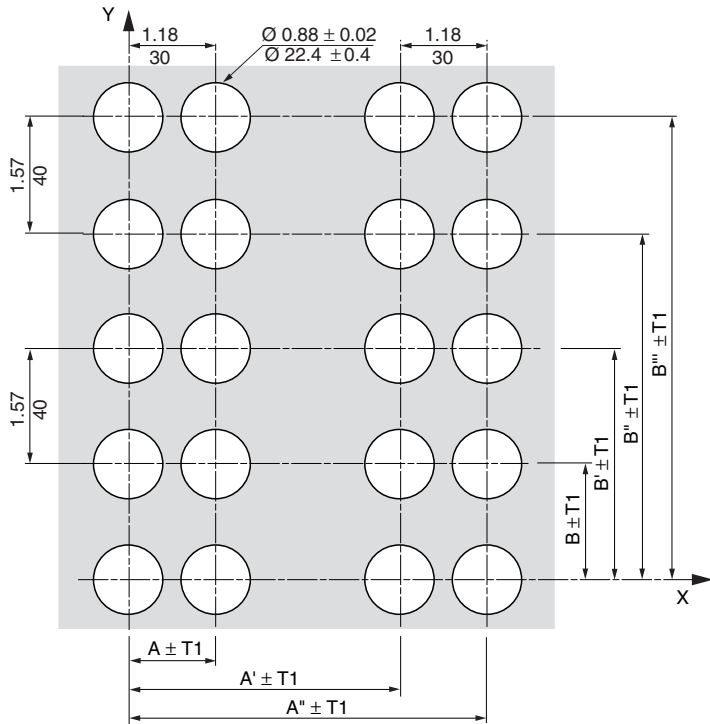

Printed Circuit Board Drillings (viewed from electrical block side)

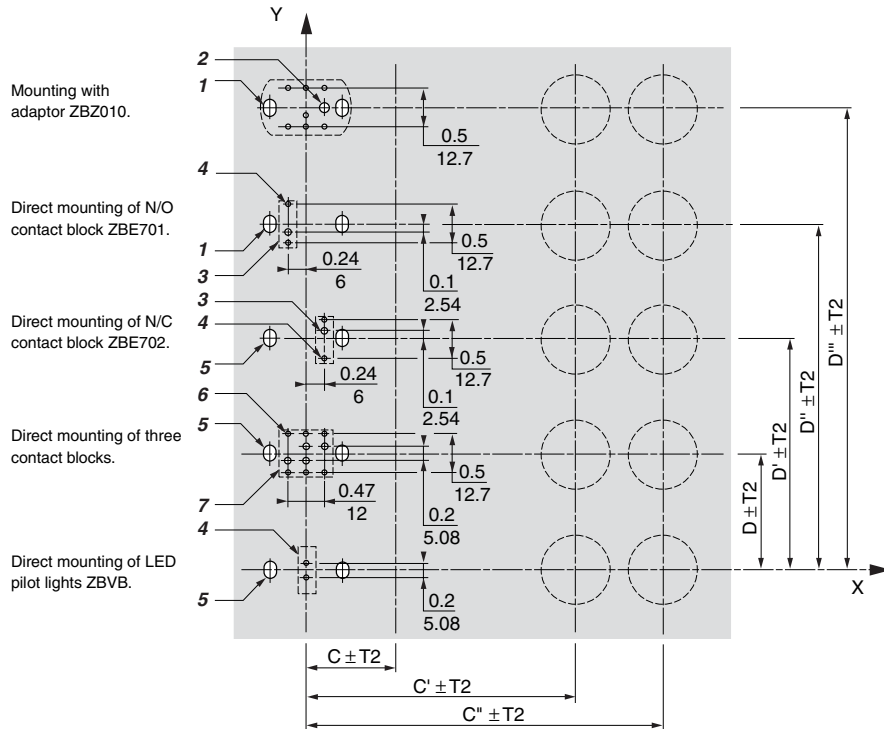

General Tolerances of the Panel and Printed Circuit Board

The cumulative tolerance must not exceed 0.02 inch (0.5 mm): $T1 + T2 = 0.02$ inch (0.5 mm) maximum.

Related to horizontal direction X / Related to vertical direction Y

Dimensions: A on panel / Dimensions: B on panel

C on printed circuit board / D on printed circuit board

Installation Precautions:

1. Minimum circuit board thickness: 0.063 in (1.6 mm)
2. Cut-out diameter: 0.88 in \pm 0.004 (22.4 mm \pm 0.1)
3. Orientation of body/mounting collar ZB5AZ009: \pm 2° 30'
4. ZBZ005 and ZBZ006 mounting screw tightening torque: (0.6 N•m)

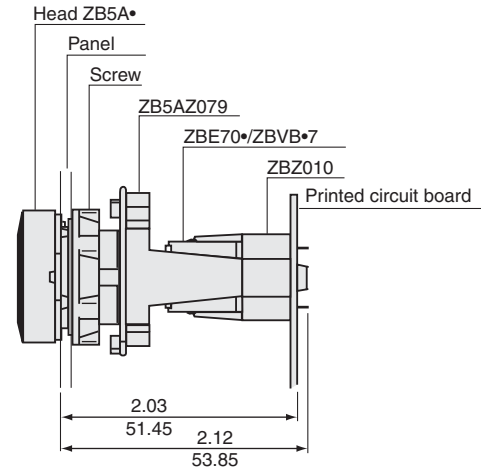

Dual Dimensions $\frac{\text{inches}}{\text{mm}}$

- 1 Two elongated holes for ZBZ005 screw access.
- 2 One - 0.1 inch \pm 0.002 (2.6 mm \pm 0.05) diameter hole for orientation of the ZBZ010 adaptor.
- 3 One - 0.07 inch \pm 0.002 (1.8 mm \pm 0.05) diameter hole for orientation of contact block.
- 4 Two - 0.05 inch \pm 0.002 (1.2 mm \pm 0.05) diameter holes.
- 5 Two elongated holes for ZBZ006 screw access.
- 6 Six - 0.05 inch \pm 0.002 (1.2 mm \pm 0.05) diameter holes.
- 7 Four - 0.07 inch \pm 0.002 (1.8 mm \pm 0.05) diameter holes.

Dual Dimensions $\frac{\text{inches}}{\text{mm}}$

Push Buttons & Operator Interface - XB5 22 mm Double Insulated Printed Circuit Board (PCB) Components

Standard (30 x 40 mm) Legend Plates for 8 x 27 mm Legends ■

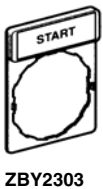
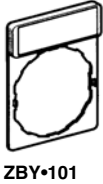
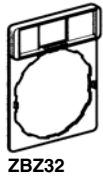

Description	Legend		Catalog Number
	Color	Text	
Without legend	–	–	ZBZ32
With blank legend (for engraving)	Black or red background	–	ZBY2101
	White or yellow background	–	ZBY4101
Custom Legend (Specify Engraving) 2 lines of 11 characters (including spaces) maximum per line	Black background	White	ZBY2002
	Red background	White	ZBY2004
	White background	Black	ZBY4001
	Yellow background	Black	ZBY4005
With international language marked legend	Black or red background	O (black background)	ZBY2146
		O (red background)	ZBY2931
		I	ZBY2147
		II	ZBY2148
		O-I	ZBY2178
		I-II	ZBY2179
		I-O-II	ZBY2186
		AUTO	ZBY2115
		STOP	ZBY2304
		With English language marked legend	Black or red background ▲
AUTO-O-HAND	ZBY2385		
CLOSE	ZBY2314		
DOWN	ZBY2308		
EMERGENCY STOP	ZBY2330		
FAST	ZBY2328		
FORWARD	ZBY2305		
FOR REV	ZBY2371		
HAND	ZBY2316		
HAND-OFF-AUTO	ZBY2387		
INCH	ZBY2321		
JOG	ZBY2382		
LEFT	ZBY2310		
OFF	ZBY2312		
OFF-ON	ZBY2367		
ON	ZBY2311		
OPEN	ZBY2313		
POWER ON	ZBY2326		
RESET (red background)	ZBY2323		
RESET (black background)	ZBY2322		
REVERSE	ZBY2306		
RIGHT	ZBY2309		
RUN	ZBY2334		
SLOW	ZBY2327		
START	ZBY2303		
STOP-START	ZBY2366		
UP	ZBY2307		

■ For legends, see page 99.

▲ "Start" functions: white letters on black background. "Stop" functions: white letters on red background (unless otherwise specified above).

Push Buttons & Operator Interface - XB5 22 mm Double Insulated Printed Circuit Board (PCB) Components

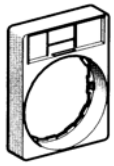

ZBZ34



ZBY•H101



ZBZ33

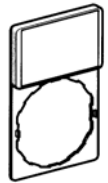

ZBY610•



ZBZ35



ZBY6H10•



ZBY9330

Flush Mounting with Bezel Legend Plates (30 x 40 mm) for 8 x 27 mm Legends

Description	For Use With	Color	Catalog Number
Without legend	Circular heads	–	ZBZ34
	Square heads	–	ZBCZ34
With blank legend	Circular heads	Black or red background	ZBY2H101
		White or yellow background	ZBY4H101
With blank legend	Square heads	Black or red background	ZBCY2H101
		White or yellow background	ZBCY4H101

Standard (30 x 50 mm) Legend Plates for 18 x 27 mm Legends

Description	For Use With	Color	Catalog Number
Without legend	Circular and square heads	–	ZBZ33
With blank legend	Circular and square heads	Black or red background	ZBY6101
		White or yellow background	ZBY6102

Flush Mounting with Bezel Legend Plates (30 x 50 mm) for 18 x 27 mm Legends

Description	For Use With	Color	Catalog Number
Without legend	Circular heads	–	ZBZ35
	Square heads	–	ZBCZ35
With blank legend	Circular heads	Black or red background	ZBY6H101
		White or yellow background	ZBY6H102
With blank legend	Square heads	Black or red background	ZBCY6H101
		White or yellow background	ZBCY6H102

Legends for Engraving (Inserts only)

Description	For use with	Color	Catalog Number
8 x 27 mm	30 x 40 mm legend holders	Black or red background	ZBY0101
		White or yellow background	ZBY0102
18 x 27 mm	30 x 50 mm legend holders	Black or red background	ZBY5101
		White or yellow background	ZBY5102

Custom Engraved (inserts only)

Description	For use with	Color	Text	Catalog Number
8 x 27 mm Custom Legend / Insert only (Specify Engraving) 2 lines of 11 characters (including spaces) maximum per line	30 x 40 mm holder	Black background	White	ZBY01002
		Red background	White	ZBY01004
		White background	Black	ZBY01001
		Yellow background	Black	ZBY01005
18 x 27 mm Custom Legend / Insert only (Specify Engraving) 3 lines of 11 characters (including spaces) maximum per line	30 x 50 mm holder	Black background	White	ZBY05002
		Red background	White	ZBY05004
		White background	Black	ZBY05001
		Yellow background	Black	ZBY05005

Sheets of Peel-Off Legends (with backing board and protective transparent cover)

Description	For use with	Catalog Number
Sheet of 76 8 x 27 mm legends	30 x 40 mm legend holders ZBZ32 and ZBZ34	ZBY4100
Sheet of 40 18 x 27 mm legends	30 x 50 mm legend holders ZBZ33 and ZBZ35	ZBY5100

Circular Legends for Emergency Stop Mushroom Heads (yellow background)

Diameter	For use with	Catalog Number
60 mm	Blank	ZBY9101
	ARRET D'URGENCE	ZBY9130
	EMERGENCY STOP	ZBY9330
90 mm	Blank	ZBY8101
	ARRET D'URGENCE	ZBY8130
	EMERGENCY STOP	ZBY8330

Push Buttons & Operator Interface - XB5 22 mm Double Insulated Printed Circuit Board (PCB) Components

Marked Legends (8 x 27 mm) (for 30 x 40 mm legend holders ZBZ32 and ZBZ34)



Color	Text		Catalog Number	
Black or red background ■	International	O (black background)	ZBY02146	
		O (red background)	ZBY02931	
		I	ZBY02147	
		II	ZBY02148	
		O-I	ZBY02178	
		I-II	ZBY02179	
		I-O-II	ZBY02186	
		AUTO	ZBY02115	
		STOP	ZBY02304	
		English	AUTO-HAND	ZBY02364
			AUTO-O-HAND	ZBY02385
			CLOSE	ZBY02314
			DOWN	ZBY02308
			EMERGENCY STOP	ZBY02330
			FAST	ZBY02328
FORWARD	ZBY02305			
FOR REV	ZBY02371			
HAND	ZBY02316			
HAND-OFF-AUTO	ZBY02387			
INCH	ZBY02321			
JOG	ZBY02382			
LEFT	ZBY02310			
OFF	ZBY02312			
OFF-ON	ZBY02367			
ON	ZBY02311			
OPEN	ZBY02313			
POWER ON	ZBY02326			
RESET (red background)	ZBY02323			
RESET (black background)	ZBY02322			
REVERSE	ZBY02306			
RIGHT	ZBY02309			
RUN	ZBY02334			
SLOW	ZBY02327			
START	ZBY02303			
STOP-START	ZBY02366			
UP	ZBY02307			

■ "Start" functions: white letters on black background. "Stop" functions: white letters on red background (unless otherwise specified above).

Sheets of Legends for Push Buttons, Switches, and Pilot Lights

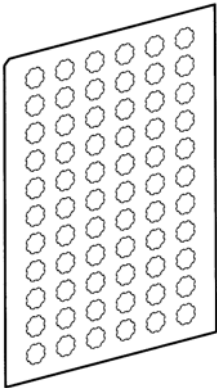

ZBY1101

Description	Text		Catalog Number
Sheets of 66 circular peel-off transparent self-adhesive legends	Without		ZBY1101
	International	O	ZBY1146
		I	ZBY1147
		II	ZBY1148
		III	ZBY1149
		STOP	ZBY1304
		↑	ZBY1912
		English	HAND
	OFF	ZBY1312	
	ON	ZBY1311	
	START	ZBY1303	

Push Buttons & Operator Interface - XB5 22 mm Double Insulated

Push Button Caps

Push Button Caps - Unmarked



ZBA•



ZBL•

For use with	Type of Push	Color	Catalog Number	
ZB5AA0 push button heads supplied with cap	Flush	White	ZBA1	
		Black	ZBA2	
		Green	ZBA3	
		Red	ZBA4	
		Yellow	ZBA5	
		Blue	ZBA6	
	6 colors ■	ZBA9		
		Extended	White	ZBL1
			Black	ZBL2
			Green	ZBL3
			Red	ZBL4
			Yellow	ZBL5
Blue	ZBL6			
6 colors ■	ZBL9			

Push Button Caps - Marked



ZBA•33

For use with	Type of Push	Marking		Color of Cap	Catalog Number
		Text	Color		
ZB5AA0 push button heads supplied with cap	Flush	▲	White	Green	ZBA331
			Black	White	ZBA131
		START ▲	White	Green	ZBA333
			Black	White	ZBA133
		◊	White	Green	ZBA346
		ON	White	Green	ZBA341
			Black	White	ZBA141
		UP ▲	Black	White	ZBA343
		DOWN ▲	White	Black	ZBA344
		⊕	White	Green	ZBA346
		⊕ ▲	Black	White	ZBA145
			White	Black	ZBA245
		↑	Black	White	ZBA334 ●
			White	Black	ZBA335 ●
		O ▲	White	Red	ZBA432
			Black	Black	ZBA232
		STOP ▲	White	Red	ZBA434
	Black		Black	ZBA234	
OFF	White	Red	ZBA435		
	Black	Black	ZBA235		
R ▲	White	Blue	ZBA639		
Extended	O ▲	White	Red	ZBL432	

- Set of 6 different colored caps: white, black, green, red, yellow, blue.
- ▲ Double injection molded marking.
- Cap supplied not clipped-in, allowing orientation of arrow in 4 directions: ↑, ↓, ←, →.

Push Buttons & Operator Interface - XB5 22 mm Double Insulated Accessories and Replacement Parts



ZBZ160*



ZB4SZ3



ZB5AZ31



ZB5AZ905



ZB5AZ902

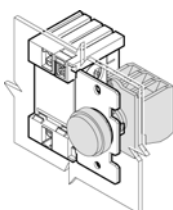

XBZS43



DLCE***



DL1CF***

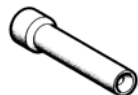

XBFX13

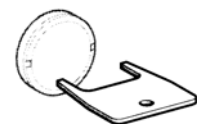

ZBZ8



ZBG455

Accessories

Description	Application	Color	Catalog Number
Metal guards (padlocking possible)	Ø 40 mm Emergency stop and mushroom head push buttons	Black	ZBZ1602
		Red	ZBZ1604
		Yellow	ZBZ1605
		Blue	ZBZ1606
Plastic blanking plug, round, black ■	For Ø 22 mm units with round heads		ZB5SZ3
Plastic blanking plug, square, black ■	For Ø 22 mm units with square heads		ZB5SZ5
Square insert	To give square appearance to ZB5A round heads		ZB5AZ31
Mounting nut	Operator		ZB5AZ901
Tool	For tightening screw ZB5AZ901		ZB5AZ905
Plate	Anti-rotation of head		ZB5AZ902

■ Mounting nut included with blanking plug.

Modules for AS-i Interface with Ø 22 mm Control and Signalling Units

Description	Application	Catalog Number
Mounted on panel, with a Harmony style push button		
Profil P 7.0 	4 I/O direct supply for AS-i bus	XBZS43

BA 9s Bulbs and Associated Accessories

Description	Characteristics	Catalog Number
Incandescent bulbs	6 V, 1.2 W	DL1CB006
	12 V, 2 W	DL1CE012
	24 V, 2 W	DL1CE024
	120-130 V, 2.4 W	DL1CE130
Neon bulbs	120-130 V	DL1CF110
	230-240 V	DL1CF220
Bulb extractor		XBFX13
Lens cap tightening tool	Illuminated push buttons with flush push	ZBZ8

Replacement Keys for Emergency Stop Push Buttons and Selector Switches

Description	Key Number	Catalog Number
Set of 2 keys	455	ZBG455
	421E	ZBG421E
	458A	ZBG458A
	520E	ZBG520E
	3131A	ZBG3131A

Push Buttons & Operator Interface - XB5 22 mm Double Insulated Accessories and Replacement Parts



ZBP0

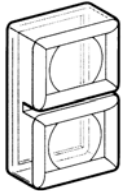

ZBW008



ZBV01-3



ZBV01

Clear Boots

Description	For use with	Catalog Number
Single boots	Booted push buttons with circular head (neoprene)	ZBP0
	Booted push buttons with circular head used in food industry applications (silicone)	ZBP0A
Double boots	Double-headed push buttons, with or without pilot light (neoprene)	ZBW008
	Double-headed push buttons used in food industry applications (silicone)	ZBW008A

Lens Caps

For use with	Color	Catalog Number
Lens caps for protected LED light modules		
Pilot lights	White	ZBV0113
	Green	ZBV0133
	Red	ZBV0143
	Yellow	ZBV0153
	Blue	ZBV0163
Illuminated push buttons with flush push	White	ZBW9113
	Green	ZBW9133
	Red	ZBW9143
	Yellow	ZBW9153
	Blue	ZBW9163
Illuminated push buttons with extended push	White	ZBW9313
	Green	ZBW9333
	Red	ZBW9343
	Yellow	ZBW9353
	Blue	ZBW9363
Circular lens caps for Ba9 light modules		
Pilot lights	White	ZBV011
	Green	ZBV013
	Red	ZBV014
	Yellow	ZBV015
	Blue	ZBV016
	Clear	ZBV017
Illuminated push buttons with flush push	White	ZBW911
	Green	ZBW913
	Red	ZBW914
	Yellow	ZBW915
	Blue	ZBW916
	Clear	ZBW917
Illuminated push buttons with extended push	White	ZBW931
	Green	ZBW933
	Red	ZBW934
	Yellow	ZBW935
	Blue	ZBW936
	Clear	ZBW937
Square lens caps for protected LED light modules (ZB5C operators only)		
Pilot lights	White	ZBCV0113
	Green	ZBCV0133
	Red	ZBCV0143
	Yellow	ZBCV0153
	Blue	ZBCV0163
Illuminated push buttons with flush push	White	ZBCW9113
	Green	ZBCW9133
	Red	ZBCW9143
	Yellow	ZBCW9153
	Blue	ZBCW9163
Illuminated push buttons with extended push	White	ZBCW9313
	Green	ZBCW9333
	Red	ZBCW9343
	Yellow	ZBCW9353
	Blue	ZBCW9363

Push Buttons & Operator Interface - XB5 22 mm Double Insulated Dimensions

Push Buttons, momentary

XB5AA••

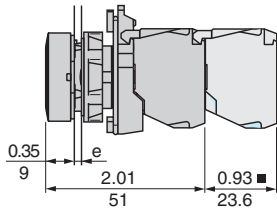

XB5AL••

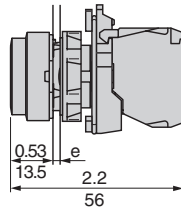

Common face view

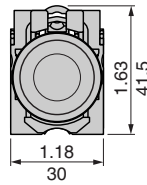

XB5AP••

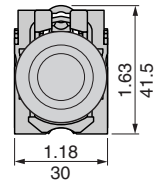
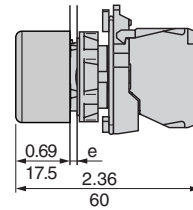

■ Can be fitted with additional contact block.

Push buttons, momentary Mushroom head XB5AC21

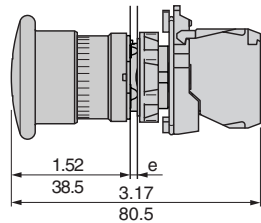

Double-headed

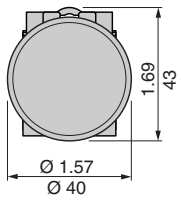

XB5AL•45, AL•4C5

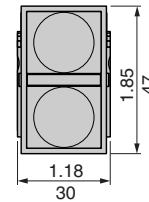
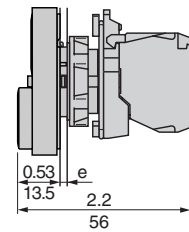

Dual Dimensions $\frac{\text{inches}}{\text{mm}}$

e: Panel thickness, 0.04 to 0.24 in (1 to 6 mm).

Emergency stop and mushroom head push buttons XB5AT42, AT845

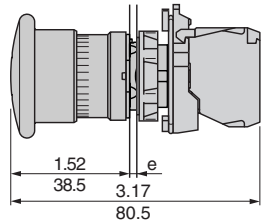

XB5AS542, AS8445

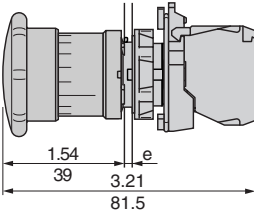

XB5AS142, AS9445

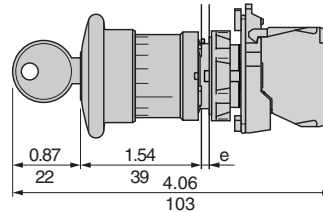

Common face view

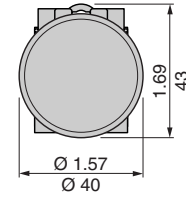

e: Panel thickness, 0.04 to 0.24 in (1 to 6 mm).

Selector switches Standard lever operator XB5AD

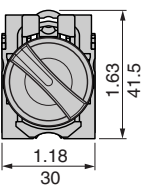
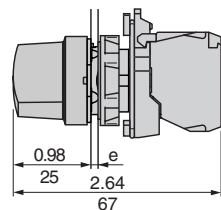

Rectangular head XB5AJ

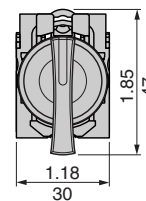
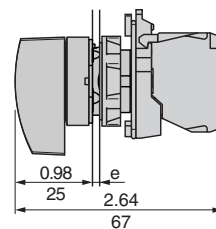

Key switches XB5AG

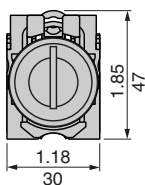
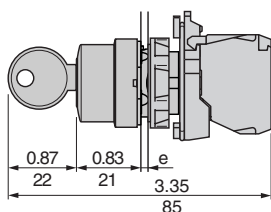

Dual Dimensions $\frac{\text{inches}}{\text{mm}}$

e: Panel thickness, 0.04 to 0.24 in (1 to 6 mm)

Push Buttons & Operator Interface - XB5 22 mm Double Insulated Dimensions

Pilot lights

Protected LED
XB5AVB•, AVG•, AVM•

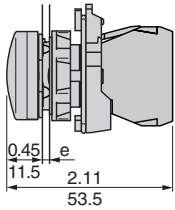

Direct supply
XB5AV6

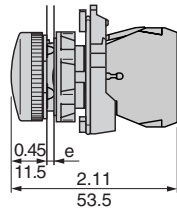

Transformer type
XB5AV3•, AV4•

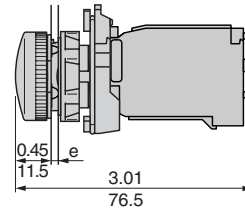

Common face view

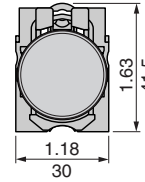

Dual Dimensions $\frac{\text{inches}}{\text{mm}}$

e: Panel thickness, 0.04 to 0.24 in (1 to 6 mm).

Illuminated push buttons

Protected LED
XB5AW3••5

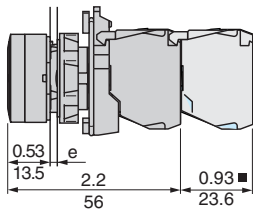

Direct supply
XB5AW3•65

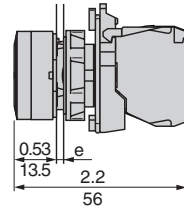

Transformer type
XB5AW3••5

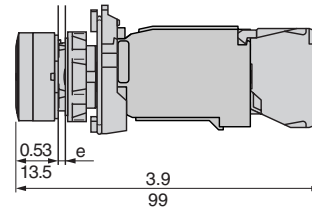

Common face view

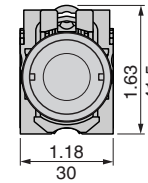

Double headed push buttons with pilot light

Protected LED
XB5AW84•5

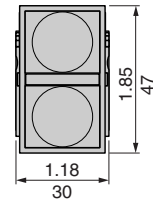
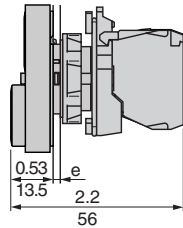

Illuminated selector switches

Protected LED
XB5AK12••5

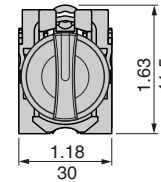
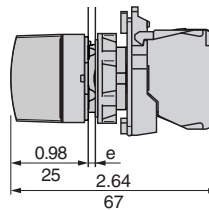

e: Panel thickness, 0.04 to 0.24 in (1 to 6 mm).

■ Can be fitted with additional contact block.

Support panel cut-out (suitable for mounting all types of push buttons and pilot lights)

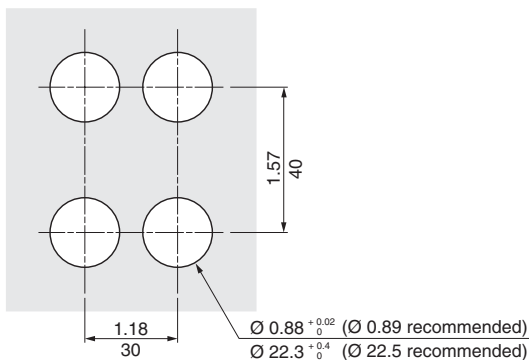

Dual Dimensions $\frac{\text{inches}}{\text{mm}}$

Heads for push buttons, momentary

ZB5AA•, AA•••
ZB5AA•8

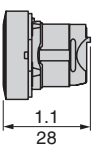

ZB5AL•, AL•••

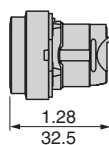

ZB5AA•4

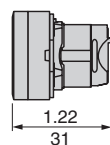

Common face view

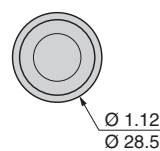

ZB5AP••

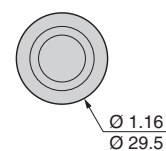
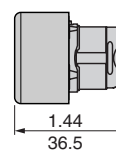

Push Buttons & Operator Interface - XB5 22 mm Double Insulated Dimensions

ZB5CA•

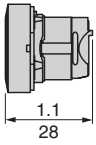

ZB5CL•

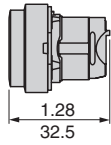

Common face view

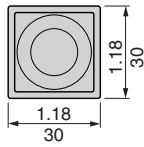

Dual Dimensions $\frac{\text{inches}}{\text{mm}}$

Heads for push buttons Lockable "Push-turn" ZB5AFD

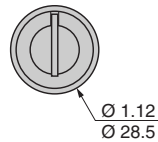
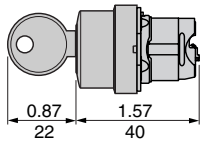

"Push-push to release" ZB5AH•

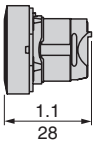

ZB5AH•

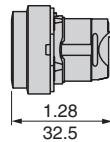

Common face view

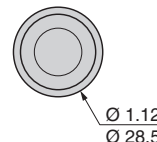

ZB5CH•

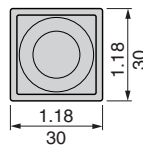
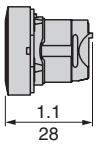

Heads for double-headed push buttons, momentary

ZB5AA81•• ZB5AA82••

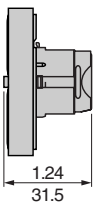

ZB5AL83•• ZB5AL84••

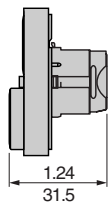

Common face view

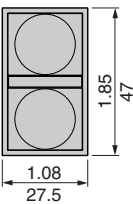

ZB5AA91•• ZB5AA92••

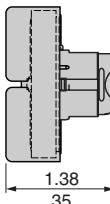

ZB5AL93•• ZB5AL94••

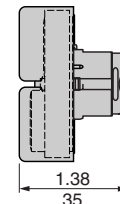

Common face view

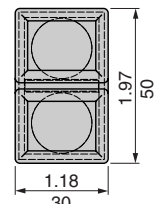

Mushroom heads for push buttons ZB5AC•4

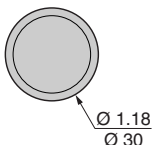
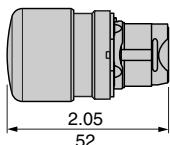

ZB5AC•, AR•

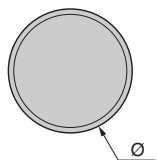
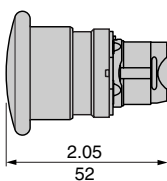

ZB5	Ø
AC•	1.57 in (40 mm)
AR•	2.36 in (60 mm)

Mushroom heads for push buttons, maintained

Push-pull

ZB5AT•4

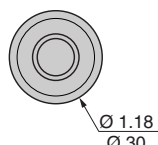
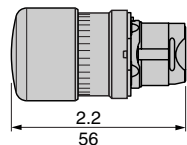

ZB5AT•, AX•

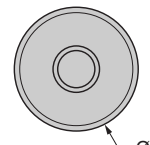
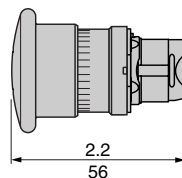

Dual Dimensions $\frac{\text{inches}}{\text{mm}}$

ZB5	Ø
AT•	1.57 in (40 mm)
AX•	2.36 in (60 mm)

Turn to release ZB5AS4•, AS834

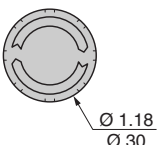
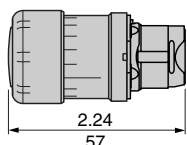

ZB5AS5•, AS844, AS6•

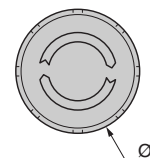
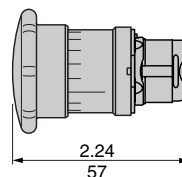

ZB5	Ø
AS5•, AS844	1.57 in (40 mm)
AS6•	2.36 in (60 mm)

Push Buttons & Operator Interface - XB5 22 mm Double Insulated Dimensions

Key release ZB5AS7•, AS934

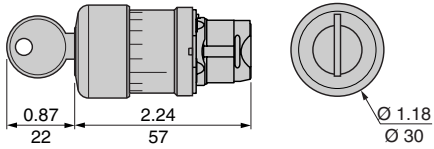

ZB5AS1•, AS2•, AS944, AS964

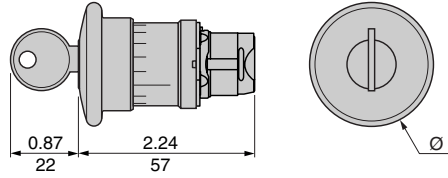

ZB5	Ø
AS1•, AS944	1.57 in (40 mm)
AS2•, AS964	2.36 in (60 mm)

ZB5AS14D

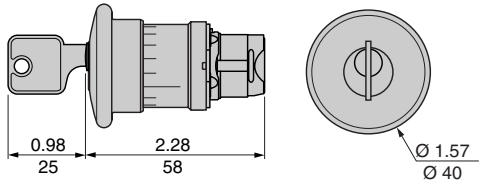

Dual Dimensions $\frac{\text{inches}}{\text{mm}}$

Heads for selector switches Standard lever ZB5AD•

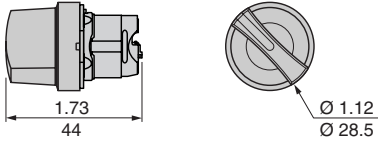

Extended lever ZB5AJ•

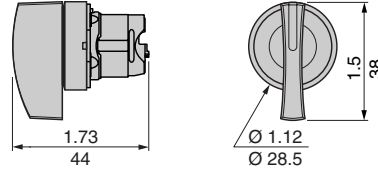

Dual Dimensions $\frac{\text{inches}}{\text{mm}}$

Knurled knob ZB5AD-9

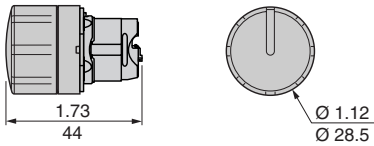

Key switches (Ronis No. 455) ZB5AG•, AG0•

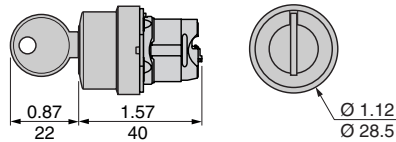

Key switches (DOM No. 8D1) ZB5AGD

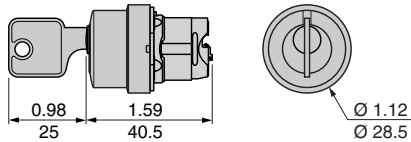

Heads for toggle switches ZB5AD-8

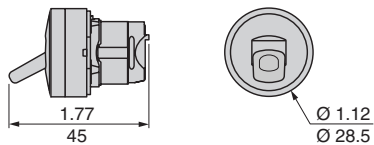

Bodies for push buttons and switches Screw clamp terminal connections ZB5AZ10•

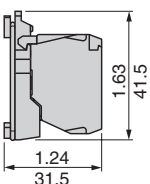

Plug-in connector ZB5AZ10•4, AZ1414

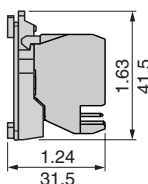

Dual Dimensions $\frac{\text{inches}}{\text{mm}}$

Push Buttons & Operator Interface - XB5 22 mm Double Insulated Dimensions

Heads for pilot lights, with light source

Protected LED

ZB5AV0•3

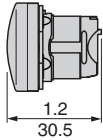

Incandescent, neon or LED

ZB5AV0•

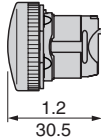

Common face view

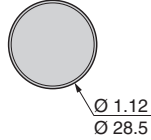

ZB5CV0•3

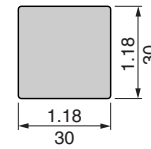
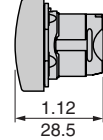

Bodies for pilot lights, screw clamp terminal connections

Protected LED

ZB5AV••

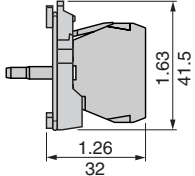

Direct supply, for BA 9s bulb

ZB5AV6

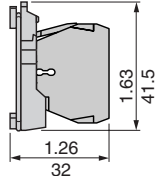

Transformer type, for BA 9s bulb

ZB5AV•, AV•D•

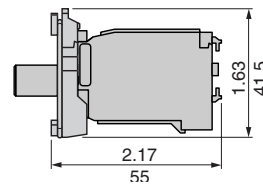

Dual Dimensions $\frac{\text{inches}}{\text{mm}}$

Bodies for pilot lights, plug-in connector

Protected LED

ZB5AV••4

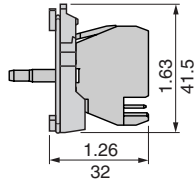

Heads for illuminated push buttons, momentary, light source LED

ZB5AW3•3

ZB5AW1•3

Common face view

ZB5AW9•3

ZB5AA•8

ZB5AL•8

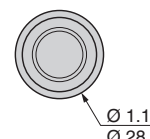
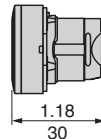
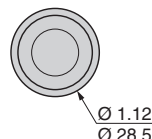
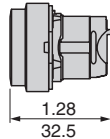
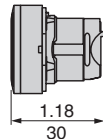

ZB5AW5•3

ZB5CW3•3

ZB5CW1•3

Common face view

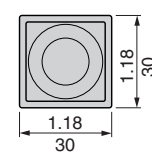
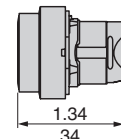
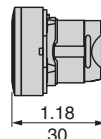
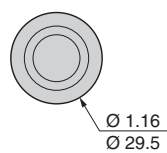
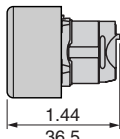

Incandescent or neon

ZB5AW3•3

ZB5AW1•3

Common face view

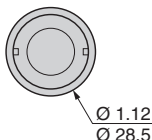
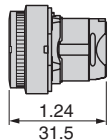
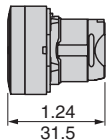

Dual Dimensions $\frac{\text{inches}}{\text{mm}}$

Heads for double-headed push buttons with pilot light

ZB5AW81•••3,

ZB5AW83•••3

Common face view

ZB5AW82•••3

ZB5AW84•••3

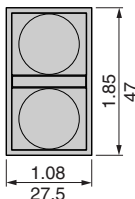
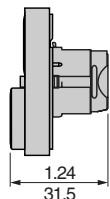
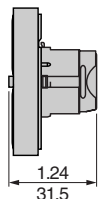

Push Buttons & Operator Interface - XB5 22 mm Double Insulated Dimensions

Heads for "push-push to release" illuminated push buttons
ZB5AH0•3, **ZB5AH•3** Common face view

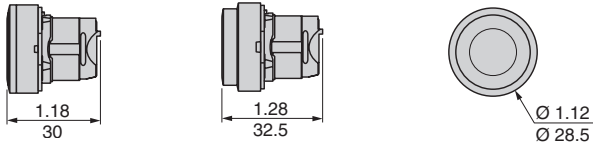

Heads for illuminated selector switches, standard lever
ZB5AK1•••3

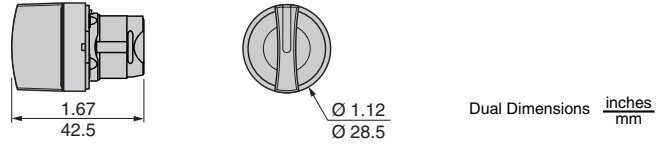

Dual Dimensions $\frac{\text{inches}}{\text{mm}}$

Bodies for illuminated push buttons and selector switches, screw clamp terminal connections

Protected LED

Direct supply, for BA 9s bulb

Transformer type, for BA 9s bulb

Bodies for illuminated push buttons and selector switches, plug-in connector protected LED
ZB5AW0•••4

ZB5AW0•••

ZB5AW06•

ZB5AW0••, AW0•D••



Manual overload reset buttons

Head + mounting base

for potentiometer
ZB5AD9•2

XB5A8•••

XB5AL8•••

Common face view

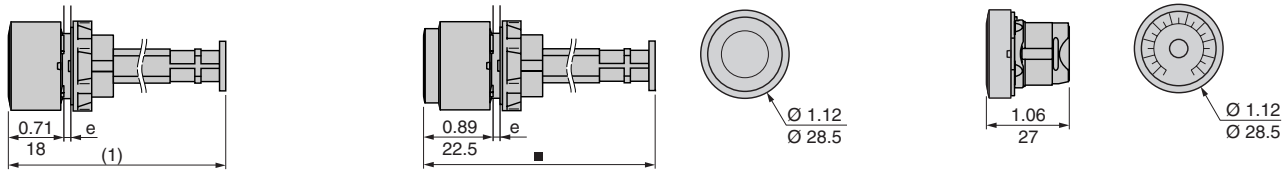

e: Panel thickness, 0.04 to 0.24 in (1 to 6 mm)

Joystick controllers

XD5PA•2

XD5PA•4

Common face view

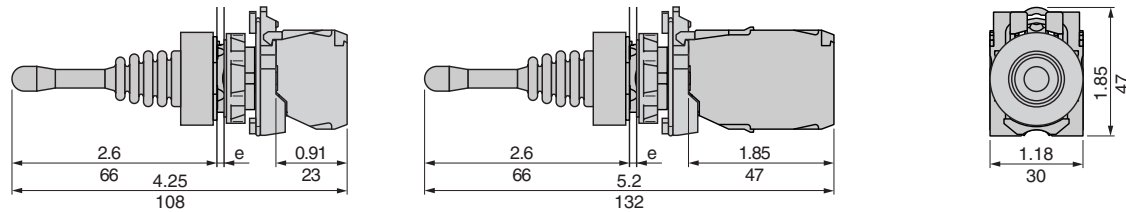

e: Panel thickness, 0.04 to 0.24 in (1 to 6 mm).

Hour counters

XB5DS•

Annunciators

XB5KS•

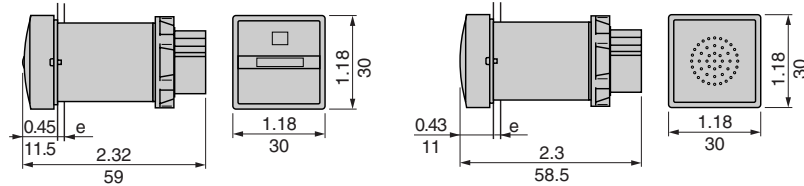

e: Panel thickness, 0.04 to 0.24 in (1 to 6 mm).

Push Buttons and Operator Interface Specifier's Guide Type XAL Control Stations

Catalog
2005

File 9001



CONTENTS

Description	Page
General Information	110
General Characteristics	111
Complete Stations	113
Emergency Stop Stations	113
Empty Enclosures	114
Assembly Components	115
Dimensions	116
Declaration of Conformity	221



Push Buttons & Operator Interface - XAL Control Stations

General Information

GENERAL INFORMATION

XALD and XALK control stations are available in two forms:

- Pre-assembled
- Custom assembled

These control stations use push buttons and pilot lights from the XB5 plastic operator range.

Control stations are composed of:

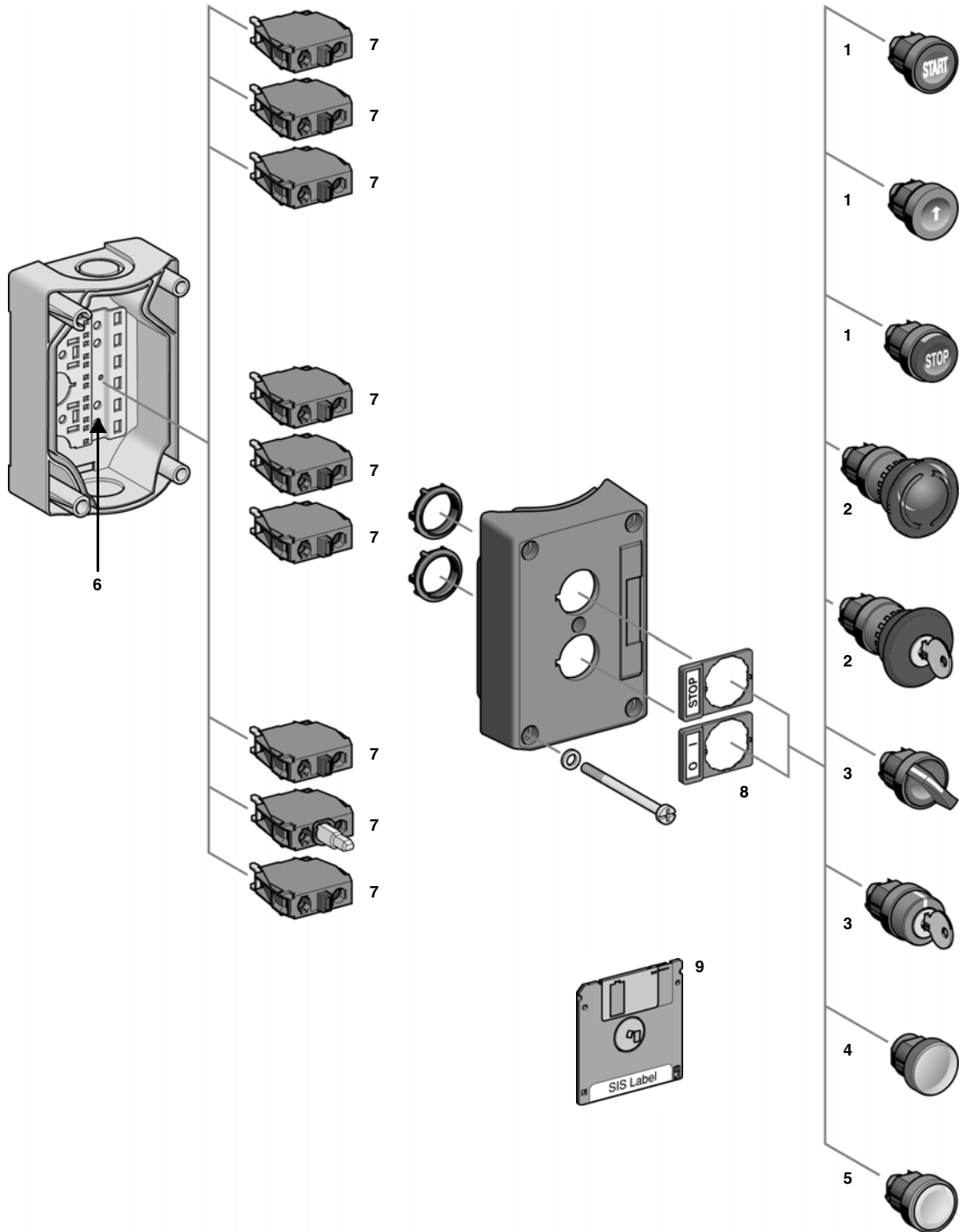

- 1 - Non-illuminated operators.
- 2 - Emergency stop operators.
- 3 - Selector switches.
- 4 - Pilot lights.
- 5 - Illuminated operators.
- 6 - Base of enclosure (with mounting plate).
- 7 - Contact block and light module combinations.
- 8 - Legends.
- 9 - SIS label software.



Push Buttons & Operator Interface - XAL Control Stations

General Characteristics

Environment

Protective treatment standard version		"TH"
Ambient air temperature around the device	Storage	-40 to +158 °F (- 40 to +70 °C)
	Operation	-13 to +158 °F (- 25 to +70 °C) unless otherwise stated
Electric shock protection	Conforming to IEC 60536	Class II
Degree of protection	Conforming to IEC 60529	IP 65, unless otherwise stated IP 66, for booted push button heads
	Conforming to UL 50, CSA C22.2 No. 94	Type 1, 4X, 12, and 13, unless otherwise stated
Resistance to high pressure cleaner		1,015 psi (70 x 10 ⁵ Pa-70 bars); distance: 3.94 in (0.1 m) Temperature: 131 °F (55 °C)
Mechanical shock protection	Conforming to EN 50102	Non-illuminated heads: IK 03
		Illuminated heads: IK 05
Conforming to standards	 Marked	IEC 60947-1, IEC/EN 60947-5-1, IEC 60947-5-4, EN 60947-1, JIS C 4520, UL 508, CSA C22.2 No. 14
Product certifications	UL Listed, CSA Certified  File E164353 CCN NKCR  File LR 44087 Class 3211 03	Standard single contacts with screw clamp terminals: A600; R300 Light blocks with screw clamp terminals
Terminal identification	Conforming to EN 50005 and EN 50013	
Material and colors		XALD: polycarbonate, light grey RAL 7035 and dark grey RAL 7016 XALK: polycarbonate, light grey RAL 7035 and yellow RAL 1012
Cable entries		Cable entries: 'knock-outs' for No. 13 (CM 12, PG 13.5) cable glands and tapped ISO 20
Cover Screws		Stainless steel, tightening torque 2 Nm

Contact Blocks Characteristics

Mechanical Characteristics			
Contact operation	N/C or N/O	Slow break	
Positive operation	Conforming to IEC/EN 60947-5-1 Appendix K	All functions incorporating a N/C contact are positive opening operation	
Operating travel (to change electrical state)	Push button	Changing N/C state: 0.06 in (1.5 mm) Changing N/O state: 0.11 in (2.6 mm) Total travel: 0.17 in (4.3 mm)	
	Operating force	Push button Changing N/C state: 0.79 lbf (3.5 N) Changing N/O state: 0.85 lbf (3.8 N)	
Operating force	Additional contact only	Single N/C contact: 0.45 lbf (2 N) Single N/O contact: 0.52 lbf (2.3 N)	
	Emergency stop with N/C + N/O	Standard push-pull: 10.12 lbf (45 N) Trigger action push-pull: 11.24 lbf (50 N)	
		Standard turn to release and key release: 8.99 lbf (40 N) Trigger action turn to release and key release: 9.89 lbf (44 N)	
Operating torque (to change electrical state)	Selector switches	N/O contact: 1.24 lb-in (0.14 N•m)	
	Additional contact only	N/O contact: 0.44 lb-in (0.05 N•m)	
Mechanical durability (in operating cycles)	Push button	Momentary	5 million
	Selector switches	Non-illuminated	3 million
		Illuminated	1 million
	Toggle switches		500,000
	Emergency stop push button		100,000
Vibration resistance	Conforming to IEC 60068-2-6	Frequency (2 to 500 Hz): 5 gn	
Shock resistance	Conforming to IEC 60068-2-27	All functions except mushroom head push buttons– Half sine wave acceleration 11 ms: 50 gn Half sine wave acceleration 18 ms: 30 gn	
		Mushroom head push buttons– Half sine wave acceleration 11 ms: 10 gn	

Push Buttons & Operator Interface - XAL Control Stations

General Characteristics

Contact Block Characteristics (continued)

Electrical Characteristics				
Cabling capacity	Conforming to IEC 60947-1	Screw and captive clamp terminals Min: 1 x 24 AWG (0.22 mm ²) without cable end 1 x 22 AWG (0.34 mm ²) for linking Max: 2 x 16 AWG (1.5 mm ²) with cable end Cross headed screw (Pozidrive type 1) slotted for flat 4 and 5.5 mm screwdriver Typical torque: 0.8 N•m (8.55 lb-in) Maximum torque: 1.2 N•m (10.7 lb-in)		
Contact material		Silver alloy (Ag/Ni)		
Short-circuit protection	Conforming to IEC/EN 60947-5-1	Standard blocks with screw clamp terminals: 10 A (gG cartridge fuse conforming to IEC 60269-1)		
Rated insulation voltage	Conforming to IEC 60947-1	Standard blocks with screw clamp terminals: Ui = 600 V, degree of pollution 3		
Rated impulse withstand voltage	Conforming to IEC 60947-1	Standard block with screw clamp terminals: Uimp = 6 kV		
Rated operational characteristics Conforming to IEC/EN 60947-5-1	AC supply: Utilization category AC-15	A600: Ue = 600 Vac and Ie = 1.2 A or Ue = 240 Vac and Ie = 3 A or Ue = 120 Vac and Ie = 6 A		
	DC supply: Utilization category DC-13	R300: Ue = 250 Vdc and Ie = 0.1 A or Ue = 125 Vdc and Ie = 0.22 A		
Electrical durability Conforming to IEC/EN 60947-5-1 Appendix C Operating rate 3600 operating cycles/hour. Load factor: 0.5	AC supply for 1 million operating cycles, utilization category AC-15	24 Vac	120 Vac	230 Vac
		4 A	3 A	2 A
	DC supply for 1 million operating cycles, utilization category DC-13	24 Vdc	110 Vdc	
		0.4 A	0.15 A	
Electrical reliability	Failure rate Conforming to IEC 947-5-4	Standard blocks: - at 17 V and 5 mA, $\lambda < 10^{-8}$ - at 5 V and 1 mA, $\lambda < 10^{-6}$		

Specific Characteristics of Light Modules with Protected LED

Mechanical Characteristics		
Vibration resistance	Conforming to IEC 60068-2-6	Frequency (2 to 500 Hz): 15 gn
Shock resistance	Conforming to IEC 60068-2-27	Half sine wave acceleration 11 ms: 50 gn Half sine wave acceleration 18 ms: 30 gn
Electrical Characteristics		
Cabling capacity	Conforming to IEC 60947-1	Screw and captive clamp terminals Min: 1 x 24 AWG (0.22 mm ²) without cable end 1 x 22 AWG (0.34 mm ²) for linking Max: 2 x 16 AWG (1.5 mm ²) with cable end
Rated insulation voltage	Conforming to IEC 60947-1	Pilot light blocks with protected LED: Ui = 250 V, degree of pollution 3
Rated impulse withstand voltage	Conforming to IEC 60947-1	Pilot light blocks with protected LED: Uimp = 4 kV
Voltage limits	Nominal voltage	24 V: 19.2 to 30 Vdc; 21.6 to 24.6 Vac 120V: 102 to 132 Vac 240V: 195 to 264 Vac
Current consumption	Applicable to all colors	24 Vac/Vdc supply blocks: 18 mA 120 Vac supply blocks: 14 mA 240 Vac supply blocks: 14 mA
Service life	At nominal voltage and at an ambient temperature of 77 °F (25 °C)	100,000 hours
Surge withstand	Conforming to IEC 61000-4-5	2/1 kV
Resistance to fast transients	Conforming to IEC 61000-4-4	2 kV
Resistance to electromagnetic fields	Conforming to IEC 61000-4-3	10 V/m
Resistance to electrostatic discharges	Conforming to IEC 61000-4-2	8/6 kV
Electromagnetic emission	Conforming to EN 55011	Class B

Push Buttons & Operator Interface - XAL Control Stations Complete and Emergency Stop Stations

Start or Stop Function (light grey base, RAL 7035; dark grey lid, RAL 7016)



XALD101



XALD111



XALD164

Description	Type of Push	Type of Contact		Legend Marking	Catalog Number
		N/O	N/C		
Marking on Legend Holder					
1 momentary push button	Flush black	1	–	Start	XALD101
	Flush red	–	1	Stop	XALD111
Marking on Legend Holder					
1 mushroom head push button Ø40 mm, momentary	Red	–	1	Emergency stop (red legend)	XALD164

Emergency Stop Function (light grey base, RAL 7035; yellow lid, RAL 1012)



XALK174



XALK184



XALK194

Description	Type	Type of Contact		Catalog Number
		N/O	N/C	
1 Mushroom head push button Ø 40mm, red Turn to release	Standard	–	1	XALK174
	Trigger action	–	1	XALK178
1 Mushroom head push button Ø 40mm, red Key release (Key No. 455)	Standard	–	1	XALK184
	Trigger action	–	1	XALK188
1 Mushroom head push button Ø 40mm, red Push-pull	Standard	–	1	XALK194

Push Buttons & Operator Interface - XAL Control Stations

Empty Enclosures

Start-Stop Function (light grey base, RAL 7035; dark grey lid, RAL 7016)



XALD211H29

Description	Type of Push	Type of Contact		Legend Text	Catalog Number
		N/O	N/C		
Text on legend plate					
2 Momentary push buttons	1 flush black	1	–	Start	XALD211
	1 flush red	–	1	Stop	
	1 flush black	1	–	Forward	XALD221
	1 flush black	1	–	Reverse	

Three Function (light grey base, RAL 7035; dark grey lid, RAL 7016)



XALD321

Description	Type of Push	Type of Contact		Legend Text	Catalog Number	
		N/O	N/C			
Text on legend plates						
3 momentary push buttons	1 flush black 1 flush red 1 flush black	1	–	Open	XALD341	
		–	1	Stop		
		1	–	Close		
		XALD311	1 flush black 1 flush red 1 flush black	1	–	Forward
				–	1	Stop
				1	–	Reverse
				1	–	Up
		XALD321	1 flush black 1 flush red 1 flush black	–	1	Stop
				1	–	Down

Empty Enclosures ■



XALD02

Description	Number of Holes	Catalog Number
For normal environments, CSA+ UL approvals (with stainless steel lid mounting screws)		
Light grey base "RAL 7035"	1	XALD01
Dark grey lid "RAL 7016"	2	XALD02
	3	XALD03
	4	XALD04
	5	XALD05
	Light grey base "RAL 7035"	1
Yellow lid "RAL 1012"		

■ For customer assembly using XB5 operators, see Push Buttons - XB5 22 mm starting on page 73.

Push Buttons & Operator Interface - XAL Control Stations Assembly Components



ZENL1111



ZALV**



ZB5SZ3

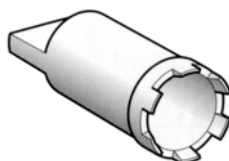

ZB5AZ905

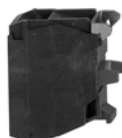

ZBE101



ZBVB*



ZB5AZ009

Electrical Blocks and Accessories (for mounting on metal plate at back of enclosure) ■

Description	Type	Color	Catalog Number
Electrical blocks with screw clamp terminal connections			
Standard contact blocks ■	N/O contact	–	ZENL1111
	N/C contact	–	ZENL1121
Light blocks with protected LED Protected LED	24 Vac or Vdc	White	ZALVB1
		Green	ZALVB3
		Red	ZALVB4
		Yellow	ZALVB5
		Blue	ZALVB6
		120 Vac	White
		Green	ZALVG3
		Red	ZALVG4
		Yellow	ZALVG5
		Blue	ZALVG6
	230 Vac	White	ZALVM1
		Green	ZALVM3
		Red	ZALVM4
		Yellow	ZALVM5
		Blue	ZALVM6

Description	Application	Catalog Number
Accessories for electrical blocks		
Blanking plug	Ø 22 mm units	ZB5SZ3
Nut	Head mounting	ZB5AZ901
Grounding terminal	Grounding	XALZ09
Key	For tightening nut ZB5AZ901	ZB5AZ905

Electrical Blocks (for mounting directly beneath the heads)

Description	Type	Color	Catalog Number
Electrical blocks with screw clamp terminal connections (for mounting on base ZB5AZ009)			
Standard contact blocks ▲	N/O contact	–	ZBE101
	N/O contact	–	ZBE102
Light blocks with protected LED Protected LED	24 Vac or Vdc	White	ZBVB1
		Green	ZBVB3
		Red	ZBVB4
		Yellow	ZBVB5
		Blue	ZBVB6
		110-120 Vac	White
		Green	ZBVG3
		Red	ZBVG4
		Yellow	ZBVG5
		Blue	ZBVG6
	230-240 Vac	White	ZBVM1
		Green	ZBVM3
		Red	ZBVM4
		Yellow	ZBVM5
		Blue	ZBVM6

Description	Application	Catalog Number
Accessories for electrical blocks		
Mounting base	Electrical blocks (contact or light module)	ZB5AZ009

- For customer assembly using XB5 operators, see Push Buttons - XB5 22 mm starting on page 73.
- ▲ A maximum of 3 electrical blocks may be fitted per associated head.

Push Buttons & Operator Interface - XAL Control Stations

Dimensions

Single-way control stations XALD1**, K1**, D01

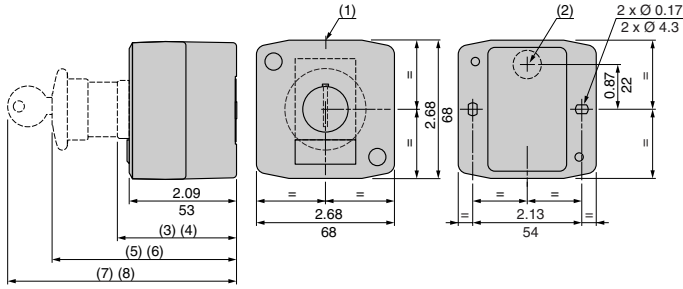

- (1) 2 knock-outs for PG 13.5 cable glands, maximum capacity 0.47 in (12 mm).
- (2) Knock-out for cable entry, maximum capacity 0.55 in (14 mm).

Examples:

- (3) 2.44 in (62 mm) for flush push buttons.
- (4) 2.59 in (66 mm) for projecting push buttons.
- (5) 3.58 in (91 mm) for latching mushroom head push buttons.
- (6) 2.91 in (74 mm) for key switches.
- (7) 4.45 in (113 mm) for latching mushroom head push buttons with key release.
- (8) 3.78 in (96 mm) for key switches with key.
- (9) 2.52 in (64 mm) for pilot lights.

Two-way control stations XALD2**, K2**, D02

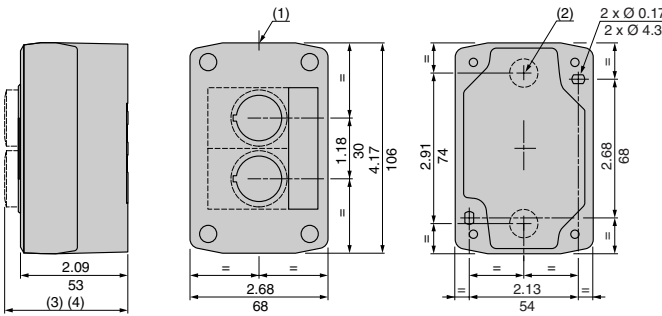

Three-way control stations XALD3**, K3**, D03

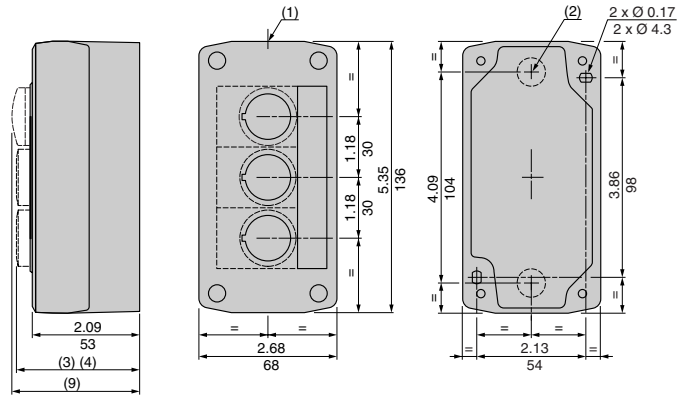

Four-way control stations XALD4**, K4**, D04

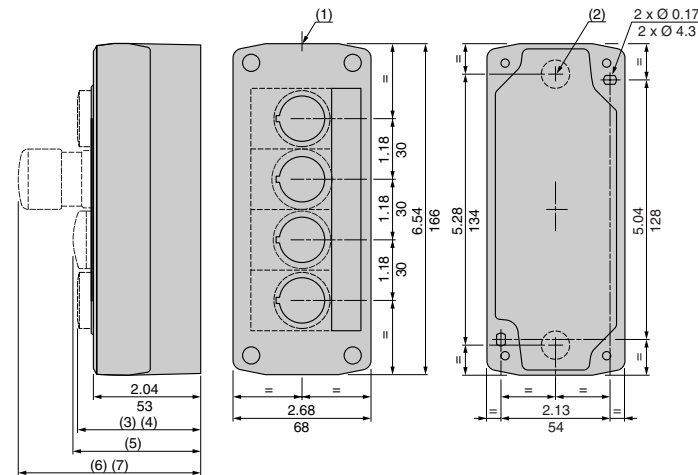

Five-way control stations XALD5**, K5**, D05

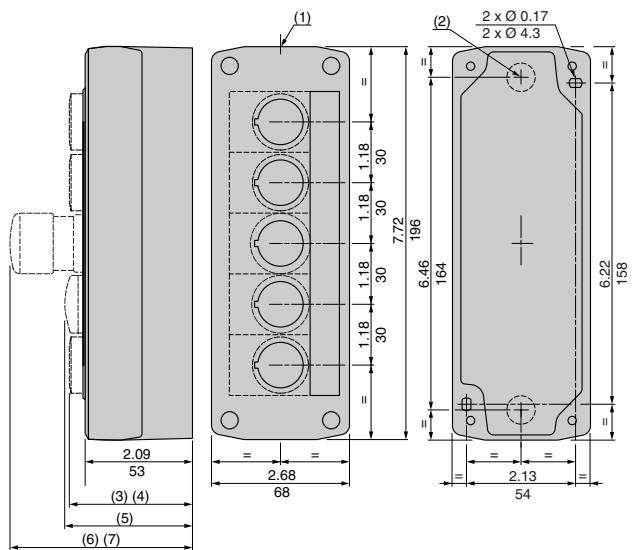

- (1) 2 knock-outs for PG 13.5 cable glands, maximum capacity 0.47 in (12 mm).
- (2) Knock-out for cable entry, maximum capacity 0.55 in (14 mm).

Examples:

- (3) 2.44 in (62 mm) for flush push buttons.
- (4) 2.59 in (66 mm) for projecting push buttons.
- (5) 2.52 in (64 mm) for pilot lights.
- (6) 3.43 in (87 mm) for mushroom head push buttons.
- (7) 3.07 in (78 mm) for selector switches.

Dual Dimensions $\frac{\text{inches}}{\text{mm}}$

Push Buttons and Operator Interface Specifier's Guide Type XAP Enclosures

Catalog
2005

File 9001



CONTENTS

Description	Page
Characteristics	118
Glass-Reinforced Polyester Enclosures	119
Die Cast Enclosures	121
Flush Plates	122
Declaration of Conformity	221



Push Buttons and Operator Interface - XAP Enclosures

Characteristics

Glass-reinforced polyester insulated enclosures XAPA

Material	Glass-reinforced polyester.
Approvals	Special version: CSA Type 4 and 5 (undrilled version)
Protective treatment	Standard version: "TC" and "TH" treatments.
Ambient temperature	Operation: -25 °C to +70 °C (-13 °F to +158 °F). Storage: -40 °C to +70 °C (-40 °F to +158 °F).
Degree of protection	IP 65 conforming to IEC 60529 and IP 657 conforming to NF C 20-010. Type 4, 4X, 12.
Electric shock protection	Class II conforming to IEC 60536 and NF C 20-030.
Flame resistance	CSTB: M3, NF C 20-455: 850°C, IEC 60092: 960 °C, UL 94: VO.
Chemical resistance	High degree of resistance to acids, bases, sea water, mineral salts, all solvents, petrol, diesel, oils and greases.
Cable entry	Undrilled.

Die Cast metal enclosures XAPG

Material	Zinc alloy (XAPG1-XAP4) Aluminum (XAPG5)
Approvals	Special version: CSA Type 4 and 5 (undrilled version); UL Type 1, 2, 4, and 12; Standard CSA Type 1, 4, 4X, and 12.
Protective treatment	Standard version: "TC" treatment. Special version: "TH" treatment.
Ambient temperature	Operation: -25 °C to +70 °C (-13 °F to +158 °F). Storage: -40 °C to +70 °C (-40 °F to +158 °F).
Degree of protection	IP 65 conforming to IEC 60529 and IP 657 conforming to NF C 20-010. UL Type 4, 12.
Electric shock protection	Class I conforming to IEC 60536 and NF C 20-030.
Chemical resistance	Special treatments on request.
Cable entry	Tapped entries for cable glands, see dimensions pages 120 and 121.

Flush mount enclosures XAPE

Material and color	Anodized aluminum front plate. Insulated protective rear cover.
Protective treatment	Standard version: "TC" and "TH" treatments.
Ambient temperature	Operation: -25 °C to +70 °C (-13 °F to +158 °F). Storage: -40 °C to +70 °C. (-40 °F to +158 °F).
Degree of protection	IP 65 conforming to IEC 60529 and IP 657 conforming to NF C 20-010. CSA Type 1, 4, 4X, and 12.
Electric shock protection	Class I conforming to IEC 60536 and NF C 20-030.
Chemical resistance	High degree of resistance to organic acids, diluted mineral acids, salts, alcohol, acetone, chloride and fluoride solvents, oils and petrol.
Cable entry	With rear cover: knock-out cable entries.



Push Buttons and Operator Interface - XAP Enclosures Glass-Reinforced Polyester Enclosures



XAPA1100

Undrilled Enclosures, Glass-Reinforced Polyester

Type		H x W Dimensions	Catalog Number
NEMA 4, 4X, 13 Usable depth 3.27 in (83 mm)	without hinges	3.34 x 5.75 in (85 x 146 mm)	XAPA1100
		3.34 x 8.90 in (85 x 226 mm)	XAPA2100
	with hinges	5.95 x 9.49 in (151 x 241 mm)	XAPA3100
		5.95 x 9.49 in (151 x 241 mm)	XAPA4100
Undrilled Grounding Plate	Sheet steel with ground screw	For XAPA1100	XAPZ100
		For XAPA2100	XAPZ200
		For XAPA3100 and 4100	XAPZ300

Undrilled Insulated enclosures
XAPA1100, XAP2100



XAPA2100

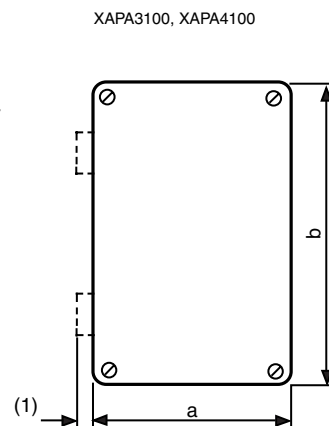
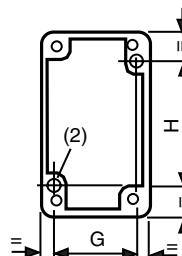
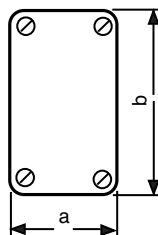
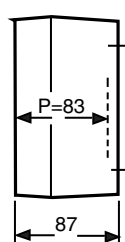

XAP	a	b	G	H
A1100	3.35 in (85 mm)	5.75 in (146 mm)	2.76 in (70 mm)	4.13 in (105 mm)
A2100	3.35 in (85 mm)	8.90 in (226 mm)	2.76 in (70 mm)	7.09 in (180 mm)
A3100	5.94 in (151 mm)	9.49 in (241 mm)	5.31 in (135 mm)	7.87 in (200 mm)
A4100	5.94 in (151 mm)	9.49 in (241 mm)	5.31 in (135 mm)	7.87 in (200 mm)

Cable entries not drilled

(1) 0.43 in (11 mm) for XAPA4●●● stations with hinges

(2) 2 x Ø 0.22 in (5.6 mm) untapped holes, depth 0.47 in (12 mm)

Push Buttons and Operator Interface - XAP Enclosures

Glass-Reinforced Polyester Enclosures



XAPA1104

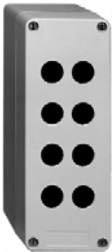

XAPA2108

Drilled Insulated Enclosures, Glass-Reinforced Polyester

Type	Number of Knock-outs 22 mm	Number of Rows		Catalog Number
		Vertical	Horizontal	
NEMA 4, 4X, 13 Usable depth 3.27 in (83 mm) 1.58 in (40 mm) centerline spacing of holes	1	1	1	XAPA1110
	2	1	2	XAPA1120
	4	2	2	XAPA1104
	8	2	4	XAPA2108
	16	4	4	XAPA3116

Drilled Grounding Plate	Sheet steel with ground screw	For XAPA1110	XAPZ110
		For XAPA1120	XAPZ120
		For XAPA1104	XAPZ104
		For XAPA2108	XAPZ208
		For XAPA3116	XAPZ316

Insulated enclosures with cut-outs
XAPA

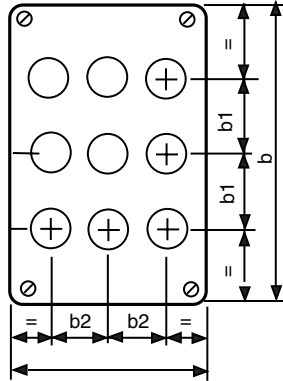
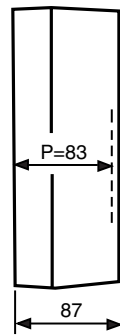

Fixing

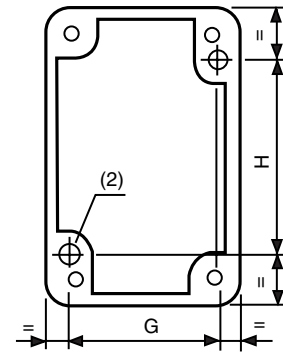

For Ø 22 mm control and signalling units

XAP	a	b	b1	b2	G	H
A1110	3.35 in (85 mm)	5.75 in (146 mm)	–	–	2.76 in (70 mm)	4.13 in (105 mm)
A1120	3.35 in (85 mm)	5.75 in (146 mm)	1.57 in (40 mm)	–	2.76 in (70 mm)	4.13 in (105 mm)
A1104	3.35 in (85 mm)	5.75 in (146 mm)	1.57 in (40 mm)	1.18 in (30 mm)	2.76 in (70 mm)	4.13 in (105 mm)
A2108	3.35 in (85 mm)	8.90 in (226 mm)	1.57 in (40 mm)	1.18 in (30 mm)	2.76 in (70 mm)	7.09 in (180 mm)
A3116	5.94 in (151 mm)	9.49 in (241 mm)	1.57 in (40 mm)	1.18 in (30 mm)	5.31 in (135 mm)	7.87 in (200 mm)

Cable entries not drilled

(2) 2 x Ø 0.22 in (5.6 mm) untapped holes, depth 0.47 in (12 mm)

Push Buttons and Operator Interface - XAP Enclosures Die Cast Enclosures



XAPG39400



XAPG29703

Undrilled Die Cast Enclosures (Painted Grey RAL 7032)

Type	Material	Usable Depth	H x W x D Dimensions	Catalog Number
NEMA Type 4, 13	Zinc	1.93 in (49 mm)	3.15 x 3.15 x 2.03 in (80 x 80 x 51.5 mm)	XAPG19100
			5.12 x 3.15 x 2.03 in (130 x 80 x 51.5 mm)	XAPG29100
			6.89 x 3.15 x 2.03 in (175 x 80 x 51.5 mm)	XAPG39100
		2.93 (74.5 mm)	3.15 x 3.15 x 3.03 in (80 x 80 x 77 mm)	XAPG19400
			5.12 x 3.15 x 3.03 in (130 x 80 x 77 mm)	XAPG29400
			6.89 x 3.15 x 3.03 in (175 x 80 x 77 mm)	XAPG39400
	Aluminum	2.93 (74.5 mm)	8.66 x 3.15 x 3.03 in (220 x 80 x 77 mm)	XAPG49400
			12.20 x 3.35 x 3.03 in (310 x 85 x 77 mm)	XAPG59400

Drilled Die Cast Enclosures (Painted Grey RAL 7032)

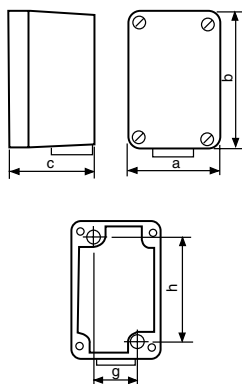

Type	Material	Usable Depth	Number of 22 mm knock-outs	Catalog Number
NEMA Type 4, 13 1.18 in (30 mm) centerline spacing of holes	Zinc	1.93 in (49 mm)	2	XAPG19702
			3	XAPG29703
			4	XAPG39704
		2.93 (74.5 mm)	2	XAPG19802
			3	XAPG29803
			4	XAPG39804
NEMA Type 4, 13 1.58 in (40 mm) centerline spacing of holes	Zinc	1.93 in (49 mm)	1	XAPG19201
			2	XAPG29202
			3	XAPG39203
		2.93 (74.5 mm)	1	XAPG19501
			2	XAPG29502
	3		XAPG39503	
	Aluminum	2.93 (74.5 mm)	4	XAPG49504
			5	XAPG59505

Catalog Number	a		b		c		g		h		Conduit opening supplied
	IN	mm	IN	mm	IN	mm	IN	mm	IN	mm	
XAPG19201	3.15	80	3.15	80	2.03	51.5	1.97	50	2.56	65	3/4" NPT
XAPG29202	3.15	80	5.12	130	2.03	51.5	1.97	50	4.53	115	3/4" NPT
XAPG39203	3.15	80	6.90	175	2.03	51.5	1.97	50	6.30	160	3/4" NPT
XAPG19501	3.15	80	3.15	80	3.03	77	1.97	50	2.56	65	3/4" NPT
XAPG29502	3.15	80	5.12	130	3.03	77	1.97	50	4.53	115	3/4" NPT
XAPG39503	3.15	80	6.90	175	3.03	77	1.97	50	6.30	160	3/4" NPT
XAPG49504	3.15	80	8.66	220	3.03	77	1.97	50	8.07	205	3/4" NPT
XAPG59505	3.35	85	12.20	310	3.03	77	2.16	55	11.60	295	3/4" NPT
XAPG19702	3.15	80	3.15	80	2.03	51.5	1.97	50	2.56	65	3/4" NPT
XAPG29703	3.15	80	5.12	130	2.03	51.5	1.97	50	4.53	115	3/4" NPT
XAPG39704	3.15	80	6.90	175	2.03	51.5	1.97	50	6.30	160	3/4" NPT
XAPG19802	3.15	80	3.15	80	3.03	77	1.97	50	2.56	65	3/4" NPT
XAPG29803	3.15	80	5.12	130	3.03	77	1.97	50	4.53	115	3/4" NPT
XAPG39804	3.15	80	6.90	175	3.03	77	1.97	50	6.30	160	3/4" NPT

Push Buttons and Operator Interface - XAP Enclosures

Flush Plates



XAPE301



XAPE302

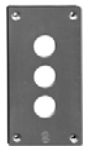

XAPE303



XAPE305

Drilled Flush Plates

Type	Material	Number of 22mm holes	H x W Dimensions in (mm)	Catalog Number
NEMA Type 4, 13 1.18 in (30 mm) centerline spacing of holes	Anodized Aluminum	1	2.83 x 2.83 in (72 x 72 mm)	XAPE301
		2	4.13 x 2.83 in (105 x 72 mm)	XAPE302
		3	5.43 x 2.83 in (138 x 72 mm)	XAPE303
		4	6.73 x 2.83 in (171 x 72 mm)	XAPE304
		5	8.03 x 2.83 in (204 x 72 mm)	XAPE305

Optional Back Box (for finger protection, if required)

Type	Material	Catalog Number	
Protective rear covers	Insulating Fiberglass	For flush plate XAPE301	XAPE901
		For flush plate XAPE302	XAPE902
		For flush plate XAPE303	XAPE903
		For flush plate XAPE304	XAPE904
		For flush plate XAPE305	XAPE905

Flush mounting enclosures
Front plate with cut-outs for Ø 22 mm control and signalling units
XAPE30●

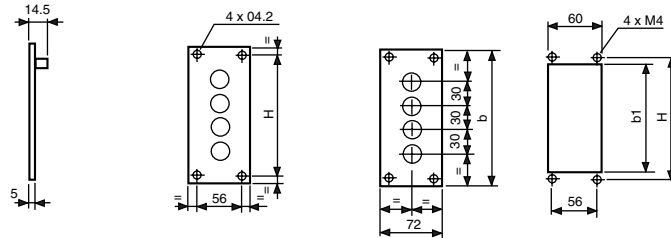

For Ø 22 mm control and signalling units

Front plate

XAP	b	b1	H
E301	2.83 in (72 mm)	1.73 in (44 mm)	2.20 in (56 mm)
E302	4.13 in (105 mm)	3.03 in (77 mm)	3.50 in (89 mm)
E303	5.43 in (138 mm)	4.33 in (110 mm)	4.80 in (122 mm)
E304	6.73 in (171 mm)	5.63 in (143 mm)	6.10 in (155 mm)
E305	8.03 in (204 mm)	6.93 in (176 mm)	7.40 in (188 mm)

Mounting of front plate and protective rear cover

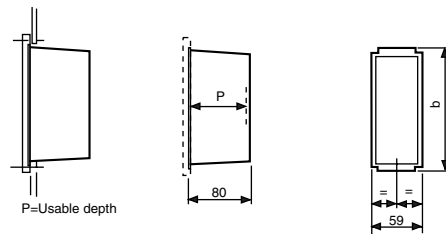

Protective rear cover for front plate XAPE30●

XAP	b	P
E901	2.05 in (52 mm)	3.25 in (82.5 mm)
E902	3.35 in (85 mm)	3.25 in (82.5 mm)
E903	4.65 in (118 mm)	3.25 in (82.5 mm)
E904	5.94 in (151 mm)	3.25 in (82.5 mm)
E905	7.24 in (184 mm)	3.25 in (82.5 mm)

Push Buttons and Operator Interface Specifier's Guide

Type K and SK 30 mm Push Buttons

Catalog
2005

File 9001



CONTENTS





Description	Page
Type K and SK Common Operators	124
Type K Heavy Duty Operators	125-138
Type K Voltage Assembly Codes	128
Type K and SK Selector Switch Selection Guide	129
Type K Heavy Duty Selector Switches	130
Type K Heavy Duty Pilot Lights	135
Type K Heavy Duty Joysticks	136
Type SK Corrosion Resistant Operators	139
Type SK Corrosion Resistant Selector Switches	142
Type SK Corrosion Resistant Potentiometers	146
Type SK Corrosion Resistant Pilot Lights	147
Type K, SK, KX, and T Light Modules	148
Type K, SK, KX, and T Contact Blocks	149
Hazardous Location Information	150
Type K and SK "H" Numbers	151
Type K and SK Legend Plates	152
Type K and SK Accessories	154, 157
Type K and SK Application Data and Materials	155
Type K and SK Replacement Parts	158
Type K and SK Dimensions	159
Declaration of Conformity	224







Push Buttons and Operator Interface - Type K and SK, 30 mm Common Operators

For use in hazardous locations – See page 150.





“START” Push Buttons

Operator Style	Description	Contact Block	Button Color	Type	Legend Plate
30.5 mm Industrial (Metal)			Black	KR1BH13	KN201SP
30.5 mm Corrosion Resistant (Non Metallic)			Black	SKR1BH13	KN101SP





“STOP” Push Buttons

Operator Style	Description	Contact Block	Button Color	Type	Legend Plate
30.5 mm Industrial (Metal)			Red	KR1RH13	KN202RP
30.5 mm Corrosion Resistant (Non Metallic)			Red	SKR1RH13	KN102RP



“OFF – ON” Selector Switch

Operator Style	Description	Contact Sequence	Knob Color	Type	Legend Plate
		Contact Block Included			
30.5 mm Industrial (Metal)			Black	KS11BH13	KN244SP
30.5 mm Corrosion Resistant (Non Metallic)			Black	SKS11BH13	KN144SP

“HAND – OFF – AUTO” Selector Switch

Operator Style	Description	Contact Sequence	Knob Color	Type	Legend Plate
		Contact Block Included			
30.5 mm Industrial (Metal)			Black	KS43BH13	KN260SP
30.5 mm Corrosion Resistant (Non Metallic)			Black	SKS43BH13	KN160SP



RED – 120 Vac – “ON” Pilot Light

Operator Style	Description	Type	Legend Plate
30.5 mm Industrial (Metal)		KP1R31	KN203SP
30.5 mm Corrosion Resistant (Non Metallic)		SKP1R31	KN103SP



GREEN – 120 Vac – “OFF” Pilot Light

Operator Style	Description	Type	Legend Plate
30.5 mm Industrial (Metal)		KP1G31	KN204SP
30.5 mm Corrosion Resistant (Non Metallic)		SKP1G31	KN104SP

RED – 120 Vac – “ON” Push-To-Test Pilot Light

Operator Style	Description	Type	Legend Plate
30.5 mm Industrial (Metal)		KT1R31	KN203SP
30.5 mm Corrosion Resistant (Non Metallic)		SKT1R31	KN103SP

GREEN – 120 Vac – “OFF” Push-To-Test Pilot Light

Operator Style	Description	Type	Legend Plate
30.5 mm Industrial (Metal)		KT1G31	KN204RP
30.5 mm Corrosion Resistant (Non Metallic)		SKT1G31	KN104RP



File E42259
CCN NKCR



File LR 25490
Class 3211 03







Marking

Push Buttons and Operator Interface - Type K and SK, 30 mm Heavy Duty Operators

Non-Illuminated Momentary Push Button Operators – UL Types 4, 13/NEMA Types 4, 13

For use in hazardous locations – See page 150.
Contact blocks and legend plate not included unless otherwise noted.

Description	Color	Operator With 1 N.O. and 1 N.C. Contact (KA1)	Operator With 1 N.O. Contact (KA2)	Operator With 1 N.C. Contact (KA3)	Operator Only With No Contacts ⑤	
 Full Guard	Black	KR1BH13	KR1BH5	KR1BH6	KR1B	
	Red	KR1RH13	KR1RH5	KR1RH6	KR1R	
	Green	KR1GH13	KR1GH5	KR1GH6	KR1G	
	Universal ①	KR1UH13	KR1UH5	KR1UH6	KR1U	
	Other ②	KR1②H13	KR1②H5	KR1②H6	KR1②	
 No Guard	Black	KR3BH13	KR3BH5	KR3BH6	KR3B	
	Red	KR3RH13	KR3RH5	KR3RH6	KR3R	
	Green	KR3GH13	KR3GH5	KR3GH6	KR3G	
	Universal ①	KR3UH13	KR3UH5	KR3UH6	KR3U	
	Other ②	KR3②H13	KR3②H5	KR3②H6	KR3②	
 Extended Guard	Black	KR2BH13	KR2BH5	KR2BH6	KR2B	
	Red	KR2RH13	KR2RH5	KR2RH6	KR2R	
	Green	KR2GH13	KR2GH5	KR2GH6	KR2G	
	Universal ①	KR2UH13	KR2UH5	KR2UH6	KR2U	
	Other ②	KR2②H13	KR2②H5	KR2②H6	KR2②	
 1 3/8" Diameter Mushroom Button	Snap-In Mushroom Button					
	Black	KR4BH13	KR4BH5	KR4BH6	KR4B	
	Red	KR4RH13	KR4RH5	KR4RH6	KR4R	
	Red ③	KR4R05H13	KR4R05H5	KR4R05H6	KR4R05	
	Green	KR4GH13	KR4GH5	KR4GH6	KR4G	
	Other ④	KR4④H13	KR4④H5	KR4④H6	KR4④	
	Screw-On Mushroom Button With Set Screw Security					
	Black	KR24BH13	KR24BH5	KR24BH6	KR24B	
	Red	KR24RH13	KR24RH5	KR24RH6	KR24R	
	Green	KR24GH13	KR24GH5	KR24GH6	KR24G	
	Other ④	KR24④H13	KR24④H5	KR24④H6	KR24④	
	 2 1/4" Diameter Mushroom Button	Snap-In Mushroom Button				
		Black	KR5BH13	KR5BH5	KR5BH6	KR5B
		Red	KR5RH13	KR5RH5	KR5RH6	KR5R
Red ③		KR5R05H13	KR5R05H5	KR5R05H6	KR5R05	
Green		KR5GH13	KR5GH5	KR5GH6	KR5G	
Other ④		KR5④H13	KR5④H5	KR5④H6	KR5④	
Screw-On Mushroom Button With Set Screw Security						
Black		KR25BH13	KR25BH5	KR25BH6	KR25B	
Red		KR25RH13	KR25RH5	KR25RH6	KR25R	
Green		KR25GH13	KR25GH5	KR25GH6	KR25G	
Other ④		KR25④H13	KR25④H5	KR25④H6	KR25④	

- ① The universal push button operators contain one each of the following color inserts: black, red, green, yellow, orange, blue and white.
 ② See table below.
 ③ Knob has the words "Emergency Stop" in raised letters highlighted in white for readability. Available in red snap-in mushroom buttons only.
 ④ See table below.
 ⑤ These operators can be ordered complete with contact blocks – for maximum block usage – see page 155. Add the "H" number chosen from page 151 to the end of the operator type number.
EXAMPLE: KR24B + H2(2 - KA1) = KR24BH2

Color	② For KR1, 2, 3 Choose Color and Place Code in Type Number	④ For KR4, 5, 24, 25 Choose Color and Place Code in Type Number
Blue	L	L
Yellow	Y	Y
White	W	–
Orange	S	S
Gray	E	–

Basic Operators	Page 155
Boots	Page 154
Contact Blocks	Pages 149-150
"H" Numbers	Page 151
Lamps	Page 148
Legend Plates	Pages 152-153
Light Modules	Page 148
Lockouts	Page 154
Outline Dimensions	Pages 159-160
Ratings	Pages 149-150
Replacement Parts	Page 158
Ring Nuts	Page 158
Color Inserts and Mushroom Knobs	Page 157

Push Buttons and Operator Interface - Type K and SK, 30 mm Heavy Duty Operators

Illuminated and Non-Illuminated Multifunction Operators

Meets UL Type 13/NEMA Type 13 and UL Type 6/NEMA Type 6, which UL and NEMA consider an equivalent to UL Type 4/NEMA Type 4.

For use in hazardous locations – See page 150.

Legend plate and contact blocks not included unless otherwise noted.

	Description	Color	With 2 N.O. Contacts (2 KA2)	With 1 N.O. & 1 N.C. Contact (KA2, KA3)	Without Contacts ⑨
	Momentary Dual Function	Universal ① Green-Red Other ②	KR6UH7 KR6GRH7 KR6②H7	KR6UH37 KR6GRH37 KR6②H37	KR6U KR6GR KR6②
	Momentary Interlocked Dual Function	Universal ① Green-Red Other ②	KR67UH7 KR67GRH7 KR67②H7	KR67UH37 KR67GRH37 KR67②H37	KR67U KR67GR KR67②
	Maintained Interlocked Dual Function	Universal ① Green-Red Other ②	KR7UH7 KR7GRH7 KR7②H7	KR7UH37 KR7GRH37 KR7②H37	KR7U KR7GR KR7②
	Description	Color	–	Contacts See ⑩ (KA2, KA3)	Without Contacts ⑨
	Both Buttons Maintained Interlocked Assembly	Universal ③ Other ④	–	KR11UH1 KR11④H1	KR11U KR11④
One Button Momentary One Button Maintained Interlocked Assembly	Universal ③ Other ④	–	KR12UH1H1 KR12④H1H1	KR12U KR12④	

 <p>1 5/8" Dia. Knob For 1 3/8" or 2 1/4" Dia. Knob - see ⑫ Includes Type KN379 Legend Plate Marked Pull To Start Push To Stop</p>	Description ⑫	Color	With 2 N.C. Contacts (1 KA3, 1 KA5)	With 1 N.O. 1 N.C. Contact (1 KA1)	Without Contacts ⑨	
	3 Position Momentary Pull - Maintained Neutral - Momentary Push Non-Illuminated	Red Green Other⑤	KR8RH25 KR8GH25 KR8⑤H25	– – –	– – –	KR8R KR8G KR8⑤
	2 Position Maintained Pull - Maintained Push Non-Illuminated	Red ① Green Other⑤	– – –	KR9RH13 KR9GH13 KR9⑤H13	– – –	KR9R KR9G KR9⑤

 <p>1 5/8" Dia. Knob For 1 3/8" or 2 1/4" Dia. Knob - see ⑫ Includes Type KN379 Legend Plate Marked Pull To Start Push To Stop</p>	Description ⑫	Voltage	With Red Knob With 2 N.C. Contacts (1 KA3, 1 KA5)	With Other Color Knob With 2 N.C. Contacts (1 KA3, 1 KA5)	With Other Color Knob Without Contacts ⑨
	3 Position Momentary Pull - Maintained Neutral - Momentary Push Illuminated	110-120 V, 50-60 Hz Other – Transformer, LED, Flashing ⑦ Other – Full Voltage, Resistor, Neon ⑧	KR8P1RH25 KR8P⑥RH25 KR8P⑥RH25	KR8P1⑤H25 KR8P⑥⑤H25 KR8P⑥⑤H25	KR8P1⑤ KR8P⑥⑤ KR8P⑥⑤
	Description ⑫	Voltage	With Red ① Knob With 1 N.O. & 1 N.C. Contact (KA1)	With Other Color Knob With 1 N.O. & 1 N.C. Contact (KA1)	With Other Color Knob Without Contacts
	2 Position Maintained Pull - Maintained Push Illuminated	110-120 V, 50-60 Hz Other – Transformer, LED, Flashing ⑦ Other – Full Voltage, Resistor, Neon ⑧	KR9P1RH13 KR9P⑥RH13 KR9P⑥RH13	KR9P1⑤H13 KR9P⑥⑤H13 KR9P⑥⑤H13	KR9P1⑤ KR9P⑥⑤ KR9P⑥⑤

① Universal for KR6, 67, 7 includes 2 inserts each of black, red and green.

② Choose one color for each button. R = red, G = green, B = Black.

EXAMPLE: A KR6 with left red and right black = KR6RB

③ Universal for KR11, 12 includes 2 each of black, red, green, yellow, orange, blue, white.

④ Choose one color for each button from table and insert color code in type number.

EXAMPLE: A KR11 with top button grey and bottom button orange = KR11ES

⑤ Choose one color from table and insert color code in type number.

EXAMPLE: KR9 with a yellow knob = KR9Y

⑥ Add the voltage assembly code as chosen from voltage assembly code table on page 128.

EXAMPLE: KR8P⑥ with a 277 V 50-60 Hz voltage = KR8PB

⑦ The color of the knob must be the same color as the LED voltage chosen (i.e., green LED uses green knob) or use clear knob.

⑧ On neon voltages use clear knobs only.

⑨ These operators can be ordered complete with contact blocks. For maximum block usage see page 155. Add the "H" number chosen from page 151 to the end of the operator type number.

EXAMPLE: KR67BB + H8(2 KA3) = KR67BBH8

⑩ KR11UH1 has 1 - KA1 (1 N.O., 1 N.C.) and KR12UH1H1 has 2 - KA1 (2 N.O., 2 N.C.).

① To obtain a red knob with "Push Emergency Stop" printed on the red knob – substitute "R05" in place of "R". Not available in 1 3/8" or 2 1/4" diameter knobs.

② For 1 3/8" or 2 1/4" Dia. Knob:

a) Order -20 or -21 knob from page 157.

b) Order 9001K54 adapter (no charge) - allows -20 or -21 knob to fit on push pull operators. Voids UL and NEMA Type 6 rating.

c) Can order assembled operator by replacing color code with -20 or -21. Example: 9001 KR9R would be 9001KR9R20 or 9001KR9R21. No price adder.

Other Color Code Selection

Color	KR6, KR7, KR67	KR11, KR12	KR8, KR9
Black	B	B	B*
Red	R	R	R
Green	G	G	G
Blue	–	L	L
Yellow	–	Y	Y
White	–	W	W
Orange	–	S	S*
Clear	–	–	C
Amber	–	–	A
Gray	–	E	–

* These colors are not available on illuminated push-pull operators.





**Voltage Assembly Codes
See Page 128**

Push Buttons and Operator Interface - Type K and SK, 30 mm Heavy Duty Operators

Illuminated Push Button Operators – UL Types 4, 13/NEMA Types 4, 13

For use in hazardous locations – See page 150.

Legend plate and contact block not included unless otherwise noted.

Description	Voltage and Frequency	Style	With Red Color Cap and 1 N.O. and 1 N.C. Contact (KA1)	With Green Color Cap and 1 N.O. and 1 N.C. Contact (KA1)	With Other Color Cap Without Contact Block ①
 Full Guard Illuminated Push Button Clear Plastic Top	110-120 V, 50-60 Hz	Transformer	K1L1RH13	K1L1GH13	K1L1⑤
	220-240 V, 50-60 Hz	Transformer	K1L7RH13	K1L7GH13	K1L7⑤
	24-28 Vac-dc	Full Voltage	K1L35RH13	K1L35GH13	K1L35⑤
	For other Voltages see Table ②	Transformer or Flashing	K1L②RH13	K1L②GH13	K1L②⑤
		Full Voltage	K1L②RH13	K1L②GH13	K1L②⑤
		Resistor or Neon ③	K1L②RH13	K1L②GH13	K1L②⑤
LED ④	K1L②RH13	K1L②GH13	K1L②⑤		
 Full Guard Illuminated Push Button Metal Top	110-120 V, 50-60 Hz	Transformer	K3L1RH13	K3L1GH13	K3L1⑤
	220-240 V, 50-60 Hz	Transformer	K3L7RH13	K3L7GH13	K3L7⑤
	24-28 Vac-dc	Full Voltage	K3L35RH13	K3L35GH13	K3L35⑤
	For other Voltages see Table ②	Transformer or Flashing	K3L②RH13	K3L②GH13	K3L②⑤
		Full Voltage	K3L②RH13	K3L②GH13	K3L②⑤
		Resistor or Neon ③	K3L②RH13	K3L②GH13	K3L②⑤
LED ④	K3L②RH13	K3L②GH13	K3L②⑤		
 No Guard Illuminated Push Button	110-120 V, 50-60 Hz	Transformer	K2L1RH13	K2L1GH13	K2L1⑤
	220-240 V, 50-60 Hz	Transformer	K2L7RH13	K2L7GH13	K2L7⑤
	24-28 Vac-dc	Full Voltage	K2L35RH13	K2L35GH13	K2L35⑤
	For other Voltages see Table ②	Transformer or Flashing	K2L②RH13	K2L②GH13	K2L②⑤
		Full Voltage	K2L②RH13	K2L②GH13	K2L②⑤
		Resistor or Neon ③	K2L②RH13	K2L②GH13	K2L②⑤
LED ④	K2L②RH13	K2L②GH13	K2L②⑤		
 1 3/8 Inch Illuminated Mushroom	110-120 V, 50-60 Hz	Transformer	K2L1R20H13	K2L1G20H13	Order K2L ②⑤ Above ⑥
	220-240 V, 50-60 Hz	Transformer	K2L7R20H13	K2L7G20H13	
	24-28 Vac-dc	Full Voltage	K2L35R20H13	K2L35G20H13	
	For other Voltages see Table ②	Transformer or Flashing	K2L②R20H13	K2L②G20H13	
		Full Voltage	K2L②R20H13	K2L②G20H13	
		Resistor or Neon ③	K2L②R20H13	K2L②G20H13	
LED④	K2L②R20H13	K2L②G20H13			
 2 1/4 Inch Illuminated Mushroom	110-120 V, 50-60 Hz	Transformer	K2L1R21H13	K2L1G21H13	Order K2L ②⑤ Above ⑥
	220-240 V, 50-60 Hz	Transformer	K2L7R21H13	K2L7G21H13	
	24-28 Vac-dc	Full Voltage	K2L35R21H13	K2L35G21H13	
	For other Voltages see Table ②	Transformer or Flashing	K2L②R21H13	K2L②G21H13	
		Full Voltage	K2L②R21H13	K2L②G21H13	
		Resistor or Neon ③	K2L②R21H13	K2L②G21H13	
LED④	K2L②R21H13	K2L②G21H13			

- ① These operators can be ordered complete with contact blocks, for maximum block usage see page 155. Add the "H" number chosen from page 151 to the end of the operator type number. **Example: K2L36R20+H2(2 KA1)=K2L36R20H2**
- ② Add the Voltage assembly code as chosen from Voltage assembly code table on page 128. **Example: K2L② with a 240 Vac-dc Voltage = K2L25**
- ③ On neon Voltages use clear color caps only.
- ④ The color of the color cap must be the same color as the LED Voltage chosen (i.e., red LED uses red color cap) or use clear color cap.
- ⑤ Add the color code as chosen from the color cap table. **Example: K2L25⑤ with a blue 1 3/8 mushroom button = K2L25L20**
- ⑥ The only difference between a no guard (K2L②) operator and mushroom button operators is the color cap.

Voltage Assembly Codes
See Page 128

Color Caps

Color	Color Codes		
	⑤ K1L K2L, K3L	⑤ 1 3/8 Inch Mushroom	⑤ 2 1/4 Inch Mushroom
Red	R	R20	R21
Green	G	G20	G21
Blue	L	L20	L21
Yellow	Y	Y20	Y21
White	W	W20	W21
Clear	C	C20	C21
Amber	A	A20	A21

Basic Operators	Page 155
Color Caps & Mushroom Knobs	Page 157
Basic Operators	Page 155
Boots	Page 154
Contact Blocks	Pages 149-150
"H" Numbers	Page 151
Lamps	Page 148
Legend Plates	Pages 152-153
Light Modules	Page 148
Lockouts	Page 154
Outline Dimensions	Pages 159-160
Ratings	Pages 149-150
Replacement Parts	Page 158
Ring Nuts	Page 158

Push Buttons and Operator Interface - Type K and SK, 30 mm Voltage Assembly Codes

This page lists light module code numbers that are used in operators listed on pages 126-127.

- Neon type light modules – use CLEAR color caps only.
- LED light modules use a lamp with 7 element LED clusters that provide illumination similar to incandescent illumination.
- LED light modules require the color cap color and the LED color be the same or use a clear color cap.

Voltage Assembly Codes

Voltage	Description	Voltage Assembly Code	Separate Light Module Type Number
6 Vac-dc	Full Voltage	31	KM31
6 Vac-dc	LED Red	31LR	KM31LR
6 Vac-dc	LED Green	31LG	KM31LG
6 Vac-dc	LED Yellow	31LY	KM31LY
12-14 Vac-dc	Full Voltage	32	KM32
12-14 Vac-dc	LED Red	32LR	KM32LR
12-14 Vac-dc	LED Green	32LG	KM32LG
12-14 Vac-dc	LED Yellow	32LY	KM32LY
18 Vac-dc	Resistor	33	KM33
24-28 Vac-dc	Full Voltage	35	KM35
24-28 Vac-dc	LED Red	35LR	KM35LR
24-28 Vac-dc	LED Green	35LG	KM35LG
24-28 Vac-dc	LED Yellow	35LY	KM35LY
32 Vac-dc	Resistor	23	KM23
48 Vac-dc	Full Voltage	36	KM36
48 Vac-dc	LED Red	36LR	KM36LR
48 Vac-dc	LED Green	36LG	KM36LG
48 Vac-dc	LED Yellow	36LY	KM36LY

Voltage	Description	Voltage Assembly Code	Separate Light Module Type Number
60 Vac-dc	Full Voltage	37	KM37
60 Vac-dc	LED Red	37LR	KM37LR
60 Vac-dc	LED Green	37LG	KM37LG
60 Vac-dc	LED Yellow	37LY	KM37LY
110-120 V, 25-30 Hz	Transformer	2	KM2
110-120 V, 50-60 Hz	Transformer	1	KM1
110-120 V, 50-60 Hz	Flashing	F1	KMF1
120 Vac-dc	Resistor	38	KM38
120 Vac Only	Neon *	11	KM11
120 Vac-dc	LED Red	38LR	KM38LR
120 Vac-dc	LED Green	38LG	KM38LG
120 Vac-dc	LED Yellow	38LY	KM38LY
208-220 V, 50-60 Hz	Transformer	3	KM3
220-240 V, 25-30 Hz	Transformer	4	KM4
220-240 V, 50-60 Hz	Transformer	7	KM7
220-240 V, 50-60 Hz	Flashing	F7	KMF7
240 Vac-dc	Resistor	25	KM25
240 Vac-dc	Neon *	12	KM12
277 V, 50-60 Hz	Transformer	8	KM8
380 Vac-dc	Neon *	13	KM13
380-480 V, 50-60 Hz	Transformer	5	KM5
480 Vac-dc	Neon *	14	KM14
550 Vac-dc	Neon *	5	KM15
550-600 V, 50-60 Hz	Transformer	6	KM6

*: Use clear color caps only with neon light modules.

Push Buttons and Operator Interface - Type K and SK, 30 mm Selector Switch Selection Guide

Shown below is a simplified method of selecting a selector switch to meet almost any combination of contact sequences.

Step No. 1

Determine the contact sequence(s) required. Set up a target table like the one shown for the example below.

Example:

Contact Sequence	↖	↑	↗
A	1	0	0
B	0	1	0
C	0	0	1

0 – contact open
1 – contact closed

Step No. 2

Look for a cam type common to all sequences in Table 1, 2 or 3. For the example above, Table 2 would be used. For the contact sequences A(1 0 0), B(0 1 0) and C(0 0 1) of the example above, cam types F and L are common to all 3 sequences.

Step No. 3

Next, the cam type common to all the sequences (If several cam types are common, choose one.) is used to find the operator type number. Go to the proper page number as indicated in the table below:

Number of Positions	Push Button Line	Page Number
2	Type K Type SK	130, 131, 142, 143
3	Type K Type SK	132, 133, 144, 145
4	Type K Type SK	134, 146

If for the example above:

- A manual return operator with a standard black knob is required and
- If the F cam type were chosen, the operator type number would be:
Type K Line – Class 9001 Type KS46B (From page 132)
Type SK Line – Class 9001 Type SKS46B (From page 144)
- If the L cam type were chosen, the operator type number would be:
Type K Line – Class 9001 Type KS401B (From page 132)
Type SK Line – Class 9001 Type SKS401B (From page 144)

Step No. 4:

Determine the contact blocks required by using the same table used for Step No. 2.

If for the example above:

- The F cam type were chosen:
A 9001KA3 mounted on side no. 2 would be used for sequence A(1 0 0).
A 9001KA3 mounted on side no. 1 would be used for sequence B(0 1 0).
A 9001KA2 mounted on side no. 1 or 2 would be used for sequence C(0 0 1).
- The L cam type were chosen:
A 9001KA2 mounted on side no. 2 would be used for sequence A(1 0 0).
A 9001KA2 mounted on side no. 1 or a 9001 KA3 mounted on side no. 2 would be used for sequence B(0 1 0).
A 9001KA3 mounted on side no. 1 would be used for sequence C(0 0 1).

One Type KA1 double circuit block can be used in place of one Type KA2 single circuit block and one Type KA3 single circuit block mounted on the same side.

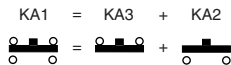

For "H" Numbers Page 151
For Outline Dimensions Pages 159-160

Table 1 – 2 Position Selector Switch

If you require contact sequence		Use Sel. Sw. with cam type	Use contact block type	Mount on side No. (See page 151)
↖	↗			
1	0	E	KA3	1 or 2
		D	KA2	1 or 2
0	1	E	KA2	1 or 2
		D	KA3	1 or 2

Table 2 – 3 Position Selector Switch

If you require contact sequence			Use Sel. Sw. with cam type	Use contact block type	Mount on side No. (See page 151)
↖	↑	↗			
1	0	0	G	KA2	1
			M	KA2	2
			C E L	KA3	1
			B C E F G J	KA3	2
0	1	0	B G J	KA5 *	2
			D E J L	KA2	1
			D E	KA2	2
			F	KA3	1
0	0	1	L	KA3	2
			C F	KA2	1 or 2
			B D G L	KA3	1
			B	KA5 *	1
1	1	0	M	KA2	2
			B	KA2	1
			C F	KA5 *	1 or 2
				KA3	2
0	1	1	G J	KA2	2
			G	KA5 *	1
			L	KA5 *	2
			M	KA3	1
1	0	1	J	KA3	1
			D E J L	KA5 *	1
			D E	KA5 *	2

Table 3 – 4 Position Selector Switch

If you require contact sequence				Use Sel. Sw. with cam type	Use contact block type	Mount on side No. (See page 151)
↖	↗	↘	↙			
1	0	0	0	H	(A) KA3	2
0	1	0	0	H	(B) KA2	1
0	0	1	0	H	(C) KA2	2
0	0	0	1	H	(D) KA3	1
1	0	0	1	H	A & D Wired in Parallel	
1	1	0	0	H	A & B Wired in Parallel	
0	1	1	0	H	B & C Wired in Parallel	
0	0	1	1	H	C & D Wired in Parallel	
1	1	1	0	H	A, B & C Wired in Parallel	
0	1	1	1	H	B, C & D Wired in Parallel	
1	0	1	0	H	A & C Wired in Parallel	
0	1	0	1	H	B & D Wired in Parallel	
1	1	0	1	H	KA5 *	2
1	0	1	1	H	KA5 *	1

*: The KA5 must be the last block on either side. If more than one KA5 is required on either side – contact your local Square D sales office.

Push Buttons and Operator Interface - Type K and SK, 30 mm Heavy Duty Selector Switches - Type K

Non-Illuminated 2 Position Selector Switch Operators – UL Types 4, 13/NEMA Types 4, 13

For use in hazardous locations – See page 150.
Legend plate and contact block not included unless noted.

Contact Block Required			1 — Contact Closed 0 — Contact Open			
Contact Block Position	Quantity and Type	Mount on Side	Left	Right	Left	Right
<p>Top View</p>	KA1	KA3	1	0	0	1
		KA2	0	1	1	0
	KA1	KA3	1	0	0	1
		KA2	0	1	1	0
CAM			E		D	
Non-Illuminated Operators			Type	Type		
Manual Return	Operator Only ①	Without Knob With Standard Black Knob With Other Color Knob (See Table)② Key Operated with E10 Key (Code 1,2,3)③④	KS11 KS11B KS11② KS11K③	KS12 KS12B KS12② KS12K③		
	With Contact Block(s)	With Standard Black Knob (See Table for Other Colors, Replace B in Type Number with Other Color Code) With 1 KA1 on Side #2 (H13) With 1 KA1 on Side #1 (H1) With 1 KA1 on Side #1 and 1 KA1 on Side #2 (H2)	KS11BH13 KS11BH1 KS11BH2	— — —		
Spring Return from Left	Operator Only ①	Without Knob With Standard Black Knob With Other Color Knob (See Table)② Key Operated with E10 Key (Code 2 only)④	KS25 KS25B KS25② KS25K2	— — — —		
Spring Return From Right	Operator Only ①	Without Knob With Standard Black Knob With Other Color Knob (See Table)② Key Operated with E10 Key (Code 1 Only)④	— — — —	KS34 KS34B KS34② KS34K1		

① These operators can be ordered complete with contact blocks, for maximum block usage – see page 155. Add the "H" number chosen from page 151 to the end of the operator type number.

Example: KS11K1+H13(KA1-SIDE 2)=KS11K1H13.

② Add the color code as chosen from knob color table at right.

Example: KS11② with a green gloved hand knob = KS11FG

③ Add the key withdrawal code from key withdrawal code table.

Example: KS11K③ that the key can be withdrawn in the right position only = KS11K2

④ All key operated devices are furnished as standard with Square D number E10 (key only part no. is 2941101100) key change. The following 20 additional key changes are available at no extra cost: **E11-E13, E16, E21-E26, E28-E33, CH501, CH674, SR251, T107.**

Occasionally it is desirable to have several devices with dissimilar key changes, but all operable by a single master key. The following key changes with master keying provisions are available.

Key No.	Total Key Changes Available	Master Key (E99)
		Part No.
E36 thru E60	25	2941151990

Example: For individual key, not master keyed an E29 is chosen. The type number is KS11K2E29.

All key operators come standard with 2 keys. Replacement keys can be purchased by specifying the key required i.e., E10, E24, E36 key only, etc.

Selector Switch Knobs

Color	Standard Knob		Gloved Hand Knob		Coin Operated	
	② Knob Code	Type	② Knob Code	Type	② Knob Code	Type
Black	B	B11	FB	B25	TB	B18
Red	R	R8	FR	R24	TR	R16
Green	G	G8	FG	G24	TG	G16
Yellow	Y	Y8	FY	Y24	TY	Y16
Orange	S	S11	FS	S25	—	—
Blue	L	L8	FL	L24	TL	L16
White	W	W8	FW	W24	—	—
Amber	A	A8	FA	A24	—	—
Clear	C	C8	FC	C24	TC	C16

③ Key Withdrawal Code

Code	↖	↗
1	Yes	No
Code	↖	↗
2	No	Yes
Code	↖	↗
3	Yes	Yes

Boots	Page 154
Contact Blocks	Pages 149-150
"H" Numbers	Page 151
Legend Plates	Pages 152-153
Lockouts	Page 154
Outline Dimensions	Pages 159-160
Ratings	Pages 149-150
Replacement Parts	Page 158
Ring Nuts	Page 158
Cams	Page 157

Push Buttons and Operator Interface - Type K and SK, 30 mm Heavy Duty Selector Switches - Type K

Illuminated 2 Position Selector Switch Operators – UL Types 4, 13/NEMA Types 4, 13

For use in hazardous locations – See page 150.

Legend plate and contact block not included unless noted.

Contact Block Required			1 — Contact Closed 0 — Contact Open			
Contact Block Position	Quantity and Type	Mount on Side	↖ ↗		↙ ↘	
			Left	Right	Left	Right
<p style="text-align: center;">Top View</p>	KA1 OR KA3	KA3 OR #2	1	0	0	1
	KA2	KA2 #2	0	1	1	0
	KA1 OR KA3	KA3 OR #1	1	0	0	1
	KA2	KA2 #1	0	1	1	0
CAM			E	D		
Illuminated Operators			Type	Type		
Manual Return ①			K11J1	K12J1		
Without Knob 110-120 V, 50-60 Hz			K11J1R	K12J1R		
With Standard Red Knob 110-120 V, 50-60 Hz			K11J②	K12J②		
Without Knob and Other Voltage Transformer, Flashing or LED ④			K11J②	K12J②		
Without Knob Full Voltage, Neon or Resistor ⑤			K11J②③	K12J②③		
With Other Color Knob and Other Voltage Transformer, Flashing or LED ④			K11J②③	K12J②③		
With Other Color Knob Full Voltage, Neon or Resistor ⑤			K11J②③	K12J②③		
Spring Return from Left ①			K25J1	—		
Without Knob 110-120 V, 50-60 Hz			K25J1R	—		
With Standard Red Knob 110-120 V, 50-60 Hz			K25J②	—		
Without Knob and Other Voltage Transformer, Flashing or LED ④			K25J②	—		
Without Knob Full Voltage, Neon or Resistor ⑤			K25J②③	—		
With Other Color Knob and Other Voltage Transformer, Flashing or LED ④			K25J②③	—		
With Other Color Knob Full Voltage, Neon or Resistor ⑤			K25J②③	—		
Spring Return From Right ①			—	K34J1		
Without Knob 110-120 V, 50-60 Hz			—	K34J1R		
With Standard Red Knob 110-120 V, 50-60 Hz			—	K34J②		
Without Knob and Other Voltage Transformer, Flashing or LED ④			—	K34J②		
Without Knob Full Voltage, Neon or Resistor ⑤			—	K34J②③		
With Other Color Knob and Other Voltage Transformer, Flashing or LED ④			—	K34J②③		
With Other Color Knob Full Voltage, Neon or Resistor ⑤			—	K34J②③		

① These operators can be ordered complete with contact blocks, for maximum block usage – see page 155. Add the “H” number chosen from page 151 to the end of the operator type number.

Example: K12J35FR-H2(2 KA1) = K12J35FRH2.

② Add the voltage assembly code as chosen from the voltage assembly code table below.

Example: K25J② with a 60 Vac-dc Voltage = K25J37.

③ Add the color code as chosen from the knob color table at right.

Example: K25J35③ with a green knob = K25J35G.

④ The color of the knob must be the same color as the LED voltage chosen (i.e., red LED use red knob) or use clear knob.

⑤ On neon voltages use clear knobs only.

Voltage Assembly Codes

Voltage	Description	Voltage Assembly Code	Separate Light Module Type Number
6 Vac-dc	Full Voltage	31	KM31
6 Vac-dc	LED Red	31LR	KM31LR
6 Vac-dc	LED Green	31LG	KM31LG
6 Vac-dc	LED Yellow	31LY	KM31LY
12-14 Vac-dc	Full Voltage	32	KM32
12-14 Vac-dc	LED Red	32LR	KM32LR
12-14 Vac-dc	LED Green	32LG	KM32LG
12-14 Vac-dc	LED Yellow	32LY	KM32LY
18 Vac-dc	Resistor	33	KM33
24-28 Vac-dc	Full Voltage	35	KM35
24-28 Vac-dc	LED Red	35LR	KM35LR
24-28 Vac-dc	LED Green	35LG	KM35LG
24-28 Vac-dc	LED Yellow	35LY	KM35LY
32 Vac-dc	Resistor	23	KM23
48 Vac-dc	Full Voltage	36	KM36
48 Vac-dc	LED Red	36LR	KM36LR
48 Vac-dc	LED Green	36LG	KM36LG
48 Vac-dc	LED Yellow	36LY	KM36LY
60 Vac-dc	Full Voltage	37	KM37
60 Vac-dc	LED Red	37LR	KM37LR
60 Vac-dc	LED Green	37LG	KM37LG
60 Vac-dc	LED Yellow	37LY	KM37LY
110-120 V, 25-30 Hz	Transformer	2	KM2
110-120 V, 50-60 Hz	Transformer	1	KM1
110-120 V, 50-60 Hz	Flashing	F1	KMF1
120 Vac-dc	Resistor	38	KM38
120 Vac Only	Neon *	11	KM11
120 Vac-dc	LED Red	38LR	KM38LR
120 Vac-dc	LED Green	38LG	KM38LG
120 Vac-dc	LED Yellow	38LY	KM38LY
208-220 V, 50-60 Hz	Transformer	3	KM3
220-240 V, 25-30 Hz	Transformer	4	KM4
220-240 V, 50-60 Hz	Transformer	7	KM7
220-240 V, 50-60 Hz	Flashing	F7	KMF7
240 Vac-dc	Resistor	25	KM25
240 Vac-dc	Neon *	12	KM12
277 V, 50-60 Hz	Transformer	8	KM8
380 Vac-dc	Neon *	13	KM13
380-480 V, 50-60 Hz	Transformer	5	KM5
480 Vac-dc	Neon *	14	KM14
550 Vac-dc	Neon *	15	KM15
550-600 V, 50-60 Hz	Transformer	6	KM6

* Use clear color caps only with neon light modules.

Two Color Selector Switch

Used to indicate red in left position and green in right position on illuminated operators.

Knob	Factory Assembled Form Number ▲
Standard	Y178
Gloved Hand	Y1781

▲ Add form number to standard Type number, e.g. Type K11J1 Form Y178.

Selector Switch Knobs

Color	Standard Knob		Gloved Hand Knob		Coin Operated	
	③ Knob Code	Type	③ Knob Code	Type	③ Knob Code	Type
Red	R	R8	FR	R24	TR	R16
Green	G	G8	FG	G24	TG	G16
Yellow	Y	Y8	FY	Y24	TY	Y16
Blue	L	L8	FL	L24	TL	L16
White	W	W8	FW	W24	—	—
Amber	A	A8	FA	A24	—	—
Clear	C	C8	FC	C24	TC	C16

Boots	Page 154
Contact Blocks	Pages 149-150
“H” Numbers	Page 151
Lamps	Page 148
Legend Plates	Pages 152-153
Lockouts	Page 154
Outline Dimensions	Pages 159-160
Ratings	Pages 149-150
Replacement Parts	Page 158
Ring Nuts	Page 158
Cams	Page 157

Push Buttons and Operator Interface - Type K and SK, 30 mm Heavy Duty Selector Switches - Type K

Non-Illuminated 3 Position Selector Switch Operators – UL Types 4, 13/NEMA Types 4, 13

For use in hazardous locations – See page 150. Legend Plate and Contact Block Not Included Unless Noted

CONTACT BLOCK REQUIRED				1 — Contact Closed 0 — Contact Open											
Contact Block Position	Quantity and Type	Mount on Side	Center	Center		Center		Center		Center		Center		Center	
				↖ ↗	↖ ↗	↖ ↗	↖ ↗	↖ ↗	↖ ↗	↖ ↗	↖ ↗	↖ ↗	↖ ↗	↖ ↗	↖ ↗
				Left	Right	Left	Right	Left	Right	Left	Right	Left	Right	Left	Right
<p>Top View</p>	KA1 OR KA3	KA1 #2	KA3 #2	1	0	0	1	0	0	0	0	1	1	0	0
	KA1 OR KA2	KA1 #2	KA2 #2	0	1	1	0	0	1	0	0	1	0	0	0
	KA1 OR KA3	KA1 #1	KA3 #1	0	0	1	1	0	0	1	0	0	0	1	1
	KA1 OR KA2	KA1 #1	KA2 #1	1	1	0	0	0	1	0	0	1	0	0	1
CAM				B	C	D	E	F	G	J	L	M			
Non-Illuminated Operators				Type	Type	Type	Type	Type	Type	Type	Type	Type	Type	Type	
Manual Return	Operator Only ①	Without Knob With Standard Black Knob With Other Color Knob (See Table) ② Key Operated with E10 Key (Code 4 through 10) ③④	KS42 KS42B KS42② KS42K③	KS43 KS43B KS43② KS43K③	KS44 KS44B KS44② KS44K③	KS45 KS45B KS45② KS45K③	KS46 KS46B KS46② KS46K③	KS47 KS47B KS47② KS47K③	KS49 KS49B KS49② KS49K③	KS401 KS401B KS401② KS401K③	KS402 KS402B KS402② KS402K③				
	With Contact Block(s)	With Standard Black Knob (See Table for Other Colors, Replace B in Type Number with Other Color Code) With 1 KA1 on side #2 (H13) With 1 KA1 on side #1 (H1) With 1 KA1 on side #1 and 1 KA1 on side #2 (H2)	KS42BH13 KS42BH1 KS42BH2	KS43BH13 KS43BH1 KS43BH2	KS44BH13 KS44BH1 KS44BH2	KS45BH13 KS45BH1 KS45BH2	KS46BH13 KS46BH1 KS46BH2	KS47BH13 KS47BH1 KS47BH2	KS49BH13 KS49BH1 KS49BH2	KS401BH13 KS401BH1 KS401BH2	KS402BH13 KS402BH1 KS402BH2				
Spring Return From Left to Center	Operator Only ①	Without Knob With Standard Black Knob With Other Color Knob (See Table) ② Key Operated with E10 Key (Code 5, 6 or 9 only) ③④	KS62 KS62B KS62② KS62K③	KS63 KS63B KS63② KS63K③	KS64 KS64B KS64② KS64K③	KS65 KS65B KS65② KS65K③	KS66 KS66B KS66② KS66K③	KS67 KS67B KS67② KS67K③	KS69 KS69B KS69② KS69K③	KS601 KS601B KS601② KS601K③	KS602 KS602B KS602② KS602K③				
Spring Return From Right to Center	Operator Only ①	Without Knob With Standard Black Knob With Other Color Knob (See Table) ② Key Operated with E10 Key (Code 4, 5 or 7 Only) ③④	KS72 KS72B KS72② KS72K③	KS73 KS73B KS73② KS73K③	KS74 KS74B KS74② KS74K③	KS75 KS75B KS75② KS75K③	KS76 KS76B KS76② KS76K③	KS77 KS77B KS77② KS77K③	KS79 KS79B KS79② KS79K③	KS701 KS701B KS701② KS701K③	KS702 KS702B KS702② KS702K③				
Spring Return Both Sides to Center	Operator Only ①	Without Knob With Standard Black Knob With Other Color Knob (See Table) ② Key Operated with E10 Key (Code 5 Only) ③④	KS52 KS52B KS52② KS52K5	KS53 KS53B KS53② KS53K5	KS54 KS54B KS54② KS54K5	KS55 KS55B KS55② KS55K5	KS56 KS56B KS56② KS56K5	KS57 KS57B KS57② KS57K5	KS59 KS59B KS59② KS59K5	KS501 KS501B KS501② KS501K5	KS502 KS502B KS502② KS502K5				

① These operators can be ordered complete with contact blocks, for maximum block usage – see page 155. Add the "H" number chosen from page 151 to the end of the operator type number.

EXAMPLE: KS43K6+H13(KA1-SIDE 2)=KS43K6H13.

② Add the color code as chosen from knob color table at right.

EXAMPLE: KS43② with a green gloved hand knob = KS43FG

③ Add the key withdrawal code from key withdrawal code table below.

EXAMPLE: KS43K③ that the key can be withdrawn in the right position only = KS43K6

④ All key operated devices are furnished as standard with Square D number E10 (key only part no. is 2941101100) key change. The following 20 additional key changes are available at no extra cost:

E11-E13, E16, E21-E26, E28-E33, CH501, CH674, SR251, T107.

Occasionally it is desirable to have several devices with dissimilar key changes, but all operable by a single master key. The following key changes with master keying provisions are available.

Key No.	Total Key Changes Available	Master Key (E99)
		Part No.
E36 thru E60	25	2941151990

EXAMPLE: For individual key, not master keyed an E29 is chosen. The type number is KS43K6E29.

All key operators come standard with 2 keys. Replacement keys can be purchased by specifying the key required i.e., E10, E24, E36 key only, etc.

Selector Switch Knobs

Color	Standard Knob		Gloved Hand Knob		Coin Operated	
	② Knob Code	Type	② Knob Code	Type	② Knob Code	Type
Black	B	B11	FB	B25	TB	B18
Red	R	R8	FR	R24	TR	R16
Green	G	G8	FG	G24	TG	G16
Yellow	Y	Y8	FY	Y24	TY	Y16
Orange	S	S11	FS	S25	-	-
Blue	L	L8	FL	L24	TL	L16
White	W	W8	FW	W24	-	-
Amber	A	A8	FA	A24	-	-
Clear	C	C8	FC	C24	TC	C16

3-Position Switches

③ Code	↖	↗	↘	③ Code	↖	↗	↘
4	Yes	No	No	8	Yes	No	Yes
5	No	Yes	No	9	No	Yes	Yes
6	No	No	Yes	10	Yes	Yes	Yes
7	Yes	Yes	No				

Basic Operators	Page 155
Boots	Page 154
Contact Blocks	Pages 149-150
"H" Numbers	Page 151
Legend Plates	Pages 152-153
Lockouts	Page 154
Outline Dimensions	Pages 159-160
Ratings	Pages 149-150
Replacement Parts	Page 158
Ring Nuts	Page 158
Cams	Page 157

Push Buttons and Operator Interface - Type K and SK, 30 mm Heavy Duty Selector Switches - Type K

Illuminated 3 Position Selector Switch Operators

For use in hazardous locations – See page 150. Legend Plate and Contact Block Not Included Unless Noted

CONTACT BLOCK REQUIRED			1 — Contact Closed 0 — Contact Open											
Contact Block Position	Quantity and Type	Mount on Side	Center		Center		Center		Center		Center		Center	
			↕↕↕ Left	↕↕↕ Right	↕↕↕ Left	↕↕↕ Right	↕↕↕ Left	↕↕↕ Right	↕↕↕ Left	↕↕↕ Right	↕↕↕ Left	↕↕↕ Right	↕↕↕ Left	↕↕↕ Right
<p style="text-align: center;">Top View</p>	KA1 OR KA3	KA1 #2 OR KA3 #2	1 0 0	1 0 0	0 0 1	1 0 0	1 0 0	1 0 0	1 0 0	1 0 0	0 1 0	1 1 0		
	KA2		KA2 #2	0 1 1	0 0 1	0 1 0	0 1 0	0 0 1	0 1 1	0 1 1	1 0 0	0 0 1		
	KA1 OR KA3	KA1 #1 OR KA3 #1	0 0 1	1 0 0	0 0 1	1 0 0	0 1 0	0 0 1	1 0 1	0 0 1	0 0 1	0 1 1		
	KA2		KA2 #1	1 1 0	0 0 1	0 1 0	0 1 0	0 0 1	1 0 0	0 1 0	0 1 0	1 0 0		
			B	C	D	E	F	G	J	L	M			
Non-Illuminated Operators			Type	Type	Type	Type	Type	Type	Type	Type	Type	Type		
Manual Return ①	Without Knob 110-120 V, 50-60 Hz	K42J1	K43J1	K44J1	K45J1	K46J1	K47J1	K49J1	K401J1	K402J1				
	With Standard Red Knob 110-120 V, 50-60 Hz	K42J1R	K43J1R	K44J1R	K45J1R	K46J1R	K47J1R	K49J1R	K401J1R	K402J1R				
	Without Knob and Other Voltages Transformer, Flashing or LED④	K42J2	K43J2	K44J2	K45J2	K46J2	K47J2	K49J2	K401J2	K402J2				
	Without Knob Full Voltage, Neon or Resistor⑤	K42J2③	K43J2③	K44J2③	K45J2③	K46J2③	K47J2③	K49J2③	K401J2③	K402J2③				
	With Other Color Knob and Other Voltage Transformer, Flashing or LED④	K42J2③	K43J2③	K44J2③	K45J2③	K46J2③	K47J2③	K49J2③	K401J2③	K402J2③				
Spring Return Left To Center ①	Without Knob 110-120 V, 50-60 Hz	K62J1	K63J1	K64J1	K65J1	K66J1	K67J1	K69J1	K601J1	K602J1				
	With Standard Red Knob 110-120 V, 50-60 Hz	K62J1R	K63J1R	K64J1R	K65J1R	K66J1R	K67J1R	K69J1R	K601J1R	K602J1R				
	Without Knob and Other Voltage Transformer, Flashing or LED④	K62J2	K63J2	K64J2	K65J2	K66J2	K67J2	K69J2	K601J2	K602J2				
	Without Knob Full Voltage, Neon or Resistor⑤	K62J2③	K63J2③	K64J2③	K65J2③	K66J2③	K67J2③	K69J2③	K601J2③	K602J2③				
	With Other Color Knob Full Voltage, Neon or Resistor⑤	K62J2③	K63J2③	K64J2③	K65J2③	K66J2③	K67J2③	K69J2③	K601J2③	K602J2③				
Spring Return Right To Center ①	Without Knob 110-120 V, 50-60 Hz	K72J1	K73J1	K74J1	K75J1	K76J1	K77J1	K79J1	K701J1	K702J1				
	With Standard Red Knob 110-120 V, 50-60 Hz	K72J1R	K73J1R	K74J1R	K75J1R	K76J1R	K77J1R	K79J1R	K701J1R	K702J1R				
	Without Knob and Other Voltage Transformer, Flashing or LED④	K72J2	K73J2	K74J2	K75J2	K76J2	K77J2	K79J2	K701J2	K702J2				
	Without Knob Full Voltage, Neon or Resistor⑤	K72J2③	K73J2③	K74J2③	K75J2③	K76J2③	K77J2③	K79J2③	K701J2③	K702J2③				
	With Other Color Knob and Other Voltage Transformer, Flashing or LED④	K72J2③	K73J2③	K74J2③	K75J2③	K76J2③	K77J2③	K79J2③	K701J2③	K702J2③				
Spring Return Both Sides To Center ①	Without Knob 110-120 V, 50-60 Hz	K52J1	K53J1	K54J1	K55J1	K56J1	K57J1	K59J1	K501J1	K502J1				
	With Standard Red Knob 110-120 V, 50-60 Hz	K52J1R	K53J1R	K54J1R	K55J1R	K56J1R	K57J1R	K59J1R	K501J1R	K502J1R				
	Without Knob and Other Voltage Transformer, Flashing or LED④	K52J2	K53J2	K54J2	K55J2	K56J2	K57J2	K59J2	K501J2	K502J2				
	Without Knob Full Voltage, Neon or Resistor⑤	K52J2③	K53J2③	K54J2③	K55J2③	K56J2③	K57J2③	K59J2③	K501J2③	K502J2③				
	With Other Color Knob and Other Voltage Transformer, Flashing or LED④	K52J2③	K53J2③	K54J2③	K55J2③	K56J2③	K57J2③	K59J2③	K501J2③	K502J2③				

① These operators can be ordered complete with contact blocks, for maximum block usage – see page 155. Add the "H" number chosen from page 151 to the end of the operator type number.

EXAMPLE: K43J35+H(2 KA1)=K43J35FRH2

② Add the voltage assembly code as chosen from voltage assembly code table on page 134.

EXAMPLE: K43J2 with a 60 Vac-dc voltage=K43J37

③ Add the color code as chosen from knob color table below.

EXAMPLE: K43J35③ with a green knob = K43J35G

④ The color of the knob must be the same color as the LED voltage chosen (i.e. red LED use red knob) or use a clear knob.

⑤ On neon voltages use clear knobs only.

Voltage Assembly Codes
See Page 134

Basic Operators	Page 155
Boots	Page 154
Contact Blocks	Pages 149-150
"H" Numbers	Page 151
Lamps	Page 148
Legend Plates	Pages 152-153
Light Modules	Page 148
Two Color Selector Switch	Page 131
Lockouts	Page 154
Outline Dimensions	Pages 159-160
Ratings	Pages 149-150
Replacement Parts	Page 158
Ring Nuts	Page 158
Cams	Page 157

Selector Switch Knobs

Color	Standard Knob		Gloved Hand Knob		Coin Operated	
	Knob Code ③	Type	Knob Code ③	Type	Knob Code ③	Type
Black	B	B11 *	FB	B25 *	TB	B18 *
Red	R	R8	FR	R24	TR	R16
Green	G	G8	FG	G24	TG	G16
Yellow	Y	Y8	FY	Y24	TY	Y16
Orange	S	S11 *	FS	S25 *	-	-
Blue	L	L8	FL	L24	TL	L16
White	W	W8	FW	W24	-	-
Amber	A	A8	FA	A24	-	-
Clear	C	C8	FC	C24	TC	C16

* Non-Illuminated only.

Push Buttons and Operator Interface - Type K and SK, 30 mm Heavy Duty Selector Switches - Type K

Non-Illuminated and Illuminated 4 Position Selector Switch Operators

For use in hazardous locations – See page 150.

UL Types 4, 13/NEMA Types 4, 13

Legend Plate and Contact Block Not Included Unless Noted

CONTACT BLOCK REQUIRED			1 — Contact Closed 0 — Contact Open	
Contact Block Position	Quantity and Type	Mount on Side		
<p>Top View</p>	KA1 OR KA3	KA3 #2	1 0 0 0	
	KA2 OR KA3	KA2 #2	0 0 1 0	
	KA1 OR KA3	KA3 #1	0 0 0 1	
	KA2 OR KA3	KA2 #1	0 1 0 0	
Non-Illuminated Operators			Cam	Type
Manual Return ①				
Operator Only ①				
Without Knob			H	KS88
With Standard Black Knob			H	KS88B
With Other Color Knob (See Table) ②			H	KS88 ②
Key Operated with E10 Key (Codes 11,12,13,14,15) ③④			H	KS88K ③
Spring Return From Left - Spring Return From Right - Maintained in the Two Mid Positions				
Operator Only ①				
Without Knob			H	KS89
With Standard Black Knob			H	KS89B
With Other Color Knob (See Table) ②			H	KS89②
Illuminated Operators			Cam	Type
Manual Return ①				
Without Knob 110-120 V, 50-60 Hz			H	K88J1
With Standard Red Knob 110-120 V, 50-60 Hz			H	K88J1R
Without Knob and With Other Voltages Transformer, Flashing or LED ⑥			H	K88J⑤
Without Knob Full Voltage, Neon or Resistor ⑦			H	K88J⑤
With Other Color Knob and Other Voltage Transformer, Flashing or LED ⑥			H	K88J⑤②
With Other Color Knob Full Voltage, Neon or Resistor ⑦			H	K88J⑤②
Spring Return From Left - Spring Return From Right - Maintained in the Two Mid Positions				
Without Knob 110-120 V, 50-60 Hz			H	K89J1
With Standard Red Knob 110-120 V, 50-60 Hz			H	K89J1R
Without Knob and With Other Voltages Transformer, Flashing or LED ⑥			H	K89J⑤
Without Knob Full Voltage, Neon or Resistor ⑦			H	K89J⑤
With Other Color Knob and Other Voltage Transformer, Flashing or LED ⑥			H	K89J⑤②
With Other Color Knob Full Voltage, Neon or Resistor ⑦			H	K89J⑤②

① These operators can be ordered complete with contact blocks, for maximum block usage – see page 155. Add the "H" number chosen from page 151 to the end of the operator type number.

EXAMPLE: KS88K11 + H13(KA1-SIDE 2) = KS88K11H13.

② Add the color code as chosen from knob color table

EXAMPLE: KS88② with a green gloved hand knob = KS88FG

③ Add the key withdrawal code from key withdrawal code table below.

EXAMPLE: KS88K③ that the key can be withdrawn in the right position only = KS88K12

④ All key operated devices are furnished as standard with Square D number E10 (key only part no. is 2941101100) key change. The following 20 additional key changes are available at no extra cost: E11-E13, E16, E21-E26, E28-E33, CH501, CH674, SR251, T107. Occasionally it is desirable to have several devices with dissimilar key changes, but all operable by a single master key. The following key changes with master keying provisions are available.

Key No.	Total Key Changes Available	Master Key (E99)
		Part No.
E36 thru E60	25	2941151990

EXAMPLE: For individual key, not master keyed an E29 is chosen. The type number is KS88K11E29.

All key operators come standard with 2 keys. Replacement keys can be purchased by specifying the key required i.e., E10, E24, E36 key only, etc.

⑤ Add the voltage assembly code as chosen from voltage assembly code table below.

EXAMPLE: K88J⑤ with a 60 Vac-dc voltage = K88J37

⑥ The color of the knob must be the same color as the LED voltage chosen, (i.e., red LED use red knob) or use clear knob.

⑦ On neon voltages use clear knobs only.

Voltage Assembly Codes

Voltage	Description	Voltage Assembly Code	Separate Light Module Type Number
6 Vac-dc	Full Voltage	31	KM31
6 Vac-dc	LED Red	31LR	KM31LR
6 Vac-dc	LED Green	31LG	KM31LG
6 Vac-dc	LED Yellow	31LY	KM31LY
12-14 Vac-dc	Full Voltage	32	KM32
12-14 Vac-dc	LED Red	32LR	KM32LR
12-14 Vac-dc	LED Green	32LG	KM32LG
12-14 Vac-dc	LED Yellow	32LY	KM32LY
18 Vac-dc	Resistor	33	KM33
24-28 Vac-dc	Full Voltage	35	KM35
24-28 Vac-dc	LED Red	35LR	KM35LR
24-28 Vac-dc	LED Green	35LG	KM35LG
24-28 Vac-dc	LED Yellow	35LY	KM35LY
32 Vac-dc	Resistor	23	KM23
48 Vac-dc	Full Voltage	36	KM36
48 Vac-dc	LED Red	36LR	KM36LR
48 Vac-dc	LED Green	36LG	KM36LG
48 Vac-dc	LED Yellow	36LY	KM36LY
60 Vac-dc	Full Voltage	37	KM37
60 Vac-dc	LED Red	37LR	KM37LR
60 Vac-dc	LED Green	37LG	KM37LG
60 Vac-dc	LED Yellow	37LY	KM37LY
110-120 V, 25-30 Hz	Transformer	2	KM2
110-120 V, 50-60 Hz	Transformer	1	KM1
110-120 V, 50-60 Hz	Flashing	F1	KMF1
120 Vac-dc	Resistor	38	KM38
120 Vac Only	Neon *	11	KM11
120 Vac-dc	LED Red	38LR	KM38LR
120 Vac-dc	LED Green	38LG	KM38LG
120 Vac-dc	LED Yellow	38LY	KM38LY
208-220 V 50-60 Hz	Transformer	3	KM3
220-240 V 25-30 Hz	Transformer	4	KM4
220-240 V 50-60 Hz	Transformer	7	KM7
220-240 V 50-60 Hz	Flashing	F7	KMF7
240 Vac-dc	Resistor	25	KM25
240 Vac-dc	Neon *	12	KM12
277 V, 50-60 Hz	Transformer	8	KM8
380 Vac-dc	Neon *	13	KM13
380-480 V, 50-60 Hz	Transformer	5	KM5
480 Vac-dc	Neon *	14	KM14
550 Vac-dc	Neon *	15	KM15
550-600 V, 50-60 Hz	Transformer	6	KM6

* Use clear color caps only with neon light modules.

③ Key Withdrawal Code:

4-Position Switches				
Code				
11	Yes	No	No	Yes
12	No	No	No	Yes
13	Yes	No	No	No
14	Yes	Yes	Yes	Yes
15	No	Yes	Yes	Yes

Selector Switch Knobs

Color			
	Standard Knob	Gloved Hand Knob	Coin Operated





② See table on page 132.

Basic Operators	Page 155
Boots	Page 154
Contact Blocks	Pages 149-150
"H" Numbers	Page 151
Lamps	Page 148
Legend Plates	Pages 152-153
Lockouts	Page 154
Outline Dimensions	Pages 159-160
Ratings	Pages 149-150
Replacement Parts	Page 158
Ring Nuts	Page 158
Cams	Page 157

Push Buttons and Operator Interface - Type K and SK, 30 mm Heavy Duty Pilot Lights - Type K

Pilot Lights – UL Types 4, 13/NEMA Type 4 & 13

For use in hazardous locations – See page 150. Legend Plates Not Included

Description	Voltage	Style	With Red Fresnel Color Cap	With Green Fresnel Color Cap	With Other Color Cap	Without Color Cap
 Standard Pilot Light (Plastic fresnel Color Cap Shown)	110-120 V, 50-60 Hz 220-240 V, 50-60 Hz 24-28 Vac-dc For Other Voltages See Table ①	Transformer Transformer Full Voltage Transformer, Flashing or LED ③ Full Voltage, Neon or Resistor ④	KP1R31 KP7R31 KP35R31 KP①R31 KP①R31	KP1G31 KP7G31 KP35G31 KP①G31 KP①G31	KP1 ② KP7 ② KP35 ② KP ①② KP ①②	KP1 KP7 KP35 KP ① KP ①
 Push To Test Pilot Light (Glass Color Cap Shown)	110-120 V, 50-60 Hz 220-240 V, 50-60 Hz 24-28 Vac-dc For Other Voltages See Table ①	Transformer Transformer Full Voltage Transformer, Flashing or LED ③ Full Voltage, Neon or Resistor ④	KT1R31 KT7R31 KT35R31 KT①R31 KT①R31	KT1G31 KT7G31 KT35G31 KT①G31 KT①G31	KT1 ② KT7 ② KT35 ② KT ①② KT ①②	KT1 KT7 KT35 KT ① KT ①
 Remote Test Pilot Light (Glass Color Cap Shown)	120 Vac Only 24-28 Vac Only For Other Voltages See Table ①⑤	Resistor ⑤ Full Voltage ⑤ Full Voltage or Resistor ⑤	KTR38R31 KTR35R31 KTR①R31	KTR38G31 KTR35G31 KTR①G31	KTR38 ② KTR35 ② KTR ①②	KTR38 KTR35 KTR ①
 Pilot Light For Intrinsically Safe Circuits (NEMA Type 4X)	Intrinsically safe equipment must not release electrical or thermal energy capable of igniting certain explosive or combustible hazardous atmospheres, for which the equipment has been tested. These pilot lights are intrinsically safe when used with a suitable approved barrier or barrier relay (Class 8501 Type TO or NY2). These pilot lights are Factory Mutual (FM approved). Consult your local Square D Sales Office for further details. These pilot lights are fully encapsulated – there are no replaceable parts – except for the SK40 ring nut. Use KN100 series plastic legend plates as shown on pages 152 and 153.		KP44R	KP44G	KP44Y (Yellow Color Cap)	—
	Operating Voltage Range	Nominal Current				
	20-30 V AC/DC	25 mA				

- ① Add the voltage assembly code as chosen from voltage assembly code table on page 134. **EXAMPLE: KT①R31 with a 60VAC red LED voltage=KT37LRR31**
- ② Add the color code as chosen from the color cap table. **EXAMPLE: KP1② with a blue fresnel cap = KP1L31**
- ③ The color cap must be the same color as the LED voltage chosen (i.e., green LED use a green color cap) or use clear cap.
- ④ On neon voltages use clear color caps only.
- ⑤ On remote test pilot lights use only full voltage or resistor voltage assembly codes. Do not choose LED, neon or transformer codes. For AC use only.

**Voltage Assembly Codes
See Page 134**

Push-To-Test Ground Detector Pilot Light (Contact Block Included — But NOT Legend Plate or Color Cap)

Used in pairs to indicate a grounded condition in a control circuit fed from a grounded center-tapped transformer. The Type KT50 is commonly used in press control circuits, and fulfills the requirements of the ground detector called for in ANSI B11.1 (1971), Par. E3.6.5. Consult local Square D Sales Office for proper application.

Voltage and Frequency	Type
110-120 V, 50-60 Hz	KT50

Color	② Plastic Fresnel	② Plastic Domed	② Glass
Amber	A31	A9	A6
Blue	L31	L9	L6
Clear	C31	C9	C6
Green	G31	G9	G6
Red	R31	R9	R6
White	W31	W9	W6
Yellow	Y31	Y9	Y6

Basic Operators	Page 155
Boots	Page 154
Lamps	Page 148
Legend Plates	Pages 152-153
Light Modules	Page 148
Outline Dimensions	Pages 159-160
Ratings	Pages 149-150
Replacement Parts	Page 158
Ring Nuts	Page 158
Ratings	Page 148

Typical Wiring Diagrams

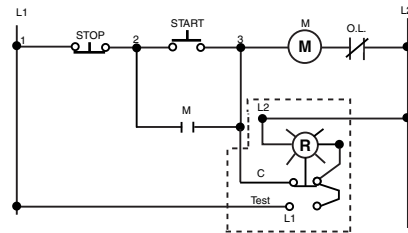

Push-To-Test Pilot Light

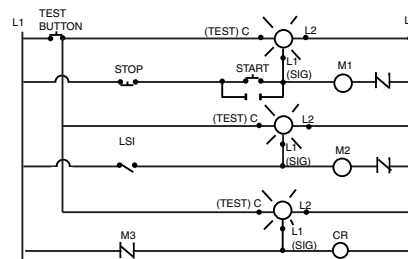



Remote Test Pilot Light

Push Buttons and Operator Interface - Type K and SK, 30 mm

Heavy Duty Joysticks - Type K

Joy Stick Operators – UL Types 4, 13/NEMA Types 4, 13



For use in hazardous locations – See page 150. Contact Blocks And Legend Plate Not Included Unless Otherwise Noted

Image	Description			Symbol	Operator With Contacts	Operator Without Contacts ①	
	Position	Contact Type	Latch				
 Without Latch	3 Position-Center Off	Momentary Contact — Spring Return to Center	Without Latch	↕	K71H7	K71	
			With Latch		K70H7	K70	
		Maintained Contact	Without Latch		K73H7	K73	
	3 Position-Center Off	Momentary Contact — Spring Return to Center	Without Latch		↔	K31H8	K31
			With Latch			K30H8	K30
		Maintained Contact	Without Latch			K33H8	K33
 With Latch	3 Position-Center Off	Momentary Contact — Spring Return to Center	Without Latch	↖↗		K32H8	K32
			With Latch			K35H2	K35
		Maintained Contact	Without Latch			K34H2	K34
	5 Position-Center Off	Momentary Contact — Spring Return to Center	Without Latch		⬠	K37H2	K37
			With Latch			K36H2	K36
		Maintained Contact	Without Latch				

The joystick operator is ideal for applications where only one circuit is to be energized at one time. The three position joy stick closes one circuit each in Up-Down or Right-Left position with all circuits open in center position. The five position operator closes one circuit each in Up, Down, Left and Right positions with all circuits open in center position. Momentary contact operators are spring return to the center position. Maintained operators remain in each position and must be reset manually. Operators with latch cannot be operated until the latch button in center of handle is pressed.

① These operators can be ordered complete with contact blocks, for maximum block usage – see page 155. Add the "H" number chosen from page 151 to the end of the operator type number. Use Legend Plate 9001KN900

Contact Arrangements

Operator	Contact Block Type	Contact Block Location (See Fig. 2)	Contact (See Fig. 2)	Handle position (with ref. to Nib, See Fig. 1)				
				1 ↑	2 →	OFF	3 ↓	4 ←
	KA3	POS 1	A		1	0		0
			A		0	0		1
	KA2	POS 1	B	1		0	0	
			B	0		0	1	
	KA1	POS 1	A	0	1	0	0	0
			B	1	0	0	0	0
	KA1	POS 2	A	0	0	0	0	1
			B	0	0	0	1	0

(1) Contact Closed

(0) Contact Open

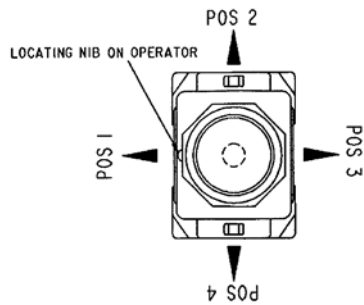

Figure 1

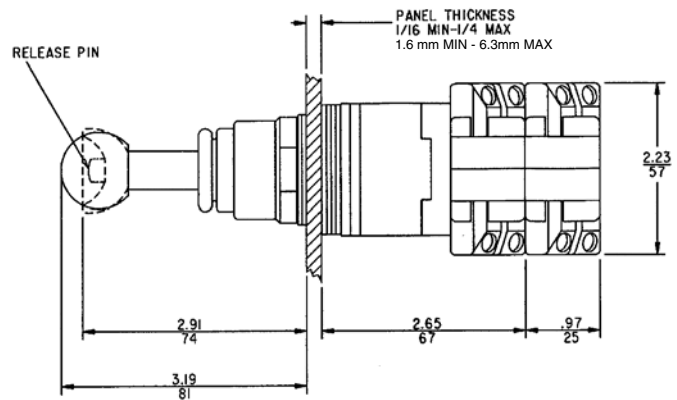

Figure 2

Dimensions **Inches**
MM

65075-344

Contact Blocks	Pages 149-150
"H" Numbers	Page 151
Legend Plates	Pages 152-153
Ratings	Pages 149-150
Replacement Parts	Page 158
Ring Nuts	Page 158

Push Buttons and Operator Interface - Type K and SK, 30 mm Heavy Duty Operators - Type K

Selector Push Button Operators – UL Types 4, 13/NEMA Types 4, 13

For use in hazardous locations – See page 150.
Legend Plate and Contact Block Not Included

Inserts are field convertible. For colors not listed, order operator without insert plus separate color insert from page 157. Up to two Type KA contact blocks can be mounted in tandem (total of four blocks). Selector push buttons cannot be illuminated.



Contact Block Required		Two Position Operators												Three Position Operators			Order Contact Blocks From Pages 149-150.
		1 — Contact Closed 0 — Contact Open						F — Free D — Depressed									
		Left		Right		Left		Right		Left		Right					
Quantity and Type	Mount on Side	F	D	F	D	F	D	F	D	F	D	F	D	F	D	F	D
1-KA-1 O LO O	#2	0 0 0 1	1 0 0 1	0 0 0 1	1 0 0 0	0 0 0 1	1 1 0 0	1 1 0 0	1 0 0 1	1 0 0 1	0 0 0 1	1 0 - 0 0 1	- 0 - 1	1 0 0 1	1 0 0 0	1 1 0 0	
1-KA-1 O LO O	#1	0 0 0 1	1 1 0 0	0 0 0 1	1 0 0 0	1 1 0 0	0 0 0 1	1 0 0 1	1 1 0 0	1 1 0 0	0 0 0 1	1 0 - 0 0 1	- 0 - 1	1 1 0 0	1 0 0 0	1 0 0 1	
CAM ②		P		R		S		T		Y		Z		U			
Color Insert		Type		Type		Type		Type		Type		Type		Type			
Without Insert ① Black		KQ11 KQ11B		KQ12 KQ12B		KQ13 KQ13B		KQ14 KQ14B		KQ15 KQ15B		KQ18 KQ18B		KQ27 KQ27B			

① Order color inserts from page 157.

② Cams are not interchangeable.

Key Operated Push Button – UL Types 4, 13/NEMA Types 4, 13

For use in hazardous locations – See page 150.

Key operated push buttons are used wherever unauthorized use of a push button is to be discouraged. Examples are locking a “Start” push button in the extended position or locking a “Stop” push button in the depressed position. The operator can also be locked in the flush position –holding all contacts open. **Up to two Type KA contact blocks can be mounted in tandem (total of four blocks).**

Legend Plate and Contact Block Not Included

Description	Positions In Which Push Button Can Be Locked			Type
	Extended	Flush	Depressed	
Push button operable only with key in lock. Key is removable in locked position only.	X	–	–	KR131
	–	X	–	KR132
	–	–	X	KR133
	X	X	X	KR137
Push button operable with or without key in lock. Push button can be locked with key only. Key removable in both locked or unlocked position.	X	–	–	KR141
	–	X	–	KR142
	–	–	X	KR143
	X	X	X	KR147
Unit is set by rotating key, with button in extended position. Key is removable only in this set position. When pushed, the button will then lock in position indicated at right.	–	X	–	KR152
	–	–	X	KR153

All key operated push buttons are furnished as standard with Square D number E10 key change.

See page 134 for other key changes (Note 4).



Color Inserts	Page 157
Contact Blocks	Pages 149-150
“H” Numbers	Page 151
Lockouts	Page 154
Legend Plates	Pages 152-153
Ratings	Pages 149-150
Outline Dimensions	Pages 159-160
Replacement Parts	Page 158
Ring Nuts	Page 158

Push Buttons and Operator Interface - Type K and SK, 30 mm Heavy Duty Operators - Type K

Potentiometer (with Dial Plate ① – NEMA Types 4, 13)

	Watts		Description			Type		
	2		Operator only – Single Pot Operator with Single Pot Operator only – Tandem Pot Operator with Tandem Pot			K20 K21 ② K22 K23 ③		
	② ③ Complete Type No. by adding suffix No. from table below. Example: Type K2105							
Suffix ②	Ohms	Suffix ②	Ohms	Suffix ②	Ohms	Suffix ③	Ohms	
							Front	Rear
01	50	07	5 K	13	500 K	82	1000	1000
02	100	08	10 K	14	750 K	83	5000	5000
38	200	40	15 K	15	1.0 Meg	85	10 K	10 K
03	250	09	25 K	16	2.5 Meg	88	50 K	50 K
04	500	35	35 K	17 ④	5.0 Meg	89	100 K	100 K
05	1000	10	50 K					
32	1500	36	75 K					
39	2000	11	100 K					
06	2500	12	250 K					
33	3500							

- ① The dial plate only is 651580090501.
- ② Complete Type No. by adding suffix No. from table below. Example: Type K2105
- ③ Complete Type No. by adding suffix No. from table below. Example: Type K2385
- ④ For use with 9050 Type T.
- * Potentiometer shaft diameter 1/4" (6 mm), 7/8" (22 mm) length.
- Not UL Listed, CSA Certified, or CE Mark.



Emergency "Break Glass" Operator – UL Types 4, 13/NEMA Types 4, 13

	
Operator is held in a depressed position by a glass disc. When the glass disc is broken with the hammer, button returns to a normal extended position. Package of 5 discs included with operator. For a N.C. circuit, use a 9001 KA3 or the N.C. contact of a 9001KA1 or the N.C. contact of a 9001KA4. For a N.O. circuit, use the N.O. contact of a 9001KA4 or 9001KA6.	Type K15

9001 K15 Replacement Parts

Description	Part Number
Yellow bumper	3105211101
Hammer and chain	3105206750
Lower ring nut	6512232801
Top ring nut	9001K40
Package of 5 replacement discs	9001K57
Clip to hold hammer	2540902240

Time Delay Push Button – UL Types 4, 13/NEMA Types 4, 13

	Description	Type (All Colors)		
		Full Guard	Extended Guard	No Guard
	 Timed Cont. 1 N.O. and 1 N.C.	KRD1UH1	KRD2UH1	KRD3UH1
 Timed Cont. 2 N.O. and 2 N.C.	KRD1UH2	KRD2UH2	KRD3UH2	
Note: When mounted in top or bottom hole of Type K enclosures, device requires one additional space below or above operator. When mounted other than in top or bottom hole, device may require two additional spaces, one above and one below operator. Closing plates must be installed on unused holes.				
Timing period is adjustable from 0.1 second to 60 seconds and begins after button has been released. Devices include a package of seven color inserts for color coding the push button. Contacts are quick make – quick break.				

Rocker Arm Operating Lever

	Allows two standard push buttons to be operated independently of each other. Order push buttons and legend plates from pages 124 and 152 — specify which marking is to be inverted.
	Type K50

Alternate Action – (Push-On Push-Off) Module

	This module can be added to standard 9001 Type K, KX, SK or T momentary push button operators. Contact blocks mounted behind this module (maximum of 2) will be held in the depressed position when the operator is operated once and released to their normal position when the operator is operated again. For a N.C. circuit, use a 9001 KA3 or the N.C. contact of a 9001KA1 or the N.C. contact of a 9001KA4. For a N.O. circuit, use the N.O. contact of a 9001KA4 or 9001KA6.
	Type K85

Wobble Stick

	For easy operation of any standard push button.
	Type K8

Push Buttons and Operator Interface - Type K and SK, 30 mm Corrosion Resistant Operators - Type SK

Non-Illuminated Momentary Push Button Operators – UL Types 4, 4X, 13/NEMA Types 4, 4X, 13

For use in hazardous locations – See page 150.

Contact Blocks And Legend Plate Not Included Unless Otherwise Noted

Description	Color	Operator With 1 N.O. and 1 N.C. Contact (KA1)	Operator With (KA2)	Operator With 1 N.C. Contact (KA3)	Operator Only With No Contacts ⑤	
 Full Guard	Black	SKR1BH13	SKR1BH5	SKR1BH6	SKR1B	
	Red	SKR1RH13	SKR1RH5	SKR1RH6	SKR1R	
	Green	SKR1GH13	SKR1GH5	SKR1GH6	SKR1G	
	Universal ①	SKR1UH13	SKR1UH5	SKR1UH6	SKR1U	
	Other ②	SKR1②H13	SKR1②H5	SKR1②H6	SKR1②	
 No Guard	Black	SKR3BH13	SKR3BH5	SKR3BH6	SKR3B	
	Red	SKR3RH13	SKR3RH5	SKR3RH6	SKR3R	
	Green	SKR3GH13	SKR3GH5	SKR3GH6	SKR3G	
	Universal ①	SKR3UH13	SKR3UH5	SKR3UH6	SKR3U	
	Other ②	SKR3②H13	SKR3②H5	SKR3②H6	SKR3②	
 Extended Guard	Black	SKR2BH13	SKR2BH5	SKR2BH6	SKR2B	
	Red	SKR2RH13	SKR2RH5	SKR2RH6	SKR2R	
	Green	SKR2GH13	SKR2GH5	SKR2GH6	SKR2G	
	Universal ①	SKR2UH13	SKR2UH5	SKR2UH6	SKR2U	
	Other ②	SKR2②	SKR2②H5	SKR2②H6	SKR2②	
 1 5/8 Mushroom Button	Snap In Mushroom Button					
	Black	SKR4BH13	SKR4BH5	SKR4BH6	SKR4B	
	Red	SKR4RH13	SKR4RH5	SKR4RH6	SKR4R	
	Red ③	SKR4R05H13	SKR4R05H5	SKR4R05H6	SKR4R05	
	Green	SKR4GH13	SKR4GH5	SKR4GH6	SKR4G	
	Other ④	SKR4④H13	SKR4④H5	SKR4④H6	SKR4④	
	Screw-On Mushroom Button With Set Screw Security					
	Black	SKR24BH13	SKR24BH5	SKR24BH6	SKR24B	
	Red	SKR24RH13	SKR24RH5	SKR24RH6	SKR24R	
	Green	SKR24GH13	SKR24GH5	SKR24GH6	SKR24G	
	Other ④	SKR24④H13	SKR24④H5	SKR24④H6	SKR24④	
	 2 1/4 Mushroom Button	Snap-In Mushroom Button				
		Black	SKR5BH13	SKR5BH5	SKR5BH6	SKR5B
		Red	SKR5RH13	SKR5RH5	SKR5RH6	SKR5R
		Red ③	SKR5R05H13	SKR5R05H5	SKR5R05H6	SKR5R05
Green		SKR5GH13	SKR5GH5	SKR5GH6	SKR5G	
Other ④		SKR5④H13	SKR5④H5	SKR5④H6	SKR5④	
Screw-On Mushroom Button With Set Screw Security						
Black		SKR25BH13	SKR25BH5	SKR25BH6	SKR25B	
Red		SKR25RH13	SKR25RH5	SKR25RH6	SKR25R	
Green		SKR25GH13	SKR25GH5	SKR25GH6	SKR25G	
Other ④		SKR25④H13	SKR25④H5	SKR25④H6	SKR25④	

① The universal push button operators include one each of the following color inserts: black, red, green, yellow, orange, blue and white.

② See table below.

③ Knob has the words "Emergency Stop" in raised letters highlighted in white for readability. Available in red snap-in mushroom buttons only.

④ See table below.

⑤ These operators can be ordered complete with contact blocks, for maximum block usage – see page 155. Add the "H" number chosen from page 151 to the end of the operator type number. **EXAMPLE: SKR24B + H2(2-KA1) = SKR24BH2**

Color	② For SKR1,2,3 Choose Color and Place Color Code in Type Number	④ For SKR4,5,24,25 Choose Color and Place Color Code in Type Number
Blue	L	L
Yellow	Y	Y
White	W	–
Orange	S	S
Gray	E	–

Color Inserts and Mushroom Knobs	Page 157
Basic Operators	Page 155
Boots	Page 154
Contact Blocks	Pages 149-150
"H" Numbers	Page 151
Legend Plates	Pages 152-153
Lockouts	Page 154
Outline Dimensions	Pages 159-160
Ratings	Pages 149-150
Replacement Parts	Page 158
Ring Nuts	Page 158

Push Buttons and Operator Interface - Type K and SK, 30 mm

Corrosion Resistant Operators - Type SK

Multifunction Operators – UL Types 4, 4X, 13/NEMA Types 4, 4X, 13

For use in hazardous locations – See page 150. Legend Plate And Contact Blocks Not Included Unless Otherwise Noted

	Description	Color	Contacts ⑥	Without Contacts ⑦
	Both Buttons Maintained Interlocked Assembly	Universal ① Other ②	SKR11UH1 SKR11②H1	SKR11U SKR11②
One Button Momentary One Button Maintained Interlocked Assembly	Universal ① Other ②	SKR12UH1H1 SKR12②H1H1	SKR12U SKR12②	

	Description	Color	With 2 N.C. Contacts (1 KA3, 1 KA5)	With 1 N.O. 1 N.C. Contact (1 KA1)	Without Contacts ⑦
	3 POSITION Momentary Pull-Maintained Neutral-Momentary Push	Red ⑨ Green Other ③	SKR8RH25 SKR8GH25 SKR8③H25	– – –	SKR8R SKR8G SKR8③
2 POSITION Maintained Pull-Maintained Push	Red ⑨ Green Other ③	– – –	SKR9RH13 SKR9GH13 SKR9③H13	SKR9R SKR9G SKR9③	

Non-Illuminated
1 5/8" Diameter Knob
Includes Type KN179WP
Legend Plate Marked
Pull To Start Push To Stop

	Description	Voltage	With Red Knob ⑩ With 2 N.C. Contacts (1 KA3, 1 KA5)	With Other Color Knob With 2 N.C. Contacts (1 KA3, 1 KA5)	With Other Color Knob Without Contacts ⑦
	3 POSITION Momentary Pull-Maintained Neutral-Momentary Push	110-120 V, 50-60 Hz Other – Transformer, LED, Flashing ⑤ Other – Full Voltage, Resistor, Neon ⑥	SKR8P1RH25 SKR8P④RH25 SKR8P④RH25	SKR8P1③H25 SKR8P④③H25 SKR8P④③H25	SKR8P1③ SKR8P④③
2 POSITION Maintained Pull-Maintained Push Illuminated	110-120 V, 50-60 Hz Other – Transformer, L.E.D., Flashing ⑤ Other – Full Voltage, Resistor, Neon ⑥	SKR9P1RH13 SKR9P④RH13 SKR9P④RH13	SKR9P1③H13 SKR9P④③H13 SKR9P④③H13	SKR9P1③ SKR9P④③ SKR9P④③	

Illuminated
1 5/8" Diameter Knob
Includes Type KN179WP
Legend Plate Marked
Pull To Start Push To Stop

- ① Universal for SKR11,12 includes 2 each of black, red, green, yellow, orange, blue, white.
- ② Choose one color for each button from table and insert color code in type number.
EXAMPLE: An SKR11 with top button gray and bottom button orange = SKR11ES
- ③ Choose one color from table and insert color code in type number.
EXAMPLE: SKR9 with a yellow knob=SKR9Y
- ④ Add the voltage assembly code as chosen from voltage assembly code table on page 141.
EXAMPLE: SKR8P④ with a 277 V 50-60 Hz voltage=SKR8P8
- ⑤ The color of the knob must be the same color as the LED voltage chosen (i.e., green LED uses green knob) or use a clear knob.
- ⑥ On neon voltages use clear knobs only.
- ⑦ These operators can be ordered complete with contact blocks, for maximum block usage – see page 155. Add the "H" number chosen from page 151 to the end of the operator type number.
- ⑧ SKR11UH1 has 1 KA1(1N.O., 1N.C.) and SKR12UH1H1 has 2 KA1 (2N.O., 2N.C.).
- ⑨ To obtain a red knob with "Push Emergency Stop" printed on the red knob – substitute "R05" in place of "R". Not available in 1 3/8" or 2 1/4".

Color	SKR11, SKR12②	SKR8, SKR9 ③
Black	B	B *
Red	R	R
Green	G	G
Blue	L	L
Yellow	Y	Y
White	W	W
Orange	S	S *
Clear	–	C
Amber	–	A
Gray	E	–



* These colors are not available on illuminated push-pull operators.

Color Inserts and Mushroom Knobs	Page 157
Basic Operators	Page 155
Boots	Page 154
Contact Blocks	Pages 149-150
"H" Numbers	Page 151
Lamps	Page 148
Legend Plates	Pages 152-153
Light Modules	Page 148
Lockouts	Page 154
Outline Dimensions	Pages 159-160
Ratings	Pages 149-150
Replacement Parts	Page 158
Ring Nuts	Page 158

Push Buttons and Operator Interface - Type K and SK, 30 mm Corrosion Resistant Operators - Type SK

Illuminated Push Button Operators – UL Types 4, 4X, 13/NEMA Types 4, 4X, 13

For use in hazardous locations – See page 150. Legend Plate Not Included Unless Otherwise Noted

Description	Voltage and Frequency	Style	With Red Color Cap and 1 N.O. and 1 N.C. Contact (KA1)	With Green Color Cap and 1 N.O. and 1 N.C. Contact (KA1)	With Other Color Cap Without Contact Blocks ①
 Full Guard Illuminated Push Button	110-120 V, 50-60 Hz	Transformer	SK1L1RH13	SK1L1GH13	SK1L1⑤
	220-240 V, 50-60 Hz	Transformer	SK1L7RH13	SK1L7GH13	SK1L7⑤
	24-28 Vac/dc	Full Voltage	SK1L35RH13	SK1L35GH13	SK1L35⑤
	For other voltages See Table ②	Transformer, Flashing	SK1L②RH13	SK1L②GH13	SK1L②⑤
		Full Voltage	SK1L②RH13	SK1L②GH13	SK1L②⑤
		Resistor, Neon ③	SK1L②RH13	SK1L②GH13	SK1L②⑤
 No Guard Illuminated Push Button	110-120 V, 50-60 Hz	Transformer	SK2L1RH13	SK2L1GH13	SK2L1⑤
	220-240 V, 50-60 Hz	Transformer	SK2L7RH13	SK2L7GH13	SK2L7⑤
	24-28 Vac/dc	Full Voltage	SK2L35RH13	SK2L35GH13	SK2L35⑤
	For other voltages See Table ②	Transformer, Flashing	SK2L②RH13	SK2L②GH13	SK2L②⑤
		Full Voltage	SK2L②RH13	SK2L②GH13	SK2L②⑤
		Resistor, Neon ③	SK2L②RH13	SK2L②GH13	SK2L②⑤
 1 3/8 Inch Illuminated Mushroom	110-120 V, 50-60 Hz	Transformer	SK2L1R20H13	SK2L1G20H13	Order SK2L② ⑤ ⑥
	220-240 V, 50-60 Hz	Transformer	SK2L7R20H13	SK2L7G20H13	
	24-28 Vac/dc	Full Voltage	SK2L35R20H13	SK2L35G20H13	
	For other voltages See Table ②	Transformer, Flashing	SK2L②R20H13	SK2L②G20H13	
		Full Voltage	SK2L②R20H13	SK2L②G20H13	
		Resistor, Neon ③	SK2L②R20H13	SK2L②G20H13	
 2 1/4 Inch Illuminated Mushroom	110-120 V, 50-60 Hz	Transformer	SK2L1R21H13	SK2L1G21H13	Order SK2L② ⑤ ⑥
	220-240 V, 50-60 Hz	Transformer	SK2L7R21H13	SK2L7G21H13	
	24-28 Vac/dc	Full Voltage	SK2L35R21H13	SK2L35G21H13	
	For other voltages See Table ②	Transformer, Flashing	SK2L②R21H13	SK2L②G21H13	
		Full Voltage	SK2L②R21H13	SK2L②G21H13	
		Resistor, Neon ③	SK2L②R21H13	SK2L②G21H13	
	LED ④	SK2L②R21H13	SK2L②G21H13		

- ① These operators can be ordered complete with contact blocks, for maximum block usage – see page 155. Add the "H" number chosen from page 151 to the end of the operator type number. **EXAMPLE: SK2L36R20+H2 (2 KA1) =SK2L36R20H2.**
- ② Add the voltage assembly code as chosen from voltage assembly code table at right. **EXAMPLE: SK2L② with a 240 Vac-dc voltage=SK2L25.**
- ③ On neon voltages use clear color caps only.
- ④ The color of the color cap must be the same color as the LED voltage chosen (i.e., red LED uses red color cap) or use a clear cap.
- ⑤ Add the color code as chosen from the color cap table below. **EXAMPLE: SK2L25⑤ with a blue 1 3/8" mushroom button=SK2L25L20.**
- ⑥ The only difference between a no guard (SK2L) operator and mushroom button operators is the color cap.

Color Caps

Color	Color Codes		
	SK1L ⑤ SK2L ⑤	1 3/8 Inch Mushroom ⑤	2 1/4 Inch Mushroom ⑤
Red	R	R20	R21
Green	G	G20	G21
Blue	L	L20	L21
Yellow	Y	Y20	Y21
White	W	W20	W21
Clear	C	C20	C21
Amber	A	A20	A21

Color Caps and Mushroom Knobs	Page 157
Basic Operators	Page 155
Boots	Page 154
Contact Blocks	Pages 149-150
"H" Numbers	Page 151
Lamps	Page 148
Legend Plates	Pages 152-153
Lockouts	Page 154
Outline Dimensions	Pages 159-160
Ratings	Pages 149-150
Replacement Parts	Page 158
Ring Nuts	Page 158

Voltage Assembly Codes

Voltage	Description	Voltage Assembly Code	Separate Light Module Type Number
6 Vac-dc	Full Voltage	31	KM31
	LED Red	31LR	KM31LR
	LED Green	31LG	KM31LG
	LED Yellow	31LY	KM31LY
12-14 Vac-dc	Full Voltage	32	KM32
	LED Red	32LR	KM32LR
	LED Green	32LG	KM32LG
	LED Yellow	32LY	KM32LY
18 Vac-dc	Resistor	33	KM33
24-28 Vac-dc	Full Voltage	35	KM35
	LED Red	35LR	KM35LR
	LED Green	35LG	KM35LG
	LED Yellow	35LY	KM35LY
32 Vac-dc	Resistor	23	KM23
48 Vac-dc	Full Voltage	36	KM36
	LED Red	36LR	KM36LR
	LED Green	36LG	KM36LG
	LED Yellow	36LY	KM36LY
60 Vac-dc	Full Voltage	37	KM37
	LED Red	37LR	KM37LR
	LED Green	37LG	KM37LG
	LED Yellow	37LY	KM37LY
110-120 V, 25-30 Hz	Transformer	2	KM2
110-120 V, 50-60 Hz	Transformer	1	KM1
110-120 V, 50-60 Hz	Flashing	F1	KMF1
120 Vac-dc	Resistor	38	KM38
	Neon *	11	KM11
	LED Red	38LR	KM38LR
	LED Green	38LG	KM38LG
LED Yellow	38LY	KM38LY	
208-220 V, 50-60 Hz	Transformer	3	KM3
220-240 V, 25-30 Hz	Transformer	4	KM4
	Transformer	7	KM7
	Flashing	F7	KMF7
	240 Vac-dc	Resistor	25
240 Vac-dc	Neon *	12	KM12
277 V, 50-60 Hz	Transformer	8	KM8
380 Vac-dc	Neon *	13	KM13
380-480 V, 50-60 Hz	Transformer	5	KM5
	Neon *	14	KM14
550 Vac-dc	Neon *	15	KM15
	Transformer	6	KM6











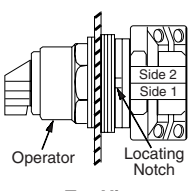





* Use clear color caps only with neon light modules.

Push Buttons and Operator Interface - Type K and SK, 30 mm Corrosion Resistant Selector Switches - Type SK

Non-Illuminated 2 Position Selector Switch Operators – UL Types 4, 4X, 13/NEMA Types 4, 4X, 13

For use in hazardous locations – See page 150.

Legend Plate and Contact Block Not Included Unless Noted

Contact Block Required			1 — Contact Closed 0 — Contact Open							
Contact Block Position	Quantity and Type	Mount on Side	Left		Right					
			↖	↗	↖	↗				
 Top View	KA1 	OR	KA3 	KA3 #2 	KA1 #2 OR	KA2 #2 	1	0	0	1
	KA1 	OR	KA3 	KA2 #2 	KA1 #2 OR	KA3 #1 	0	1	1	0
	KA1 	OR	KA3 	KA2 #1 	KA1 #1 OR	KA3 #2 	1	0	0	1
	KA1 	OR	KA2 	KA2 #1 	KA1 #1 OR	KA2 #1 	0	1	1	0
CAM			E		D					
Non-Illuminated Operators			Type		Type					
Manual Return	Operator Only ①	Without Knob With Standard Black Knob With Other Color Knob (See Table) ②	SKS11 SKS11B SKS11 ②		SKS12 SKS12B SKS12 ②					
	With Contact Block(s)	With Standard Black Knob (See Table for Other Colors, Replace B in Type Number with Other Color Code) With 1 KA1 on Side #2 (H13) With 1 KA1 on Side #1 (H1) With 1 KA1 on Side #1 and 1 KA1 on Side #2 (H2)	SKS11BH13 SKS11BH1 SKS11BH2		— — —					
Spring Return from Left	Operator Only ①	Without Knob With Standard Black Knob With Other Color Knob (See Table) ②	SKS25 SKS25B SKS25 ②		— — —					
Spring Return From Right	Operator Only ①	Without Knob With Standard Black Knob With Other Color Knob (See Table) ②	— — —		SKS34 SKS34B SKS34 ②					

① These operators can be ordered complete with contact blocks, for maximum block usage – see page 155. Add the “H” number chosen from page 151 to the end of the operator type number.

Example: SKS11FB+H13(KA1-Side 2) = SKS11FBH13

② Add the color code as chosen from knob color table below.

Example: SKS11② with a green gloved hand knob = SKS11FG

Selector Switch Knobs

Color	Standard Knob		Gloved Hand Knob		Coin Operated	
	② Knob Code	Type	② Knob Code	Type	② Knob Code	Type
Black	B	B11	FB	B25	TB	B18
Red	R	R8	FR	R24	TR	R16
Green	G	G8	FG	G24	TG	G16
Yellow	Y	Y8	FY	Y24	TY	Y16
Orange	S	S11	FS	S25	—	—
Blue	L	L8	FL	L24	TL	L16
White	W	W8	FW	W24	—	—
Amber	A	A8	FA	A24	—	—
Clear	C	C8	FC	C24	TC	C16

Basic Operators	Page 155
Boots	Page 154
Contact Blocks	Pages 149-150
“H” Numbers	Page 151
Legend Plates	Pages 152-153
Light Modules	Page 148
Lockouts	Page 154
Outline Dimensions	Pages 159-160
Ratings	Pages 149-150
Replacement Parts	Page 158
Ring Nuts	Page 158
Cams	Page 157

Push Buttons and Operator Interface - Type K and SK, 30 mm Corrosion Resistant Selector Switches - Type SK

Illuminated 2 Position Selector Switch Operators – UL Types 4, 4X, 13/NEMA Types 4, 4X, 13

For use in hazardous locations – See page 150.
Legend Plate and Contact Block Not Included Unless Noted

Contact Block Required			1 — Contact Closed 0 — Contact Open	
Contact Block Position	Quantity and Type	Mount on Side	↖	↗
			Left	Right
	KA3 KA1 OR KA2	KA3 #2 KA1 OR #2	1	0
	KA3 KA1 OR KA2	KA3 #1 KA1 OR #1	0	1
	KA3 KA1 OR KA2	KA3 #1 KA1 OR #1	1	0
	KA3 KA1 OR KA2	KA3 #1 KA1 OR #1	0	1
CAM			E	D
Illuminated Operators			Type	Type
Manual Return ①				
Without Knob 110-120 V, 50-60 Hz			SK11J1	SK12J1
With Standard Red Knob 110-120 V, 50-60 Hz			SK11J1R	SK12J1R
Without Knob and Other Voltage Transformer, Flashing or LED ④			SK11J②	SK12J②
Without Knob Full Voltage, Neon or Resistor ⑤			SK11J③	SK12J③
With Other Color Knob and Other Voltage Transformer, Flashing or LED ④			SK11J②③	SK12J②③
With Other Color Knob Full Voltage, Neon or Resistor ⑤			SK11J②③	SK12J②③
Spring Return from Left ①				
Without Knob 110-120 V, 50-60 Hz			SK25J1	—
With Standard Red Knob 110-120 V, 50-60 Hz			SK25J1R	—
Without Knob and Other Voltage Transformer, Flashing or LED ④			SK25J②	—
Without Knob Full Voltage, Neon or Resistor ⑤			SK25J②	—
With Other Color Knob and Other Voltage Transformer, Flashing or LED ④			SK25J②③	—
With Other Color Knob Full Voltage, Neon or Resistor ⑤			SK25J②③	—
Spring Return From Right ①				
Without Knob 110-120 V, 50-60 Hz			—	SK34J1
With Standard Red Knob 110-120 V, 50-60 Hz			—	SK34J1R
Without Knob and Other Voltage Transformer, Flashing or LED ④			—	SK34J②
Without Knob Full Voltage, Neon or Resistor ⑤			—	SK34J②
With Other Color Knob and Other Voltage Transformer, Flashing or LED ④			—	SK34J②③
With Other Color Knob Full Voltage, Neon or Resistor ⑤			—	SK34J②③

- ① These operators can be ordered complete with contact blocks, for maximum knob usage – see page 155. Add the "H" number chosen from page 151 to the end of the operator type number. **Example: SK12J35FR+H2(2 KA1) = SK12J35FRH2.**
- ② Add the voltage assembly code as chosen from voltage assembly code table below. **Example: SK25J② with a 60 Vac-dc Voltage = SK25J37**
- ③ Add the color code as chosen from the knob color table at right. **Example: SK25J35③ with a green knob = SK25J35G**
- ④ The color of the knob must be the same color as the LED voltage chosen (i.e., red LED use red knob) or use a clear knob.
- ⑤ On neon voltages use clear knobs only.

Selector Switch Knobs

Color	Standard Knob		Gloved Hand Knob		Coin Operated	
	③ Knob Code	Type	③ Knob Code	Type	③ Knob Code	Type
Red	R	R8	FR	R24	TR	R16
Green	G	G8	FG	G24	TG	G16
Yellow	Y	Y8	FY	Y24	TY	Y16
Blue	L	L8	FL	L24	TL	L16
White	W	W8	FW	W24	—	—
Amber	A	A8	FA	A24	—	—
Clear	C	C8	FC	C24	TC	C16

Voltage Assembly Codes

Voltage	Description	Voltage Assembly Code	Separate Light Module Type Number
6 Vac-dc	Full Voltage	31	KM31
6 Vac-dc	LED Red	31LR	KM31LR
6 Vac-dc	LED Green	31LG	KM31LG
6 Vac-dc	LED Yellow	31LY	KM31LY
12-14 Vac-dc	Full Voltage	32	KM32
12-14 Vac-dc	LED Red	32LR	KM32LR
12-14 Vac-dc	LED Green	32LG	KM32LG
12-14 Vac-dc	LED Yellow	32LY	KM32LY
18 Vac-dc	Resistor	33	KM33
24-28 Vac-dc	Full Voltage	35	KM35
24-28 Vac-dc	LED Red	35LR	KM35LR
24-28 Vac-dc	LED Green	35LG	KM35LG
24-28 Vac-dc	LED Yellow	35LY	KM35LY
32 Vac-dc	Resistor	23	KM23
48 Vac-dc	Full Voltage	36	KM36
48 Vac-dc	LED Red	36LR	KM36LR
48 Vac-dc	LED Green	36LG	KM36LG
48 Vac-dc	LED Yellow	36LY	KM36LY
60 Vac-dc	Full Voltage	37	KM37
60 Vac-dc	LED Red	37LR	KM37LR
60 Vac-dc	LED Green	37LG	KM37LG
60 Vac-dc	LED Yellow	37LY	KM37LY
110-120 V, 25-30 Hz	Transformer	2	KM2
110-120 V, 50-60 Hz	Transformer	1	KM1
110-120 V, 50-60 Hz	Flashing	F1	KMF1
120 Vac-dc	Resistor	38	KM38
120 Vac-Only	Neon*	11	KM11
120 Vac-dc	LED Red	38LR	KM38LR
120 Vac-dc	LED Green	38LG	KM38LG
120 Vac-dc	LED Yellow	38LY	KM38LY
208-220 V 50-60 Hz	Transformer	3	KM3
220-240 V 25-30 Hz	Transformer	4	KM4
220-240 V 50-60 Hz	Transformer	7	KM7
220-240 V 50-60 Hz	Flashing	F7	KMF7
240 Vac-dc	Resistor	25	KM25
240 Vac-dc	Neon*	12	KM12
277 V, 50-60 Hz	Transformer	8	KM8
380 Vac-dc	Neon*	13	KM13
380-480 V, 50-60 Hz	Transformer	5	KM5
480 Vac-dc	Neon*	14	KM14
550 Vac-dc	Neon*	15	KM15
550-600 V, 50-60 Hz	Transformer	6	KM6

* Use clear color caps only with neon light modules.

Two Color Selector Switch

Used to indicate red in left position and green in right position on illuminated operators.

Knob	Factory Assembled Form Number ▲
Standard	Y178
Gloved Hand	Y1781

▲ Add form number to standard Type number, e.g. Type SK11J1 Form Y-178.

Basic Operators	Page 155
Boots	Page 154
Contact Blocks	Pages 149-150
"H" Numbers	Page 151
Lamps	Page 147
Legend Plates	Pages 152-153
Lockouts	Page 154
Outline Dimensions	Pages 159-160
Ratings	Pages 149-150
Replacement Parts	Page 158
Ring Nuts	Page 158
Cams	Page 157

Push Buttons and Operator Interface - Type K and SK, 30 mm

Corrosion Resistant Selector Switches - Type SK

Non-Illuminated 3 Position Selector Switch Operators – UL Types 4, 4X, 13/NEMA Types 4, 4X, 13
 For use in hazardous locations – See page 150. Legend Plate and Contact Block Not Included Unless Noted

CONTACT BLOCK REQUIRED			1 — Contact Closed						0 — Contact Open																					
Contact Block Position	Quantity and Type	Mount on Side	Center		Center		Center		Center		Center		Center																	
			Left	Right	Left	Right	Left	Right	Left	Right	Left	Right	Left	Right																
<p>Top View</p>	KA1 OR KA3	KA1 #2 OR KA2 #2	KA3 #2	1	0	0	1	0	0	0	0	1	1	0	0	1	0	0	1	0	0	0	1	0	1	1	0			
	KA2		KA2 #2	0	1	1	0	0	1	0	1	0	0	1	0	0	0	1	0	1	1	0	1	1	1	0	0	0	0	1
	KA1 OR KA3	KA1 #1 OR KA2 #1	KA3 #1	0	0	1	1	0	0	0	0	1	1	0	0	0	1	0	0	0	1	1	0	1	0	0	1	0	1	1
	KA2		KA2 #1	1	1	0	0	0	1	0	1	0	0	1	0	0	0	1	1	0	0	0	1	0	0	1	0	1	0	0
CAM			B	C	D	E	F	G	J	L	M																			
Non-Illuminated Operators			Type	Type	Type	Type	Type	Type	Type	Type	Type	Type	Type	Type	Type															
Manual Return	Operator Only ^①	Without Knob With Standard Black Knob With Other Color Knob (See Table) ^②	SKS42 SKS42B SKS42 ^②	SKS43 SKS43B SKS43 ^②	SKS44 SKS44B SKS44 ^②	SKS45 SKS45B SKS45 ^②	SKS46 SKS46B SKS46 ^②	SKS47 SKS47B SKS47 ^②	SKS49 SKS49B SKS49 ^②	SKS401 SKS401B SKS401 ^②	SKS402 SKS402B SKS402 ^②																			
	With Contact Block(s)	With Standard Black Knob (See Table for Other Colors, Replace B in Type No. with Color Code) With 1 KA1 on side #2 (H13) With 1 KA1 on side #1 (H1) With 1 KA1 on side #1 and 1 KA1 on side #2 (H2)	SKS42BH13 SKS42BH1 SKS42BH2	SKS43BH13 SKS43BH1 SKS43BH2	SKS44BH13 SKS44BH1 SKS44BH2	SKS45BH13 SKS45BH1 SKS45BH2	SKS46BH13 SKS46BH1 SKS46BH2	SKS47BH13 SKS47BH1 SKS47BH2	SKS49BH13 SKS49BH1 SKS49BH2	SKS401BH13 SKS401BH1 SKS401BH2	SKS402BH13 SKS402BH1 SKS402BH2																			
Spring Return from Left to Center	Operator Only ^①	Without Knob With Standard Black Knob With Other Color Knob (See Table) ^②	SKS62 SKS62B SKS62 ^②	SKS63 SKS63B SKS63 ^②	SKS64 SKS64B SKS64 ^②	SKS65 SKS65B SKS65 ^②	SKS66 SKS66B SKS66 ^②	SKS67 SKS67B SKS67 ^②	SKS69 SKS69B SKS69 ^②	SKS601 SKS601B SKS601 ^②	SKS602 SKS602B SKS602 ^②																			
Spring Return From Right to Center	Operator Only ^①	Without Knob With Standard Black Knob With Other Color Knob (See Table) ^②	SKS72 SKS72B SKS72 ^②	SKS73 SKS73B SKS73 ^②	SKS74 SKS74B SKS74 ^②	SKS75 SKS75B SKS75 ^②	SKS76 SKS76B SKS76 ^②	SKS77 SKS77B SKS77 ^②	SKS79 SKS79B SKS79 ^②	SKS701 SKS701B SKS701 ^②	SKS702 SKS702B SKS702 ^②																			
Spring Return Both Sides to Center	Operator Only ^①	Without Knob With Standard Black Knob With Other Color Knob (See Table) ^②	SKS52 SKS52B SKS52 ^②	SKS53 SKS53B SKS53 ^②	SKS54 SKS54B SKS54 ^②	SKS55 SKS55B SKS55 ^②	SKS56 SKS56B SKS56 ^②	SKS57 SKS57B SKS57 ^②	SKS59 SKS59B SKS59 ^②	SKS501 SKS501B SKS501 ^②	SKS502 SKS502B SKS502 ^②																			

① These operators can be ordered complete with contact blocks, for maximum block usage – see page 155. Add the “H” number chosen from page 151 to the end of the operator type number.
EXAMPLE: SKS43FB+H13(KA1-POS 2) = SKS43FBH13.
 ② Add the color code as chosen from knob color table below.
EXAMPLE: SKS43^② with a green gloved hand knob = SKS43FG.

Selector Switch Knobs

Color	Standard Knob		Gloved Hand Knob		Coin Operated	
	② Knob Code	Type	② Knob Code	Type	② Knob Code	Type
Black	B	B11	FB	B25	TB	B18
Red	R	R8	FR	R24	TR	R16
Green	G	G8	FG	G24	TG	G16
Yellow	Y	Y8	FY	Y24	TY	Y16
Orange	S	S11	FS	S25	—	—
Blue	L	L8	FL	L24	TL	L16
White	W	W8	FW	W24	—	—
Amber	A	A8	FA	A24	—	—
Clear	C	C8	FC	C24	TC	C16

Basic Operators	Page 155
Boots	Page 154
Contact Blocks	Pages 149-150
“H” Numbers	Page 151
Legend Plates	Pages 152-153
Lockouts	Page 154
Outline Dimensions	Pages 159-160
Ratings	Pages 149-150
Replacement Parts	Page 158
Ring Nuts	Page 158
Cams	Page 157

Push Buttons and Operator Interface - Type K and SK, 30 mm Corrosion Resistant Selector Switches - Type SK

Illuminated 3 Position Selector Switch Operators – UL Types 4, 4X, 13/NEMA Types 4, 4X, 13
For use in hazardous locations – See page 150. Legend Plate and Contact Block Not Included Unless Noted

CONTACT BLOCK REQUIRED			1 — Contact Closed 0 — Contact Open													
Contact Block Position	Quantity and Type	Mount on Side	Center		Center		Center		Center		Center		Center			
			Left	Right	Left	Right	Left	Right	Left	Right	Left	Right	Left	Right		
<p style="text-align: center;">Top View</p>	KA1 OR KA3 KA2 OR KA2 KA1 OR KA3 KA2 OR KA2	KA1 #2 OR KA2 #2 KA1 #1 OR KA2 #1	1	0	0	1	1	0	0	1	1	0	0	1		
			0	1	1	0	0	1	0	1	0	0	1	0	1	
			0	0	1	1	0	0	1	1	0	0	1	1	0	1
			1	1	0	0	0	1	0	1	0	0	1	0	1	0
CAM			B	C	D	E	F	G	J	L	M					
Illuminated Operators			Type	Type	Type	Type	Type	Type	Type	Type	Type	Type	Type			
Manual Return	Without Knob 110-120 V, 50-60 Hz		SK42J1	SK43J1	SK44J1	SK45J1	SK46J1	SK47J1	SK49J1	SK401J1	SK402J1					
	With Standard Red Knob 110-120 V, 50-60 Hz		SK42J1R	SK43J1R	SK44J1R	SK45J1R	SK46J1R	SK47J1R	SK49J1R	SK401J1R	SK402J1R					
Spring Return Left To Center	Without Knob and Other Voltage Transformer, Flashing or LED		SK62J1	SK63J1	SK64J1	SK65J1	SK66J1	SK67J1	SK69J1	SK601J1	SK602J1					
	With Other Color Knob Full Voltage, Neon or Resistor		SK62J2	SK63J2	SK64J2	SK65J2	SK66J2	SK67J2	SK69J2	SK601J2	SK602J2					
Spring Return Right To Center	Without Knob 110-120 V, 50-60 Hz		SK72J1	SK73J1	SK74J1	SK75J1	SK76J1	SK77J1	SK79J1	SK701J1	SK702J1					
	With Standard Red Knob 110-120 V, 50-60 Hz		SK72J1R	SK73J1R	SK74J1R	SK75J1R	SK76J1R	SK77J1R	SK79J1R	SK701J1R	SK702J1R					
Spring Return Both Sides To Center	Without Knob and Other Voltage Transformer, Flashing or LED		SK52J1	SK53J1	SK54J1	SK55J1	SK56J1	SK57J1	SK59J1	SK501J1	SK502J1					
	With Other Color Knob Full Voltage, Neon or Resistor		SK52J2	SK53J2	SK54J2	SK55J2	SK56J2	SK57J2	SK59J2	SK501J2	SK502J2					

- ① These operators can be ordered complete with contact blocks, for maximum block usage – see page 155. Add the "H" number chosen from page 151 to the end of the operator type number.
EXAMPLE: SK43J35FR+H2(2KA1) = SK43J35FRH2.
- ② Add the voltage assembly code as chosen from voltage assembly code table at right.
EXAMPLE: SK43J2 with a 60 Vac-dc voltage = SK43J37.
- ③ Add the color as chosen from knob color table on page 143.
EXAMPLE: SK43J35 with a green gloved hand knob = SK43J35FG.
- ④ The color of the knob must be the same color as the LED voltage chosen (i.e. red LED use red knob) or use a clear knob.
- ⑤ On neon voltages use clear knobs only.

Two Color Selector Switch
Used to indicate red in left position and green in right position on illuminated operators.

Knob	Factory Assembled Form Number *
Standard	Y178
Gloved Hand	Y1781

* Add form number to standard Type number, e.g. Type SK43J1 Form Y178.

**For additional product information and accessories
See Page 144**

Voltage Assembly Codes

Voltage	Description	Voltage Assembly Code	Separate Light Module Type Number
6 Vac-dc	Full Voltage	31	KM31
6 Vac-dc	LED Red	31LR	KM31LR
6 Vac-dc	LED Green	31LG	KM31LG
6 Vac-dc	LED Yellow	31LY	KM31LY
12-14 Vac-dc	Full Voltage	32	KM32
12-14 Vac-dc	LED Red	32LR	KM32LR
12-14 Vac-dc	LED Green	32LG	KM32LG
12-14 Vac-dc	LED Yellow	32LY	KM32LY
18 Vac-dc	Resistor	33	KM33
24-28 Vac-dc	Full Voltage	35	KM35
24-28 Vac-dc	LED Red	35LR	KM35LR
24-28 Vac-dc	LED Green	35LG	KM35LG
24-28 Vac-dc	LED Yellow	35LY	KM35LY
32 Vac-dc	Resistor	23	KM23
48 Vac-dc	Full Voltage	36	KM36
48 Vac-dc	LED Red	36LR	KM36LR
48 Vac-dc	LED Green	36LG	KM36LG
48 Vac-dc	LED Yellow	36LY	KM36LY
60 Vac-dc	Full Voltage	37	KM37
60 Vac-dc	LED Red	37LR	KM37LR
60 Vac-dc	LED Green	37LG	KM37LG
60 Vac-dc	LED Yellow	37LY	KM37LY

Voltage Assembly Codes (Con't.)

Voltage	Description	Voltage Assembly Code	Separate Light Module Type Number
110-120 V, 25-30 Hz	Transformer	2	KM2
110-120 V, 50-60 Hz	Transformer	1	KM1
110-120 V, 50-60 Hz	Flashing	F1	KMF1
120 Vac-dc	Resistor	38	KM38
120 Vac Only	Neon *	11	KM11
120 Vac-dc	LED Red	38LR	KM38LR
120 Vac-dc	LED Green	38LG	KM38LG
120 Vac-dc	LED Yellow	38LY	KM38LY
208-220 V 50-60 Hz	Transformer	3	KM3
220-240 V 25-30 Hz	Transformer	4	KM4
220-240 V 50-60 Hz	Transformer	7	KM7
220-240 V 50-60 Hz	Flashing	F7	KMF7
240 Vac-dc	Resistor	25	KM25
240 Vac-dc	Neon *	12	KM12
277 V, 50-60 Hz	Transformer	8	KM8
380 Vac-dc	Neon *	13	KM13
380-480 V, 50-60 Hz	Transformer	5	KM5
480 Vac-dc	Neon *	14	KM14
550 Vac-dc	Neon *	15	KM15
550-600 V, 50-60 Hz	Transformer	6	KM6

* Use clear color caps only with neon light modules.

Push Buttons and Operator Interface - Type K and SK, 30 mm

Corrosion Resistant Selector Switches and Potentiometers - Type SK

Non-Illuminated and Illuminated 4 Position Selector Switch Operators – UL Types 4, 4X, 13/NEMA Types 4, 4X, 13
 Legend Plate and Contact Block Not Included Unless Noted. For use in hazardous locations – See page 150.

CONTACT BLOCK REQUIRED			1 — Contact Closed	0 — Contact Open
Contact Block Position	Quantity and Type	Mount on Side	1 0 0 0	
<p>Top View</p>	KA1 OR KA3	KA1 #2 OR KA3 #2	1	0
	KA2	KA2 #2	0	0
	KA1 OR KA3	KA1 #1 OR KA3 #1	0	0
	KA2	KA2 #1	0	0
Non-Illuminated Operators			Cam	Type
Manual Return Operator Only ①			H	SKS88
Without Knob			H	SKS88B
With Standard Black Knob			H	SKS88②
With Other Color Knob (See Table ②)				
Spring Return From Left				
Spring Return From Right				
Maintained in the Two Mid Positions				
Operator Only ①			H	SKS89
Without Knob			H	SKS89B
With Standard Black Knob			H	SKS89②
With Other Color Knob (See Table ②)				
Illuminated Operators				
Manual Return ①			H	SK88J1
Without Knob 110-120 V, 50-60 Hz			H	SK88J1R
With Standard Red Knob 110-120 V, 50-60 Hz			H	SK88J③
Without Knob and With Other Voltage Transformer, Flashing or LED ④			H	SK88J③
Without Knob Full Voltage, Neon or Resistor ⑤			H	SK88J③②
With Other Color Knob and Other Voltage Transformer, Flashing or LED ④			H	SK88J③②
With Other Color Knob Full Voltage, Neon or Resistor ⑤			H	SK88J③②
Spring Return From Left				
Spring Return From Right				
Maintained in the Two Mid Positions				
Operator Only ①			H	SK89J1
Without Knob 110-120 V, 50-60 Hz			H	SK89J1R
With Standard Red Knob 110-120 V, 50-60 Hz			H	SK89J③
Without Knob and Other Voltage Transformer, Flashing or LED ④			H	SK89J③
Without Knob Full Voltage, Neon or Resistor ⑤			H	SK89J③②
With Other Color Knob and Other Voltage Transformer, Flashing or LED ④			H	SK89J③②
With Other Color Knob Full Voltage, Neon or Resistor ⑤			H	SK89J③②

① These operators can be ordered complete with contact blocks, for maximum block usage – see page 155. Add the "H" number chosen from page 151 to the end of the operator type number.
EXAMPLE: SKS88FB + H13(KA1-SIDE 2) = SKS88FBH13.

② Add the color code as chosen from knob color table at right.
EXAMPLE: SKS88② with a green gloved hand knob = SKS88FG.

③ Add the voltage assembly code as chosen from Voltage Assembly Code Table on page 145.
EXAMPLE: SK88J③ with a 60 Vac-Vdc voltage = SK88J37.

④ The color of the knob must be the same color as the LED voltage chosen (i.e., red LED use red knob) or use a clear knob.

⑤ On neon voltages, use clear knobs only.

Color	Knob Code	Type	Knob Code	Type	Knob Code	Type
Black	B	B11 *	FB	B25 *	TB	B18 *
Red	R	R8	FR	R24	TR	R16
Green	G	G8	FG	G24	TG	G16
Yellow	Y	Y8	FY	Y24	TY	Y16
Orange	S	S11 *	FS	S25 *	—	—
Blue	L	L8	FL	L24	TL	L16
White	W	W8	FW	W24	—	—
Amber	A	A8	FA	A24	—	—
Clear	C	C8	FC	C24	TC	C16

Potentiometer ♦ (with Dial Plate ⑦)

Watts	Description	Type						
2	Operator only – Single Pot Operator with Single Pot Operator only – Tandem Pot Operator with Tandem Pot	SK-20 SK-21 ⑦ SK-22 SK-23 ⑧						
⑦ ⑧ Complete Type No. by adding suffix No. from table below. Example: Type SK2105 or SK2385								
Suffix ⑦	Ohms	Suffix ⑦	Ohms	Suffix ⑦	Ohms	Suffix ⑧	Ohms	
							Front	Rear
01	50 K	07	5000					
02	100 K	08	10 K	13	500 K	82	1000	1000
38	200 K	40	15 K	37	750 K	83	5000	5000
03	250 K	09	25 K	14	1.0 Meg	85	10 K	10 K
04	500 K	35	35 K	15	2.5 Meg	88	50 K	50 K
05	1000 K	10	50 K	16	5.0 Meg	89	100 K	100 K
32	1500 K	36	75 K	17⑨	5.0 Meg			
39	2000 K	11	100 K					
06	2500 K	12	250 K					
33	3500 K							

⑦ The dial plate only 65158-001-80-03.
 ⑨ For use with 9050 Type T.
 ♦ Potentiometer shaft diameter = 1/4" (6 mm), length = 7/8" (22 mm).
 Not UL Listed, CSA Certified, or CE Marked.

Selector Switch Knobs

Color	Standard Knob		Gloved Hand Knob		Coin Operated	
	Knob Code	Type	Knob Code	Type	Knob Code	Type
Black	B	B11 *	FB	B25 *	TB	B18 *
Red	R	R8	FR	R24	TR	R16
Green	G	G8	FG	G24	TG	G16
Yellow	Y	Y8	FY	Y24	TY	Y16
Orange	S	S11 *	FS	S25 *	—	—
Blue	L	L8	FL	L24	TL	L16
White	W	W8	FW	W24	—	—
Amber	A	A8	FA	A24	—	—
Clear	C	C8	FC	C24	TC	C16





* Black and orange are opaque and for use on non-illuminated operators only.

Voltage Assembly Codes
 See Page 145

Basic Operators	Page 155
Boots	Page 154
Contact Blocks	Pages 149-150
"H" Numbers	Page 151
Lamps	Page 148
Legend Plates	Pages 152-153
Light Modules	Page 148
Lockouts	Page 154
Outline Dimensions	Pages 159-160
Ratings	Pages 149-150
Replacement Parts	Page 158
Ring Nuts	Page 158
Cams	Page 157

Push Buttons and Operator Interface - Type K and SK, 30 mm Corrosion Resistant Pilot Lights - Type SK

Pilot Lights – UL Types 4, 4X, 13/NEMA Types 4, 4X, 13
For use in hazardous locations – See page 150. Legend Plate Not Included.

Description	Voltage	Style	With Red Fresnel Color Cap	With Green Fresnel Color Cap	With Other Color Cap	Without Color Cap
 <p>Standard Pilot Light (Plastic fresnel color cap shown)</p>	110-120 V, 50-60 Hz	Transformer	SKP1R31	SKP1G31	SKP1②	SKP1
	220-240 V, 50-60 Hz	Transformer	SKP7R31	SKP7G31	SKP7②	SKP7
	24-28 Vac-dc	Full Voltage	SKP35R31	SKP35G31	SKP35②	SKP35
	For other voltages see Table ①	Transformer, Flashing or LED ③	SKP①R31	SKP①G31	SKP①②	SKP①
Full Voltage, Neon or Resistor ④		SKP①R31	SKP①G31	SKP①②	SKP①	
 <p>Push-To-Test Pilot Light (Plastic fresnel color cap shown)</p>	110-120 V, 50-60 Hz	Transformer	SKT1R31	SKT1G31	SKT1②	SKT1
	220-240 V, 50-60 Hz	Transformer	SKT7R31	SKT7G31	SKT7②	SKT7
	24-28 Vac-dc	Full Voltage	SKT35R31	SKT35G31	SKT35②	SKT35
	For other voltages see Table ①	Transformer, Flashing or LED ③	SKT①R31	SKT①G31	SKT①②	SKT①
Full Voltage, Neon or Resistor ④		SKT①R31	SKT①G31	SKT①②	SKT①	
 <p>Remote Test Pilot Light (Plastic fresnel color cap shown)</p>	120 Vac Only	Resistor ⑤	SKTR38R31	SKTR38G31	SKTR38②	SKTR38
	24-28 Vac Only	Full Voltage ⑤	SKTR35R31	SKTR35G31	SKTR35②	SKTR35
	For other voltages see Tables ①②⑤	Full Voltage or Resistor⑤	SKTR①R31	SKTR①⑤G31	SKTR①②⑤	SKTR①
 <p>Pilot Light For Intrinsically Safe Circuits (NEMA 4X)</p>	Intrinsically safe equipment must not release electrical or thermal energy capable of igniting certain explosive or combustible hazardous atmosphere, for which the equipment has been tested. These pilot lights are intrinsically safe when used with a suitable approved barrier or barrier relay (Class 8501 Type TO or NY2). These pilot lights are Factory Mutual (FM approved). Consult your local Square D Sales Office for further details. These pilot lights are fully encapsulated — there are no replaceable parts — except for the SK40 ring nut. Use KN100 series plastic legend plates as shown on pages 152 and 153		KP44R	KP44G	KP44Y (Yellow Color Cap)	-
	Operating Voltage Range	Nominal Current	V max = 32 V I max = 165 mA			
	20-30 Vac/dc	25 mA				

- ① Add the voltage assembly code as chosen from voltage assembly code table, page 145.
EXAMPLE: SKT①R31 with a 60Vac red LED voltage = SKT37LRR31.
- ② Add the color code as chosen from the color cap table below.
EXAMPLE: SKP1② with a blue fresnel cap = SKP1L31.
- ③ The color cap must be the same color as the LED voltage chosen (i.e., green LED use a green color cap) or use a clear cap.
- ④ On neon voltages use clear color caps only.
- ⑤ Use only full voltage or resistor voltage assembly codes on remote test pilot lights. Do not choose LED, or neon transformer codes. For AC use only.

Voltage Assembly Codes
See Page 145

Color Caps

Color	② Plastic Fresnel	② Plastic Domed
		
Amber	A31	A9
Blue	L31	L9
Clear	C31	C9
Green	G31	G9
Red	R31	R9
White	W31	W9
Yellow	Y31	Y9

Typical Push-To-Test Wiring Diagram

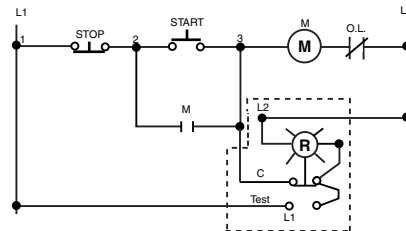

Typical Remote Test Pilot Light Wiring Diagram

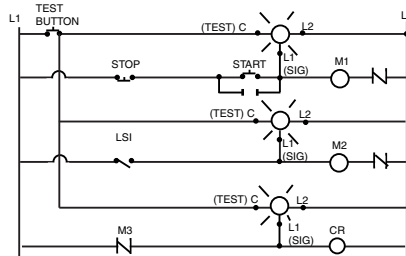

Basic Operators	Page 155
Boots	Page 154
Lamps	Page 148
Legend Plates	Pages 152-153
Light Modules	Page 148

Lockouts	Page 154
Outline Dimensions	Pages 159-160
Ratings	Pages 148
Replacement Parts	Page 158
Ring Nuts	Page 158

Push Buttons and Operator Interface - Type K and SK, 30 mm Light Modules Type K, SK, KX, and T

Standard Light Modules for Types K, SK, and KX Control Units ④

- For use in hazardous locations – See page 150.
- Neon type light modules — use CLEAR color caps only.
- LED light modules require the color cap color and the LED color to be the same or use a clear color cap.

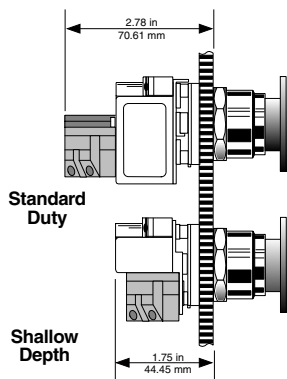

Dual Dimensions inches mm

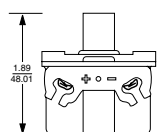

Side View

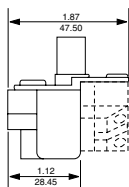

Side View
Shown with 9001 KA contact block

Voltage	Description	For Use With Single Lamp III. Operators as Indicated ①	Light Module Type No. ⑤	Voltage Assembly Code	Rating	Replacement Lamps ③ ④		
						Lamp Number (ANSI)	Lamp Part Number ⑤	
6 Vac-dc	Full Voltage	All	KM31	31	0.9 VA	755	2550101020	
6 Vac-dc	LED Red	All Except ②	KM31LR	31LR	0.65 VA		6508805201	
6 Vac-dc	LED Green	All Except ②	KM31LG	31LG	0.65 VA		6508805203	
6 Vac-dc	LED Yellow	All Except ②	KM31LY	31LY	0.65 VA		6508805202	
12-14 Vac-dc	Full Voltage	All	KM32	32	1.2 VA	756	2550101037	
12-14 Vac-dc	LED Red	All Except ②	KM32LR	32LR	0.50 VA		6508805201	
12-14 Vac-dc	LED Green	All Except ②	KM32LG	32LG	0.50 VA		6508805203	
12-14 Vac-dc	LED Yellow	All Except ②	KM32LY	32LY	0.50 VA		6508805202	
18 Vac-dc	Resistor	All	KM33	33	1.4 VA	756	2550101037	
24-28 Vac-dc	Full Voltage	All	KM35	35	1.2 VA	757	2550101002	
24-28 Vac-dc	LED Red	All Except ②	KM35LR	35LR	0.50 VA		6508805204	
24-28 Vac-dc	LED Green	All Except ②	KM35LG	35LG	0.50 VA		6508805206	
24-28 Vac-dc	LED Yellow	All Except ②	KM35LY	35LY	0.50 VA		6508805205	
32 Vac-dc	Resistor	All	KM23	23	2.5 VA	757	2550101002	
48 Vac-dc	Full Voltage	All	KM36	36	2.6 VA	48MB	2550101025	
48 Vac-dc	LED Red	All Except ②	KM36LR	36LR	0.50 VA		6508805204	
48 Vac-dc	LED Green	All Except ②	KM36LG	36LG	0.50 VA		6508805206	
48 Vac-dc	LED Yellow	All Except ②	KM36LY	36LY	0.50 VA		6508805205	
60 Vac-dc	Full Voltage	All	KM37	37	3.0 VA	60MB	2550101026	
60 Vac-dc	LED Red	All Except ②	KM37LR	37LR	0.50 VA		6508805204	
60 Vac-dc	LED Green	All Except ②	KM37LG	37LG	0.50 VA		6508805206	
60 Vac-dc	LED Yellow	All Except ②	KM37LY	37LY	0.50 VA		6508805205	
110-120 V, 25-30 Hz	Transformer	All Except ②	KM2	2	2.2 VA	1490	2550101003	
110-120 V, 50-60 Hz	Transformer	All Except ②	KM1	1	2.4 VA		755	2550101020
110-120 V, 50-60 Hz	Flashing	All Except ②	KMF1	F1	0.85 VA		267	2550101036
120 Vac-dc	Resistor	All	KM38	38	3.0 VA	120MB NE51H	2550101027	
120 Vac-dc	Full Voltage	All	KM38	38	3.0 VA		2550101027	
120 Vac-dc	Neon	All Except ②	KM11	11	0.2 VA		2550101013	
120 Vac-dc	LED Red	All Except ②	KM38LR	38LR	4.0 VA		6508805204	
120 Vac-dc	LED Green	All Except ②	KM38LG	38LG	4.0 VA		6508805206	
120 Vac-dc	LED Yellow	All Except ②	KM38LY	38LY	4.0 VA		6508805205	
208-220 V, 50-60 Hz	Transformer	All Except ②	KM3	3	2.5 VA	755	2550101020	
220-240 V, 25-30 Hz	Transformer	All Except ②	KM4	4	2.2 VA	1490	2550101003	
220-240 V, 50-60 Hz	Transformer	All Except ②	KM7	7	2.0 VA		755	2550101020
220-240 V, 50-60 Hz	Flashing	All Except ②	KMF7	F7	2.0 VA		267	2550101036
240 Vac-dc	Resistor	All Except ②	KM25	25	6.0 VA	120MB NE51H	2550101027	
240 Vac-dc	Neon	All Except ② and KX	KM12	12	0.3 VA		2550101013	
277 V, 50-60 Hz	Transformer	All Except ②	KM8	8	2.4 VA	755	2550101020	
380 Vac-dc	Neon	All Except ② and KX	KM13	13	0.4 VA	NE51H	2550101013	
380-480 V, 50-60 Hz	Transformer	All Except ②	KM5	5	2.8 VA	755 NE51H	2550101020	
480 Vac-dc	Neon	All Except ② and KX	KM14	14	0.5 VA		2550101013	
550 Vac-dc	Neon	All Except ② and KX	KM15	15	0.6 VA	NE51H 755	2550101013	
550-600 V, 50-60 Hz	Transformer	All Except ②	KM6	6	2.5 VA		2550101020	

Replacement lamps for Series G 120Vac LED Light Modules ③

Voltage	Description	Lamp Part Number
120 Vac Only	LED Red	6508805207
120 Vac Only	LED Green	6508805209
120 Vac Only	LED Yellow	6508805208

Shallow Depth Light Modules For Types K and SK Control Units

For use in hazardous locations – See page 150. Reduces the depth of illuminated push buttons with contact blocks by over 33%.

- LED light modules require the color cap color and the LED color to be the same or use a clear color cap.

Voltage	Description	For Use With Single Lamp III. Operators as Indicated ⑤	Light Module Type No. ⑤	Voltage Assembly Code	Rating	Replacement Lamps ③ ④	
						Lamp Number (ANSI)	Lamp Part Number ⑤
24-28 Vac-dc	Full Voltage	All Except ② and KX	KM55	55	1.2 VA	757	2550101002
24-28 Vac-dc	LED Red	All Except ② and KX	KM55LR	55LR	0.5 VA		6508805204
24-28 Vac-dc	LED Green	All Except ② and KX	KM55LG	55LG	0.5 VA		6508805206
24-28 Vac-dc	LED Yellow	All Except ② and KX	KM55LY	55LY	0.5 VA		6508805205
110-120 Vac-dc	Full Voltage	All Except ② and KX	KM58	58	3.0 VA	120MB	2550101027
110-120 Vac-dc	LED Red	All Except ② and KX	KM58LR	58LR	0.5 VA		6508805204
110-120 Vac-dc	LED Green	All Except ② and KX	KM58LG	58LG	0.5 VA		6508805206
110-120 Vac-dc	LED Yellow	All Except ② and KX	KM58LY	58LY	0.5 VA		6508805205

- ① 9001 K, SK, KX.
- ② Do not use on any remote test version pilot light.
- ③ LED lamps shown here will also function in Class 9001 Type J pilot lights.
- ④ For Series A through F light modules – see page 158.
- ⑤ All light modules with a LED above 12 V use a 14 V Bipolar LED.
- ⑥ 9001K, SK, T

Push Buttons and Operator Interface - Type K and SK, 30 mm Contact Blocks - Type K, SK, KX, and T

The Class 9001 Type KA contact blocks have been improved. The most noticeable change is that the terminals are Fingersafe® contact blocks (meeting VDE 0106 Part 100). They also have one screw mounting and captive backed out plus/minus terminal screws. These contact blocks still use the same reliable double break direct acting contacts used since 1965. Because of the wiping action of these contacts, they are suitable for use with programmable controllers. All contact blocks listed below will accept up to 2 #12-#24 solid or stranded wires. Types KA1, KA3, KA31, and KA33 NC contacts are direct opening.

Standard Contact Blocks

Description	Symbol	Type
 (Clear Cover)		KA1
 (Green Cover)		KA2
 (Red Cover)		KA3
 (Clear Cover)	 N.O. Contact Early Closing	KA4
 (Red Cover)	 N.C. Contact Late Opening	KA5
 (Green Cover)	 N.O. Contact Early Closing	KA6

Additional Circuit Arrangements Available

Sequencing ※ N.O. Contact of KA4 closes before N.O. Contact on KA1		Order One Type KA4 and One Type KA1
Overlapping ※ N.O. Contact of KA4 closes before N.C. Contact of KA5 Opens		Order One Type KA4 and One Type KA5

※ For push buttons or two position selector switches (Types K or SKS11, K or SKS12, K or SKS25, K or SKS34, K or SK11J, K or SK12J, K or SK25J and K or SK34J) only. For sequencing or overlapping contacts on other operators — consult local Square D Sales Office.

Symbol	Contact Blocks With Binder Head Screws (not Fingersafe)		Gold Flashed Contacts With Standard Pressure Wire Terminals
	Type	Quantity	Type
	KA21	25-Up ▲	KA31
	KA22	25-Up ▲	KA32
	KA23	25-Up ▲	KA33
 N.O. Early Closing	KA24	25-Up ▲	KA34
 N.C. Contact Late Opening	KA25	25-Up ▲	KA35

▲ Minimum order quantity is 25.

Contact Blocks Listed Below Are Not FINGERSAFE® Contact Blocks, But Provide:

- Terminals that accept ring tongue/fork tongue connectors
- Short single circuit contact blocks (0.75" deep vs. 0.97" deep on the FINGERSAFE® Contact Blocks)
- Same as old style Series G product available prior to 3/89.
- Use form Y238 (add to catalog # as suffix)



Symbol	Type	Symbol	Type
	KA1G	 N.O. Contact Early Closing	KA4G
	KA2G	 N.C. Contact Late Opening	KA5G
	KA3G	 N.O. Contact Early Closing	KA6G

Contact Blocks Listed Below Are Not FINGERSAFE® Contact Blocks, But Have "Quick Connect" Terminals.

Symbol	Type
	KA12
	KA13

Dimensions. Page 159
Maximum Block Usage. Page 155

Maximum Current Ratings For Control Circuit Contacts – Types KA1-KA6, KA21-25, KA31-35, KA1G-KA6G



Volts	AC						Volts	DC				
	Inductive (NEMA / UL Type A600) 35% Power Factor					Resistive 75% Power Factor Make, Break and Continuous Amperes		Inductive and Resistive (NEMA / UL Type P600)				
	Make		Break		Continuous Carrying Amperes			Make and Break				Continuous Carrying Amperes
	Amperes	VA	Amperes	VA				KA1	KA2 KA3	KA4	KA5 KA6	
120	60	7200	6.0	720	10	10	125	1.1	1.1	1.1	1.1	10
240	30	7200	3.0	720	10	10	250	0.55	0.55	—	0.55	10
480	15	7200	1.5	720	10	10	600	0.2	0.2	—	0.2	10
600	12	7200	1.2	720	10	10						

Push Buttons and Operator Interface - Type K and SK, 30 mm

Reed Contact Blocks & Hazardous Location Information - Type K, SK, KX, and T

In hazardous locations, it is not always required to use explosion-proof equipment like the Class 9001 Type BR control stations. It can save money to know what type of hazardous location exists. If you're not sure what type of hazardous location exists, the "Summary of Classification" Chart may help. If not, contact your local electrical inspector. When you know what class, division, and group(s) exists, see the table in the lower left-hand corner of this page for what Square D has to offer.

Summary Of Classification Chart

Class	Division	Group
I. Gas 	1. Hazard May Exist May Exist In Atmosphere Under Normal Operating Conditions.	A. Acetylene
		B. Hydrogen and Manufactured Gases containing Hydrogen
		C. Petrochemicals (e.g. ethylene)
		D. Petrochemicals (e.g. alcohol)
II. Dust 	1. Hazard May Exist May Exist In Atmosphere Under Normal Operating Conditions.	E. Conductive and Combustible Dust (Resistivity <math><10^2</math> ohms/cm)
		F. Carbonaceous Dusts (Resistivity >math>10^2</math> ohm/cm but $\delta 10^3$ ohm/cm)
		G. Non-Conductive Combustible Dust (Resistivity >math>10^3</math> ohms/cm)
		G. Non-Conductive Combustible Dust (Resistivity >math>10^3</math> ohms/cm)
III. Fibers 	1. Production Areas	Easily Ignitable Fibers or Flyings
	2. Handling and Storage Areas	Easily Ignitable Fibers or Flyings







For			Use
Class	Division	Group(s)	
I	1	A	1. Intrinsically Safe System ①
I	1	B, C, D	1. 9001 BR station 2. Intrinsically Safe System ①
I	2	A	1. 9001 K, SK, KX control stations with the restrictions listed in footnote ② 2. Intrinsically Safe System ①
I	2	B, C, D	1. 9001 BR station 2. 9001 K, SK, KX control stations with the restrictions listed in footnote ② 3. Intrinsically Safe System ①
II	1	E, F, G	1. 9001 BR station 2. Intrinsically Safe System ①
II	2	E, F	1. 9001 BR station 2. 9001 K, SK, KX control stations with the restrictions listed in footnote ② 3. Intrinsically Safe System ①
II	2	G	1. 9001 BR station 2. 9001 K, SK, KX control stations with the restrictions listed in footnote ③ 3. Intrinsically Safe System ①
III	1, 2	-	1. 9001 BR Station 2. 9001 K, SK, KX control stations with the restrictions listed in footnote ③ 3. Intrinsically Safe System ①

- ① An intrinsically safe system requires either a Class 8501 Type TO or NY2 barrier relay or an intrinsically safe barrier to restrict the energy available in the area classified as a hazardous area to a level less than that required to cause an explosion. In an intrinsically safe system, any **non-illuminated** Class 9001 operator or control station with standard contacts can be used. No illuminated operators, except the Class 9001 Type KP44 intrinsically safe pilot light, may be used.
- ② Any Class 9001 Type K, SK or KX operator can be used in an area classified as Class I, Division 2 hazardous locations.
- Only logic (KA40 series) or power (KA50 series) reed contact blocks are used.
 - All Type K and SK illuminated operators are UL approved for use in Class I Division 2 areas. ♦
 - Type KX illuminated operators do not use 4 lamp light modules, or 2 lamp light modules other than the transformer type. ♦
 - The operators are mounted in Type KY, KYSS, KYAF, SKY enclosures.
- ③ Any Class 9001 Type K, SK, or KX operator mounted in a Class 9001 Type KY, KYSS, KYAF, SKY enclosure may be used, except potentiometer operators.
- For ② and ③: UL Listed: File E10054, CCN NOIV.
For ♦: Add Form Y243 to single lamp Push To Test pilot lights.

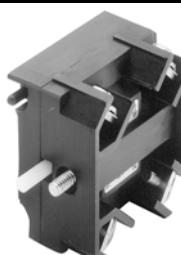
All contact blocks listed below will accept #12-18 solid or stranded wire.

Hermetically Sealed Logic Reed Contact Blocks







Suitable for use on low energy level circuits

Description	Symbol	Type	
		KA41	
		KA42	
		KA43	
		KA44	
		KA45	
Max. Volts AC/DC	Maximum Load		
	32/30 120/100	Res. 0.25 A 8 VA	Ind. 0.10 A 3 VA

The maximum number of logic and/or power reed contact blocks per operator is as indicated on page 155 for standard contact blocks, **except:**

- On 3 position selector switches with cams "C," "D," "E," "F," "G," "L," or "M" mount reed blocks on **one side only** (either side), maximum 2 in tandem.
- On 4 position selector switches, mount reed blocks on **one side only** (either side), maximum 2 in tandem.
- On joysticks or on Type KR8 or SKR8 push-pull operators, mount reed blocks on **one side only** (either side), maximum 2 in tandem.

Hermetically Sealed Power Reed Contact Blocks

Description	Symbol	Type				
		KA51				
		KA52				
		KA53				
		KA54				
		KA55				
Volts	AC NEMA / UL Type C300 ④				Continuous Carrying Amps	
	Make		Break			
	Amps	VA	Amps	VA		
	120	10.00	1200	1.000	120	3.0
	240	5.00	1200	0.500	120	3.0
	Volts	DC NEMA / UL Type Q150 ⑤				Continuous Carrying Amps
Make		Break				
Amps		VA	Amps	VA		
115		0.50	58	0.50	58	3.0

The power reed contact blocks can be used with standard industrial relays and starters through NEMA Size 4. Minimum voltage is 5 volts and the minimum current is 1 mA.









- ④ Inductive Rating - 35% Power Factor.
⑤ Inductive and Resistive Ratings.

Pilot Light For Intrinsically Safe Circuits — NEMA / UL Type 4X





	Intrinsically safe equipment must not release electrical or thermal energy capable of igniting certain explosive or combustible hazardous atmosphere, for which the equipment has been tested.			
	Listed below are pilot lights that are intrinsically safe when used with a suitable approved barrier or barrier relay (Class 8501 Type TO or NY2. These pilot lights are Factory Mutual FM# J.I. OH4A2, AX, 3610 (FM approved). Consult your local Square D Sales Office for further details.			
These pilot lights are fully encapsulated - there are no replaceable parts - except for the SK40 ring nut. Use KN100 series plastic legend plates as shown on pages 152 and 153.				
Operating Voltage Range	Nominal Current	Lens Color	Type	
V max. = 32 V	20-30 V AC/DC	25 mA	Red Green Yellow	KP44R KP44G KP44Y
I max. = 165 mA				

Push Buttons and Operator Interface - Type K and SK, 30 mm Accessories

Padlock Attachments

	Used On	Description	Type
	For Type K non-illuminated push button — Std. or mushroom (KR4, KR5 mushroom buttons only).	Holds button in depressed position . . . and can be padlocked.	K4
	For Types K and SK non-illuminated push buttons with or without protective boots.	Holds button in depressed position when padlocked.	K5
			K97
	For Types K and SK non-illuminated push buttons, cover type attachment.	Attachment can be padlocked. Does not hold button in depressed position.	K6
	For Types K and SK push-pull operator and illuminated push buttons.	Holds button in depressed position . . . and can be padlocked.	K62
	For Types K and SK push buttons, cover type attachment.	Similar to K6 shown above EXCEPT without lockout provision and with spring loaded cover.	K60
	For KR11U and KR12U.	Holds maintained button in depressed position . . . and can be padlocked.	K96
	For Type KR9 & SKR9 Push-Pull operators-Non-Illuminated and Illuminated	Holds button in depressed position-Can be padlocked	K162

Padlock Attachments

	Used On	Description	Type
	For Types K and SK selector switches (will not work with gloved hand knob) and potentiometers	Cover type attachment that can be padlocked to keep unauthorized personnel from tampering with the operator.	K7
	For Types K and SK selector switches (will not work with gloved hand knob) and potentiometers	Same as 9001 K7 except that this lockout is spring loaded.	K107
	For Types K and SK illuminated push buttons (with or without guard) and key operated push buttons	Cover type attachment that can be padlocked to keep unauthorized personnel from tampering with the operator.	K108
	For Types K and SK illuminated push buttons (with or without guard) and key operated push buttons	Same as 9001 K108 except that this lockout is spring loaded.	K109
	For Types K and SK maintained push-pull operators using 1 3/8" dia. mushroom buttons (-20 series as shown on Page 157).	Cover type attachment that holds mushroom button in depressed position and can be padlocked.	K110

Protective Boots

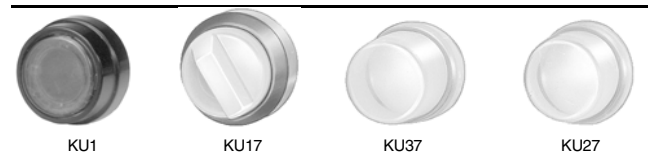



These Type KU protective boots are not required for UL Type 4 rating on the Type K operators or UL Type 4 or 4X rating on the Type SK operators. Protective boots are still recommended for very dirty environments or severe hose down. The K1 (see Page 158) wrench is required for installation of these boots.

For Non-Illuminated Push Buttons●		Clear Color for	Type
Color	Type	Standard Knob Selector Switch	
Black	KU1	Gloved Hand Cap for use on std. knob Selector Switch	KU18
Red	KU2		
Blue	KU3		
Brown	KU4	Standard Pilot Light and Maintained Contact Push Buttons	KU27
Green	KU5	Push-to-Test and Illuminated Push Button Without Guard	KU37
Yellow	KU6		
Clear	KU7		
Clear (Provides Full Guard)	KU8	Illuminated Push But. With Guard	KU47

● Use KU27 for maintained contact push buttons.

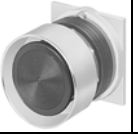

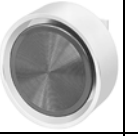
Mushroom Button Guards

	Aluminum Mushroom Guard for 1 3/8" Mushroom Button Operator (KR4, KR24)		Yellow Plastic Extended Mushroom Guard for 1 3/8" Mushroom Button Operators		Aluminum Mushroom Guard for 2 1/4" Mushroom Button Operator
Type	Type	Type	Used On	Type	Used On
K48	K56▼	K56▲M*	KR4, SKR4	K68	KR5
			KR8, KR9, SKR8, SKR9	K685	KR25

* The mushroom guard has finger holes for pushpull operators.
 ▼ B = Black G = Green R = Red Y = Yellow
 ▲ R = Red Y = Yellow

Dimensions Page 160

Closing Plates

Description		
	Type	Type
Gray	K11▲	K51†
Chrome Plated	K12▲	K52†

† Meets UL and NEMA Types 1, 2, 3, 4, 4X, 6, 12 and 13.
 ▲ Meets UL and NEMA Types 1, 2, 3, 4, 6, 12 and 13.

Push Buttons and Operator Interface - Type K and SK, 30 mm Basic Operators, Application Data

Basic Operators

(Does not include Color Caps, Mushroom Buttons, Knobs, Selector Switch Cams, Contact Blocks, Light Modules or Legend Plates)

Description	UL Types/NEMA Types	
	4, 13	4, 4X, 13
Non Illuminated Push Button (Full Guard)	KR1	SKR1
Non Illuminated Push Button (Extended Guard)	KR2	SKR2
Non Illuminated Push Button (No Guard)	KR3	SKR3
Non Illuminated Push Button (Mushroom Button/screw on)	KR20	SKR20
Non Illuminated Dual Push Button (Momentary)	KR6	—
Non Illuminated Dual Push Button (Momentary Interlocked)	KR67	—
Non Illuminated Dual Push Button (Maintained Interlocked)	KR7	—
Momentary Pull - Maintained Neutral - Momentary Push	KR8 ①④	SKR8 ①
Maintained Pull - Maintained Push	KR9 ①④	SKR9 ①
Illuminated Push Button (Full Guard - Plastic Top)	K1L ②	SK1L ②
Illuminated Push Button and Push To Test (No Guard)	K2L ②③	SK2L ②③
Illuminated Push Button (Full Guard - Metal Top)	K3L ②	—
Standard Pilot Light	KP	SKP
3 Pos. Maintained Selector Switch	KS4 ①	SKS4 ①
3 Pos. Spring Return Both Sides To Center – Selector Switch	KS5 ①	SKS5 ①
3 Pos. Spring Return Left To Center – Selector Switch	KS6 ①	SKS6 ①
3 Pos. Spring Return Right To Center – Selector Switch	KS7 ①	SKS7 ①

- ① Operator can be converted to an illuminated operator by removing the liner (6509704901) and adding a light module.
- ② Operator can be converted to a non-illuminated operator by adding liner (6509704901).
- ③ Operator includes jumper wires for push-to-test conversion.
- ④ These operators can be supplied with 1³/₈" or 2¹/₄" dia. mushroom buttons. For 1³/₈" : Add * 20 to type number. The * refers to the color chosen - see page 126, 140, or 157.
For 2¹/₄" : Add * 21 to type number. The * refers to the color chosen - see page 126, 140, or 157. Voids UL and NEMA Type 6 Rating.

Selector Switch Angular Travel (Types K and SK)

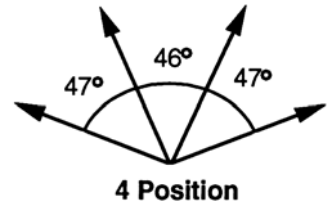
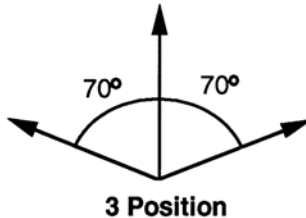
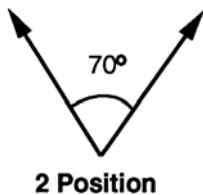

Maximum Contact Block Usage (Includes Types K and SK)

- 2 blocks mounted side by side only:** Any 2, 3 or 4 position spring return selector switch (non-illuminated, illuminated or keyed).
- 2 blocks mounted in tandem on one side only:** Any 2 operator interlocked push button.
- 2 blocks mounted in tandem (total of four blocks):** Any selector push button, keyed push button, 2, 3, or 4 position maintained selector switch (non-illuminated, illuminated or keyed), push pull operators (non-illuminated or illuminated), joy stick, dual push button.
- 3 blocks mounted in tandem (total of six blocks):** Single momentary push buttons (non-illuminated or illuminated).

Non Hazardous Locations



Hazardous Locations (see page 150)



Operator Service Temperature Range:

-22 °F to + 140 °F at 50% relative humidity
-30 °C to + 60 °C

Environmental Ratings:

Types K: The Type K (Series H) operators are UL Listed for use in Types 1, 2, 3, 3R, 4, 6, 12 and 13 flat surface enclosures.
Type SK: The Type SK operators are UL Listed for use in Types 1, 2, 3, 3R, 4, 4X, 6, 12 and 13 flat surface enclosures.
Types K, SK: For hazardous location use — see page 150.

Dimensions:

Types K and SK: See pages 159-160.

Mounting Hole Dimensions:

See page 153.

Minimum Centerline Spacing:

Types K and SK: See page 153.

Push Buttons and Operator Interface - Type K and SK, 30 mm Application Data, Materials

Type K Operator Materials:

Push Button and Push To Test Pilot Light
(Types KR and KT)

Gasket – Nitrile
Seal – Nitrile
Seal Cap – Amorphous Acetal
Decorative Ring – Polyester Film
Compensating Washer – Polypropylene
Lock Ring – Amorphous Nylon
Stem – Thermoplastic Polyester
Base Cap – Thermoplastic Polyester
Knob – Polycarbonate
Liner – Polypropylene
Hold Down Spring for Type K-15 – Neoprene
Operator Base – Zinc
Operator Base (KR8) – Polyester
Return Spring – Music Wire or Stainless Steel (KT only)
Ring Nuts – Aluminum or Zinc
Springkeeper – Steel
Locking Thrust Washer – Zinc
Color Insert – Polyethylene
Boots – Silicone

Selector Switch (Types KS)

Gasket – Nitrile
Seal – Nitrile
Bearing Washer – Polyester Film
Compensating Washer – Polypropylene
Cam Follower – Delrin 100
Liner – Polypropylene
Knob – Polycarbonate
Cam Carrier – Amorphous Nylon
Cam Rotor – Celenex 3300
Cam Profile– Delrin 100
Operator Base – Zinc
Detent Spring – Stainless Steel
Ring Nuts – Aluminum or Zinc
Seal keeper – Stainless Steel
Locking Thrust Washer – Zinc

Pilot Light (Type KP)

Gasket – Nitrile
Compensating Washer – Polypropylene
Lens – Glass or Polycarbonate
Light Module Housing – Thermoplastic Polyester
Operator Base – Zinc
Glass Lens Ring – Anodized Aluminum

Contact Block And Light Module Materials:

Contact Block (Type KA)

Housing – Amorphous Nylon
Contact Slider – Phenolic, Nylon or Acetal
Terminal – Steel
Saddle Clamp – Steel
Spring – Stainless Steel
Contacts – Silver and Copper
Blade – Beryllium Copper
Mounting Screw – Steel
Label – Paper

Type SK Operator Materials:

Push Button and Push To Test Pilot Light
(Types SKR and SKT)

Base – Thermoplastic Polyester
Stem – Acetal (non-illuminated push button)
Thermoplastic Polyester (illuminated push button
and push-to-test pilot light)
Seal – Nitrile
Gasket – Nitrile
Spring – 302 Stainless Steel
Spring Support – CRS
Lock Ring – Nylon
Trim Washer – Polypropylene
Locking Thrust Washer – Thermoplastic Polyester
Ring Nut – Thermoplastic Polyester
Color Insert – Polyethylene (non-illuminated push button)
Color Cap – Polycarbonate (illuminated push button and
push-to-test pilot light)
Mushroom Button – Acetal (non-illuminated push button)
Polycarbonate (illuminated push button)
Liner – Polypropylene (non-illuminated push button)

Selector Switch (Types SKS)

Base – Thermoplastic Polyester
Seal – Nitrile
Gasket – Nitrile
Seal Keeper – 302 Stainless Steel
Spring – 302 Stainless Steel
Cam Follower – Delrin 100
Bearing Washer – Polyester Film
Cam Carrier – Trogamid
Cam Profile – Delrin 100
Liner – Polypropylene (non-illuminated only)
Knob – Polycarbonate
Trim Washer – Polypropylene
Locking Thrust Washer – Thermoplastic Polyester
Spring Support – CRS









Pilot Light (Type SKP)

Gasket – Nitrile
Base – Thermoplastic Polyester
Trim Washer – Polypropylene
Locking Thrust Washer – Thermoplastic Polyester
Ring Nut – Thermoplastic Polyester
Color Cap – Polycarbonate











Light Module (Type KM)

Housing – Thermoplastic Polyester
Socket – Steel
Terminal – Steel with Tin Plate
Saddle Clamp – Steel
Translating Pin – Polycarbonate
Transformer – Thermoplastic Polyester, Steel, Copper,
Polyvinyl Chloride, Polytetrafluorethylene,
Acetate, Paper
Lamp Spring – Tin Plated Music Wire

Push Buttons and Operator Interface - Type K and SK, 30 mm Accessories

Description	Color	Type	Package Qty.
 Color inserts for KR1, KR2, KR3, KR11, KR12, SKR11, SKR12, KR1, KR2, KR3, KR11, KR12, SKR11, SKR12, KR1, KR2, KR3, KR11, KR12, SKR11, SKR12, KR1, KR2, KR3, KR11, KR12, SKR11, SKR12, KR1, KR2, KR3, KR11, KR12, SKR11, SKR12	Black Blue Gray Green Orange Red Universal ① White Yellow	T8BK T8BE T8GY T8GN T8OE T8RD T8U T8WH T8YW	10 10 10 10 10 10 10 10 10
 1 3/8" Snap-in Mushroom knob for KR4 and SKR4 ③	Black Blue Green Orange Red Red ② Yellow	K16B K16L K16G K16S K16R K16R05 K16Y	1 1 1 1 1 1 1
 2 1/4" Snap-in Mushroom knob for KR5 and SKR5 ④	Black Blue Green Orange Red Red ② Yellow	K17B K17L K17G K17S K17R K17R05 K17Y	1 1 1 1 1 1 1
 1 3/8" Screw-on Mushroom knob for KR24 and SKR24 ⑤	Black Blue Green Orange Red Yellow	K92B K92L K92G K92S K92R K92Y	1 1 1 1 1 1
 2 1/4" Screw-on Mushroom knob for KR25 and SKR25 ⑥	Black Blue Green Orange Red Yellow	K93B K93L K93G K93S K93R K93Y	1 1 1 1 1 1
 1 5/8" Push-Pull Knobs for KR8, KR9, SKR8, SKR9 Operators	Amber Black ⑦ Blue Clear Green Orange ⑦ Red Red ⑧ White Yellow	A22 B23 L22 C22 G22 S23 R22 R2205 W22 Y22	1 1 1 1 1 1 1 1 1 1
 Color Inserts for Dual Function Operators KR6, KR7, KR67	Black Green Red Universal ⑧	B19 G19 R19 U19	10 10 10 10
 Standard Color Caps for Illuminated Push Buttons K1L, K2L, K3L, SK1L, SK2L	Amber Blue Clear Green Red White Yellow	A7 L7 C7 G7 R7 W7 Y7	1 1 1 1 1 1 1

- ① Includes one each of the following color inserts: Black, Red, Green, Yellow, Orange, Blue, and White.
- ② "EMERGENCY STOP" is in raised letters and hot stamped white across the front of the mushroom button.
- ③ The mushroom button kits listed here may be assembled to a 9001 KR1U or SKR1U to form a 9001 KR4 or SKR4.
- ④ The mushroom button kits listed here may be assembled to a 9001 KR1U or SKR1U to form a 9001 KR5 or SKR5.
- ⑤ The mushroom button kits listed here may be assembled to a 9001 KR20 to form a 9001 KR24 or SKR24.
- ⑥ The mushroom button kits listed here may be assembled to a 9001 KR20 to form a 9001 KR25 or SKR25.
- ⑦ These color caps are opaque and are for use on non-illuminated operators only.
- ⑧ Includes two of each of the following color inserts: Black, Red, and Green.
- ⑨ May be used on KR8 and KR9 operators. Order mushroom button and K54 adapter (no charge) from page 158. Using the K54 adapter voids Type 6 rating.
- ⑩ Red knob with "Push Emergency Stop" marked on top of knob.

Description	Color	Type	Package Qty.
 1 3/8" Mushroom Knob for Illuminated Push Buttons K2L, SK2L ⑩	Amber Blue Clear Green Red White Yellow	A20 L20 C20 G20 R20 W20 Y20	1 1 1 1 1 1 1
 2 1/4" Mushroom Knob for Illuminated Push Buttons K2L, SK2L ⑩	Amber Blue Clear Green Red White Yellow	A21 L21 C21 G21 R21 W21 Y21	1 1 1 1 1 1 1
 Plastic Fresnel Pilot Light Lens for KP, KT, SKP, SKT	Amber Blue Clear Green Red White Yellow	A31 L31 C31 G31 R31 W31 Y31	1 1 1 1 1 1 1
 Domed Plastic Pilot Light Lens for KP, KT, SKP, SKT	Amber Blue Clear Green Red White Yellow	A9 L9 C9 G9 R9 W9 Y9	1 1 1 1 1 1 1
 Glass Pilot Light Lens for KP, KT	Amber Blue Clear Green Red White Yellow	A6 L6 C6 G6 R6 W6 Y6	1 1 1 1 1 1 1
 Standard Selector Switch Knob for K and SK Selector Switches	Amber Black ⑦ Blue Clear Green Orange ⑦ Red White Yellow	A8 B11 L8 C8 G8 S11 R8 W8 Y8	1 1 1 1 1 1 1 1 1
 Gloved Hand Selector Switch Knob for K and SK Selector Switches	Amber Black ⑦ Blue Clear Green Orange ⑦ Red White Yellow	A24 B25 L24 C24 G24 S25 R24 W24 Y24	1 1 1 1 1 1 1 1 1
 Coin Operated Selector Switch Knob for K and SK Selector Switches	Black ⑦ Blue Clear Green Red Yellow	B18 L16 C16 G16 R16 Y16	1 1 1 1 1 1
 Color Inserts for KQ and TQ Selector Push Buttons	Black Blue Green Orange Red White Yellow	T5BK T5BE T5GN T5OE T5RD T5WH T5YW	10 10 10 10 10 10 10
 Selector Switch Cams	B C D E F G H J L M	K13B K13C K13D K13E K13F K13G K13H K13J K13L 3105402402	

Push Buttons and Operator Interface - Type K and SK, 30 mm Replacement Parts

Ring Nuts

Used On	Type	Used On	Type
K1L	K44	SK1L	SK44
K30-K37	6512233501	-	-
K70-K73	6512233501	-	-
K20, K21, K22, K23	K45	SK20, SK21, SK22, SK23	SK45
K20, K21, K22, K23 ③	K46	SK20, SK21, SK22, SK23 ③	SK46
K2L	K49	SK2L	SK49
K3L	K111	-	-
KP, KTR	K40	SKP, SKTR	SK40
KR1	K41	SKR1	SK41
KR11	K42	SKR11	SK42
KR12 ①	K42	SKR12 ①	SK42
KR12 ②	K41	SKR12 ②	SK41
KR13-, 14-, 15-	K55	-	-
KR2	K42	SKR2	SK42
KR20	K49	-	-
KR24	K49	-	-
KR25	K49	-	-
KR3	K40	SKR3	SK40
KR4	K41	SKR4	SK41
KR5	K41	SKR5	SK41
KR6	K47	-	-
KR67	K47	-	-
KR7	K47	-	-
KR8, KR89	K58	SKR8, SKR89	SK58
KR9	K41	SKR9	SK41
KS	K45	SKS	SK45
KS ③	SK46	SKS ③ SKRU11 SKRU1,2,3,4,5,10	SK46 SK41 SK40
KT	K49	SKT	SK49

- ① Maintained button of two button operator.
 ② Momentary button of two button operator.
 ③ Secondary ring nut (holds knob on selector switch or potentiometer).

Replacement Lamps for Series A thru F (black) Light Modules

Light Module Type	Lamp No. (ANSI)	Square D Replacement Lamps
		Part Number
KM1	GE44 ④	-
KM2	GE1490	2550101003
KM3	GE44 ④	-
KM4	GE1490	2550101003
KM5	GE44 ④	-
KM6	GE44 ④	-
KM7	GE44 ④	-
KM8	GE44 ④	-
KM9	GE755	2550101020
KM11	CMDK1A5	2550105014
KM12	CMDK1A5	2550105014
KM13	CMDK1A5	2550105014
KM14	CMDK1A5	2550105014
KM15	CMDK1A5	2550105014
KM21	SYL 12PSB	2550105003
KM22	SYL 12PSB	2550105003
KM23	SYL 28PSB	2550105008
KM25	SYL 120PSB	2550105005
KM31	SYL 6PSB	2550105007
KM32	SYL 12PSB	2550105003
KM34	SYL 24PSB	2550105004
KM35	SYL 28PSB	2550105008
KM36	SYL 48PSB	2550105009
KM37	SYL 60PSB	2550105010
KM38	SYL 120PSB	2550105005

④ GE44 and GE755 are interchangeable (GE755 gives longer life). If a GE-44 lamp is ordered, a GE755 (2550101020) will be substituted. For a replacement lamp in a current series light module see the light module listing on page 148.

Selector Switch Cams

Cam	Type	Cam	Type
B	K13B	G	K13G
C	K13C	H	K13H
D	K13D	J	K13J
E	K13E	L	K13L
F	K13F	M	3105402402

Repair Parts

Description	Part Number
E11 Key	2941101100
E11 through E33 keys	Refer to page 134
D10 Key	2940601100
Master Key for E36 - E60	2941151990
Gray cap for KR11, KR12, SKR11, or SKR12	3105217001
Clear plastic top (only) for 9001 K44 & SK44	4487D63XI
Ring Nut	
Gasket for Type K and SK Push-Pull Knob	6509701801
Gasket for Plastic Illuminated Lens	6509701901
Gasket for Type K and SK selector switch knob	3105406401
Black Compensating Gasket (Type K and SK Operators)	6509702001
Liner for Non Illuminated Operators	6509704901
Locking Thrust Washer	6512231201
Nylon Spacer	6509705001
Locking Thrust Washer (Std. Type SK Operator)	6512240601
Push Pull Mushroom Adapter ⑤	K54
Rubber Boot for Joystick	6512243201
Knob on Joysticks without latch	4458D20X3

⑤ Allows Type -20 and -21 mushroom color caps to be used on push pull operators. Use of 9001 K54 voids Type 6 rating.

KU Replacement Ring Nuts (Threaded Inside and Out)

Used On	Part Number
KU1 through KU8, KU27, KU37, KU47	3105204101
KU17, KU18	3105205901

Interlock



For mechanically interlocking two push buttons so that only one button can be depressed at a time. A Type K3 attachment is furnished with the 9001 KR11, KR12, SKR11, SKR12, SKRU1 and SKRU11 operators. However, maintained operators are supplied here and the K3 interlock serves to release one of the buttons when the other is depressed. When used with momentary contact buttons, the K3 interlock **does not** hold the buttons in the depressed position. It simply prevents pushing both buttons at the same time. The Type K3 interlock can be mounted behind the operators. Operators and blocks not included.

Type

K3

Screwdriver



Used to tighten mounting screws on contact blocks and light modules.

Type No.

K69

Wrench



K95



K1

Where Used	Type
For tightening ring nuts on Types K, KX, SK and J control units	K95
For protective cap kits	K1

Push Buttons and Operator Interface - Type K and SK, 30 mm Dimensions

Approximate Dimensions — Consult your local Square D Sales Office for latest version of dimension drawings.

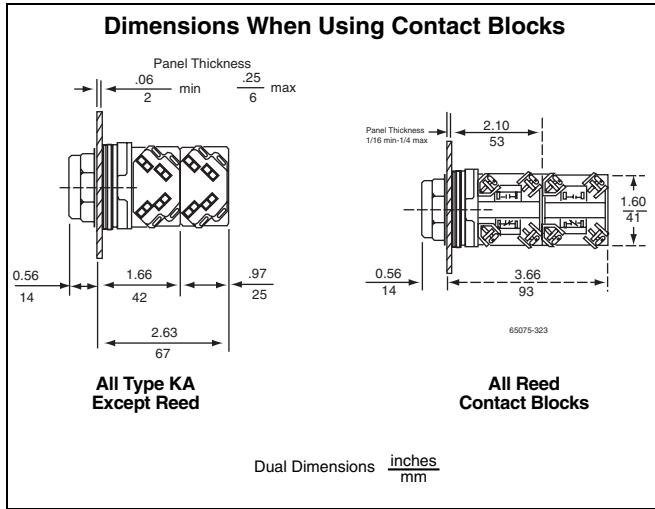
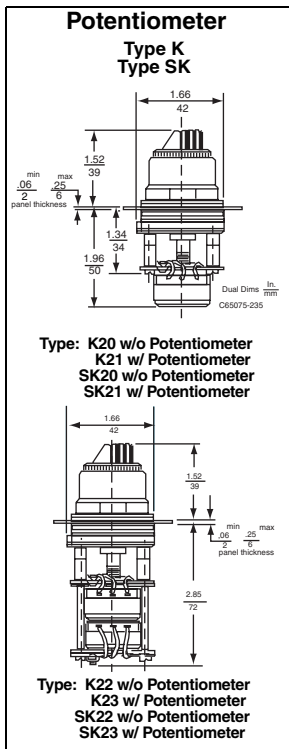
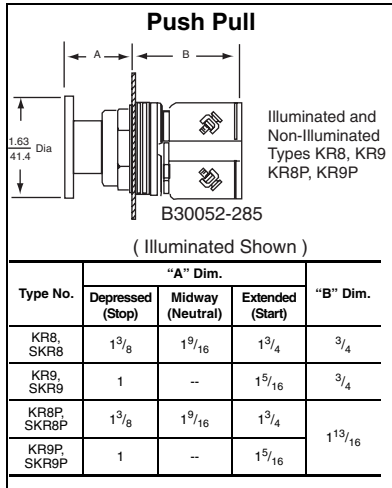
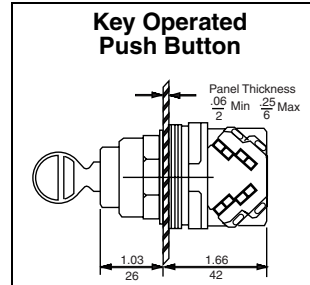
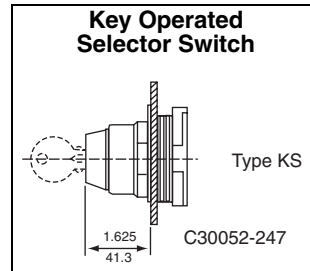
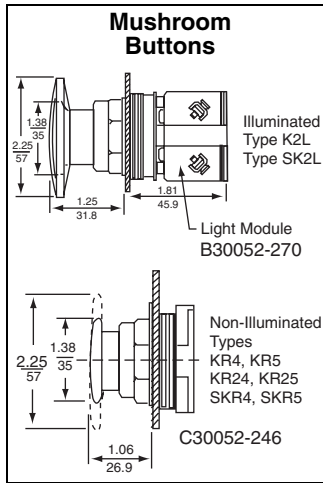
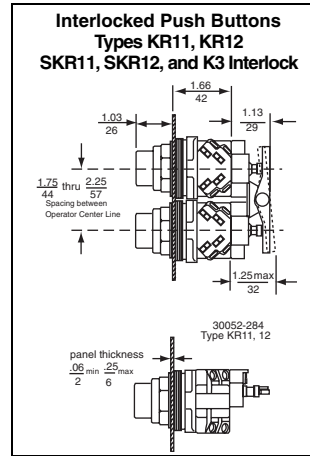
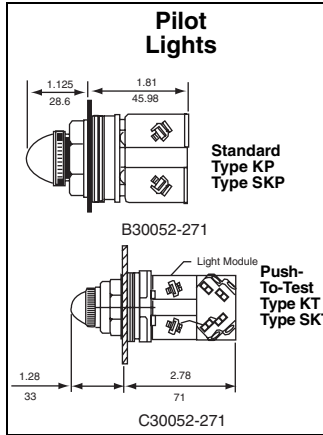
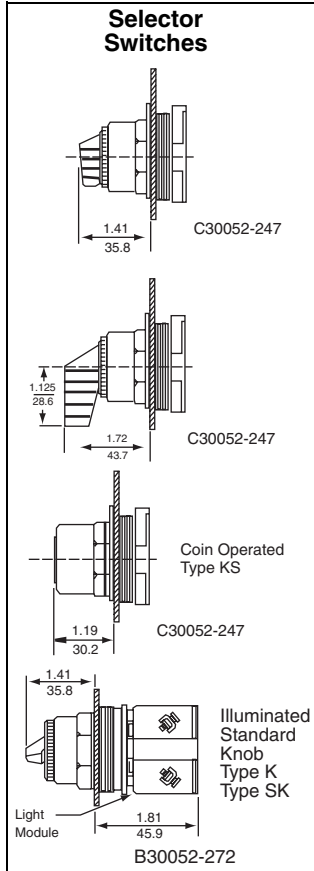
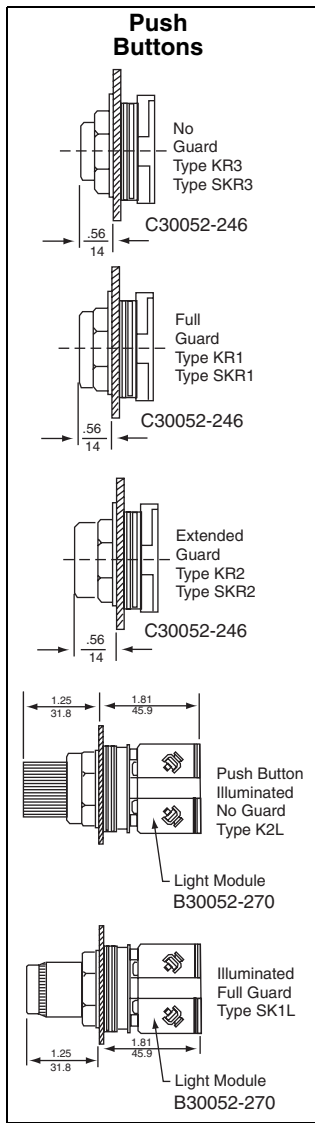

Push Buttons and Operator Interface - Type K and SK, 30 mm Dimensions

Approximate Dimensions — Consult your local Square D Sales Office for latest version of dimension drawings.

Time Delay Push Button

Type No.	Dimension A	Dim. B
KRD1UH1 KRD1UH2	Full Guard	9 ¹ / ₁₆ 2 ¹ / ₂
KRD2UH1 KRD2UH2	Ext. Guard	1 ¹ / ₁₆ 2 ¹ / ₂
KRD3UH1 KRD3UH2	No Guard	9 ¹ / ₁₆ 2 ¹ / ₂

Emergency "Break Glass" Operator Type K15

Panel Thickness: .06 / 2 min, .25 / 6 max

B30051-248

Dual Function Operator Types KR6, KR7

C30052-246-A

Selector Push Button Type KQ

C30052-247

Padlock Attachments

Type K4, Type K96, Type K7, K107, K108, K109, and K110, Type K6, K60, and K97, Type K62, Type K5

Protective Boots

Type KU1 to KU8, Type KU27, TYPE KU37, TYPE KU47, TYPE KU17, TYPE KU18

Alternate Action Module "Push-on, Push-off" Type K85

1.61 / 40.9, 0.75 / 19.05

Mushroom Button Guards

Type K48, Type K56Y, K56YM, Type K68

* 9001K56YM includes finger holes.

Rocker Arm Operating Lever Type K50

Dual Dimensions inches / mm

C65013-001-27

Push Buttons and Operator Interface Specifier's Guide

Type KX 30 mm Push Buttons

Catalog
2005

File 9001



CONTENTS

Description	Page
Type KX Square Multifunction Complete Operators	162
Type KX Square Oiltight/Watertight Operators	165
Type KX Selector Switch Selection Guide	166
Type KX Square Multifunction Selector Switches	167
Type KX Square Multifunction Pilot Lights	168
Type KX Legends	170
Type KX Accessories	171
Types K, SK, KX, and T Contact Blocks	172
Hazardous Location Information	173
"H" Numbers	174
Application Data, Materials	175
Type KX Dimensions	176
Declaration of Conformity	224



Push Button and Operator Interface - Type KX 30 mm Square Multifunction Complete Operators

The operators listed below come complete with color caps, legend inserts/plates, contact blocks, and light modules (illuminated operators only) and can be ordered using the short type number. If the operator you desire is not listed below, see pages 162 through 171. For a component breakdown of each of the operators listed on this page, refer to Product Data M-603.

For use in hazardous locations – See page 173.

Description	Button Color	Legend Marking	Contacts	Type Number
	Green	Start	$\begin{matrix} \text{O} & \text{I} & \text{O} \\ \text{O} & & \text{O} \end{matrix}$	KXRA101
	Red	Stop	$\begin{matrix} \text{O} & & \text{O} \\ \text{O} & & \text{O} \end{matrix}$	KXRA102
	Green	Start	$\begin{matrix} \text{I} \\ \text{O} \end{matrix}$	KXRA133
	Red	Stop	$\begin{matrix} \text{O} & \text{I} & \text{O} \\ \text{O} & & \text{O} \end{matrix}$	KXRA134
	Red Mushroom	Emerg. Stop	$\begin{matrix} \text{O} & \text{I} & \text{O} \\ \text{O} & & \text{O} \end{matrix}$	KXRN105
Illuminated 110-120 V, 50-60 Hz Transf.	Green	Start	$\begin{matrix} \text{O} & \text{I} & \text{O} \\ \text{O} & & \text{O} \end{matrix}$	KXRB103
	Red	Stop	$\begin{matrix} \text{O} & & \text{O} \\ \text{O} & & \text{O} \end{matrix}$	KXRB104
	Red Mushroom	Emerg. Stop	$\begin{matrix} \text{O} & \text{I} & \text{O} \\ \text{O} & & \text{O} \end{matrix}$	KXRP106

Dual Push Buttons

Description	Top Button (#1)	Bottom Button (#2)	Contacts	Type Number
	Green-Mom.-Start	Red-Mom.-Stop	$\begin{matrix} \text{O} & \text{I} & \text{O} & \text{O} & \text{I} & \text{O} \\ \text{O} & & \text{O} & \text{O} & & \text{O} \end{matrix}$	KXRC111
	Green-Mom.-Start	Red-Mom.-Stop	$\begin{matrix} \text{I} \\ \text{O} \end{matrix}$ $\begin{matrix} \text{O} & \text{I} & \text{O} \\ \text{O} & & \text{O} \end{matrix}$	KXRC136
	Green-Mom.-Up*	Green-Mom.-Down*	$\begin{matrix} \text{O} & \text{I} & \text{O} & \text{O} & \text{I} & \text{O} \\ \text{O} & & \text{O} & \text{O} & & \text{O} \end{matrix}$	KXRD112
	Green-Mom.-Open*	Green-Mom.-Close*	$\begin{matrix} \text{O} & \text{I} & \text{O} & \text{O} & \text{I} & \text{O} \\ \text{O} & & \text{O} & \text{O} & & \text{O} \end{matrix}$	KXRD113
	Green-Mom.-Fwd.*	Green-Mom.-Rev.*	$\begin{matrix} \text{O} & \text{I} & \text{O} & \text{O} & \text{I} & \text{O} \\ \text{O} & & \text{O} & \text{O} & & \text{O} \end{matrix}$	KXRD114
	Green-Mom.-Up*	Green-Mom.-Down*	$\begin{matrix} \text{I} \\ \text{O} \end{matrix}$ $\begin{matrix} \text{I} \\ \text{O} \end{matrix}$	KXRD140
	Green-Mom.-Open*	Green-Mom.-Close*	$\begin{matrix} \text{I} \\ \text{O} \end{matrix}$ $\begin{matrix} \text{I} \\ \text{O} \end{matrix}$	KXRD141
	Green-Mom.-Fwd.*	Green-Mom.-Rev.*	$\begin{matrix} \text{I} \\ \text{O} \end{matrix}$ $\begin{matrix} \text{I} \\ \text{O} \end{matrix}$	KXRD142
	Green-Maint.-Start*	Red-Maint.-Stop*	$\begin{matrix} \text{O} & \text{I} & \text{O} \\ \text{O} & & \text{O} \end{matrix}$	KXRE115
	Green-Mom.-Reset*	Red-Maint.-Stop*	$\begin{matrix} \text{O} & \text{I} & \text{O} \\ \text{O} & & \text{O} \end{matrix}$	KXRF116

Dual Push Button With One Pilot Light

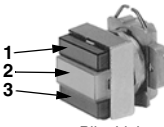

Description	Top Button (#1)	Middle Lens (#2)	Bottom Button (#3)	Contacts	Type Number
	Green-Mom.-Start	Red-On	Red-Mom.-Stop	$\begin{matrix} \text{O} & \text{I} & \text{O} & \text{O} & \text{I} & \text{O} \\ \text{O} & & \text{O} & \text{O} & & \text{O} \end{matrix}$	KXRG117
	Green-Mom.-Start	Red-On	Red-Mom.-Stop	$\begin{matrix} \text{I} \\ \text{O} \end{matrix}$ $\begin{matrix} \text{O} & \text{I} & \text{O} \\ \text{O} & & \text{O} \end{matrix}$	KXRG137
	Green-Mom.-Blank	Red-Blank	Green-Mom.-Blank	$\begin{matrix} \text{O} & \text{I} & \text{O} & \text{O} & \text{I} & \text{O} \\ \text{O} & & \text{O} & \text{O} & & \text{O} \end{matrix}$	KXRH118
	Green-Maint.-Start	Red-On	Red-Maint.-Stop	$\begin{matrix} \text{O} & \text{I} & \text{O} \\ \text{O} & & \text{O} \end{matrix}$	KXRJ119
	Green-Mom.-Reset*	Red-On	Red-Maint.-Stop	$\begin{matrix} \text{O} & \text{I} & \text{O} \\ \text{O} & & \text{O} \end{matrix}$	KXRK120

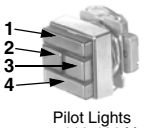
Dual Push Button With Dual Pilot Lights

Description	Top Button (#1)	Left Lens (#2)	Right Lens (#3)	Bottom Button (#4)	Contacts	Type Number
	Green-Mom.-Start	Red-On	Green-Off	Red-Mom.-Stop	$\begin{matrix} \text{O} & \text{I} & \text{O} & \text{O} & \text{I} & \text{O} \\ \text{O} & & \text{O} & \text{O} & & \text{O} \end{matrix}$	KXRL121
	White-Mom.-Number 1	White 1	Blue 2	Blue-Mom.-Number 2	$\begin{matrix} \text{O} & \text{I} & \text{O} & \text{O} \\ \text{O} & & \text{O} & \text{O} \end{matrix}$	KXRL132
	Green-Mom.-Start	Red-On	Green-Off	Red-Mom.-Stop	$\begin{matrix} \text{I} \\ \text{O} \end{matrix}$ $\begin{matrix} \text{O} & \text{I} & \text{O} \\ \text{O} & & \text{O} \end{matrix}$	KXRL138
	Green-Mom.-Blank	Red-Blank	Red-Blank	Green-Mom.-Blank	$\begin{matrix} \text{O} & \text{I} & \text{O} & \text{O} & \text{I} & \text{O} \\ \text{O} & & \text{O} & \text{O} & & \text{O} \end{matrix}$	KXRM122

* Buttons are mechanically interlocked.

Selector Switches

Non-Illuminated					
Description	Positions	Legend	Knob	Contacts	Type Number
	2-Maint.	Off-On	Black	$\begin{matrix} 1 & 0 \\ 0 & 1 \end{matrix}$	KXSA125
	2-Maint.	Off-On	Black	$\begin{matrix} 0 & 1 \end{matrix}$	KXSA139
	3-Maint.	Hand-Off-Auto.	Black	$\begin{matrix} 1 & 0 & 0 \\ 0 & 0 & 1 \end{matrix}$	KXSD126
	3-Maint.	Hand-Off-Auto.	Black	$\begin{matrix} 1 & 0 & 0 \\ 0 & 0 & 1 \\ 1 & 0 & 0 \\ 0 & 0 & 1 \end{matrix}$	KXSD127
Illuminated - 110-120 V, 50-60 Hz, Transf.					
Description	Positions	Legend	Knob	Contacts	Type Number
	2-Maint.	Off-On	Red	$\begin{matrix} 1 & 0 \\ 0 & 1 \end{matrix}$	KXSJ128
	3-Maint.	Hand-Off-Auto.	Red	$\begin{matrix} 1 & 0 & 0 \\ 0 & 0 & 1 \end{matrix}$	KXSM129
	3-Maint.	Hand-Off-Auto.	Red	$\begin{matrix} 1 & 0 & 0 \\ 0 & 0 & 1 \\ 1 & 0 & 0 \\ 0 & 0 & 1 \end{matrix}$	KXSM130

Single Pilot Light

Description	Lens Color	Legend Marking	Type Number
	Standard	Red Green Off	KXPA107 KXPA108
	Push-To-Test	Red Green Off	KXTA109 KXTA110

Dual Push To Test Pilot Light

(Pushing Button #1 Tests Pilot Light #2 — Pushing Button #4 Tests Pilot Light #3)

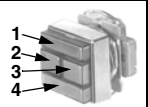
Description	Top Button (#1)	Left Lens (#2)	Right Lens (#3)	Bottom Button (#4)	Type Number
	Green-Blank	Red-Blank	Red-Blank	Green-Blank	KXTC123

Dual Pilot Light

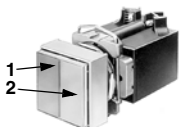
Description	Left Lens (#1)	Right Lens (#2)	Type Number
	Red-On	Green-Off	KXPB124

Four Field Pilot Light

Description	Top Left (#1)	Top Right (#2)	Bottom Left (#3)	Bottom Right (#4)	Type Number
	White-Blank	Blue-Blank	Green-Blank	Red-Blank	KXPC131
Remote Test ♦ 120 V, AC Resistor	White-Blank	Blue-Blank	Green-Blank	Red-Blank	KXTE150 ♦

♦ If all four lamps are illuminated at the same time continuously – do NOT operate above 120 Vac.

Push Button and Operator Interface - Type KX 30 mm Square Multifunction Operators

Non-Illuminated Push Buttons

For use in hazardous locations – See page 173.

All non-illuminated push buttons are of the no guard type. To make the Type KXRA operator a full guard type (does not apply to the KXRN operators), add a shroud from page 171. If legend inserts are required to be assembled into the operator, see instructions on page 170.

Momentary operators on this page will accept up to three Type KA contact blocks mounted in tandem (total of six blocks).

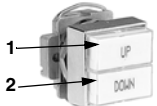

Maintained operators on this page will accept up to two Type KA contact blocks mounted in tandem (total of four blocks).

Description	Button Type	Button Cover Color	Type Number
 Single Button Momentary	Standard	No Cover Green Red Amber White Blue	KXRA KXRAG KXRAR KXRAA KXRAW KXRAL
	Mushroom	No Cover Red Green Amber White Blue	KXRN KXRNR KXRNG KXRNA KXRNW KXRNL

Description	Button Type	Mechanical Interlock	Button Cover Color		Type Number
			(1) Top	(2) Bottom	
 Dual Push Button (Non-illuminated Only)	Both Momentary	No	None Green Amber Other	None Red Green Other	KXRC KXRRCGR KXRRCAR KXRRCAG KXRC*
	Both Momentary	Yes	None Green Red Amber Other	None Red Green Amber Other	KXRD KXRDCGR KXRDCAR KXRDCAG KXRDA KXRD*
	Both Maintained	Yes	None Green Red Amber Other	None Red Green Amber Other	KXRE KXREGR KXREAR KXREAG KXREA KXRE*
	Top Button Momentary Bottom Button Maintained	Yes	None Green Green Green Other	None Red Green Amber Other	KXRF KXRFCGR KXRFCAR KXRFCAG KXRFA KXRF*



* Add 2 color codes from button cover table. See example below.
Example: To get a Dual Push Button similar to a 9001KXRRCGR except the top button is blue, order a 9001KXRCLR.

Button Covers

Description	For Use on	Color	Type Number	Code
 Includes KXN100	KXRA	Red Green Amber Blue White	KXAR1 KXAG1 KXAA1 KXAL1 KXAW1	R G A L W
 Includes KXN100	KXRN	Red Green Amber Blue White	KXARM1 KXAGM1 KXAA1 KXALM1 KXAWM1	R G A L W
 Includes KXN200	KXRC KXRD KXRE KXRF	Red Green Amber Blue White	KXAR2 KXAG2 KXAA2 KXAL2 KXAW2	R G A L W

◆ Two required per operator. When ordering an assembled operator — specify two code numbers. The first code will be assembled into #1 and the second code will be assembled into #2.

Standard Contact Blocks

Symbol	Contact Block Type	Contact Block Assembled To Operator
		Suffix▲
	KA1	H13
	KA2	H5
	KA3	H6

▲ **Example:** Class 9001 Type KXRAG with a KA1 contact block is Type KXRAGH13.
 Types KA1 and KA3 NC contacts are direct opening 

Shroud	Page 171
Lockouts	Page 171
Boots	Page 171
Contact Blocks	Pages 172-173
“H” Numbers	Page 174
Legend Inserts	Page 170
Dimensions	Page 176
Application Data	Page 175
Completely Assembled Operators	Page 162
Ratings	Pages 172-173

Push Button and Operator Interface - Type KX 30 mm Square Oiltight/Watertight Operators

Illuminated Push Buttons

For use in hazardous locations – See page 173.

All illuminated push buttons are of the no guard type. To make them a full guard type (does not apply to the KXRP operators), add a shroud from page 171. If legend inserts are required to be assembled into the operators, see instructions on page 170.

Momentary operators on this page will accept up to three Type KA contact blocks mounted in tandem (total of six blocks).

Maintained operators on this page will accept up to two Type KA contact blocks mounted in tandem (total of four blocks).

To order operators with color caps other than those listed below, substitute the proper color code from the Button Cover Table.

Example: To get a Dual Push Button/Single Pilot Light similar to a 9001 KXRG1GGR except the pilot light is white, order a 9001 KXRG1GWR.

Description	Button Type	Mechanical Interlock	Voltage	Button Cover Color	Type Number
	Both Momentary	No	No Light Module	No Covers	KXRG
			110-120 V 50-60 Hz Trans.	No Covers Green-Red-Red Green-Green-Red Green-Amber-Red	KXRG1 KXRG1GRR KXRG1GGR KXRG1GAR
			Other Voltages	No Covers	KXRG*
	Both Momentary	Yes	No Light Module	No Covers	KXRH
			110-120 V 50-60 Hz Trans.	No Covers Green-Red-Green Green-Amber-Green Red-Green-Red	KXRH1 KXRH1GRG KXRH1GAG KXRH1RGR
			Other Voltages	No Covers	KXRH*
	Both Maintained	Yes	No Light Module	No Covers	KXRJ
			110-120 V 50-60 Hz Trans.	No Covers Green-Red-Red Green-Green-Red Green-Amber-Red	KXRJ1 KXRJ1GRR KXRJ1GGR KXRJ1GAR
			Other Voltages	No Covers	KXRJ*
	Top Momentary Bottom Maintained	Yes	No Light Module	No Covers	KXRK
			110-120 V 50-60 Hz Trans.	No Covers Green-Red-Red Green-Green-Red Green-Amber-Red	KXRK1 KXRK1GRR KXRK1GGR KXRK1GAR
			Other Voltages	No Covers	KXRK*

* Insert the proper voltage code from page 168 (single lamp).

Description	Button Type	Voltage	Button Cover Color	Type Number
	Standard	No Light Module	No Cover	KXRA
		110-120 V 50-60 Hz Trans.	No Cover Green Red Amber White Blue	KXRB1 KXRB1G KXRB1R KXRB1A KXRB1W KXRB1L
		Other Voltages	No Cover Green Red	KXRB* KXRB*:G KXRB*:R
	Mushroom	No Light Module	No Cover	KXRN
		110-120 V 50-60 Hz Trans.	No Cover Red Green Amber White Blue	KXRP1 KXRP1R KXRP1G KXRP1A KXRP1W KXRP1L
		Other Voltages	No Cover Red Green	KXRP* KXRP*:R KXRP*:G

* Insert the proper voltage code from page 168 (single lamp).

Button Covers

Description	For Use on	Color	Type Number	Code
Includes KXN100	KXRA KXRB	Red Green Amber Blue White	KXAR1 KXAG1 KXAA1 KXAL1 KXAW1	R G A L W
Includes KXN100	KXRN KXRP	Red Green Amber Blue White	KXARM1 KXAGM1 KXAAM1 KXALM1 KXAWM1	R G A L W
Includes KXN400	KXRG (Pos. 1 & 3) KXRH (Pos. 1 & 3) KXRJ (Pos. 1 & 3) KXRK (Pos. 1 & 3) KXRL (Pos. 1 & 4) KXRM (Pos. 1 & 4)	Red Green Amber Blue White Black	KXAR4 KXAG4 KXAA4 KXAL4 KXAW4 KXAB4	R G A L W B ▼
Includes KXN300	KXRG (Pos. 2) KXRH (Pos. 2) KXRJ (Pos. 2) KXRK (Pos. 2)	Red Green Amber Blue White	KXAR3 KXAG3 KXAA3 KXAL3 KXAW3	R G A L W
Includes KXN500	KXRL (Pos. 2 & 3) KXRM (Pos. 2 & 3)	Red Green Amber Blue White	KXAR5 KXAG5 KXAA5 KXAL5 KXAW5	R G A L W

▼ Not available with text.

Replacement Parts

Ring Nut Adapter Assembly w/o Liner Spring Clip Adapter with Liner	6508901401 6508903350 6508900902 6508903351
---	--

Description	Button Type	Mechanical Interlock	Voltage and Frequency	Button Cover Color	Type Number
	Both Momentary	No	No Light Module	No Covers	KXRL
			110-120 V 50-60 Hz Transformer	No Covers Green-Green-Red-Red Green-Red-Red-Red Red-Green-Red-Red Red-Green-Green-Red	KXRL1 KXRL1GRRR KXRL1GRRG KXRL1RGRR
			Other Voltages	No Covers	KXRL*:
			No Light Module	No Covers	KXRM
Both Momentary	Yes	Yes	110-120 V 50-60 Hz Transformer	No Covers Green-Green-Red-Red Green-Red-Red-Red Red-Green-Green-Red	KXRM1 KXRM1GRRR KXRM1GRRG KXRM1RGRR
			Other Voltages	No Covers	KXRM*:

* Insert the proper voltage code from page 169 (dual lamp).

Lockout	Page 171
Shroud	Page 171
Contact Blocks	Pages 172 - 173
Completely Assembled Operators	Page 162
Legend Inserts	Page 170
Boots	Page 171
Lamp and Lens Removal Kit	Page 171
Dimensions	Page 176
Application Data	Page 175
Light Modules	Pages 168 - 169
"H" Numbers	Page 174
Rating	Pages 172 - 173

Push Button and Operator Interface - Type KX 30 mm Selector Switch Selection Guide

Shown below is a simplified method of selecting a selector switch to meet almost any combination of contact sequences.

Step No. 1

Determine the contact sequence(s) required. Set up a target table like the one shown for the example below.

Example:

Contact Sequence	↖	↑	↗
A	1	0	0
B	0	1	0
C	0	0	1

0 – contact open
1 – contact closed

Step No. 2

Look for a cam type common to all sequences in Table 1, 2 or 3. For the example above, Table 2 would be used. For the contact sequences A(1 0 0), B(0 1 0) and C(0 0 1) of the example above, cam types F and L are common to all 3 sequences.

Step No. 3

Next, the cam type common to all the sequences (If several cam types are common, choose one.) is used to find the operator type number. Go to the proper page number as indicated in the table below:

Number of Positions	Push Button Line	Page Number
2	Type KX	167
3	Type KX	167
4	Type KX	167

If for the example above:

- A manual return operator with a standard black knob is required and
 - If the F cam type were chosen, the operator type number would be: Type KX Line – Class 9001 Type KXSDFB (from page 167)
 - If the L cam type were chosen, the operator type number would be: Type KX Line – Class 9001 Type KXSDLB (from page 167)

Step No. 4:

Determine the contact blocks required by using the same table used for Step No. 2.

If for the example above:

- The F cam type were chosen:
 - A 9001KA3 mounted on side no. 2 would be used for sequence A(1 0 0).
 - A 9001KA3 mounted on side no. 1 would be used for sequence B(0 1 0).
 - A 9001KA2 mounted on side no. 1 or 2 would be used for sequence C(0 0 1).
- The L cam type were chosen:
 - A 9001KA2 mounted on side no. 2 would be used for sequence A(1 0 0).
 - A 9001KA2 mounted on side no. 1 or a 9001 KA3 mounted on side no. 2 would be used for sequence B(0 1 0).
 - A 9001KA3 mounted on side no. 1 would be used for sequence C(0 0 1).

One Type KA1 double circuit block can be used in place of one Type KA2 single circuit block and one Type KA3 single circuit block mounted on the same side.

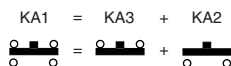

"H" Numbers Page 174
Outline Dimensions Page 176

Table 1 – 2 Position Selector Switch

If you require contact sequence		Use Sel. Sw. with cam type	Use contact block type	Mount on side No. (See page 174)
1	0	E	KA3	1 or 2
		D	KA2	1 or 2
0	1	E	KA2	1 or 2
		D	KA3	1 or 2

Table 2 – 3 Position Selector Switch

If you require contact sequence			Use Sel. Sw. with cam type	Use contact block type	Mount on side No. (See page 174)
1	0	0	G	KA2	1
			L	KA2	2
			C E	KA3	1
			B C E F G J	KA3	2
0	1	0	B	KA5*	2
			D E	KA2	1
			D E	KA2	2
			F	KA3	1
0	0	1	L	KA3	2
			C F	KA2	1 or 2
			B D G L	KA3	1
			B D	KA3	2
1	1	0	B	KA5*	1
			M	KA2	2
			C F	KA5*	1 or 2
			M	KA3	2
0	1	1	B	KA2	2
			G J	KA5*	1
			G	KA5*	2
			L	KA3	1
1	0	1	M	KA3	1
			D E	KA5*	1
			D E	KA5*	2

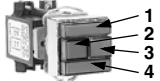

Table 3 – 4 Position Selector Switch

If you require contact sequence				Use Sel. Sw. with cam type	Use contact block type	Mount on side No. (See page 174)
1	0	0	0	H	(A) KA3	2
0	1	0	0	H	(B) KA2	1
0	0	1	0	H	(C) KA2	2
0	0	0	1	H	(D) KA3	1
1	0	0	1	H	A & D Wired in Parallel	
1	1	0	0	H	A & B Wired in Parallel	
0	1	1	0	H	B & C Wired in Parallel	
0	0	1	1	H	C & D Wired in Parallel	
1	1	1	0	H	A, B & C Wired in Parallel	
0	1	1	1	H	B, C & D Wired in Parallel	
1	0	1	0	H	A & C Wired in Parallel	
0	1	0	1	H	B & D Wired in Parallel	
1	1	0	1	H	KA5*	2
1	0	1	1	H	KA5*	1

*: The KA5 must be the last block on either side. If more than one KA5 is required on either side – contact your local Square D sales office.

Push Button and Operator Interface - Type KX 30 mm Square Multifunction Pilot Lights

Single Standard Pilot Light For use in hazardous locations – See page 173.

Description	Voltage and Frequency	Style	These operators include a blank KXN100 Legend Insert			Without Color Cap Type
			With Red Color Cap Type	With Green Color Cap Type	With Other Color Cap Type	
 Type KXPA Single Standard Pilot Light	110-120 V, 50-60 Hz 220-240 V, 50-60 Hz 24-28 Vac-dc	Transformer Transformer Full Voltage	KXPA1R KXPA7R KXPA35R	KXPA1G KXPA7G KXPA35G	KXPA1▲ KXPA7▲ KXPA35▲	KXPA1 KXPA7 KXPA35
	See Table Below For Voltage, Frequency and Assembly Code	Transformer or Flashing Resistor Full Voltage	KXPA*:R KXPA*:R KXPA*:R	KXPA*:G KXPA*:G KXPA*:G	KXPA*:▲ KXPA*:▲ KXPA*:▲	KXPA*: KXPA*: KXPA*:
 Type KXTA Single Push-To-Test Pilot Light	110-120 V, 50-60 Hz 220-240 V, 50-60 Hz 24-28 Vac-dc	Transformer Transformer Full Voltage	KXTA1RH1 KXTA7RH1 KXTA35RH1	KXTA1GH1 KXTA7GH1 KXTA35GH1	KXTA1▲ KXTA7▲ KXTA35▲	KXTA1H1 KXTA7H1 KXTA35H1
	See Table Below For Voltage, Frequency and Assembly Code	Transformer or Flashing Resistor Full Voltage	KXTA*:RH1 KXTA*:RH1 KXTA*:RH1	KXTA*:GH1 KXTA*:GH1 KXTA*:GH1	KXTA*:▲ KXTA*:▲ KXTA*:▲	KXTA*:H1 KXTA*:H1 KXTA*:H1
 Type KXTB Single Remote Test Pilot Light	24 Vac 120 Vac	Resistor/ Full Voltage	KXTB35R KXTB38R	KXTB35G KXTB38G	KXTB35▲ KXTB38▲	KXTB35 KXTB38
	Choose Resistor or Full Voltage Required from Table Below. ◆		KXTB*:R	KXTB*:G	KXTB*:▲	KXTB*:

* Add voltage assembly code. ◆ Remote test AC only. Use only full voltage or resistor assembly code. Do not use transformer. ▲ Add color code.

Single Lamp Light Module Codes



Voltage	Description	For Use with Single Lamp ILL. Operators As Indicated	Assembly Code*	Separate Light Module Type No.	Rated VA (Watts)	Replacement Lamps	
						Lamp Number (ANSI)	Lamp Part Number
6 Vac-dc	Full Voltage	All	31	KM31	0.9	755	2550101020
12-14 Vac-dc	Full Voltage	All	32	KM32	1.2	756	2550101037
18 Vac-dc	Resistor	All	33	KM33	1.4	756	2550101037
24-28 Vac-dc	Full Voltage	All	35	KM35	1.2	757	2550101002
32 Vac-dc	Resistor	All	23	KM23	2.5	757	2550101002
48 Vac-dc	Full Voltage	All	36	KM36	2.6	SYL48MB	2550101025
60 Vac-dc	Full Voltage	All	37	KM37	2.6	SYL60MB	2550101026
110-120 V, 25-30 Hz	Transformer	All Except KXTB	2	KM2	2.2	1490	2550101003
110-120 V, 50-60 Hz	Transformer	All Except KXTB	1	KM1	3.9	755	2550101020
110-120 V, 50-60 Hz	Flashing	All Except KXTB	F1	KMF1	3.9	267	2550101036
120 Vac-dc	Resistor	All	38	KM38	3.0	SYL120MB	2550101027
120 Vac-dc	Full Voltage	All	38	KM38	3.0	SYL120MB	2550101027
208-220 V 50-60 Hz	Transformer	All Except KXTB	3	KM3	7.1	755	2550101020
220-240 V 25-30 Hz	Transformer	All Except KXTB	4	KM4	2.2	1490	2550101003
220-240 V 50-60 Hz	Transformer	All Except KXTB	7	KM7	7.7	755	2550101020
220-240 V 50-60 Hz	Flashing	All Except KXTB	F7	KMF7	7.7	267	2550101036
240 Vac-dc	Resistor	All	25	KM25	5.5	SYL120MB	2550101027
277 V, 50-60 Hz	Transformer	All Except KXTB	8	KM8	4.3	755	2550101020
380-480 V, 50-60 Hz	Transformer	All Except KXTB	5	KM5	4.8	755	2550101020
550-600 V, 50-60 Hz	Transformer	All Except KXTB	6	KM6	6.0	755	2550101020

No neon light modules available.

Basic Operators (Without Light Modules, Color Caps, or Legend Inserts)

Description	Type
Single Standard Pilot Light	KXPA
Single Push-to-Test Pilot Light	KXRA
Dual Standard Pilot Light	KXPB
Dual Push-to-Test Pilot Light	KXRL
Four Field Pilot Light	KXPC

Button Covers

For Use On	Color	Type Number	▲Code
 KXPA Includes KXN100	Red	KXAR8	R
	Green	KXAG8	G
	Amber	KXAA8	A
	Blue	KXAL8	L
 KXTA-KXTB Includes KXN100	Red	KXAR1	R
	Green	KXAG1	G
	Amber	KXAA1	A
	Blue	KXAL1	L
	White	KXAW1	W

Typical Push to Test Pilot Light Wiring Diagram

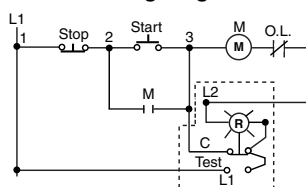

Typical Remote Test Pilot Light Wiring Diagram

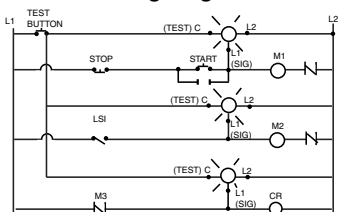

Completely Assembled Operators	Page 162
Legend Inserts	Page 170
Boots	Page 171
Lamp and Lens Removal Kit	Page 171
Dimensions	Page 176
Application Data	Page 175

Push Button and Operator Interface - Type KX 30 mm

Legends

For Push Buttons or Pilot Lights

Used On	KXRA, KXRB, KXRN, KXRP, KXPA, KXPC, KXTA, KXTB, KXTE	KXRC, KXRD, KXRE, KXRF	KXPB, KXTD ◆	KXRG, KXRH, KXRJ, KXRK, KXRL, KXRM, KXTC	KXRG, KXRH, KXRJ, KXRK, KXRL, KXRM, KXTC	KXRL, KXRM, KXTC ※
Marking						
Blank	KXN100	KXN200	KXN200	KXN300	KXN400	KXN500
Start	KXN101	KXN201	KXN201V	KXN301	KXN401	KXN501
Stop	KXN102	KXN202	KXN202V	KXN302	KXN402	KXN502
On	KXN103	KXN203	KXN203V	KXN303	KXN403	KXN503
Off	KXN104	KXN204	KXN204V	KXN304	KXN404	KXN504
Emerg. Stop	KXN105	KXN205	KXN205V	KXN305	KXN405	KXN505
Forward	KXN106	KXN206	KXN206V	KXN306	KXN406	KXN506
Reverse	KXN107	KXN207	KXN207V	KXN307	KXN407	KXN507
Close	KXN108	KXN208	KXN208V	KXN308	KXN408	KXN508
Open	KXN109	KXN209	KXN209V	KXN309	KXN409	KXN509
Down	KXN110	KXN210	KXN210V	KXN310	KXN410	KXN510
Up	KXN111	KXN211	KXN211V	KXN311	KXN411	KXN511
Jog	KXN118	KXN218	KXN218V	KXN318	KXN418	KXN518
Reset	KXN123	KXN223	KXN223V	KXN323	KXN423	KXN523
Run	KXN124	KXN224	KXN224V	KXN324	KXN424	KXN524
Cycle Start	KXN132	KXN232	KXN232V	KXN332	KXN432	KXN532
Motor Run	KXN136	KXN236	KXN236V	KXN336	KXN436	KXN536
Power On	KXN138	KXN238	KXN238V	KXN338	KXN438	KXN538
Special-Marking	KXN199	KXN299	KXN299V	KXN399	KXN499	KXN599

※ These legend inserts are for the pilot lights in the center of the operator.
 ▲ These legend inserts are for the push button portion of the operator.
 ◆ These Legend Inserts have Vertical Printing.

For Selector Switches

Used On	KXSA, KXSB, KXSC, KXSD, KXSE, KXSF, KXSG, KXSH, KXSJ, KXSK, KXSL, KXSM, KXSN, KXSO, KXSP, KXSQ	KXSR, KXSS, KXST, KXSV, KXSW, KXSX, KXSY, KXSZ
Marking		
Blank	KXN600	KXN700
For.-Rev.	KXN639	KXN739
Hand-Auto	KXN640	KXN740
Man-Auto	KXN643	KXN743
Off-On	KXN644	KXN744
On-Off	KXN645	KXN745
Open-Close	KXN646	KXN746
Start-Stop	KXN651	KXN751
Auto-Off-Hand	KXN658	KXN758
Hand-Off-Auto	KXN660	KXN760
Man-Off-Auto	KXN662	KXN762
Spcl. Marking	KXN699	KXN799

Dual Dimensions: **INCHES**
Millimeters

KXRA, KXRB, KXRN, KXRP, KXPA, KXPC, KXTA, KXTB, KXTE	KXRC, KXRD, KXRE, KXRF	KXRG, KXRH, KXRJ, KXRK	KXRL, KXRM, KXTC	KXPB, KXTD								

KXS

170

Letter Height For Standard Legends

KXN100 KXN200 KXN300 KXN400 KXN500 KXN600 KXN700	1/4" Inch (6 mm) 3/16" Inch (4.75 mm) 3/16" Inch (4.75 mm) 3/16" Inch (4.75 mm) 1/8" Inch (3 mm) 1/8" Inch (3 mm)
--	--

Maximum Number of Lines and Characters for Type KXN Legend Inserts

Letter Height	Number of	KXN199	KXN299 Horizontal	KXN299 Vertical	KXN399	KXN499	KXN599
1/4" (6 mm)	Characters Per Line	7	7	3	7	7	3
	Lines Per Legend Insert	4	2	4	1	1	1
3/16" (4.75 mm)	Characters Per Line	9	9	4	9	9	4
	Lines Per Legend Insert	5	2	6	2	1	2
1/8" (3 mm)	Characters Per Line	14	14	5	14	14	6
	Lines Per Legend Insert	8	4	9	3	2	3

Maximum Number of Lines and Characters for Type KXN699 and KXN799 Legend Plates

Position	Letter Height	Characters Per Marking Area	
		A and C	B
	3/16" (4.75 mm)	6	6
	1/8" (3 mm)	8	9
	3/16" (4.75 mm)	10	5
	1/8" (3 mm)	13	7

All Type KX push buttons and pilot lights have a blank insert as standard. These blank inserts can be custom marked using a marking pen, a mechanical lettering set, press letters, or a tape lettering machine that marks a tape which can then be transferred to the blank insert.

To have legend inserts installed into the operators, order the operator as normal and then tell where to install the legend inserts using the numbered positions shown on the operator ordered.

Example: 9001KXRL1GRGRH2 with a
 9001KXN 401 in pos. 1
 9001KXN 503 in pos. 2
 9001KXN 504 in pos. 3
 9001KXN 402 in pos. 4

Push Button and Operator Interface - Type KX 30 mm Accessories

Lockout for Push Buttons

 Holds button in depressed position	Used On	Type No.
	KXRA-KXRC KXRD-KXRE KXRF-KXRG KXRJ-KXRK KXRL-KXRM KXRH-KXRB	KXAK4

Closing Plate

 UL Types 4, 13/NEMA types 4, 13 Square Closing Plate (Chrome Plated) Same size as KX Bezel	Type No.
	KXAK52

Boot for Push Buttons and Pilot Lights

 Transparent boot used to exclude harmful Contaminants	Used On	Type No.
	All KX Push Buttons and Pilot Lights	KXAKU7

Boot For Selector Switches

Description	Used On	Knob Color	Type No.
 Transparent boot with knob used on selector switches to exclude harmful contaminants.	All KX selector switches and potentiometer operators (except key op.)	Black Red Green	KXAKU17B KXAKU17R KXAKU17G

Potentiometer (With Dial Plate) ^① [⚡] ▼

Suffix:*	Ohms	Suffix:*	Ohms	Suffix:*	Ohms	Suffix:♦	Ohms	
							Front	Rear
01	50							
02	100	07	5000					
38	200	08	10 K	12	250 K	82	1000	1000
03	250	40	15 K	13	500 K	83	5000	5000
04	500	09	25 K	37	750 K	85	10 K	10 K
05	1000	35	35 K	14	1.1 Meg	88	50 K	50 K
32	1500	10	50 K	15	2.2 Meg	88	100 K	100 K
39	2000	36	75 K	16	5.0 Meg	89		
06	3200							
33	3500	11	100 K					

^① Dial Plate only – Order Class 9001 Type KXN905.
[⚡] Uses same potentiometer as Class 9001 Type K and SK.
 ▼ Potentiometer shaft diameter = 1/4" (6 mm), length = 7/8" (22 mm)
 Not UL Listed, CSA Certified, or CE Marked.

Shrouds

 Used to color code the Type KX operators.			
Type	Used On	Color	Type No.
Full Shroud	All Push Buttons and Pilot Lights	Gray Red Green Yellow Black Blue	KXAK41E KXAK41R KXAK41G KXAK41Y KXAK41B KXAK41L
Short Shroud	Any KX Operator	Gray Red Green Yellow Black Blue	KXAK40E KXAK40R KXAK40G KXAK40Y KXAK40B KXAK40L

Basic Operators

Description	Type
2 pos. maintained	KXSAE
2 pos. spring return from right	KXSBE
2 pos. spring return from left	KXSCE
3 pos. maintained	KXSD
3 pos. spring return from right	KXSE
3 pos. spring return from left	KXSF
3 pos. spring return from both sides	KXSG
4 pos. maintained	KXSHH

Liner

Type No.
6508900401

Wrench

Type No.
K95

Used to tighten ring nut on operators.

Lamp and Lens Removal Kit

Type No.
KXALLRT

Used to remove lamp and lens on all illuminated operators and pilot lights.

Screwdriver

Type No.
K69













Used to tighten mounting screws on contact blocks and light modules.

Push Button and Operator Interface - Type KX 30 mm



Contact Blocks - Type K, SK, KX, and T

The Class 9001 Type KA contact blocks have been improved. The most noticeable change is that the terminals are Fingersafe® contact blocks (meeting VDE 0106 Part 100). They also have one screw mounting and captive backed out plus/minus terminal screws. These contact blocks still use the same reliable double break direct acting contacts used since 1965. Because of the wiping action of these contacts, they are suitable for use with programmable controllers. All contact blocks listed below will accept up to 2 #12-#24 solid or stranded wires. Types KA1, KA3, KA31, and KA33 NC contacts are direct opening. 





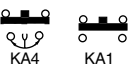

Standard Contact Blocks

Description	Symbol	Type
 (Clear Cover)		KA1
 (Green Cover)		KA2
 (Red Cover)		KA3
 (Clear Cover)	 N.O. Contact Early Closing	KA4
 (Red Cover)	 N.C. Contact Late Opening	KA5
 (Green Cover)	 N.O. Contact Early Closing	KA6

Additional Circuit Arrangements Available

Sequencing*: N.O. Contact of KA4 closes before N.O. Contact on KA1	 KA4 KA1	Order One Type KA4 and One Type KA1
Overlapping*: N.O. Contact of KA4 closes before N.C. Contact of KA5 Opens	 KA4 KA5	Order One Type KA4 and One Type KA5

* For push buttons or two position selector switches (Types K or SKS11, K or SKS12, K or SKS25, K or SKS34, K or SK11J, K or SK12J, K or SK25J and K or SK34J) only. For sequencing or overlapping contacts on other operators — consult local Square D Sales Office.







Symbol	Contact Blocks With Binder Head Screws (not Fingersafe)		Gold Flashed Contacts With Standard Pressure Wire Terminals
	Type	Quantity	Type
	KA21	25-Up*	KA31 
	KA22	25-Up*	KA32
	KA23	25-Up*	KA33 
 N.O. Early Closing	KA24	25-Up*	KA34
 N.C. Contact Late Opening	KA25	25-Up*	KA35

* Minimum order quantity is 25.



Contact Blocks Listed Below Are Not FINGERSAFE® Contact Blocks, But Provide:

- Terminals that accept ring tongue/fork tongue connectors
- Short single circuit contact blocks (0.75" deep vs. 0.97" deep on the FINGERSAFE® Contact Blocks)
- Same as old style Series G product available prior to 3/89.
- Use form Y238 (add to catalog # as suffix)



Symbol	Type	Symbol	Type
	KA1G	 N.O. Contact Early Closing	KA4G
	KA2G	 N.C. Contact Late Opening	KA5G
	KA3G	 N.O. Contact Early Closing	KA6G

Contact Blocks Listed Below Are Not FINGERSAFE® Contact Blocks, But Have "Quick Connect" Terminals.

Symbol	Type
	KA12
	KA13

Maximum Current Ratings For Control Circuit Contacts – Types KA1-KA6, KA21-25, KA31-35, KA1G-KA6G

Volts	DC					Continuous Carrying Amperes
	Inductive and Resistive (NEMA / UL Type P600)					
	Make and Break					
	KA1	KA2 KA3	KA4	KA5 KA6		
125	1.1	1.1	1.1	1.1	10	
250	0.55	0.55	0.55	10	
600	0.2	0.2	0.2	10	

Volts	AC					
	Inductive (NEMA / UL Type A600) 35% Power Factor					Resistive 75% Power Factor Make, Break and Continuous Amperes
	Make		Break		Continuous Carrying Amperes	
Amperes	VA	Amperes	VA			
120	60	7200	6.0	720	10	10
240	30	7200	3.0	720	10	10
480	15	7200	1.5	720	10	10
600	12	7200	1.2	720	10	10



File E42259
CCN NKCR



File LR 25490
Class 3211 03





Marking

Dimensions..... Page 176

Push Button and Operator Interface - Type KX 30 mm Reed Contact Blocks & Hazardous Location Information - Type K, SK, KX, and T

In hazardous locations, it is not always required to use explosion-proof equipment like the Class 9001 Type BR control stations. It can save money to know what type of hazardous location exists. If you're not sure what type of hazardous location exists, the "Summary of Classification" Chart may help. If not, contact your local electrical inspector. When you know what class, division, and group(s) exists, see the table in the lower left hand corner of this page for what Square D has to offer.

Summary Of Classification Chart

Class	Division	Group
I. Gas 	1. Hazard May Exist May Exist In Atmosphere Under Normal Operating Conditions.	A. Acetylene
		B. Hydrogen and Manufactured Gases containing Hydrogen
		C. Petrochemicals (e.g. ethylene)
		D. Petrochemicals (e.g. alcohol)
	2. Potential Hazard A. May be present in atmosphere only under abnormal circumstances. B. Location adjacent to Division 1 location.	A. Acetylene
		B. Hydrogen and Manufactured Gases Containing Hydrogen
		C. Petrochemicals (e.g. ethylene)
		D. Petrochemicals (e.g. alcohol)
II. Dust 	1. Hazard May Exist May Exist In Atmosphere Under Normal Operating Conditions.	E. Conductive and Combustible Dust (Resistivity <math><10^5</math> ohms/cm)
		F. Carbonaceous Dusts (Resistivity >math>>10^2</math> ohm/cm but <math><10^8</math> ohm/cm)
		G. Non-Conductive Combustible Dust (Resistivity >math>>= 10^5</math> ohms/cm)
III. Fibers 	1. Production Areas	Easily Ignitable Fibers or Flyings
	2. Handling and Storage Areas	Easily Ignitable Fibers or Flyings

For			Use
Class	Division	Group(s)	
I	1	A	1. Intrinsically Safe System*:
I	1	B, C, D	1. 9001 BR station 2. Intrinsically Safe System*:
I	2	A	1. 9001 K, SK, KX control stations with the restrictions listed in footnote◆ 2. Intrinsically Safe System*:
I	2	B, C, D	1. 9001 BR station 2. 9001 K, SK, KX control stations with the restrictions listed in footnote◆ 3. Intrinsically Safe System*:
II	1	E, F, G	1. 9001 BR station 2. Intrinsically Safe System*:
II	2	E, F	1. 9001 BR station 2. 9001 K, SK, KX control stations with the restrictions listed in footnote◆ 3. Intrinsically Safe System*:
II	2	G	1. 9001 BR station 2. 9001 K, SK, KX control stations with the restrictions listed in footnote▲ 3. Intrinsically Safe System*:
III	1, 2	1. 9001 BR Station 2. 9001 K, SK, KX control stations with the restrictions listed in footnote▲ 3. Intrinsically Safe System*:

*: An intrinsically safe system requires either a Class 8501 Type TO or NY2 barrier relay or an intrinsically safe barrier to restrict the energy available in the area classified as a hazardous area to a level less than that required to cause an explosion. In an intrinsically safe system, any **non-illuminated** Class 9001 operator or control station with standard contacts can be used. No illuminated operators, except the Class 9001 Type KP44 intrinsically safe pilot light, may be used.

◆ Any Class 9001 Type K, SK or KX operator can be used in an area classified as Class I, Division 2 hazardous locations.

- Only logic (KA40 series) or power (KA50 series) reed contact blocks are used.
- All Type K and SK illuminated operators are UL approved for use in Class I Division 2 areas. ■
- Type KX illuminated operators do not use 4 lamp light modules, or 2 lamp light modules other than the transformer type. ■
- The operators are mounted in Type KY, KYSS, KYAF, SKY enclosures.

▲ Any Class 9001 Type K, SK, or KX operator mounted in a Class 9001 Type KY, KYSS, KYAF, SKY enclosure may be used, except potentiometer operators.







For ◆ and ▲: UL Listed: File E10054, CCN NOIV.

For ■: Add Form Y243 to single lamp Push To Test pilot lights.

All contact blocks listed below will accept #12-18 solid or stranded wire.

Hermetically Sealed Logic Reed Contact Blocks







Suitable for use on low energy level circuits

Description	Symbol	Type
		KA41
		KA42
		KA43
		KA44
		KA45
Max. Volts AC/DC	Maximum Load	
32/30 120/100	Res. 0.25A 8 VA	Ind. Cont. 0.10A 3 VA 0.5 A 0.5 A

The maximum number of logic and/or power reed contact blocks per operator is as indicated for standard contact blocks, **except**:

- On 3 position selector switches with cams "C," "D," "E," "F," "G," "L," or "M," mount reed blocks on **one side only** (either side), maximum 2 in tandem.
- On 4 position selector switches, mount reed blocks on **one side only** (either side), maximum 2 in tandem.

Hermetically Sealed Power Reed Contact Blocks

Description	Symbol	Type			
		KA51			
		KA52			
		KA53			
		KA54			
		KA55			
Volts	AC NEMA / UL Type C300①				Continuous Carrying Amps
	Make		Break		
	Amps	VA	Amps	VA	
120	10.00	1200	1.000	120	3.0
240	5.00	1200	0.500	120	3.0
Volts	DC NEMA / UL Type Q150				Continuous Carrying Amps
	Make		Break		
	Amps	VA	Amps	VA	
115	0.50	58	0.50	58	3.0

The power reed contact blocks can be used with standard industrial relays and starters through NEMA Size 4. Minimum voltage is 5 volts and the minimum current is 1 mA.

① Inductive Rating - 35% Power Factor. ② Inductive and Resistive Ratings

Push Button and Operator Interface - Type KX 30 mm

Application Data, Materials

The Type KX operators are UL and CSA Listed as follows:



File E42259
CCN NKCR



File Class 25490C
3211 03

The KX operators are rated UL Types 1, 2, 3, 3R, 4, 4X, 6, 12, 13/ NEMA Types 1, 2, 3, 3R, 4X, 6, 12, 13 without the use of protective boots. Boots are recommended for dirty environments or areas that are hosed down with water under very high pressure.

Maximum Number of Contact Blocks Per Operator

Mom. Push Button — Three mounted in tandem for a total of six.	Maint. Push Button — Two mounted in tandem for a total of four.	Selector Switch — Two mounted in tandem for a total of four.
--	---	--

Operator Service Temperature Range:

-22 °F to +140 °F at 50% relative humidity
-30 °C to +60 °C

Mounting Hole For Type KX Control Units

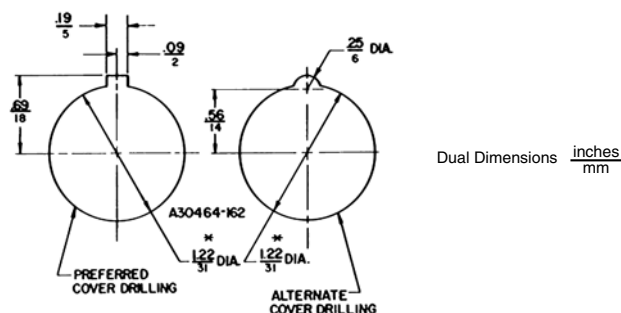

Use Greenlee Tool #60242 for punching mounting hole and notch.

Selector Switch Angular Travel

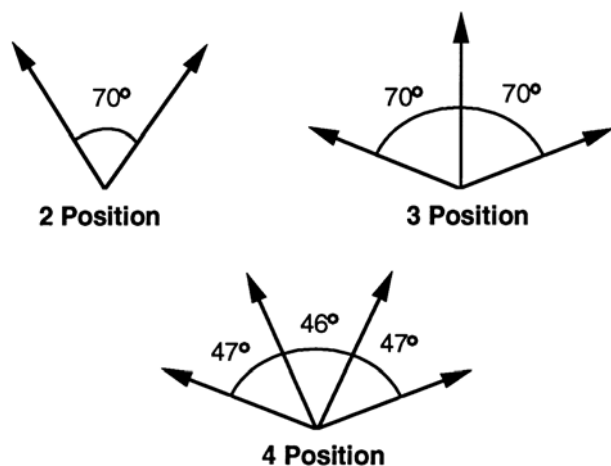

Type KX Operator Materials

Single Push Button

(KXRA, KXRB, KXRN, KXRP, KXTA)

Gasket – Nitrile
Locking Head – ZAMAC #3
Screws – Steel
Terminals – Steel
Button – Polycarbonate
Seal – Nitrile
Seal Retainer – Steel
Bezel – Zinc
Stem – Polycarbonate
Stem Cover – Polycarbonate
Legend Insert – Polyester
Return-Spring – Music Wire
Ring Nut – Zinc or Aluminum
Adaptor – Zinc
Adaptor Mounting Clip – Music Wire
Liner – Nylon

Dual Push Button

(Non-Illuminated and Illuminated)

(KXRC, KXRD, KXRE, KXRF, KXRG, KXRH, KXRJ, KXRK, KXRL, KXRM, KXTC)

Gasket – Nitrile
Seal – Nitrile
Seal Retainer – Brass
Bezel – Zinc
Button Stem – Stainless Steel
Button – Polycarbonate
Button Cover – Polycarbonate
Legend Insert – Polyester
Lamp Cover – Polycarbonate
Lens Retainer – Polycarbonate
Lens – Polycarbonate
Return-Spring – Music Wire
Ring Nut – Zinc or Aluminum
Adaptor – Zinc
Adaptor Mounting Clip – Music Wire
Liner – Nylon
Retainer Ring – Steel
Interlock Pad – Polyester
Interlock – Sintered Steel
Interlock – Nylon (KXRD)
Pin – Steel (KXRE, KXRF)
Detent Bearing – Steel (KXRE, KXRF)
Detent Spring – Music Wire (KXRE, KXRF)
Interlock – Steel (KXRM)
Baffle – Steel
Locking Head – ZAMAC #3
Screws – Steel
Stem – Polycarbonate
Stem Cover – Polycarbonate
Terminals – Steel

Selector Switch

(Non-Illuminated and Illuminated)

(KXS)

Gasket – Nitrile
Seal – Nitrile
Seal Retainer – Steel
Return Spring – Music Wire
Cam Rotor – Celenex 3300
Cam Follower – Delrin 100
Cam Carrier – Trogamid
Cam Profile – Delrin 100
Bearing – Polyester
Bezel – Zinc
Knob – Polycarbonate or Nylon
Knob Ring Nut – Polycarbonate
Knob Seal – Nitrile
Legend Plate – ABS
Plug Insert – Polyester
Key Plug – Zinc, Brass, Music Wire
Key – Brass
Locking Head – Zinc
Locking Head Seal – Nitrile
Insert – Zinc
Adaptor – Zinc
Adaptor Mounting Clip – Music Wire
Liner – Nylon
Ring Nut – Zinc or Aluminum
Terminals – Steel
Screws – Steel

Contact Block Type (KA)

Housing – Amorphous Nylon
Contact Slider – Nylon or Acetal
Terminal – Steel
Saddle Clamp – Steel
Spring – Steel
Contacts – Silver and Copper
Blade – Beryllium Copper
Label – Paper

Shrouds – Delrin 507

Lockout – 410 Stainless Steel

Closing Plate – ZAMAC #3

Boots – Neoprene

Potentiometer (KXBA, KXBB, KXBC, KXBD):

Pot – Clarostat Types J and EJ
Operator – ZAMAC #3
Legend Plate – ABS
Knob – Polycarbonate
Printed circuit board – Phenolic
Cam Rotor – Polyester
Cam – Acetal
Cam Carrier – Nylon
Adaptor – ZAMAC #3
Adaptor Spring – Square Music Wire
Spacer – Fiber Board
Gasket – Buna N
Terminal – Brass
Screws – Steel
Bezel – Zinc
Locking Head – ZAMAC #3

Legend Inserts (KXN100, KXN200, KXN300, KXN400, KXN500) – 0.005 Thk. Matte Polyester

Legend Plates (KXN-600, KXN-700) – ABS

Pilot Light

(KXPA, KXPB, KXPC, KXTE)

O-Ring – Nitrile
Bezel – Zinc
Button – Polycarbonate
Button Cover – Polycarbonate
Button Stem – Polycarbonate
Screws – Steel
Terminals – Steel
Lens Assembly – Polycarbonate
Baffle – Steel
Ring Nut – Zinc or Aluminum
Adaptor – Zinc
Adaptor Mounting Clip – Music Wire

Light Module

(Single Lamp KM)

Housing – Thermoplastic Polyester
Socket – Steel
Terminal – Steel with Tin Plate
Saddle Clamp – Steel
Translating Pin – Polycarbonate
Transformer – Thermoplastic Polyester, Steel, Copper, Polyvinyl Chloride, Polytetrafluoroethylene, Acetate, Paper
Lamp Spring – Tin Plated Music Wire

Light Module

(2 Lamp KXAKM2)

Adaptor Screw – Steel
Housing – Thermoplastic Polyester
Lamp Terminal – Copper
Terminal – Steel
Saddle Clamp – Steel
Contact Spring – Copper
Translating Pin – Polycarbonate
Transformer – Thermoplastic Polyester, Steel, Copper, Polyvinyl Chloride, Polytetrafluoroethylene, Acetate, Paper

Light Module

(4 Lamp KXAKM4)

Housing – Thermoplastic Polyester
Lamp Terminal – Copper
Adaptor Screw – Steel
Terminal – Steel
Saddle Clamp – Steel
Transformer – Nylon, Steel, Copper, Polyvinyl Chloride, Polytetrafluoroethylene, Acetate, Paper

Push Button and Operator Interface - Type KX 30 mm Dimensions

Approximate Dimensions – Consult your local Square D Sales Office for latest version of dimension drawings.

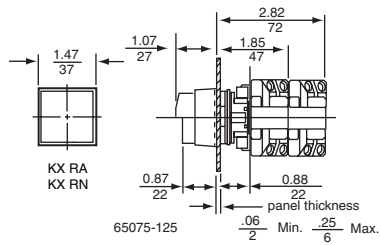

Single Push Button Operator Non-Illuminated

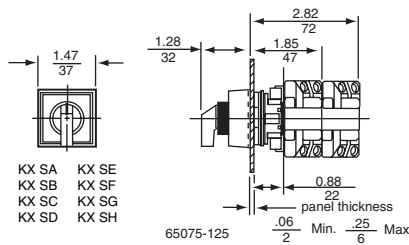

Selector Switch Operator Non-Illuminated

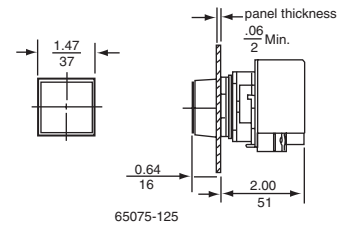

Single Pilot Light

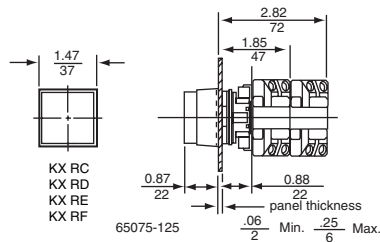

Dual Push Button Operator Non-Illuminated

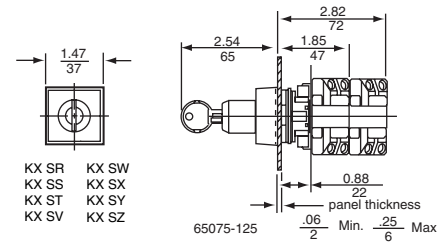

Key Operator Selector Switch

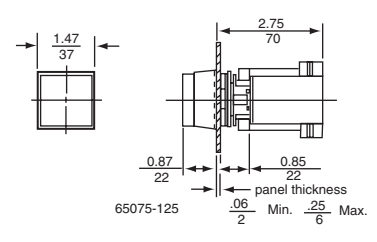

Dual Lamp Pilot Light

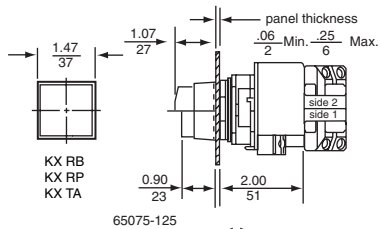

Single Push Button Operator Illuminated

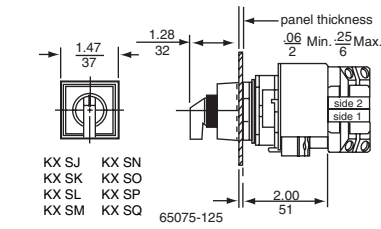

Selector Switch Operator Illuminated

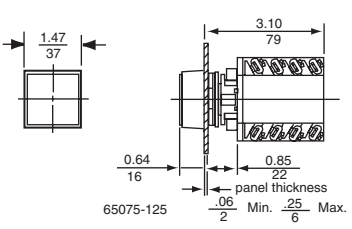

Four Lamp Pilot Light

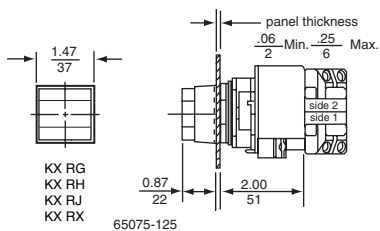

Dual Push Button Operator Illuminated

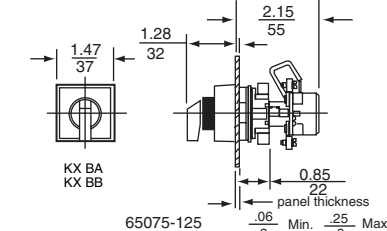

Single Pot Potentiometer Operator

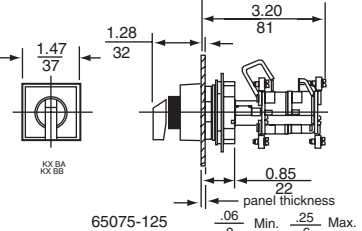

Double Pot Potentiometer Operator

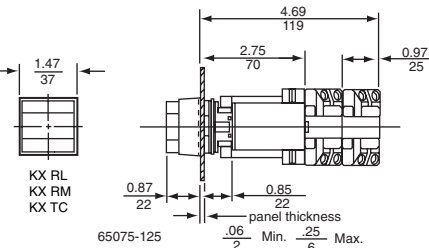

Dual Lamp Push Button Operator

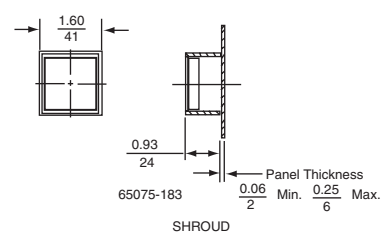

Shroud

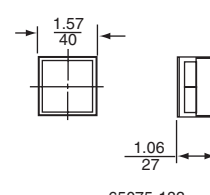

Boot

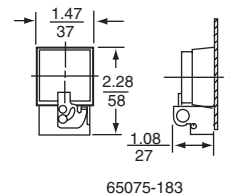

Lockout

Minimum Centerline Spacings For Type KX
2 1/4" Vertically
1 5/8" Horizontally

Dual Dimensions $\frac{\text{inches}}{\text{mm}}$

Push Buttons and Operator Interface Specifier's Guide

Type B and 30 mm Control Stations

Catalog
2005

File 9001



CONTENTS

Description	Page
Type B Standard Duty Control Stations	178
Type B Standard Duty Control Stations Accessories and Legends	179
Type B Standard Duty Control Stations Replacement Parts	180
Type B Standard Duty Control Stations Dimensions	181
Type K, SK, and KX Industrial Duty Enclosures	182
Type K and Sk Control Stations	183
Type K, SK, KX, and T Flush Plates	185
Type K and SK Enclosure Dimensions	186
Type KY and KZC Security Control Stations	190
Type K, SK, KX, and T Contact Blocks	191
Hazardous Location Information	192
Declaration of Conformity	224



Push Button and Operator Interface - Type B and 30 mm Control Stations

Type B Standard Duty Control Stations

Standard duty control stations are designed for use with magnetic motor starters to govern the starting, stopping, or reversing of all types of electric motors. Push buttons are momentary contact unless otherwise indicated. Selector switches are maintained contact.



NEMA Type 1
Surface Mounting
Type BG201



NEMA Type 1
Flush Mounting
(w/o pullbox)
Type BF201





NEMA Type 4
Type BW243



NEMA Types 7-9
Type BR103

Control Stations

Many items are stock or can be furnished as a quick ship using a "Universal" station plus accessories.

No. of Units	Nameplate Markings and Features	Contact Symbol See page 181	Surface Mounting NEMA Type 1*	Stainless Steel Flush Plate (Pullbox not included)*	Watertight and Dusttight NEMA Type 4*	For Hazardous Locations Class I, Div. I & II Groups B, C and D Class II Div. I & II Groups E, F and G NEMA Types 7 & 9*
			Type	Type	Type	Type
1	Start	1	BG101	BF101	BW146	BR101
	Stop	3	BG102	BF102	BW147
	Stop (Mushroom Button)	3	BG103	BW151	BR103
	Stop (Lockout)	3	BG104	BW148	BR104
	Universal (w/o Legend Inserts) ▲	16	BG107	BF107	BW159	BR107
	Off-on (Selector Switch)	19	BG111	BF111
2	Hand-Off-Auto (Selector Switch)	17	BG112	BF112
	Universal Selector Switch (w/o Legend Insert) ▲	19 or 17	BG114	BF114
	Red Pilot Light: 120 Vac or dc	121	BG121	BF121
	Green Pilot Light: 120 Vac or dc	121	BG122	BF122
	Pilot Light (w/o Lens): 120 Vac or dc ▲	121	BG123	BF123
	Start-Stop	145	BG201	BF201	BW240	BR204
Start-Stop (Mushroom on Stop)	146	BG202	BF202	BW252	BR202	
Start-Stop (Mushroom on Start)	145	BG203	BW250	BR203	
Start-Stop (Lockout on Stop)	145	BG204	BW241	BR204	
Start-Stop (Mushroom on Start and Stop)	145	BG205	BW246	BR205	
Forward-Reverse	146	BG206	BF206	BW242	BR206	
Open-Close	146	BG207	BF207	BW244	BR207	
Up-Down	146	BG208	BF208	BW243	BR208	
Raise-Lower	146	BG209	BF209	BW253	BR209	
On-Off	145	BG210	BF210	BW245	BR210	
On-Off (Maintained Contact)	146	BG211	BF211	BW254	BR211	
Universal (w/o Legend Inserts) ▲	25	BG214	BF214	BW260	BR214	
Start-Stop (Maintained Contact)	10	BG215	BF215	BW255	BR215	
On-Off (Maintained Contact)	10	BG216	BF216	BW256	BR216	
Hand-Auto (Maintained Contact)	10	BG217	BF217	BW257	BR217	
Start-Stop (Red Mushroom on Stop, Both Buttons Maintained)	10	BR219	
Universal (Maintained Contact w/o Legend Inserts) ▲	10	BG218	BF218	BW258	BR218	
Off-On (Selector Switch), Red P.L.: 120 Vac or dc	19 & 121	BG221	BF221	▲ "Universal" designates control stations without legend inserts, lenses or accessory kits. Universal stations plus separate legend inserts and other accessories listed on page 179 allow the user to conveniently build up standard or custom stations. ● Use standard 2.0 or 2.13 inch deep wall boxes, single gang for Types BF1 – and BF2 – and two gang for Type BF3 –. * For replacement interiors, see page 180. Replacement enclosures (case and/or cover) are not available for Type BF devices. Lockout must be factory installed on NEMA Type 4 devices. However, replacement covers are available with the lockout feature as standard. See page 179.	 File E42259 CCN NKCR  Marking  File LR 25490 Class 3211 03	
Hand-Off-Auto (Selector Switch), Red P.L.: 120 Vac or dc	17 & 121	BG223	BF223			
Universal Selector Switch & Pilot Light 120 Vac or dc (w/o Legend Insert & w/o Lens) ▲	17 or 19 & 121	BG224	BF224			
Hand-Off-Auto (Selector Switch) & Start (Push Button)	17 & 1	BG225	BF225			
Universal Selector Switch & Push Button (w/o Legend Inserts) ▲	17 or 19 & 16	BG226	BF226			
Fast-Slow-Stop	109	BG301	BF301			
Forward-Reverse-Stop	109	BG302	BF302			
Open-Close-Stop	109	BG303	BF303			
Raise-Lower-Stop	109	BG304	BF304			
Up-Down-Stop	109	BG305	BF305			
High-Low-Stop	109	BG306	BF306			
Start-Jog-Stop	109	BG316			
Forward-Reverse-Stop (Lockout on Stop)	109	BG322			
Up-Down-Stop (Lockout on Stop)	109	BG325			
High-Low-Stop (Lockout on Stop)	109	BG326			
Universal (w/o Legend Inserts) ▲	8	BG307	BF307			
3	Start-Stop, Red Pilot Light: 120 Vac or dc	145 & 121	BG308	BF308		
	Universal Push Buttons (2) & Pilot Light: 120 Vac or DC (w/o Legend Inserts & w/o Lens) ▲	25 & 121	BG309	BF309		
	Start-Stop (Maintained Contacts) & Red Pilot Light: 120 Vac or dc	10 & 121	BG310	BF310		
	On-Off (Maintained Contact) & Red Pilot Light: 120 Vac or dc	10 & 121	BG311	BF311		
	Hand-Auto (Maintained Contacts), & Red Pilot Light: 120 Vac or dc	10 & 121	BG312	BF312		
	Universal Push Buttons (Maintained Contact) & Pilot Light: 120 Vac or DC (w/o Legend Inserts & w/o Lens) ▲	10 & 121	BG313	BF313		
Hand-Off-Auto (Selector Switch), & Start-Stop (Push Buttons)	17 & 145	BG314	BF314			
Universal Selector Switch & 2 Push Buttons (w/o Legend Inserts) ▲	17 or 19 & 25	BG315	BF315			

Push Button and Operator Interface - Type B and 30 mm Control Stations

Type B Standard Duty Control Stations — Accessories and Legends



Mushroom Caps – Kits do not include legend insert; order separate legend insert from the tables below.

EX: For red mushroom button marked STOP, order one 9001 Type B301 plus one 9001 Type B102.

Color	Type
For NEMA TYPE 1 surface mounting stations	
Red	B301
Black	B302
For NEMA Type 4	
Red	B303



Lockout Kit – For **NEMA Type 1** surface mounting stations, bottom unit only. Can be used on either push button or on 2 or 3 position selector switch. Lockout cannot be used with mushroom cap.

Type
B321

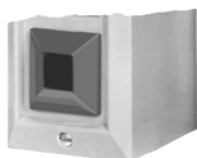

Pilot Light Lenses

Color	For NEMA Type 1 Surface Mounting	For NEMA Type 1 Flush Mounting
	Type	Type
Red	B331	B341
Green	B332	B342

Push Button Legend Inserts

Marking	For NEMA Type 1 Surface Mounting Push Button & Mushroom Caps	For NEMA Type 1 Flush Mounting	For NEMA Type 4 and NEMA Types 7-9 Lever Type Square	For NEMA Type 4 Button Type Round	Mushroom Button Inserts For NEMA Type 4
	Type	Type	Type	Type	Type
Start	B101	B131	B161	B259	B282
Stop	B102	B132	B162	B260	B283
Fast	B103	B133	B163
Slow	B104	B134	B164
Forward	B105	B135	B165	B255	B278
Reverse	B106	B136	B166	B256	B279
Open	B107	B137	B167	B263	B286
Close	B108	B138	B168	B264	B287
Raise	B109	B139	B169	B261	B284
Lower	B110	B140	B170	B262	B285
Up	B111	B141	B171	B253	B276
Down	B112	B142	B172	B254	B277
High	B113	B143	B173
Low	B114	B144	B174
On	B115	B145	B175	B257	B280
Off	B116	B146	B176	B258	B281
Hand	B117	B147	B177	B265	B288
Auto	B118	B148	B178	B266	B289
Jog	B119	B149	B179
Blank-Black	B129	B159	B189	B251	B251
Blank-Red	B129R	B159R	B189R	B252	B252

Order must specify quantity of 10 or multiples of 10.



Replacement Covers for BF and BW

For Types	Types
BF101-BF123	3040000311
BF201-BF226	3040000302
BF301-BF315	3110104301
BW146-BW147	BWD108
BW148*	BWD109
BW149-BW159	BWD108
BW240	BWD219
BW241*	BWD220
BW242-BW260	BWD219

* Replacement cover has lockout factory installed on cover.

Selector Switch Knob for Types BG & BF Selector Switches

Type
B351

Replacement Lamp

Sylvania Lamp No.	Square D Part No.
120PSB	2550105005

Replacement Lamp Holder

Type
BGC124

Interchangeable Selector Switch Legend Plates

Marking	For NEMA Type 1 Surface Mounting	For NEMA Type 1 Flush Mounting
	Type	Type
Off-On	B201	B231
Hand-Off-Auto	B202	B232
Manual-Auto	B203	B233
Forward-Reverse	B204	B234
Open-Close	B205	B235
Open-Off-Close	B206	B236
Hand-Auto	B207	B237
Forward-Off-Reverse	B208	B238
Summer-Winter	B209	B239
Summer-Off-Winter	B210	B240
Low-Off-High	B211	B241
Up-Off-Down	B212	B242

Order must specify quantity of 10 or multiples of 10.

Legend Insert Kits

(Kit includes one each of standard legend inserts as indicated below, Type No. of kit.)

Where Used:	Type	
For NEMA Type 1 Surface Mounting	Push Buttons	B100 (Incl's 1 each of B101 thru B119)
	Selector Switches	B200 (Incl's 1 each of B201 thru B212)
For NEMA Type 1 Flush Mounting	Push Buttons	B130 (Incl's 1 each of B131 thru B149)
	Selector Switches	B230 (Incl's 1 each of B231 thru B242)
For NEMA Type 4 and NEMA Type 7-9 Lever Type, Square	Push Button	B160 (Incl's 1 each of B161 thru B179)
For NEMA Type 4 Button Type, Round	Push Button	B250 (Incl's 1 each of B253 thru B266)
For NEMA Type 4 Button Type	Mushroom Button	B300 (Incl's 1 each of B276 thru B289)

Push Button and Operator Interface - Type B and 30 mm Control Stations

Type B Standard Duty Control Stations — Replacement Parts



Type BGC214
(Type BGC contact block assemblies include cover.)



Type BGB214

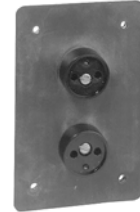

Type BOC361

Replacement Interiors For Type B Standard Duty Push Button Stations

For Control Station Types	Contact Symbol	Contact Block Assembly▲ Type	Terminal Block Wiring Receptacle Type
BF101—BF107	16	BOC107	BFB107
BF111—BF114	19 or 17	BOC114	BFB114
BF121—BF123	121	BOC123	BFB123
BF201—BF214	25	BOC214	BFB214
BF215—BF218	10	BOC218	BFB214
BF221—BF224	7 or 19 & 121	BOC224	BFB224
BF225—BF226	17 or 19 & 16	BOC226	BFB226
BF301—BF307	8	BOC214 & BOC107	BFB214 & BFB107
BF308—BF309	25 & 121	BOC214 & BOC123	BFB214 & BFB123
BF310—BF313	10 & 121	BOC218 & BOC123	BFB214 & BFB123
BF314—BF315	17 or 19 & 25	BOC214 & BOC114	BFB214 & BFB114
BG101—BG107	16	BGC107	BGB107
BG111—BG114	17 or 19	BGC114	BGB114
BG121—BG123	121	BGC123	BGB123
BG201—BG214	25	BGC214	BGB214
BG215—BG218	10	BGC218	BGB214
BG221—BG224	17 or 19 & 121	BGC224	BGB224
BG225—BG226	17 or 19 & 16	BGC226	BGB226
BG301—BG307 BG316—BG326	8	BGC307	BGB307
BG308—BG309	25 & 121	BGC309	BGB309
BG310—BG313	10 & 121	BGC313	BGB309
BG314—BG315	17 or 19 & 25	BGC315	BGB315
BR101—BR107	16	BOC107	BFB107
BR202—BR214	25	BOC214	BFB214
BR215—BR219	10	BOC218	BFB214
BW101—BW107	16	BOC107	BFB107
BW202—BW214	25	BOC214	BFB214
BW215—BW218	10	BOC218	BFB214
BW146—BW159	16	BOC360	
BW240—BW260	25	BOC361	
BW255—BW258	10	BOC362	

Note: Contact block assemblies for all Type BG stations include cover and contact block.
Replacement contact block assemblies and terminal block wiring receptacles for push buttons have provision for 1 N.O. & 1 N.C. circuit on each button. Unneeded circuits need not be wired.
▲ Order separate legend plates, if required, from listing on page 179.

“C” Shaped Mounting Bracket for 9001 BR Interior

3110112001

Electrical Contact Ratings

AC – NEMA / UL Type B600						DC – NEMA / UL Type P600			
Volts	Inductive 35% Power Factor				Resistive 75% Power Factor	Volts	Inductive and Resistive		
	Make		Break				Make and Break Amperes	Continuous Carrying Amperes	
	Amps	VA	Amps	VA					
120	30.5	3600	3.75	360	5	5	120	1.1	5
240	15	3600	1.5	360	5	5	240	0.55	5
480	7.5	3600	0.75	360	5	5	600	0.2	5
600	6	3600	0.6	360	5	5			

Push Button and Operator Interface - Type B and 30 mm Control Stations

Type B Standard Duty Control Stations — Dimensions

Contact Symbols

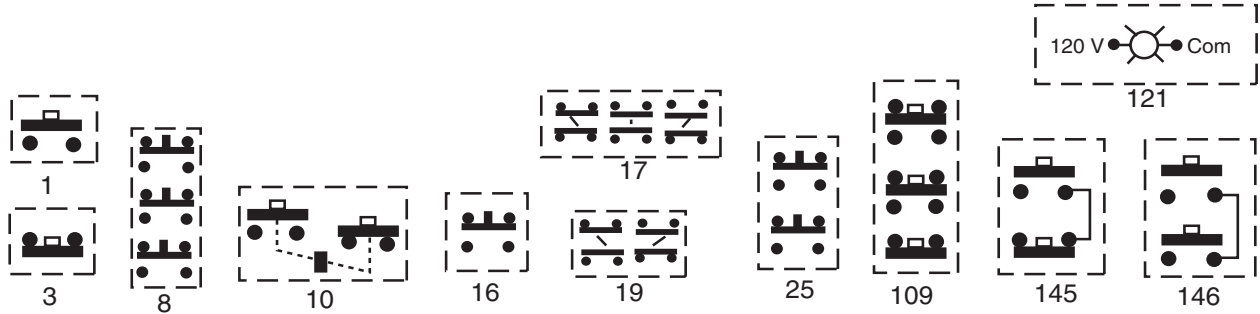

Approximate Dimensions

Surface Mount Type BG

Glass Filled Polyester Cover

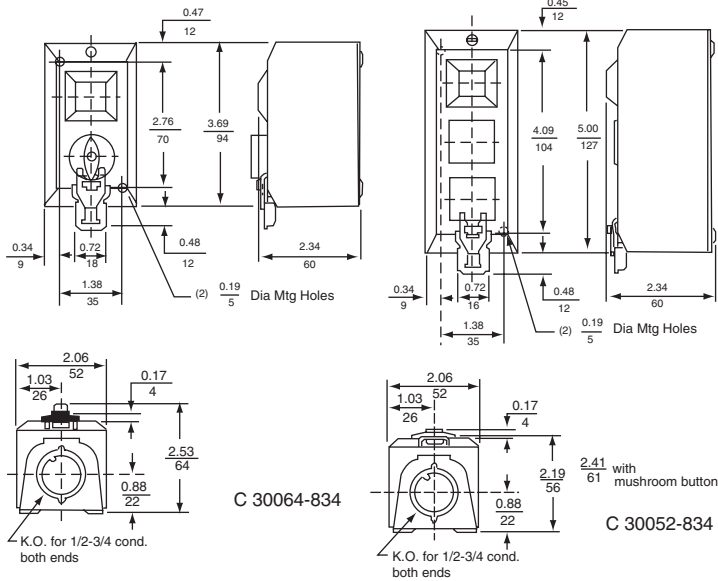

Hazardous Location

Hazardous Location Type BR

Cast Aluminum Enclosure

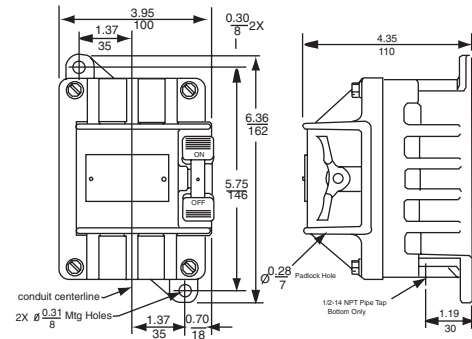

Flush Mount Type BF

Stainless Steel

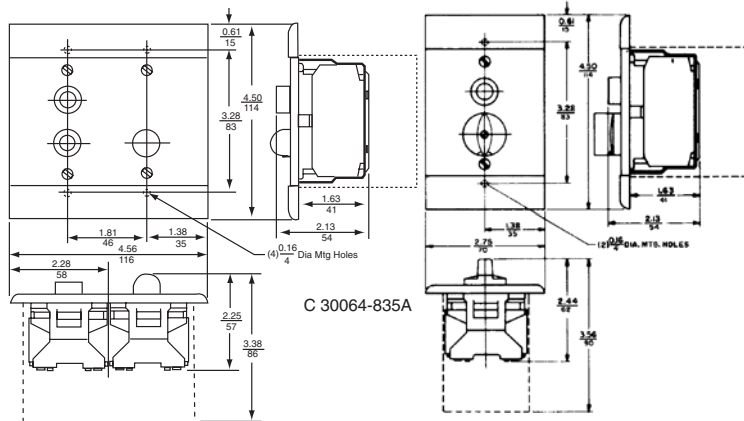

Watertight & Dusttight Type BW

Cast Zinc Enclosure

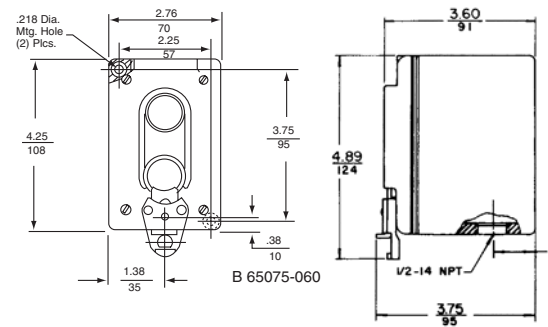

Dual Dimensions $\frac{\text{inches}}{\text{mm}}$

Push Button and Operator Interface - Type B and 30 mm Control Stations

Type K, SK, KX, and T — 30 mm Industrial Duty Enclosures

Enclosures Only (For Customer Assembly)

No. of Units	UL Types 1, 3 and 13/NEMA Types 1, 3 and 13		UL Types 1, 3, 4 and 13 NEMA Types 1, 3, 4 and 13 ①	UL Types 1, 3, 4, 4X and 13 NEMA Types 1, 3, 4, 4X and 13 ①	
	Surface Mounting		Surface Mounting	Surface Mounting	
	Sheet Steel	Flush Mounting without Pullbox ③ ④		Die Cast Aluminum ④	Stainless Steel (304) ⑤
	Type	Type	Type		Type
1	KYAF1	KZ11	KY1	KYSS1	SKY1
2	KYAF2	KZ21②	KY2②	KYSS2	SKY2
3	KYAF3	KZ31②	KY3②	KYSS3	SKY3
4	KYAF4	KZ41②	KY4②	KYSS4	SKY4
6	KYAF6	KZ6	KY6	KYSS6	SKY6
9	KYAF9	KZ9	KY9	KYSS9	SKY9
12	KYAF12	KZ12	KY12	KYSS12	SKY12
16	KYAF16	KZ16	KY16	KYSS16	SKY16
20	KYAF20	Not Avail.	Not Avail.	KYSS20	SKY20
25	KYAF25	Not Avail.	Not Avail.	KYSS25	SKY25
30	KYAF30	Not Avail.	Not Avail.	KYSS30	Not Avail.

- ① Type K Series A through Series G operators were rated NEMA Type 1, 3, 12, and 13. Type K Series H operators are rated UL Types 1, 3, 4, 6, 12 and 13/NEMA Types 1, 3, 4, 6, 12, and 13.
- ② Only KN200 series legend plates will fit upright on these enclosures with their long axis vertical.
- ③ For machine cavity mounting. Pull box not available.
- ④ Type KN1, KN6 and KN7 a series of legend plates will not fit on these enclosures.
- ⑤ Standard Type KYSS enclosures are supplied with Type 304 stainless steel — Use Form Y35 and order by description — contact your local Square D sales office.

Custom Built Control Stations

The catalog numbers shown include the enclosure only. A complete assembled control station is the enclosure plus all control units to be installed. **Orders must be accompanied with a key sheet (M-7687) or sketch showing all control units in their desired locations. Specify the marking on the nameplates for the enclosure.** The standard nameplate size is 1.69" (43 mm) by 0.5" (13 mm) inches. It has a black field with white letters. For nameplates other than our standard, contact your local Square D Sales Office. There is an additional charge to move or add an additional conduit hole or change the diameter of the conduit.

Example: Add a 1 inch conduit to the top (nonstandard location) of a KY6 enclosure and increase the bottom conduit from 3/4" to 1 inch (19 to 25 mm). There would be an additional charge for the top conduit and the bottom conduit. If 20 or more identical stations are ordered at one time, there is no additional charge.

No. of Units	UL Types 1, 3 and 13/NEMA Types 1, 3 and 13		UL Types 1, 3, 4 and 13 NEMA Types 1, 3, 4 and 13 ①	UL Types 1, 3, 4, 4X and 13/NEMA Types 1, 3, 4, 4X and 13 (1)	
	Surface Mounting		Surface Mounting	Surface Mounting	
	Sheet Steel	Flush Mounting without Pullbox ③ ④		Die Cast Aluminum ④	Stainless Steel (304) ⑤
	Type	Type	Type		Type
1	KYAF100	KZ110	KY10	KYSS100	SKY100
2	KYAF200	KZ210②	KY20②	KYSS200	SKY200
3	KYAF300	KZ310②	KY30②	KYSS300	SKY300
4	KYAF400	KZ410②	KY40②	KYSS400	SKY400
6	KYAF600	KZ60	KY60	KYSS600	SKY600
9	KYAF900	KZ90	KY90	KYSS900	SKY900
12	KYAF1200	KZ120	KY120	KYSS1200	SKY1200
16	KYAF1600	KZ160	KY160	KYSS1600	SKY1600
20	KYAF2000	Not Avail.	Not Avail.	KYSS2000	SKY2000
25	KYAF2500	Not Avail.	Not Avail.	KYSS2500	SKY2500
30	KYAF3000	Not Avail.	Not Avail.	KYSS3000	Not Avail.

- ① Type K Series A through Series G operators were rated NEMA Type 1, 3, 12, and 13. Type K Series H operators are rated UL Types 1, 3, 4, 6, 12 and 13/NEMA Types 1, 3, 4, 6, 12, and 13.
- ② Only KN200 series legend plates will fit upright on these enclosures with their long axis vertical.
- ③ For machine cavity mounting. Pull box not available.
- ④ Type KN1, KN6 and KN7 a series of legend plates will not fit on these enclosures.
- ⑤ Standard Type KYSS enclosures are supplied with Type 304 stainless steel — Use Form Y35 and order by description — contact your local Square D sales office.
- ⑥ For a copy of M-7687 keysheet, reference D-Fax™ #1143 or see pages 188-189.

Standard Assembled Control Stations	Pages 183-184
Dimensions	Pages 186-187
Key Sheet for Custom Assembled Control Stations	Pages 188-189

Push Button and Operator Interface - Type B and 30 mm Control Stations Types K and SK — 30 mm Control Stations



Type KY30

Type KZ310

Type KYAF900

Type KYSS300

Type SKY200

Control Stations

Enclosures have sufficient depth to accommodate two contact blocks in tandem (total of four blocks) on non-illuminated operators and two contact blocks side-by-side on illuminated operators.

Assembled Control Stations – UL Types 1, 3, 4 and 13/NEMA Types 1, 3, 4 and 13 ▲ Die Cast Aluminum Enclosures

No of Units	Legend Plate Marking And Features	Type	Consists Of			
			Enclosure	Operators	Contact Blocks	Legend Plates
1	Hand-Off-Auto (Sel. Switch)	KYK111	KY1	KS43B	KA1	KN260
	Hand-Off-Auto (Sel. Switch) (With Sealed Contacts)	KYK121 ◆	KY1	KS43B	KA51	KN260
	Jog-Run (Selector Switch)	KYK18	KY1	KS11B	KA1	KN242
	Off-On (Selector Switch)	KYK110	KY1	KS11B	KA1	KN244
	Off-On (Sel. Sw.) (With Sealed Contacts)	KYK122 ◆	KY1	KS11B	KA51	KN244
	Red 120 Vac Pilot Light	KYK120 ◆	KY1	KP1R31
	Start	KYK11	KY1	KR1B	KA1	KN201
	Start (With Sealed Contacts)	KYK125 ◆	KY1	KR1B	KA51	KN201
	Start (Mushroom Button)	KYK12	KY1	KR4B	KA1	KN201
	Stop	KYK13	KY1	KR1R	KA1	KN202
	Stop (Mushroom Button)	KYK14	KY1	KR4R	KA1	KN202
	Stop (With Lockout)	KYK15	KY1	KR3R, K4	KA1	KN202
	Stop (With Sealed Contacts and Lockout)	KYK124 ◆	KY1	KR3R, K4	KA51	KN202
	Stop Mushroom (With Sealed Contacts and Lockout)	KYK123 ◆	KY1	KR4R, K4	KA51	KN202
To Stop - Break Glass	KYK116	KY1	K15	KA1	KN799RP	
To Stop - Break Glass (Red Enclosure)	KYK117	KY1S1	K15	KA1	KN799RP	
2	Forward-Reverse	KYK24	KY2	KR1B, KR1B	KA1, KA1	KN206, KN207
	Jog-Stop (Lockout on Stop)	KYK224	KY2	KR1B, KR3R, K4	KA1, KA1	KN218, KN202
	On-Off	KYK218	KY2	KR1B, KR3R	KA1, KA1	KN203, KN204
	On-Off (With Sealed Contacts)	KYK222 ◆	KY2	KR1B, KR3R	KA51, KA51	KN203, KN204
	On-Off (Maintained Contact)	KYK221	KY2	KR11GR	KA1	KN203, KN204
	Open-Close	KYK26	KY2	KR1B, KR1B	KA1, KA1	KN209, KN208
	Start-Stop	KYK21	KY2	KR1B, KR3R	KA1, KA1	KN201, KN202
	Start-Stop (With Sealed Contacts)	KYK223 ◆	KY2	KR1B, KR3R	KA51, KA51	KN201, KN202
	Start-Stop (Lockout on Stop)	KYK23	KY2	KR1B, KR3R, K4	KA1, KA1	KN201, KN202
	Start-Stop (Maintained Contact)	KYK27	KY2	KR11GR	KA1	KN201, KN202
	Start-Stop (With Maintained Sealed Contacts)	KYK220 ◆	KY2	KR11GR	KA51	KN201, KN202
	Start-Stop (Mushroom on Stop)	KYK22	KY2	KR1B, KR4R	KA1, KA1	KN201, KN202
	Up-Down	KYK25	KY2	KR1B, KR1B	KA1, KA1	KN211, KN210
	3	Forward-Reverse-Start-Stop	KYK35	KY3	KS11B, KR1B, KR3R	KA1, KA1, KA1
Forward-Reverse-Stop		KYK31	KY3	KR1B, KR1B, KR3R	KA1, KA1, KA1	KN206, KN207, KN202
Forward-Reverse-Stop (Lockout on Stop)		KYK326	KY3	KR1B, KR1B, KR3R, K4	KA1, KA1, KA1	KN206, KN207, KN202
Forward-Reverse-Stop (With Sealed Contacts and Lockout on Stop)		KYK322 ◆	KY3	KR1B, KR1B, KR3R, K4	KA51, KA51, KA51	KN206, KN207, KN202
High-Low-Stop		KYK34	KY3	KR1B, KR1B, KR3R	KA1, KA1, KA1	KN214, KN215, KN202
Jog/Run-Start-Stop		KYK36	KY3	KS11B, KR1B, KR3R	KA1, KA1, KA1	KN242, KN201, KN202
Open-Close-Stop		KYK33	KY3	KR1B, KR1B, KR3R	KA1, KA1, KA1	KN209, KN208, KN202
Open-Close-Stop (Lockout on Stop)		KYK327	KY3	KR1B, KR1B, KR3R, K4	KA1, KA1, KA1	KN209, KN208, KN202
Open-Close-Stop (With Sealed Contacts and Lockout on Stop)		KYK323 ◆	KY3	KR1B, KR1B, KR3R, K4	KA51, KA51, KA51	KN209, KN208, KN202
Red 120 Vac Pilot Light-Start-Stop		KYK317	KY3	KP1R31, KR1B, KR3R	KA2, KA3	KN200, KN201, KN202
Red 120 Vac Pilot Light-Start-Stop (With Sealed Contacts)		KYK321 ◆	KY3	KP1R31, KR1B, KR3R	KA51, KA51	KN200, KN201, KN202
Red 120 Vac/dc Pilot Light-Start-Stop		KYK324	KY3	KP3R31, KR1B, KR3R	KA1, KA1	KN200, KN201, KN202
Up-Down-Stop		KYK32	KY3	KR1B, KR1B, KR3R	KA1, KA1, KA1	KN211, KN210, KN202
Up-Down-Stop (Lockout on Stop)		KYK325	KY3	KR1B, KR1B, KR3R, K4	KA1, KA1, KA1	KN211, KN210, KN202
Up-Down-Stop (With Sealed Contacts and Lockout on Stop)	KYK328 ◆	KY3	KR1B, KR1B, KR3R, K4	KA51, KA51, KA51	KN211, KN210, KN202	

▲ Control stations are UL Listed for use in areas classified as Class II Division 2 Group G and Class III.
◆ Control station consists of components that are UL Listed for use in Class I, Division 2, Groups A, B, C or D.

Standard Assembled Control Stations Pages 183-184
 Custom Assembled Control Stations Page 182
 Dimensions Pages 186-187
 Key Sheet for Custom Assembled Control Stations Pages 188-189

Push Button and Operator Interface - Type B and 30 mm Control Stations

Types K and SK — 30 mm Control Stations

Assembled Control Stations - UL Types 1, 3, 4, and 13/NEMA Types 1, 3, 4 and 13 ♦

No. of Units	Legend Plate Marking And Features	Type	Consists Of			
			Enclosure	Operators	Contact Blocks	Legend Plates
1	Start	KYSS101	KYSS1	KR1B	KA1	KN201
	Stop	KYSS103	KYSS1	KR3R	KA3	KN202
	Stop (Lockout)	KYSS105	KYSS1	KR3R with K5	KA3	KN202
	Off/On (Selector Switch)	KYSS110	KYSS1	KS11B	KA1	KN244
	Hand/Off/Auto (Selector Switch)	KYSS111	KYSS1	KS43B	KA1	KN260
2	Start/Stop	KYSS201	KYSS2	KR1B, KR3R	KA1, KA3	KN201, KN202
	Start/Stop (Lockout on Stop)	KYSS203	KYSS2	KR1B, KR3R with K5	KA1, KA3	KN201, KN202
	Up/Down	KYSS205	KYSS2	KR1B, KR1B	KA1, KA1	KN211, KN210
	Start/Stop (Maintained Contact)	KYSS210	KYSS2	KR11U	KA1, KA1	KN201, KN202
3	Forward/Reverse/Stop	KYSS301	KYSS3	KR1B, KR1B, KR3R	KA1, KA1, KA3	KN206, KN207, KN202
	Up/Down/Stop	KYSS302	KYSS3	KR1B, KR1B, KR3R	KA1, KA1, KA3	KN211, KN210, KN202
	Open/Close/Stop	KYSS303	KYSS3	KR1B, KR1B, KR3R	KA1, KA1, KA3	KN209, KN208, KN202
	High/Low/Stop	KYSS304	KYSS3	KR1B, KR1B, KR3R	KA1, KA1, KA3	KN214, KN215, KN202
	Forward/Reverse/Stop (Lockout on Stop)	KYSS308	KYSS3	KR1B, KR1B, KR3R w/K5	KA1, KA1, KA3	KN206, KN207, KN202
	Up/Down/Stop (Lockout on Stop)	KYSS309	KYSS3	KR1B, KR1B, KR3R w/K5	KA1, KA1, KA3	KN211, KN210, KN202
	Open/Close/Stop (Lockout on Stop)	KYSS310	KYSS3	KR1B, KR1B, KR3R w/K5	KA1, KA1, KA3	KN209, KN208, KN202
	High/Low/Stop (Lockout on Stop)	KYSS311	KYSS3	KR1B, KR1B, KR3R w/K5	KA1, KA1, KA3	KN214, KN215, KN202

♦ Control Stations are UL Listed for use in areas classified as Class II Division 2 Group G and Class III.

Assembled Control Stations - UL Types 1, 3, 4, 4X and 13/NEMA Types 1, 3, 4, 4X, and 13*

No. of Units	Legend Plate Marking And Features	Type	Consists Of			
			Enclosures	Operators	Contact Blocks	Legend Plates
1	Start	KYSK101	KYSS1	SKR1B	KA1	KN101WP
	Stop	KYSK103	KYSS1	SKR3R	KA3	KN102RP
	Stop (Lockout)	KYSK105	KYSS1	SKR3R with K5	KA3	KN102RP
	Off/On (Selector Switch)	KYSK110	KYSS1	SKS11B	KA1	KN144WP
	Hand/Off/Auto (Selector Switch)	KYSK111	KYSS1	SKS43B	KA1	KN160WP
2	Start/Stop	KYSK201	KYSS2	SKR1B, SKR3R	KA1, KA3	KN101WP, KN102RP
	Start/Stop (Lockout on Stop)	KYSK203	KYSS2	SKR1B, SKR3R with K5	KA1, KA3	KN101WP, KN102WP
	Up/Down	KYSK205	KYSS2	SKR1B, SKR1B	KA1, KA1	KN111WP, KN110WP
	Start/Stop (Maintained Contact)	KYSK210	KYSS2	SKR11U	KA1, KA1	KN101WP, KN102WP
3	Forward/Reverse/Stop	KYSK301	KYSS3	SKR1B, SKR1B, SKR3R	KA1, KA1, KA3	KN106WP, KN107WP, KN102RP
	Up/Down/Stop	KYSK302	KYSS3	SKR1B, SKR1B, SKR3R	KA1, KA1, KA3	KN111WP, KN110WP, KN102RP
	Open/Close/Stop	KYSK303	KYSS3	SKR1B, SKR1B, SKR3R	KA1, KA1, KA3	KN109WP, KN108WP, KN102RP
	High/Low/Stop	KYSK304	KYSS3	SKR1B, SKR1B, SKR3R	KA1, KA1, KA3	KN114WP, KN115WP, KN102RP
	Forward/Reverse/Stop (Lockout on Stop)	KYSK308	KYSS3	SKR1B, SKR1B, SKR3R w/K5	KA1, KA1, KA3	KN106WP, KN107WP, KN102RP
	Up/Down/Stop (Lockout on Stop)	KYSK309	KYSS3	SKR1B, SKR1B, SKR3R w/K5	KA1, KA1, KA3	KN111WP, KN110WP, KN102RP
	Open/Close/Stop (Lockout on Stop)	KYSK310	KYSS3	SKR1B, SKR1B, SKR3R w/K5	KA1, KA1, KA3	KN109WP, KN108WP, KN102RP
	High/Low/Stop (Lockout on Stop)	KYSK311	KYSS3	SKR1B, SKR1B, SKR3R w/K5	KA1, KA1, KA3	KN114WP, KN115WP, KN102RP

* Control Stations are UL Listed for use in areas classified as Class II Division 2 Group G and Class III.

Assembled Control Stations - UL Types 1, 3, 4, 4X and 13/NEMA Types 1, 3, 4, 4X, and 13▲

No. of Units	Legend Plate Marking And Features	Type	Consists Of			
			Enclosure	Operators	Contact Blocks	Legend Plates
1	Hand-Off-Auto (Sel. Sw. with Sealed Contacts)	SKY121 ■	SKY1	SKS43B	KA51	KN160WP
	Hand-Off-Auto (Sel. Switch)	SKY111	SKY1	SKS43B	KA1	KN160WP
	Jog	SKY107	SKY1	SKR1B	KA1	KN118WP
	Man-Auto (Sel. Switch)	SKY108	SKY1	SKS11B	KA1	KN143WP
	Off-On (Sel. Sw. with Sealed Contacts)	SKY122 ■	SKY1	SKS11B	KA51	KN144WP
	Off-On (Sel. Switch)	SKY110	SKY1	SKS11B		
	Start	SKY101	SKY1	SKR1B	KA1	KN101WP
	Start (With Sealed Contacts)	SKY125 ■	SKY1	SKR1B	KA51	KN101WP
	Stop	SKY103	SKY1	SKR3R	KA3	KN102RP
	Stop (With Lockout)	SKY105	SKY1	SKR3R, K5	KA3	KN102RP
Stop (With Sealed Contacts and Lockout)	SKY124 ■	SKY1	SKR3R, K5	KA51	KN102RP	
2	Forward-Reverse	SKY204	SKY2	SKR1B, SKR1B	KA1, KA1	KN106WP, KN107WP
	On-Off	SKY222 ■	SKY2	SKR1B, SKR3R	KA51, KA51	KN103WP, KN104RP
	Open-Close	SKY206	SKY2	SKR1B, SKR1B	KA1, KA1	KN109WP, KN108WP
	Start-Stop	SKY201	SKY2	SKR1B, SKR3R	KA1, KA3	KN101WP, KN102RP
	Start-Stop (Lockout on Stop)	SKY203	SKY2	SKR1B, SKR1R, K5	KA1, KA3	KN101WP, KN102RP
	Start-Stop (With Maintained Sealed Contacts)	SKY220 ■	SKY2	SKR11GR	KA51	KN101WP, KN102RP
3	Start-Stop (With Sealed Contacts)	SKY223 ■	SKY2	SKR1B, SKR3R	KA51, KA51	KN101WP, KN102RP
	Up-Down	SKY205	SKY2	SKR1B, SKR1B	KA1, KA1	KN111WP, KN110WP
	Forward-Reverse-Stop	SKY301	SKY3	SKR1B, SKR1B, SKR3R	KA1, KA1, KA3	KN106WP, KN107WP, KN102RP
	Forward-Reverse-Stop (With Sealed Contacts and Lockout on Stop)	SKY322 ■	SKY3	SKR1B, SKR1B, SKR3R	KA51, KA51, KA51	KN106WP, KN107WP, KN102RP
	High-Low-Stop	SKY304	SKY3	SKR1B, SKR1B, SKR3R	KA1, KA1, KA3	KN114WP, KN115WP, KN102RP
	Open-Close-Stop	SKY303	SKY3	SKR1B, SKR1B, SKR3R	KA1, KA1, KA3	KN109WP, KN108WP, KN102RP
	Open-Close-Stop (With Sealed Contacts)	SKY323 ■	SKY3	SKR1B, SKR1B, SKR3R	KA51, KA51, KA51	KN109WP, KN108WP, KN102RP
	Red 120 VAC Pilot Light-Start-Stop	SKY315A	SKY3	SKP1R31, SKR1B, SKR3R	KA1, KA3	KN101WP, KN102RP
Start-Jog-Stop	SKY305	SKY3	SKR1B, SKR1B, SKR3R	KA1, KA1, KA3	KN101WP, KN118WP, KN102RP	
Up-Down-Stop	SKY302	SKY3	SKR1B, SKR1B, SKR3R	KA1, KA1, KA3	KN111WP, KN110WP, KN102RP	
Up-Down-Stop (With Sealed Contacts and Lockout on Stop)	SKY328 ■	SKY3	SKR1B, SKR1B, SKR3R	KA51, KA51, KA51	KN111WP, KN110WP, KN102RP	

▲ Control Stations are UL Listed for use in areas classified as Class II Division 2 Group G and Class III.

■ Control Stations are UL Listed for use in areas classified as Class I Division 2 Groups A, B, C and D.

Push Button and Operator Interface - Type B and 30 mm Control Stations Types K, SK, KX, and T — 30 mm Flush Plates

Stainless Steel NEMA Type 1 Flush Plates

These flush plates accept Type K, SK, KX and T operators and contact blocks and may be used with a standard 2 x 3 general purpose switch box. A 2 1/2" deep box should be used with two Type K contact blocks mounted side by side. If two Type K contact blocks mounted in tandem are needed, a 3 1/2" deep box should be used. Although oiltight/watertight operators are used, an assembled station using the flush plates is **not oiltight/watertight**. The kits include the stainless steel flush plate, cover screws and a set of liners. The liners must be used to maintain electrical clearance.

Two Unit



Number of Units	Description	Type Number
1	1 Unit flush plate, cover screws, insulating liners	K25
2	2 Unit flush plate, cover screws, insulating liners	K26
3	3 Unit flush plate, cover screws, insulating liners	K27
4	4 Unit flush plate, cover screws, insulating liners	K28

Approximate Dimensions

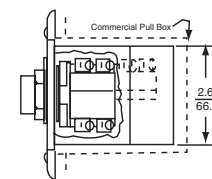
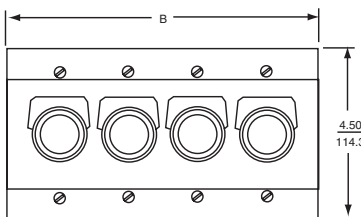
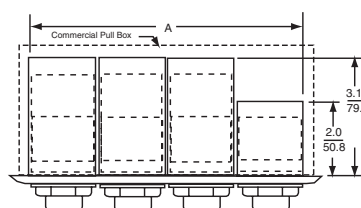

Number of Units	Dimensions (inches)	
	A*	B
1	1 25/32" (45 mm)	2 3/4" (70 mm)
2	3 19/32" (91 mm)	4 9/16" (116 mm)
3	5 13/32" (36 mm)	6 3/8" (162 mm)
4	7 7/32" (183 mm)	8 3/16" (208 mm)

* Center to center of operators is 1 13/16" (46 mm).

General Purpose NEMA Type 1 Flush Mounting Control Station With Pull Box For Type K Control Units (Stations Are Not Oiltight)

Number of Units	Enclosure Only For Customer Assembly	Custom Built Factory Assembled Control Stations
	Type	Type
1	KZP1	KZP10
2	KZP2	KZP20
3	KZP3	KZP30
4	KZP4	KZP40
5	KZP5	KZP50
6	KZP6	KZP60
7	KZP7	KZP70
8	KZP8	KZP80

Special Features

Type 304 Stainless Steel Flush Plate (Form Y242)

No. of Units

1-4

5-8

Omit Pull Box (Form Y243)

No. of Units

1-2

3-4

5-6

7-8

Dimensions (Type KZP) Page 187

Push Button and Operator Interface - Type B and 30 mm Control Stations Types K and SK — 30 mm Enclosure Dimensions

Location Of Control Units

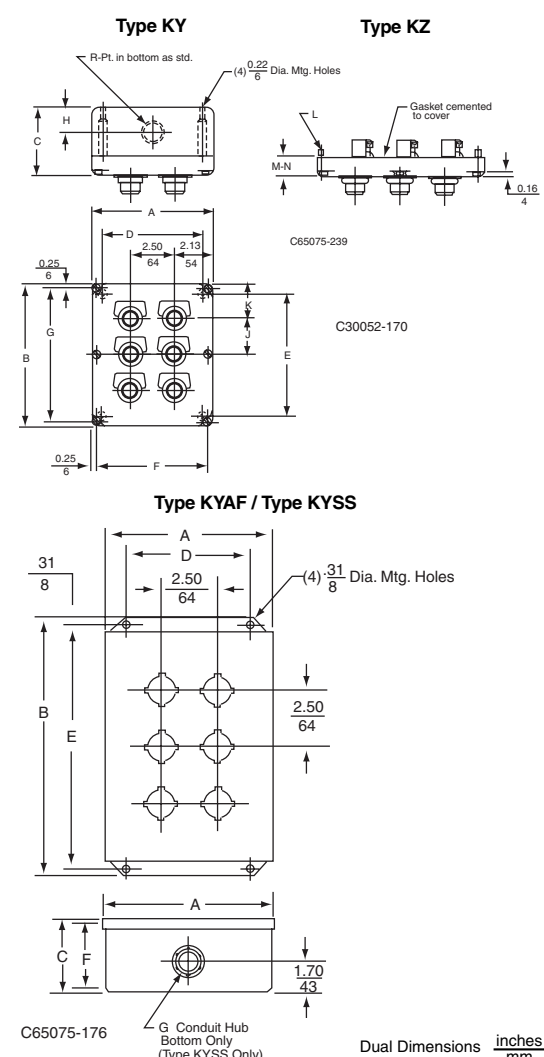
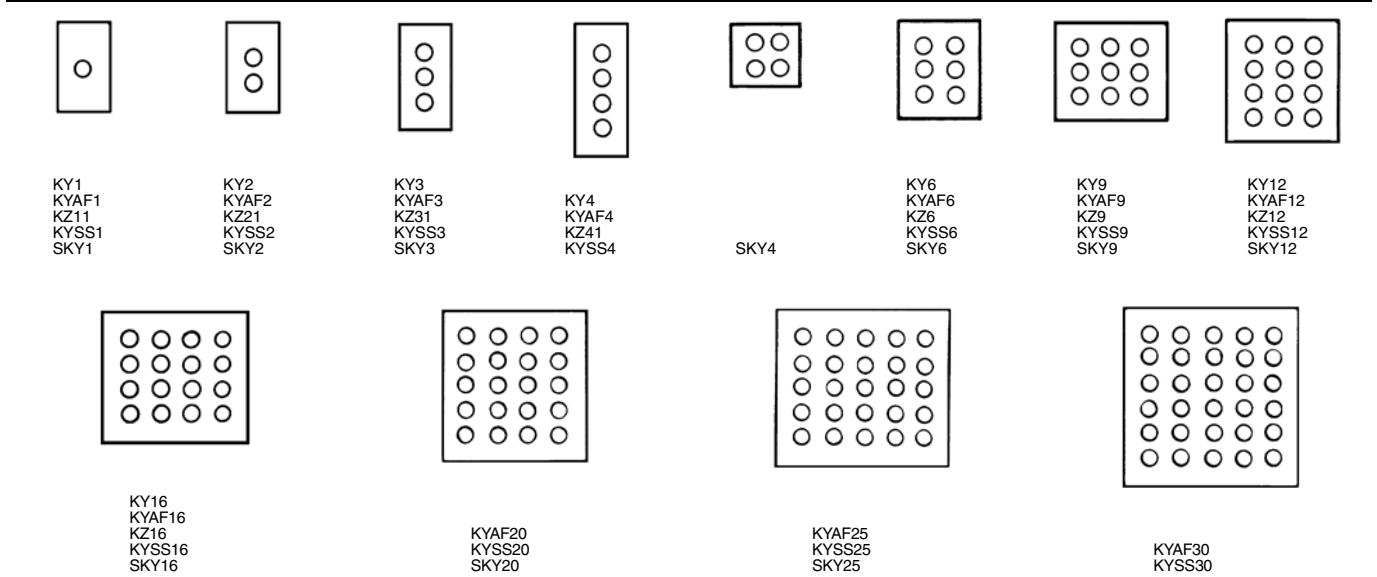

Table for Type KY and KZ

No. of Units	Overall Dimensions			Mounting Dim.				Conduit		Other Dimensions			Cover Thickness	
	A	B	C	KY		KZ		H	R	J	K	L	KY	KZ
				D	E	F	G						M	N
1	3 5/8	4	3 17/32	3	2 3/4	3 1/8	5 1/2	1 1/8	3/4-14	—	2	10-24 x 5/8	1.18	.50
2	3 5/8	5 1/4	3 17/32	3	4 1/2	3 1/8	5 1/4	1 1/8	3/4-14	1 3/4	2	10-24 x 5/8	1.18	.50
3	3 5/8	7 1/2	3 17/32	3	6 1/4	3 1/8	7	1 1/8	3/4-14	1 3/4	2	10-24 x 5/8	1.18	.50
4	3 5/8	9 1/4	3 17/32	3	8	3 1/8	8 3/4	1 1/8	3/4-14	1 3/4	2	10-24 x 5/8	1.18	.50
6	6 3/4	8	3 27/32	5 5/8	6 5/8	6 1/4	7 1/4	1 3/8	3/4-14	2	2	8-32	1.06	1.06
9	9 1/4	8	3 27/32	8 1/8	6 5/8	8 3/4	7 1/2	1 3/8	3/4-14	2	2	8-32	1.06	1.06
12	9 1/4	10	4 5/32	8 1/8	8 5/8	8 3/4	9 1/2	1 19/32	1 1/4-11 1/2	2	2	8-32	.88	.88
16	11 3/4	10 1/2	4 5/32	10 5/8	9 5/8	11 1/4	10	1 19/32	1 1/2-11 1/2	2	2 1/4	8-32	.88	.88

Table for Type KYAF and KYSS

No. of Units	Overall Dimensions						Mounting Dimensions				Inside Dim.		Conduit For Type KYSS Only
	A		B		C		D		E		F		G
	IN	mm	IN	mm	IN	mm	IN	mm	IN	mm	IN	mm	
1	4.18	106	5.24	133	3.63	92	2.25	57	4.62	117	3.41	87	3/4-14
2	4.18	106	7.74	197	3.63	92	2.25	57	7.12	181	3.41	87	3/4-14
3	4.18	106	10.24	260	3.63	92	2.25	57	9.62	244	3.41	87	3/4-14
4	4.18	106	12.74	324	3.63	92	2.25	57	12.12	308	3.41	87	3/4-14
6	7.43	189	11.37	289	4.34	110	5.50	140	10.75	273	4.13	105	3/4-14
9	9.68	246	11.37	289	4.34	110	7.75	197	10.75	273	4.13	105	1-11 1/2
12	9.68	246	13.87	352	4.34	110	7.75	197	13.25	337	4.13	105	1 1/4-11 1/2
16	11.93	303	13.87	352	4.34	110	10.00	254	13.25	337	4.13	105	1 1/2-11 1/2
20	11.93	303	16.37	416	4.34	110	10.00	254	15.75	400	4.13	105	1 1/2-11 1/2
25	14.18	360	16.37	416	4.34	110	12.25	311	15.75	400	4.13	105	(2) 1 1/2-11 1/2
30	14.18	360	18.87	479	4.34	110	12.25	311	18.25	464	4.13	105	(2) 1 1/2-11 1/2

Push Button and Operator Interface - Type B and 30 mm Control Stations Types K and SK — 30 mm Enclosure Dimensions

Type SKY Enclosures

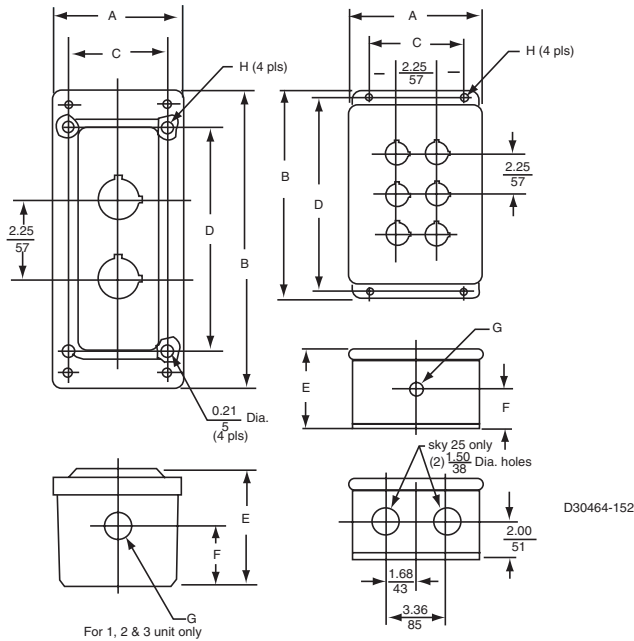

**Flush Mount Sheet Steel
Type KZP**

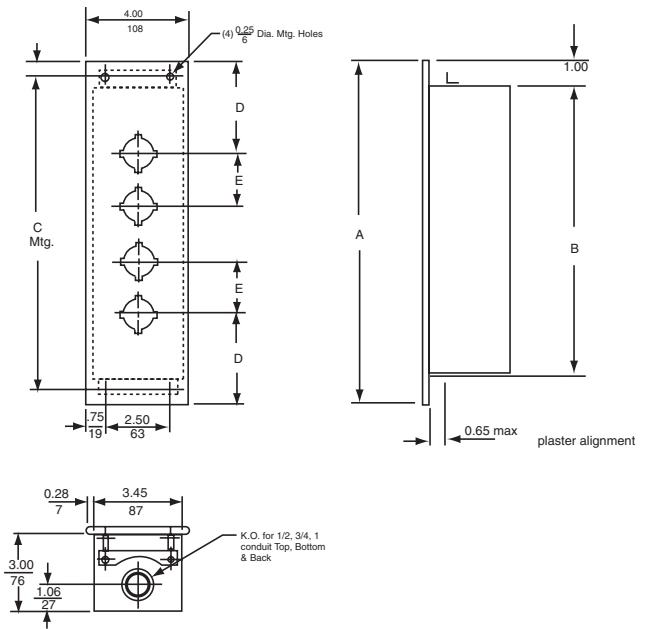

Glass Polymeric Type SKY

Mtg. Hole	Conduit Size		Conduit Location		Height	Mtg. Dim.			Overall Dim.			No. of Units				
	H	G	F	E		D	C	B	A	IN	mm					
0.31	8	0.75	19	1.34	34	3.88	99	4.88	124	2.94	75	6.63	169	3.81	97	1
0.31	8	0.75	19	1.34	34	3.88	99	4.88	124	2.94	75	6.63	169	3.81	97	2
0.31	8	0.75	19	1.34	34	3.88	99	7.13	181	2.94	75	8.88	226	3.81	97	3
0.31	8	0.75	19	2.00	51	4.72	120	6.75	172	4.00	102	7.53	191	7.53	191	4
0.31	8	0.75	19	2.00	51	4.72	120	8.88	226	4.00	102	9.50	241	7.50	191	6
0.31	8	1.00	25	1.75	44	4.25	108	10.75	273	6.00	153	11.34	288	9.41	239	9
0.31	8	1.00	25	1.75	44	4.25	108	10.75	273	6.00	153	11.34	288	9.41	239	12
0.31	8	1.50	38	2.00	51	5.25	133	12.75	324	8.00	203	13.41	341	11.44	291	16
0.31	8	1.50	38	2.00	51	5.25	133	12.75	324	8.00	203	13.41	341	11.44	291	20
0.31	8	1.50	38	2.00	51	6.25	159	14.63	372	10.00	254	15.47	393	13.47	342	25

Class 9001 Type KZP

Type	Letter Dimensions									
	A		B		C		D		E	
	IN	mm	IN	mm	IN	mm	IN	mm	IN	mm
KZP1	7.56	192	5.56	141	6.38	162	3.78	96	-	-
KZP2	9.43	240	7.44	189	8.25	210	3.72	94	2.00	51
KZP3	11.30	287	9.31	236	10.12	257	3.65	93	2.00	51
KZP4	13.18	335	11.18	284	12.00	305	3.59	91	2.00	51
KZP5	15.06	383	13.06	332	13.88	353	3.53	90	2.00	51
KZP6	16.93	430	14.94	379	15.75	400	3.47	88	2.00	51
KZP7	18.81	478	16.81	427	17.62	448	3.40	86	2.00	51
KZP8	20.68	525	18.69	475	19.50	495	3.34	85	2.00	51

Dual Dimensions $\frac{\text{inches}}{\text{mm}}$

Push Button and Operator Interface - Type B and 30 mm Control Stations

Types K, SK, KX, and T — 30 mm Key Sheet

 CONTROL GROUP	KEY SHEET FOR ORDERING CLASS 9001 TYPE "K", "KX", "SK" OR "T" ASSEMBLED OILTIGHT CONTROL STATIONS		INVOICE NUMBER
	CUSTOMER		CUSTOMER ORDER NUMBER
DATE	QUANTITY	CLASS 9001 TYPE	LIST PRICE EACH, DS-1

TOP										
<p>TYPE NUMBER KEY</p> <p>Select Type Numbers from Catalog Digest</p> <p>1. Operator or Closing Plate. Include "H" No. for Contact Blocks Assembled to Operator. Example - KR1B-H13</p> <p>2. Attachment or Protective Cap. Example - KU-1</p> <p>3. Legend Plate Type Number. Example - KN-201</p> <p>4. Legend Plate Marking. - Use Only if Special Marking is Required. Example: Line 3. - KN-299 Line 4. - "Panic"</p> <p>For Further Instructions - See Reverse Side</p>	1	A	1	G	1	N	1	U	1	AA
	2		2		2		2		2	
	3		3		3		3		3	
	4		4		4		4		4	
	1	B	1	H	1	P	1	V	1	BB
	2		2		2		2		2	
	3		3		3		3		3	
	4		4		4		4		4	
	1	C	1	J	1	Q	1	W	1	CC
	2		2		2		2		2	
	3		3		3		3		3	
	4		4		4		4		4	
	1	D	1	K	1	R	1	X	1	DD
	2		2		2		2		2	
	3		3		3		3		3	
	4		4		4		4		4	
1	E	1	L	1	S	1	Y	1	EE	
2		2		2		2		2		
3		3		3		3		3		
4		4		4		4		4		
1	F	1	M	1	T	1	Z	1	FF	
2		2		2		2		2		
3		3		3		3		3		
4		4		4		4		4		

Push Button and Operator Interface - Type B and 30 mm Control Stations

Types K, SK, KX, and T — 30 mm Ordering Instructions

INSTRUCTIONS FOR ORDERING ASSEMBLED CONTROL STATIONS

1. Use separate Key Sheet for each different control station arrangement on order.
2. Select locations on sketch (reverse side) which illustrate manner in which station is to be mounted. Example: Selection of location A, B, C and D indicates a four unit station mounted with its long axis vertical and the legend plates mounted accordingly. Selection of locations A, G, N and U indicates mounting with long axis horizontal.
3. Each interlock attachment Type K-3 must be specified at two adjacent locations. Type KR-11 or Type KR-12 must be specified at two adjacent locations. Type KRD Time Delay Units require space equal to two push button mounting holes. The unused hole must be covered with at Type K-51 or K-52 Closing Plate. The time delay unit must be positioned with the contacts adjacent to the unused hole. The unused hole may be located above, below, right or left of the unit.
4. Types KN-3 and KN-4 legend plates will not fit upright on 2, 3 or 4 unit Type KY or Type KZ enclosures with long axis vertical. Type KYC enclosures must use Type KN-8 legend plates.
5. Large (2 1/4" Dia.) mushroom button operators can not be mounted in adjacent locations.
6. Enclosures have sufficient depth to accommodate two contact blocks side-by-side on illuminated operators (Types K, SK and T only).

Suffix No. (Add to Operator Type No.)	Positions				Total Circuits	Circuit Symbol
	1	2	3	4		
H1	KA-1				1 N.O. 1 N.C.	
H2	KA-1	KA-1			2 N.O. 2 N.C.	
H3	KA-1	KA-1	KA-1		3 N.O. 3 N.C.	
H4	KA-1	KA-1	KA-1	KA-1	4 N.O. 4 N.C.	
H5	KA-2				1 N.O.	
H6	KA-3				1 N.C.	
H7	KA-2	KA-2			2 N.O.	
H8	KA-3	KA-3			2 N.C.	
H9	KA-4	KA-1			1 N.O. 1 E.C.N.O. 2 N.C.	
H10	KA-4	KA-5			1 E.C.N.O. 1 E.C.N.C. 1 N.C.	
H11	KA-1	KA-1		KA-1	3 N.O. 3 N.C.	
H12	KA-2	KA-3	KA-2	KA-3	2 N.O. 2 N.C.	
H13		KA-1			1 N.O. 1 N.C.	
H14		KA-3			1 N.C.	
H36		KA-2			1 N.O.	

Location of Control Units – Types K, KX, SK and T

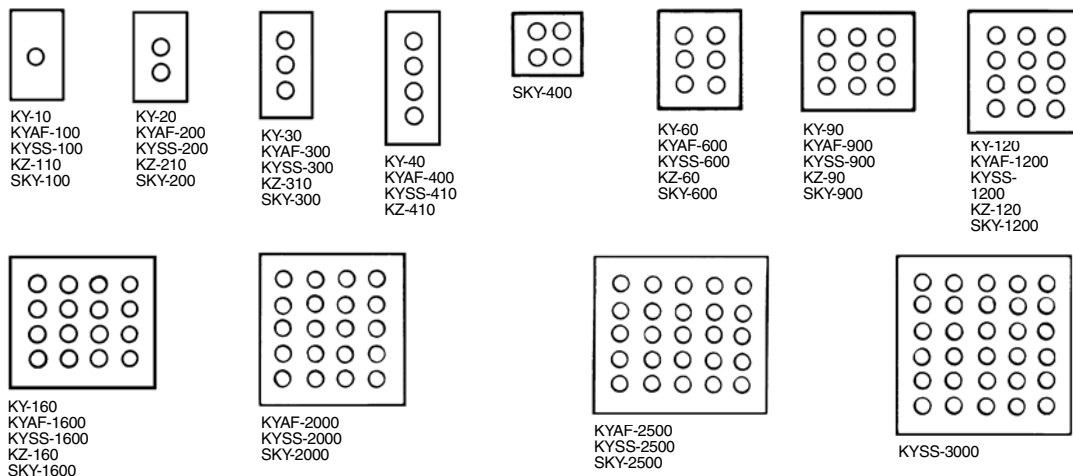

Push Button and Operator Interface - Type B and 30 mm Control Stations

Types KY and KZC Security Control Stations — Application Data, Features

Standard Features

- All cylinders are random keyed.
- Key operators are all spring return from both sides to center, maintained contact not available.
- Key withdrawal is in the center position only.
- Cover is mechanically interlocked with the box to make it difficult for unauthorized people to gain entrance into the enclosure.
- Cover is securely held in place by allen screws.
- Cylinders are of builders hardware type, which permits keying stations to the rest of the cylinders in a development.
- Cylinder legend plate marking is "OPEN-CLOSE."
- An optional push button is available. The legend plate marking is "STOP."



Type KY192



Type KZC299

UL Listed
File E42259
CNN NKCR

CSA Certified
File LR25490
Class 321103

Electrical Ratings

Key Operator: One Class 9007 Type AO2 snap switch is used for the "OPEN" position and one snap switch is used for the "CLOSE" position. See page 191 for electrical ratings of the 9007 AO2.

Stop Button: One Class 9001 Type KA1 contact block is used on the optional push button. See page 191 for 9001KA1 electrical ratings. **(Note: The KA1 contact block has a maximum voltage rating of 300 volts (NEMA / UL A300) when used in the Type KZC station.)**

Dimensions

Surface Mount Type KY

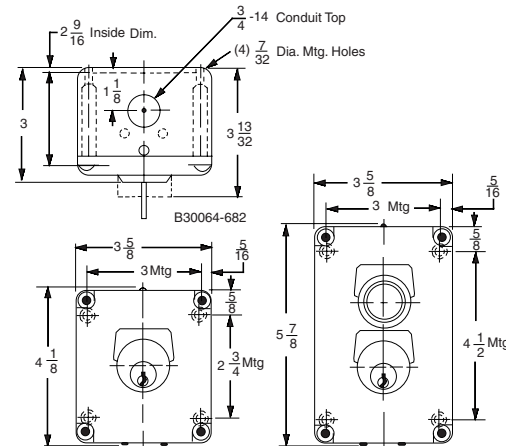

Flush Mount Type KZC

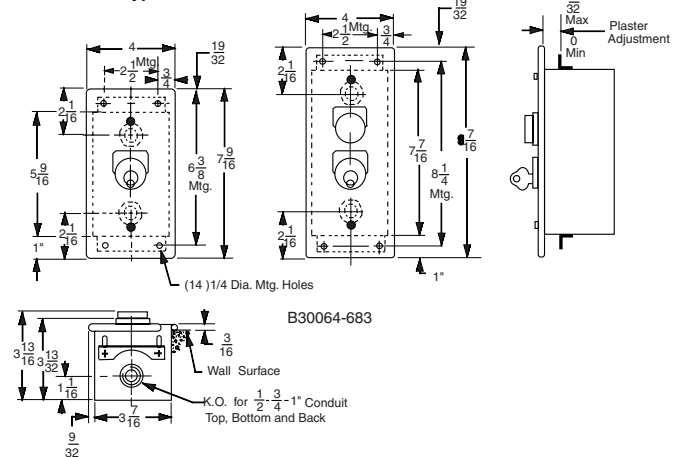

Description	Type of Cylinder	Cylinder Finish	Special Features	Cast Aluminum Enclosure *	Satin Chrome Finish Flush Mtd. W/Box
				Type	Type
Key Operator Only	Emhart	Chrome	Complete With Core◆ (6 Tumbler Pins) Lock Cylinder Only - Core Omitted▲ (6 Tumbler Pins)	KY198	KZC198
	Yale	Brass		KY199	KZC199
	Best	Chrome		KY197	KZC197
	Best	Chrome	Complete With Core◆ (7 Tumbler Pins) Lock Cylinder Only - Core Omitted▲ (7 Tumbler Pins)	KY196	KZC196
	Best	Chrome		KY195	KZC195
	Best	Chrome		KY194	KZC194
	Schlage	Chrome	KY193	KZC193	
	Sargent	Chrome	Maximum Security Cylinder	KY192	KZC192
Key Operator With Stop Button	Emhart	Chrome	Complete With Core◆ (6 Tumbler Pins) Lock Cylinder Only - Core Omitted▲ (6 Tumbler Pins)	KY298	KZC298
	Yale	Brass		KY299	KZC299
	Best	Chrome		KY297	KZC297
	Best	Chrome	Complete With Core◆ (7 Tumbler Pins) Lock Cylinder Only - Core Omitted▲ (7 Tumbler Pins)	KY296	KZC296
	Best	Chrome		KY295	KZC295
	Best	Chrome		KY294	KZC294
	Schlage	Chrome	KY293	KZC293	
	Sargent	Chrome	Maximum Security Cylinder	KY292	KZC292

*: Meets NEMA Type 3R requirements.

◆ When Best Lock stations are supplied with core, customer should contact local Best Lock representative to change core.

▲ When Best Lock stations are supplied without core, customer must purchase core separately from Best Lock Company, and customer can subsequently change core at his convenience.

Contact Your Local Square D Sales Office If:

- Master keying is required.
- Keying several stations alike is required.
- Station is to be keyed to a specific key number.
- Nonstandard legend plates are required.
- Extra keys are required.
- A specific type of keyway is required.

Repair Parts

Replacement or duplicate keys: Emhart, Yale, or Schlage - local distributor, hardware store, or lock shop that duplicates keys. Square D can supply and deliver in 5 weeks. BEST – Must purchase from local Best Lock Corporation representative. Sargent – must purchase from Square D. Keys supplied with our security control station are registered to the Square D Company.

Replacement enclosures are not sold. Replacement cores or cylinders are not sold.

Push Button and Operator Interface - Type B and 30 mm Control Stations Types K, SK, KX, and T — 30 mm Contact Blocks

The Class 9001 Type KA contact blocks have been improved. The most noticeable change is that the terminals are FINGERSAFE® contact blocks (meeting VDE 0106 Part 100). They also have one screw mounting and captive backed out plus/minus terminal screws. These contact blocks still use the same reliable double break direct acting contacts used since 1965. Because of the wiping action of these contacts, they are suitable for use with programmable controllers. All contact blocks listed below will accept up to 2 #12-#24 solid or stranded wires. Types KA1, KA31, KA3, and KA33 N.C. contacts are direct opening. (→)

Standard Contact Blocks

Description	Symbol	Type
 (Clear Cover)		KA1
 (Green Cover)		KA2
 (Hed Cover)		KA3
 (Clear Cover)	 N.O. Contact Early Closing	KA4
 (Red Cover)	 N.C. Contact Late Opening	KA5
 (Green Cover)	 N.O. Contact Early Closing	KA6

Additional Circuit Arrangements Available

Sequencing *: N.O. Contact of KA4 closes before N.O. Contact on KA1		Order One Type KA4 and One Type KA1
Overlapping *: N.O. Contact of KA4 closes before N.C. Contact of KA5 Opens		Order One Type KA4 and One Type KA5

* For push buttons or two position selector switches (Types K or SKS11, K or SKS12, K or SKS25, K or SKS34, K or SK11J, K or SK12J, K or SK25J and K or SK34J) only. For sequencing or overlapping contacts on other operators — consult local Square D Sales Office.

Maximum Current Ratings for Control Circuit Contacts – Class 9001 Type KA1-KA6, KA21-25, KA31-35, KA1G-KA6G

Volts	AC						Volts	DC					
	Inductive (NEMA / UL Type A600) 35% Power Factor							Inductive and Resistive (NEMA / UL Type A600)					
	Make		Break		Continuous Carrying Amperes	Resistive 75% Power Factor Make, Break and Continuous Amperes		Make and Break				Continuous Carrying Amperes	
	Amperes	VA	Amperes	VA				KA1	KA2, KA3	KA4	KA5, KA6		
120	60	7200	6.0	720	10	10	125	1.1	1.1	1.1	1.1	10	
240	30	7200	3.0	720	10	10	250	0.55	0.55	0.55	10	
480	15	7200	1.5	720	10	10	600	0.2	0.2	0.2	10	
600	12	7200	1.2	720	10	10							

Maximum Current Ratings for Control Circuit Contacts – Class 9007 Type AO2

Switch Type	Contact Action	Direct Opening Contacts to Meet IEC 60947-5-1 Requirements for Positive Opening Contacts	AC – 50 or 60 Hz						DC				AC or DC Continuous Carrying Amperes
			Volts	Inductive 35% Power Factor		Resistive 75% Power Factor		Volts	Inductive and Resistive				
				Make		Break			Make and Break Amperes				
				Amps	VA	Amps	VA		Single Throw	Double Throw			
AO-2	SPDT	No	120	40	4800	15	1800	15	125	2.0	0.5	0.5	15
			240	20	4800	10	2400	10	250	0.5	0.2	0.2	15
			480	10	4800	6	2880	6	600	0.1	0.02	0.02	15
			600	8	4800	5	3000	5	15

Symbol	Contact Blocks With Binder Head Screws (not FINGERSAFE® Contact Blocks)		Gold Flashed Contacts With Standard Pressure Wire Terminals
	Type	Quantity	Type
	KA21	25-Up ▲	KA31 (→)
	KA22	25-Up ▲	KA32
	KA23	25-Up ▲	KA33 (→)
 N.O. Early Closing	KA24	25-Up ▲	KA34
 N.C. Contact Late Opening	KA25	25-Up ▲	KA35

▲ Minimum order quantity is 25.

Contact Blocks Listed Below Are Not FINGERSAFE® Contact Blocks, But Provide:

- Terminals that accept ring tongue/fork tongue connectors
- Short single circuit contact blocks (0.75" deep vs. 0.97" deep on the FINGERSAFE® Contact Blocks)
- Same as old style Series G product available prior to 3/89.
- Use form Y238 (add to catalog # as suffix)



Symbol	Type	Symbol	Type
	KA1G	 N.O. Contact Early Closing	KA4G
	KA2G	 N.C. Contact Late Opening	KA5G
	KA3G	 N.O. Contact Early Closing	KA6G

Contact Blocks Listed Below Are Not FINGERSAFE® Contact Blocks, But Have "Quick Connect" Terminals.



Symbol	Type
	KA12
	KA13

Push Button and Operator Interface - Type B and 30 mm Control Stations

Types K, SK, KX, and T — 30 mm Reed Contact Blocks & Hazardous Location Information

In hazardous locations, it is not always required to use explosion-proof equipment like the Class 9001 Type BR control stations. Knowing what type of hazardous location exists will permit you to select the most economical solution to your application. If you're not sure what type of hazardous location exists, the "Summary of Classification" chart may help. If not, contact your local electrical inspector. When you know what class, division, and group(s) exists, see the table in the lower lefthand corner of this page for what Square D has to offer.

Summary Of Classification Chart

Class	Division	Group	
I. Gas 	1. Hazard May Exist May Exist In Atmosphere Under Normal Operating Conditions.	A. Acetylene	
		B. Hydrogen and Manufactured Gases containing Hydrogen	
		C. Petrochemicals (e.g. ethylene)	
		D. Petrochemicals (e.g. alcohol)	
	2. Potential Hazard A. May be present in atmosphere only under abnormal circumstances. B. Location adjacent to Division 1 location.	A. Acetylene	
		B. Hydrogen and Manufactured Gases containing Hydrogen	
		C. Petrochemicals (e.g. ethylene)	
		D. Petrochemicals (e.g. alcohol)	
II. Dust 	1. Hazard May Exist May Exist In Atmosphere Under Normal Operating Conditions.	E. Conductive and Combustible Dust (Resistivity <math><10^9</math> ohms/cm)	
		F. Carbonaceous Dusts (Resistivity >math>>10^2</math> ohm/cm but <math><10^9</math> ohm/cm)	
		G. Non-Conductive Combustible Dust (Resistivity >math>>= 10^2</math> ohms/cm)	
		2. Potential Hazard A. May be present in atmosphere only under abnormal circumstances.	G. Non-Conductive Combustible Dust (Resistivity >math>>= 10^2</math> ohms/cm)
	1. Production Areas	Easily Ignitable Fibers or Flyings	
		2. Handling and Storage Areas	Easily Ignitable Fibers or Flyings







For			Use
Class	Division	Group(s)	
I	1	A	1. Intrinsically Safe System ①
I	1	B, C, D	1. 9001 BR station 2. Intrinsically Safe System ①
I	2	A	1. 9001 K, SK, KX control stations with the restrictions listed in footnote ② 2. Intrinsically Safe System ①
I	2	B, C, D	1. 9001 BR station 2. 9001 K, SK, KX control stations with the restrictions listed in footnote ② 3. Intrinsically Safe System ①
II	1	E, F, G	1. 9001 BR station 2. Intrinsically Safe System ①
II	2	E, F	1. 9001 BR station 2. 9001 K, SK, KX control stations with the restrictions listed in footnote ② 3. Intrinsically Safe System ①
II	2	G	1. 9001 BR station 2. 9001 K, SK, KX control stations with the restrictions listed in footnote ③ 3. Intrinsically Safe System ①
III	1, 2	-	1. 9001 BR Station 2. 9001 K, SK, KX control stations with the restrictions listed in footnote ③ 3. Intrinsically Safe System ①

- ① An intrinsically safe system requires either a Class 8501 Type TO or NY2 barrier relay or an intrinsically safe barrier to restrict the energy available in the area classified as a hazardous area to a level less than that required to cause an explosion. In an intrinsically safe system, any **non-illuminated** Class 9001 operator or control station with standard contacts can be used. No illuminated operators, except the Class 9001 Type KP44 intrinsically safe pilot light, may be used.
- ② Any Class 9001 Type K, SK or KX operator can be used in an area classified as Class I, Division 2 hazardous locations.
- Only logic (KA40 series) or power (KA50 series) reed contact blocks are used.
 - All Type K and SK illuminated operators are UL approved for use in Class I Division 2 areas.
 - Type KX illuminated operators do not use 4 lamp light modules, or 2 lamp light modules other than the transformer type.
 - The operators are mounted in Type KY, KYSS, KYAF, SKY enclosures.
- ③ Any Class 9001 Type K, SK, or KX operator mounted in a Class 9001 Type KY, KYSS, KYAF, SKY enclosure may be used, except potentiometer operators.
- For ♦: Add Form Y243 to single lamp Push To Test pilot lights.

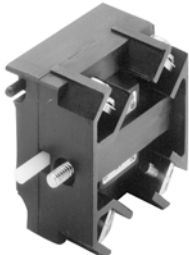
All contact blocks listed below will accept #12-18 solid or stranded wire.

Hermetically Sealed Logic Reed Contact Blocks







Suitable for use on low energy level circuits

Description	Symbol	Type
		KA41
		KA42
		KA43
		KA44
		KA45
Max. Volts AC/DC		Maximum Load
32/30 120/100		Res. 0.25 A 8 VA
		Ind. 0.10 A 3 VA
		Cont. 0.5 A 0.5 A

The maximum number of logic and/or power reed contact blocks per operator is the same for standard contact blocks, **except:**

- On 3 position selector switches with cams "C," "D," "E," "F," "G," "L," or "M" mount reed blocks on **one side only** (either side), maximum 2 in tandem.
- On 4 position selector switches, mount reed blocks on **one side only** (either side), maximum 2 in tandem.
- On joysticks or on Type KR8 or SKR8 push-pull operators, mount reed blocks on **one side only** (either side), maximum 2 in tandem.

Hermetically Sealed Power Reed Contact Blocks

Description	Symbol	Type			
		KA51			
		KA52			
		KA53			
		KA54			
		KA55			
AC NEMA / UL Type C300 ④					
Volts	Make		Break		Continuous Carrying Amps
	Amps	VA	Amps	VA	
120	10.00	1200	1.000	120	3.0
240	5.00	1200	0.500	120	3.0
DC NEMA / UL Type Q150 ⑤					
Volts	Make		Break		Continuous Carrying Amps
	Amps	VA	Amps	VA	
115	0.50	58	0.50	58	3.0

The power reed contact blocks can be used with standard industrial relays and starters through NEMA Size 4. Minimum voltage is 5 volts and the minimum current is 1 mA.

④ Inductive Rating – 35% Power Factor.

⑤ Inductive and Resistive Ratings.

Pilot Light For Intrinsically Safe Circuits — NEMA / UL Type 4X

Operating Voltage Range	Nominal Current	Lens Color	Type	
			V max. = 32 V	20-30 V AC/DC
I max. = 165 mA				

Intrinsically safe equipment must not release electrical or thermal energy capable of igniting certain explosive or combustible hazardous atmosphere, for which the equipment has been tested.

Listed below are pilot lights that are intrinsically safe when used with a suitable approved barrier or barrier relay (Class 8501 Type TO or NY2. These pilot lights are Factory Mutual FM# J1, OH42, AX3610 (FM approved). Consult your local Square D Sales Office for further details.

These pilot lights are fully encapsulated – there are no replaceable parts – except for the SK40 ring nut. Use KN100 series plastic legend plates.

Push Buttons and Operator Interface Specifier's Guide

Type BW, SKYP & XACA Pendant Stations

Catalog
2005

File 9001



CONTENTS

Description	Page
Type BW General Information	194
Type BW Specifications	195
Type BW Application Data and Order Information	196
Seriplex Control Bus Version 2, Material Pull Pendant Station	197
Type XACA Specifications	198
Type XACA Standard Duty	199
Type XACA Contact Blocks	199
Type XACA Operators	200
Type XACA Accessories	200
Type XACA Exploded Drawing	201
Type XACA Lamps and Legend Plates	202
Type XACA Order Form	203
Type XACA Dimensions	204
Type SKYP Specifications	205
Type SKYP Application Data and Order Information	206
Type SK Operators, Application Data and Order Information	207
Type SKYP Dimensions	208
Type SKYP Order Form	209
Declaration of Conformity	221



Push Button and Operator Interface - Type BW, SKYP & XACA Pendant Stations

Type BW Pendant Stations — General Information

Type BW Standard Duty Pendant Stations

The Class 9001 Type BW Pendant Station is a pre-assembled, 2 button station well suited for standard hoist applications. Oversized finger grips on the rear of the enclosure make it easy to grip and operate.



Features and Options

- Made of high impact thermoplastic with self-extinguishing flammability rating (UL 94V)
- NEMA 1, 3, 3R, 4, 4X, 13 Watertight, Dusttight, Oiltight, Corrosion Resistant
- UL Listed and CSA Approved
- 1/2" conduit opening
- Internal strain relief post
- Momentary contact
- Maintained contact
- Single speed
- Two speed
- With or without mechanical interlock
- Optional external hanger bracket and seal
- Ribs on top of enclosure prevent hanger bracket from rotating and coming loose
- Contoured for easy grip
- Easy to hold with one hand

- Push button legend inserts
- Field installable mushroom button
- Full cover gasket to exclude harmful contaminants



Off and Stop are White Letters on a Red Background

- Jumper included on all single speed buttons (except universal types), saves wiring time
- Self-lifting pressure wire connectors for easy wiring



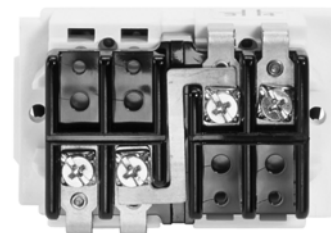

UV PROTECTED
FOR OUTDOOR USE



Push Button and Operator Interface - Type BW, SKYP & XACA Pendant Stations

Type BW Pendant Stations — Specifications

Specifications

Electrical ratings	AC - NEMA / UL B600 DC - NEMA / UL P600
Enclosure type	NEMA / UL Type 1, 3, 3R, 4, and 4X
Operating temperature	- 25 °C to + 60 °C - 13 °F to + 140 °F
Housing material	Polycarbonate/PET Polyester Blend
Storage temperature	- 40 °C to + 70 °C - 40 °F to + 158 °F
Cable entry	1/2 inch NPT
Approvals	 File E42259 CCN NKCR  File LR 25490 Class 3211 03  Marking

Electrical Contact Ratings (BW70'S AND BW80'S)

AC – NEMA / UL B600						
Volts ▲	Inductive 35% Power Factor				Continuous Carrying Amperes	Resistive 75% Power Factor Make, Break and Continuous Carrying Amperes
	Make		Break			
	Amps	VA	Amps	VA		
120	30.0	3600	3.0	360	5	5
240	15.0	3600	1.5	360	5	5
480	7.5	3600	0.75	360	5	5
600	0.6	3600	0.6	360	5	5

DC – NEMA / UL P600		
Volts	Inductive and Resistive	
	Make and Break Amperes	Continuous Carrying Amperes
120	1.10	5
240	0.55	5
600	0.20	5

▲ OSHA Regulation, Section 1910.170 Overhead and Gantry Cranes, limits the voltage at pendant push buttons to 150 Vac or 300 Vdc.

Approximate Dimensions

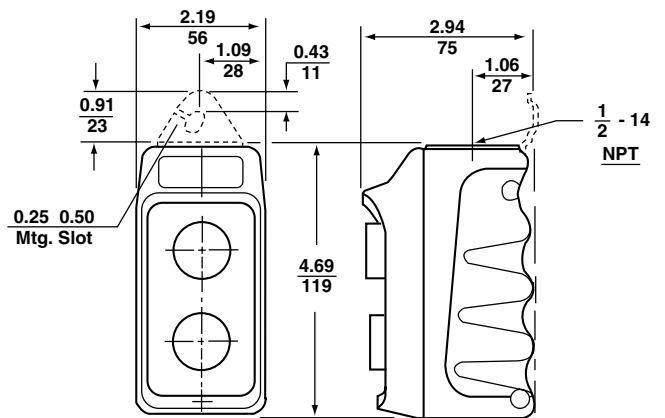

Type BW70B through Type BW82Y

Dual Dimensions: Inches
mm

Push Button and Operator Interface - Type BW, SKYP & XACA Pendant Stations

Type BW Pendant Stations — Application Data and Order Information

The Class 9001 BW70 and BW80 pendant stations are used for hoist applications, requiring either single speed or two speed buttons. The thermoplastic enclosure is provided with a 1/2 inch conduit entrance at top to accept a pendant cable and has internal strain relief provided as standard. The stations are rated NEMA Type 1, 3, 3R, 4 and 4X. The enclosure is available in three colors. All universal stations have double circuit blocks (1 N.O. — 1 N.C.) on each button and come without legends so they can be assembled to fit the application. For convenience, push buttons have interchangeable legend inserts. The complete line is UL listed and C.S.A. certified.



No. of Units	Description	Legend Insert Markings	Mechanical Interlock	Enclosure Color			Contact Symbol	Replacement Interior	
				Yellow	Black	Red		9001 Type	Contact Symbol
2	Single Speed	Up-Down	Yes	BW72Y	BW72B	BW72R	146	BOC368	146
		Forward-Reverse	Yes	BW73Y	BW73B	BW73R	146	BOC368	146
		On-Off ▲	Yes	BW74Y	BW74B	BW74R	10	BOC358	147
		Start-Stop	No	BW75Y	BW75B	BW75R	145	BOC359	25
		Start-Stop ▲	Yes	BW76Y	BW76B	BW76R	10	BOC358	147
		On-Off	No	BW77Y	BW77B	BW77R	146	BOC359	25
		On-Off	No	BW79Y	BW79B	BW79R	145	BOC359	25
		Up-Down	Yes	BW78Y	BW78B	100
		W/O Legend Inserts	Yes	BW70YU	BW70BU	BW70RU	25	BOC366	25
		W/O Legend Inserts	No	BW71YU	BW71BU	BW71RU	25	BOC359	25
Two Speed	W/O Legend Inserts ▲	Yes	BW74YU	BW74BU	BW74RU	147	BOC358	147	
		Yes	BW80YU	BW80BU	BW80RU	150	BOC367	150	
		Up-Down	Yes	BW82Y	BW82B	BW82R	150	BOC367	150

▲ Maintained contact

Interchangeable Push Button Legend Inserts

Marking	For NEMA / UL Type 4X Type BW70's and BW80's		Marking	Mushroom Button Inserts For NEMA / UL Type 4X Type BW70's and BW80's	
	Type	Type		Type	Type
Start	B259	B282	On Off Hand Auto Blank-Black Blank-Red	B257	B280
Stop	B260	B283		B258	B281
Forward	B255	B278		B265	B288
Reverse	B256	B279		B266	B289
Open	B263	B286		B251	B251
Close	B264	B287		B252	B252
Raise	B261	B284			
Lower	B262	B285			
Up	B253	B276			
Down	B254	B277			

Order must specify quantity of 10 or multiples of 10.

Legend Insert Kit – Kit includes one each of standard legend inserts as indicated below Type No. of kit.

Where Used:		Type
For NEMA Type 4X Type BW70's and BW80	Push Button	B250 (includes 1 each of B253 through B266)
	Mushroom Button	B300 (includes 1 each of B276 through B289)

Hanger Bracket (factory installed only)

Form
Y236



Addition of External hanger bracket (similar to the one used on Class 9001 Type SKYP Pendant Stations). Use when polymeric cord connectors are required.

Hanger Bracket and Seal Kit

Type
B350



Contact Symbol

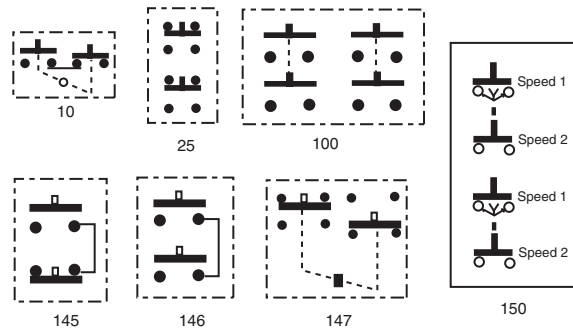

File E42259
CCN NKCR



File LR 25490
Class 3211 03



Marking

Replacement Enclosures 9001BW70'S and 9001BW80'S

Description	Yellow	Red	Black
Box and cover with four screws	BWRY	BWRR	BWRB

Screws not included. Order quantity 4 of a 21930-14281 for the screws.

Mushroom Button (less button insert) – For NEMA / UL Type 4X, BW70 and BW80

Color	Type
Red	B303

For Dimensions Page 195

Push Button and Operator Interface - Type BW, SKYP & XACA Pendant Stations SERIPLEX Control Bus Version 2 — Material Pull Pendant Station

The **Material Pull Pendant Stations** provide an interface between the SERIPLEX® control bus and a single input push button operator enclosed in a pendant station. Single-bit bus interface circuitry is used in this unit. If multiplexed operation is used by the CPU interface card, the pendant is scanned every frame. This pendant is not capable of being multiplexed.

Features

- Durable enclosure rated NEMA Type 12.
- Bus powered lamp modules don't require an auxiliary power supply or additional power conductors.
- Bus powered lamp modules use high visibility, low current consumption LED lamps, providing long life and greater system flexibility.
- Mini-style quick-change connectors provide for easy pendant installation and change out.
- LED indicators provided on the SERIPLEX module show power-on status, input status and output status – a convenient installation and troubleshooting aid.

About Material Pull Systems

A SERIPLEX Material Pull Pendant is used to control the floor stock of parts being installed during a final assembly operation. Typically, as an assembly worker uses parts they monitor the stock of material being used. When stock falls to a predetermined level, the assembly worker pushes the button on the Material Pull Pendant and a signal is sent to the computer requesting parts for that specific assembly operation. The illuminated push button in the pendant flashes to indicate the location where the parts are needed and a lift truck driver is dispatched with the parts. The lift truck driver presses the pendant push button to indicate that the parts have been delivered and to reset the system.

Catalog Number	Input Type Address A	Input Type Address B	Output Type Address B	Description
SPXBWPEND5	—	N.O.	LED Lamp - Amber	Pendant enclosure, single illuminated push button, bus powered amber LED lamp, 5-pin mini-style quick change connector
9001 AEQ3370	—	N.O.	LED Indicator - Red	Pendant enclosure, single non-illuminated push button, red LED indicating lamp inserted in bottom of pendant, 5-pin mini-style quick change connector

Electrical Specifications

Voltage: 24 Vdc
Capacitance: 75 pF (typical)
Max Current: 20 mA

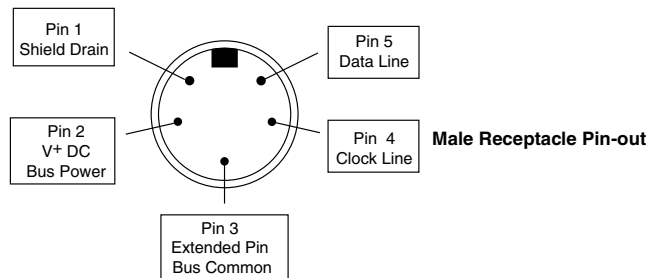

Dimensions (SPXBWPEND5 only)

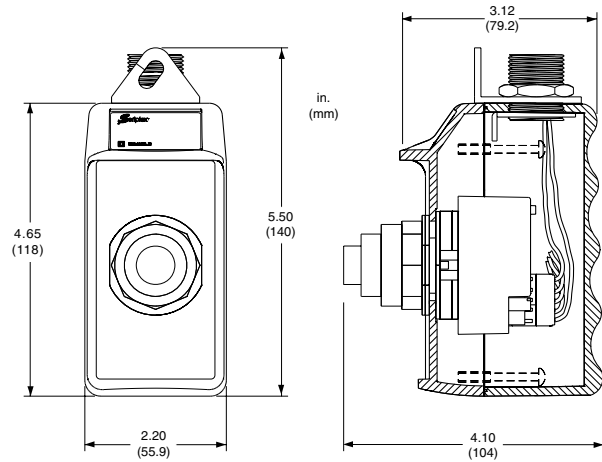

Pendant connector receptacle: Torque nut to 23 - 27 lb-in.
Pendant enclosure screws: Torque screws to 15 lb-in.
Operator ring nut: Torque 6 - 8 lb-ft.

Note: Gasket must be in place to maintain enclosure rating.

Replacement Parts

Part Number	Description
SPXLEDA1	LED Lamp - Amber
9001AE50	BW Pendant Hanger Bracket
9001A1	Push button Lens - Amber
Hand-Held Set-Up Tool Adapter Cable for 5-Pin Mini-style Connectors	

Internal Wiring to SERIPLEX Module

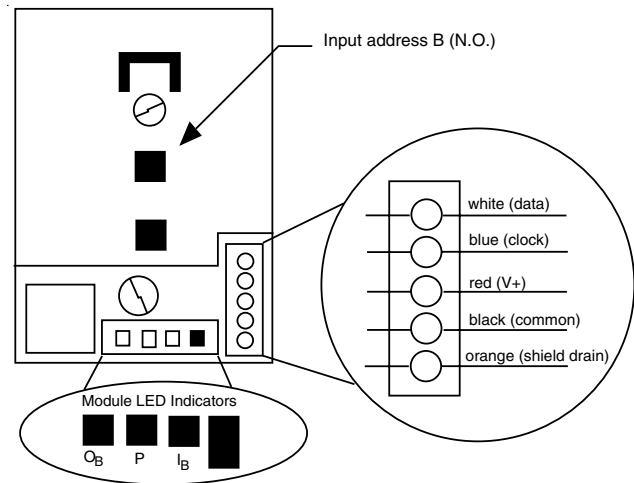

LED	Color	Function and Address
I _B	yellow	Input B Active
P	green	Bus Power Applied
O _B	yellow	Output B Active

For additional information, see catalog 8330CT9601R4/99.

Push Button and Operator Interface - Type BW, SKYP & XACA Pendant Stations

Type XACA Pendant Stations — Specifications

XAC pendant stations are designed for standard or medium duty control circuit applications. The enclosures are made from rugged, double insulated thermoplastic material. These stations have been designed for easy handling and operation, even with heavy work gloves.

Two styles of stations are offered; “small hoist” pistol grip stations with integral parts (see page 199), and “general purpose” station components with modular assembly required. The general purpose components are available as custom factory assembled stations. For custom applications, a wide range of operators, contact blocks, legend plates and accessories are offered.





XACA08
(Shown with optional operators and accessories)

Features

- 1 and 2 speed versions
- Double insulated
- Shock and corrosion resistant
- 2, 4, 6, 8, 12 element versions
- Ease of operation

Applications

- Overhead cranes
- Tower cranes
- Fixed hoists
- Beam hoists

Specifications	
Electrical ratings	NEMA / UL A600, Q600
Enclosure	XACAO* NEMA / UL Type 4, 4X (Indoor/Outdoor), 5 IP 65
	XACAO* (Pistol grip) NEMA / UL Type 4, 4X (Indoor), 5 IP 65
Operating temperatures	-15 °C to +70 °C -5 °F to +158 °F
Housing	Yellow polypropylene
Storage temperatures	-40 °C to +70 °C -40 °F to +158 °F
Shock resistance	100 g
Vibration resistance	15 g for f = 40 to 500 Hz
Mechanical life	1 million operations (The product life expressed is based on average usage and normal operating conditions. Actual operating life will vary with conditions. The above statements are not intended to nor shall they create any express or implied warranties as to product operation or life. For information on the limited warranty offered on this product, please refer to Square D terms and conditions of sale found in the Square D Digest.)
Operating force	XACA Multi-element types -with contact ZB2BE: 1 daN (36 oz.) for 1N.O., 1.3 daN (46.8 oz.) for 1N.O./1N.C. -with contact XENG1491: 1.4 daN (50.4 oz.) for 1N.C./2N.O. -with contact XENG1191: 1.4 daN (50.4 oz.) for 1st step, 2.5 daN (89.9 oz.) for 2nd step
Cable entry	XACD - 7 to 18 mm All other models - 8 to 26 mm
Cabling	Screw and captive cable clamp terminals. Recommended torque 15.62 in lbs. Capacity: minimum 1 x 0.5 mm ² (20 AWG) solid or stranded, maximum with or without cable end: 2 x 1.5 mm ² (16 AWG) or 1 x 2.5 mm ² (14 AWG) or by cable quick connector conforming to NF C 20-20 (on request).
Approvals	 File E164353 CCN NKCR
	 File LR 44087 Class 3211 03
	 Marking

UV PROTECTED
FOR OUTDOOR USE

Push Button and Operator Interface - Type BW, SKYP & XACA Pendant Stations

Type XACA Pendant Stations — Standard Duty



XACA2013



XACA06



XACA03

(Shown with optional operator)



ZB2BE10



XENG37



XENG1191



XACS10

Pistol grip stations

Description	Speeds	Function 1 Speed / 2 Speed	Catalog Number
1 N.O. contact per operator 2 Mechanically interlocked operators	1	↕	XACA201▲
2 N.O. (staggered) contacts per operator 2 Mechanically interlocked operators	2	↕↕	XACA207▲
1 N.O. + 1 N.C. 2 Mechanically interlocked operators	1	↕	XACA205▲
1 N.O. contact per direction 1 Mechanically interlocked 2 way toggle	1	↕	XACD21A0101
1 N.O. + N.O. staggered 1 Mechanically interlocked 2 way toggle	2	↕↕	XACD21A1231
1 N.O. & 1 N.C. contact per direction 1 Mechanically interlocked 2 way toggle	1	↕	XACD21A0105
1 N.C. + 1 N.O. + 1 N.O. staggered 1 Mechanically interlocked 2 way toggle	2	↕↕	XACD21A1241

▲ These XAC units are available with factory installed E-stops. Add a "3" to the end of the catalog number for standard E-stop or add a "4" for a "Trigger Action" E-stop.

General purpose pendants*

Enclosures	Catalog Number
2 hole enclosure	XACA02
3 hole enclosure	XACA03
4 hole enclosure	XACA04
6 hole enclosure	XACA06
8 hole enclosure	XACA08
12 hole enclosure	XACA12

* Standard enclosures include internal mounting plate, cable sleeve for 8 to 26 mm, internal cable clamp, suspension ring and cable tie.

Contact Blocks For Operators In Cover

Description	Wiring Diagram	Catalog Number
1 N.O./spring return/1 speed	—	ZB2BE101
1 N.C./spring return/1 speed	—	ZB2BE102
1 N.O. early close & 1N.C.&1N.O./spring return/2 speed	Fig. 1	XENG1191
1 N.C. & 2 N.O./spring return/1 speed	Fig. 2	XENG1491
1 N.O. & 1 N.O. latching/1 speed/interlocked	Fig. 3	XENG3781
1 N.O. & 1 N.C. latching/1 speed/interlocked	Fig. 4	XENG3791

For operators in base of enclosure†

1 N.O./1 speed	XACS101
1 N.C./1 speed	XACS102
2 N.O./1 speed	XACS103
2 N.C./1 speed	XACS104
1 N.O. & 1 N.C./1 speed	XACS105

† Cannot be used with XACA03 pendant.

Wiring diagrams

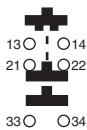

Fig. 1

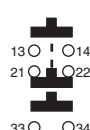

Fig. 2



Fig. 3



Fig. 4

Push Button and Operator Interface - Type BW, SKYP & XACA Pendant Stations

Type XACA Pendant Stations — Contact Blocks



Booted push button



Mushroom head



Selector switch



Selector switch
(key operated)



Wobble stick

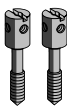

XACB961

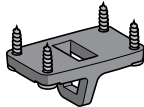

XACA971

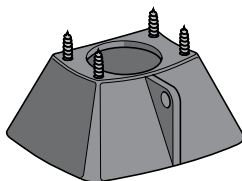

XACA982

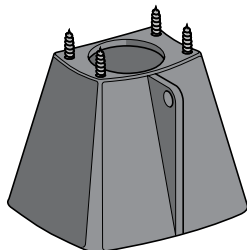

XACA983

Operators▲

Description	Color	Catalog Number	
Booted push button	White	XACA9411	
	Black	XACA9412	
	Green	XACA9413	
	Red	XACA9414	
	Yellow	XACA9415	
	Blue	XACA9416	
	Brown	XACA9419	
Description	Mushroom Size	Color	Catalog Number
Mushroom head, momentary	30 mm	Black	ZA2BC24
		Red	ZA2BC44
Mushroom head, momentary	40 mm	Black	ZA2BC2
		Red	ZA2BC4
Mushroom head, push to maintain/turn to release	30 mm	Red	ZA2BS44
		Red	ZA2BS54
Mushroom head, push to maintain/turn to release (trigger action)*	30 mm	Red	ZA2BS834
		Red	ZA2BS844
Mushroom head, push to maintain/key turn to release	30 mm	Red	ZA2BS74
		Red	ZA2BS14
Mushroom head, push to maintain/key turn to release (trigger action)*	40 mm	Red	ZA2BS844
		Red	ZA2BS14
Description	Color	Catalog Number	
Selector switch/2 position - maintained**	Black	ZA2BD2	
Selector switch/3 position - maintained**	Black	ZA2BD3	
Selector switch/2 position - maintained key operated - key removal from left or right position**	NA	ZA2BG4	
Selector switch/3 position - maintained key operated - key removal from left or right position**	NA	ZA2BG5	
Wobble stick (bottom mounting recommended)	Black	ZA2BB2	
	Red	ZA2BB4	

Pilot light components

Description	Color	Catalog Number
Direct supply base/without lamp (for 6 to 120 V applications) (AC/DC)		ZB2BV006
Resistor supply base/with 130 V lamp (for 220-240 V applications) (AC/DC)		ZB2BV007
Pilot light operators for incandescent lamps	Green	ZA2BV03
	Red	ZA2BV04
	Amber	ZA2BV05
	Blue	ZA2BV06
	Clear	ZA2BV07
Pilot light operators for LED lamps	Green	ZA2BV033
	Red	ZA2BV043
	Amber	ZA2BV053

▲ Booted push buttons are for cover mounting only. All other operators can be mounted on cover or bottom.

* Trigger action mushroom heads are "tamper proof" whereby a change of contact state is not possible by "teasing" or floating the operator.

** Not for use with XEN G contact blocks.

Enclosure Accessories

Description	Catalog Number
Blank hole plug	ZB2SZ3
Mechanical interlock (momentary). For use with XAC booted operators only	XACA009
Adapter for self-supporting cable	XACB961
Low suspension ring for single row station	XACA971
Protective guard for bottom mounted mushroom head	XACA982
Protective guard for bottom mounted selector switch or key switch	XACA983
Cable sleeve (XACA20●)	XACA913
Cable sleeve (XACA●●)	XACA960

Push Button and Operator Interface - Type BW, SKYP & XACA Pendant Stations

Type XACA Pendant Stations

Exploded Drawing

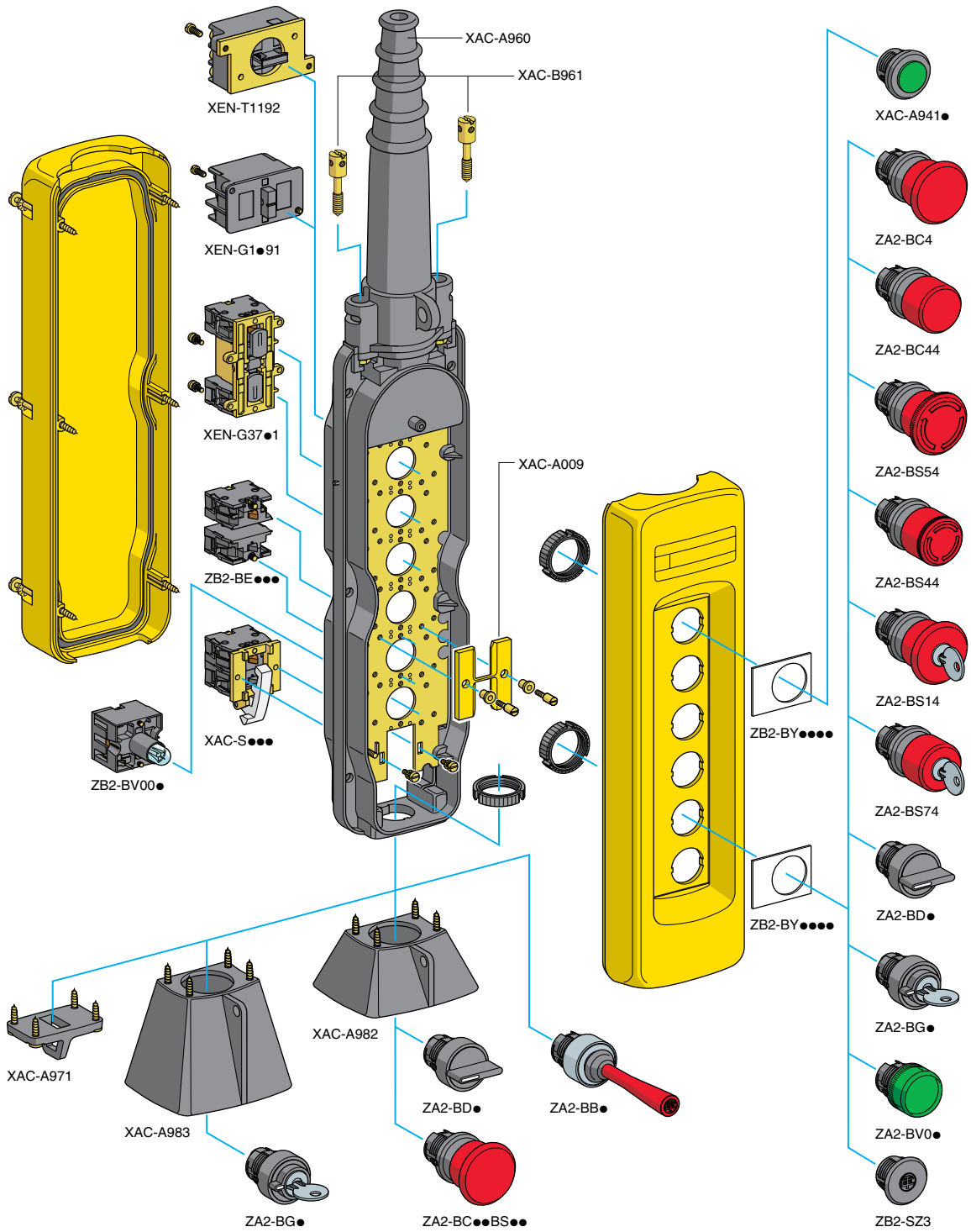

30075-16

Push Button and Operator Interface - Type BW, SKYP & XACA Pendant Stations

Type XACA Pendant Stations — Lamps and Legend Plates

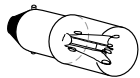

DL1CE0
(Incandescent)**

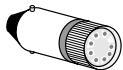

DL1CJUS**
(LED)**

Lamps

Type	Voltage (AC/DC)	Watts	Catalog Number
Replacement bulbs (Type BA9s) Incandescent	6	1.2	DL1CB006
	12	2.0	DL1CE012
	24	2.0	DL1CE024
	48	2.4	DL1 CE048
	130	2.6	DL1CE130
Neon (use with direct supply light module)	120	-	NE51HRT120V
	220	-	NE51HRT220V
	380	-	NE51HRT380V

Type	Color	Voltage	Part Number
LED, BA9s base for Direct Supply blocks	Green	6 volt ac/dc	DL1CJUS0063
	Red	6 volt ac/dc	DL1CJUS0064
	Amber	6 volt ac/dc	DL1CJUS0065
	Green	12 volt ac/dc	DL1CJUS0123
	Red	12 volt ac/dc	DL1CJUS0124
	Amber	12 volt ac/dc	DL1CJUS0125
	Green	24 volt ac/dc	DL1CJUS0243
	Red	24 volt ac/dc	DL1CJUS0244
	Amber	24 volt ac/dc	DL1CJUS0245
	Green	120 volt ac/dc	DL1CJUS1203
	Red	120 volt ac/dc	DL1CJUS1204
	Amber	120 volt ac/dc	DL1CJUS1205

PVC Standard legend plates 30 x 40mm

Text ★	Catalog number
Bridge Forward	ZB2BY2343
Bridge Reverse	ZB2BY2344
Close	ZB2BY2314
Down	ZB2BY2308
Emergency Stop	ZB2BY2330
Fast	ZB2BY2328
Forward	ZB2BY2305
For Rev	ZB2BY23
For-O-Rev	ZB2BY2384
Hand Off Auto	ZB2BY2387
High	ZB2BY2338
High Low	ZB2BY2369
Hoist Down	ZB2BY2342
Hoist Up	ZB2BY2341
In	ZB2BY2503
Inch	ZB2BY2321
Jog For	ZB2BY2381
Jog Rev	ZB2BY2380
Jog Run	ZB2BY2365
Left	ZB2BY2310
Low	ZB2BY2336
Lower	ZB2BY2337
Man Auto	ZB2BY2372

Text ★	Catalog Number
Off	ZB2BY2312
On	ZB2BY2311
Off On	ZB2BY2367
Open	ZB2BY2313
Open Close	ZB2BY2376
Open-O-Close	ZB2BY2388
Out	ZB2BY2339
Power On	ZB2BY2326
Raise	ZB2BY2335
Reset	ZB2BY2323
Reverse	ZB2BY2306
Right	ZB2BY2309
Run	ZB2BY2334
Slow	ZB2BY2327
Start	ZB2BY2303
Stop	ZB2BY2304
Stop Start	ZB2BY2366
Trolley Right	ZB2BY2345
Trolley Left	ZB2BY2346
Up	ZB2BY2307
Up Down	ZB2BY2370
Up-O-Down	ZB2BY2389



★ All nameplates are black w/white lettering except "Stop", "Emergency Stop" and "Reset" which are red w/white lettering.
For black "Reset" change final digit of catalog number to 2.

Type	Description	Catalog Number
PVC blank legend	Blank	Black or red background-30 mm x 40 mm
	Blank	Yellow or white background-30 mm x 40 mm
PVC custom engraved	Special engraving †	Black background, white letters-30 mm x 40 mm
	Special engraving †	Red background, white letters-30 mm x 40 mm
	Special engraving †	White background, black letters-30 mm x 40 mm
	Special engraving †	Yellow background, black letters-30 mm x 40 mm

† Please specify lettering when ordering. Two lines with 11 characters (including spaces) maximum on each line.

Push Button and Operator Interface - Type BW, SKYP & XACA Pendant Stations

Type XACA Pendant Stations — Lamps and Legend Plates

XACA Order guide instructions

Custom built pendant stations

- The first step in putting together your pendant station is to determine the number of operators that you require. This enables you to choose the enclosure based on the number of holes needed.
- Select the type of operator, contact block and appropriate nameplate for each function required from pages 199-202. Enter the components for each function on the order form below.
- Check for special functions that may be required. These items could include mechanical interlocks, adapters for self-supporting cable, lower support rings, protective guards etc.

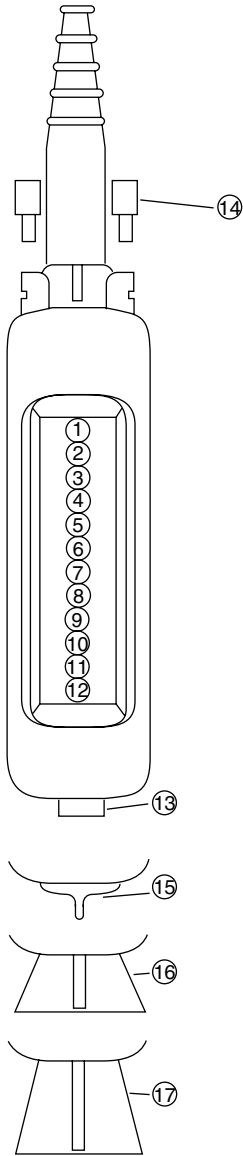

TO BE COMPLETED BY SQUARE D

Name		Branch/Sales office	
Date	Order No.	Delivery date	

TO BE COMPLETED BY CUSTOMER

Firm		Sheet No.	
Date	Cust. Order No.	Delivery date	

No. of identical units required Unit reference of enclosure **XACA**

Functions (optional)	Mechanical interlock (draw a line between the 2 units to be interlocked★)	Legends	Contact blocks and pilot light bodies	push button pilot light or blanking plug
1				
2				
3				
4				
5				
6				
7				
8				
9				
10				
11				
12				

★ Mechanical interlock XACA009 Number of XAC A009 required

Unit mounted in base of station (facing downwards)

13				
----	--	--	--	--

* Mechanical interlock

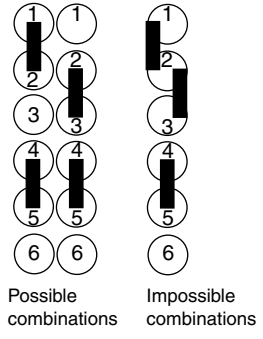

Attachments

	Position	Type	Catalog No.
Cross the appropriate box if required	14	Adapters for self supporting cable type BBAP (only available with 8 to 26 mm dia. cable sleeve)	XACB961
	15	Lower support ring	XACA971
	16	Protective guard for base mounted selector switch or 40 mm emergency stop push button	XACA982
	17	Protective guard for key switch	XACA983

Photocopy this form and complete all information.

Push Button and Operator Interface - Type BW, SKYP & XACA Pendant Stations

Type XACA Pendant Stations — Dimensions

Small hoist type
XACA201 and A205

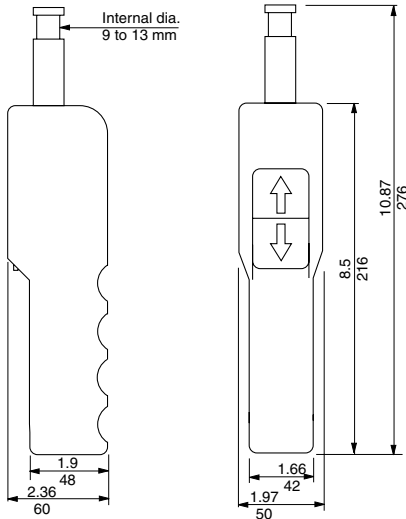

General purpose type
XACA●●●●

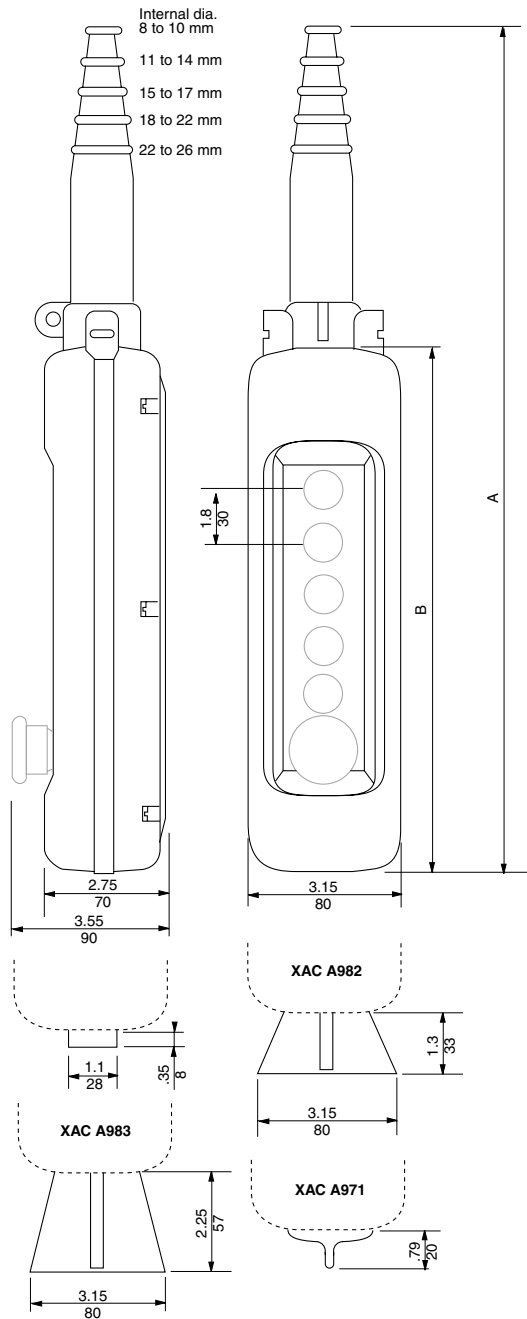

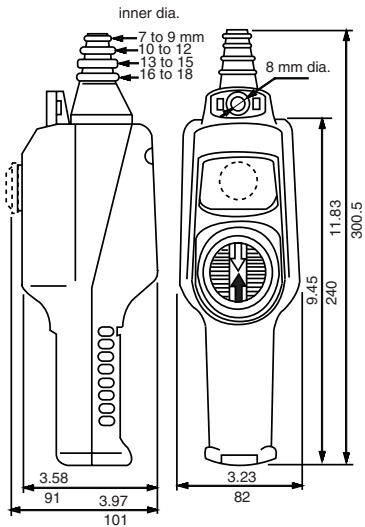

Small hoist
XACD



No. of Holes IN/mm	2		3		4		6		8		12	
	IN	mm	IN	mm	IN	mm	IN	mm	IN	mm	IN	mm
A	15.00	380	15.00	380	17.33	440	19.70	500	22.10	560	26.78	680
B	7.50	190	7.50	190	9.85	250	12.20	310	14.57	370	19.30	490

Push Button and Operator Interface - Type BW, SKYP & XACA Pendant Stations

Type SKYP Pendant Stations — Specifications

Specifications	
Electrical ratings	Types SKRU2 - SKRU5: AC - Nema / UL B300 DC - Nema / UL P600 Types SKRU1, 10, 11: AC - Nema / UL A600: DC - Nema / UL P600
Enclosure type	UL Type 1, 3, 3R, 4, 4X, and 13
Operating temperature	- 30 °C to + 60 °C - 13 °F to + 140 °F
Housing material	Polycarbonate
Storage temperature	- 40 °C to + 70 °C - 40 °F to + 158 °F
Cable entry	1/2 inch NPT
Approvals	 File E42259 CCN NKCR  File LR 25490 Class 3211 03  Marking

Electrical Contact Ratings (Types SKRU2 Through SKRU5)*

AC – NEMA / UL Type B300						
Volts▲	Inductive 35% Power Factor				Continuous Carrying Amperes	Resistive 75% Power Factor Make, Break and Continuous Carrying Amperes
	Make		Break			
	Amps	VA	Amps	VA		
120	30	3600	3	360	5	5
240	15	3600	1.5	360	5	5

Electrical Contact Ratings (Types SKRU1, 10 and 11)*

AC – NEMA / UL Type A600					DC - Standard Duty - NEMA / UL P600		
Volts*	Inductive 35% Power Factor			Resistive 75% Power Factor	Volts	Inductive and Resistive	
	Make Amperes	Break Amperes	Continuous Carrying Amperes			Make, Break and Continuous Carrying Amperes	Make and Break Amperes
120	60	6	10	10	120	1.1	10
240	30	3	10	10	240	0.55	10
480	15	1.5	10	10	600	0.2	10
600	12	1.2	10	10			

▲ OSHA Regulation, Section 1910.170 Overhead and Gantry Cranes, limits the voltage at pendant push buttons to 150 Vac or 300 Vdc.

Push Button and Operator Interface - Type BW, SKYP & XACA Pendant Stations

Type SKYP Pendant Stations — Application Data and Order Information

This line of pendant stations consists of polymeric enclosures (2 through 10 units), push button units (1 through 5 speed) and laminated legend plates. All enclosures have an extra single unit space near the top which permits the installation of a toggle switch ①, a Type SK operator or pilot light ② or a warning label. All enclosures come with a stainless steel hanger bracket and internal strain relief post, as standard. Enclosures are yellow and have a threaded opening in the top. The complete line is UL Listed and CSA Certified with NEMA Type environmental ratings 1, 3, 4, 4X and 13.

Enclosures

Size	Conduit Entrance Size	Enclosure Only▲	Enclosure For Assembled Station●
		Type	Type
2 Button	3/4"-14 NPT	SKYP2	SKYP20
4 Button	3/4"-14 NPT	SKYP4	SKYP40
6 Button	1"-11 1/2 NPT	SKYP6	SKYP60
8 Button	1 1/4"-11 1/2 NPT	SKYP8	SKYP80
10 Button	1 1/4"-11 1/2 NPT	SKYP10	SKYP100

▲ Class 9001 SK push-to-test pilot lights and remote test pilot lights will not fit in these enclosures.

● Assembled pendant stations consist of an enclosure, operators and legend plates. The price of the total station consists of the prices of the individual components - there is no charge for assembly. All custom orders must include the pendant key sheet available as shown on page 209.

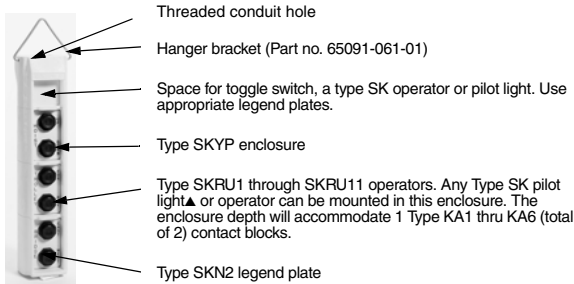

Push Button Units

Number of Buttons Per Unit	Description	Contact Symbol – See Below	Type*
2	Single Speed – Momentary Interlocked	7	SKRU1
2	Single Speed – Momentary Non-Interlocked	5	SKRU10
2	Single Speed – Maintained Interlock	10	SKRU11
2	Two Speed – Momentary Interlocked	87	SKRU2
2	Three Speed – Momentary Interlocked	88	SKRU3
2	Four Speed – Momentary Interlocked	89	SKRU4
2	Five Speed – Momentary Interlocked	90	SKRU5

* Types SKRU 1, 10 and 11 use Type KA contact blocks. Types SKRU 2 thru 5 are factory enclosed contact blocks.

Multispeed Contact Symbols ("X" = Contact Closed)

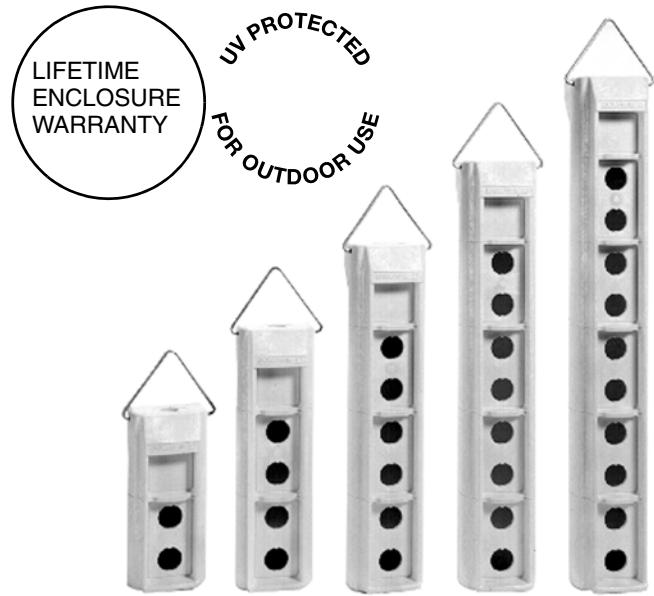
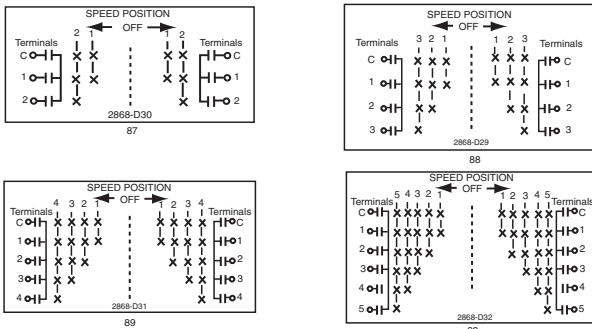

Legend Plates

	Where Used	Marking	Type
	For SKRU1 through SKRU11	Blank-Blank Hoist: Up-Down Trolley: East-West Trolley: Fwd.-Rev. Trolley: North-South Bridge: Fwd.-Rev. Bridge: East-West Bridge: North-South Start-Stop Reset-Stop Aux Hoist: Up-Down Power: On-Off Specify Marking	SKN200⑤ SKN201 SKN202 SKN203 SKN204 SKN205 SKN206 SKN207 SKN208 SKN209 SKN210 SKN211 SKN299⑤
	With Toggle Switch① in Top Space of Enclosure	Blank Off-On On-Off Specify Marking	SKN500③ SKN544③ SKN545③ SKN599③
	With Type SK Operator or Pilot Light② in Top Space of Enclosure	Blank On Off Emerg. Stop Run Power On Off-On Specify Marking	SKN100④ SKN103 SKN104 SKN105 SKN124 SKN138 SKN144 SKN199④

① Can be supplied by Square D as Class 9001 Type SKSTS1 - includes boot for NEMA Type 4X.

② See Class 9001 Type SK on page 207.

③ Includes legend plate, gasket and ground plate to be used with toggle switch.

④ Tri-laminated legend plate having a yellow or red background on a black core.

⑤ 19 characters each side max.

Closing Plate

	Type
	SK52

Single Speed Contact Symbols

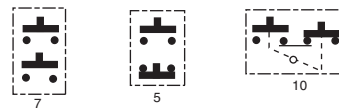

Dimensions Page 208
Key Sheet for Custom Assembled Pendant Page 209

Push Button and Operator Interface - Type BW, SKYP & XACA Pendant Stations Type SK Pendant Stations — Application Data and Order Information

Non-illuminated

	Description	Color	Catalog
	2 Position	Red	SKR9R
	Maintained Pull	Red (1)	SKR9R05
Maintained Push	(2)	SKR9 (2)	

(1) Red knob available with "Push Emergency Stop" printed on the red knob.
See note (3) below for additional options.

Color	(2) Other Color Codes
Black	B ▲
Red	R
Green	G
Blue	L
Yellow	Y
White	W ▲
Orange	S
Clear	C
Amber	A





▲ These colors are not available on illuminated push buttons.

Illuminated

	Description	Color	Voltage	Catalog
	2 Position	Red	120 Vac/dc - Full Voltage	SKR9P58R
	Maintained Pull	Red (1)	24 Vac/dc - Full Voltage	SKR9P55R05
Maintained Push	(2)	24 Vac/dc - Full Voltage	SKR9P55 (2)	

(1) Red knob available with "Push Emergency Stop" printed on the red knob.
See note (3) below for additional options.

Contact Blocks (3)

Description	Symbol	Catalog
 (Clear Cover)		KA1
 (Red Cover)		KA3

Both N.C. contacts are direct opening. 

Shallow Depth Light Modules For Type SK Control Units

- UL Listed and CSA Certified
- LED light modules use lamp with 7 element LED cluster that provides illumination similar to incandescent illumination.
- LED light modules require the color cap color and the LED color be the same or use a clear color cap.

	Voltage	Description	For Use With Single Lamp Ill. Operators as Indicated ①	Light Module Type No.	Voltage Assembly Code	Rating	Replacement Lamps	
							Lamp Number (ANSI)	Lamp Part Number
	24-28 Vac-dc	Full Voltage	All	KM55	55	1.2 VA	757	2550101002
	24-28 Vac-dc	LED Red	All	KM55LR	55LR	0.5 VA		6508805204
	24-28 Vac-dc	LED Green	All	KM55LG	55LG	0.5 VA		6508805206
	24-28 Vac-dc	LED Yellow	All	KM55LY	55LY	0.5 VA		6508805205
	110-120 Vac-dc	Full Voltage	All	KM58	58	3.0 VA	120MB	2550101027
	110-120 Vac-dc	LED Red	All	KM58LR	58LR	0.5 VA		6508805204
	110-120 Vac-dc	LED Green	All	KM58LG	58LG	0.5 VA		6508805206
	110-120 Vac-dc	LED Yellow	All	KM58LY	58LY	0.5 VA		6508805205

① 9001 SK

Maximum Current Ratings For Control Circuit Contacts – Types KA1-KA6, KA21-25, KA31-35, KA1G-KA6G

Volts	AC						Volts	DC				
	Inductive (NEMA / UL Type A600) 35% Power Factor					Resistive 75% Power Factor Make, Break and Continuous Amperes		Inductive and Resistive (NEMA / UL Type P600)				
	Make		Break		Continuous Carrying Amperes			Make and Break				
	Amperes	VA	Amperes	VA		KA1		KA2 KA3	KA4	KA5 KA6	Continuous Carrying Amperes	
120	60	7200	6.0	720	10	10	125	1.1	1.1	1.1	1.1	10
240	30	7200	3.0	720	10	10	250	0.55	0.55	–	0.55	10
480	15	7200	1.5	720	10	10	600	0.2	0.2	–	0.2	10
600	12	7200	1.2	720	10	10						

(3) For additional Type SK push button operators (illuminated and non-illuminated), light modules, and contact blocks, see document 9001CT9601: 30mm Push Buttons Type K and SK. All illuminated push button operators must use a shallow depth light module listed above. Only standard pilot lights and non-illuminated selector switches can be used in Type SKYP enclosures.

Push Button and Operator Interface - Type BW, SKYP & XACA Pendant Stations

Type SKYP Pendant Stations — Dimensions



Approximate Dimensions

Units	"A" Dimensions		Conduit Opening
	Inches	mm	NPT
2	11.70	297	3/4" -14
4	16.03	407	3/4" -14
6	20.36	517	1" -11 1/2
8	24.69	627	1 1/4" -11 1/2
10	29.02	737	1 1/4" -11 1/2

Type SKYP

Class 9001 Type SK Push-To-Test Pilot Lights and Remote Test Pilot Lights **will not** fit in these enclosures. Standard Pilot Lights **will** fit in these enclosures. For illuminated operators, in the SKYP, the shallow depth light module (9001KM55 or 9001KM58) must be used.

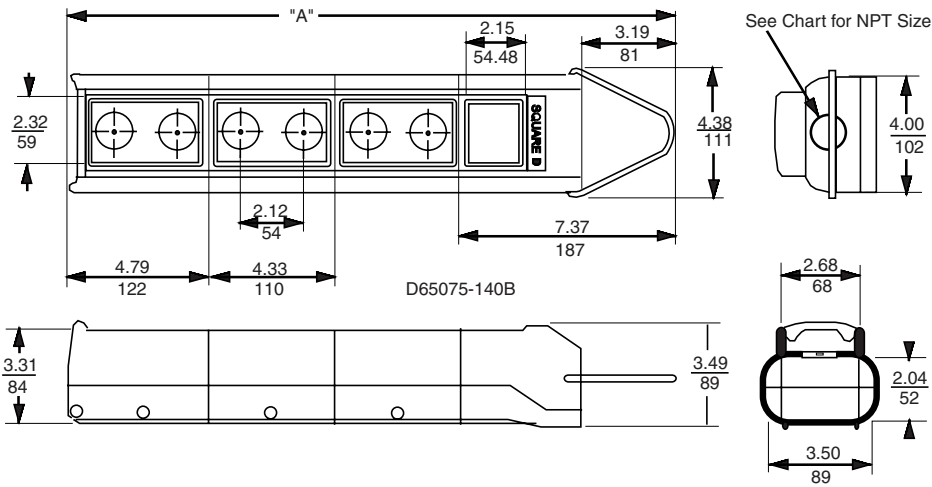

Type SKYP

Push Button and Operator Interface - Type BW, SKYP & XACA Pendant Stations

Type SKYP Pendant Stations — Order Form

	KEY SHEET FOR ORDERING CLASS 9001 TYPE SKYP ASSEMBLED PENDANT CONTROL STATIONS		
	CUSTOMER	CUSTOMER ORDER NO.	
	DATE	LIST PRICE EACH, DIB	QUANTITY

1. Operator or Closing Plate.
Example - SKRU1
2. Legend Plate Type Number
Example - SKN201
3. Legend Plate Marking ▲
– Used Only if Special Marking is Required
Example:
Line 2 - SKN299
Line 3 - A.) Hoist
B.) FWD
C.) REV

When operator and legend plate use 2 adjacent holes - specify same in both locations. Example:

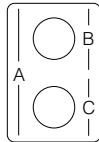

1	SKRU1
2	SKN201
3	

1	SKRU1
2	SKN201
3	

TYPE NUMBER KEY

Space for toggle switch ①, a Type SK operator or pilot light, or a warning label. Use SKN-5 or SKN-1 legend plates.

ENCLOSURES – NEMA 4X, 13

Size	Conduit Entrance Size	Enclosure for Assembled Station ▲
		Type
2 Button	3/4" -14 NPT	SKYP20
4 Button	3/4" -14 NPT	SKYP40
6 Button	1" -14 NPT	SKYP60
8 Button	1 1/4" -11 1/2	SKYP80
10 Button	1 1/4" -11 1/2	SKYP100

▲ Assembled pendant stations consist of an enclosure, operators, and legend plates. The price of the total station consists of the prices of the individual components – there is no charge for assembly.

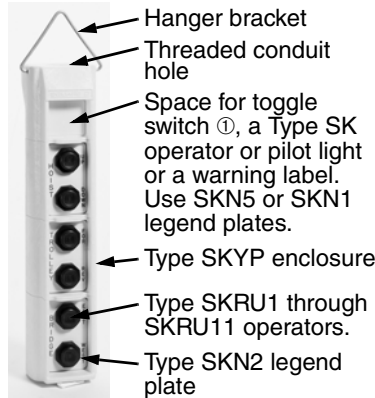

PUSH BUTTON UNITS – NEMA / UL 4X, 13

Number of Buttons per Unit	Description	Contact Symbol	Type
2	Single Speed - Momentary Interlocked	7	SKRU1
2	Single Speed - Momentary Non-Interlocked	5	SKRU10
2	Single Speed - Maintained Interlocked	10	SKRU11
2	Two Speed - Momentary Interlocked	87	SKRU2
2	Three Speed - Momentary Interlocked	88	SKRU3
2	Four Speed - Momentary Interlocked	89	SKRU4
2	Five Speed - Momentary Interlocked	90	SKRU5

CLOSING PLATE

Type
SK52

LEGEND PLATES – NEMA / UL 4X, 13

Where Used	Marking	Type
For SKRU1 through SKRU11	Blank-Blank	SKN200④
	Hoist: Up-Down	SKN201
	Trolley: East-West	SKN202
	Trolley: Fwd.-Rev.	SKN203
	Trolley: North-South	SKN204
	Bridge: Fwd.-Rev.	SKN205
	Bridge: East-West	SKN206
	Bridge: North-South	SKN207
	Start-Stop	SKN208
	Reset-Stop	SKN209
Specify Marking	SKN299④	
With Toggle Switch ① in Top Space of Enclosure	Blank	SKN500 ②
	Off-On	SKN544 ②
	On-Off	SKN545 ②
	Specify Marking	SKN599 ②
With Type SK Operator ▲ or Pilot Light in Top Space of Enclosure	Blank	SKN100 ③
	On	SKN103
	Off	SKN104
	Emerg. Stop	SKN105
	Run	SKN124
	Power On	SKN138
	Light	SKN144
	Off-On	SKN144
	Specify Marking	SKN199 ③
	Specify Marking	SKN199R ③
	(Red Background)	

- ① Can be supplied by Square D as 9001SKSTS1
- ② Includes legend plate, gasket and ground plate to be used with toggle switch.
- ③ Tri-laminated legend plate having a yellow or red background on a black core.
- ④ 19 characters each sides.
- ▲ Class 9001 Type SK Push-To-Test Pilot lights and Remote Test Pilot lights will not fit in these enclosures.

Push Button and Operator Interface - Type BW, SKYP & XACA Pendant Stations



Square D offers specialized control packages through the Modified Panels Group. Assemblies can be manufactured to meet your specific design criteria, incorporating special dimensions, enclosure types, and component makeup.

Specific control operator needs can be satisfied with products ranging from standard 30 mm push buttons to printed circuit board mounted pilot device assemblies.

In addition, Square D offers the widest variety of control products in numerous enclosure types to meet your electrical, environmental, and dimensional needs. Use of CAD designs, prototype assembly before production, and personalized service insures the product you receive will be exactly what you ordered...Guaranteed.

For additional information or receive a personalized proposal, contact your local Square D sales office.

Push Buttons and Operator Interface Specifier's Guide

XVB Illuminated Beacons and Indicating Banks

Catalog
2005

File 9001



CONTENTS

Description	Page
XVB General Information	212
XVB Characteristics	213
XVBL Beacons	214
XVBC Bank Components	215
XVB Accessories	216
XVB Wiring Diagrams	217
XVB Dimensions	217
XVDLS Miniature Beacons	219
Declaration of Conformity	221



Push Buttons & Operator Interface

XVB Illuminated Beacons & Indicating Banks / General Information

Illuminated Beacons

The complete unit includes the following:

- 1- A base.
- 2- A colored lens unit.

Additional accessories include:

- 3- A support tube.
- 4- Support tube concealment cover.
- 5- Tulip for use with tube for mounting on a horizontal surface.
- 6- Wall mounting bracket.
- 14 - Adaptor with cable gland, for cable size of 0.4 to 0.55 in (10 to 14 mm) diameter.

Stackable Indicating Banks

It may include the following:

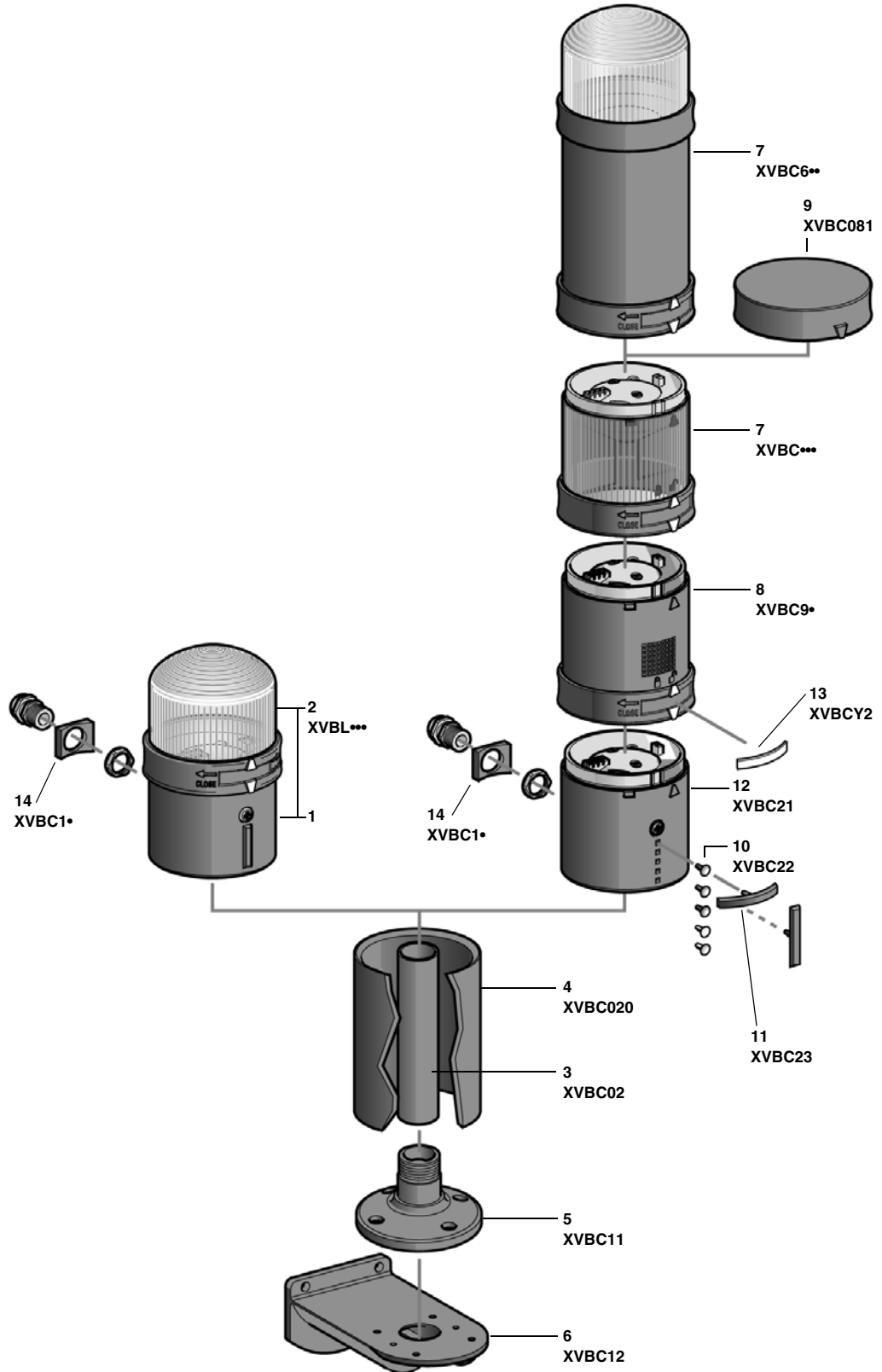

- 12- A base.
- 7- 1 to 5 colored lens units
- 8- Or 1 audible sounder unit.
- 9- A top cover, (except with a strobe).
- 3- Support tube.
- 4- Support tube concealment cover.
- 5- Tulip for use with tube for mounting on a horizontal surface.
- 6- Wall mounting bracket.
- 10- Colored markers.
- 11- Legend holders with legend.
- 13- Legends that attach to locking ring of individual signalling units for identification.
- 14- Adaptor with cable gland, for cable size of 0.4 to 0.55 in (10 to 14 mm) diameter.



Push Buttons & Operator Interface

XVB Illuminated Beacons & Indicating Banks / Characteristics

Environment

Approvals	Standard version, CSA, UL  File E164353 CCN NKCR  File LR 44087 Class 3211 03	UL E164353 CCN NKCR, CSA LR 44087 Class 3211 03
Conforming to standards	 CE Marked	IEC/EN 60947-5-1, UL 508, CSA 22.2 No. 14
Protective treatment		"TC"
Ambient air temperature		- 40 to + 158 °F (- 40 to +70 °C)
Storage		
Operation ■	Illuminated lens unit, steady	- 13 to + 158 °F (- 25 to +70 °C), with 10 W incandescent bulb - 13 to + 122 °F (- 25 to +50 °C), with LED
	Flashing units	- 13 to + 122 °F (- 25 to +50 °C), with 7 W incandescent bulb - 13 to + 104 °F (- 25 to +40 °C), with 10 W incandescent bulb - 13 to + 122 °F (- 25 to +50 °C), with LED
	Units with strobe	- 13 to + 122 °F (- 25 to +50 °C)
	audible sounder units	- 13 to + 122 °F (- 25 to +50 °C), with sounder
Electric shock protection conforming to IEC 536	Tube mounting	Class I
	Direct mounting on base unit	Class II
Degree of protection	To IEC 60529 and NF C 20-010 To UL 50 and CSA 22.2 No. 94	IP 65 Type 1, 4X (indoor), and 12
Material	Illuminated lens unit	Polycarbonate
	Base unit and top cover	Glass-reinforced polyamide and polycarbonate
	Tube	Stainless steel (matte black finish)
	Tulip	Zinc Alloy (matte black finish)

- When associating different elements such as steady or flashing, the maximum temperature is limited to that of the unit with the lowest temperature rating. Do not combine illuminated units with incandescent lamps and illuminated units with LED lamp in the same bank.

Electrical Characteristics

Rated insulation voltage (Ui)	Conforming to IEC 60947-1	250 V
Consumption	LED unit	
	Steady	24 Vac/dc: < 80 mA 120 - 230 Vac: < 30 mA
	Flashing	24 Vac or 24 Vdc: < 40 mA 120 - 230 Vac: < 15 mA
	Unit with strobe (on energization)	24 Vac or 24 Vdc: 5 Joule unit: < 430 mA; 10 Joule unit: < 850 mA 120 Vac: 5 Joule unit: < 130 mA; 10 Joule unit: < 260 mA 230 Vac: 5 Joule unit: < 105 mA; 10 Joule unit: < 210 mA
	Audible sounder units	12 - 48 Vac/dc: < 20 mA 120 - 230 Vac: < 50 mA
Rated impulse withstand voltage	Conforming to IEC 60947-1	U imp = 4 kV
Bulb type	Illuminated units, steady or flashing	Bayonet type BA 15d: minimum power 5 W, maximum power 10 W
Illuminating power	Strobe units	13 cds (integral high intensity tube) with clear lens unit: 5 Joule tube 26 cds (integral high intensity tube) with clear lens unit: 10 Joule tube
Audible sounder units	Continuous or intermittent signal	90 dB at 1 m
	Fundamental frequency	2.8 kHz
Terminal marking	Common	1 terminal marked "C"
	Depending on type of units	1 or 5 terminals marked 1 to 5
Cable size	Maximum wire size	1 x #16 AWG (1.5 mm ²) with cable end
Terminals		Screw and captive cable clamp terminals Torque to 4.4 lb-in (0.5 N•m)
Frequency of illuminated units	Flashing units	1 Hz
	Strobe units	1 Hz

Push Buttons & Operator Interface

XVB Illuminated Beacons & Indicating Banks / XVBL Beacons



XVBL3•

Illuminated Beacons with Steady Light (2.75 in/70 mm diameter)

Description	Light Source and Voltage	Color	Catalog Number
Complete unit, includes: 1 lens unit 1 base unit (direct or tube mounting)	Bulb (10 W max) not included 250 V max	Green	XVBL33
		Red	XVBL34
		Orange	XVBL35
		Blue	XVBL36
		Clear	XVBL37
		Yellow	XVBL38



XVBL4B•

Illuminated Beacons with Flashing Light (2.75 in/70 mm diameter)

Description	Light Source and Voltage	Color	Catalog Number	
Complete unit, includes: 1 lens unit 1 base unit (direct or tube mounting)	Bulb (10 W max) not included 24 Vac 24 - 48 Vdc	Green	XVBL4B3	
		Red	XVBL4B4	
		Orange	XVBL4B5	
		Blue	XVBL4B6	
		Clear	XVBL4B7	
		Yellow	XVBL4B8	
		Bulb (10 W max) not included 48 - 230 Vac	Green	XVBL4M3
			Red	XVBL4M4
Orange	XVBL4M5			
Blue	XVBL4M6			
Clear	XVBL4M7			
Yellow	XVBL4M8			

For bulbs, see page 216.



**XVBL6B•
5 Joule**

Illuminated Beacons with 10 Joule Strobe (2.75 in/70 mm diameter)

Description	Light Source and Voltage	Color	Catalog Number ■	
Complete unit, includes: 1 lens unit 1 base unit (direct or tube mounting)	Strobe 24 Vac/dc	Green	XVBL8B3	
		Red	XVBL8B4	
		Orange	XVBL8B5	
		Blue	XVBL8B6	
		Clear	XVBL8B7	
		Yellow	XVBL8B8	
		Strobe 120 Vac	Green	XVBL8G3
			Red	XVBL8G4
Orange	XVBL8G5			
Blue	XVBL8G6			
Clear	XVBL8G7			
Yellow	XVBL8G8			
Strobe 230 Vac	Green		XVBL8M3	
	Red		XVBL8M4	
	Orange	XVBL8M5		
	Blue	XVBL8M6		
	Clear	XVBL8M7		
	Yellow	XVBL8M8		

■ For 5 Joule units, specify XVBL6**, instead of XVBL8**.

NOTE: There are no replacement lenses for strobes and illuminated beacons.



**XVBL8B•
10 Joule**

Push Buttons & Operator Interface

XVB Illuminated Beacons & Indicating Banks / XVBC Bank Components



XVBC3*



XVBC4**



XVBC8**
10 Joule

Illuminated Lens Units with Steady Light (2.75 in/70 mm diameter)

Description	Light Source and Voltage	Color	Catalog Number
Illuminated lens unit	Bulb (10 W max) not included 250 V max	Green	XVBC33
		Red	XVBC34
		Orange	XVBC35
		Blue	XVBC36
		Clear	XVBC37
		Yellow	XVBC38

Illuminated Lens Unit with Flashing Light (2.75 in/70 mm diameter)

Description	Light Source and Voltage	Color	Catalog Number	
Illuminated lens unit	Bulb (10 W max) not included 24 Vac 24 - 48 Vdc	Green	XVBC4B3	
		Red	XVBC4B4	
		Orange	XVBC4B5	
		Blue	XVBC4B6	
		Clear	XVBC4B7	
		Yellow	XVBC4B8	
		Bulb (10 W max) not included 48 - 230 Vac	Green	XVBC4M3
			Red	XVBC4M4
Orange	XVBC4M5			
Blue	XVBC4M6			
Clear	XVBC4M7			
Yellow	XVBC4M8			

For bulbs, see page 216.

Illuminated Lens Units with 10 Joule Strobe (2.75 in/70 mm diameter)

Description	Light Source and Voltage	Color	Catalog Number ■	
Illuminated lens units	Strobe 24 Vac/dc	Green	XVBC8B3	
		Red	XVBC8B4	
		Orange	XVBC8B5	
		Blue	XVBC8B6	
		Clear	XVBC8B7	
		Yellow	XVBC8B8	
		Strobe 120 Vac	Green	XVBC8G3
			Red	XVBC8G4
	Orange		XVBC8G5	
	Blue		XVBC8G6	
	Clear		XVBC8G7	
	Yellow		XVBC8G8	
	Strobe 230 Vac		Green	XVBC8M3
			Red	XVBC8M4
		Orange	XVBC8M5	
		Blue	XVBC8M6	
		Clear	XVBC8M7	
		Yellow	XVBC8M8	

■ For 5 Joule units, specify XVBC6**, instead of XVBC8**.

NOTE: There are no replacement lenses units for the XVBC strobe.

Push Buttons & Operator Interface

XVB Illuminated Beacons & Indicating Banks / XVBC Bank Components



XVBC9•

Audible Sounder Units (2.75 in/70 mm diameter)

Description	Supply Voltage	Catalog Number
Sounder unit 90 dB at 1 m Adjustable from 75 - 90 dB Continuous or intermittent modes	12 - 48 Vac/dc	XVBC9B
	120 - 230 Vac	XVBC9M



XVBC21
(cover not shown)

Base Units + Cover (for direct or tube mounting, 2.75 in/70 mm diameter)

Description	For use with	Type	Catalog Number
Base unit + cover for bottom or side cable entry	Banks	Standard	XVBC21



XVBC02

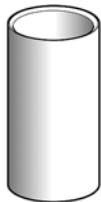

XVBC020

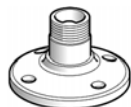

XVBC11

Accessories Common to Beacon and Indicating Banks

Description	Characteristics	Catalog Number		
Support tube	3.94 in (100 mm)	XVBC02		
	15.75 in (400 mm)	XVBC03		
	31.50 in (800 mm)	XVBC04		
Support tube concealment cover	3.94 in (100 mm)	XVBC020		
	15.75 in (400 mm)	XVBC030		
	31.50 in (800 mm)	XVBC040		
Mounting tulip	For mounting on tube XVBC0•	XVBC11		
Wall mount bracket	For direct mounting on base unit or with tulip XVBC11 + tube XVBC0•	XVBC12		
Incandescent bulbs bayonet type BA 15d, 10 W	12 Vac/dc	DL1BLJ		
	24 Vac/dc	DL1BLB		
	48 Vac/dc	DL1BLE		
	120 Vac/dc	DL1BLG		
	230 Vac/dc	DL1BLM		
Incandescent bulbs bayonet type BA 15d, 7 W	12 Vac/dc	DL1BEJ		
	24 Vac/dc	DL1BEB		
	48 Vac/dc	DL1BEE		
	120 Vac/dc	DL1BEG		
	230 Vac/dc	DL1BEM		
LEDs bayonet type BA 15d (sold singly)	24 Vac/dc	White	DL1BDB1	
		Green	DL1BDB3	
		Red	DL1BDB4	
		Blue	DL1BDB6	
		Yellow-orange	DL1BDB8	
		120 Vac	White	DL1BDG1
			Green	DL1BDG3
			Red	DL1BDG4
	Blue		DL1BDG6	
	Yellow-orange		DL1BDG8	
	230 Vac		White	DL1BDM1
			Green	DL1BDM3
			Red	DL1BDM4
		Blue	DL1BDM6	
	Adaptors for side entry through base unit	With CM12 (Pg 13.5) cable gland, for cable size of 0.4 to 0.55 in (10 to 14 mm) diameter	XVBC14	
		Conduit adaptor	1/2" NPT (for customer supplied tubing)	XVBC00

Accessories Specific to Indicating Banks

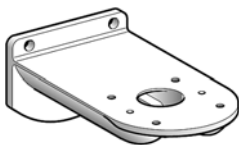

XVBC12

Description	Characteristics	Catalog Number
Set of colored markers	6 colors	XVBC22
Set of 5 legend holders	Identification of stacked units on base	XVBC23
Sheet of 85 legends for legend holder (XVBC23)	Identification of stacked units on base	XVBCY1
Sheet of 52 legends	Identification of stacked units on locking ring	XVBCY2
Replacement cap	For top of bank	XVBC081

Push Buttons & Operator Interface

XVB Illuminated Beacons & Indicating Banks / Wiring Diagrams & Dimensions

Wiring Diagrams, Base Units

Screw terminals
Torque to 4.4 lb-in (0.5 N·m)

2 x #16 AWG (1.5 mm²)
1 x #14 AWG (2.5 mm²)

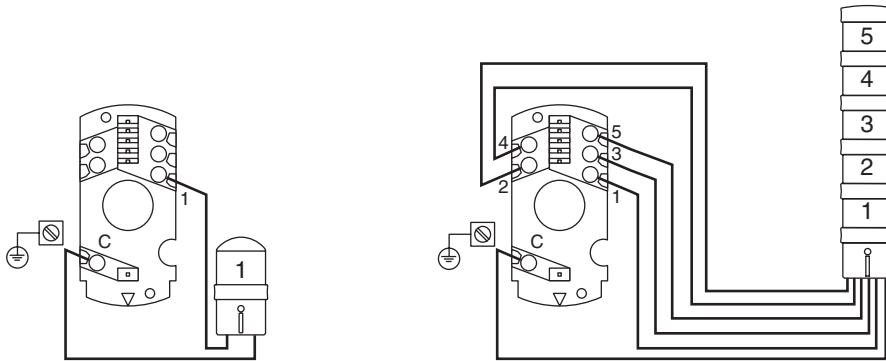

Illuminated Beacons XVBL***

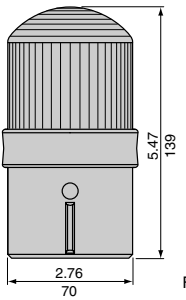

For bulb with bayonet type BA 15d or LED

Dual Dimensions $\frac{\text{inches}}{\text{mm}}$

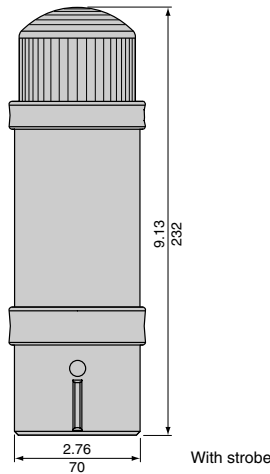

With strobe

Indicating Banks XVBC

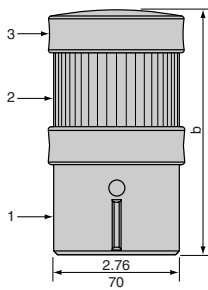

Without strobe
1 + 3 = Base unit + cover, XVBC21
2 Illuminated or audible sounder unit, XVBC***

Dual Dimensions $\frac{\text{inches}}{\text{mm}}$

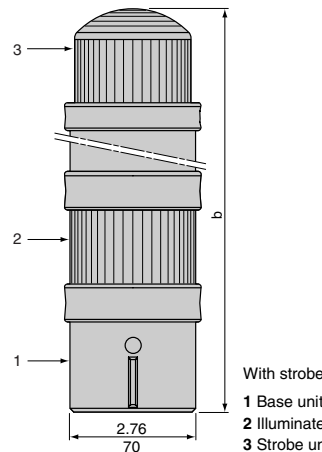

With strobe
1 Base unit
2 Illuminated or audible sounder unit, XVBC***
3 Strobe unit, XVBC***

Number of illuminated or audible sounder units (no strobe)	b inches (mm)
1	5.43 (138)
2	7.91 (201)
3	10.39 (264)
4	12.87 (327)
5	15.35 (390)

Number of illuminated or audible sounder units other than strobe	b inches (mm)
1	11.61 (295)
2	14.09 (358)
3	16.57 (421)
4	19.06 (484)

Push Buttons & Operator Interface

XVB Illuminated Beacons & Indicating Banks / Wiring Diagrams & Dimensions

Panel Cutout for Direct Mounting (on base unit XVBC21)

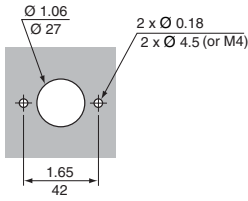

Dual Dimensions $\frac{\text{inches}}{\text{mm}}$

Support Tube XVBC0• and Tulip for Horizontal Surface XVBC11

- 1 Support tube XVBC0•, \varnothing 1.0 in (25 mm)
- 2 Tulip for vertical surface, XVBC12.

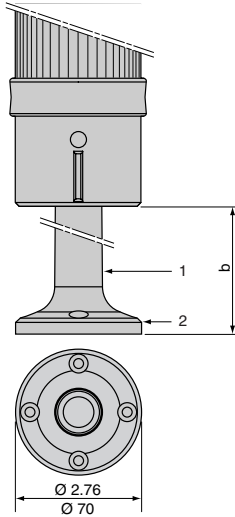

Cut-out in horizontal panel for mounting on tulip XVBC11

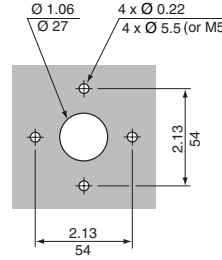

	b inches (mm)
XVBC02	3.03 (77)
XVBC03	14.84 (377)
XVBC04	30.59 (777)

Dual Dimensions $\frac{\text{inches}}{\text{mm}}$

Wall Mount Bracket for Vertical Surface XVBC12, Direct Mounting on Base Unit

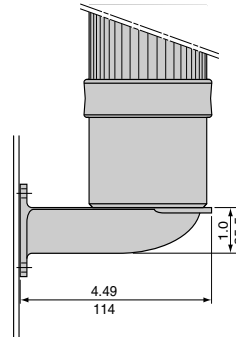
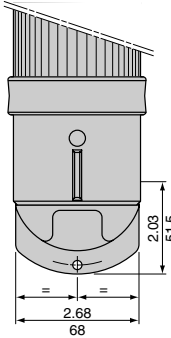

Mounting by Means of Plate XVBC11 (screwed onto tube XVBC0•)

- 1 Tube, \varnothing 1.0 in (25 mm)
- 2 Wall mount bracket, XVBC12.

Cut-out in vertical panel for mounting on plate XVBC12

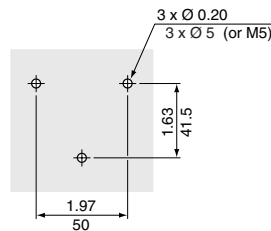
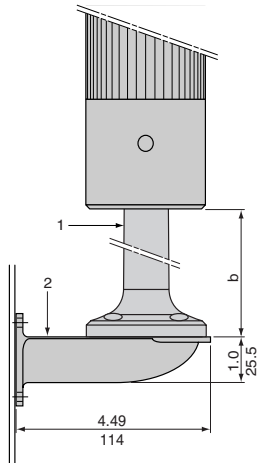

	b inches (mm)
XVBC02	3.03 (77)
XVBC03	14.84 (377)
XVBC04	30.59 (777)



Dual Dimensions $\frac{\text{inches}}{\text{mm}}$

Push Buttons & Operator Interface

XVB Illuminated Beacons & Indicating Banks / XVDLS Miniature Beacons

The XVDLS miniature illuminated beacons are designed for short distance signalling applications.

Environment

Approvals	Standard version, CSA, UL  File E164353 CCN NKCR  File LR 44087 Class 3211 03	UL E164353 CCN NKCR, CSA LR 44087 Class 3211-03
Conforming to standards	 Marked	IEC/EN 60947-5-1, UL 508, CSA C22.2 No. 14
Protective treatment		"TC"
Ambient air temperature		- 40 to + 158 °F (- 40 to +70 °C)
Storage		
Operation	Incandescent bulb	- 13 to + 158 °F (- 25 to +70 °C)
	Strobe units	+ 14 to + 122 °F (- 10 to +50 °C)
Electric shock protection	Conforming to IEC 536	Class II
Degree of protection	To UL 50, CSA C22.2 No. 94 To IEC 60529 and NF C 20-010	Type 1 IP 40
Material	Illuminated lens unit	Polycarbonate
	Base unit and top cover	Glass-reinforced polyamide
Rated insulation voltage (Ui)	Conforming to IEC 947-1	250 V
Consumption	Strobe units	24 Vdc: < 65 mA 120 Vac: < 15 mA 230 Vac: < 19 mA
Rated impulse withstand voltage	Conforming to IEC 60947-1	U imp = 4 kV
Bulb type	Units with steady light	Bayonet type BA 15d, maximum power 5 W
Illuminating power	Strobe units	1.4 cds (integral high intensity tube) with clear lens unit: 0.5 Joule tube
Cable size	Maximum wire size	1 x #16 AWG (1.5 mm ²) with cable end
Terminals		Screw and captive cable clamp terminals Torque to 4.4 lb-in (0.5 N•m)

NOTE: The XVDL miniature illuminated beacon is designed for a maximum 5 W bulb.

Dimensions

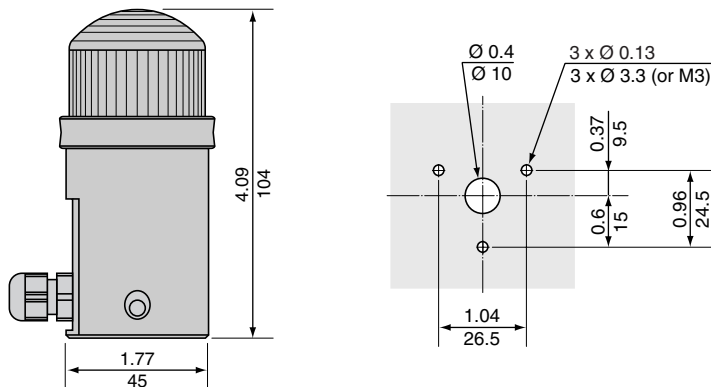

Dual Dimensions $\frac{\text{inches}}{\text{mm}}$

Push Buttons & Operator Interface

XVB Illuminated Beacons & Indicating Banks / XVDLS Miniature Beacons



XVDLS**

Illuminated Beacons with Steady Light (1.75 in/45 mm diameter)

Description	Light Source	Color	Catalog Number
Complete unit, includes: 1 lens unit 1 base unit (direct mounting)	Incandescent bulb (5 W max) ■ not included 250 V max	Green	XVDLS33
		Red	XVDLS34
		Orange	XVDLS35
		Blue	XVDLS36
		Clear	XVDLS37
		Yellow	XVDLS38

■ Bulb type for use with direct supply: BA 15d base fitting, incandescent. Maximum lamp size is 5 W.

Illuminated Beacons with 0.5 Joule Strobe (1.75 in/45 mm diameter)

Description	Light Source	Color	Catalog Number	
Complete unit, includes: 1 lens unit 1 base unit (direct mounting)	Strobe 24 Vdc	Green	XVDLS6B3	
		Red	XVDLS6B4	
		Orange	XVDLS6B5	
		Blue	XVDLS6B6	
		Clear	XVDLS6B7	
		Yellow	XVDLS6B8	
		Strobe 120 Vac	Green	XVDLS6G3
			Red	XVDLS6G4
	Orange		XVDLS6G5	
	Blue		XVDLS6G6	
	Clear		XVDLS6G7	
	Yellow		XVDLS6G8	
	Strobe 230 Vac		Green	XVDLS6M3
		Red	XVDLS6M4	
		Orange	XVDLS6M5	
Blue		XVDLS6M6		
Clear		XVDLS6M7		
Yellow		XVDLS6M8		

Accessories

Description	Supply Voltage	Color	Catalog Number
Incandescent bulbs bayonet type BA 15d, 5 W (sold in lots of 10)	24 Vac/dc		DL1BEBS
	120 Vac/dc		DL1BEGS
	230 Vac/dc		DL1BEMS
LEDs bayonet type BA 15d (sold singly)	24 Vac/dc	White	DL1BDB1
		Green	DL1BDB3
		Red	DL1BDB4
		Blue	DL1BDB6
		Yellow-orange	DL1BDB8
	120 Vac	White	DL1BDG1
		Green	DL1BDG3
		Red	DL1BDG4
		Blue	DL1BDG6
		Yellow-orange	DL1BDG8
	230 Vac	White	DL1BDM1
		Green	DL1BDM3
		Red	DL1BDM4
		Blue	DL1BDM6
		Yellow-orange	DL1BDM8



MANUFACTURER'S DECLARATION OF CONFORMITY

INDUSTRIAL CONTROL BUSINESS UNIT
Machine Equipment Activity Management

WE: SCHNEIDER ELECTRIC SA
40, Avenue A.Morizet
92100 Boulogne-Billancourt-t
FRANCE

declare under our own responsibility that the product(s):

TRADEMARK TELEMECANIQUE

NAME, TYPE : Pushbuttons and pilot lights
MODELS : XB4-B.. , ZB4-B.. ,XB5-A.. ,ZB5-A..

NAME, TYPE : Illuminated beacons and indicating banks
MODELS : XVB.. ,XVD.. ,XVD-LS..

NAME, TYPE : Control stations
MODELS : XAL-D.. ,XAL-K..

NAME, TYPE : Electrical blocks
MODELS : ZBE... ,ZBV... ,ZEN-L... ,ZAL-V.

to which this declaration refers conform to :

STANDARDS OR NORMATIVE DOCUMENTS :
Low-voltage switchgear and controlgear,
General rules IEC 947-1 (EN60947-1)
Electromechanical control circuit devices IEC/EN60947-5- 1

Subject to installation, maintenance and use conforming to its (their) intended purpose, to the applicable regulations and standards, to the supplier's instructions and to standard practice,

the products conform to the requirements of the applicable European Directives :

Low-voltage Directive N° 73/23/EEC
EMC Directive N° 89/336/EEC

The CE marking on the products and/or their packaging signifies that Schneider Electric holds the reference technical file available to the European Union authorities.

Issued at Angoulême - FRANCE : May 11 ,1999

Authorised Signatory

Name : Arne Frank
Title : Activity Director
Signature :

COPYING WITHOUT WRITTEN AUTHORISATION PROHIBITED



Schneider Electric - North American Division
1415 South Roselle Road
Palatine, IL 60067 USA
Tel. 847-397-2600
Fax 847-925-7367
http://www.squared.com

Push Buttons - Declaration of Conformity



MANUFACTURER'S DECLARATION OF CONFORMITY

INDUSTRIAL CONTROL BUSINESS UNIT
Machine Equipment Activity Management

WE : SCHNEIDER ELECTRIC SA
40, Avenue A.Morizet
92100 Boulogne-Billancourt
FRANCE

declare under our own responsibility that the product(s):

TRADEMARK : TELEMECANIQUE

NAME, TYPE : *Pushbuttons and pilot lights*
MODELS : XB2-B.,XA2-B.,XB2-M.,Domino, XB2-E.,XVL...

NAME, TYPE : *Joystick controllers*
MODELS : XD2-...XDL- .

NAME, TYPE : *Control stations*
MODELS : XAL-., XAP-..

NAME, TYPE : *Rotary switches*
MODELS : XBC-D., K1.,K2..

NAME, TYPE : *Illuminated indicator bank*
MODELS : XVA..

to which this declaration refers conform to:

STANDARDS OR NORMATIVE DOCUMENTS :
Low-voltage switchgear and controlgear,
General rules IEC 947-1 (EN60947-1)
Electromechanical control circuit devices IEC 947-5-1 (EN60947-5-1)

Subject to installation, maintenance and use conforming to its (their) intended purpose, to the applicable regulations and standards, to the suppliers instructions and to standard practice,

the products conform to the requirements of the applicable European Directives :

Low-voltage Directive N° 73/23/EEC
EMC Directive N° 89/336/EEC

The CE marking on the products and/or their packaging signifies that Schneider Electric holds the reference technical file available to the European Union authorities.

Issued at Angoulême - FRANCE : November 4,1996

Authorised Signatory

Name : Xavier Robineau Bourgneuf
Title : Activity Director
Signature :



Schneider Electric - North American Division

1415 South Roselle Road
Palatine, IL 60067 USA
Tel. 847-397-2600
Fax 847-925-7367
<http://www.squared.com>



**MANUFACTURER'S
DECLARATION OF CONFORMITY**

**INDUSTRIAL CONTROL BUSINESS UNIT
Machine Equipment Activity Management**

**WE : SCHNEIDER ELECTRIC INDUSTRIES SA
89 boulevard Franklin Roosevelt
92500 Rueil Malmaison
FRANCE**

declare under our own responsibility that the products:

TRADEMARK : TELEMECANIQUE

NAME, TYPE : Display units with alphanumeric screen
MODELS : XBT-H...

NAME, TYPE : Display units with matrix screen
MODELS : XBT-HM...

NAME, TYPE : Terminals with alphanumeric screen
MODELS : XBT-P... ;XBT-E...

NAME, TYPE : Terminals with matrix screen
MODELS : XBT-PM...

NAME, TYPE : Terminals with graphic screen
MODELS : XBT-F ... ;XBT-FC...

to which this declaration refers conform to :

STANDARDS OR NORMATIVE DOCUMENTS :
Low-voltage switchgear and controlgear,
General rules IEC 947-1 (EN60947-1)
Programmable controllers IEC 1131-2 (EN61 131-2)

Subject to installation, maintenance and use conforming to their intended purpose, to the applicable regulations and standards, to the supplier's instructions and to standard practice,

the products conform to the requirements of the applicable European Directives

EMC Directive N° 89/336/EEC

The CE marking on the products and/or their packaging signifies that Schneider Electric holds the reference technical file available to the European Union authorities.

Issued at Angoulême - FRANCE : May 05 , 2000

Authorised Signatory

Name:
Title:
Signature:

Jean Pierre Mura
Activity Director



MANUFACTURER'S DECLARATION OF CONFORMITY

WE: Square D Company
128 Bingham Road
Asheville, NC 28802

Declare that the products:

BRAND: SquareD
NAME, TYPE: Class 9001, Type KM, KMF, "Light Modules"
" " , Type KA, "Contact Blocks"
" " , Type K, KX, SK, SKRU, "30 mm Operators"
" " , Type BW, SKYP "Pendant Stations"
Class 9002, Type AW, "Foot Switches"

To which this declaration refers are in conformity with:

The following Standards or Normative Documents:

- General rules: EN60947.1
- Electromechanical control circuit devices: EN60947.5.1

subject to installation, maintenance and utilization in accordance with their purpose, regulations, current standards, manufacturer's instructions and industry standards.

Meet the provisions of the following Directives:

No. 73/23/CCE of February 19, 1973, named Low-voltage Directive, modified by Directive 93/68/EC of July 22, 1993.

No. 89/336/CEE of May 3, 1989, named Electromagnetic Compatibility Directive, modified by Directives 92/31/CEE of April 28, 1992 and 93/68/CEE of July 22, 1993.

The CE marking on the product and/or the packaging signifies that Square D holds the reference technical file available to the European Authorities.

Executed at Raleigh: October 22, 1997

Authorized Signature:

Name: Neil Tollas
Position: Director, Logic Control
Signature:



Push Buttons and Operator Interface Specifiers Guide

Indexed Catalog Numbers

2550101002207	DL1BDB4216	DL1CE13066	JT32
255010100332	DL1BDB4220	DL1CF110101	JT132
255010102032	DL1BDB6216	DL1CF11066	JT1G2932
255010102032	DL1BDB6220	DL1CF220101	JT1R2932
255010102032	DL1BDB8216	DL1CF22066	JT1Y2932
255010102032	DL1BDB8220	DL1CJUS0063202	JT3532
255010102232	DL1BDG1216	DL1CJUS0064202	JT35DGG2932
255010102232	DL1BDG1220	DL1CJUS0065202	JT35DRR2932
255010102432	DL1BDG3216	DL1CJUS0123202	JT35DYY2932
255010102432	DL1BDG3220	DL1CJUS0124202	JT35G2932
255010102432	DL1BDG4216	DL1CJUS0125202	JT35LGG2932
255010102532	DL1BDG4220	DL1CJUS0243202	JT35LRR2932
255010102532	DL1BDG6216	DL1CJUS0244202	JT35LYY2932
255010102632	DL1BDG6220	DL1CJUS0245202	JT35R2932
255010102632	DL1BDG8216	DL1CJUS1203202	JT35Y2932
2550101027207	DL1BDG8220	DL1CJUS1204202	JT3832
255010104032	DL1BDM1216	DL1CJUS1205202	JT38G2932
255010104032	DL1BDM1220	FB1234	JT38LGG2932
255010104032	DL1BDM3216	FB12034	JT38LRR2932
255010500334	DL1BDM3220	FB2434	JT38LYY2932
255010500434	DL1BDM4216	G2633	JT38R2932
255010500534	DL1BDM4220	G2933	JT38Y2932
255042001034	DL1BDM6216	JN10033	JTR32
255042002034	DL1BDM6220	JN100R33	JTR132
255042003034	DL1BDM8216	JN19933	JTR1G2932
255042004034	DL1BDM8220	JN199R33	JTR1R2932
255042006034	DL1BEB216	JN70033	JTR1Y2932
255043004034	DL1BEBS220	JN79933	JTR3532
255047001034	DL1BEE216	JP32	JTR35G2932
6508805206207	DL1BEG216	JP132	JTR35LGG2932
6508805206207	DL1BEGS220	JP1G2932	JTR35LRR2932
651290180133	DL1BEJ216	JP1R2932	JTR35LYY2932
651290920133	DL1BEM216	JP1Y2932	JTR35R2932
651290930133	DL1BEMS220	JP3532	JTR35Y2932
651290960133	DL1BLB216	JP35DGG2932	JTR3832
A2633	DL1BLE216	JP35DRR2932	JTR38G2932
A2933	DL1BLG216	JP35DYY2932	JTR38R2932
APE1C215059	DL1BLJ216	JP35G2932	JTR38Y2932
APE1C215094	DL1BLM216	JP35LGG2932	KA1207
APE1C225059	DL1CB006101	JP35LRR2932	KA3207
APE1C225094	DL1CB006202	JP35LYY2932	L2633
APE1PAD2159	DL1CB00666	JP35R2932	L2933
APE1PAD2194	DL1CE012101	JP35Y2932	NE51HRT120V202
C2633	DL1CE012202	JP3832	NE51HRT220V202
C2933	DL1CE01266	JP38G2932	NE51HRT380V202
DL1202	DL1CE024101	JP38LGG2932	OA1234
DL1BDB1216	DL1CE024202	JP38LRR2932	OA12034
DL1BDB1220	DL1CE02466	JP38LYY2932	OA2434
DL1BDB3216	DL1CE130101	JP38R2932	OC1234
DL1BDB3220	DL1CE130202	JP38Y2932	OC12034

Push Buttons and Operator Interface Specifiers Guide

Indexed Catalog Numbers

OC24	34	XACD21A0105	199	XAPG19501	121	XB4BD53	43
OG12	34	XACD21A1231	199	XAPG19702	121	XB4BG03	43
OG120	34	XACD21A1241	199	XAPG19802	121	XB4BG21	43
OG24	34	XACS101	199	XAPG29100	121	XB4BG33	43
OR12	34	XACS102	199	XAPG29202	121	XB4BG41	43
OR120	34	XACS103	199	XAPG29400	121	XB4BG61	43
OR24	34	XACS104	199	XAPG29502	121	XB4BJ21	43
OW12	34	XACS105	199	XAPG29703	121	XB4BJ33	43
OW120	34	XALD01	114	XAPG29803	121	XB4BJ53	43
OW24	34	XALD02	114	XAPG39100	121	XB4BL42	42
OY12	34	XALD03	114	XAPG39203	121	XB4BL845	42
OY120	34	XALD04	114	XAPG39400	121	XB4BP21	42
OY24	34	XALD05	114	XAPG39503	121	XB4BP31	42
R26	33	XALD101	113	XAPG39704	121	XB4BP42	42
R29	33	XALD111	113	XAPG39804	121	XB4BP51	42
SKR9	207	XALD164	113	XAPG49400	121	XB4BP61	42
SKR9P55	207	XALD211	114	XAPG49504	121	XB4BS142	43
SKR9P55R05	207	XALD221	114	XAPG59400	121	XB4BS542	43
SKR9P58R	207	XALD311	114	XAPG59505	121	XB4BS8445	43
SKR9R	207	XALD321	114	XAPZ100	119	XB4BS9445	43
SKR9R05	207	XALD341	114	XAPZ104	120	XB4BT42	43
W26	33	XALK01	114	XAPZ110	120	XB4BT845	43
W29	33	XALK174	113	XAPZ120	120	XB4BV31	44
XACA009	200	XALK178	113	XAPZ200	119	XB4BV33	44
XACA02	199	XALK184	113	XAPZ208	120	XB4BV34	44
XACA03	199	XALK188	113	XAPZ300	119	XB4BV35	44
XACA04	199	XALK194	113	XAPZ316	120	XB4BV61	44
XACA06	199	XALZ09	115	XB4BA21	42	XB4BV63	44
XACA08	199	XAPA1100	119	XB4BA31	42	XB4BV64	44
XACA12	199	XAPA1104	120	XB4BA3311	42	XB4BV65	44
XACA201q	199	XAPA1110	120	XB4BA42	42	XB4BVB1	44
XACA205	199	XAPA1120	120	XB4BA4322	42	XB4BVB3	44
XACA207	199	XAPA2100	119	XB4BA51	42	XB4BVB4	44
XACA913	200	XAPA2108	120	XB4BA61	42	XB4BVB5	44
XACA9411	200	XAPA3100	119	XB4BA821	52	XB4BVB6	44
XACA9412	200	XAPA3116	120	XB4BA822	52	XB4BVG1	44
XACA9413	200	XAPA4100	119	XB4BA841	52	XB4BVG3	44
XACA9414	200	XAPE301	122	XB4BA842	52	XB4BVG4	44
XACA9416	200	XAPE302	122	XB4BA861	52	XB4BVG5	44
XACA9419	200	XAPE303	122	XB4BA862	52	XB4BVG6	44
XACA960	200	XAPE304	122	XB4BA921	52	XB4BW3135	45
XACA971	200	XAPE305	122	XB4BA922	52	XB4BW3145	45
XACA971	203	XAPE901	122	XB4BA941	52	XB4BW3165	45
XACA982	200	XAPE902	122	XB4BA942	52	XB4BW31B5	45
XACA982	203	XAPE903	122	XB4BA961	52	XB4BW31G5	45
XACA983	200	XAPE904	122	XB4BA962	52	XB4BW3335	45
XACA983	203	XAPE905	122	XB4BC21	42	XB4BW3345	45
XACB961	200	XAPG19100	121	XB4BD21	43	XB4BW3365	45
XACB961	203	XAPG19201	121	XB4BD25	43	XB4BW33B5	45
XACD21A0101	199	XAPG19400	121	XB4BD33	43	XB4BW33G5	45

Push Buttons and Operator Interface Specifiers Guide

Indexed Catalog Numbers

XB4BW3435	45	XB5AS142	79	XB5KSG	87	XB6AW1B5B	7
XB4BW3445	45	XB5AS542	79	XB5KSM	87	XB6AW3B1B	7
XB4BW3465	45	XB5AS8445	79	XB6AA11B	9	XB6AW3B5B	7
XB4BW34B5	45	XB5AS9445	79	XB6AA15B	9	XB6AW4B1B	7
XB4BW34G5	45	XB5AT42	79	XB6AA21B	9	XB6AW4B5B	7
XB4BW3535	45	XB5AT845	79	XB6AA22B	9	XB6AW5B1B	7
XB4BW3545	45	XB5AV31	80	XB6AA25B	9	XB6AW5B5B	7
XB4BW3565	45	XB5AV33	80	XB6AA31B	9	XB6AW6B1B	7
XB4BW35B5	45	XB5AV34	80	XB6AA35B	9	XB6AW6B5B	7
XB4BW35G5	45	XB5AV35	80	XB6AA42B	9	XB6CA11B	9
XB4BW36B5	45	XB5AV61	80	XB6AA45B	9	XB6CA15B	9
XB4BW36G5	45	XB5AV63	80	XB6AA51B	9	XB6CA21B	9
XB5AA21	78	XB5AV64	80	XB6AA55B	9	XB6CA22B	9
XB5AA31	78	XB5AV65	80	XB6AA61B	9	XB6CA25B	9
XB5AA3311	78	XB5AVB1	80	XB6AA65B	9	XB6CA31B	9
XB5AA42	78	XB5AVB3	80	XB6AD221B	10	XB6CA35B	9
XB5AA4322	78	XB5AVB4	80	XB6AD225B	10	XB6CA42B	9
XB5AA51	78	XB5AVB5	80	XB6AD235B	10	XB6CA45B	9
XB5AA61	78	XB5AVB6	80	XB6AE1B1B	7	XB6CA51B	9
XB5AA831	87	XB5AVG1	80	XB6AE1B5B	7	XB6CA55B	9
XB5AA832	87	XB5AVG3	80	XB6AE3B1B	7	XB6CA61B	9
XB5AA841	87	XB5AVG4	80	XB6AE3B5B	7	XB6CA65B	9
XB5AA84101	87	XB5AVG5	80	XB6AE4B1B	7	XB6CD221B	10
XB5AA842	87	XB5AVG6	80	XB6AE4B5B	7	XB6CD225B	10
XB5AA84201	87	XB5AW3135	80	XB6AE5B1B	7	XB6CD235B	10
XB5AA861	87	XB5AW3145	80	XB6AE5B5B	7	XB6CE1B1B	6
XB5AA86102	87	XB5AW3165	80	XB6AE6B1B	7	XB6CE1B5B	6
XB5AA862	87	XB5AW31B5	80	XB6AE6B5B	7	XB6CE3B1B	6
XB5AA86202	87	XB5AW31G5	80	XB6AF1B1B	7	XB6CE3B5B	6
XB5AC21	78	XB5AW3335	80	XB6AF1B5B	7	XB6CE4B2B	6
XB5AD21	79	XB5AW3345	80	XB6AF3B1B	7	XB6CE4B5B	6
XB5AD33	79	XB5AW3365	80	XB6AF3B5B	7	XB6CE5B1B	6
XB5AD53	79	XB5AW33B5	80	XB6AF4B1B	7	XB6CE5B5B	6
XB5AG03	79	XB5AW33G5	80	XB6AF4B5B	7	XB6CE6B1B	6
XB5AG21	79	XB5AW3435	80	XB6AF5B1B	7	XB6CE6B5B	6
XB5AG33	79	XB5AW3445	80	XB6AF5B5B	7	XB6CF1B1B	6
XB5AG41	79	XB5AW3465	80	XB6AF6B1B	7	XB6CF1B5B	6
XB5AG61	79	XB5AW34B5	80	XB6AF6B5B	7	XB6CF3B1B	6
XB5AJ21	79	XB5AW34G5	80	XB6AGC5B	10	XB6CF3B5B	6
XB5AJ33	79	XB5AW3535	80	XB6AGH5B	10	XB6CF4B2B	6
XB5AJ53	79	XB5AW3545	80	XB6AS8342B	8	XB6CF4B5B	6
XB5AL42	78	XB5AW3565	80	XB6AS8345B	8	XB6CF5B1B	6
XB5AL84101	87	XB5AW35B5	80	XB6AS9342B	8	XB6CF5B5B	6
XB5AL84201	87	XB5AW35G5	80	XB6AS9345B	8	XB6CF6B1B	6
XB5AL845	78	XB5AW36B5	80	XB6AV1BB	8	XB6CF6B5B	6
XB5AP21	78	XB5AW36G5	80	XB6AV3BB	8	XB6CGC5B	10
XB5AP31	78	XB5DSB	87	XB6AV4BB	8	XB6CGH5B	10
XB5AP42	78	XB5DSG	87	XB6AV5BB	8	XB6CV1BB	8
XB5AP51	78	XB5DSM	87	XB6AV6BB	8	XB6CV3BB	8
XB5AP61	78	XB5KSB	87	XB6AW1B1B	7	XB6CV4BB	8

Push Buttons and Operator Interface Specifiers Guide

Indexed Catalog Numbers

XB6CV5BB	8	XB6DV4BB	8	XVBC4B4	215	XVBL4M8	214
XB6CV6BB	8	XB6DV5BB	8	XVBC4B5	215	XVBL8B3	214
XB6CW1B1B	6	XB6DV6BB	8	XVBC4B6	215	XVBL8B4	214
XB6CW1B5B	6	XB6DW1B1B	6	XVBC4B7	215	XVBL8B5	214
XB6CW3B1B	6	XB6DW1B5B	6	XVBC4B8	215	XVBL8B6	214
XB6CW3B5B	6	XB6DW3B1B	6	XVBC4M3	215	XVBL8B7	214
XB6CW4B2B	6	XB6DW3B5B	6	XVBC4M4	215	XVBL8B8	214
XB6CW4B5B	6	XB6DW4B2B	6	XVBC4M5	215	XVBL8G3	214
XB6CW5B1B	6	XB6DW4B5B	6	XVBC4M6	215	XVBL8G4	214
XB6CW5B5B	6	XB6DW5B1B	6	XVBC4M7	215	XVBL8G5	214
XB6CW6B1B	6	XB6DW5B5B	6	XVBC4M8	215	XVBL8G6	214
XB6CW6B5B	6	XB6DW6B1B	6	XVBC8B3	215	XVBL8G7	214
XB6DA11B	9	XB6DW6B5B	6	XVBC8B4	215	XVBL8G8	214
XB6DA15B	9	XBFX13	101	XVBC8B5	215	XVBL8M3	214
XB6DA21B	9	XBFX13	66	XVBC8B6	215	XVBL8M4	214
XB6DA22B	9	XBZS43	101	XVBC8B7	215	XVBL8M5	214
XB6DA25B	9	XBZS43	66	XVBC8B8	215	XVBL8M6	214
XB6DA31B	9	XD4PA12	52	XVBC8G3	215	XVBL8M7	214
XB6DA35B	9	XD4PA14	52	XVBC8G4	215	XVBL8M8	214
XB6DA42B	9	XD4PA22	52	XVBC8G5	215	XVDLS33	220
XB6DA45B	9	XD4PA24	52	XVBC8G6	215	XVDLS34	220
XB6DA51B	9	XD5PA12	87	XVBC8G7	215	XVDLS35	220
XB6DA55B	9	XD5PA14	87	XVBC8G8	215	XVDLS36	220
XB6DD221B	10	XD5PA22	87	XVBC8M3	215	XVDLS37	220
XB6DD225B	10	XD5PA24	87	XVBC8M4	215	XVDLS38	220
XB6DD235B	10	XENG1191	199	XVBC8M5	215	XVDLS6B3	220
XB6DE1B1B	6	XENG1491	199	XVBC8M6	215	XVDLS6B4	220
XB6DE1B5B	6	XENG3781	199	XVBC8M7	215	XVDLS6B5	220
XB6DE3B1B	6	XENG3791	199	XVBC8M8	215	XVDLS6B6	220
XB6DE3B5B	6	XVBC00	216	XVBC9B	216	XVDLS6B7	220
XB6DE4B2B	6	XVBC02	216	XVBC9M	216	XVDLS6B8	220
XB6DE4B5B	6	XVBC020	216	XVBCY1	216	XVDLS6G3	220
XB6DE5B1B	6	XVBC03	216	XVBCY2	216	XVDLS6G4	220
XB6DE5B5B	6	XVBC030	216	XVBL33	214	XVDLS6G5	220
XB6DE6B1B	6	XVBC04	216	XVBL34	214	XVDLS6G6	220
XB6DE6B5B	6	XVBC040	216	XVBL35	214	XVDLS6G7	220
XB6DF1B1B	6	XVBC081	216	XVBL36	214	XVDLS6G8	220
XB6DF1B5B	6	XVBC11	216	XVBL37	214	XVDLS6M3	220
XB6DF3B1B	6	XVBC12	216	XVBL38	214	XVDLS6M4	220
XB6DF3B5B	6	XVBC14	216	XVBL4B3	214	XVDLS6M5	220
XB6DF4B2B	6	XVBC21	216	XVBL4B4	214	XVDLS6M6	220
XB6DF4B5B	6	XVBC22	216	XVBL4B5	214	XVDLS6M7	220
XB6DF5B1B	6	XVBC23	216	XVBL4B6	214	XVDLS6M8	220
XB6DF5B5B	6	XVBC33	215	XVBL4B7	214	XVLA113	36
XB6DF6B1B	6	XVBC34	215	XVBL4B8	214	XVLA114	36
XB6DF6B5B	6	XVBC35	215	XVBL4M3	214	XVLA115	36
XB6DGC5B	10	XVBC36	215	XVBL4M4	214	XVLA123	36
XB6DGH5B	10	XVBC37	215	XVBL4M5	214	XVLA124	36
XB6DV1BB	8	XVBC38	215	XVBL4M6	214	XVLA125	36
XB6DV3BB	8	XVBC4B3	215	XVBL4M7	214	XVLA133	36

Push Buttons and Operator Interface Specifiers Guide

Indexed Catalog Numbers

XVLA134	36	ZA2BS844	200	ZB2BY2335	202	ZB4BA38	54
XVLA135	36	ZA2BS844	200	ZB2BY2336	202	ZB4BA4	46
XVLA143	36	ZA2BV03	200	ZB2BY2337	202	ZB4BA432	47
XVLA144	36	ZA2BV033	200	ZB2BY2338	202	ZB4BA434	47
XVLA145	36	ZA2BV04	200	ZB2BY2339	202	ZB4BA435	47
XVLA213	36	ZA2BV05	200	ZB2BY2341	202	ZB4BA46	46
XVLA214	36	ZA2BV053	200	ZB2BY2342	202	ZB4BA48	46
XVLA215	36	ZA2BV06	200	ZB2BY2343	202	ZB4BA48	54
XVLA223	36	ZALVB1	115	ZB2BY2344	202	ZB4BA5	46
XVLA224	36	ZALVB3	115	ZB2BY2345	202	ZB4BA56	46
XVLA225	36	ZALVB4	115	ZB2BY2346	202	ZB4BA58	46
XVLA233	36	ZALVB5	115	ZB2BY2365	202	ZB4BA58	54
XVLA234	36	ZALVB6	115	ZB2BY2366	202	ZB4BA6	46
XVLA235	36	ZALVG1	115	ZB2BY2367	202	ZB4BA66	46
XVLA243	36	ZALVG3	115	ZB2BY2369	202	ZB4BA68	46
XVLA244	36	ZALVG4	115	ZB2BY2370	202	ZB4BA68	54
XVLA245	36	ZALVG5	115	ZB2BY2372	202	ZB4BA8	46
XVLA313	36	ZALVG6	115	ZB2BY2376	202	ZB4BA8112	48
XVLA314	36	ZALVM1	115	ZB2BY2380	202	ZB4BA8134	48
XVLA315	36	ZALVM3	115	ZB2BY2381	202	ZB4BA8212	48
XVLA323	36	ZALVM4	115	ZB2BY2384	202	ZB4BA8234	48
XVLA324	36	ZALVM5	115	ZB2BY2387	202	ZB4BA9	46
XVLA325	36	ZALVM6	115	ZB2BY2388	202	ZB4BA9112	48
XVLA333	36	ZB2BE101	199	ZB2BY2389	202	ZB4BA9134	48
XVLA334	36	ZB2BE102	199	ZB2BY2503	202	ZB4BA9212	48
XVLA335	36	ZB2BV006	200	ZB2BY4001	202	ZB4BA9234	48
XVLA343	36	ZB2BV007	200	ZB2BY4005	202	ZB4BC2	47
XVLA344	36	ZB2BY2002	202	ZB2BY4101	202	ZB4BC24	47
XVLA345	36	ZB2BY2004	202	ZB2SZ3	200	ZB4BC3	47
XVLX08	36	ZB2BY2101	202	ZB4BA0	46	ZB4BC34	47
XVLX12	36	ZB2BY23	202	ZB4BA1	46	ZB4BC4	47
XVLZ911	36	ZB2BY2303	202	ZB4BA131	47	ZB4BC44	47
XVLZ912	36	ZB2BY2304	202	ZB4BA133	47	ZB4BC5	47
Y26	33	ZB2BY2305	202	ZB4BA141	47	ZB4BC54	47
Y29	33	ZB2BY2306	202	ZB4BA16	46	ZB4BC6	47
ZA2BB2	200	ZB2BY2307	202	ZB4BA18	46	ZB4BC64	47
ZA2BB4	200	ZB2BY2308	202	ZB4BA18	54	ZB4BD2	50
ZA2BC2	200	ZB2BY2309	202	ZB4BA2	46	ZB4BD28	52
ZA2BC24	200	ZB2BY2310	202	ZB4BA232	47	ZB4BD3	50
ZA2BC4	200	ZB2BY2311	202	ZB4BA234	47	ZB4BD4	50
ZA2BC44	200	ZB2BY2312	202	ZB4BA235	47	ZB4BD48	52
ZA2BD2	200	ZB2BY2313	202	ZB4BA26	46	ZB4BD5	50
ZA2BD3	200	ZB2BY2314	202	ZB4BA3	46	ZB4BD7	50
ZA2BG4	200	ZB2BY2321	202	ZB4BA331	47	ZB4BD8	50
ZA2BG5	200	ZB2BY2323	202	ZB4BA333	47	ZB4BD922	52
ZA2BS14	200	ZB2BY2326	202	ZB4BA334	47	ZB4BG0	50
ZA2BS44	200	ZB2BY2327	202	ZB4BA335	47	ZB4BG08	50
ZA2BS54	200	ZB2BY2328	202	ZB4BA341	47	ZB4BG09	50
ZA2BS74	200	ZB2BY2330	202	ZB4BA36	46	ZB4BG1	50
ZA2BS834	200	ZB2BY2334	202	ZB4BA38	46	ZB4BG2	50

Push Buttons and Operator Interface Specifiers Guide

Indexed Catalog Numbers

ZB4BG3	50	ZB4BK1513	56	ZB4BR6	47	ZB4BV3	53
ZB4BG4	50	ZB4BK1533	56	ZB4BS12	49	ZB4BV4	53
ZB4BG5	50	ZB4BK1543	56	ZB4BS14	49	ZB4BV5	53
ZB4BG6	50	ZB4BK1553	56	ZB4BS22	49	ZB4BV6	53
ZB4BG7	50	ZB4BK1563	56	ZB4BS24	49	ZB4BV8	53
ZB4BG8	50	ZB4BK1713	56	ZB4BS42	49	ZB4BV9	53
ZB4BG9	50	ZB4BK1733	56	ZB4BS44	49	ZB4BVB1	53
ZB4BH01	48	ZB4BK1743	56	ZB4BS52	49	ZB4BVB3	53
ZB4BH013	55	ZB4BK1753	56	ZB4BS54	49	ZB4BVB4	53
ZB4BH02	48	ZB4BK1763	56	ZB4BS5430	49	ZB4BVB5	53
ZB4BH03	48	ZB4BK1813	56	ZB4BS55	49	ZB4BVB6	53
ZB4BH033	55	ZB4BK1833	56	ZB4BS5550	49	ZB4BVG1	53
ZB4BH04	48	ZB4BK1843	56	ZB4BS62	49	ZB4BVG3	53
ZB4BH043	55	ZB4BK1853	56	ZB4BS64	49	ZB4BVG4	53
ZB4BH05	48	ZB4BK1863	56	ZB4BS72	49	ZB4BVG5	53
ZB4BH053	55	ZB4BL1	46	ZB4BS74	49	ZB4BVG6	53
ZB4BH06	48	ZB4BL2	46	ZB4BS834	49	ZB4BW031	58
ZB4BH063	55	ZB4BL232	47	ZB4BS844	49	ZB4BW035	58
ZB4BH1	48	ZB4BL234	47	ZB4BS934	49	ZB4BW041	58
ZB4BH13	55	ZB4BL235	47	ZB4BS944	49	ZB4BW045	58
ZB4BH2	48	ZB4BL3	46	ZB4BS964	49	ZB4BW051	58
ZB4BH3	48	ZB4BL4	46	ZB4BT2	49	ZB4BW055	58
ZB4BH33	55	ZB4BL432	47	ZB4BT4	49	ZB4BW061	58
ZB4BH4	48	ZB4BL434	47	ZB4BT84	49	ZB4BW062	58
ZB4BH43	55	ZB4BL435	47	ZB4BV01	53	ZB4BW063	58
ZB4BH5	48	ZB4BL5	46	ZB4BV013	53	ZB4BW065	58
ZB4BH53	55	ZB4BL6	46	ZB4BV013S	53	ZB4BW0B11	57
ZB4BH6	48	ZB4BL8312	48	ZB4BV03	53	ZB4BW0B12	57
ZB4BH63	55	ZB4BL8334	48	ZB4BV033	53	ZB4BW0B13	57
ZB4BJ2	50	ZB4BL8412	48	ZB4BV033S	53	ZB4BW0B15	57
ZB4BJ3	50	ZB4BL8434	48	ZB4BV04	53	ZB4BW0B31	57
ZB4BJ4	50	ZB4BL9312	48	ZB4BV043	53	ZB4BW0B32	57
ZB4BJ5	50	ZB4BL9334	48	ZB4BV043S	53	ZB4BW0B33	57
ZB4BJ7	50	ZB4BL9412	48	ZB4BV05	53	ZB4BW0B35	57
ZB4BJ8	50	ZB4BL9434	48	ZB4BV053	53	ZB4BW0B41	57
ZB4BK1213	56	ZB4BP1	46	ZB4BV053S	53	ZB4BW0B42	57
ZB4BK1233	56	ZB4BP18	46	ZB4BV06	53	ZB4BW0B43	57
ZB4BK1243	56	ZB4BP2	46	ZB4BV063	53	ZB4BW0B45	57
ZB4BK1253	56	ZB4BP3	46	ZB4BV063S	53	ZB4BW0B51	57
ZB4BK1263	56	ZB4BP38	46	ZB4BV07	53	ZB4BW0B52	57
ZB4BK1313	56	ZB4BP4	46	ZB4BV18B1	53	ZB4BW0B53	57
ZB4BK1333	56	ZB4BP48	46	ZB4BV18B3	53	ZB4BW0B55	57
ZB4BK1343	56	ZB4BP5	46	ZB4BV18B4	53	ZB4BW0B61	57
ZB4BK1353	56	ZB4BP58	46	ZB4BV18B5	53	ZB4BW0B62	57
ZB4BK1363	56	ZB4BP6	46	ZB4BV18B6	53	ZB4BW0B63	57
ZB4BK1413	56	ZB4BP68	46	ZB4BV18G1	53	ZB4BW0B65	57
ZB4BK1433	56	ZB4BR2	47	ZB4BV18G3	53	ZB4BW0G11	57
ZB4BK1443	56	ZB4BR3	47	ZB4BV18G4	53	ZB4BW0G12	57
ZB4BK1453	56	ZB4BR4	47	ZB4BV18G5	53	ZB4BW0G13	57
ZB4BK1463	56	ZB4BR5	47	ZB4BV18G6	53	ZB4BW0G15	57

Push Buttons and Operator Interface Specifiers Guide

Indexed Catalog Numbers

ZB4BW0G31	57	ZB4BW653	55	ZB5AA131	82	ZB5AC3	82
ZB4BW0G32	57	ZB4BW663	55	ZB5AA133	82	ZB5AC34	82
ZB4BW0G33	57	ZB4BW673	55	ZB5AA14	81	ZB5AC4	82
ZB4BW0G35	57	ZB4BW811723	55	ZB5AA141	82	ZB5AC44	82
ZB4BW0G41	57	ZB4BW812743	55	ZB5AA18	81	ZB5AC5	82
ZB4BW0G42	57	ZB4BW813743	55	ZB5AA18	89	ZB5AC54	82
ZB4BW0G43	57	ZB4BW821723	55	ZB5AA2	81	ZB5AC6	82
ZB4BW0G45	57	ZB4BW822743	55	ZB5AA232	82	ZB5AC64	82
ZB4BW0G51	57	ZB4BW823743	55	ZB5AA234	82	ZB5AD2	85
ZB4BW0G52	57	ZB4BW831723	55	ZB5AA235	82	ZB5AD28	87
ZB4BW0G53	57	ZB4BW832743	55	ZB5AA24	81	ZB5AD3	85
ZB4BW0G55	57	ZB4BW833743	55	ZB5AA3	81	ZB5AD4	85
ZB4BW0G61	57	ZB4BW841723	55	ZB5AA331	82	ZB5AD48	87
ZB4BW0G62	57	ZB4BW842743	55	ZB5AA333	82	ZB5AD5	85
ZB4BW0G63	57	ZB4BW843743	55	ZB5AA334	82	ZB5AD7	85
ZB4BW0G65	57	ZB4BX2	49	ZB5AA335	82	ZB5AD8	85
ZB4BW11	54	ZB4BX4	49	ZB5AA34	81	ZB5AD922	87
ZB4BW113	54	ZB4BZ009	51	ZB5AA341	82	ZB5AG0	85
ZB4BW13	54	ZB4BZ009	58	ZB5AA343	82	ZB5AG08	85
ZB4BW133	54	ZB4BZ009	60	ZB5AA344	82	ZB5AG09	85
ZB4BW14	54	ZB4BZ079	60	ZB5AA345	82	ZB5AG1	85
ZB4BW143	54	ZB4BZ101	51	ZB5AA38	81	ZB5AG2	85
ZB4BW15	54	ZB4BZ1013	51	ZB5AA38	89	ZB5AG3	85
ZB4BW153	54	ZB4BZ1014	59	ZB5AA4	81	ZB5AG4	85
ZB4BW16	54	ZB4BZ1016	51	ZB5AA432	82	ZB5AG5	85
ZB4BW163	54	ZB4BZ1019	51	ZB5AA434	82	ZB5AG6	85
ZB4BW17	54	ZB4BZ102	51	ZB5AA435	82	ZB5AG7	85
ZB4BW31	54	ZB4BZ1023	51	ZB5AA44	81	ZB5AG8	85
ZB4BW313	54	ZB4BZ1024	59	ZB5AA48	81	ZB5AG9	85
ZB4BW33	54	ZB4BZ1026	51	ZB5AA48	89	ZB5AH01	83
ZB4BW333	54	ZB4BZ1029	51	ZB5AA5	81	ZB5AH013	90
ZB4BW34	54	ZB4BZ103	51	ZB5AA54	81	ZB5AH02	83
ZB4BW343	54	ZB4BZ1033	51	ZB5AA58	81	ZB5AH03	83
ZB4BW35	54	ZB4BZ1034	59	ZB5AA58	89	ZB5AH033	90
ZB4BW353	54	ZB4BZ1036	51	ZB5AA6	81	ZB5AH04	83
ZB4BW36	54	ZB4BZ104	51	ZB5AA64	81	ZB5AH043	90
ZB4BW363	54	ZB4BZ1043	51	ZB5AA68	81	ZB5AH05	83
ZB4BW37	54	ZB4BZ1044	59	ZB5AA68	89	ZB5AH053	90
ZB4BW433	54	ZB4BZ1046	51	ZB5AA8	81	ZB5AH06	83
ZB4BW443	54	ZB4BZ105	51	ZB5AA8112	83	ZB5AH063	90
ZB4BW453	54	ZB4BZ1053	51	ZB5AA8134	83	ZB5AH1	83
ZB4BW463	54	ZB4BZ1054	59	ZB5AA8212	83	ZB5AH13	90
ZB4BW473	54	ZB4BZ1056	51	ZB5AA8234	83	ZB5AH2	83
ZB4BW513	54	ZB4BZ141	51	ZB5AA9	81	ZB5AH3	83
ZB4BW533	54	ZB4BZ1905	66	ZB5AA9112	83	ZB5AH33	90
ZB4BW543	54	ZB4BZ62	66	ZB5AA9134	83	ZB5AH4	83
ZB4BW553	54	ZB4BZ905	66	ZB5AA9212	83	ZB5AH43	90
ZB4BW563	54	ZB4SZ3	66	ZB5AA9234	83	ZB5AH5	83
ZB4BW633	55	ZB5AA0	81	ZB5AC2	82	ZB5AH53	90
ZB4BW643	55	ZB5AA1	81	ZB5AC24	82	ZB5AH6	83

Push Buttons and Operator Interface Specifiers Guide

Indexed Catalog Numbers

ZB5AH63	90	ZB5AL8334	83	ZB5AV033	88	ZB5AW0B51	92
ZB5AJ2	85	ZB5AL8412	83	ZB5AV033S	88	ZB5AW0B52	92
ZB5AJ3	85	ZB5AL8434	83	ZB5AV04	88	ZB5AW0B53	92
ZB5AJ4	85	ZB5AL9312	83	ZB5AV043	88	ZB5AW0B55	92
ZB5AJ5	85	ZB5AL9334	83	ZB5AV043S	88	ZB5AW0B61	92
ZB5AJ7	85	ZB5AL9412	83	ZB5AV05	88	ZB5AW0B62	92
ZB5AJ8	85	ZB5AL9434	83	ZB5AV053	88	ZB5AW0B63	92
ZB5AK1213	91	ZB5AP1	81	ZB5AV053S	88	ZB5AW0B65	92
ZB5AK1233	91	ZB5AP18	81	ZB5AV06	88	ZB5AW0G11	92
ZB5AK1243	91	ZB5AP2	81	ZB5AV063	88	ZB5AW0G12	92
ZB5AK1253	91	ZB5AP3	81	ZB5AV063S	88	ZB5AW0G13	92
ZB5AK1263	91	ZB5AP38	81	ZB5AV07	88	ZB5AW0G15	92
ZB5AK1313	91	ZB5AP4	81	ZB5AV3	88	ZB5AW0G31	92
ZB5AK1333	91	ZB5AP48	81	ZB5AV4	88	ZB5AW0G32	92
ZB5AK1343	91	ZB5AP5	81	ZB5AV5	88	ZB5AW0G33	92
ZB5AK1353	91	ZB5AP58	81	ZB5AV6	88	ZB5AW0G35	92
ZB5AK1363	91	ZB5AP6	81	ZB5AV8	88	ZB5AW0G41	92
ZB5AK1413	91	ZB5AP68	81	ZB5AV9	88	ZB5AW0G42	92
ZB5AK1433	91	ZB5AR2	82	ZB5AVB1	88	ZB5AW0G43	92
ZB5AK1443	91	ZB5AR3	82	ZB5AVB3	88	ZB5AW0G45	92
ZB5AK1453	91	ZB5AR4	82	ZB5AVB4	88	ZB5AW0G51	92
ZB5AK1463	91	ZB5AR5	82	ZB5AVB5	88	ZB5AW0G52	92
ZB5AK1513	91	ZB5AR6	82	ZB5AVB6	88	ZB5AW0G53	92
ZB5AK1533	91	ZB5AS12	84	ZB5AVG1	88	ZB5AW0G55	92
ZB5AK1543	91	ZB5AS14	84	ZB5AVG3	88	ZB5AW0G61	92
ZB5AK1553	91	ZB5AS22	84	ZB5AVG4	88	ZB5AW0G62	92
ZB5AK1563	91	ZB5AS24	84	ZB5AVG5	88	ZB5AW0G63	92
ZB5AK1713	91	ZB5AS42	84	ZB5AVG6	88	ZB5AW0G65	92
ZB5AK1733	91	ZB5AS44	84	ZB5AW031	92	ZB5AW11	89
ZB5AK1743	91	ZB5AS52	84	ZB5AW035	92	ZB5AW113	89
ZB5AK1753	91	ZB5AS54	84	ZB5AW041	92	ZB5AW13	89
ZB5AK1763	91	ZB5AS55	84	ZB5AW045	92	ZB5AW133	89
ZB5AK1813	91	ZB5AS62	84	ZB5AW051	92	ZB5AW14	89
ZB5AK1833	91	ZB5AS64	84	ZB5AW055	92	ZB5AW143	89
ZB5AK1843	91	ZB5AS72	84	ZB5AW061	92	ZB5AW15	89
ZB5AK1853	91	ZB5AS74	84	ZB5AW062	92	ZB5AW153	89
ZB5AK1863	91	ZB5AS834	84	ZB5AW063	92	ZB5AW16	89
ZB5AL1	81	ZB5AS844	84	ZB5AW065	92	ZB5AW163	89
ZB5AL2	81	ZB5AS934	84	ZB5AW0B11	92	ZB5AW17	89
ZB5AL232	82	ZB5AS944	84	ZB5AW0B12	92	ZB5AW31	89
ZB5AL234	82	ZB5AS964	84	ZB5AW0B13	92	ZB5AW313	89
ZB5AL235	82	ZB5AT2	84	ZB5AW0B15	92	ZB5AW33	89
ZB5AL3	81	ZB5AT24	84	ZB5AW0B31	92	ZB5AW333	89
ZB5AL4	81	ZB5AT4	84	ZB5AW0B32	92	ZB5AW34	89
ZB5AL432	82	ZB5AT44	84	ZB5AW0B33	92	ZB5AW343	89
ZB5AL434	82	ZB5AT84	84	ZB5AW0B35	92	ZB5AW35	89
ZB5AL435	82	ZB5AV01	88	ZB5AW0B41	92	ZB5AW353	89
ZB5AL5	81	ZB5AV013	88	ZB5AW0B42	92	ZB5AW36	89
ZB5AL6	81	ZB5AV013S	88	ZB5AW0B43	92	ZB5AW363	89
ZB5AL8312	83	ZB5AV03	88	ZB5AW0B45	92	ZB5AW37	89

Push Buttons and Operator Interface Specifiers Guide

Indexed Catalog Numbers

ZB5AW433	89	ZB5AZ1044	94	ZB5SZ3	115	ZB6AGH	20
ZB5AW443	89	ZB5AZ1046	86	ZB5SZ3	66	ZB6AGJ	20
ZB5AW453	89	ZB5AZ105	86	ZB5SZ5	101	ZB6AGK	20
ZB5AW463	89	ZB5AZ1053	86	ZB6AA1	15	ZB6AGL	20
ZB5AW473	89	ZB5AZ1054	94	ZB6AA2	15	ZB6AGM	20
ZB5AW513	89	ZB5AZ1056	86	ZB6AA3	15	ZB6AGN	20
ZB5AW533	89	ZB5AZ141	86	ZB6AA4	15	ZB6AGP	20
ZB5AW543	89	ZB5AZ1414	94	ZB6AA5	15	ZB6AGQ	20
ZB5AW553	89	ZB5AZ31	101	ZB6AA6	15	ZB6AGR	20
ZB5AW563	89	ZB5AZ901	101	ZB6AA9	15	ZB6AGS	20
ZB5AW733	90	ZB5AZ901	115	ZB6AC1	15	ZB6AGT	20
ZB5AW743	90	ZB5AZ902	101	ZB6AC2	15	ZB6AS834	15
ZB5AW753	90	ZB5AZ905	101	ZB6AC3	15	ZB6AS934	15
ZB5AW763	90	ZB5AZ905	115	ZB6AC5	15	ZB6AV0	14
ZB5AW773	90	ZB5CA1	81	ZB6AC6	15	ZB6AV1	14
ZB5AW811723	90	ZB5CA2	81	ZB6AD02	17	ZB6AV3	14
ZB5AW812743	90	ZB5CA3	81	ZB6AD03	17	ZB6AV4	14
ZB5AW813743	90	ZB5CA331	82	ZB6AD04	17	ZB6AV5	14
ZB5AW821723	90	ZB5CA4	81	ZB6AD05	17	ZB6AV6	14
ZB5AW822743	90	ZB5CA432	82	ZB6AD06	17	ZB6AV9	14
ZB5AW823743	90	ZB5CA5	81	ZB6AD07	17	ZB6AW0	14
ZB5AW831723	90	ZB5CA6	81	ZB6AD08	17	ZB6AW0	15
ZB5AW832743	90	ZB5CH01	83	ZB6AD22	16	ZB6AW1	14
ZB5AW833743	90	ZB5CH02	83	ZB6AD23	16	ZB6AW3	14
ZB5AW841723	90	ZB5CH03	83	ZB6AD24	16	ZB6AW4	14
ZB5AW842743	90	ZB5CH04	83	ZB6AD25	16	ZB6AW5	14
ZB5AW843743	90	ZB5CH05	83	ZB6AD26	16	ZB6AW6	14
ZB5AX2	84	ZB5CH06	83	ZB6AD27	16	ZB6AW9	14
ZB5AX4	84	ZB5CL1	81	ZB6AD28	16	ZB6CA1	15
ZB5AZ009	115	ZB5CL2	81	ZB6AE0	14	ZB6CA2	15
ZB5AZ009	86	ZB5CL3	81	ZB6AE1	14	ZB6CA3	15
ZB5AZ009	93	ZB5CL4	81	ZB6AE3	14	ZB6CA4	15
ZB5AZ009	95	ZB5CL5	81	ZB6AE4	14	ZB6CA5	15
ZB5AZ079	95	ZB5CL6	81	ZB6AE5	14	ZB6CA6	15
ZB5AZ101	86	ZB5CV013	88	ZB6AE6	14	ZB6CA9	15
ZB5AZ1013	86	ZB5CV033	88	ZB6AE9	14	ZB6CD02	17
ZB5AZ1014	94	ZB5CV043	88	ZB6AF0	14	ZB6CD03	17
ZB5AZ1016	86	ZB5CV053	88	ZB6AF1	14	ZB6CD04	17
ZB5AZ1019	86	ZB5CV063	88	ZB6AF3	14	ZB6CD05	17
ZB5AZ102	86	ZB5CW113	89	ZB6AF4	14	ZB6CD06	17
ZB5AZ1023	86	ZB5CW133	89	ZB6AF5	14	ZB6CD07	17
ZB5AZ1024	94	ZB5CW143	89	ZB6AF6	14	ZB6CD08	17
ZB5AZ1026	86	ZB5CW153	89	ZB6AF9	14	ZB6CD22	16
ZB5AZ1029	86	ZB5CW163	89	ZB6AGA	20	ZB6CD23	16
ZB5AZ103	86	ZB5CW313	89	ZB6AGB	20	ZB6CD24	16
ZB5AZ1033	86	ZB5CW333	89	ZB6AGC	20	ZB6CD25	16
ZB5AZ1034	94	ZB5CW343	89	ZB6AGD	20	ZB6CD26	16
ZB5AZ1036	86	ZB5CW353	89	ZB6AGE	20	ZB6CD27	16
ZB5AZ104	86	ZB5CW363	89	ZB6AGF	20	ZB6CD28	16
ZB5AZ1043	86	ZB5SZ3	101	ZB6AGG	20	ZB6CE0	13

Push Buttons and Operator Interface Specifiers Guide

Indexed Catalog Numbers

ZB6CE1	13	ZB6DA5	15	ZB6DV1	14	ZB6Y018	24
ZB6CE3	13	ZB6DA6	15	ZB6DV3	14	ZB6Y019	24
ZB6CE4	13	ZB6DA9	15	ZB6DV4	14	ZB6Y7001	24
ZB6CE5	13	ZB6DD02	17	ZB6DV5	14	ZB6Y7130	24
ZB6CE6	13	ZB6DD03	17	ZB6DV6	14	ZB6Y7330	24
ZB6CE9	13	ZB6DD05	17	ZB6DV9	14	ZB6Y905	24
ZB6CF0	13	ZB6DD06	17	ZB6DW0	13	ZB6YA001	24
ZB6CF1	13	ZB6DD07	17	ZB6DW0	15	ZB6YA002	24
ZB6CF3	13	ZB6DD08	17	ZB6DW1	13	ZB6YA003	24
ZB6CF4	13	ZB6DD204	17	ZB6DW3	13	ZB6YA006	24
ZB6CF5	13	ZB6DD22	16	ZB6DW4	13	ZB6YA013	24
ZB6CF6	13	ZB6DD23	16	ZB6DW5	13	ZB6YA100	22
ZB6CF9	13	ZB6DD24	16	ZB6DW6	13	ZB6YA101	22
ZB6CGA	19	ZB6DD25	16	ZB6DW9	13	ZB6YA102	22
ZB6CGB	19	ZB6DD26	16	ZB6E1A	12	ZB6YA103	22
ZB6CGC	19	ZB6DD27	16	ZB6E1B	12	ZB6YA104	22
ZB6CGD	19	ZB6DD28	16	ZB6E1D	12	ZB6YA105	22
ZB6CGE	19	ZB6DE0	13	ZB6E1E	12	ZB6YA106	22
ZB6CGF	19	ZB6DE1	13	ZB6E2A	12	ZB6YA107	22
ZB6CGG	19	ZB6DE3	13	ZB6E2B	12	ZB6YA108	22
ZB6CGH	19	ZB6DE4	13	ZB6E2D	12	ZB6YA109	22
ZB6CGJ	19	ZB6DE5	13	ZB6E2E	12	ZB6YA111	22
ZB6CGK	19	ZB6DE6	13	ZB6EB1A	12	ZB6YA112	22
ZB6CGL	19	ZB6DE9	13	ZB6EB1B	12	ZB6YA113	22
ZB6CGM	19	ZB6DF0	13	ZB6EB3A	12	ZB6YA114	22
ZB6CGN	19	ZB6DF1	13	ZB6EB3B	12	ZB6YA115	22
ZB6CGP	19	ZB6DF3	13	ZB6EB4A	12	ZB6YA116	22
ZB6CGQ	19	ZB6DF4	13	ZB6EB4B	12	ZB6YA117	22
ZB6CGR	19	ZB6DF5	13	ZB6EB5A	12	ZB6YA118	22
ZB6CGS	19	ZB6DF6	13	ZB6EB5B	12	ZB6YA119	23
ZB6CGT	19	ZB6DF9	13	ZB6EB6A	12	ZB6YA120	23
ZB6CV0	14	ZB6DGA	18	ZB6EB6B	12	ZB6YA121	23
ZB6CV1	14	ZB6DGB	18	ZB6EG0A	12	ZB6YA122	23
ZB6CV3	14	ZB6DGC	18	ZB6EG0B	12	ZB6YA127	23
ZB6CV4	14	ZB6DGD	18	ZB6EH0A	12	ZB6YA128	23
ZB6CV5	14	ZB6DGE	18	ZB6EH0B	2	ZB6YA129	23
ZB6CV6	14	ZB6DGF	18	ZB6EM0A	12	ZB6YA130	23
ZB6CV9	14	ZB6DGG	18	ZB6EM0B	12	ZB6YA131	23
ZB6CW0	13	ZB6DGH	18	ZB6Y001	24	ZB6YA132	23
ZB6CW0	15	ZB6DGJ	18	ZB6Y002	24	ZB6YA133	23
ZB6CW1	13	ZB6DGK	18	ZB6Y003	24	ZB6YA134	23
ZB6CW3	13	ZB6DGL	18	ZB6Y004	24	ZB6YA200	22
ZB6CW4	13	ZB6DGM	18	ZB6Y005	24	ZB6YA201	22
ZB6CW5	13	ZB6DGN	18	ZB6Y006	24	ZB6YA202	22
ZB6CW6	13	ZB6DGP	18	ZB6Y007	24	ZB6YA203	22
ZB6CW9	13	ZB6DGQ	18	ZB6Y009	24	ZB6YA204	22
ZB6DA1	15	ZB6DGR	18	ZB6Y010	24	ZB6YA205	22
ZB6DA2	15	ZB6DGS	18	ZB6Y011	24	ZB6YA206	22
ZB6DA3	15	ZB6DGT	18	ZB6Y016	24	ZB6YA207	22
ZB6DA4	15	ZB6DV0	14	ZB6Y017	24	ZB6YA208	22

Push Buttons and Operator Interface Specifiers Guide

Indexed Catalog Numbers

ZB6YA209	22	ZB6YAW6	21	ZB6YC229	23	ZB6YD127	23
ZB6YA210	22	ZB6YB028	24	ZB6YC230	23	ZB6YD128	23
ZB6YA212	22	ZB6YC003	24	ZB6YC231	23	ZB6YD129	23
ZB6YA213	22	ZB6YC013	24	ZB6YC232	23	ZB6YD130	23
ZB6YA214	22	ZB6YC100	22	ZB6YC233	23	ZB6YD131	23
ZB6YA215	22	ZB6YC101	22	ZB6YC234	23	ZB6YD132	23
ZB6YA219	23	ZB6YC102	22	ZB6YC311	22	ZB6YD133	23
ZB6YA220	23	ZB6YC103	22	ZB6YC410	22	ZB6YD134	23
ZB6YA221	23	ZB6YC104	22	ZB6YCA1	21	ZB6YD2	23
ZB6YA222	23	ZB6YC105	22	ZB6YCA2	21	ZB6YD200	22
ZB6YA223	22	ZB6YC106	22	ZB6YCA3	21	ZB6YD201	22
ZB6YA224	22	ZB6YC107	22	ZB6YCA4	21	ZB6YD202	22
ZB6YA225	22	ZB6YC108	22	ZB6YCA5	21	ZB6YD203	22
ZB6YA227	23	ZB6YC109	22	ZB6YCA6	21	ZB6YD204	22
ZB6YA228	23	ZB6YC111	22	ZB6YCE1	21	ZB6YD205	22
ZB6YA229	23	ZB6YC112	22	ZB6YCE3	21	ZB6YD206	22
ZB6YA230	23	ZB6YC113	22	ZB6YCE4	1	ZB6YD207	22
ZB6YA231	23	ZB6YC114	22	ZB6YCE5	21	ZB6YD208	22
ZB6YA232	23	ZB6YC119	23	ZB6YCE6	21	ZB6YD209	22
ZB6YA233	23	ZB6YC120	23	ZB6YCV1	21	ZB6YD210	22
ZB6YA234	23	ZB6YC121	23	ZB6YCV3	21	ZB6YD212	22
ZB6YA311	22	ZB6YC122	23	ZB6YCV4	21	ZB6YD213	22
ZB6YA316	22	ZB6YC127	23	ZB6YCV5	21	ZB6YD214	22
ZB6YA317	22	ZB6YC128	23	ZB6YCV6	21	ZB6YD219	23
ZB6YA318	22	ZB6YC129	23	ZB6YCW1	21	ZB6YD220	23
ZB6YA410	22	ZB6YC130	23	ZB6YCW3	21	ZB6YD221	23
ZB6YA423	22	ZB6YC131	23	ZB6YCW4	21	ZB6YD222	23
ZB6YA424	22	ZB6YC132	23	ZB6YCW5	21	ZB6YD227	23
ZB6YA425	22	ZB6YC133	23	ZB6YCW6	21	ZB6YD228	23
ZB6YA426	22	ZB6YC134	23	ZB6YD001	24	ZB6YD229	23
ZB6YAA1	21	ZB6YC200	22	ZB6YD003	24	ZB6YD230	23
ZB6YAA2	21	ZB6YC201	22	ZB6YD013	24	ZB6YD231	23
ZB6YAA3	21	ZB6YC202	22	ZB6YD100	22	ZB6YD232	23
ZB6YAA4	21	ZB6YC203	22	ZB6YD101	22	ZB6YD233	23
ZB6YAA5	21	ZB6YC204	22	ZB6YD102	22	ZB6YD234	23
ZB6YAA6	21	ZB6YC205	22	ZB6YD103	22	ZB6YD311	22
ZB6YAE1	21	ZB6YC206	22	ZB6YD104	22	ZB6YD4	23
ZB6YAE3	21	ZB6YC207	22	ZB6YD105	22	ZB6YD410	22
ZB6YAE4	21	ZB6YC208	22	ZB6YD106	22	ZB6YDA1	21
ZB6YAE5	21	ZB6YC209	22	ZB6YD107	22	ZB6YDA2	21
ZB6YAE6	21	ZB6YC210	22	ZB6YD108	22	ZB6YDA3	21
ZB6YAV1	21	ZB6YC212	22	ZB6YD109	22	ZB6YDA4	21
ZB6YAV3	21	ZB6YC213	22	ZB6YD111	22	ZB6YDA5	21
ZB6YAV4	21	ZB6YC214	22	ZB6YD112	22	ZB6YDA6	21
ZB6YAV5	21	ZB6YC219	23	ZB6YD113	22	ZB6YDE1	21
ZB6YAV6	21	ZB6YC220	23	ZB6YD114	22	ZB6YDE3	21
ZB6YAW1	21	ZB6YC221	23	ZB6YD119	23	ZB6YDE4	21
ZB6YAW3	21	ZB6YC222	23	ZB6YD120	23	ZB6YDE5	21
ZB6YAW4	21	ZB6YC227	23	ZB6YD121	23	ZB6YDE6	21
ZB6YAW5	21	ZB6YC228	23	ZB6YD122	23	ZB6YDV1	21

Push Buttons and Operator Interface Specifiers Guide

Indexed Catalog Numbers

ZB6YDV3	21	ZBA2	65	ZBCW9113	102	ZBE204	51
ZB6YDV4	21	ZBA232	100	ZBCW9133	102	ZBE204	58
ZB6YDV5	21	ZBA232	65	ZBCW9143	102	ZBE204	86
ZB6YDV6	21	ZBA234	100	ZBCW9153	102	ZBE204	93
ZB6YDW1	21	ZBA234	65	ZBCW9163	102	ZBE205	51
ZB6YDW3	21	ZBA235	100	ZBCW9313	102	ZBE205	58
ZB6YDW4	21	ZBA235	65	ZBCW9333	102	ZBE205	86
ZB6YDW5	21	ZBA245	100	ZBCW9343	102	ZBE205	93
ZB6YDW6	21	ZBA245	65	ZBCW9353	102	ZBE701	60
ZB6YG095	24	ZBA3	100	ZBCW9363	102	ZBE701	95
ZB6YJ012	24	ZBA3	65	ZBCY2H101	98	ZBE7016	60
ZB6YK1	23	ZBA331	100	ZBCY4H101	98	ZBE7016	95
ZB6YK3	23	ZBA331	65	ZBCY6H101	98	ZBE702	60
ZB6YK4	23	ZBA333	100	ZBCY6H102	98	ZBE702	95
ZB6YK5	23	ZBA333	65	ZBCZ34	98	ZBE7026	60
ZB6YK6	23	ZBA334	100	ZBCZ35	98	ZBE7026	95
ZB6Z1B	11	ZBA334	65	ZBE101	115	ZBG2201	52
ZB6Z2B	11	ZBA335	100	ZBE101	51	ZBG2401	52
ZB6Z3B	11	ZBA335	65	ZBE101	58	ZBG3131A	101
ZB6Z4B	11	ZBA341	100	ZBE101	86	ZBG3131A	66
ZB6Z5B	11	ZBA341	65	ZBE101	93	ZBG4201	52
ZB6Z6B	11	ZBA343	100	ZBE1013	51	ZBG421E	101
ZB6Z7B	11	ZBA343	65	ZBE1013	86	ZBG421E	66
ZB6Z8B	11	ZBA344	100	ZBE1014	59	ZBG455	101
ZB6Z9B	11	ZBA344	65	ZBE1014	94	ZBG455	66
ZB6ZB11B	11	ZBA345	65	ZBE1016	51	ZBG458A	101
ZB6ZB15B	11	ZBA346	100	ZBE1016	58	ZBG458A	66
ZB6ZB31B	11	ZBA346	100	ZBE1016	86	ZBG520E	101
ZB6ZB35B	11	ZBA346	65	ZBE1016	93	ZBG520E	66
ZB6ZB42B	11	ZBA4	100	ZBE1019	51	ZBL1	100
ZB6ZB45B	11	ZBA4	65	ZBE1019	86	ZBL1	65
ZB6ZB51B	11	ZBA432	100	ZBE102	115	ZBL2	100
ZB6ZB52B	11	ZBA432	65	ZBE102	51	ZBL2	65
ZB6ZB55B	11	ZBA434	100	ZBE102	58	ZBL3	100
ZB6ZB61B	11	ZBA434	65	ZBE102	86	ZBL3	65
ZB6ZB65B	11	ZBA435	100	ZBE102	93	ZBL4	100
ZB6ZH01B	11	ZBA435	65	ZBE1023	51	ZBL4	65
ZB6ZH02B	11	ZBA5	100	ZBE1023	86	ZBL432	100
ZB6ZH05B	11	ZBA5	65	ZBE1024	59	ZBL432	65
ZBA1	100	ZBA6	100	ZBE1024	94	ZBL5	100
ZBA1	65	ZBA6	65	ZBE1026	51	ZBL5	65
ZBA131	100	ZBA639	100	ZBE1026	58	ZBL6	100
ZBA131	65	ZBA639	65	ZBE1026	86	ZBL6	65
ZBA133	100	ZBA9	100	ZBE1026	93	ZBL9	100
ZBA133	65	ZBA9	65	ZBE1029	51	ZBL9	65
ZBA141	100	ZBCV0113	102	ZBE1029	86	ZBP0	102
ZBA141	65	ZBCV0133	102	ZBE203	51	ZBP0	7
ZBA145	100	ZBCV0143	102	ZBE203	58	ZBP0A	102
ZBA145	65	ZBCV0153	102	ZBE203	86	ZBP0A	67
ZBA2	00	ZBCV0163	102	ZBE203	93	ZBV011	102

Push Buttons and Operator Interface Specifiers Guide

Indexed Catalog Numbers

ZBV011	67	ZBVB57	95	ZBVM5	93	ZBW936	67
ZBV0113	102	ZBVB6	115	ZBVM54	59	ZBW9363	102
ZBV0113	67	ZBVB6	58	ZBVM54	94	ZBW9363	67
ZBV013	102	ZBVB6	93	ZBVM6	115	ZBW937	102
ZBV013	67	ZBVB64	59	ZBVM6	93	ZBW937	67
ZBV0133	102	ZBVB64	94	ZBVM64	59	ZBY001	58
ZBV0133	67	ZBVB67	60	ZBVM64	94	ZBY001	86
ZBV014	102	ZBVB67	95	ZBW008	102	ZBY001	93
ZBV014	67	ZBVG1	115	ZBW008	67	ZBY01001	63
ZBV0143	102	ZBVG1	58	ZBW008A	102	ZBY01001	98
ZBV0143	67	ZBVG1	93	ZBW008A	67	ZBY01002	63
ZBV015	102	ZBVG14	59	ZBW911	102	ZBY01002	98
ZBV015	67	ZBVG14	94	ZBW911	67	ZBY01004	63
ZBV0153	102	ZBVG3	115	ZBW9113	102	ZBY01004	98
ZBV0153	67	ZBVG3	58	ZBW9113	67	ZBY01005	63
ZBV016	102	ZBVG3	93	ZBW913	102	ZBY01005	98
ZBV016	67	ZBVG34	59	ZBW913	67	ZBY0101	63
ZBV0163	102	ZBVG34	94	ZBW9133	102	ZBY0101	98
ZBV0163	67	ZBVG4	115	ZBW9133	67	ZBY0102	63
ZBV017	102	ZBVG4	58	ZBW914	102	ZBY0102	98
ZBV017	67	ZBVG4	93	ZBW914	67	ZBY02115	64
ZBV6	58	ZBVG44	59	ZBW9143	102	ZBY02115	99
ZBV6	93	ZBVG44	94	ZBW9143	67	ZBY02146	64
ZBVB1	115	ZBVG5	115	ZBW915	102	ZBY02146	99
ZBVB1	58	ZBVG5	58	ZBW915	67	ZBY02147	64
ZBVB1	93	ZBVG5	93	ZBW9153	102	ZBY02147	99
ZBVB14	59	ZBVG54	59	ZBW9153	67	ZBY02148	64
ZBVB14	94	ZBVG54	94	ZBW916	102	ZBY02148	99
ZBVB17	60	ZBVG6	115	ZBW916	67	ZBY02178	64
ZBVB17	95	ZBVG6	58	ZBW9163	102	ZBY02178	99
ZBVB3	115	ZBVG6	93	ZBW9163	67	ZBY02179	64
ZBVB3	58	ZBVG64	59	ZBW917	102	ZBY02179	99
ZBVB3	93	ZBVG64	94	ZBW917	67	ZBY02186	64
ZBVB34	59	ZBVM1	115	ZBW931	102	ZBY02186	99
ZBVB34	94	ZBVM1	58	ZBW931	67	ZBY02303	64
ZBVB37	60	ZBVM1	93	ZBW9313	102	ZBY02303	99
ZBVB37	95	ZBVM14	59	ZBW9313	67	ZBY02304	64
ZBVB4	115	ZBVM14	94	ZBW933	102	ZBY02304	99
ZBVB4	58	ZBVM3	115	ZBW933	67	ZBY02305	64
ZBVB4	93	ZBVM3	58	ZBW9333	102	ZBY02305	99
ZBVB44	59	ZBVM3	93	ZBW9333	67	ZBY02306	64
ZBVB44	94	ZBVM34	59	ZBW934	102	ZBY02306	99
ZBVB47	60	ZBVM34	94	ZBW934	67	ZBY02307	64
ZBVB47	95	ZBVM4	115	ZBW9343	102	ZBY02307	99
ZBVB5	115	ZBVM4	58	ZBW9343	67	ZBY02308	64
ZBVB5	58	ZBVM4	93	ZBW935	102	ZBY02308	99
ZBVB5	93	ZBVM44	59	ZBW935	67	ZBY02309	64
ZBVB54	59	ZBVM44	94	ZBW9353	102	ZBY02309	99
ZBVB54	94	ZBVM5	115	ZBW9353	67	ZBY02310	64
ZBVB57	60	ZBVM5	58	ZBW936	102	ZBY02310	99

Push Buttons and Operator Interface Specifiers Guide

Indexed Catalog Numbers

ZBY02311 64	ZBY1101 64	ZBY2308 62	ZBY4001 62
ZBY02311 99	ZBY1101 99	ZBY2308 97	ZBY4001 97
ZBY02312 64	ZBY1146 64	ZBY2309 62	ZBY4005 62
ZBY02312 99	ZBY1146 99	ZBY2309 97	ZBY4005 97
ZBY02313 64	ZBY1147 99	ZBY2310 62	ZBY4100 63
ZBY02313 99	ZBY1148 99	ZBY2310 97	ZBY4100 98
ZBY02314 64	ZBY1149 64	ZBY2311 62	ZBY4101 62
ZBY02314 99	ZBY1149 99	ZBY2311 97	ZBY4101 97
ZBY02316 64	ZBY1303 64	ZBY2312 62	ZBY4H101 63
ZBY02316 99	ZBY1303 99	ZBY2312 97	ZBY4H101 98
ZBY02321 64	ZBY1304 64	ZBY2313 62	ZBY5100 63
ZBY02321 99	ZBY1304 99	ZBY2313 97	ZBY5100 98
ZBY02322 64	ZBY1311 64	ZBY2314 62	ZBY5101 63
ZBY02322 99	ZBY1311 99	ZBY2314 97	ZBY5101 98
ZBY02323 64	ZBY1312 64	ZBY2316 62	ZBY5102 63
ZBY02323 99	ZBY1312 99	ZBY2316 97	ZBY5102 98
ZBY02326 64	ZBY1316 64	ZBY2321 62	ZBY6101 63
ZBY02326 99	ZBY1316 99	ZBY2321 97	ZBY6101 98
ZBY02327 64	ZBY1912 64	ZBY2322 62	ZBY6102 63
ZBY02327 99	ZBY1912 99	ZBY2322 97	ZBY6102 98
ZBY02328 64	ZBY2002 62	ZBY2323 62	ZBY6H101 63
ZBY02328 99	ZBY2002 97	ZBY2323 97	ZBY6H101 98
ZBY02330 64	ZBY2004 2	ZBY2326 62	ZBY6H102 63
ZBY02330 99	ZBY2004 97	ZBY2326 97	ZBY6H102 98
ZBY02334 64	ZBY2101 62	ZBY2327 62	ZBY8101 49
ZBY02334 99	ZBY2101 97	ZBY2327 97	ZBY8101 63
ZBY02364 64	ZBY2115 62	ZBY2328 62	ZBY8101 84
ZBY02364 99	ZBY2115 97	ZBY2328 97	ZBY8101 98
ZBY02366 64	ZBY2146 62	ZBY2330 62	ZBY8130 98
ZBY02366 99	ZBY2146 97	ZBY2330 97	ZBY8330 49
ZBY02367 64	ZBY2147 62	ZBY2334 62	ZBY8330 63
ZBY02367 99	ZBY2147 97	ZBY2334 97	ZBY8330 84
ZBY02371 64	ZBY2148 62	ZBY2364 62	ZBY8330 98
ZBY02371 99	ZBY2148 97	ZBY2364 97	ZBY9101 49
ZBY02382 64	ZBY2178 62	ZBY2366 62	ZBY9101 63
ZBY02382 99	ZBY2178 97	ZBY2366 97	ZBY9101 84
ZBY02385 64	ZBY2179 62	ZBY2367 62	ZBY9101 98
ZBY02385 99	ZBY2179 97	ZBY2367 97	ZBY9130 98
ZBY02387 64	ZBY2186 62	ZBY2371 62	ZBY9330 49
ZBY02387 99	ZBY2186 97	ZBY2371 97	ZBY9330 63
ZBY02931 64	ZBY2303 62	ZBY2382 62	ZBY9330 84
ZBY02931 99	ZBY2303 97	ZBY2382 97	ZBY9330 98
ZBY05001 63	ZBY2304 62	ZBY2385 62	ZBZ001 51
ZBY05001 98	ZBY2304 97	ZBY2385 97	ZBZ001 58
ZBY05002 63	ZBY2305 62	ZBY2387 62	ZBZ001 86
ZBY05002 98	ZBY2305 97	ZBY2387 97	ZBZ001 93
ZBY05004 63	ZBY2306 62	ZBY2931 62	ZBZ006 60
ZBY05004 98	ZBY2306 97	ZBY2931 97	ZBZ006 95
ZBY05005 63	ZBY2307 62	ZBY2H101 63	ZBZ010 60
ZBY05005 98	ZBY2307 97	ZBY2H101 98	ZBZ010 95

Push Buttons and Operator Interface Specifiers Guide Indexed Catalog Numbers

ZBZ1602	101
ZBZ1602	66
ZBZ1604	101
ZBZ1604	66
ZBZ1605	101
ZBZ1605	66
ZBZ1606	101
ZBZ1606	66
ZBZ32	62
ZBZ32	97
ZBZ33	63
ZBZ33	98
ZBZ34	63
ZBZ34	98
ZBZ35	63
ZBZ35	98
ZBZ41	66
ZBZ8	101
ZBZ8	66
ZENL1111	115
ZENL1121	115

Schneider Electric USA

8001 Highway 64 East
Knightdale, NC 27545
1-888-SquareD
(1-888-778-2733)
www.us.SquareD.com

Schneider Electric Canada

19 Waterman Avenue,
M4B 1 Y2
Toronto, Ontario
1-800-565-6699
www.schneider-electric.ca

9001CT0001R4/05 © 1999-2005 Schneider Electric All Rights Reserved
Replaces 9001CT0001, dated 11/00

04/2005