

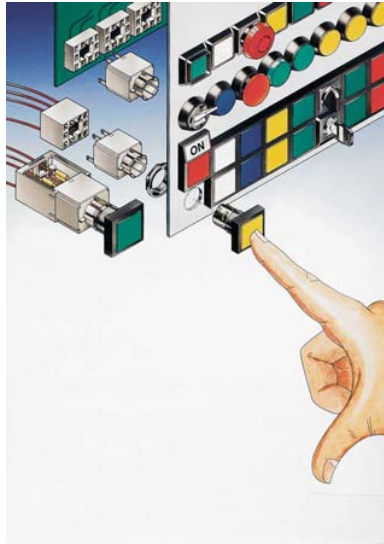

# Control components

	<b>Page</b>
<b>RAFIX 16</b>	<b>2 - 3</b>
RAFIX 16 pushbutton	2 - 8
RAFIX 16 selector switch	2 - 18
RAFIX 16 keylock switch MICROMECC	2 - 22
RAFIX 16 keylock switch, RONIS	2 - 26
RAFIX 16 mushroom-headed pushbutton	2 - 30
RAFIX 16 emergency stop pushbutton	2 - 34
RAFIX 16 toggle switch	2 - 40
RAFIX 16 potentiometer drive	2 - 42
RAFIX 16 buzzer	2 - 44
RAFIX 16 signal indicator	2 - 46
RAFIX 16 contact blocks with gold contacts	2 - 52
RAFIX 16 contact blocks with silver contacts	2 - 56
RAFIX 16 lamp socket	2 - 60
RAFIX 16 special accessories	2 - 62
<b>RAFIX 16 F</b>	<b>2 - 69</b>
RAFIX 16 F pushbutton	2 - 70
RAFIX 16 F selector switch	2 - 74
RAFIX 16 F keylock switch MICROMECC	2 - 76
RAFIX 16 F emergency stop pushbutton	2 - 78
RAFIX 16 F signal indicator	2 - 80
RAFIX 16 F special accessories	2 - 82
<b>RAFIX 22 QR</b>	<b>2 - 83</b>
RAFIX 22 QR pushbutton	2 - 88
RAFIX 22 QR selector switch	2 - 96
RAFIX 22 QR keylock switch	2 - 102
RAFIX 22 QR mushroom-headed pushbutton	2 - 106
RAFIX 22 QR emergency stop pushbutton, dupe-proof to EN 418	2 - 110
RAFIX 22 QR toggle switch	2 - 114
RAFIX 22 QR twin pushbutton	2 - 116
RAFIX 22 QR potentiometer drive	2 - 118
RAFIX 22 QR buzzer	2 - 120
RAFIX 22 QR signal indicator	2 - 122
RAFIX 22 QR contact blocks with silver contacts	2 - 124
RAFIX 22 QR contact blocks with gold contacts	2 - 128
Contact blocks with coupling, gold contacts, RJ 12 connector, integrated LED	2 - 132
RAFIX 22 QR lamp sockets BA 9s (MBC/MCC), screw terminals and cage clamp terminals	2 - 134
RAFIX 22 QR lamp sockets with integrated LED, screw terminals	2 - 138
RAFIX 22 QR special accessories	2 - 140
<b>RAFIX 22 FS</b>	<b>2 - 147</b>
RAFIX 22 FS pushbuttons	2 - 152
RAFIX 22 FS selector switches	2 - 160
RAFIX 22 FS keylock switch	2 - 164
RAFIX 22 FS emergency stop pushbutton	2 - 168
RAFIX 22 FS signal indicator	2 - 172
RAFIX 22 FS contact blocks with gold contacts	2 - 174
RAFIX 22 FS contact blocks with silver contacts	2 - 176
RAFIX 22 FS special accessories	2 - 178
<b>Control components</b>	<b>2 - 1</b>



**General data**

**RAFIX 16 control component range**

- For a mounting hole diameter of 16.2 mm to IEC 60947
- 250V/6A max.
- Water-jet proof IP65
- Contact blocks: Gold and silver contacts with quick-connect terminals 2.8 x 0.8 mm; Option: PCB plug-in socket
- 3 collar shapes, low-profile design
- The lamps of the pushbuttons can be replaced from the front or rear.
- The contact blocks snap directly onto the actuators without a coupling element and can be easily removed by turning = cost reducing assembly.

The specified data apply only if actuators/signal indicators are combined with contact blocks and lamp sockets within the same product range.

**Content**

<b>RAFIX 16 pushbutton</b>	<b>2 - 8</b>
RAFIX 16 pushbutton, flush lens, square collar	2 - 9
RAFIX 16 pushbutton, protruding lens, square collar	2 - 10
RAFIX 16 pushbutton, protruding collar, square collar	2 - 11
RAFIX 16 pushbutton, flush lens, round collar	2 - 12
RAFIX 16 pushbutton IP66 with protective cap	2 - 13
RAFIX 16 pushbutton, protruding lens, round collar	2 - 14
RAFIX 16 pushbutton, protruding collar, round collar	2 - 15
RAFIX 16 pushbutton, flush lens, square collar, alignable without gaps	2 - 16
<b>RAFIX 16 selector switch</b>	<b>2 - 18</b>
RAFIX 16 selector switch, square collar	2 - 19
RAFIX 16 selector switch, round collar	2 - 20
RAFIX 16 selector switch, square collar, alignable without gaps	2 - 21
<b>RAFIX 16 keylock switch MICROMECC</b>	<b>2 - 22</b>
RAFIX 16 keylock switch MICROMECC, square collar	2 - 23
RAFIX 16 keylock switch MICROMECC, round collar	2 - 24
RAFIX 16 keylock switch MICROMECC, square collar, alignable without gaps	2 - 25
<b>RAFIX 16 keylock switch, RONIS</b>	<b>2 - 26</b>
RAFIX 16 keylock switch, RONIS, square collar	2 - 27
RAFIX 16 keylock switch, RONIS, round collar	2 - 28
Keylock switch, RONIS, square collar, alignable without gaps	2 - 29

Control components	2 - 3
--------------------	-------

<b>RAFIX 16 mushroom-headed pushbutton</b>	<b>2 - 30</b>
RAFIX 16 mushroom-headed pushbutton, square collar	2 - 31
RAFIX 16 mushroom-headed pushbutton, round collar	2 - 31
RAFIX 16 mushroom-headed pushbutton, square collar, alignable without gaps	2 - 32
<b>RAFIX 16 emergency stop pushbutton</b>	<b>2 - 34</b>
RAFIX 16 emergency stop pushbutton, square collar, illuminated	2 - 35
RAFIX 16 emergency stop pushbutton, square collar, dupe-proof	2 - 35
RAFIX 16 emergency stop pushbutton, round collar, illuminated	2 - 36
RAFIX 16 emergency stop pushbutton, round collar, dupe-proof	2 - 36
RAFIX 16 emergency stop pushbutton, square collar, alignable without gaps, illuminated	2 - 37
RAFIX 16 emergency stop pushbutton, square collar, alignable without gaps, dupe-proof	2 - 37
RAFIX 16 safety emergency stop pushbutton, round collar, dupe-proof, non-blocking	2 - 38
RAFIX 16 safety emergency stop pushbutton, round collar, conical, dupe-proof, non-blocking	2 - 38
<b>RAFIX 16 toggle switch</b>	<b>2 - 40</b>
RAFIX 16 toggle switch, square collar	2 - 41
RAFIX 16 toggle switch, round collar	2 - 41
RAFIX 16 toggle switch, square collar, alignable without gaps	2 - 41
<b>RAFIX 16 potentiometer drive</b>	<b>2 - 42</b>
RAFIX 16 potentiometer drive, square collar	2 - 43
RAFIX 16 potentiometer drive, round collar	2 - 43
RAFIX 16 potentiometer drive, square collar, alignable without gaps	2 - 43
<b>RAFIX 16 buzzer</b>	<b>2 - 44</b>
RAFIX 16 buzzer, square collar	2 - 45
RAFIX 16 buzzer, round collar	2 - 45
RAFIX 16 buzzer, square collar, alignable without gaps	2 - 45
<b>RAFIX 16 signal indicator</b>	<b>2 - 46</b>
RAFIX 16 signal indicator, square lens	2 - 47
RAFIX 16 signal indicator, square collar, flush lens	2 - 47
RAFIX 16 signal indicator, round lens	2 - 48
RAFIX 16 signal indicator, square collar, protruding lens	2 - 48
RAFIX 16 signal indicator, round collar, flush lens	2 - 49
RAFIX 16 signal indicator, round collar, protruding lens	2 - 49
RAFIX 16 signal indicator, square collar, alignable without gaps, flush lens	2 - 50
RAFIX 16 signal indicator, square collar, alignable without gaps, protruding lens	2 - 50
<b>RAFIX 16 contact blocks with gold contacts</b>	<b>2 - 52</b>
RAFIX 16 standard contact block, gold contacts, with lamp socket	2 - 54
RAFIX 16 standard contact block, gold contacts, without lamp socket	2 - 54
RAFIX 16 universal contact block, gold contacts, with lamp socket	2 - 55
RAFIX 16 universal contact block, gold contacts, without lamp socket	2 - 55
<b>RAFIX 16 contact blocks with silver contacts</b>	<b>2 - 56</b>
RAFIX 16 standard contact block, silver contacts, with lamp socket	2 - 58
RAFIX 16 standard contact block, silver contacts, without lamp socket	2 - 58
RAFIX 16 universal contact block, silver contacts, with lamp socket	2 - 59
RAFIX 16 universal contact block, silver contacts, without lamp socket	2 - 59
<b>RAFIX 16 lamp socket</b>	<b>2 - 60</b>
RAFIX 16 lamp socket W 2 x 4.6 d	2 - 61
RAFIX 16 lamp socket W 2 x 4.6 d	2 - 61
<b>RAFIX 16 special accessories</b>	<b>2 - 62</b>
PCB plug-in socket	2 - 62
Multipole connector	2 - 63
Female quick-connect terminal DIN 46340-B 2.8-1-MS	2 - 63
Plug distributor	2 - 63
Protection against contact	2 - 64
Protection against contact	2 - 64
Series capacitor	2 - 64
Disassembly tool	2 - 65
Protective cover, suitable for lead seal, for pushbuttons, alignable without gaps	2 - 65
Fixing spanner for hexagon nut	2 - 65
RAFIX 16 insulating housing	2 - 66
RAFIX 16 label holder, flush, for square collar	2 - 66
RAFIX 16 label holder, flush, for round collar	2 - 67
RAFIX 16 label holder, protruding, for square flush fitting collar	2 - 67
Emergency stop label, yellow, round 60 mm, PVC adhesive	2 - 68
LUMOTAST 25, RAFIX 16 blanking cap complete with sealing disc and ring nut	2 - 68

# General information

RAFIX 16 is a complete control component series for a mounting hole diameter of 16.2 mm. It enables you to design attractive control panels with a minimum of space requirements and at the same time sufficiently large actuating areas.

## Actuators

- Mounting hole  $\varnothing$  16.2 mm to DIN EN 50 007

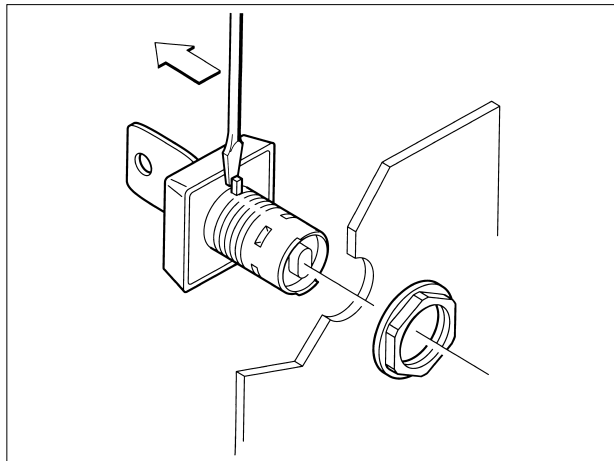
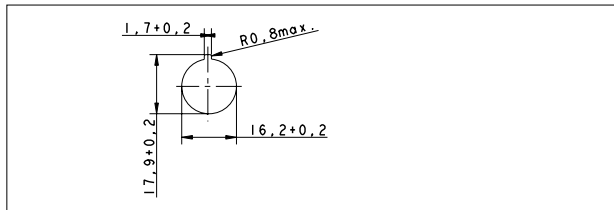

- Locating lug (easily removable).  
The locating lug can be easily removed using a screwdriver.
- Degree of protection IP 65 on panel.  
This is achieved by a reliable, tried and tested special seal.
- Grid spacing 25 x 25 mm
- Low-profile design, 7 mm height from front panel
- Three collar shapes, in black
  - Square 25 x 25 mm
  - Round 25 mm
  - Square 25 x 25 mm, alignable in flush fitting rows, which avoids accumulation of dirt between the collars.

## Contact blocks

- Standard (for actuators with one-way operation)
  - with latching mechanism (latching switch)
  - without latching mechanism (momentary switch)
- Universal (for actuators with two-way operation, e. g. selector switches)
  - without latching mechanism

## Contact material

- Silver contacts for mains voltage
- Gold contacts for electronic circuits

## Illumination

- Wedge base lamp W 2 x 4.6 d

## Assembly

- Single-handed cost-effective assembly method
- Panel thickness 0.5 ... 5 mm
- Fixing with hexagon nut
- Starting torque 1.2 Nm max.

## Shock-resistance according to IEC 600 68-2-27

- Shock amplitude:  $\leq 50$  g
- Shock time: 11 ms
- Shock type: half sinusoidal

## Environment conditions

- Constant environment: acc. to IEC 600 68-2-3 and 2-30
- Variable environment: acc. to IEC 600 68-2-14 and 2-33

## Temperature range

- Operating temperature:
  - non-illuminated: - 25 ... + 70 ° C
  - illuminated: - 25 ... + 55° C
- Storage temperature: - 40 ... + 85° C

**CE-Conformity RAFIX® 16**

Combination actuator and contact block	Order no.	Limit	EU-Directive	
			NSR 73/23	Ma. Dir. 89/392
All actuators	1.3007-.-.-		●	-
All contact blocks with silver contacts	1.2012-.-.-	6(4) A/250 V AC	●	-
Emergency stop	1.30074.-.-		●	●
Contact blocks with silver contacts	1.20123.-.-	6(4) A/250 V AC	●	●
Emergency stop, Universal	1.30074.-.-		-	●
contact blocks with gold contacts	1.20123.-.-	250 mA/42 V AC/DC	-	●
Signal indicator	1.62124.-.-		●	-
lamp socket	1.71212.-.-	1,2 W/60 V AC/DC	●	-

2

RAFIX  
16

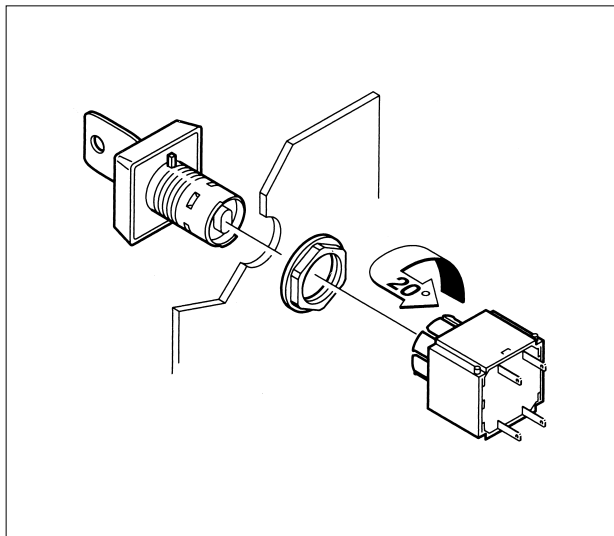

Assembly/Disassembly

**Assembly**

- Insert the actuator through the panel cut-out from the front.  
If there is no locating indent provided in the cut-out, first remove the locating lug using a screwdriver.
- Screw the hexagon nut onto the actuator or signal indicator from the rear and tighten it using a fixing spanner.
- Slide the contact block onto the actuator from the rear with an audible click.
- Install protection against accidental contact, if applicable.
- Connect quick-connect terminals.
- Alternatively, connect crimped female quick-connect terminals to multipole connector and plug it onto the contact block.
- Alternatively, connect the plug-in socket soldered onto the PCB.

**Disassembly**

- Turn the contact block by approx. 20° to the left or right – the latches open.
  - Pull the contact block off towards the rear (commercially available flat nose pliers recommended).
- To dismantle a PCB, pull the PCB with the soldered plug-in sockets off the mounted contact blocks.

**Legending**

All elements can be labelled using a separate label holder. The label holder is mounted together with the actuator/signal indicator. For order numbers and standard legend, refer to the section "Legending". Non-illuminated pushbuttons and mushroom-headed pushbuttons can be printed or laser engraved.

All illuminated pushbuttons and the majority of the signal indicators can be labelled by means of legend inserts. The legend inserts are fitted between actuator body and lens and can be easily changed.

RAFI can also provide you custom legending. Price and delivery on request.

**Lamp replacement from front**

Use the disassembly tool to grasp the actuator body and pull it towards the front with the lens.

Alternatively, you can use a screwdriver in place of the disassembly tool. In this case, insert the screwdriver between actuator body and collar and carefully raise the actuator body.

Replace the lamp using a lamp extractor or a suitable insulation sleeve.

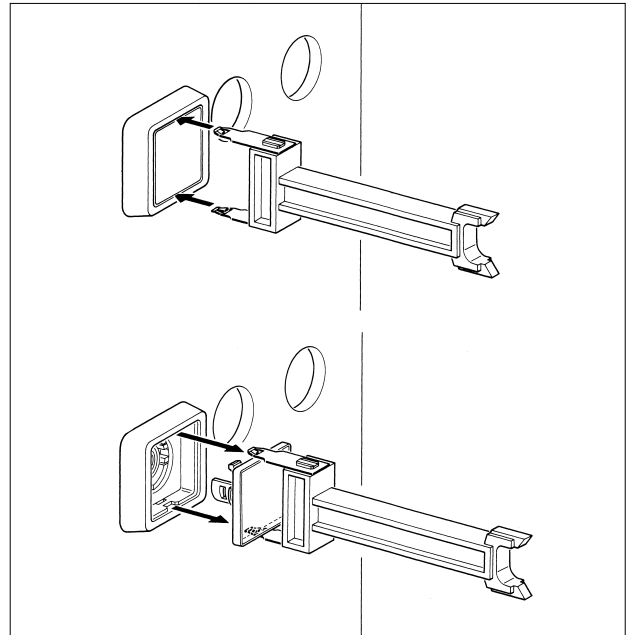

Lamp replacement from front

**RAFIX 16 pushbutton**

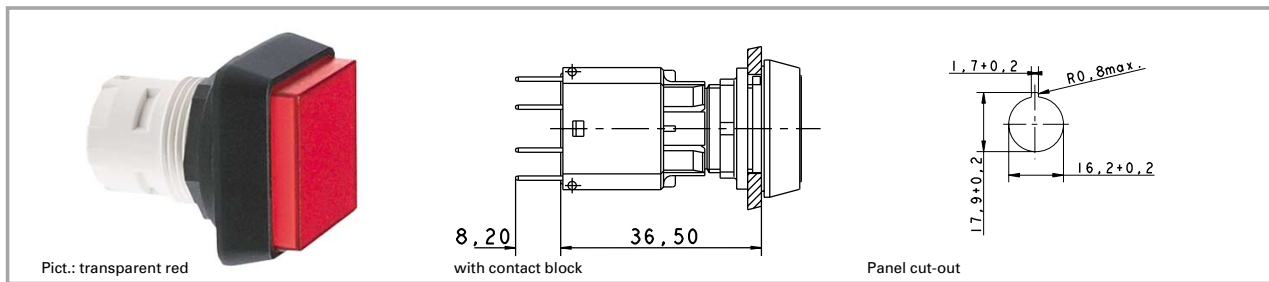

2

RAFIX  
16

**Technical data**

**General information**

Form of lens                   mushroom  
Colour of lens                 see order block  
Form of collar                 see order block

**Dimensions**

Length of collar               see order block  
Diameter of collar           see order block  
Key grid                       25 x 25 mm  
Width of collar               see order block  
Overall height               see order block  
Mounting depth              44.7 mm  
Mounting hole                16.2 mm

**Mechanical design**

Mounting                      ring nut  
Contact function             according to contact block  
Contact arrangement       according to contact block  
Illuminability               see order block

**Mechanical characteristics**

Operating travel             3 mm  
Robustness min.             100 N

**Other specifications**

Operating life                2000000  
Degree of protection       from front side           IP65  
Ambient temp. operating min.       -25 °C  
Ambient temp. operating without lamp max.   +70 °C  
Storage temperature min.       -40 °C  
Storage temperature max.       +85 °C  
Resistance to constant environment       according to IEC 600 68-2-3 and 2-30  
Resistance at variable environment       according to IEC 600 68-2-14 and 2-33

**Accessories RAFIX 16 pushbutton**

Description	Photo	Order no.	Page
RAFIX 16 standard contact block, 1 NC + 1 NO, momentary, silver contacts, with lamp socket		<b>1.20.122.001/0000</b>	2 - 58
RAFIX 16 standard contact block, 1 NC + 1 NO, momentary, gold contacts, with lamp socket		1.20.122.011/0000	2 - 54
RAFIX 16 standard contact block, 1 NC + 1 NO, momentary, silver contacts, without lamp socket		<b>1.20.122.021/0000</b>	2 - 58
RAFIX 16 standard contact block, 1 NC + 1 NO, momentary, gold contacts, without lamp socket		1.20.122.031/0000	2 - 54
LED W 2 x 4.6d superbright, white, 24 V		<b>1.90.690.365/0000</b>	5 - 16
Disassembly tool for LUMOTAST 25, RAFIX 16		<b>5.05.800.042/0000</b>	2 - 65 5 - 24
Label holder, flush, for square collar		<b>5.07.620.004/0000</b>	2 - 66

**Accessories RAFIX 16 pushbutton**

Description	Photo	Order no.	Page
Fixing spanner for hexagon nut		<b>5.58.002.034/0000</b>	2 - 65
Legend insert, blank, use only for transparent lenses		<b>5.70.635.000/2000</b>	

**RAFIX 16 pushbutton, flush lens, square collar**

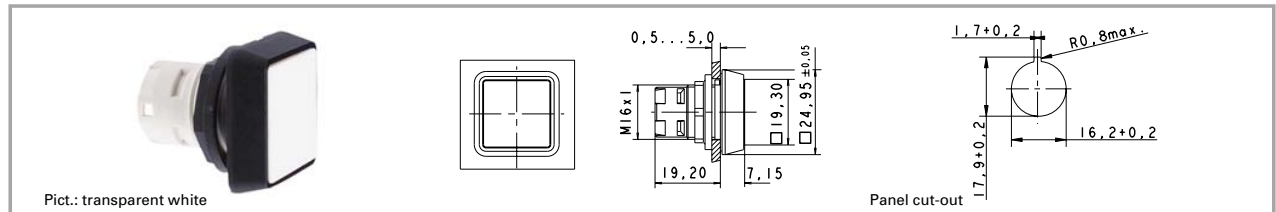

Illuminability	Colour of lens	Order no. complete	Order no. single parts	
			Housing	Lens
yes	transparent colourless	1.30.070.001/1002	<b>1.30.070.501/0000</b>	<b>5.49.077.011/1002</b>
yes	transparent red	1.30.070.001/1306	<b>1.30.070.501/0000</b>	<b>5.49.077.011/1306</b>
yes	transparent yellow	1.30.070.001/1403	<b>1.30.070.501/0000</b>	<b>5.49.077.011/1403</b>
yes	transparent green	1.30.070.001/1505	<b>1.30.070.501/0000</b>	<b>5.49.077.011/1505</b>
yes	transparent blue	1.30.070.001/1607	<b>1.30.070.501/0000</b>	<b>5.49.077.011/1607</b>
no	opaque black	1.30.070.251/0100	1.30.070.751/0000	5.05.510.640/0100
no	opaque white	1.30.070.251/0200	1.30.070.751/0000	5.05.510.640/0200
no	opaque red	1.30.070.251/0300	1.30.070.751/0000	5.05.510.640/0300
no	opaque yellow	1.30.070.251/0400	1.30.070.751/0000	5.05.510.640/0400
no	opaque green	1.30.070.251/0500	1.30.070.751/0000	5.05.510.640/0500
no	opaque blue	1.30.070.251/0600	1.30.070.751/0000	5.05.510.640/0600

Technical data see page 2 - 8

**Accessories:**

Legend insert, blank, use only for transparent lenses: 5.70.635.000/2000

For the „latching“ function, please use the standard contact block with „latching“ function.



**RAFIX 16 pushbutton, protruding lens, square collar**

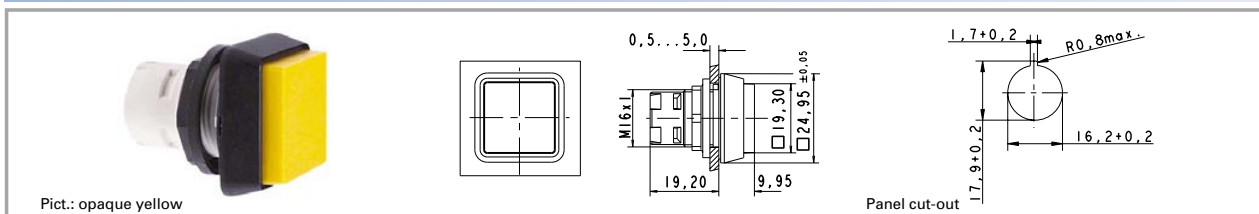

Pict.: opaque yellow

Panel cut-out

2

RAFIX  
16

Illuminability	Colour of lens	Order no. complete	Order no. single parts	
			Housing	Lens
yes	transparent colourless	1.30.070.051/1002	1.30.070.551/0000	<b>5.49.077.012/1002</b>
yes	transparent red	1.30.070.051/1306	1.30.070.551/0000	<b>5.49.077.012/1306</b>
yes	transparent yellow	1.30.070.051/1403	1.30.070.551/0000	<b>5.49.077.012/1403</b>
yes	transparent green	1.30.070.051/1505	1.30.070.551/0000	<b>5.49.077.012/1505</b>
yes	transparent blue	1.30.070.051/1607	1.30.070.551/0000	<b>5.49.077.012/1607</b>
no	opaque black	1.30.070.301/0100	-	-
no	opaque white	1.30.070.301/0200	-	-
no	opaque red	1.30.070.301/0300	-	-
no	opaque yellow	1.30.070.301/0400	-	-
no	opaque green	1.30.070.301/0500	-	-
no	opaque blue	1.30.070.301/0600	-	-

Technical data see page 2 - 8

**Accessories:**

Legend insert, blank, use only for transparent lenses: **5.70.635.000/2000**

For the „latching“ function, please use the standard contact block with „latching“ function.

**RAFIX 16 pushbutton, protruding collar, square collar**

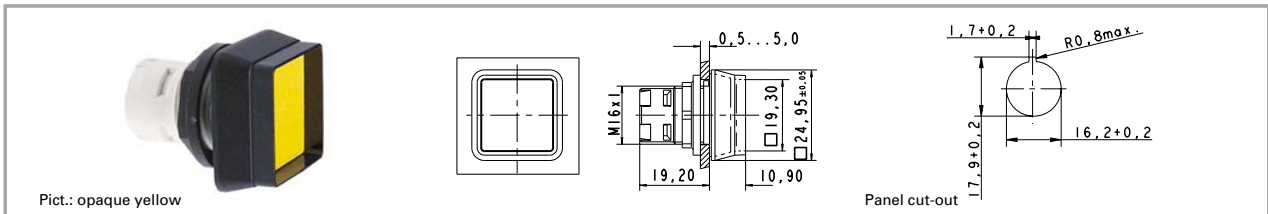

Illuminability	Colour of lens	Order no. complete	Order no. single parts	
			Housing	Lens
yes	transparent colourless	1.30.070.101/1002	1.30.070.601/0000	<b>5.49.077.011/1002</b>
yes	transparent red	1.30.070.101/1306	1.30.070.601/0000	<b>5.49.077.011/1306</b>
yes	transparent yellow	1.30.070.101/1403	1.30.070.601/0000	<b>5.49.077.011/1403</b>
yes	transparent green	1.30.070.101/1505	1.30.070.601/0000	<b>5.49.077.011/1505</b>
yes	transparent blue	1.30.070.101/1607	1.30.070.601/0000	<b>5.49.077.011/1607</b>
no	opaque black	1.30.070.351/0100	1.30.070.851/0000	5.05.510.640/0100
no	opaque white	1.30.070.351/0200	1.30.070.851/0000	5.05.510.640/0200
no	opaque red	1.30.070.351/0300	1.30.070.851/0000	5.05.510.640/0300
no	opaque yellow	1.30.070.351/0400	1.30.070.851/0000	5.05.510.640/0400
no	opaque green	1.30.070.351/0500	1.30.070.851/0000	5.05.510.640/0500
no	opaque blue	1.30.070.351/0600	1.30.070.851/0000	5.05.510.640/0600

Technical data see page 2 - 8

**Accessories:**

Legend insert, blank, use only for transparent lenses: **5.70.635.000/2000**

The protruding collar offers protection against inadvertent operation and thereby fulfils the safety requirements of various machinery manufacturers, particularly in the printing industry.

For the "latching" function, please use the standard contact block with "latching" function.

**RAFIX 16 pushbutton, flush lens, round collar**

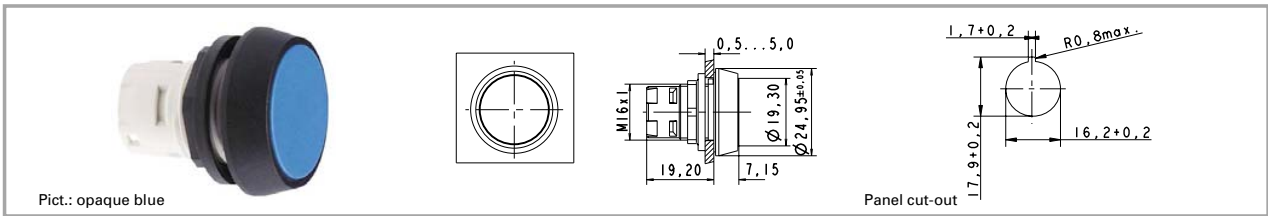

Pict.: opaque blue

Panel cut-out

2

RAFIX  
16

Illuminability	Colour of lens	Order no. complete	Order no. single parts	
			Housing	Lens
yes	transparent colourless	1.30.070.021/1002	<b>1.30.070.521/0000</b>	<b>5.49.259.017/1002</b>
yes	transparent red	1.30.070.021/1306	<b>1.30.070.521/0000</b>	<b>5.49.259.017/1306</b>
yes	transparent yellow	1.30.070.021/1403	<b>1.30.070.521/0000</b>	<b>5.49.259.017/1403</b>
yes	transparent green	1.30.070.021/1505	<b>1.30.070.521/0000</b>	<b>5.49.259.017/1505</b>
yes	transparent blue	1.30.070.021/1607	<b>1.30.070.521/0000</b>	<b>5.49.259.017/1607</b>
no	opaque black	1.30.070.271/0100	1.30.070.771/0000	5.05.510.641/0100
no	opaque white	1.30.070.271/0200	1.30.070.771/0000	5.05.510.641/0200
no	opaque red	1.30.070.271/0300	1.30.070.771/0000	5.05.510.641/0300
no	opaque yellow	1.30.070.271/0400	1.30.070.771/0000	5.05.510.641/0400
no	opaque green	1.30.070.271/0500	1.30.070.771/0000	5.05.510.641/0500
no	opaque blue	1.30.070.271/0600	1.30.070.771/0000	5.05.510.641/0600

Technical data see page 2 - 8

**Accessories:**

Legend insert, blank, use only for transparent lenses: 5.70.637.000/2000

For the „latching“ function, please use the standard contact block with „latching“ function.

**RAFIX 16 pushbutton IP66 with protective cap**

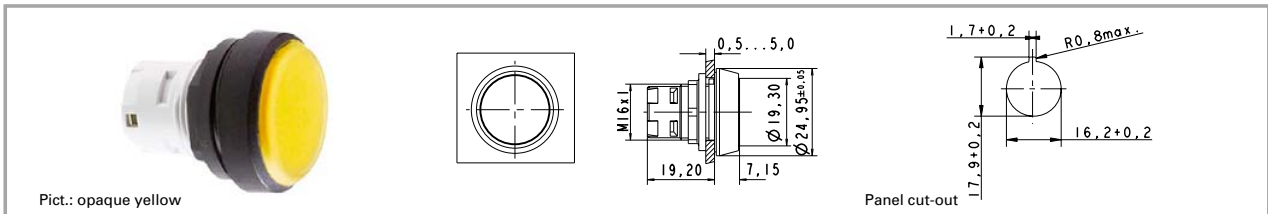

Illuminability	Colour of lens	Order no. complete	Order no. single parts	
			Housing	Lens
yes	transparent colourless	1.30.070.026/1002	-	-
yes	transparent red	1.30.070.026/1306	-	-
yes	transparent yellow	1.30.070.026/1403	-	-
yes	transparent green	1.30.070.026/1505	-	-
yes	transparent blue	1.30.070.026/1607	-	-
no	opaque black	1.30.070.276/0100	-	-
no	opaque white	1.30.070.276/0200	-	-
no	opaque red	1.30.070.276/0300	-	-
no	opaque yellow	1.30.070.276/0400	-	-
no	opaque green	1.30.070.276/0500	-	-
no	opaque blue	1.30.070.276/0600	-	-

Technical data see page 2 - 8

**Accessories:**

Legend insert, blank, use only for transparent lenses: 5.70.637.000/2000

Pushbutton for use in hostile environments. A transparent protective cap ensures a degree of protection of IP 66 to DIN/IEC. Operating life: 500,000 operations.

For the „latching“ function, please use the standard contact block with „latching“ function.

2

RAFIX  
16

**RAFIX 16 pushbutton, protruding lens, round collar**

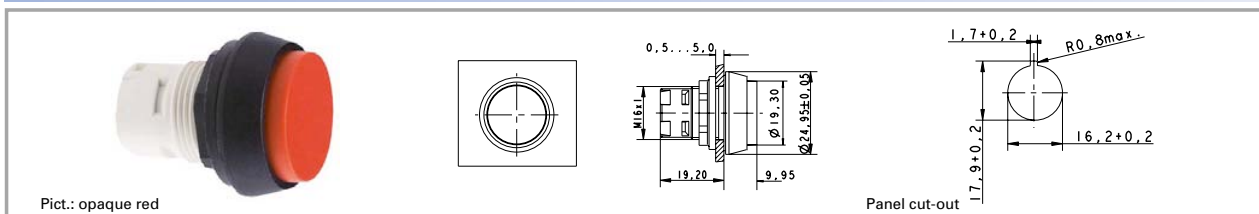

Pict.: opaque red

Panel cut-out

2

RAFIX  
16

Illuminability	Colour of lens	Order no. complete	Order no. single parts	
			Housing	Lens
yes	transparent colourless	1.30.070.071/1002	1.30.070.571/0000	5.49.259.018/1002
yes	transparent red	1.30.070.071/1306	1.30.070.571/0000	5.49.259.018/1306
yes	transparent yellow	1.30.070.071/1403	1.30.070.571/0000	5.49.259.018/1403
yes	transparent green	1.30.070.071/1505	1.30.070.571/0000	5.49.259.018/1505
yes	transparent blue	1.30.070.071/1607	1.30.070.571/0000	5.49.259.018/1607
no	opaque black	1.30.070.321/0100	-	-
no	opaque white	1.30.070.321/0200	-	-
no	opaque red	1.30.070.321/0300	-	-
no	opaque yellow	1.30.070.321/0400	-	-
no	opaque green	1.30.070.321/0500	-	-
no	opaque blue	1.30.070.321/0600	-	-

Technical data see page 2 - 8

**Accessories:**

Legend insert, blank, use only for transparent lenses: 5.70.637.000/2000

For the „latching“ function, please use the standard contact block with „latching“ function.

**RAFIX 16 pushbutton, protruding collar, round collar**

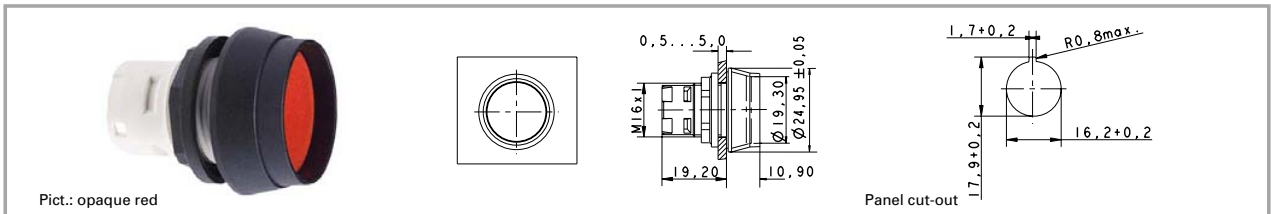

Illuminability	Colour of lens	Order no. complete	Order no. single parts	
			Housing	Lens
yes	transparent colourless	1.30.070.121/1002	1.30.070.621/0000	<b>5.49.259.017/1002</b>
yes	transparent red	1.30.070.121/1306	1.30.070.621/0000	<b>5.49.259.017/1306</b>
yes	transparent yellow	1.30.070.121/1403	1.30.070.621/0000	<b>5.49.259.017/1403</b>
yes	transparent green	1.30.070.121/1505	1.30.070.621/0000	<b>5.49.259.017/1505</b>
yes	transparent blue	1.30.070.121/1607	1.30.070.621/0000	<b>5.49.259.017/1607</b>
no	opaque black	1.30.070.371/0100	1.30.070.871/0000	5.05.510.641/0100
no	opaque white	1.30.070.371/0200	1.30.070.871/0000	5.05.510.641/0200
no	opaque red	1.30.070.371/0300	1.30.070.871/0000	5.05.510.641/0300
no	opaque yellow	1.30.070.371/0400	1.30.070.871/0000	5.05.510.641/0400
no	opaque green	1.30.070.371/0500	1.30.070.871/0000	5.05.510.641/0500
no	opaque blue	1.30.070.371/0600	1.30.070.871/0000	5.05.510.641/0600

Technical data see page 2 - 8

**Accessories:**

Legend insert, blank, use only for transparent lenses: 5.70.637.000/2000

The protruding collar offers protection against inadvertent operation and thereby fulfils the safety requirements of various machinery manufacturers, particularly in the printing industry.

For the „latching“ function, please use the standard contact block with „latching“ function.

**RAFIX 16 pushbutton, flush lens, square collar, alignable without gaps**

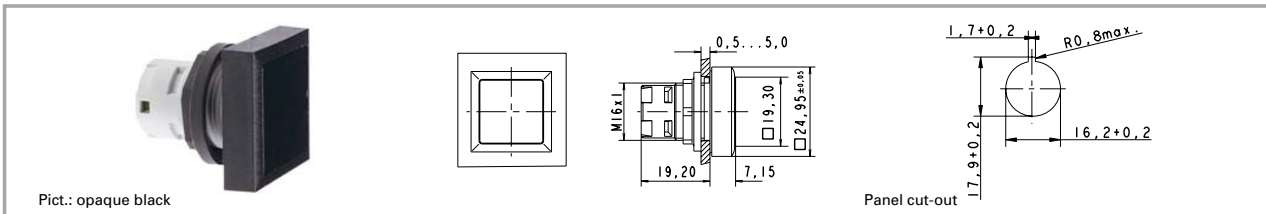

Pict.: opaque black

Panel cut-out

2

RAFIX  
16

Illuminability	Colour of lens	Order no. complete	Order no. single parts	
			Housing	Lens
yes	transparent colourless	1.30.070.201/1002	<b>1.30.070.701/0000</b>	<b>5.49.077.011/1002</b>
yes	transparent red	1.30.070.201/1306	<b>1.30.070.701/0000</b>	<b>5.49.077.011/1306</b>
yes	transparent yellow	1.30.070.201/1403	<b>1.30.070.701/0000</b>	<b>5.49.077.011/1403</b>
yes	transparent green	1.30.070.201/1505	<b>1.30.070.701/0000</b>	<b>5.49.077.011/1505</b>
yes	transparent blue	1.30.070.201/1607	<b>1.30.070.701/0000</b>	<b>5.49.077.011/1607</b>
no	opaque black	1.30.070.451/0100	1.30.070.951/0000	5.05.510.640/0100
no	opaque white	1.30.070.451/0200	1.30.070.951/0000	5.05.510.640/0200
no	opaque red	1.30.070.451/0300	1.30.070.951/0000	5.05.510.640/0300
no	opaque yellow	1.30.070.451/0400	1.30.070.951/0000	5.05.510.640/0400
no	opaque green	1.30.070.451/0500	1.30.070.951/0000	5.05.510.640/0500
no	opaque blue	1.30.070.451/0600	1.30.070.951/0000	5.05.510.640/0600

Technical data see page 2 - 8

**Accessories:**

Legend insert, blank, use only for transparent lenses: **5.70.635.000/2000**

For the „latching“ function, please use the standard contact block with „latching“ function.

**RAFIX 16 mushroom-headed pushbutton**



2

RAFIX  
16

**Technical data**

**General information**

Actuator mushroom  
Colour of mushroom red  
Form of collar see order block

**Dimensions**

Length of collar see order block  
Diameter of collar see order block  
Key grid 25 x 25 mm  
Width of collar see order block  
Overall height see order block  
Mounting depth see order block  
Mounting hole see order block

**Mechanical design**

Mounting ring nut  
Contact function according to contact block  
Contact arrangement according to contact block  
Illuminability no

**Mechanical characteristics**

Operating travel 3 mm  
Robustness min. 100 Nm

**Other specifications**

Operating life 2000000  
Degree of protection from front side IP65  
Ambient temp. operating min. -25 °C  
Ambient temp. operating without lamp max. +70 °C  
Storage temperature min. -40 °C  
Storage temperature max. +85 °C  
Resistance to constant environment according to IEC 600 68-2-3 and 2-30  
Resistance at variable environment according to IEC 600 68-2-14 and 2-33

**Accessories RAFIX 16 mushroom-headed pushbutton**

Description	Photo	Order no.	Page
RAFIX 16 standard contact block, 1 NC + 1 NO, momentary, silver contacts, without lamp socket		<b>1.20.122.021/0000</b>	2 - 58
RAFIX 16 standard contact block, 1 NC + 1 NO, momentary, gold contacts, without lamp socket		1.20.122.031/0000	2 - 54
Label holder, flush, for square collar		<b>5.07.620.004/0000</b>	2 - 66
Fixing spanner for hexagon nut		<b>5.58.002.034/0000</b>	2 - 65

For other contact blocks, refer to the chapter „RAFIX 16 contact blocks“; for additional accessories, refer to the chapter „RAFIX 16 special accessories“.



**RAFIX 16 mushroom-headed pushbutton, square collar**

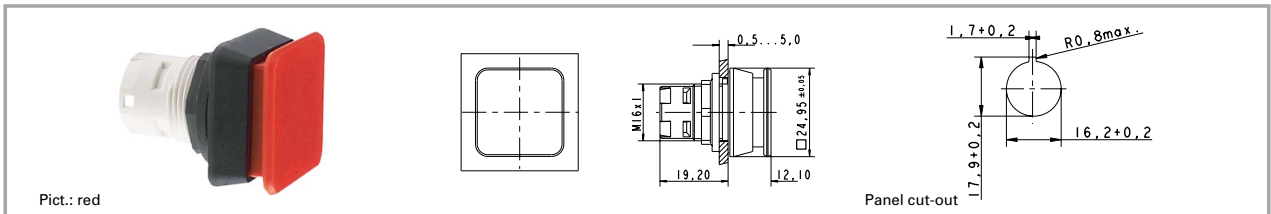

Illuminability	Colour of mushroom	Order no.
no	opaque black	1.30.071.001/0100
no	opaque red	1.30.071.001/0300

Technical data see page 2 - 30

For the „latching“ function, please use the standard contact block with „latching“ function.

2

RAFIX  
16

**RAFIX 16 mushroom-headed pushbutton, round collar**

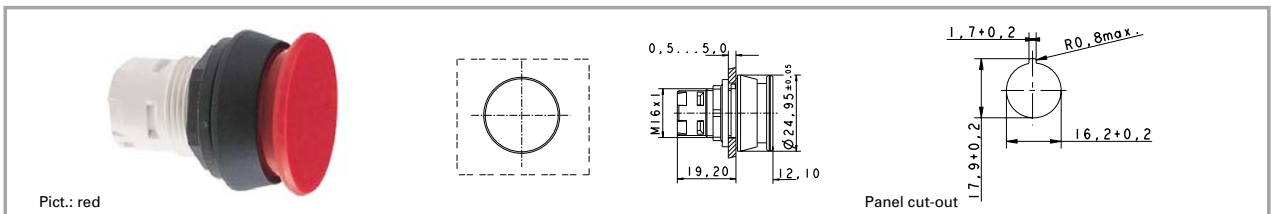

Illuminability	Colour of mushroom	Order no.
no	opaque black	1.30.071.021/0100
no	opaque red	1.30.071.021/0300

Technical data see page 2 - 30

For the „latching“ function, please use the standard contact block with „latching“ function.

**RAFIX 16 mushroom-headed pushbutton, square collar, alignable without gaps**

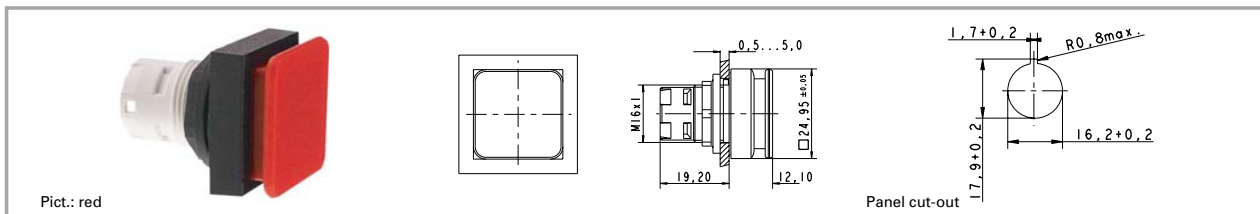

Illuminability	Colour of mushroom	Order no.
no	opaque black	1.30.071.041/0100
no	opaque red	1.30.071.041/0300

Technical data see page 2 - 30

For the „latching“ function, please use the standard contact block with „latching“ function.

2

RAFIX  
16

**RAFIX 16 emergency stop pushbutton**



**2**

RAFIX 16

**Technical data**

**General information**

Actuator mushroom  
Colour of mushroom see order block  
Form of collar see order block

**Dimensions**

Length of collar see order block  
Diameter of collar see order block  
Key grid 25 x 25 mm  
Width of collar see order block  
Overall height see order block  
Mounting depth see order block  
Mounting hole see order block

**Mechanical design**

Mounting ring nut  
Contact function latching  
Contact arrangement according to contact block  
Illuminability see order block  
Reset counterclockwise or clockwise rotation

**Mechanical characteristics**

Robustness min. 100 N  
Robustness acc. IEC 60947-5-5

**Other specifications**

Operating life 30000  
Degree of protection from front side IP65  
Ambient temp. operating min. -25 °C  
Ambient temp. operating without lamp max. +70 °C  
Ambient temp. operating with lamp max. +55 °C  
Storage temperature min. -40 °C  
Storage temperature max. +85 °C  
Resistance to constant environment according to IEC 600 68-2-3 and 2-30  
Resistance at variable environment according to IEC 600 68-2-14 and 2-33  
Corresponding to CE Ma-Dir. 89/392  
Approvals yes IEC 60204, IEC 73

**Accessories RAFIX 16 emergency stop pushbutton**

Description	Photo	Order no.	Page
RAFIX 16 universal contact block, 1 NC, momentary, silver contacts, without lamp socket		<b>1.20.123.022/0000</b>	2 - 59
RAFIX 16 universal contact block, 1 NC, momentary, gold contacts, without lamp socket		<b>1.20.123.032/0000</b>	2 - 55
Fixing spanner for hexagon nut		<b>5.58.002.034/0000</b>	2 - 65
Emergency stop label, yellow, round 60 mm, PVC adhesive, without legend		<b>5.76.204.400/0400</b>	2 - 68

For suitable LEDs, filament lamps and other contact blocks, refer to the chapter „RAFIX 16 contact blocks“; for additional accessories, refer to the chapter „RAFIX 16 special accessories“.

**RAFIX 16 emergency stop pushbutton, square collar, illuminated**

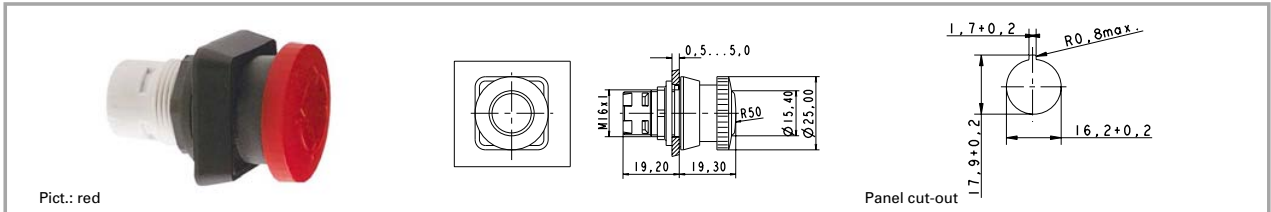

Illuminability	Colour of mushroom	Order no.
yes	translucent red	1.30.074.501/0304

Technical data see page 2 - 34

Only use universal contact blocks.

2

**RAFIX 16 emergency stop pushbutton, square collar, dupe-proof**

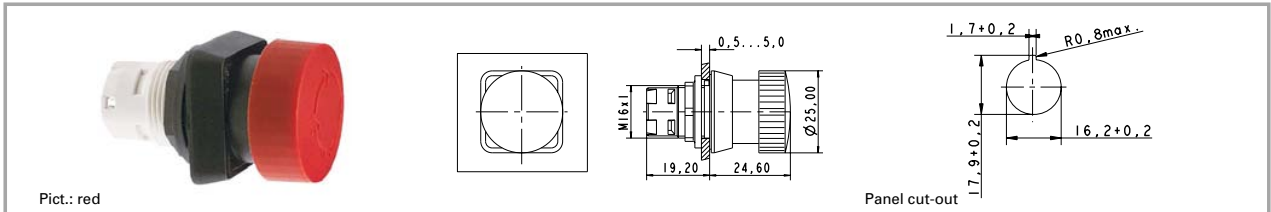

Illuminability	Colour of mushroom	Order no.
no	opaque red	1.30.074.101/0301

Technical data see page 2 - 34

Only use universal contact blocks.

The positively driven mechanical arrangement is dupe-proof to EN 418.

RAFIX  
16

**RAFIX 16 emergency stop pushbutton, round collar, illuminated**

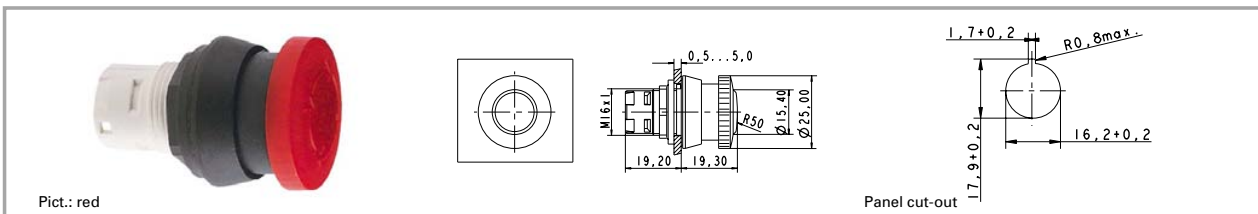

Illuminability	Colour of mushroom	Order no.
yes	translucent red	<b>1.30.074.521/0304</b>

Technical data see page 2 - 34

Only use universal contact blocks.

2

RAFIX  
16

**RAFIX 16 emergency stop pushbutton, round collar, dupe-proof**

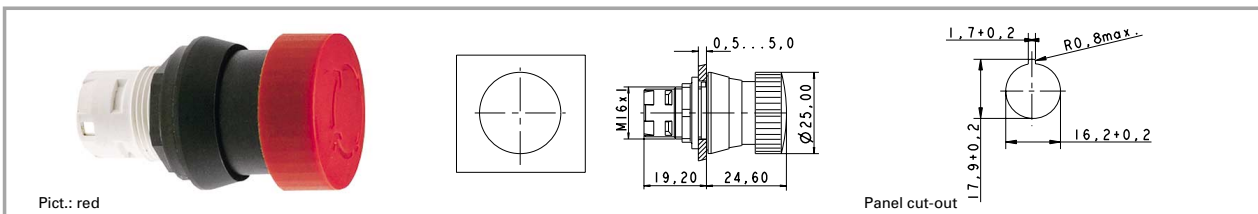

Illuminability	Colour of mushroom	Order no.
no	opaque red	<b>1.30.074.121/0301</b>

Technical data see page 2 - 34

Only use universal contact blocks.

The positively driven mechanical arrangement is dupe-proof to EN 418.

**RAFIX 16 emergency stop pushbutton, square collar, alignable without gaps, illuminated**

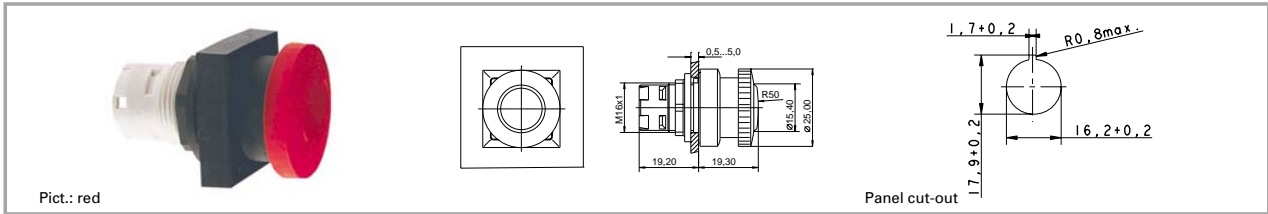

Illuminability	Colour of mushroom	Order no.
yes	translucent red	1.30.074.541/0304

Technical data see page 2 - 34

Only use universal contact blocks.

2

**RAFIX 16 emergency stop pushbutton, square collar, alignable without gaps, dupe-proof**

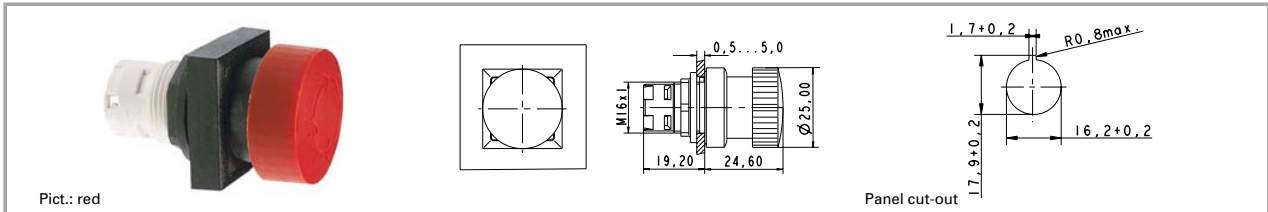

Illuminability	Colour of mushroom	Order no.
no	opaque red	1.30.074.141/0301

Technical data see page 2 - 34

Only use universal contact blocks.

The positively driven mechanical arrangement is dupe-proof to EN 418.

RAFIX  
16

**RAFIX 16 safety emergency stop pushbutton, round collar, dupe-proof, non-blocking**

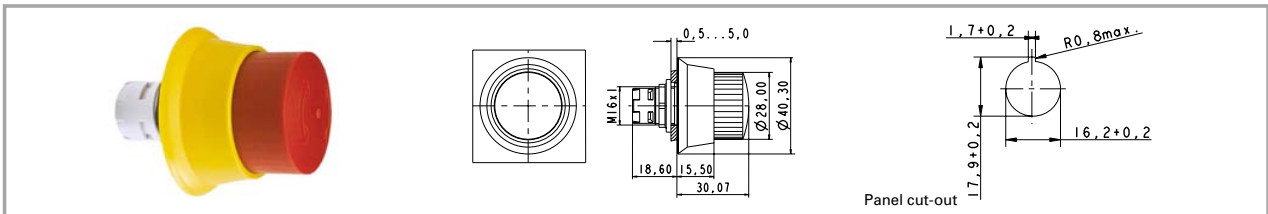

Illuminability	Colour of mushroom	Order no.
no	opaque red, collar yellow	<b>1.30.074.821/0000</b>

2

Technical data see page 2 - 34

Only use universal contact blocks.

The positively driven mechanical arrangement is dupe-proof to EN 418.

Special shape prevents blocking: Actuation cannot be interrupted by any jamming objects.

RAFIX  
16

**RAFIX 16 safety emergency stop pushbutton, round collar, conical, dupe-proof, non-blocking**

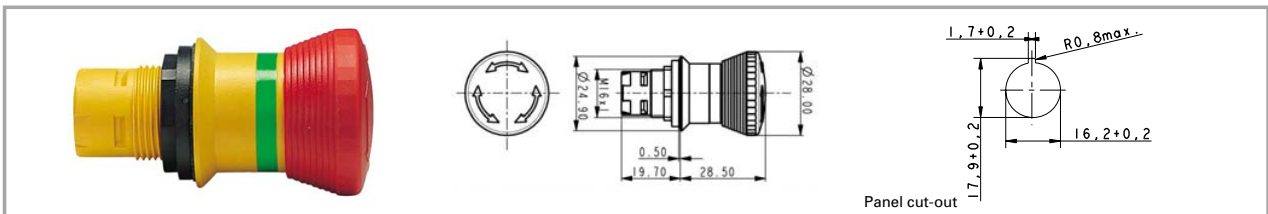

Illuminability	Colour of mushroom	Order no.
no	opaque red, collar yellow	<b>1.30.074.281/0300</b>

Technical data see page 2 - 34

Only use universal contact blocks.

The positively driven mechanical arrangement is dupe-proof to EN 418.

**RAFIX 16 toggle switch**



Pict.: black

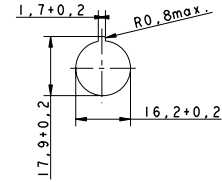

Panel cut-out

2

RAFIX  
16

**Technical data**

**General information**

Actuator toggle  
Colour of toggle see order block  
Form of collar see order block

**Dimensions**

Length of collar see order block  
Diameter of collar see order block  
Key grid 25 x 25 mm  
Width of collar see order block  
Overall height 18.4 mm  
Mounting depth 44.7 mm  
Mounting hole 16.2 mm

**Mechanical design**

Mounting ring nut  
Contact function latching  
Contact arrangement according to contact block  
Illuminability no

**Mechanical characteristics**

Robustness min. 100 N

**Other specifications**

Degree of protection from front side IP65  
Ambient temp. operating min. -25 °C  
Ambient temp. operating without lamp max. +70 °C  
Ambient temp. operating with lamp max. +55 °C  
Storage temperature min. -40 °C  
Storage temperature max. +85 °C  
Resistance to constant environment according to IEC 600 68-2-3 and 2-30  
Resistance at variable environment according to IEC 600 68-2-14 and 2-33  
Operating life (operations) 300000

**Accessories RAFIX 16 toggle switch**

Description	Photo	Order no.	Page
RAFIX 16 standard contact block, 1 NC + 1 NO, momentary, silver contacts, without lamp socket		<b>1.20.122.021/0000</b>	2 - 58
RAFIX 16 standard contact block, 1 NC + 1 NO, momentary, gold contacts, without lamp socket		1.20.122.031/0000	2 - 54
Label holder, flush, for square collar		<b>5.07.620.004/0000</b>	2 - 66
Fixing spanner for hexagon nut		<b>5.58.002.034/0000</b>	2 - 65

For other contact blocks, refer to the chapter „RAFIX 16 contact blocks“; for additional accessories, refer to the chapter „RAFIX 16 special accessories“.



**RAFIX 16 toggle switch, square collar**

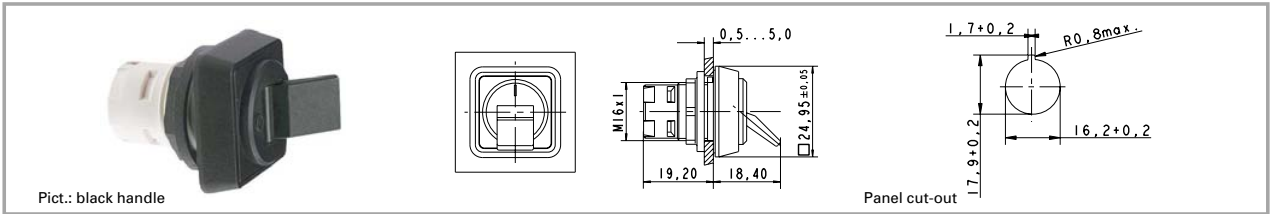

Contact function	Illuminability	Colour of toggle	Order no.
latching	no	opaque black	1.30.075.001/0104

Technical data see page 2 - 40

Only use contact blocks with "momentary" contact function.

**RAFIX 16 toggle switch, round collar**

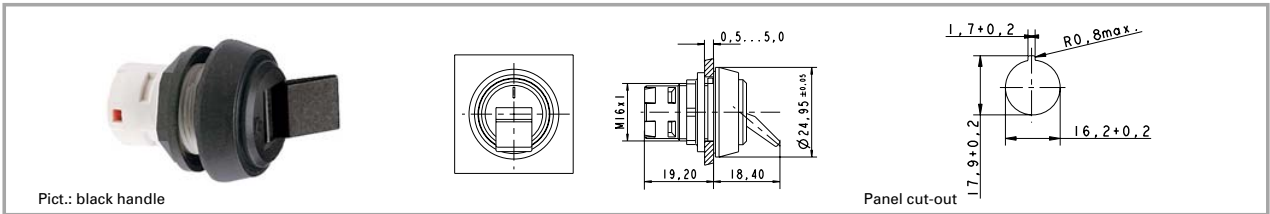

Contact function	Illuminability	Colour of toggle	Order no.
latching	no	opaque black	1.30.075.021/0104

Technical data see page 2 - 40

Only use contact blocks with "momentary" contact function.

**RAFIX 16 toggle switch, square collar, alignable without gaps**

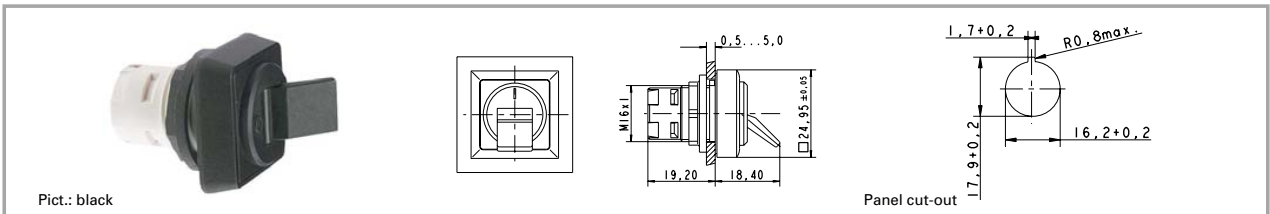

Contact function	Illuminability	Colour of toggle	Order no.
latching	no	opaque black	1.30.075.041/0104

Technical data see page 2 - 40

Only use contact blocks with „momentary“ contact function.

**RAFIX 16 potentiometer drive**

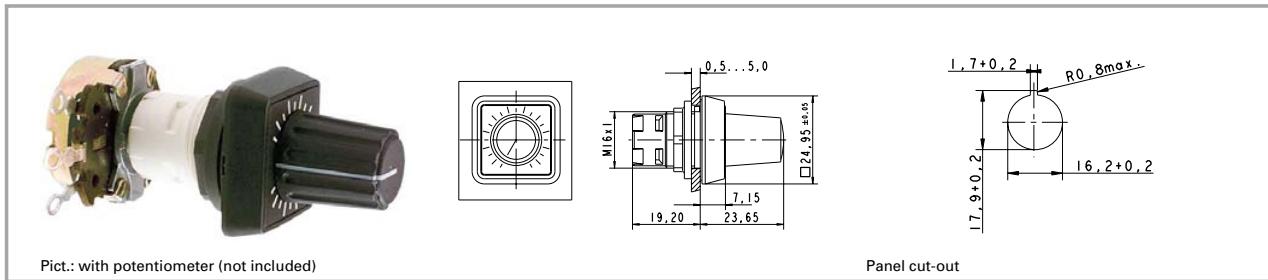

Pict.: with potentiometer (not included)

Panel cut-out

**2**

**General data**

To operate potentiometers with a shaft diameter of 6 mm.  
Suitable for potentiometers to DIN 41 450 with a shaft length of 32 mm.  
Potentiometer not included.

RAFIX  
16

**Technical data**

**General information**

Form of lens handle  
Colour of handle black  
Form of collar see order block

**Dimensions**

Length of collar see order block  
Diameter of collar see order block  
Key grid 25 x 25 mm  
Width of collar see order block  
Overall height 23.65 mm  
Mounting depth 19.2 mm  
Mounting hole 16.2 mm

**Mechanical design**

Mounting ring nut  
Threaded sleeve M 10 x 0.75

**Other specifications**

Degree of protection from front side IP65  
Ambient temp. operating min. -25 °C  
Ambient temp. operating max. +70 °C  
Storage temperature min. -40 °C  
Storage temperature max. +85 °C  
Resistance to constant environment IEC 600 68-2-3 and 2-30  
Resistance at variable environment IEC 600 68-2-14 and 2-33

**Accessories RAFIX 16 potentiometer drive**

Description	Photo	Order no.	Page
Label holder, flush, for square collar		<b>5.07.620.004/0000</b>	2 - 66
Fixing spanner for hexagon nut		<b>5.58.002.034/0000</b>	2 - 65

For additional accessories, refer to the chapter „RAFIX 16 special accessories“.

**RAFIX 16 potentiometer drive, square collar**

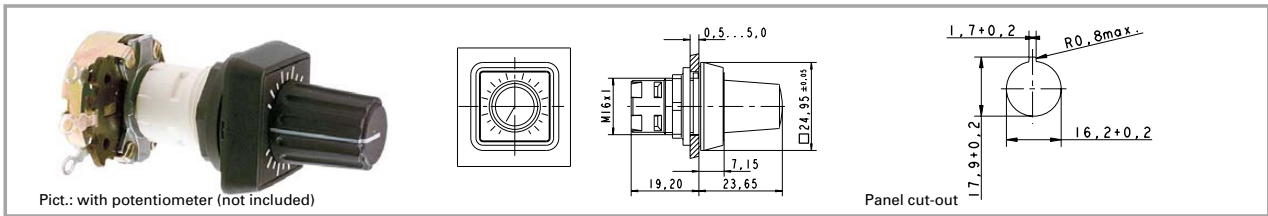

Form of lens	Form of collar	Colour of handle	Order no.
handle	square	black	1.30.077.001/0000

Technical data see page 2 - 42

**RAFIX 16 potentiometer drive, round collar**

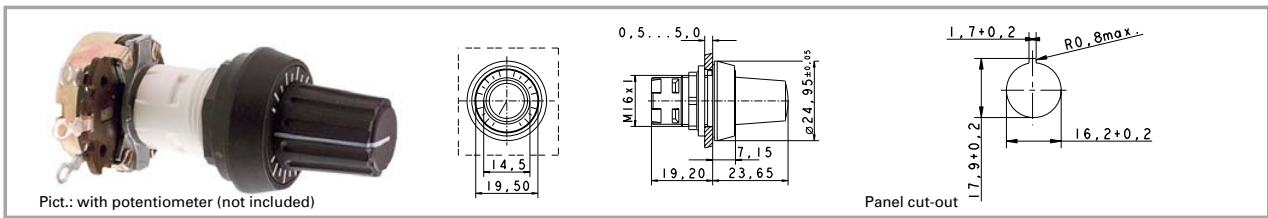

Form of lens	Form of collar	Colour of handle	Order no.
handle	round	black	1.30.077.021/0000

Technical data see page 2 - 42

**RAFIX 16 potentiometer drive, square collar, alignable without gaps**

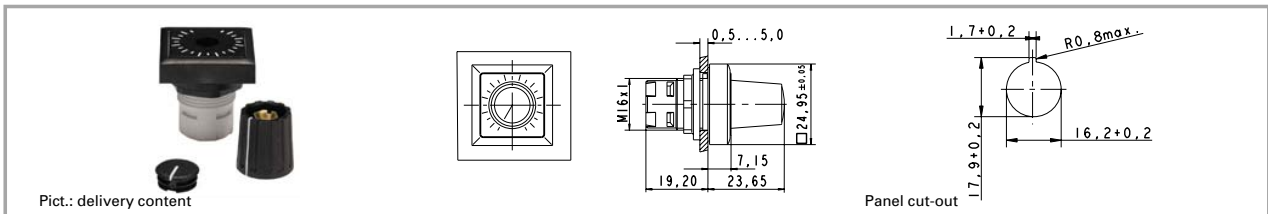

Form of lens	Form of collar	Colour of handle	Order no.
handle	square alignable	black	1.30.077.041/0000

Technical data see page 2 - 42

2  
RAFIX  
16

**RAFIX 16 buzzer**

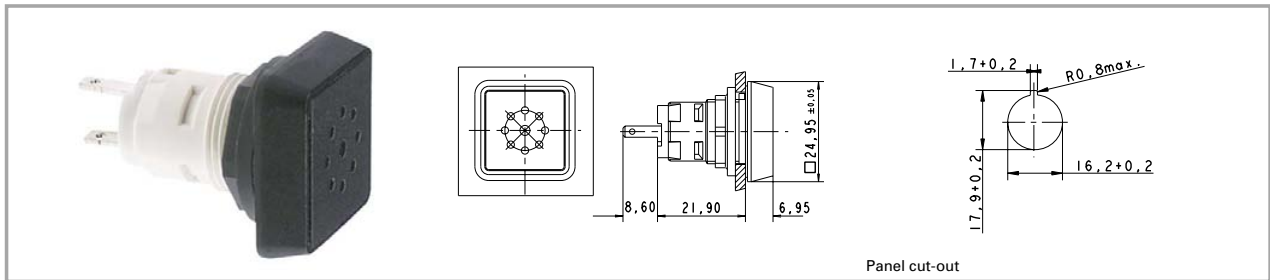

2

RAFIX  
16

**Technical data**

**General information**

Form of lens flat lens  
 Colour of lens opaque black  
 Form of collar see order block  
 Sound see order block

**Dimensions**

Length of collar see order block  
 Diameter of collar see order block  
 Key grid 25 x 25 mm  
 Width of collar see order block  
 Overall height 6.95 mm  
 Mounting depth 30.5 mm  
 Mounting hole 16.2 mm

**Mechanical design**

Mounting ring nut

**Acoustic characteristics**

Sonic pressure, 1 m distance min. see order block

**Electrical characteristics**

Operating voltage DC 24 V  
 Input current see order block  
 Frequency of intervall beep 2300 Hz

**Mechanical characteristics**

Robustness min. 100 N

**Other specifications**

Degree of protection from front side IP65  
 Ambient temp. operating min. -25 °C  
 Ambient temp. operating max. +70 °C  
 Storage temperature min. -40 °C  
 Storage temperature max. +85 °C  
 Resistance to constant environment according to IEC 600 68-2-3 and 2-30  
 Resistance at variable environment according to IEC 600 68-2-14 and 2-33

**Accessories RAFX 16 buzzer**

Description	Photo	Order no.	Page
Fixing spanner for hexagon nut		<b>5.58.002.034/0000</b>	2 - 65

For additional accessories, refer to the chapter „RAFIX 16 special accessories“.

**RAFIX 16 buzzer, square collar**

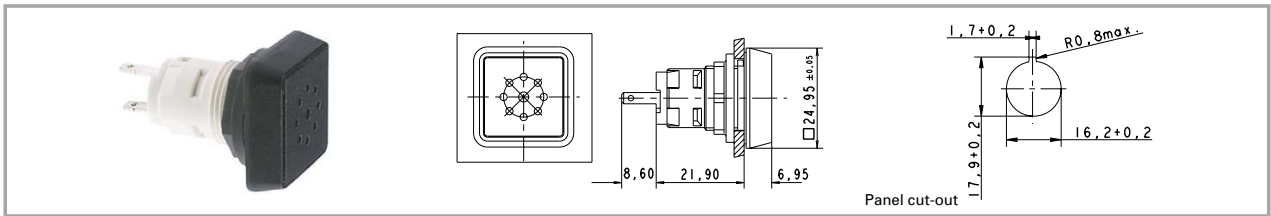

Sound	Operating voltage DC	Input current	Sonic pressure, 1 m distance min.	Order no.
continuos beep	24 V	25 mA	70 dB	1.30.078.001/0100

Technical data see page 2 - 44

12 V DC available on request.

2

**RAFIX 16 buzzer, round collar**

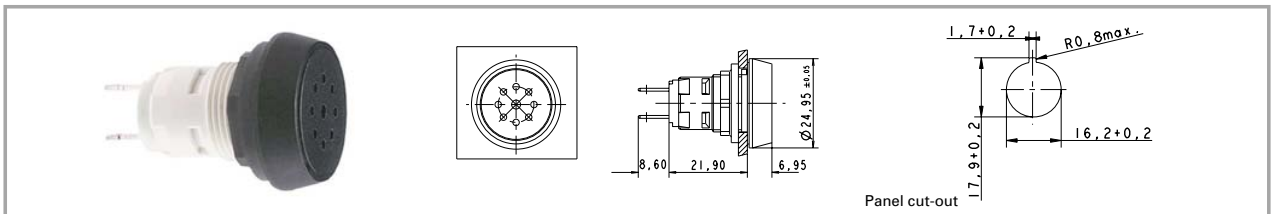

Sound	Operating voltage DC	Input current	Sonic pressure, 1 m distance min.	Order no.
continuos beep	24 V	25 mA	70 dB	1.30.078.021/0100

Technical data see page 2 - 44

12 V DC available on request.

RAFIX  
16

**RAFIX 16 buzzer, square collar, alignable without gaps**

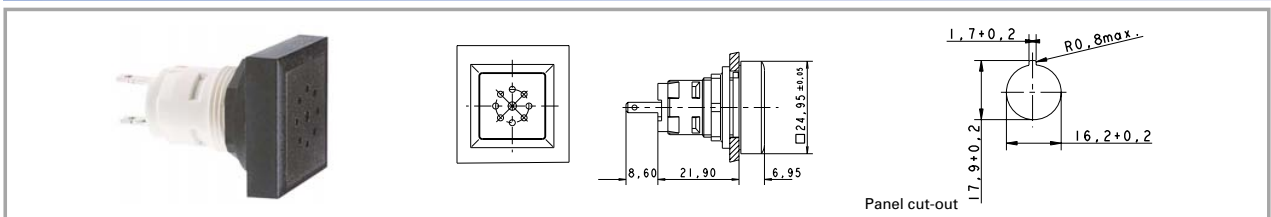

Sound	Operating voltage DC	Input current	Sonic pressure, 1 m distance min.	Order no.
continuos beep	24 V	25 mA	70 dB	1.30.078.041/0100

Technical data see page 2 - 44

12 V DC available on request.

**RAFIX 16 signal indicator**

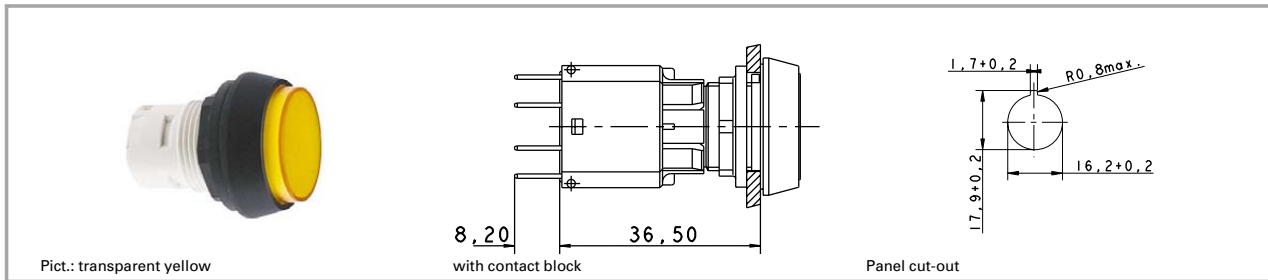

**2**

RAFIX 16

**Technical data**

**General information**

Form of lens see order block  
 Colour of lens see order block  
 Form of collar see order block

**Dimensions**

Length of collar see order block  
 Diameter of collar see order block  
 Key grid 25 x 25 mm  
 Width of collar see order block  
 Overall height see order block  
 Mounting depth 30,5/44,7 mm  
 Mounting hole 16.2 mm

**Mechanical design**

Mounting ring nut  
 Illuminability yes

**Mechanical characteristics**

Robustness min. 100 N

**Other specifications**

Degree of protection from front side IP65  
 Ambient temp. operating min. -25 °C  
 Ambient temp. operating without lamp max. +70 °C  
 Ambient temp. operating with lamp max. +55 °C  
 Storage temperature min. -40 °C  
 Storage temperature max. +85 °C  
 Resistance to constant environment according to IEC 600 68-2-3 and 2-30  
 Resistance at variable environment according to IEC 600 68-2-14 and 2-33

**Accessories RAFIX 16 signal indicator**

Description	Photo	Order no.	Page
RAFIX 16 lamp socket W 2 x 4.6 d		<b>1.71.212.001/0000</b>	2 - 61
RAFIX 16 lamp socket W 2 x 4.6 d		<b>1.71.212.011/0000</b>	2 - 61
LED W 2 x 4.6d superbright, white, 24 V		<b>1.90.690.365/0000</b>	5 - 16
Disassembly tool for LUMOTAST 25, RAFIX 16		<b>5.05.800.042/0000</b>	2 - 65 5 - 24
Label holder, flush, for square collar		<b>5.07.620.004/0000</b>	2 - 66
Fixing spanner for hexagon nut		<b>5.58.002.034/0000</b>	2 - 65

For suitable LEDs and filament lamps, refer to the chapter „RAFIX 16 lamp sockets“; for additional accessories, refer to the chapter „RAFIX 16 special accessories“.

**RAFIX 16 signal indicator, square lens**

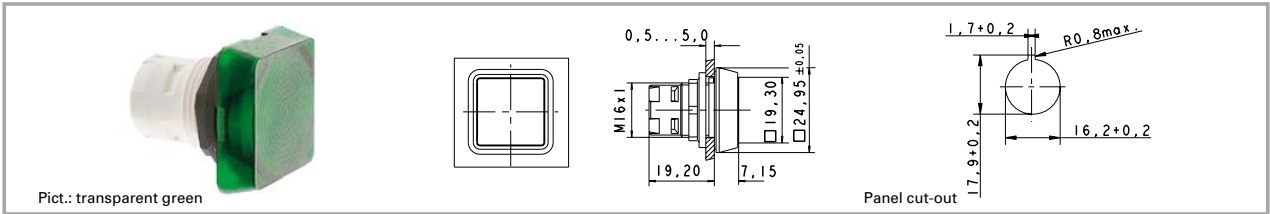

Form of lens	Form of collar	Colour of lens	Order no. complete	Order no. single parts	
				Housing	Lens
lens square		transparent colourless	1.65.124.001/1002	<b>1.65.124.101/0000</b>	<b>5.49.263.006/1002</b>
lens square		transparent red	1.65.124.001/1306	<b>1.65.124.101/0000</b>	<b>5.49.263.006/1306</b>
lens square		transparent yellow	1.65.124.001/1403	<b>1.65.124.101/0000</b>	<b>5.49.263.006/1403</b>
lens square		transparent green	1.65.124.001/1505	<b>1.65.124.101/0000</b>	<b>5.49.263.006/1505</b>
lens square		transparent blue	1.65.124.001/1607	<b>1.65.124.101/0000</b>	<b>5.49.263.006/1607</b>

Technical data see page 2 - 46

Legending can only be made externally on a label holder.

2

RAFIX  
16

**RAFIX 16 signal indicator, square collar, flush lens**

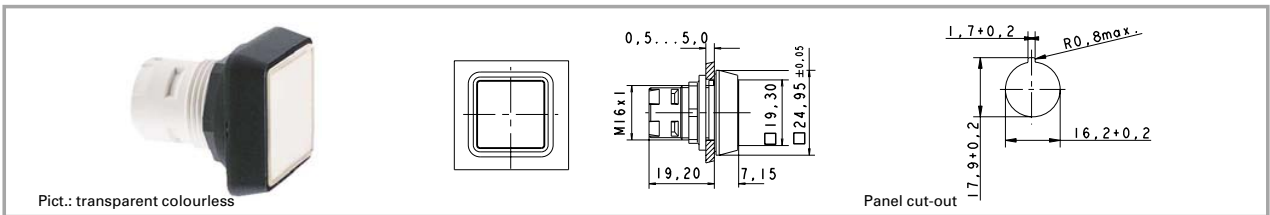

Form of lens	Form of collar	Colour of lens	Order no. complete	Order no. single parts	
				Housing	Lens
flat lens	square	transparent colourless	1.65.124.301/1002	<b>1.65.124.401/0000</b>	<b>5.49.077.011/1002</b>
flat lens	square	transparent red	1.65.124.301/1306	<b>1.65.124.401/0000</b>	<b>5.49.077.011/1306</b>
flat lens	square	transparent yellow	1.65.124.301/1403	<b>1.65.124.401/0000</b>	<b>5.49.077.011/1403</b>
flat lens	square	transparent green	1.65.124.301/1505	<b>1.65.124.401/0000</b>	<b>5.49.077.011/1505</b>
flat lens	square	transparent blue	1.65.124.301/1607	<b>1.65.124.401/0000</b>	<b>5.49.077.011/1607</b>

Technical data see page 2 - 46

**Accessories:**

Legend insert, blank, use only for transparent lenses: **5.70.635.000/2000**

**RAFIX 16 signal indicator, square collar, protruding lens**

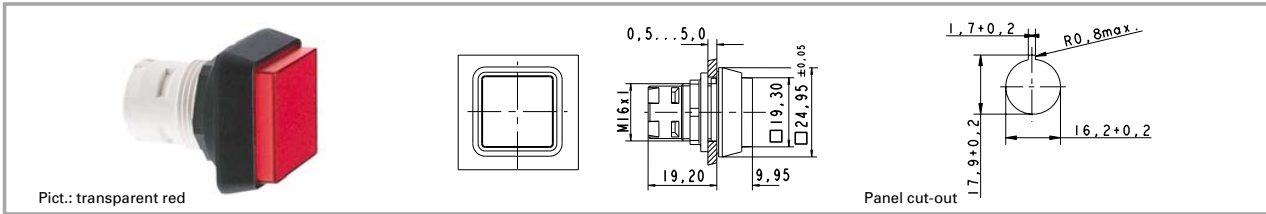

2

RAFIX 16

Form of lens	Form of collar	Colour of lens	Order no. complete	Order no. single parts	
				Housing	Lens
protruding lens	square	transparent colourless	1.65.124.351/1002	<b>1.65.124.451/0000</b>	<b>5.49.077.012/1002</b>
protruding lens	square	transparent red	1.65.124.351/1306	<b>1.65.124.451/0000</b>	<b>5.49.077.012/1306</b>
protruding lens	square	transparent yellow	1.65.124.351/1403	<b>1.65.124.451/0000</b>	<b>5.49.077.012/1403</b>
protruding lens	square	transparent green	1.65.124.351/1505	<b>1.65.124.451/0000</b>	<b>5.49.077.012/1505</b>
protruding lens	square	transparent blue	1.65.124.351/1607	<b>1.65.124.451/0000</b>	<b>5.49.077.012/1607</b>

Technical data see page 2 - 46

**Accessories:**

Legend insert, blank, use only for transparent lenses: **5.70.635.000/2000**

**RAFIX 16 signal indicator, round lens**

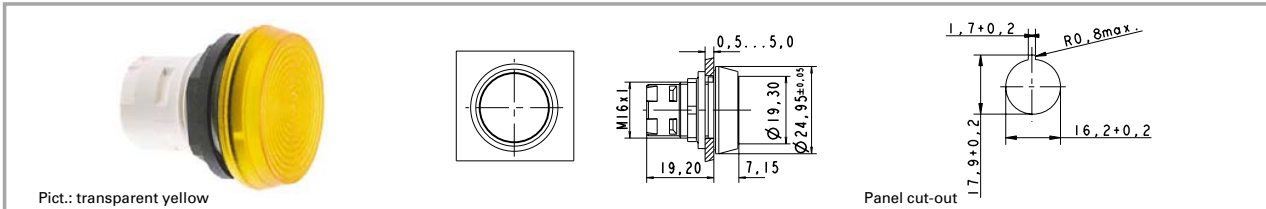

Form of lens	Form of collar	Colour of lens	Order no. complete	Order no. single parts	
				Housing	Lens
lens round	round	transparent colourless	1.65.124.021/1002	<b>1.65.124.101/0000</b>	<b>5.49.263.007/1002</b>
lens round	round	transparent red	1.65.124.021/1306	<b>1.65.124.101/0000</b>	<b>5.49.263.007/1306</b>
lens round	round	transparent yellow	1.65.124.021/1403		<b>5.49.263.007/1403</b>
lens round	round	transparent green	1.65.124.021/1505	<b>1.65.124.101/0000</b>	<b>5.49.263.007/1505</b>
lens round	round	transparent blue	1.65.124.021/1607	<b>1.65.124.101/0000</b>	<b>5.49.263.007/1607</b>

Technical data see page 2 - 46

Legending can only be made externally on a label holder.



**RAFIX 16 signal indicator, round collar, flush lens**

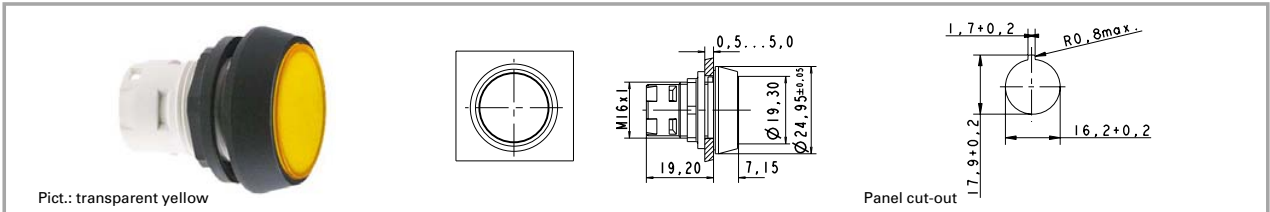

Form of lens	Form of collar	Colour of lens	Order no. complete	Order no. single parts	
				Housing	Lens
flat lens	round	transparent colourless	1.65.124.321/1002		<b>5.49.259.017/1002</b>
flat lens	round	transparent red	1.65.124.321/1306	1.65.124.421/0000	<b>5.49.259.017/1306</b>
flat lens	round	transparent yellow	1.65.124.321/1403	1.65.124.421/0000	<b>5.49.259.017/1403</b>
flat lens	round	transparent green	1.65.124.321/1505	1.65.124.421/0000	<b>5.49.259.017/1505</b>
flat lens	round	transparent blue	1.65.124.321/1607	1.65.124.421/0000	<b>5.49.259.017/1607</b>

Technical data see page 2 - 46

**Accessories:**

Legend insert, blank, use only for transparent lenses: 5.70.637.000/2000

**RAFIX 16 signal indicator, round collar, protruding lens**

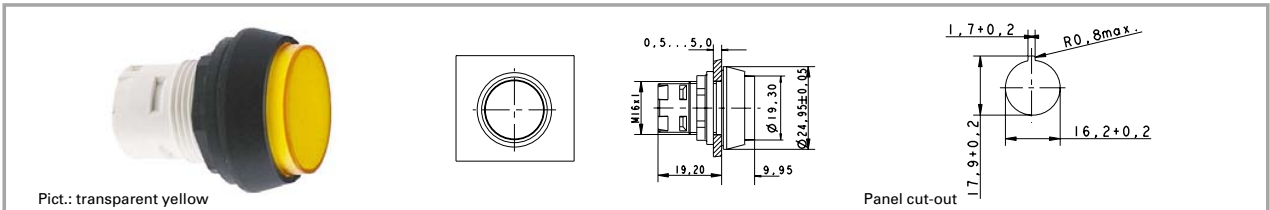

Form of lens	Form of collar	Colour of lens	Order no. complete	Order no. single parts	
				Housing	Lens
protruding lens	round	transparent colourless	1.65.124.371/1002	1.65.124.471/0000	5.49.259.018/1002
protruding lens	round	transparent red	1.65.124.371/1306	1.65.124.471/0000	5.49.259.018/1306
protruding lens	round	transparent yellow	1.65.124.371/1403	1.65.124.471/0000	5.49.259.018/1403
protruding lens	round	transparent green	1.65.124.371/1505	1.65.124.471/0000	5.49.259.018/1505
protruding lens	round	transparent blue	1.65.124.371/1607	1.65.124.471/0000	5.49.259.018/1607

Technical data see page 2 - 46

**Accessories:**

Legend insert, blank, use only for transparent lenses: 5.70.637.000/2000

**RAFIX 16 signal indicator, square collar, alignable without gaps, flush lens**

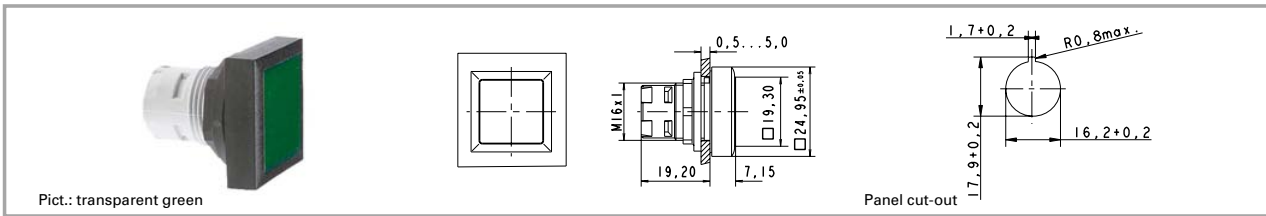

Pict.: transparent green

Panel cut-out

2

RAFIX 16

Form of lens	Form of collar	Colour of lens	Order no. complete	Order no. single parts	
				Housing	Lens
flat lens	square alignable	transparent colourless	1.65.124.551/1002	1.65.124.651/0000	<b>5.49.077.011/1002</b>
flat lens	square alignable	transparent red	1.65.124.551/1306	1.65.124.651/0000	<b>5.49.077.011/1306</b>
flat lens	square alignable	transparent yellow	1.65.124.551/1403	1.65.124.651/0000	<b>5.49.077.011/1403</b>
flat lens	square alignable	transparent green	1.65.124.551/1505	1.65.124.651/0000	<b>5.49.077.011/1505</b>
flat lens	square alignable	transparent blue	1.65.124.551/1607	1.65.124.651/0000	<b>5.49.077.011/1607</b>

Technical data see page 2 - 46

**Accessories:**

Legend insert, blank, use only for transparent lenses: **5.70.635.000/2000**

**RAFIX 16 signal indicator, square collar, alignable without gaps, protruding lens**

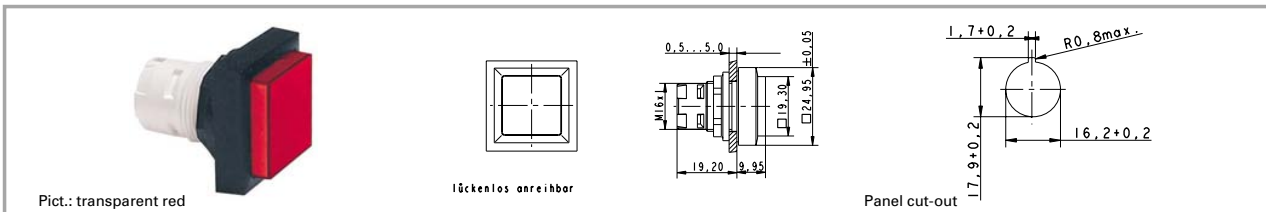

Pict.: transparent red

lückenlos anreihbar

Panel cut-out

Form of lens	Form of collar	Colour of lens	Order no. complete	Order no. single parts	
				Housing	Lens
protruding lens	square alignable	transparent colourless	1.65.124.501/1002	1.65.124.661/0000	<b>5.49.077.012/1002</b>
protruding lens	square alignable	transparent red	1.65.124.501/1306	1.65.124.661/0000	<b>5.49.077.012/1306</b>
protruding lens	square alignable	transparent yellow	1.65.124.501/1403	1.65.124.661/0000	<b>5.49.077.012/1403</b>
protruding lens	square alignable	transparent green	1.65.124.501/1505	1.65.124.661/0000	<b>5.49.077.012/1505</b>
protruding lens	square alignable	transparent blue	1.65.124.501/1607	1.65.124.661/0000	<b>5.49.077.012/1607</b>

Technical data see page 2 - 46

**Accessories:**

Legend insert, blank, use only for transparent lenses: **5.70.635.000/2000**

**RAFIX 16 contact blocks with gold contacts**

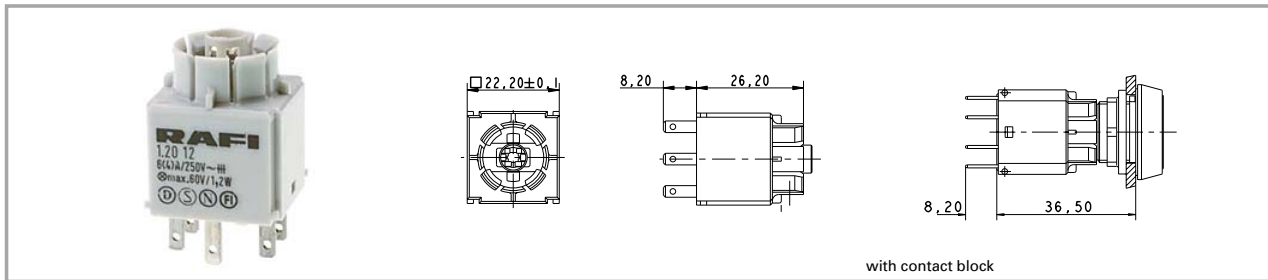

2

RAFIX 16

**Technical data**

**Dimensions**

Length	see order block
Width	see order block
Height	see order block
Mounting depth (with actuator / indicator)	see order block

**Mechanical design**

Mounting	snap on actuator
Contact system	bridgecontact self cleaning
Contact materials	Au
Contact arrangement	see order block
Contact function	see order block
Lamp socket	see order block
Terminals	quick connector 2.8 x 0.8
Terminal marking	according to DIN 50013, X1 = +, X2 = -
Operating travel	3 mm
Robustness	100 N

**Mechanical characteristics**

Robustness	acc. IEC 60947-5-5
------------	--------------------

**Electrical characteristics**

Rated voltage min.	see order block
Rated voltage max. (AC/DC)	42 V
Rated current min.	see order block
Rated current max.	see order block

Operating life switching element (momentary)	2000000
Contact resistance when new max.	50 mΩ



**Other specifications**

Protection class	II
Shock resistance acc. to IEC 600 68-2-27	see order block
Ambient temp. operating min.	-25 °C
Ambient temp. operating without lamp max.	+70 °C
Ambient temp. operating with lamp max.	+55 °C
Storage temperature min.	-40 °C
Storage temperature max.	+85 °C
Colour code	white bottom
Resistance to constant environment	IEC 600 68-2-3 and 2-30
Resistance at variable environment	IEC 600 68-2-14 and 2-33
Mechanical operating life latching (operations)	see order block
Resistance to vibrations acc. to IEC 600 68-2-6	10 g at 20 ... 500 Hz
Flame class acc. to UL 94	V 0
Hot wire ignition acc. to IEC 60695-2-1	yes

**Accessories RAFIX 16 contact blocks with gold contacts**

Description	Photo	Order no.	Page
Filament lamp, W 2 x 4.6d base, 24 - 30 V		<b>1.90.120.005/0000</b>	5 - 4
Filament lamp, W 2 x 4.6d base, 60 V		<b>1.90.120.009/0000</b>	5 - 4
Filament lamp, W 2 x 4.6d base, 48 V		<b>1.90.120.010/0000</b>	5 - 4
Filament lamp, W 2 x 4.6d base, 24 V		<b>1.90.120.011/0000</b>	5 - 4

**Accessories RAFIX 16 contact blocks with gold contacts**

Description	Photo	Order no.	Page
Filament lamp, W 2 x 4.6d base, 12 V		<b>1.90.120.012/0000</b>	5 - 4
Filament lamp, W 2 x 4.6d base, 6 V		<b>1.90.120.013/0000</b>	5 - 4
LED W 2 x 4.6d superbright, red, 24 V		<b>1.90.690.361/0000</b>	5 - 16
LED W 2 x 4.6d superbright, green, 24 V		<b>1.90.690.362/0000</b>	5 - 16
LED W 2 x 4.6d superbright, yellow, 24 V		<b>1.90.690.363/0000</b>	5 - 16
LED W 2 x 4.6d superbright, blue, 24 V		<b>1.90.690.364/0000</b>	5 - 16
LED W 2 x 4.6d superbright, white, 24 V		<b>1.90.690.365/0000</b>	5 - 16
Multipole connector		<b>5.05.510.421/0000</b>	2 - 63
PCB plug-in socket, 10 contacts (universal application)		<b>5.05.510.644/0000</b>	2 - 62
Female quick-connect terminal DIN 46340-B 2.8-1-MS		<b>5.37.540.024/8622</b>	2 - 63
Plug distributor		5.37.540.029/6000	2 - 63
Protection against contact		5.55.103.105/0100	2 - 64

**RAFIX 16 standard contact block, gold contacts, with lamp socket**

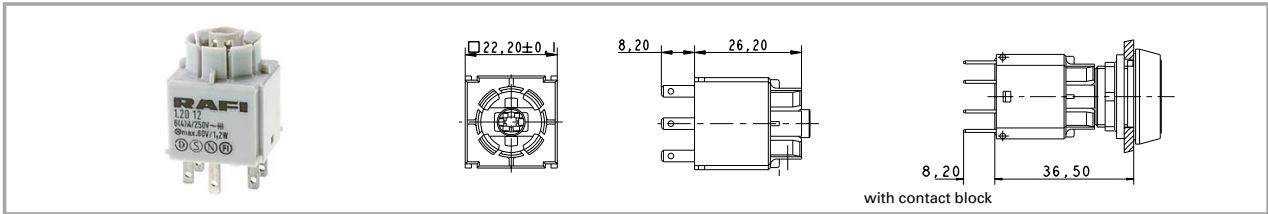

2

RAFIX  
16

Contact function	Contact arrangement	Lamp socket	Rated voltage max. (AC/DC)	Rated current max.	Order no.
momentary	1 NC + 1 NO	W 2 x 4.6d	42 V	0.25 A	1.20.122.011/0000
momentary	2 NO	W 2 x 4.6d	42 V	0.25 A	<b>1.20.122.012/0000</b>
momentary	2 NC	W 2 x 4.6d	42 V	0.25 A	1.20.122.013/0000
latching	1 NC + 1 NO	W 2 x 4.6d	42 V	0.25 A	1.20.122.051/0000
latching	2 NO	W 2 x 4.6d	42 V	0.25 A	1.20.122.052/0000

Technical data see page 2 - 52

Standard contact blocks have one common contact chamber and one actuator plunger. Contact blocks with „latching“ contact function are used as switches. When combined with pushbuttons and mushroom actuators, the switching position is visible, releasing is effected by actuating again.

**RAFIX 16 standard contact block, gold contacts, without lamp socket**

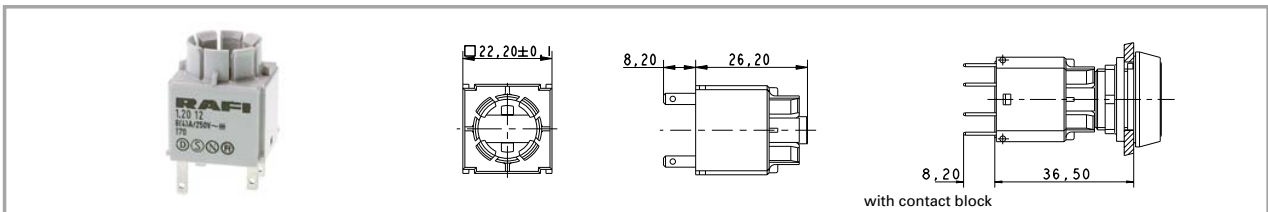

Contact function	Contact arrangement	Lamp socket	Rated voltage max. (AC/DC)	Rated current max.	Order no.
momentary	1 NC + 1 NO		42 V	0.25 A	1.20.122.031/0000
momentary	2 NO		42 V	0.25 A	1.20.122.032/0000
momentary	2 NC		42 V	0.25 A	1.20.122.033/0000
latching	1 NC + 1 NO		42 V	0.25 A	1.20.122.071/0000
latching	2 NO		42 V	0.25 A	1.20.122.072/0000

Technical data see page 2 - 52

Standard contact blocks have one common contact chamber and one actuator plunger. Contact blocks with „latching“ contact function are used as switches. When combined with pushbuttons and mushroom actuators, the switching position is visible, releasing is effected by actuating again.

**RAFIX 16 universal contact block, gold contacts, with lamp socket**

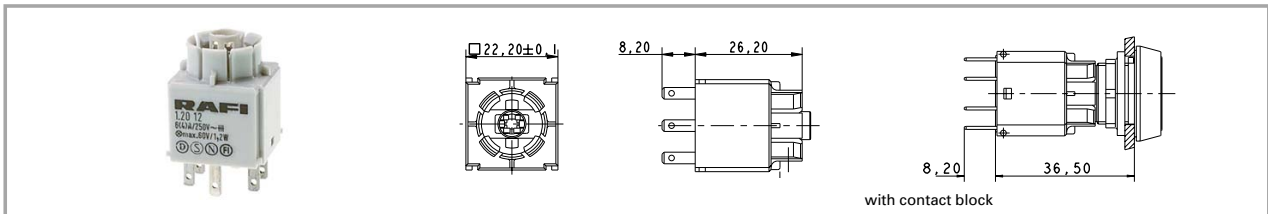

Contact function	Contact arrangement	Lamp socket	Rated voltage max. (AC/DC)	Rated current max.	Order no.
momentary	1 NC + 1 NO	W 2 x 4.6d	42 V	0.25 A	1.20.123.011/0000
momentary	1 NC	W 2 x 4.6d	42 V	0.25 A	1.20.123.012/0000
momentary	1 NO	W 2 x 4.6d	42 V	0.25 A	1.20.123.013/0000
momentary	2 NC	W 2 x 4.6d	42 V	0.25 A	1.20.123.014/0000
momentary	2 NO	W 2 x 4.6d	42 V	0.25 A	1.20.123.015/0000

Technical data see page 2 - 52

Universal contact blocks have two separate contact chambers and two actuator plungers for alternating actuation directions. Two different polarities can be switched. The NC contacts are positive opening contacts to IEC 60947-5-1.

2

RAFIX  
16

**RAFIX 16 universal contact block, gold contacts, without lamp socket**

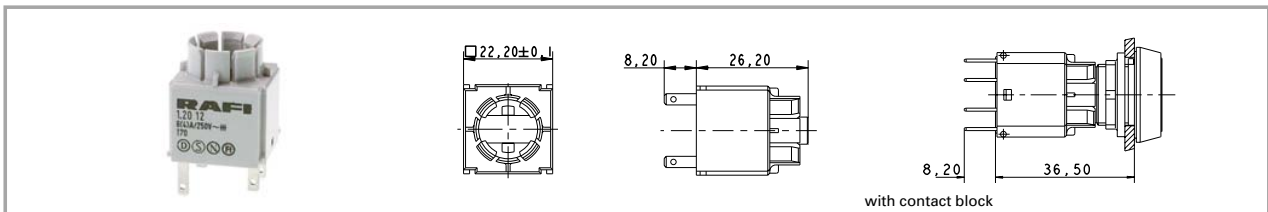

Contact function	Contact arrangement	Lamp socket	Rated voltage max. (AC/DC)	Rated current max.	Order no.
momentary	1 NC + 1 NO		42 V	0.25 A	<b>1.20.123.031/0000</b>
momentary	1 NC		42 V	0.25 A	<b>1.20.123.032/0000</b>
momentary	1 NO		42 V	0.25 A	<b>1.20.123.033/0000</b>
momentary	2 NC		42 V	0.25 A	<b>1.20.123.034/0000</b>
momentary	2 NO		42 V	0.25 A	<b>1.20.123.035/0000</b>

Technical data see page 2 - 52

Universal contact blocks have two separate contact chambers and two actuator plungers for alternating actuation directions. Two different polarities can be switched. The NC contacts are positive opening contacts to IEC 60947-5-1.

**RAFIX 16 contact blocks with silver contacts**

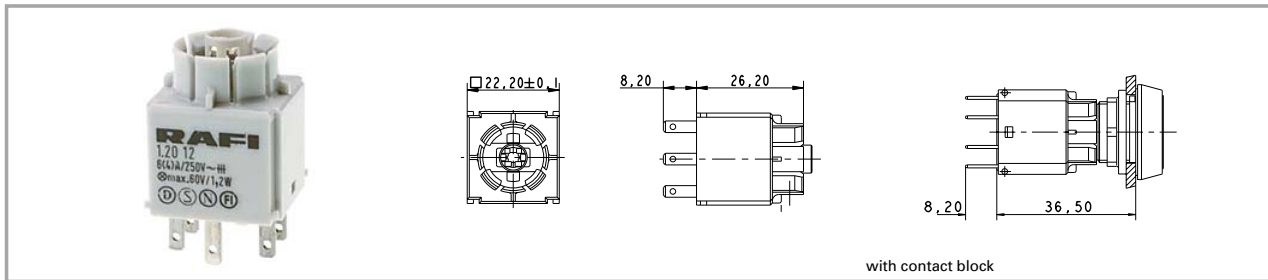

2

RAFIX 16

**Technical data**

**Dimensions**

Length	22.2 mm
Width	22.2 mm
Height	34.4 mm
Mounting depth (with actuator / indicator)	44.7 mm

**Mechanical design**

Mounting	snap on actuator
Contact system	bridgecontact self cleaning
Contact materials	Ag
Contact arrangement	see order block
Contact function	see order block
Lamp socket	see order block
Terminals	quick connector 2.8 x 0.8
Terminal marking	according to DIN 50013, X1 = +, X2 = -
Operating travel	3 mm
Robustness	100 N

**Mechanical characteristics**

Robustness	acc. IEC 60947-5-5
------------	--------------------

**Electrical characteristics**

Rated insulation voltage acc. to VDE 0110, AC	250 V
Rated insulation voltage acc. to VDE 0110, DC	300 V
Ohmic rated current I <sub>R</sub>	6 A
Rated motor current I <sub>M nenn</sub>	4 A
Application category acc. to VDE 0660 Teil 200	AC 15B 300 V
Application category acc. to VDE 0660 Teil 200	DC 13Q 300 V
Rated insulation voltage U <sub>I</sub> , AC	250 V
Rated insulation voltage U <sub>I</sub> , DC	300 V
Rated voltage U <sub>E</sub> / Rated current I <sub>E</sub> , AC	250 V/1,5 A, 120 V/3,0 A V
Rated voltage U <sub>E</sub> / Rated current I <sub>E</sub> , DAC	250 V/0,27 A, 125 V/0,55 A, 60 V/1 A, 24 V/2 A V
Thermic rated current I <sub>the</sub> , AC	5 A

**Thermic rated current**

I <sub>the</sub> , DC	2,5 A
Operating life switching element AC	100000 at 6A, 800000 at 2A
Operating life switching element DC	250000 at 220 V/0.2 A, 1000000 at 24 V/2 A

**Rated power DC**

Rated power DC	10 x I <sub>E</sub>
Rated power AC	1,1 x I <sub>E</sub>
Contact resistance when new max.	20 mΩ

**Other specifications**

Protection class	II
Approvals	ENEC 25 T 70 (55), UL, CSA

Corresponding to EU directive N

	72/73
	yes

Shock resistance acc. to IEC 600 68-2-27

	amplitude < 50g, 11ms, half sinusoidal
--	--

Ambient temp. operating min.

	-25 °C
Ambient temp. operating without lamp max.	+70 °C

Ambient temp. operating with lamp max.

	+55 °C
Storage temperature min.	-40 °C
Storage temperature max.	+85 °C

Colour code grey bottom

Resistance to constant environment

	according to IEC 600 68-2-3 and 2-30
--	--------------------------------------

Resistance at variable environment

	according to IEC 600 68-2-14 and 2-33
--	---------------------------------------

Mechanical operating life latching (operations)

	100000
--	--------

Resistance to vibrations acc. to IEC 600 68-2-6

	10 g at 20 ... 500 Hz
--	-----------------------

Flame class acc. to UL 94 Hot wire ignition acc. to IEC 60695-2-1

	V 0
	yes

**Accessories RAFIX 16 contact blocks with silver contacts**

Description	Photo	Order no.	Page
Filament lamp, W 2 x 4.6d base, 24 - 30 V		<b>1.90.120.005/0000</b>	5 - 4
Filament lamp, W 2 x 4.6d base, 60 V		<b>1.90.120.009/0000</b>	5 - 4
Filament lamp, W 2 x 4.6d base, 48 V		<b>1.90.120.010/0000</b>	5 - 4
Filament lamp, W 2 x 4.6d base, 24 V		<b>1.90.120.011/0000</b>	5 - 4
Filament lamp, W 2 x 4.6d base, 12 V		<b>1.90.120.012/0000</b>	5 - 4
Filament lamp, W 2 x 4.6d base, 6 V		<b>1.90.120.013/0000</b>	5 - 4
LED W 2 x 4.6d superbright, red, 24 V		<b>1.90.690.361/0000</b>	5 - 16
LED W 2 x 4.6d superbright, green, 24 V		<b>1.90.690.362/0000</b>	5 - 16
LED W 2 x 4.6d superbright, yellow, 24 V		<b>1.90.690.363/0000</b>	5 - 16
LED W 2 x 4.6d superbright, blue, 24 V		<b>1.90.690.364/0000</b>	5 - 16
LED W 2 x 4.6d superbright, white, 24 V		<b>1.90.690.365/0000</b>	5 - 16
Multipole connector		<b>5.05.510.421/0000</b>	2 - 63
PCB plug-in socket, 10 contacts (universal application)		<b>5.05.510.644/0000</b>	2 - 62
Female quick-connect terminal DIN 46340-B 2.8-1-MS		<b>5.37.540.024/8622</b>	2 - 63
Plug distributor		<b>5.37.540.029/6000</b>	2 - 63
Protection against contact		<b>5.55.103.105/0100</b>	2 - 64

2

RAFIX  
16



**RAFIX 16 standard contact block, silver contacts, with lamp socket**

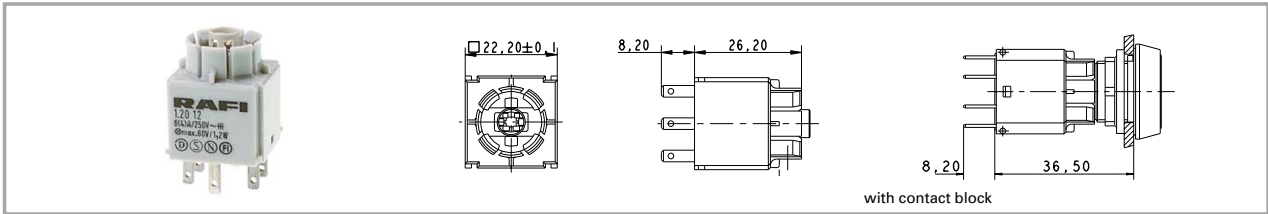

2

RAFIX  
16

Contact function	Contact arrangement	Lamp socket	Rated insulation voltage $U_i$ , AC	Ohmic rated current $I_R$	Order no.
momentary	1 NC + 1 NO	W 2 x 4.6d	250 V	6 A	<b>1.20.122.001/0000</b>
momentary	2 NO	W 2 x 4.6d	250 V	6 A	<b>1.20.122.002/0000</b>
momentary	2 NC	W 2 x 4.6d	250 V	6 A	1.20.122.003/0000
latching	1 NC + 1 NO	W 2 x 4.6d	250 V	6 A	<b>1.20.122.041/0000</b>
latching	2 NO	W 2 x 4.6d	250 V	6 A	<b>1.20.122.042/0000</b>

Technical data see page 2 - 56

Standard contact blocks have one common contact chamber and one actuator plunger. Contact blocks with „latching“ contact function are used as switches. When combined with pushbuttons and mushroom actuators, the switching position is visible, releasing is effected by actuating again.

**RAFIX 16 standard contact block, silver contacts, without lamp socket**

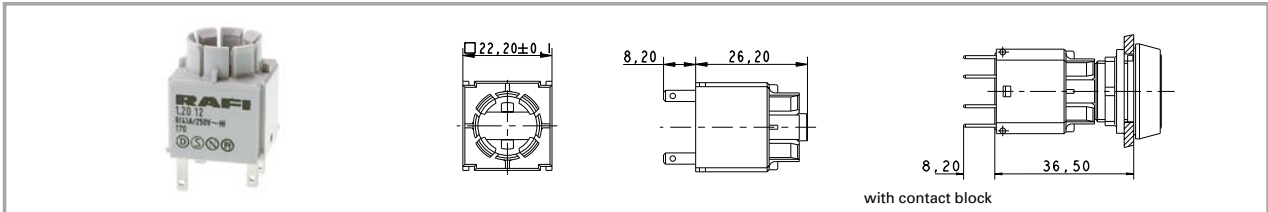

Contact function	Contact arrangement	Lamp socket	Rated insulation voltage $U_i$ , AC	Ohmic rated current $I_R$	Order no.
momentary	1 NC + 1 NO		250 V	6 A	<b>1.20.122.021/0000</b>
momentary	2 NO		250 V	6 A	<b>1.20.122.022/0000</b>
momentary	2 NC		250 V	6 A	<b>1.20.122.023/0000</b>
latching	1 NC + 1 NO		250 V	6 A	<b>1.20.122.061/0000</b>
latching	2 NO		250 V	6 A	<b>1.20.122.062/0000</b>

Technical data see page 2 - 56

Standard contact blocks have one common contact chamber and one actuator plunger. Contact blocks with „latching“ contact function are used as switches. When combined with pushbuttons and mushroom actuators, the switching position is visible, releasing is effected by actuating again.

**RAFIX 16 universal contact block, silver contacts, with lamp socket**

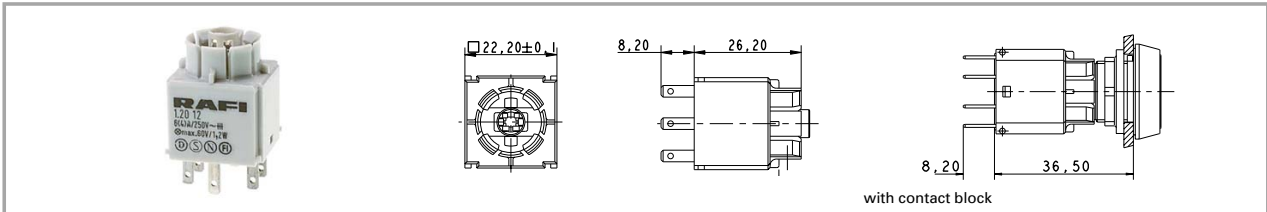

Contact function	Contact arrangement	Lamp socket	Rated insulation voltage $U_i$ , AC	Ohmic rated current $I_R$	Order no.
momentary	1 NC + 1 NO	W 2 x 4.6d	250 V	6 A	<b>1.20.123.001/0000</b>
momentary	1 NC	W 2 x 4.6d	250 V	6 A	1.20.123.002/0000
momentary	1 NO	W 2 x 4.6d	250 V	6 A	<b>1.20.123.003/0000</b>
momentary	2 NC	W 2 x 4.6d	250 V	6 A	<b>1.20.123.004/0000</b>
momentary	2 NO	W 2 x 4.6d	250 V	6 A	1.20.123.005/0000

Technical data see page 2 - 56

Universal contact blocks have two separate contact chambers and two actuator plungers. This makes it possible to switch two different polarities. The NC contacts are positive opening contacts to IEC 60947-5-1.

2

RAFIX  
16

**RAFIX 16 universal contact block, silver contacts, without lamp socket**

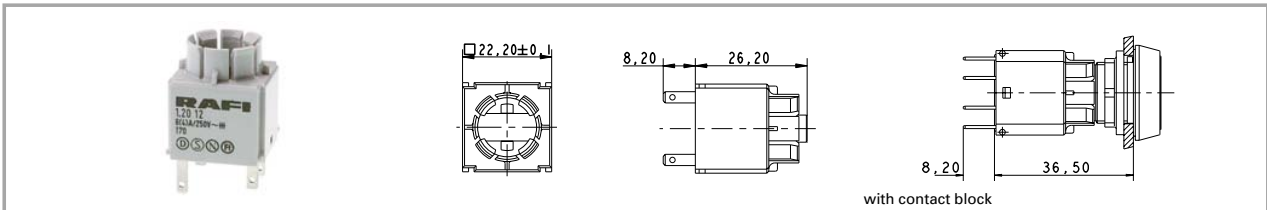

Contact function	Contact arrangement	Lamp socket	Rated insulation voltage $U_i$ , AC	Ohmic rated current $I_R$	Order no.
momentary	1 NC + 1 NO		250 V	6 A	<b>1.20.123.021/0000</b>
momentary	1 NC		250 V	6 A	<b>1.20.123.022/0000</b>
momentary	1 NO		250 V	6 A	<b>1.20.123.023/0000</b>
momentary	2 NC		250 V	6 A	<b>1.20.123.024/0000</b>
momentary	2 NO		250 V	6 A	<b>1.20.123.025/0000</b>

Technical data see page 2 - 56

Universal contact blocks have two separate contact chambers and two actuator plungers. This makes it possible to switch two different polarities. The NC contacts are positive opening contacts to IEC 60947-5-1.

**RAFIX 16 lamp socket**



2

RAFIX 16

**Technical data**

**Dimensions**

Length see order block  
Width see order block  
Height see order block  
Mounting depth see order block

**Mechanical design**

Mounting see order block  
Lamp socket wedge-base W 2 x 4.6d  
Terminals quick connector 2.8 x 0.8  
Terminal marking X1 = anode, X2 = cathode  
Robustness 100 N

**Electrical characteristics**

Rated voltage max. 60 V  
Rated power max. 1.2 W

**Other specifications**

Approvals ENEC 25 T 70 (55), UL, CSA

Shock resistance acc. to IEC 600 68-2-27

amplitude < 50g, 11ms, half sinusoidal

Ambient temp. operating min.

-25 °C

Ambient temp. operating with lamp max.

+55 °C

Storage temperature min.

-40 °C

Storage temperature max.

+85 °C

Resistance to constant environment

according to IEC 600 68-2-3 and 2-30

Resistance at variable environment

according to IEC 600 68-2-14 and 2-33 V 0

Flame class acc. to UL 94

Hot wire ignition acc. to IEC 60695-2-1

yes

Resistance to vibrations acc. to IEC 600 68-2-6

10 g at 20 ... 500 Hz

**Accessories RAFIX 16 lamp socket**

Description	Photo	Order no.	Page
Filament lamp, W 2 x 4.6d base, 24 - 30 V		<b>1.90.120.005/0000</b>	5 - 4
Filament lamp, W 2 x 4.6d base, 60 V		<b>1.90.120.009/0000</b>	5 - 4
Filament lamp, W 2 x 4.6d base, 48 V		<b>1.90.120.010/0000</b>	5 - 4
Filament lamp, W 2 x 4.6d base, 24 V		<b>1.90.120.011/0000</b>	5 - 4
Filament lamp, W 2 x 4.6d base, 12 V		<b>1.90.120.012/0000</b>	5 - 4
Filament lamp, W 2 x 4.6d base, 6 V		<b>1.90.120.013/0000</b>	5 - 4
LED W 2 x 4.6d superbright, red, 24 V		<b>1.90.690.361/0000</b>	5 - 16

**Accessories RAFIX 16 lamp socket**

Description	Photo	Order no.	Page
LED W 2 x 4.6d superbright, green, 24 V		<b>1.90.690.362/0000</b>	5 - 16
LED W 2 x 4.6d superbright, yellow, 24 V		<b>1.90.690.363/0000</b>	5 - 16
LED W 2 x 4.6d superbright, blue, 24 V		<b>1.90.690.364/0000</b>	5 - 16
LED W 2 x 4.6d superbright, white, 24 V		<b>1.90.690.365/0000</b>	5 - 16
PCB plug-in socket, 2 contacts (lamp socket)		5.05.510.649/0000	2 - 62
Protection against contact		5.55.103.105/0100	2 - 64

2

RAFIX  
16

**RAFIX 16 lamp socket W 2 x 4.6 d**

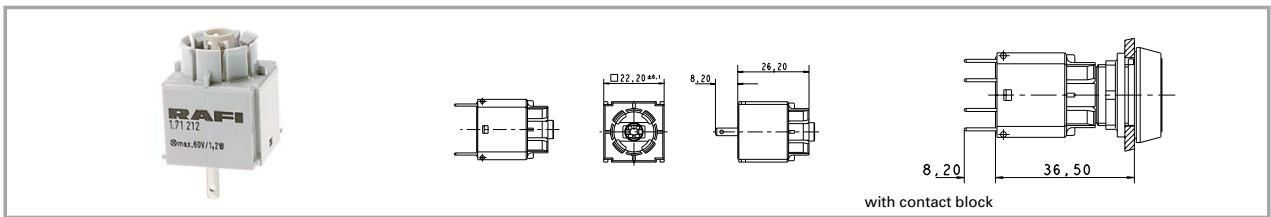

Rated voltage max.	Rated power max.	Lamp socket	Mounting	Mounting depth	Order no.
60 V	1.2 W	wedge-base W 2 x 4.6d	click on signal indicator	44.7 mm	<b>1.71.212.001/0000</b>

Technical data see page 2 - 60

A notch on the lamp socket identifies the cathode side.

**RAFIX 16 lamp socket W 2 x 4.6 d**

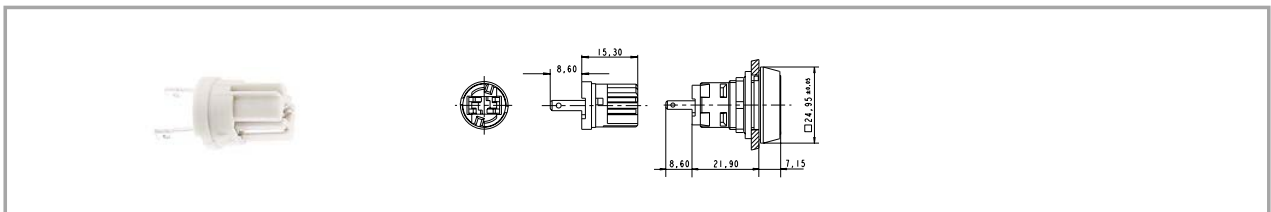

Rated voltage max.	Rated power max.	Lamp socket	Mounting	Mounting depth	Order no.
60 V	1.2 W	wedge-base W 2 x 4.6d	snap into signal indicator	30.5 mm	<b>1.71.212.011/0000</b>

Technical data see page 2 - 60

A notch on the lamp socket identifies the cathode side.

**RAFIX 16 special accessories**

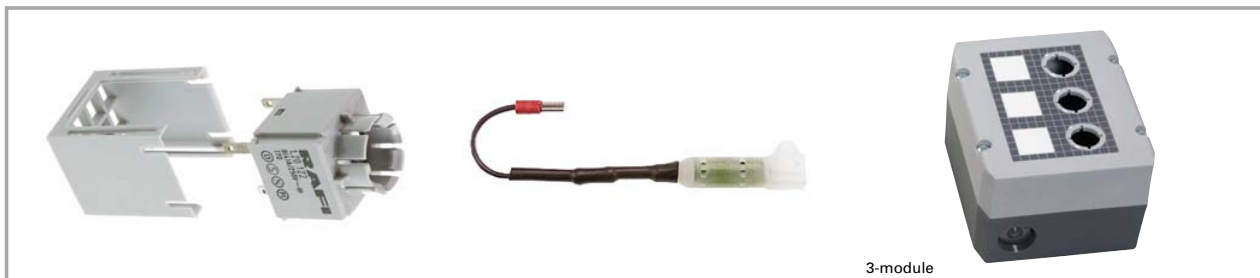

3-module

2

**PCB plug-in socket**

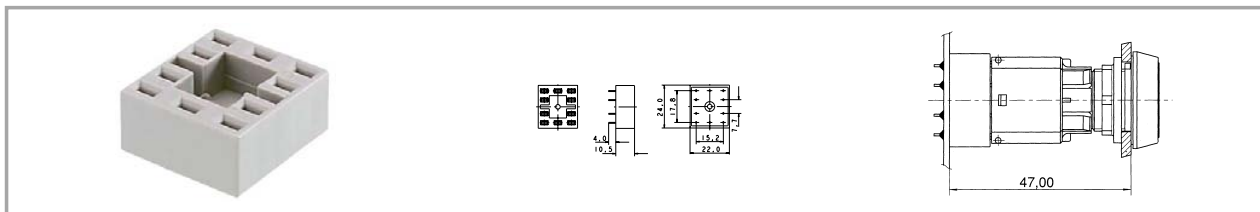

RAFIX  
16

Short text	Feature 1	Feature 2	Order no.
PCB plug-in socket, 10 contacts (universal application)	22 mm	24 mm	<b>5.05.510.644/0000</b>
PCB plug-in socket, 6 contacts (2 NO, lamp socket)	22 mm	24 mm	<b>5.05.510.645/0000</b>
PCB plug-in socket, 6 contacts (1 NC, 1 NO, lamp socket)	22 mm	24 mm	<b>5.05.510.646/0000</b>
PCB plug-in socket, 6 contacts (2 NC, lamp socket)	22 mm	24 mm	5.05.510.647/0000
PCB plug-in socket, 4 contacts (2 NC)	22 mm	24 mm	5.05.510.648/0000
PCB plug-in socket, 2 contacts (lamp socket)	22 mm	24 mm	5.05.510.649/0000

For soldering onto PCBs. The PCB carrying the plug-in sockets is plugged onto the contact blocks/lamp sockets. Additional fixing of the PCB to the contact block is not required. Solder terminals for PCB 3.5 mm long, for 1.3 mm hole.

**Multipole connector**

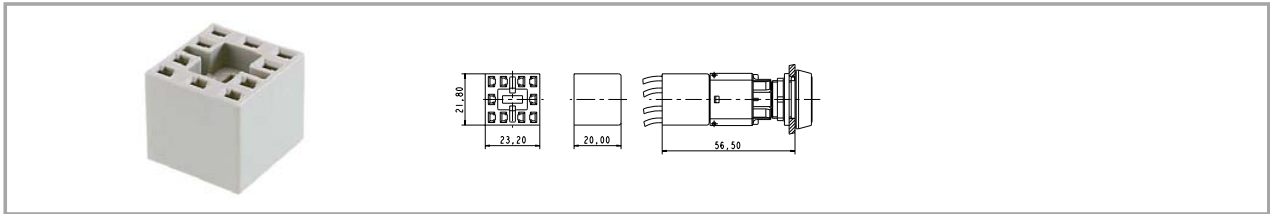

Short text	Feature 1	Feature 2	Order no.
Multipole connector	21.8 mm	23.2 mm	<b>5.05.510.421/0000</b>

Makes it possible to simultaneously connect all terminals of a contact block. Can be fitted with 2.8 mm female quick-connect terminals.

**Female quick-connect terminal DIN 46340-B 2.8-1-MS**



Short text	Feature 1	Feature 2	Order no.
Female quick-connect terminal DIN 46340-B 2.8-1-MS			<b>5.37.540.024/8622</b>

With latching detent for mating with a multipole connector.

**Plug distributor**



Short text	Feature 1	Feature 2	Order no.
Plug distributor			<b>5.37.540.029/6000</b>

For mounting on the quick-connect terminals of contact blocks. The double number of contacts facilitates loop-through.

2

RAFIX  
16

**Protection against contact**

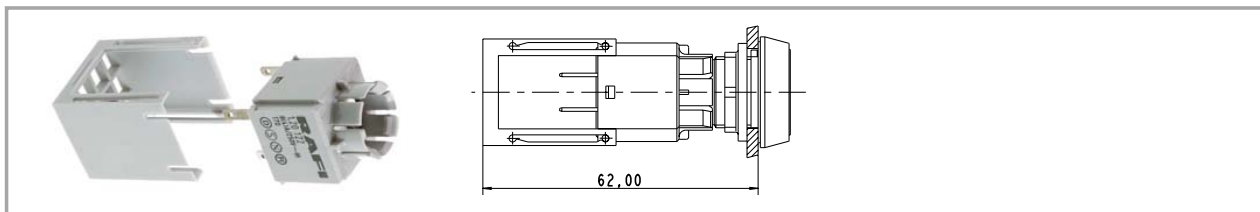

Short text	Feature 1	Feature 2	Order no.
Protection against contact			5.55.103.105/0100

Assembly sequence: Snap the protection against contact onto the contact block, connect wires to quick-connect terminals of contact block, pull protection against contact over the terminals; this ensures finger-proof condition to VBG 4.

2

RAFIX  
16

**Protection against contact**



Short text	Feature 1	Feature 2	Order no.
Protection against contact (VBG 4 with lamp socket 1.71.212.011)			5.55.103.134/0700

You can use the protection against contact to cover the terminals of the lamp socket 1.71.212.011/0000 so that they are finger-proof to VBG 4.

**Series capacitor**



Short text	Feature 1	Feature 2	Order no.
Series capacitor, 125 V/48 V~, 50 Hz, 25 mA			5.03.771.333/0000
Series capacitor, 230 V/48 V~, 50 Hz, 25 mA			5.03.771.334/0000

Fully encapsulated, with a 2.8 x 0.8 mm quick-connect tab in a touch-proof arrangement.

**Disassembly tool**

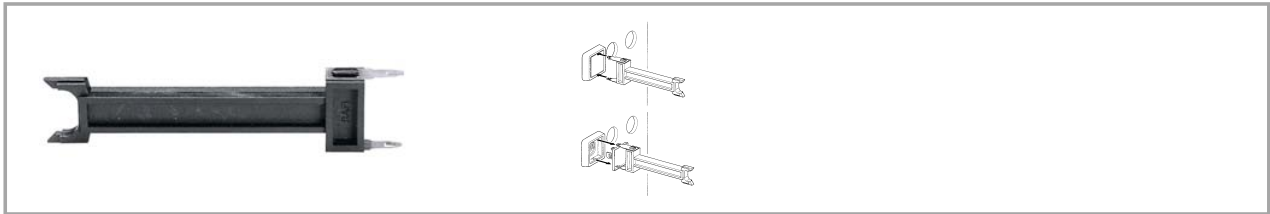

Short text	Feature 1	Feature 2	Feature 2
Disassembly tool for LUMOTAST 25, RAFIX 16			<b>5.05.800.042/0000</b>

For replacing pushbutton and signal indicator lenses.

**Protective cover, suitable for lead seal, for pushbuttons, alignable without gaps**



Short text	Feature 1	Feature 2	Feature 2
Protective cover, suitable for lead seal			<b>5.05.800.055/0000</b>

To prevent inadvertent operation. The legend is easily visible even when the cap is closed.

**Fixing spanner for hexagon nut**



Short text	Feature 1	Feature 2	Order no.
Fixing spanner for hexagon nut			<b>5.58.002.034/0000</b>

2

RAFIX  
16



**RAFIX 16 insulating housing**



Pict.: 3-module

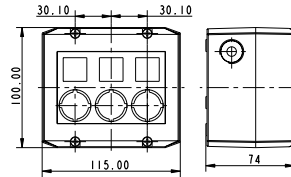

2

RAFIX  
16

Short text	Feature 1	Feature 2	Order no.
RAFIX 16 insulating housing, 1-module, light grey/dark grey	55 mm	100 mm	1.20.810.001/0000
RAFIX 16 insulating housing, 1-module, yellow/yellow	55 mm	100 mm	1.20.810.002/0000
RAFIX 16 insulating housing, 2-module, light grey/dark grey	115 mm	100 mm	1.20.820.001/0000
RAFIX 16 insulating housing, 3-module, light grey/dark grey	115 mm	100 mm	1.20.830.001/0000
RAFIX 16 insulating housing, 4-module, light grey/dark grey	145 mm	100 mm	1.20.840.001/0000
Label sheet for housings			5.40.451.283/0000

- Attractive plastic housing to accommodate up to 4 control components
- 2 cable entries prepared: 1-,2-,3-part: M20x1,5, 4-part: M25x1,5
- Degree of protection IP 65 to DIN
- All grey housings with overlay, legending possible with legend inserts
- Wall mounting with 2 screws through housing bottom prepared
- Dimensions (feature 2) x 100 mm x 74 mm
- Accessories: 50 pre-perforated legend inserts on a DIN A4 sheet for printing with a PC printer

**RAFIX 16 label holder, flush, for square collar**

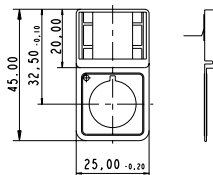

Short text	Feature 1	Feature 2	Order no.
Label holder, flush, for square collar			<b>5.07.620.004/0000</b>

- Accessories:**  
 Legend label 23 x 16 for label holder, without legend: **5.73.111.000/0000**  
 Legending available on request.

**RAFIX 16 label holder, flush, for round collar**

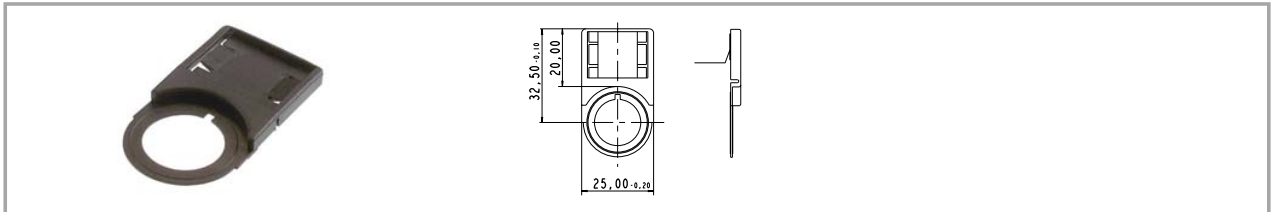

Short text	Feature 1	Feature 2	Order no.
Label holder, flush, for round collar			<b>5.07.620.006/0000</b>

**Accessories:**  
Beschriftungsschild 23 x 16 für Schildträger, ohne Beschriftung: **5.73.111.000/0000**  
Legending available on request.

2

RAFIX  
16

**RAFIX 16 label holder, protruding, for square flush fitting collar**

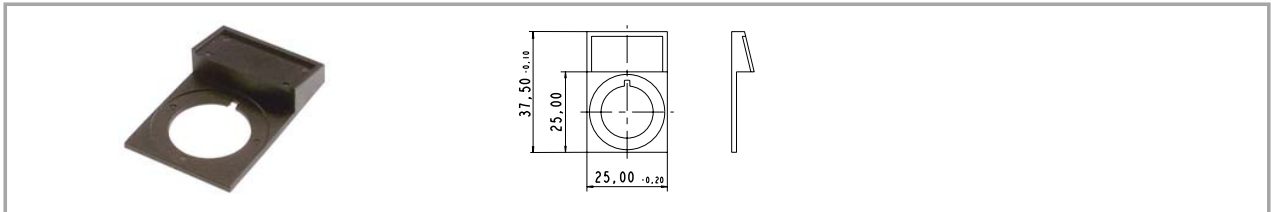

Short text	Feature 1	Feature 2	Order no.
Label holder, protruding, for square flush fitting collar			<b>5.07.620.007/0000</b>

**Accessories:**  
Legend label 23 x 16, without legend: **5.73.112.000/0000**  
Legending available on request.

**Emergency stop label, yellow, round 60 mm, PVC adhesive**



2

RAFIX  
16

Short text	Feature 1	Feature 2	Order no.
Emergency stop label, yellow, round 60 mm, PVC adhesive, without legend	60 mm		<b>5.76.204.400/0400</b>
Emergency stop label, yellow, round 60 mm, PVC adhesive, with legend „NOT-AUS“	60 mm		<b>5.76.204.401/0400</b>
Emergency stop label, yellow, round 60 mm, PVC adhesive, with legend „EMERGENCY STOP“	60 mm		<b>5.76.204.403/0400</b>

**LUMOTAST 25, RAFIX 16 blanking cap complete with sealing disc and ring nut**



Short text	Feature 1	Feature 2	Order no.
Blanking cap complete with sealing disc and ring nut, square			<b>5.05.800.049/0100</b>
Blanking cap complete with sealing disc and ring nut, round			5.05.800.050/0100
Blanking cap complete with sealing disc and ring nut, square, alignable without gaps			5.05.800.051/0100

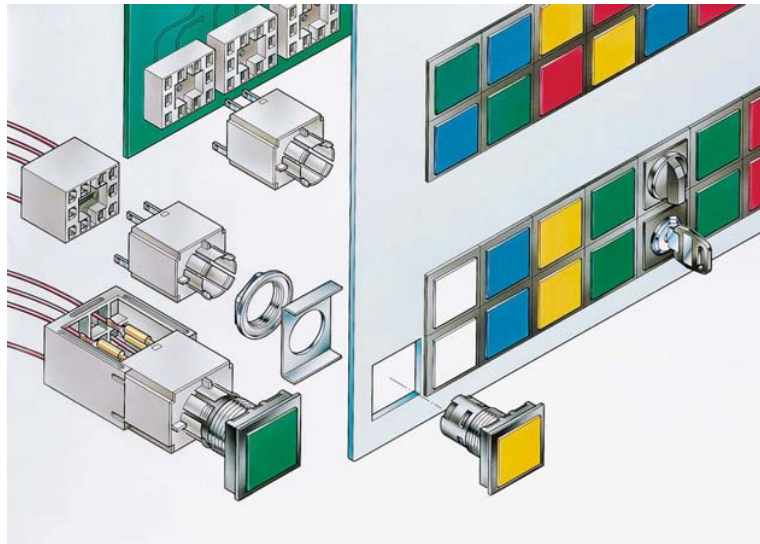

**General data**

**RAFIX 16 F control component range**

- Extremely low profile
- 250 V/6 A max.
- Water-jet proof IP65
- Contact blocks: Gold and silver contacts with quick-connect terminals 2.8 x 0.8 mm; Option: PCB plug-in socket
- The lamps of the pushbuttons can be replaced from the front or rear.
- The contact blocks snap directly onto the actuators without a coupling element and can be removed by turning = cost reducing mounting.
- **For contact blocks and accessories, refer to RAFIX 16.**
- Versions with round collars on request

The specified data apply only if actuators/signal indicators are combined with contact blocks and lamp sockets within the same product range.

**Content**

<b>RAFIX 16 F pushbutton</b>	<b>2 - 70</b>
RAFIX 16 F pushbutton, flush lens	2 - 71
RAFIX 16 F pushbutton, protruding lens	2 - 72
<b>RAFIX 16 F selector switch</b>	<b>2 - 74</b>
RAFIX 16 F selector switch	2 - 75
<b>RAFIX 16 F keylock switch MICROMECC</b>	<b>2 - 76</b>
RAFIX 16 F keylock switch MICROMECC	2 - 77
<b>RAFIX 16 F emergency stop pushbutton</b>	<b>2 - 78</b>
RAFIX 16 F emergency stop pushbutton	2 - 79
<b>RAFIX 16 F signal indicator</b>	<b>2 - 80</b>
RAFIX 16 F signal indicator, flush lens	2 - 81
RAFIX 16 F signal indicator, protruding lens	2 - 81
<b>RAFIX 16 F special accessories</b>	<b>2 - 82</b>
RAFIX 16 F, blanking cap	2 - 82
RAFIX 16 F, insulating housing IP65	2 - 82

Control components	2 - 69
--------------------	--------

**RAFIX 16 F pushbutton**

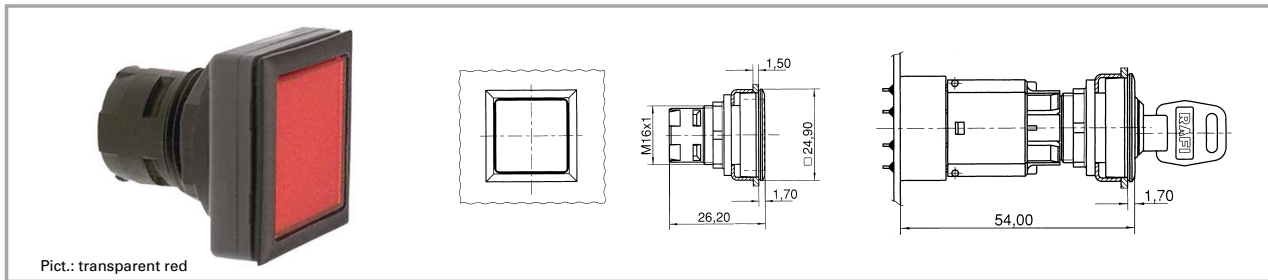

Pict.: transparent red

**2**

**Technical data**

**General information**

Form of lens see order block  
 Colour of lens see order block  
 Form of collar square

**Dimensions**

Length of collar 24.9 mm  
 Width of collar 24.9 mm  
 Overall height see order block  
 Mounting depth 51.7 mm  
 Key grid 25 x 25 mm  
 Mounting hole 23.1 x 23.1 mm

**Mechanical design**

Mounting ring nut  
 Contact function according to contact block  
 Illuminability see order block

**Mechanical characteristics**

Robustness min. 100 N

**Other specifications**

Operating life 200000 momentary/100000 latching

Degree of protection from front side IP65

Ambient temp. operating min. -25 °C

Ambient temp. operating without lamp max. +70 °C

Ambient temp. operating with lamp max. +55 °C

Storage temperature min. -40 °C

Storage temperature max. +85 °C

Resistance to constant environment according to IEC 600 68-2-3 and 2-30

Resistance at variable environment according to IEC 600 68-2-14 and 2-33

RAFIX  
16 F

**Accessories RAFIX 16 F pushbutton**

Description	Photo	Order no.	Page
RAFIX 16 standard contact block, 1 NC + 1 NO, momentary, silver contacts, with lamp socket		<b>1.20.122.001/0000</b>	2 - 58
RAFIX 16 standard contact block, 1 NC + 1 NO, momentary, gold contacts, with lamp socket		1.20.122.011/0000	2 - 54
RAFIX 16 standard contact block, 1 NC + 1 NO, momentary, silver contacts, without lamp socket		<b>1.20.122.021/0000</b>	2 - 58
RAFIX 16 standard contact block, 1 NC + 1 NO, momentary, gold contacts, without lamp socket		1.20.122.031/0000	2 - 54
LED W 2 x 4.6d superbright, white, 24 V		<b>1.90.690.365/0000</b>	5 - 16
Disassembly tool for LUMOTAST 25, RAFIX 16		<b>5.05.800.042/0000</b>	2 - 65 5 - 24
Fixing spanner for hexagon nut		<b>5.58.002.034/0000</b>	2 - 65

**Accessories RAFIX 16 F pushbutton**

Description	Photo	Order no.	Page
Legend insert, blank, use only for transparent lenses		5.70.635.000/2000	

For other contact blocks, refer to the chapter „RAFIX 16 contact blocks“; for additional accessories, refer to the chapter „RAFIX 16 special accessories“.

**RAFIX 16 F pushbutton, flush lens**

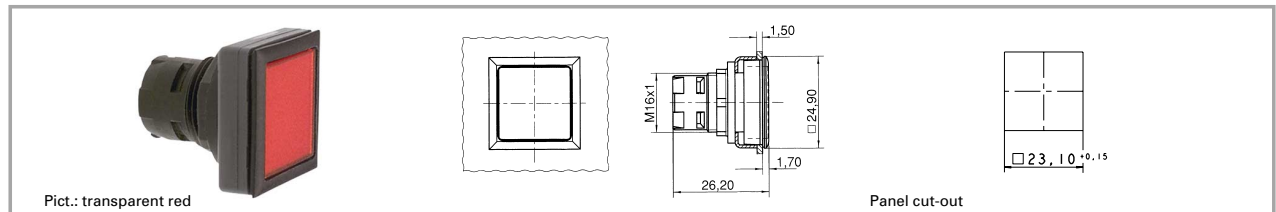

Form of lens	Illuminability	Colour of lens	Order no. complete	Order no. single parts	
				Housing	Lens
flat lens	no	opaque black	1.30.090.251/0100	-	-
flat lens	no	opaque white	1.30.090.251/0200	-	-
flat lens	no	opaque red	1.30.090.251/0300	-	-
flat lens	no	opaque yellow	1.30.090.251/0400	-	-
flat lens	no	opaque green	1.30.090.251/0500	-	-
flat lens	no	opaque blue	1.30.090.251/0600	-	-
flat lens	yes	transparent colourless	1.30.090.001/1000	<b>1.30.090.501/0000</b>	<b>5.49.077.011/1002</b>
flat lens	yes	transparent red	1.30.090.001/1300	<b>1.30.090.501/0000</b>	<b>5.49.077.011/1306</b>
flat lens	yes	transparent yellow	1.30.090.001/1400	<b>1.30.090.501/0000</b>	<b>5.49.077.011/1403</b>
flat lens	yes	transparent green	1.30.090.001/1500	<b>1.30.090.501/0000</b>	<b>5.49.077.011/1505</b>
flat lens	yes	transparent blue	1.30.090.001/1600	<b>1.30.090.501/0000</b>	<b>5.49.077.011/1607</b>

Technical data see page 2 - 70

**Accessories:**

Legend insert, blank, use only for transparent lenses: **5.70.635.000/2000**

For the "latching" function, please use the RAFIX 16 standard contact block with "latching" function.

**RAFIX 16 F pushbutton, protruding lens**

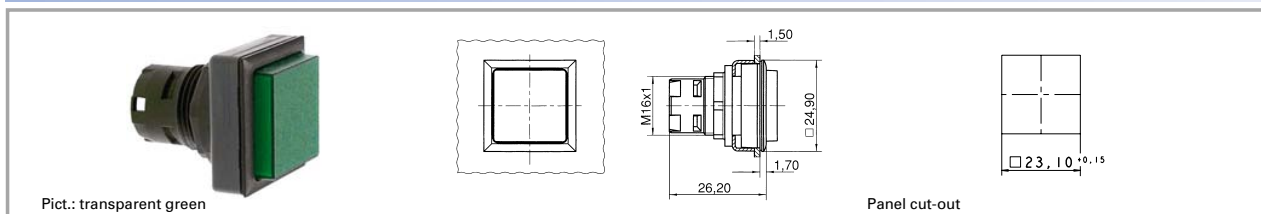

Pict.: transparent green

Panel cut-out

2

RAFIX  
16 F

Form of lens	Illuminability	Colour of lens	Order no. complete	Order no. single parts	
				Housing	Lens
protruding lens	no	opaque black	1.30.090.301/0100 -	-	-
protruding lens	no	opaque white	1.30.090.301/0200 -	-	-
protruding lens	no	opaque red	1.30.090.301/0300 -	-	-
protruding lens	no	opaque yellow	1.30.090.301/0400 -	-	-
protruding lens	no	opaque green	1.30.090.301/0500 -	-	-
protruding lens	no	opaque blue	1.30.090.301/0600 -	-	-
protruding lens	yes	transparent colourless	1.30.090.051/1000	1.30.090.551/0000	<b>5.49.077.012/1002</b>
protruding lens	yes	transparent red	1.30.090.051/1300	1.30.090.551/0000	<b>5.49.077.012/1306</b>
protruding lens	yes	transparent yellow	1.30.090.051/1400	1.30.090.551/0000	<b>5.49.077.012/1403</b>
protruding lens	yes	transparent green	1.30.090.051/1500	1.30.090.551/0000	<b>5.49.077.012/1505</b>
protruding lens	yes	transparent blue	1.30.090.051/1600	1.30.090.551/0000	<b>5.49.077.012/1607</b>

Technical data see page 2 - 70

**Accessories:**

Legend insert, blank, use only for transparent lenses: **5.70.635.000/2000**

For the "latching" function, please use the RAFIX 16 standard contact block with "latching" function.

**RAFIX 16 F selector switch**

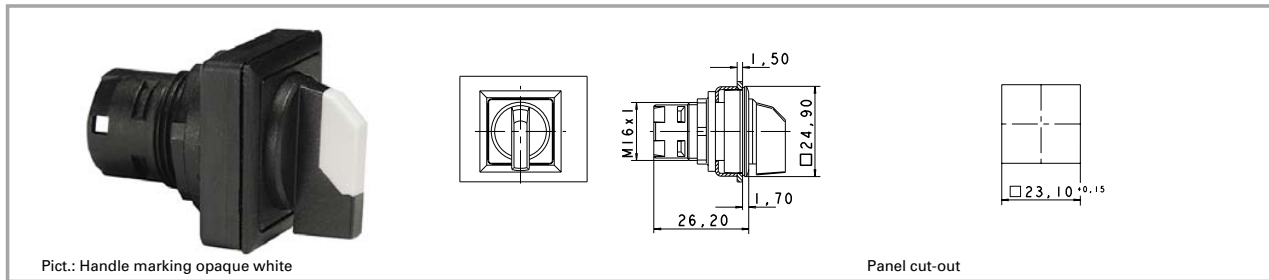

Pict.: Handle marking opaque white

Panel cut-out

**2**

**General data**

The illuminated selector switches are provided with translucent handle markings. These are opaque on the non-illuminated versions.

**Technical data**

RAFIX  
16 F

**General information**

Form of lens handle  
 Colour of handle marking see order block  
 Form of collar square

**Dimensions**

Length of collar 24.9 mm  
 Key grid 25 x 25 mm  
 Width of collar 24.9 mm  
 Overall height 23 mm  
 Mounting depth 51.7 mm  
 Mounting hole 23.1 x 23.1 mm

**Mechanical design**

Mounting ring nut  
 Contact function according to contact block  
 Illuminability see order block  
 Rotating angle see order block

**Mechanical characteristics**

Torque max. 1,3 Nm

**Other specifications**

Operating life 30000  
 Degree of protection from front side IP65  
 Ambient temp. operating min. -25 °C  
 Ambient temp. operating without lamp max. +70 °C  
 Ambient temp. operating with lamp max. +55 °C  
 Storage temperature min. -40 °C  
 Storage temperature max. +85 °C  
 Resistance to constant environment according to IEC 600 68-2-3 and 2-30  
 Resistance at variable environment according to IEC 600 68-2-14 and 2-33

**Accessories RAFIX 16 F selector switch**

Description	Photo	Order no.	Page
RAFIX 16 universal contact block, 1 NC + 1 NO, momentary, silver contacts, with lamp socket		<b>1.20.123.001/0000</b>	2 - 59
RAFIX 16 universal contact block, 1 NC + 1 NO, momentary, gold contacts, with lamp socket		1.20.123.011/0000	2 - 55
Fixing spanner for hexagon nut		<b>5.58.002.034/0000</b>	2 - 65



**RAFIX 16 F selector switch**

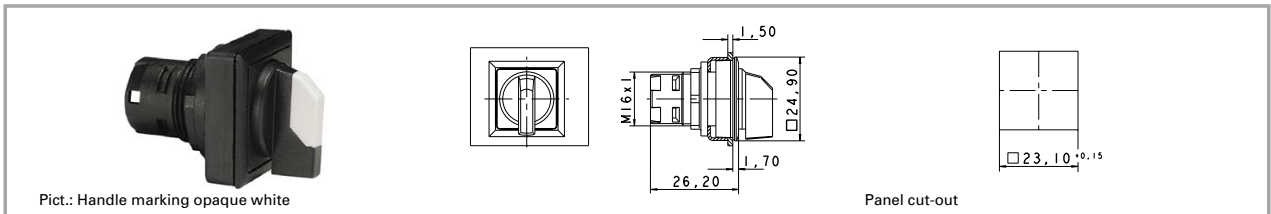

Contact function	Illuminability	Rotating angle		Colour of handle marking	Order no.
momentary	yes	1 x 40°		translucent white	1.30.093.551/2000
momentary	yes	2 x 40°		translucent white	1.30.093.651/2000
latching	yes	L, 1 x 90°		translucent white	1.30.093.501/2000
latching	yes	V, 1 x 90°		translucent white	1.30.093.601/2000
latching	yes	2 x 60°		translucent white	1.30.093.701/2000
momentary	no	1 x 40°		opaque white	1.30.093.550/0200
momentary	no	2 x 40°		opaque white	1.30.093.650/0200
latching	no	L, 1 x 90°		opaque white	1.30.093.500/0200
latching	no	V, 1 x 90°		opaque white	1.30.093.600/0200
latching	no	2 x 60°		opaque white	1.30.093.700/0200

Technical data see page 2 - 74

Only use RAFIX 16 contact blocks with "momentary" contact function. For versions with clockwise and counterclockwise rotation, use universal contact blocks only.  
Other contact functions and handle markings available on request.

2

RAFIX  
16 F

**RAFIX 16 F keylock switch MICROMECC**

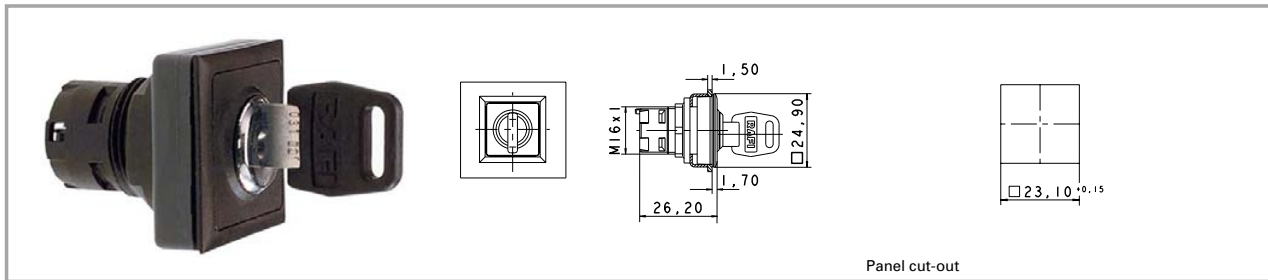

**2**

**Technical data**

**General information**

Form of lens flat lens  
 Colour of lens opaque black  
 Form of collar square

**Dimensions**

Length of collar 24.9 mm  
 Key grid 25 x 25 mm  
 Width of collar 24.9 mm  
 Overall height 11 mm  
 Mounting depth 51.7 mm  
 Mounting hole 23.1 x 23.1 mm

**Mechanical design**

Mounting ring nut  
 Contact function according to contact block  
 Illuminability no  
 Lock Micromec  
 Wafers 5  
 Lock type 001  
 Number of locking positions 500  
 Main key on request  
 Symmetric key no  
 Rotating angle see order block  
 Key removal position see order block  
 Group key on request  
 General key on request

**Mechanical characteristics**

Torque max. 1,3 Nm

**Electrical characteristics**

Protection class II

**Other specifications**

Operating life 65000  
 Degree of protection from front side IP65  
 Ambient temp. operating min. -25 °C  
 Ambient temp. operating max. +70 °C  
 Storage temperature min. -40 °C  
 Storage temperature max. +85 °C  
 Resistance to constant environment according to IEC 600 68-2-3 and 2-30  
 Resistance at variable environment according to IEC 600 68-2-14 and 2-33  
 ESD-strength lock / contact 15 kV  
 ESD-strength key/ front panel 4 kV

RAFIX  
16 F

**Accessories RAFIX 16 F keylock switch MICROMECC**

Description	Photo	Order no.	Page
RAFIX 16 universal contact block, 1 NC + 1 NO, momentary, silver contacts, without lamp socket		<b>1.20.123.021/0000</b>	2 - 59
RAFIX 16 universal contact block, 1 NC + 1 NO, momentary, gold contacts, without lamp socket		<b>1.20.123.031/0000</b>	2 - 55
Fixing spanner for hexagon nut		<b>5.58.002.034/0000</b>	2 - 65
Spare key, for single action, e.g. 1 x 90°		5.58.007.001/0000	





**Accessories RAFIX 16 F keylock switch MICROMECC**

Description	Photo	Order no.	Page
Spare key, for double action, e.g. 2 x 90°		5.58.008.001/0000	

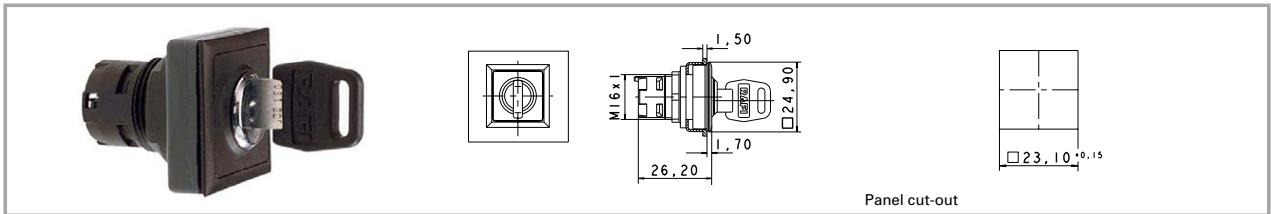
For additional accessories, refer to the chapter „RAFIX 16 special accessories“.

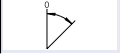
**RAFIX 16 F keylock switch MICROMECC**

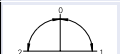

Contact function	Colour of lens	Rotating angle	Key removal position	Order no.
momentary	opaque black	1 x 40°		1.30.096.501/0000
momentary	opaque black	2 x 40°		1.30.096.701/0000
latching	opaque black	L, 1 x 90°		1.30.096.051/0000
latching	opaque black	V, 1 x 90°		1.30.096.151/0000
latching	opaque black	2 x 90°		1.30.096.401/0000

Technical data see page 2 - 76

**2**

**RAFIX 16 F**

**RAFIX 16 F emergency stop pushbutton**

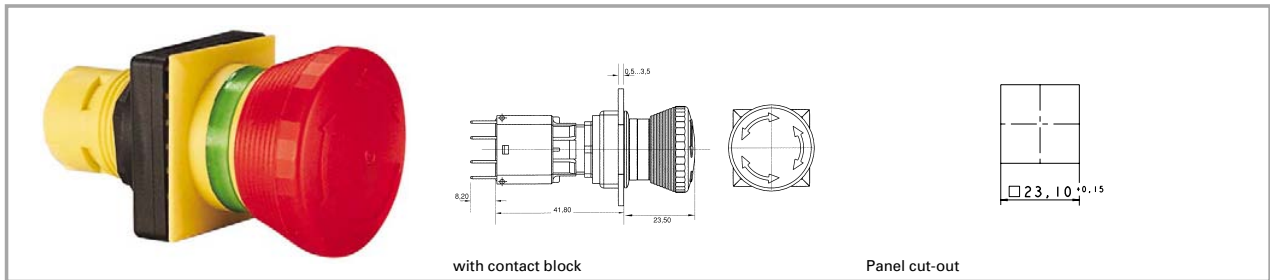

**2**

**Technical data**

**General information**

Actuator conical mushroom form  
 Colour of mushroom red, collar yellow  
 Form of collar square

**Dimensions**

Length of collar 24.9 mm  
 Key grid 25 x 25 mm  
 Width of collar 24.9 mm  
 Overall height 23.5 mm  
 Mounting depth 51.7 mm  
 Mounting hole 23.1 x 23.1 mm

**Mechanical design**

Mounting ring nut  
 Contact function latching  
 Illuminability no

**Mechanical characteristics**

Robustness min. 100 N

**Other specifications**

Operating life 10000  
 Degree of protection from front side IP65  
 Ambient temp. operating min. -25 °C  
 Ambient temp. operating without lamp max. +70 °C  
 Storage temperature min. -40 °C  
 Storage temperature max. +85 °C  
 Resistance to constant environment according to IEC 600 68-2-3 and 2-30  
 Resistance at variable environment according to IEC 600 68-2-14 and 2-33  
 Approvals IEC 60 947, EN 418

RAFIX  
16 F

**Accessories RAFIX 16 F emergency stop pushbutton**

Description	Photo	Order no.	Page
RAFIX 16 universal contact block, 1 NC, momentary, silver contacts, without lamp socket		<b>1.20.123.022/0000</b>	2 - 59
RAFIX 16 universal contact block, 1 NC, momentary, gold contacts, without lamp socket		<b>1.20.123.032/0000</b>	2 - 55
Fixing spanner for hexagon nut		<b>5.58.002.034/0000</b>	2 - 65

For other contact blocks, refer to the chapter „RAFIX 16 contact blocks“; for additional accessories, refer to the chapter „RAFIX 16 special accessories“.

**RAFIX 16 F emergency stop pushbutton**

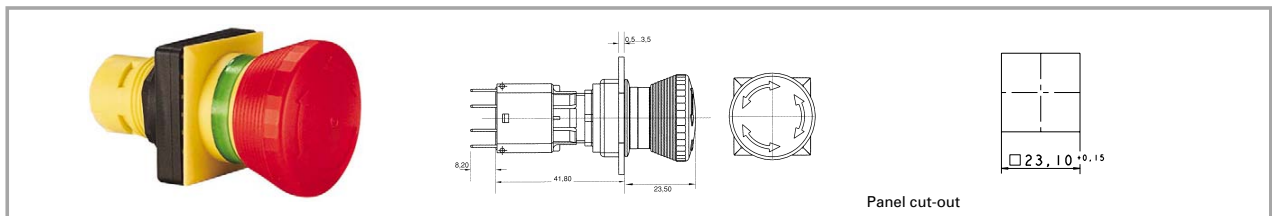

Contact function	Illuminability	Colour of mushroom	Mounting hole	Order no.
latching	no	red, collar yellow	23.1 x 23.1 mm	1.30.094.001/0300

Technical data see page 2 - 78

2

**RAFIX  
16 F**

**RAFIX 16 F signal indicator**



Pict.: transparent red

transparent green

Panel cut-out

**2**

**Technical data**

**General information**

Form of lens see order block  
 Colour of lens see order block  
 Form of collar square

**Dimensions**

Length of collar 24.9 mm  
 Key grid 25 x 25 mm  
 Width of collar 24.9 mm  
 Overall height see order block  
 Mounting depth 51,7 (37,5) mm  
 Mounting hole 23.1 x 23.1 mm

**Mechanical design**

Mounting ring nut  
 Illuminability yes

**Other specifications**

Degree of protection from front side IP65  
 Ambient temp. operating min. -25 °C  
 Ambient temp. operating max. +55 °C  
 Storage temperature min. -40 °C  
 Storage temperature max. +85 °C  
 Resistance to constant environment according to IEC 600 68-2-3 and 2-30  
 Resistance at variable environment according to IEC 600 68-2-14 and 2-33

RAFIX  
16 F

**Accessories RAFIX 16 F signal indicator**

Description	Photo	Order no.	Page
RAFIX 16 lamp socket W 2 x 4.6 d		<b>1.71.212.001/0000</b>	2 - 61
RAFIX 16 lamp socket W 2 x 4.6 d		<b>1.71.212.011/0000</b>	2 - 61
Fixing spanner for hexagon nut		<b>5.58.002.034/0000</b>	2 - 65
Legend insert, blank, use only for transparent lenses		5.70.635.000/2000	

For additional accessories, refer to the chapter „RAFIX 16 special accessories“.

**RAFIX 16 F signal indicator, flush lens**

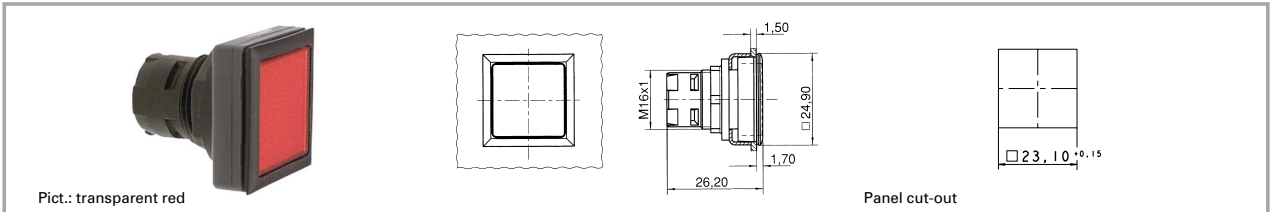

Form of lens	Overall height	Colour of lens	Order no. complete	Order no. single parts	
				Housing	Lens
flat lens	1.7 mm	transparent colourless	1.65.126.301/1000	1.65.126.401/0000	<b>5.49.077.011/1002</b>
flat lens	1.7 mm	transparent red	1.65.126.301/1300	1.65.126.401/0000	<b>5.49.077.011/1306</b>
flat lens	1.7 mm	transparent yellow	1.65.126.301/1400	1.65.126.401/0000	<b>5.49.077.011/1403</b>
flat lens	1.7 mm	transparent green	1.65.126.301/1500	1.65.126.401/0000	<b>5.49.077.011/1505</b>
flat lens	1.7 mm	transparent blue	1.65.126.301/1600	1.65.126.401/0000	<b>5.49.077.011/1607</b>

Technical data see page 2 - 80

**Accessories:**

Legend insert, blank, use only for transparent lenses: **5.70.635.000/2000**

2

RAFIX  
16 F

**RAFIX 16 F signal indicator, protruding lens**

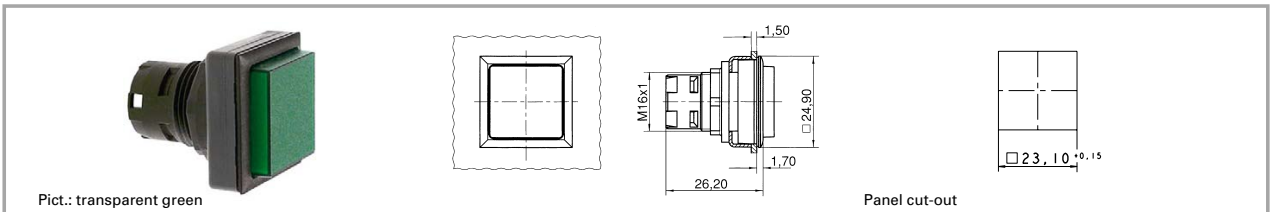

Form of lens	Overall height	Colour of lens	Order no. complete	Order no. single parts	
				Housing	Lens
protruding lens	4.5 mm	transparent colourless	1.65.126.351/1000	1.65.126.451/0000	<b>5.49.077.012/1002</b>
protruding lens	4.5 mm	transparent red	1.65.126.351/1300	1.65.126.451/0000	<b>5.49.077.012/1306</b>
protruding lens	4.5 mm	transparent yellow	1.65.126.351/1400	1.65.126.451/0000	<b>5.49.077.012/1403</b>
protruding lens	4.5 mm	transparent green	1.65.126.351/1500	1.65.126.451/0000	<b>5.49.077.012/1505</b>
protruding lens	4.5 mm	transparent blue	1.65.126.351/1600	1.65.126.451/0000	<b>5.49.077.012/1607</b>

Technical data see page 2 - 80

**Accessories:**

Legend insert, blank, use only for transparent lenses: **5.70.635.000/2000**

**RAFIX 16 F special accessories**

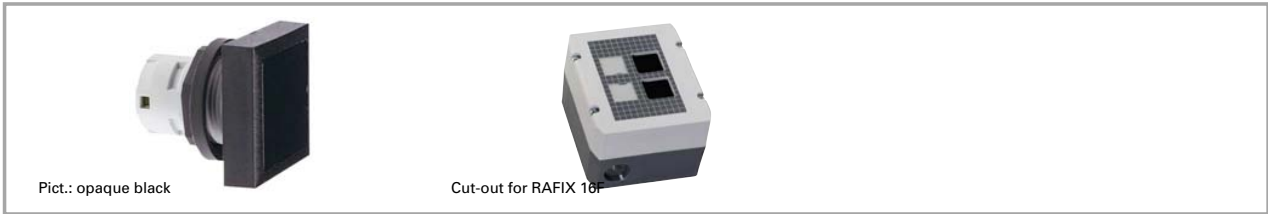

2

**RAFIX 16 F, blanking cap**

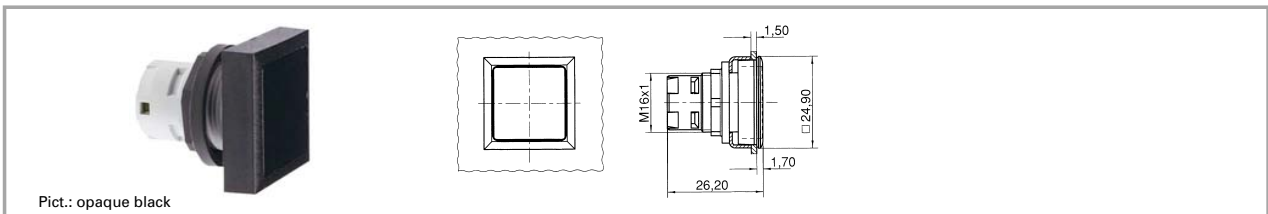

RAFIX 16 F

Short text	Feature 1	Feature 2	Order no.
RAFIX 16 F, blanking cap, black	opaque black	23.1 x 23.1 mm	5.05.800.063/0000

**RAFIX 16 F, insulating housing IP65**

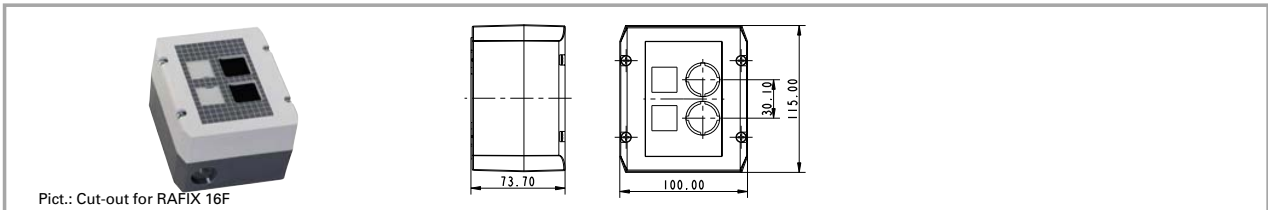

Short text	Feature 1	Feature 2	Order no.
RAFIX 16 F, insulating housing IP65, 1-module, light grey/dark grey	light grey/dark grey	55 mm	1.20.810.101/0000
RAFIX 16 F, insulating housing IP65, 1-module, yellow/yellow	yellow/yellow	55 mm	1.20.810.102/0000
RAFIX 16 F, insulating housing IP65, 2-module, light grey/dark grey	light grey/dark grey	115 mm	1.20.820.101/0000
RAFIX 16 F, insulating housing IP65, 3-module, light grey/dark grey	light grey/dark grey	115 mm	1.20.830.101/0000
RAFIX 16 F, insulating housing IP65, 4-module, light grey/dark grey	light grey/dark grey	145 mm	1.20.840.101/0000
Label sheet for insulating housing, 50 labels on a DIN A4 sheet	white		5.40.451.284/0000

- Formschönes Kunststoff-Gehäuse zur Aufnahme von bis zu 4 Befehlsgeräten
- 2 Kabeleinführungen vorbereitet: 1-,2-,3-tlg: M20x1,5, 4-tlg: M25x1,5
- Schutzart IP 65 nach DIN
- Alle grauen Gehäuse mit Frontfolie, Beschriftung durch Einschubstreifen möglich
- Wandbefestigung des Gehäusebodens mit 2 Schrauben, Bohrung vorbereitet
- Maße (Merkmal 2) x 100 mm x 74 mm
- Zubehör: 50 Folien-Einschubstreifen auf DIN A4-Bogen vorgestanz, mit PC-Drucker beschriftbar