

## L6 Series — Miniature Switches and Pilot Devices

Key features of the 5/8" L6 Series include:

- 5/8" (16mm) mounting holes
- Locking lever removable contact blocks
- Solder terminal or PCB terminal options
- Available assembled or as sub-components
- Worldwide approvals
- Incandescent or LED illumination
- Snap action contacts

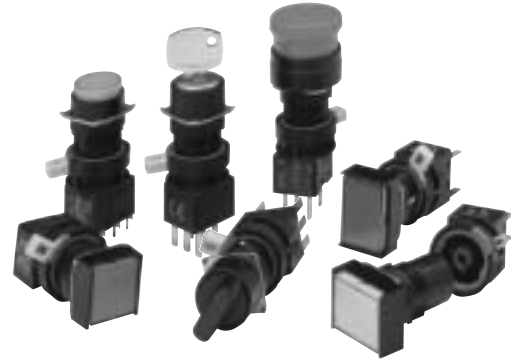

A2

Switches & Pilot Devices



UL Recognized  
File No. E55996



CSA Certified  
File No. LR21451











Registration No. R9551089 (E-stops)  
Registration No. J9551458 (all other switches)  
Registration No. J9650511 (Pilot Lights)

Contact Ratings	<b>Conforming to Standards</b>	EN60947-1, EN60947-5-1, VDE0660-200, UL508, CSA C22-2 NO.14					
	<b>Operating Temperature</b>	Operation: -25 to +55°C (without freezing), 45 to 85% rh Storage: -30 to +80°C (without freezing)					
	<b>Vibration Resistance</b>	5 to 55Hz, 1.0 peak-peak amplitude max					
	<b>Shock Resistance</b>	Operating limit: 100 m/sec <sup>2</sup> (approximately 10G) Damage limit: 1000 m/sec <sup>2</sup> (approximately 100G)					
	<b>Mechanical Life</b>	Momentary pushbuttons 2,000,000 operations minimum All others: 250,000 operations minimum					
	<b>Degree of Protection</b>	IP65 (conforming to IEC 60529)					
	<b>Dielectric Strength</b>	Switch unit: between live and ground: 2500 volt AC, 1 minute between terminals of different poles: 2500 volt AC, 1 minute between terminals of same pole: 1000 volt AC, 1 minute Illumination unit: between live part and ground: 2500 volt AC, 1 minute					
	<b>Insulation Resistance</b>	100 MΩ minimum (using 500V DC megger)					
	<b>Rated Insulation Voltage</b>	250 V AC/DC					
	<b>Rated Thermal Current</b>	Gold Contacts (pcb): 3A Silver Contacts (solder): 5A					
	<b>Contact Resistance</b>	50 Ω maximum initial value					
	<b>Rated Operating Current</b>		<b>Silver Contacts</b> (Solder Terminals)			<b>Gold Clad Contacts</b> (PCB terminals)	
			30V	125V	250V	30V	125V
	AC resistive	-	3A	2A	-	0.1A	
	AC inductive	-	2A	1.5A	0.1A	-	
	DC resistive	2A	0.4A	-	-	-	
	DC inductive	1A	0.2A	-	-	-	
<b>Minimum Recommended Load</b> (reference value for silver contacts)	5 VAC/DC, 1mA						
<b>Terminal Style</b>	0.110" Solder Tab /PCB						
<b>Contact Form</b>	Snap Action, Double Throw						
<b>Contact Material</b>	Solder Tab: Pure Silver /PCB thermal Gold Plated Silver						
<b>Electrical Life</b> (at full load)	Momentary pushbuttons: 100,000 operations minimum (1800 operations / hour) All others: 100,000 operations minimum (1200 operations / hour)						
Lamp Ratings	<b>Lamp Current Draw</b>	5V DC LED: 8mA		6V incandescent: 100 mA			
		6V LED: 7mA		12V incandescent: 50 mA			
		12V LED: 8mA		24V incandescent: 25 mA			
	<b>Lamp Life</b>	Incandescent: 2000 hours./LED: 50,000 hours. (on pure DC, half-life intensity)					
Buzzer Ratings	<b>Frequency</b>	2 khz ± 500 HZ					
	<b>Amplitude</b>	80db @ 0.1m (at rated voltage)					
	<b>Operating Voltage</b>	6V AC/DC or 12 - 24V AC/DC ± 10%					
	<b>Adjustable Cycle</b>	55 to 600 cycles per minute					
	<b>Current Draw</b>	DC: 7mA AC: 20mA					
	<b>Life</b>	1000 hrs. minimum					
	<b>Insulation Voltage</b>	60V AC/DC					
<b>Operating Temperature</b>	-20 to 55 C (no freezing), 45 to 85% rh						

## Non-Illuminated Pushbuttons (Assembled)

### Part Numbers: Non-Illuminated Pushbuttons

Style	Operation	Contact	Terminal Style	
			Solder Tab	PCB
Round 	Momentary	SPDT DPDT	LA1B-M1C5-① LA1B-M1C6-①	LA1B-M1C1V-① LA1B-M1C2V-①
	Maintained	SPDT DPDT	LA1B-A1C5-① LA1B-A1C6-①	LA1B-A1C1V-① LA1B-A1C2V-①
Square 	Momentary	SPDT DPDT	LA2B-M1C5-① LA2B-M1C6-①	LA2B-M1C1V-① LA2B-M1C2V-①
	Maintained	SPDT DPDT	LA2B-A1C5-① LA2B-A1C6-①	LA2B-A1C1V-① LA2B-A1C2V-①
Rectangular 	Momentary	SPDT DPDT	LA3B-M1C5-① LA3B-M1C6-①	LA3B-M1C1V-① LA3B-M1C2V-①
	Maintained	SPDT DPDT	LA3B-A1C5-① LA3B-A1C6-①	LA3B-A1C1V-① LA3B-A1C2V-①
Oversize Round Flush 	Momentary	SPDT DPDT	HA1B-M1C5-① HA1B-M1C6-①	HA1B-M1C1V-① HA1B-M1C2V-①
	Maintained	SPDT DPDT	HA1B-A1C5-① HA1B-A1C6-①	HA1B-A1C1V-① HA1B-A1C2V-①
Oversize Round Extended 	Momentary	SPDT DPDT	HA1B-M2C5-① HA1B-M2C6-①	HA1B-M2C1V-① HA1B-M2C2V-①
	Maintained	SPDT DPDT	HA1B-A2C5-① HA1B-A2C6-①	HA1B-A2C1V-① HA1B-A2C2V-①
Oversize Square Flush 	Momentary	SPDT DPDT	HA2B-M1C5-① HA2B-M1C6-①	HA2B-M1C1V-① HA2B-M1C2V-①
	Maintained	SPDT DPDT	HA2B-A1C5-① HA2B-A1C6-①	HA2B-A1C1V-① HA2B-A1C2V-①
Oversize Square Extended 	Momentary	SPDT DPDT	HA2B-M2C5-① HA2B-M2C6-①	HA2B-M2C1V-① HA2B-M2C2V-①
	Maintained	SPDT DPDT	HA2B-A2C5-① HA2B-A2C6-①	HA2B-A2C1V-① HA2B-A2C2V-①
Mushroom 	Momentary	SPDT DPDT	HA1B-M3C5-① HA1B-M3C6-①	HA1B-M3C1V-① HA1B-M3C2V-①
	Maintained	SPDT DPDT	HA1B-A3C5-① HA1B-A3C6-①	HA1B-A3C1V-① HA1B-A3C2V-①

### Button Color Codes

Color	Code
Black	B
Green	G
Red	R
Blue	S
White	W
Yellow	Y

A2

Switches & Pilot Devices



- In place of ① specify Button Color Code from table on right.
- Illuminated (translucent) style lenses also available, specify as such: instead of LA1B-M1C5-① use LA1B-M1C5L-② in place of ② specify Lens Color Code from next page.)
- PCB terminal models also available with silver contacts (change "1" or "2" to "5" or "6" respectively, ie LA1B-M1C1V-① becomes LA1B-M1C5V-①).

## Non-Illuminated Pushbuttons (Sub-Assembled)

**Contact + Safety Lever Lock + Operator + Button = Complete Part**



A2

Switches & Pilot Devices

### Part Numbers: Operators

Style	Momentary	Maintained
Round 	LA1L-M0	LA1L-A0
Square 	LA2L-M0	LA2L-A0
Rectangular 	LA3L-M0	LA3L-A0
Oversize Round 	HA1B-M0	HA1B-A0
Oversize Square 	HA2B-M0	HA2B-A0
Mushroom 	HA1B-M0L	HA1B-A0L

### Part Numbers: Buttons/Lenses

Style	Button	Lens
Round 	AB6M-BK2-①	AL6M-LK2-②
Square 	AB6Q-BK2-①	AL6Q-LK2-②
Rectangular 	AB6H-BK2-①	AL6H-LK2-②
Oversize Round Flush 	HA1A-B1-①	HA1A-L1-②*
Oversize Round Extended 	HA1A-B2-①	-
Oversize Square Flush 	HA2A-B1-①	HA2A-L1-②**
Oversize Square Extended 	HA2A-B2-①	-
Mushroom 	HA1A-B3-①	HA1A-L3-②

### Part Numbers: Contacts

Appearance	Contacts	Terminal Style	
		Solder Tab	PCB
	Gold	SPDT DPDT	HA-C1 HA-C2 HA-C1V HA-C2V
	Silver	SPDT DPDT	HA-C5 HA-C6 HA-C5V HA-C6V

### Part Number: Safety Lever Lock

Appearance	Part Number
	HA9Z-LS

### ① Button Color Code

Color	Code
Black	B
Green	G
Red	R
Blue	S
White	W
Yellow	Y

### ② Lens Color Code

Color	Code
Amber	A
Green	G
Red	R
Blue	S
Yellow	Y
White	W



- In place of ① specify Button Color Code from table on right.
- In place of ② specify Lens Color Code from table on right.
- \*requires HA1L-M0 or HA1L-A0 operator instead of HA1B-M0 or HA1B-A0.
- \*\*requires HA2L-M0 or HA2L-A0 instead of HA2B-M0 or HA2B-A0.

## HA1B/HA1E E-Stop

### Miniature Switches and Pilot Devices: 5/8" (16mm)

Key features of HA1B/HA1E Push lock Turn Reset include:

- PCB or Solder Terminals
- Quick Release Contact Blocks
- Positive Action Contacts
- 1 or 2 form B (SPST-NC) Contacts
- IP65 Protection
- 16mm Mounting Hole
- Tamper Proof Construction



A2

Switches & Pilot Devices

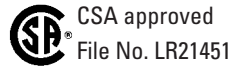
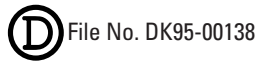

<b>Specifications</b>	<b>Contact Ratings</b>	24VDC/2A 120VAC/3A	
	<b>Contact Form</b>	1 or 2 form B (2-SPST-NC)	
	<b>Termination</b>	PCB or Solder Terminal	
	<b>Contact Material</b>	Silver	
	<b>Applicable Standards</b>	EN60947-5-1, UL-508, CSA 22.2. No. 14	
	<b>Rated Insulation Voltage</b>	250V	
	<b>Degree of Protection</b>	IP65, when mounted in an enclosure	
	<b>Conditional Short-Circuit Current &amp; Short-Circuit Protective Device</b>	50 A (at 250V) 10A 250V Fuse, operation class aM according to IEC269-1 and IEC269-2	
	<b>Positive Opening Operation</b>	Positive opening travel	3.4mm
		Minimum force required to achieve positive opening operation of all break contacts.	10.3 N (2 form B contacts)
Maximum travel including travel beyond the minimum travel position		5.5mm	
Maximum frequency of actuation		1,200 operations/hour	
<b>Pollution Degree</b>	3		

#### Part Numbers: Nameplates

HAAV-Yellow Plastic

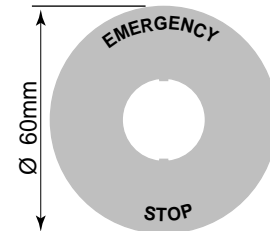

	Part Number
Blank	HAAV-0
Engraved Emergency Stop	HAAV-27

#### Part Numbers: Positive Action E-Stop

	Appearance	Operation	Contact	Terminal Style	
				Solder Tab	PCB
E-Stop		Pushlock/ Turn Reset	DPST(NC) (2 form B)	HA1B-V2E2R	HA1B-V2E2VR
			Short Body SPST-NC (1 form B) DPST-NC (2 form B)	HA1E-V2S1R HA1E-V2S2R	-

Button is non-removable, available in red and as complete assembled unit only.

#### Part Number: Buzzers (IP40)

	Appearance	Operating Voltage	Terminal Style	
			Solder/Tab	PCB
Buzzer-Rectangular		6V AC/DC ± 10%	LA3Z-1X2	LA3Z-1X2V
		12V to 24 AC/DC ± 10%	LA3Z-1X4	LA3Z-1X4V

Frequency: 2kHz ± 500 Hz  
Amplitude: 80db at 0.1m  
Beeping: Adjustable from steady tone to 600 beeps per minute.

**Pilot Lights (Assembled)**

**A2**  
**Switches & Pilot Devices**

**Part Numbers: Pilot Lights (LED)**

Style	Voltage	Terminal Style	
		Solder Tab	PCB
Round 	24V AC/DC LED 24VAC/DC Incandescent	LA1P-1C04-② LA1P-1C07-②	LA1P-1C04V-② LA1P-1C07V-②
Square 	24V AC/DC LED 24V AC/DC Incandescent	LA2P-1C04-② LA2P-1C07-②	LA2P-1C04V-② LA2P-1C07V-②
Rectangle 	24V AC/DC LED 24V AC/DC Incandescent	LA3P-1C04-② LA3P-1C07-②	LA3P-1C04V-② LA3P-1C07V-②
Oversize Round 	24V AC/DC LED 24V AC/DC Incandescent	HA1P-1C04-② HA1P-1C07-②	HA1P-1C04V-② HA1P-1C07V-②
Oversize Square 	24V AC/DC LED 24V AC/DC Incandescent	HA2P-1C04-② HA2P-1C07-②	HA2P-1C04V-② HA2P-1C07V-②
Oversize Round Unibody 	24V AC/DC LED 24V AC/DC Incandescent	HA1P-14-② HA1P-17-②	-
Oversize Square Unibody 	24V AC/DC LED 24V AC/DC Incandescent	HA2P-14-② HA2P-17-②	-

**② Lens/LED Color Codes**

Color	Code
Amber	A
Green	G
Red	R
Blue	S
Yellow	Y
White	W

**Voltage/Lamp Code**

Voltage	Code
5V DC LED	1
6V AC/DC LED	2
12V AC/DC LED	3
24V AC/DC LED	4
120 V AC LED	8
6V AC/DC Incandescent	5
12V AC/DC Incandescent	6
24V AC/DC Incandescent	7



- In place of ② specify Lens/LED Color Code from table.
- Lamps also available in 5VDC, 6V AC/DC, 12V AC/DC or 120V AC, change "4" or "7" using Voltage/Lamp Codes (ie LA1P-1C03-② uses 12V AC/DC LED).

## Pilot Lights (Sub-Assembled)

Terminals + Safety Lever Lock + Lamp Holder + Lamp + Operator + Lens = Completed Unit



A2

Switches & Pilot Devices

### Part Numbers: Operators

Style	Part Number
Round	LA1P-0
Square	LA2P-0
Rectangular	LA3P-0
Oversize Round	HA1P-0
Oversize Square	HA2P-0
Oversize Round Unibody	HA1P-00
Oversize Square Unibody	HA2P-00

### Part Numbers: Lenses

Style	Part Number
Round	AL6M-LK3-②
Square	AL6Q-LK3-②
Rectangular	AL6H-LK3-②
Oversize Round	HA1A-P1-②
Oversize Square	HA2A-P1-②

In place of ② specify lens color code.

### Part Numbers: Lamps

Style	Voltage	Part Number
LED	5V DC	LFTD-5②
	6V AC/DC	LFTD-6②
	12V AC/DC	LFTD-1②
	24V AC/DC	LFTD-2②
	120 V AC	LFTD-H2②
Incandescent	6V AC/DC	LH-06
	12V AC/DC	LH-14
	24V AC/DC	LH-28

In place of ② specify LED color code from table below.

### Part Numbers: Terminals

Appearance	Solder Tab	PCB
	HA-C00	HA-C00V

Not required for unibody models.

### Part Number: Lamp Holder

Appearance	Part Number
	HA9Z-AH

### Part Number: Safety Lever Lock







Appearance	Part Number
	HA9Z-LS

### ② Lens/LED Color Codes

Color	Code
Amber	A
Green	G
Red	R
Blue	S
Yellow	Y

## Illuminated Pushbuttons (Assembled)

### Part Numbers: Illuminated Pushbuttons

Style	Operation	Lamp Voltage	Contact	Terminal Style		
				Solder Tab	PCB	
 Round	Momentary	24V AC/DC LED	SPDT	LA1L-M1C54-②	LA1L-M1C14V-②	
		Incandescent	DPDT	LA1L-M1C64-②	LA1L-M1C24V-②	
	Maintained	24V AC/DC LED	SPDT	LA1L-A1C54-②	LA1L-A1C14V-②	
		Incandescent	DPDT	LA1L-A1C64-②	LA1L-A1C24V-②	
	 Square	Momentary	24V AC/DC LED	SPDT	LA2L-M1C54-②	LA2L-M1C14V-②
			Incandescent	DPDT	LA2L-M1C64-②	LA2L-M1C24V-②
Maintained		24V AC/DC LED	SPDT	LA2L-A1C54-②	LA2L-A1C14V-②	
		Incandescent	DPDT	LA2L-A1C64-②	LA2L-A1C24V-②	
 Rectangular		Momentary	24V AC/DC LED	SPDT	LA3L-M1C54-②	LA3L-M1C14V-②
			Incandescent	DPDT	LA3L-M1C64-②	LA3L-M1C24V-②
	Maintained	24V AC/DC LED	SPDT	LA3L-A1C54-②	LA3L-A1C14V-②	
		Incandescent	DPDT	LA3L-A1C64-②	LA3L-A1C24V-②	
	 Oversize Round	Momentary	24V AC/DC LED	SPDT	HA1L-M1C54-②	HA1L-M1C14V-②
			Incandescent	DPDT	HA1L-M1C64-②	HA1L-M1C24V-②
Maintained		24V AC/DC LED	SPDT	HA1L-A1C54-②	HA1L-A1C14V-②	
		Incandescent	DPDT	HA1L-A1C64-②	HA1L-A1C24V-②	
 Oversize Square		Momentary	24V AC/DC LED	SPDT	HA2L-M1C54-②	HA2L-M1C14V-②
			Incandescent	DPDT	HA2L-M1C64-②	HA2L-M1C24V-②
	Maintained	24V AC/DC LED	SPDT	HA2L-A1C54-②	HA2L-A1C14V-②	
		Incandescent	DPDT	HA2L-A1C64-②	HA2L-A1C24V-②	
	 Mushroom	Momentary	24V AC/DC LED	SPDT	HA1L-M3C54-②	HA1L-M3C14V-②
			Incandescent	DPDT	HA1L-M3C64-②	HA1L-M3C24V-②
Maintained		24V AC/DC LED	SPDT	HA1L-A3C54-②	HA1L-A3C14V-②	
		Incandescent	DPDT	HA1L-A3C64-②	HA1L-A3C24V-②	

### ② Lens Color Codes

Color	Code
Amber	A
Green	G
Red	R
Blue	S
Yellow	Y
White	W

### Voltage/Lamp Code

Voltage	Code
5V DC LED	1
6V AC/DC LED	2
12V AC/DC LED	3
24V AC/DC LED	4
120V AC LED	8
6V AC/DC Incandescent	5
12V AC/DC Incandescent	6
24V AC/DC Incandescent	7

- In place of ② specify lens color code from table at right.
- Lamps also available in 5V DC, 6V AC/DC, 12 V AC/DC or 120V AC, change "4" or "7" using voltage/lamp codes (ie LA1P-1C03-② uses 12V AC/DC LED).
- PCB terminal models also available with silver contacts (change "1" or "2" to "5" or "6" respectively, ie LA1L-M1C14V-② becomes LA1L-M1C54V-①).

## Illuminated Pushbuttons (Sub-Assembled)

A2

Switches & Pilot Devices

**Contacts + Safety Lever Lock + Lamp Holder + Lamp + Operator + Lens = Completed Unit**



### Part Numbers: Operators

Style	Momentary	Maintained
Round 	LA1L-M0	LA1L-A0
Square 	LA2L-M0	LA2L-A0
Rectangular 	LA3L-M0	LA3L-A0
Oversize Round 	HA1L-M0	HA1L-A0
Oversize Square 	HA2L-M0	HA2L-A0
Mushroom 	HA1B-M0L	HA1B-A0L



### Part Numbers: Lenses

Style	Part Number
Round 	AL6M-LK2-②
Square 	AL6Q-LK2-②
Rectangular 	AL6H-LK2-②
Oversize Round 	HA1A-L1-②
Oversize Square 	HA2A-L1-②
Mushroom 	HA1A-L3-②



*In place of ② specify Lens Color Code from table.*



### Part Numbers: Lamps

Appearance	Voltage	Part Number
LED 	5V DC 6V AC/DC 12V AC/DC 24V AC/DC 120V AC	LFTD-5② LFTD-6② LFTD-1② LFTD-2② LFTD-H2②
Incandescent 	6V AC/DC 12V AC/DC 24V AC/DC	LH-06 LH-14 LH-28



*In place of ② specify LED color code from table below.*

### Part Numbers: Contacts

Appearance	Contacts	Terminal Style	
		Solder Tab	PCB
	Gold SPDT DPDT	HA-C10 HA-C20	HA-C10V HA-C20V
	Silver SPDT DPDT	HA-C50 HA-C60	HA-C50V HA-C60V

### Part Number: Lamp Holder

Appearance	Part Number
	HA9Z-AH

### Part Number: Safety Lever Lock

Appearance	Part Number
	HA9Z-LS

### ② Lens/LED Color Codes

Color	Code
Amber	A
Green	G
Red	R
Blue	S
Yellow	Y
White	W



## Selector Switches (Assembled)

### Part Numbers: Selector Switches

A2

Switches & Pilot Devices

Style	Position	Position Diagram	Contact	Terminal Style	
				Solder Tab	PCB
Round 	90° 2-Position	Maintained		DPDT	LA1S-2C6 / LA1S-2C2V
		Spring return from right		DPDT	LA1S-21C6 / LA1S-21C2V
	45° 3-Position	Maintained		DPDT	LA1S-3C6 / LA1S-3C2V
		Spring return from right		DPDT	LA1S-31C6 / LA1S-31C2V
		Spring return from left		DPDT	LA1S-32C6 / LA1S-32C2V
		2-Way spring return		DPDT	LA1S-33C6 / LA1S-33C2V
Square 	90° 2-Position	Maintained		DPDT	LA2S-2C6 / LA2S-2C2V
		Spring return from right		DPDT	LA2S-21C6 / LA2S-21C2V
	45° 3-Position	Maintained		DPDT	LA2S-3C6 / LA2S-3C2V
		Spring return from right		DPDT	LA2S-31C6 / LA2S-31C2V
		Spring return from left		DPDT	LA2S-32C6 / LA2S-32C2V
		2-Way spring Return		DPDT	LA2S-33C6 / LA2S-33C2V
Rectangular 	90° 2-Position	Maintained		DPDT	LA3S-2C6 / LA3S-2C2V
		Spring return from right		DPDT	LA3S-21C6 / LA3S-21C2V
	45° 3-Position	Maintained		DPDT	LA3S-3C6 / LA3S-3C2V
		Spring return from right		DPDT	LA3S-31C6 / LA3S-31C2V
		Spring return from left		DPDT	LA3S-32C6 / LA3S-32C2V
		2-Way spring Return		DPDT	LA3S-33C6 / LA3S-33C2V
Oversize Round 	90° 2-Position	Maintained		DPDT	HA1S-2C6 / HA1S-2C2V
		Spring return from right		DPDT	HA1S-21C6 / HA1S-21C2V
	45° 3-Position	Maintained		DPDT	HA1S-3C6 / HA1S-3C2V
		Spring return from right		DPDT	HA1S-31C6 / HA1S-31C2V
		Spring return from left		DPDT	HA1S-32C6 / HA1S-32C2V
		2-Way spring Return		DPDT	HA1S-33C6 / HA1S-33C2V

### Contact Operations (for all selectors)

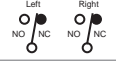
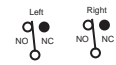
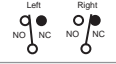
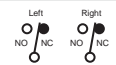
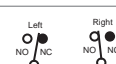
Contacts	Operator Position and Contact Operation	
2-pos. (DPDT)	Left	
	Right	
3-pos. (DPDT)	Left	
	Center	
	Right	



*As viewed from front of switch.*



1. All assembled selector switches use DPDT contacts.
2. For SPDT contacts see sub-components on next page.
3. PCB terminal models also available with silver contacts (change "1" or "2" to "5" or "6" respectively, ie LA1S-21C2V becomes LA1S-21C6V).

## Selector Switches (Sub-Assembled)

**Contacts + Safety Lever Lock + Operator = Complete Part**





**A2**

*Switches & Pilot Devices*

### Part Numbers: Operators

Style	Position	Function	Part Number
 Round	2	Maintained Spring from right	LA1S-2Y LA1S-21Y
	3	Maintained Spring from right Spring from left Spring from both	LA1S-3Y LA1S-31Y LA1S-32Y LA1S-33Y
 Square	2	Maintained Spring from right	LA2S-2Y LA2S-21Y
	3	Maintained Spring from right Spring from left Spring from both	LA2S-3Y LA2S-31Y LA2S-32Y LA2S-33Y
 Rectangular	2	Maintained Spring from right	LA3S-2Y LA3S-21Y
	3	Maintained Spring from right Spring from left Spring from both	LA3S-3Y LA3S-31Y LA3S-32Y LA3S-33Y
 Oversize Round	2	Maintained Spring from right	HA1S-2Y HA1S-21Y
	3	Maintained Spring from right Spring from left Spring from both	HA1S-3Y HA1S-31Y HA1S-32Y HA1S-33Y

### Part Numbers: Contacts

Appearance		Contacts	Terminal Style	
			Solder Tab	PCB
 Gold	 Silver	SPDT DPDT	HA-C1 HA-C2	HA-C1V HA-C2V
		SPDT DPDT	HA-C5 HA-C6	HA-C5V HA-C6V



1. All assembled switches listed on previous page use DPDT contacts.
2. SPDT Contacts for use on 2 position selector switch only

### Part Number: Safety Lever Lock

Appearance	Part Number
	HA9Z-LS

## Key Switches (Assembled)

### Part Numbers: Key Switches

Style		Operation	Contacts	Terminal Type		
				Solder Tab	PCB	
Round	90° 2-Position	Maintained		DPDT	LA1K-2C6③	LA1K-2C2V③
		Spring return from right		DPDT	LA1K-21C6B	LA1K-21C2VB
	45° 3-Position	Maintained		DPDT	LA1K-3C6③	LA1K-3C2V③
		Spring return from right		DPDT	LA1K-31C6③	LA1K-31C2V③
		Spring return from left		DPDT	LA1K-32C6③	LA1K-32C2V③
		2-Way spring return		DPDT	LA1K-33C6D	LA1K-33C2VD
Square	90° 2-Position	Maintained		DPDT	LA2K-2C6③	LA2K-2C2V③
		Spring return from right		DPDT	LA2K-21C6B	LA2K-21C2VB
	45° 3-Position	Maintained		DPDT	LA2K-3C6③	LA2K-3C2V③
		Spring return from right		DPDT	LA2K-31C6③	LA2K-31C2V③
		Spring return from left		DPDT	LA2K-32C6③	LA2K-32C2V③
		2-Way spring return		DPDT	LA2K-33C6D	LA2K-33C2VD
Rectangular	90° 2-Position	Maintained		DPDT	LA3K-2C6③	LA3K-2C2V③
		Spring return from right		DPDT	LA3K-21C6B	LA3K-21C2VB
	45° 3-Position	Maintained		DPDT	LA3K-3C6③	LA3K-3C2V③
		Spring return from right		DPDT	LA3K-31C6③	LA3K-31C2V③
		Spring return from left		DPDT	LA3K-32C6③	LA3K-32C2V③
		2-Way spring return		DPDT	LA3K-33C6D	LA3K-33C2VD
Oversize Round	90° 2-Position	Maintained		DPDT	HA1K-2C6③	HA1K-2C2V③
		Spring return from right		DPDT	HA1K-21C6B	HA1K-21C2VB
	45° 3-Position	Maintained		DPDT	HA1K-3C6③	HA1K-3C2V③
		Spring return from right		DPDT	HA1K-31C6③	HA1K-31C2V③
		Spring return from left		DPDT	HA1K-32C6③	HA1K-32C2V③
		2-Way spring return		DPDT	HA1K-33C6D	HA1K-33C2VD

### Contact Operations (for all selectors)

Contacts	Operator Position and Contact Operation	
2-pos. (DPDT)	Left	
	Right	
3-pos. (DPDT)	Left	
	Center	
	Right	



As viewed from front of switch.

### ③ Key Retention Option Codes

Code	Description
A	Key not retained in any position (removable in all positions)
B	Key retained in right position only
C	Key retained in left position only
D	Key retained in left and right (3 position only)
E	Key retained in center only (3 position only)
G	Key retained right and center (3 position only)
H	Key retained left and center (3 position only)



Key cannot be removed from a spring-return position.



- In place of ③ specify Key Retention Code from next page.
- All assembled key switches have DPDT contacts. For SPDT see sub-assembled on next page.
- PCB terminal models also available with silver contacts (change "1" or "2" to "5" or "6" respectively, ie LA1K-2C2V③ becomes LA1K-2C6V③).





## Key Switches (Sub-Assembled)



A2

Switches & Pilot Devices

### Part Numbers: Operators

Style	Positions	Operation	Part Number
 Round	2	Maintained Spring from right	LA1K-2 <sup>③</sup> LA1K-21B
	3	Maintained Spring from right Spring from left Spring from both	LA1K-3 <sup>③</sup> LA1K-31 <sup>③</sup> LA1K-32 <sup>③</sup> LA1K-33D
 Square	2	Maintained Spring from right	LA2K-2 <sup>③</sup> LA2K-21B
	3	Maintained Spring from right Spring from left Spring from both	LA2K-3 <sup>③</sup> LA2K-31 <sup>③</sup> LA2K-32 <sup>③</sup> LA2K-33D
 Rectangular	2	Maintained Spring from right	LA3K-2 <sup>③</sup> LA3K-21B
	3	Maintained Spring from right Spring from left Spring from both	LA3K-3 <sup>③</sup> LA3K-31 <sup>③</sup> LA3K-32 <sup>③</sup> LA3K-33D
 Oversize Round	2	Maintained Spring from right	HA1K-2 <sup>③</sup> HA1K-21B
	3	Maintained Spring from right Spring from left Spring from both	HA1K-3 <sup>③</sup> HA1K-31 <sup>③</sup> HA1K-32 <sup>③</sup> HA1K-33D



1. In place of ③ specify key removable code from table on right.

2. Operator includes two keys.

### Part Numbers: Contacts

Appearance	Contacts	Terminal Style	
		Solder Tab	PCB
	Gold	SPDT DPDT	HA-C1 HA-C2 HA-C1V HA-C2V
	Silver	SPDT DPDT	HA-C5 HA-C6 HA-C5V HA-C6V



1. All assembled selectors listed on previous page use DPDT contacts.
2. SPDT contacts are for use on 2 position key switches only.

### Part Number: Safety Lever Lock

Appearance	Part Number
	HA9Z-LS

### ③ Key Retention Option Codes





























Code	Description
A	Key not retained in any position (removable in all positions)
B	Key retained in right position only
C	Key retained in left position only
D	Key retained in left and right (3 position only)
E	Key retained in center only (3 position only)
G	Key retained right and center (3 position only)
H	Key retained left and center (3 position only)



Key cannot be removed from a spring-return position.

## Illuminated Selector Switches

### Part Numbers: Illuminated Selectors Switches

Style			Contact	Voltage	Terminal Style		
					Solder Tab	PCB	
Round 	90° 2-Position	Maintained		DPDT	24V LED 24V Incand.	LA1F-2C64-② LA1F-2C67-②	LA1F-2C24V-② LA1F-2C27V-②
		Spring return from right		DPDT	24V LED 24V Incand.	LA1F-21C64-② LA1F-21C67-②	LA1F-21C24V-② LA1F-21C27V-②
	45° 3-Position	Maintained		DPDT	24V LED 24V Incand.	LA1F-3C64-② LA1F-3C67-②	LA1F-3C24V-② LA1F-3C27V-②
		Spring return from right		DPDT	24V LED 24V Incand.	LA1F-31C64-② LA1F-31C67-②	LA1F-31C24V-② LA1F-31C27V-②
		Spring return from left		DPDT	24V LED 24V Incand.	LA1F-32C64-② LA1F-32C67-②	LA1F-32C24V-② LA1F-32C27V-②
		2-Way spring return		DPDT	24V LED 24V Incand.	LA1F-33C64-② LA1F-33C67-②	LA1F-33C24V-② LA1F-33C27V-②
Square 	90° 2-Position	Maintained		DPDT	24V LED 24V Incand.	LA2F-2C64-② LA2F-2C67-②	LA2F-2C24V-② LA2F-2C27V-②
		Spring return from right		DPDT	24V LED 24V Incand.	LA2F-21C64-② LA2F-21C67-②	LA2F-21C24V-② LA2F-21C27V-②
	45° 3-Position	Maintained		DPDT	24V LED 24V Incand.	LA2F-3C64-② LA2F-3C67-②	LA2F-3C24V-② LA2F-3C27V-②
		Spring return from right		DPDT	24V LED 24V Incand.	LA2F-31C64-② LA2F-31C67-②	LA2F-31C24V-② LA2F-31C27V-②
		Spring return from left		DPDT	24V LED 24V Incand.	LA2F-32C64-② LA2F-32C67-②	LA2F-32C24V-② LA2F-32C27V-②
		2-Way spring return		DPDT	24V LED 24V Incand.	LA2F-33C64-② LA2F-33C67-②	LA2F-33C24V-② LA2F-33C27V-②
Rectangular 	90° 2-Position	Maintained		DPDT	24V LED 24V Incand.	LA3F-2C64-② LA3F-2C67-②	LA3F-2C24V-② LA3F-2C27V-②
		Spring return from right		DPDT	24V LED 24V Incand.	LA3F-21C64-② LA3F-21C67-②	LA3F-21C24V-② LA3F-21C27V-②
	45° 3-Position	Maintained		DPDT	24V LED 24V Incand.	LA3F-3C64-② LA3F-3C67-②	LA3F-3C24V-② LA3F-3C27V-②
		Spring return from right		DPDT	24V LED 24V Incand.	LA3F-31C64-② LA3F-31C67-②	LA3F-31C24V-② LA3F-31C27V-②
		Spring return from left		DPDT	24V LED 24V Incand.	LA3F-32C64-② LA3F-32C67-②	LA3F-32C24V-② LA3F-32C27V-②
		2-Way spring return		DPDT	24V LED 24V Incand.	LA3F-33C64-② LA3F-33C67-②	LA3F-33C24V-② LA3F-33C27V-②
Oversize Round 	90° 2-Position	Maintained		DPDT	24V LED 24V Incand.	HA1F-2C64-② HA1F-2C67-②	HA1F-2C24V-② HA1F-2C27V-②
		Spring return from right		DPDT	24V LED 24V Incand.	HA1F-21C64-② HA1F-21C67-②	HA1F-21C24V-② HA1F-21C27V-②
	45° 3-Position	Maintained		DPDT	24V LED 24V Incand.	HA1F-3C64-② HA1F-3C67-②	HA1F-3C24V-② HA1F-3C27V-②
		Spring return from right		DPDT	24V LED 24V Incand.	HA1F-31C64-② HA1F-31C67-②	HA1F-31C24V-② HA1F-31C27V-②
		Spring return from left		DPDT	24V LED 24V Incand.	HA1F-32C64-② HA1F-32C67-②	HA1F-32C24V-② HA1F-32C27V-②
		2-Way spring return		DPDT	24V LED 24V Incand.	HA1F-33C64-② HA1F-33C67-②	HA1F-33C24V-② HA1F-33C27V-②

### Contact Operations (for all selectors)

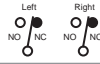
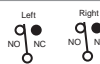
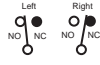
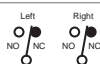
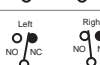
Contacts	Operator Position and Contact Operation	
2-pos. (DPDT)	Left	
	Right	
3-pos. (DPDT)	Left	
	Center	
	Right	



As viewed from front of switch.

### ② Lens/LED Color Code

Color	Code
Amber	A
Green	G
Red	R
Blue	S
Yellow	Y
White	W

### Voltage/Lamp Code

Voltage	Code
5V DC LED	1
6V AC/DC LED	2
12V AC/DC LED	3
24V AC/DC LED	4
120V AC LED	8
6V AC/DC Incandescent	5
12V AC/DC Incandescent	6
24V AC/DC Incandescent	7



- In place of ② specify Lens/LED Color Code from table above.
- Lamps also available in 5V DC, 6V AC/DC or 12 V AC/DC, change "4" or "7" using voltage/lamp codes (ie LA1F-2C63-② uses 12V AC/DC LED).
- All switches listed have DPDT contacts. For SPDT see sub-assembled on next page.
- PCB terminal models also available with silver contacts (change "1" or "2" to "5" or "6" respectively, ie LA1F-2C24V-② becomes LA1F-2C64V-②).

## Illuminated Selector Switches (Sub-Assembled)





Contacts + Safety lever lock + Lamp Holder + Lamp + Operator + Lens/Handle = Completed Unit

A2



Switches & Pilot Devices



### Part Numbers: Operators

Style	Positions	Function	Part Number
Round 	2	Maintained Spring from right	LA1F-20 LA1F-210
	3	Maintained Spring from right Spring from left Spring from both	LA1F-30 LA1F-310 LA1F-320 LA1F-330
	2	Maintained Spring from right	LA2F-20 LA2F-210
Square 	3	Maintained Spring from right Spring from left Spring from both	LA2F-30 LA2F-310 LA2F-320 LA2F-330
	2	Maintained Spring from right	LA3F-20 LA3F-210
	3	Maintained Spring from right Spring from left Spring from both	LA3F-30 LA3F-310 LA3F-320 LA3F-330
Rectangular 	2	Maintained Spring from right	HA1F-20 HA1F-210
	3	Maintained Spring from right Spring from left Spring from both	HA1F-30 HA1F-310 HA1F-320 HA1F-330
Oversize Round 	2	Maintained Spring from right	HA1F-20 HA1F-210
	3	Maintained Spring from right Spring from left Spring from both	HA1F-30 HA1F-310 HA1F-320 HA1F-330

### Part Numbers: Lenses/Handles



Appearance	Part Number
Standard 	LA1A-F-②
Oversize 	HA1A-F-②

 In place of ② specify Lens Color Code from table.

### Part Number: Safety Lever Lock

Appearance	Part Number
	HA9Z-LS

### Part Numbers: Contacts

Appearance	Terminal Style			
	Contacts	Solder Tab	PCB	
	Gold	SPDT	HA-C1	HA-C10V
		DPDT	HA-C2	HA-C20V
	Silver	SPDT	HA-C50	HA-C50V
		DPDT	HA-C60	HA-C60V

 1. All assembled selectors on previous pages use DPDT contacts. SPDT contacts are for use only on two position selectors.



### ② LED/Lens Color Code

Color	Code
Amber	A
Green	G
Red	R
Blue	S
Yellow	Y
White	W

### Part Number: Lamp Holder

Appearance	Part Number
	HA9Z-AH

### Part Numbers: Lamps

Appearance	Voltage	Part Numbers
LED 	5V DC 6V AC/DC 12V AC/DC 24V AC/DC 120V AC	LFTD-5② LFTD-6② LFTD-1② LFTD-2② LFTD-H2②
Incandescent 	6V AC/DC 12V AC/DC 24V AC/DC	LH-06 LH-14 LH-28

 In place of ② specify LED Color Code from table.

**Pushbutton Selectors (Assembled)**

**Part Numbers: Pushbutton Selectors**

Style	Terminal Style		
	Solder Tab	PCB	
	2 Position	HA1R-2C6-①	HA1R-2C2V-①
	3 Position	HA1R-3C6-①	HA1R-3C2V-①

① **Button Color Code**

Color	Code
Black	B
Green	G
Red	R
Blue	S
Yellow	Y



- In place of ① specify Button Color Code.
- PCB terminal models also available with silver contacts (change "1" or "2" to "5" or "6" respectively, ie HA1R-2C2V-① becomes HA1R-2C6V-①).

**Contact Operation**

Style	Operator Position					
	Left		Center		Right	
	Normal	Depressed	Normal	Depressed	Normal	Depressed
2 Position			—	—		
3 Position				Blocked		

**Lever Switch (Assembled)**

**Part Numbers: Lever Switches**

Style	Operation	Contacts	Terminal Type	
			Solder Tab	PCB
	Maintained		LA1T-2C6	LA1T-2C2V
	Spring return from top		LA1T-21C6	LA1T-21C2V
	Spring Return from bottom		LA1T-22C6	LA1T-22C2V
3-Position	Maintained		LA1T-3C6	LA1T-3C2V
	Spring return from top		LA1T-31C6	LA1T-31C2V
	Spring return from bottom		LA1T-32C6	LA1T-32C2V
	Spring return from both		LA1T-33C6	LA1T-33C2V



PCB terminal models also available with silver contacts (change "1" or "2" to "5" or "6" respectively, ie LA1T-2C2V becomes LA1T-2C6V).

**Contact Operation**

Contacts	Operator Position & Contact Operation	Operator Position & Contact Operation		
		Down	Center	Up
2-pos. (DPDT)	Maintained Spring from Top			
2-pos. (DPDT)	Spring Return from Bottom			
3-pos. (DPDT)	All models			







As viewed from front of switch.

## Accessories

A2

Switches & Pilot Devices

Part		Specifications	Part Number	Notes	
Ring Wrench		Made of metal	MT-001	Used for tightening the plastic locking ring when installing the L6 series unit on a panel. Tightening torque should not exceed 9kgf cm when tightening a locking ring.	
Lamp Holder Tool (Made of Rubber)		Made of rubber. Used for removing and replacing LED and incandescent lamps in illuminated units.	OR-44	Rubber tool used for replacing LED and incandescent lamps.	
Lens Removal Tool		For Illuminated pushbuttons and pilot lights.	MT-101	Used for removing the lens or button from the housing.	
LED Lamp		5V DC 6V AC/DC 12V AC/DC 24V AC/DC 120V AC	LFTD-5② LFTD-6② LFTD-1② LFTD-2② LFTD-H2②	T 1-3/4 miniature flange base. In place of ② specify LED Color Code (see page A2-43).	
Incandescent Lamp		6V AC/DC 12V AC/DC 24V AC/DC	LH-06 LH-14 LH-28	0.5W, T 1-3/4 miniature flange base	
Switch Guard		90 degrees opening maintained	Round/Square	AL-K6	Prevents inadvertent switch operation. IP40 dust-tight rated.
			Rectangular	AL-KH6	
		180 degrees opening, spring return	Round/Square	AL-K6SP	Prevents inadvertent switch operation. IP65 oiltight rated.
			Rectangular	AL-KH6SP	
Dust-proof Cover		For round units	AL-D6	Provides extra level of sealing for "front-panel" portion of switches. (Not applicable for units with oversize lenses or buttons).	
		For square units	AL-DQ6		
		For rectangular units	AL-DH6		
Terminal Cover		Made of white nylon	All removable contacts	H6-VL2	Covers terminals to prevent possible electric shock.
			Unibody Pilot Lights	H6-PVL	
Mounting Hole Plug		Rubber	AL-B6	Fills unused panel cutouts. Made of nitrile rubber. Push-in installation from front of panel. IP65 (oiltight) rated.	
		Aluminum	AL-BM6	Fills unused panel cutouts. Made of aluminum. Screw-on locking ring from inside of panel. IP65 (oiltight) rated.	
Replacement Keys		for LA1K (#132)	AS6-SK	Pair of keys.	
		for HA1K (#231)	KG9Z-SK		
Replacement Engraving Inserts		Round Square Rectangle Oversize Round Oversize Square Mushroom	AL6M-W AL6Q-W AL6H-W HA9Z-P1-W HA9Z-P2-W HA9Z-P13-W		
Replacement Locking Ring		All models	HA9Z-LN		
Replacement Anti-Rotation Ring		L6 standard	AL6-LP	Prevents rotation of switches in panel. (included with all assembled switches)	
		L6 oversize	HA9Z-LP		
Replacement Selector Inserts			HA9Z-HC1-①	Applicable to round oversize selectors only ① = (G, R, S, W, Y)	
Replacement Safety Lever Lock			HA9Z-LS		



## Dimensions

### Non-Illuminated Pushbuttons (LA\*B)

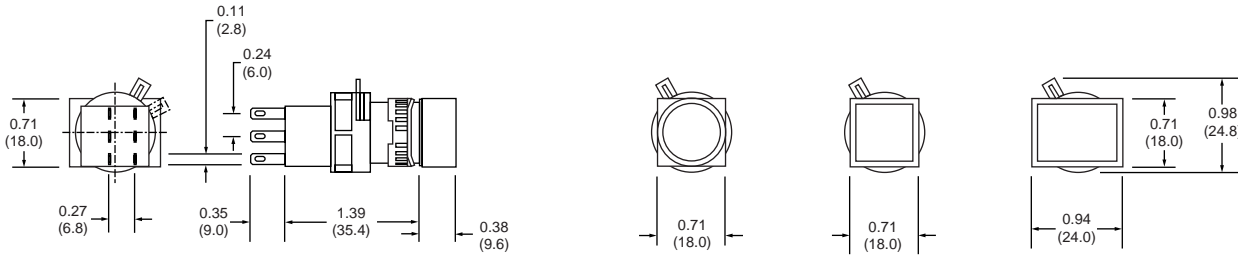

### Emergency Stop Switch (HA1B)

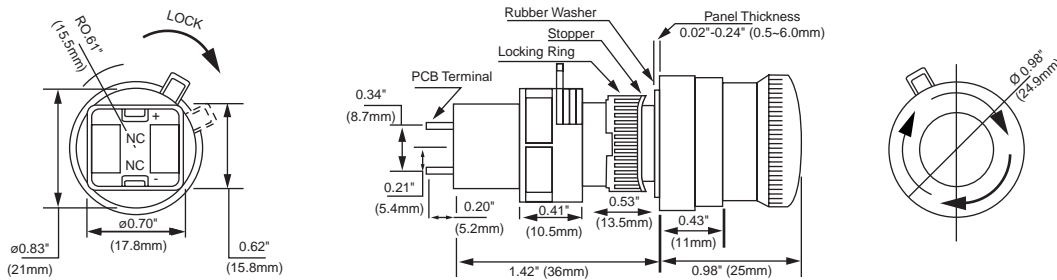

### Emergency Stop Switch (HA1E) - Short Body Style

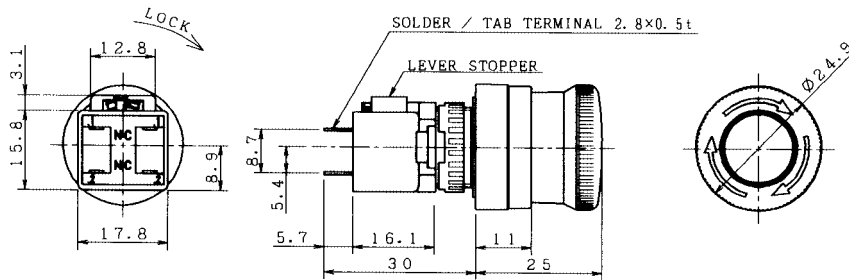

### Buzzer (LA3Z)

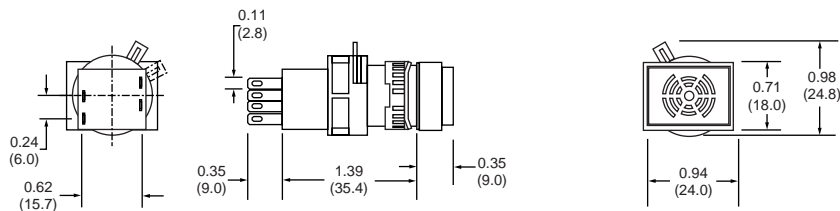

### Pilot Lights (LA\*P)

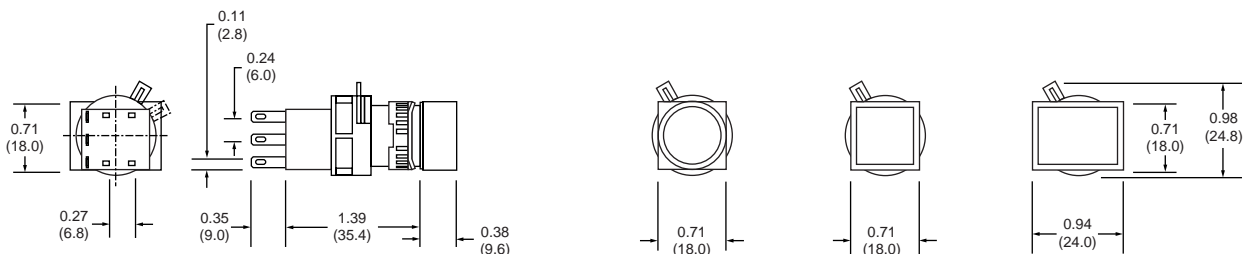

Switches & Pilot Devices

A2

## Dimensions con't

A2

Switches & Pilot Devices

### Illuminated Pushbuttons (LA\*L)

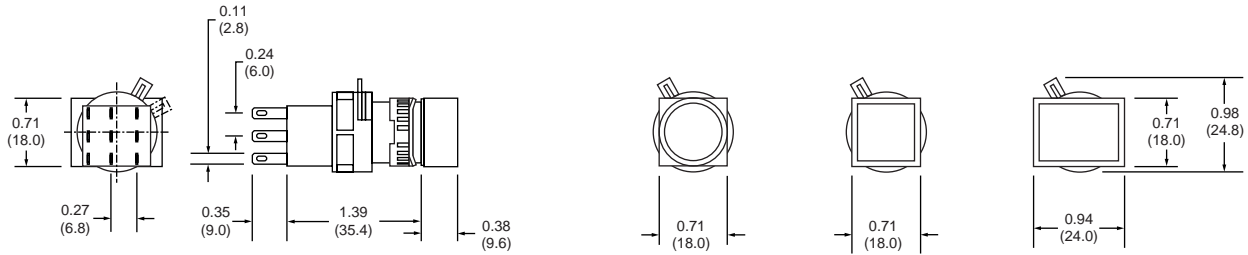

### Key Switches (LA\*K)

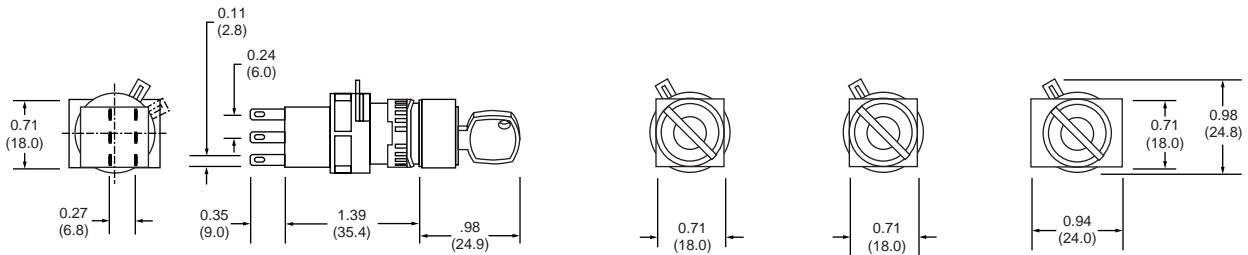

### Selector Switches (LA\*S)

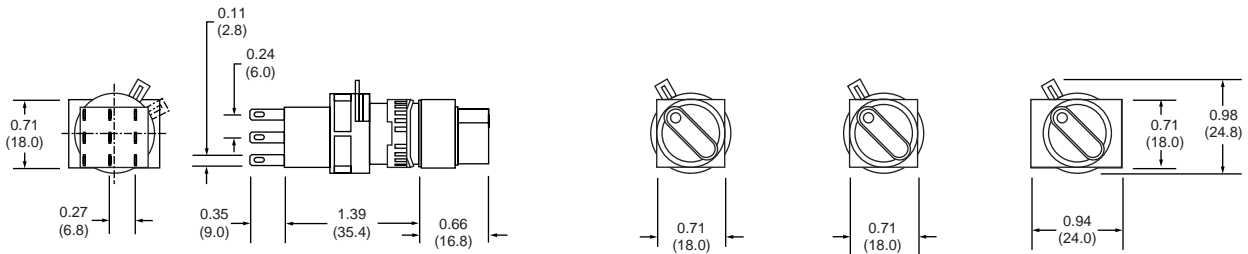

### Panel Cut-Out

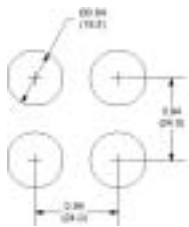

### PCB Layout (except for Buzzer and E-Stop)

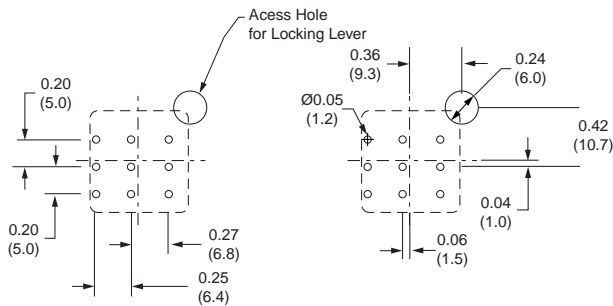

### PCB Pins

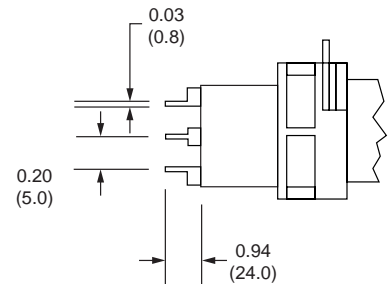

### HA1B E-Stop

#### PCB Mounting Pattern

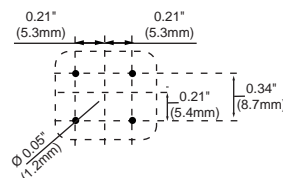

## Dimensions con't

### Oversize Flush Pushbutton and Pilot Lights

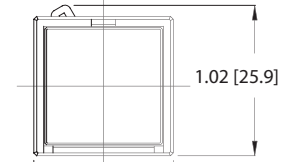
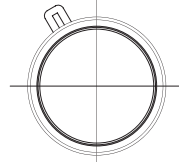
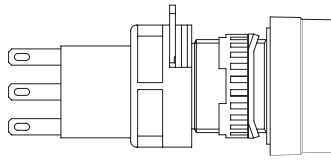
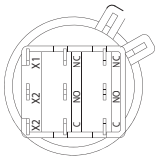

0.43 [11.0]

0.94 [24.0]

### Oversize Extended Non-Illuminated Pushbutton

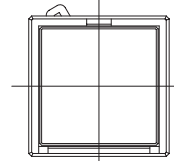
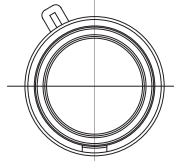
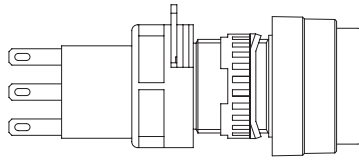
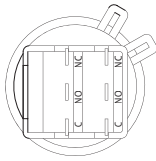

0.59 [15.1]

### Oversize Unibody Pilot Lights

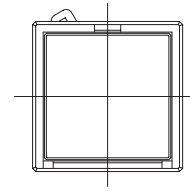
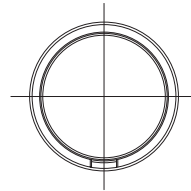
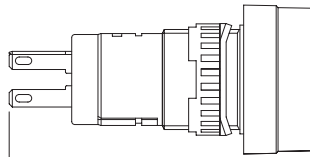
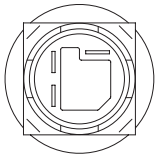

1.48 [37.5]

### Mushroom Pushbuttons

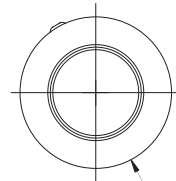
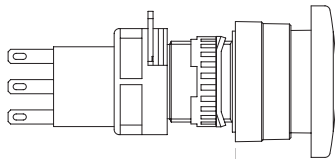
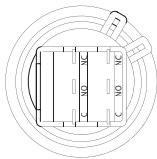

1.18 [30.0]

0.79 [20.0]

### Oversize Selector Switch

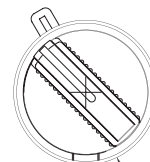
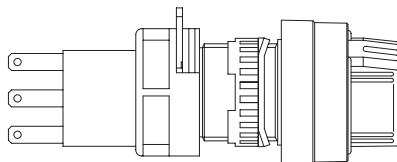
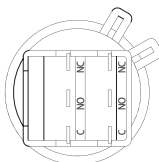

0.94 [23.8]

0.77 [19.5]

A2

Switches & Pilot Devices

## Dimensions con't

### Oversize Key Switch

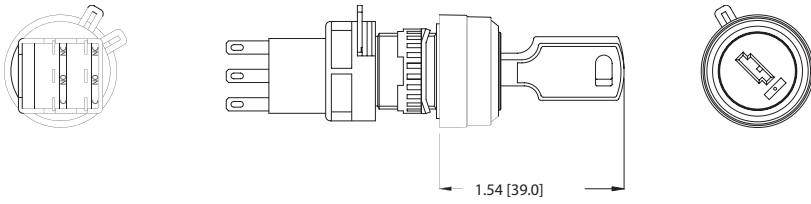

### Lever Switch

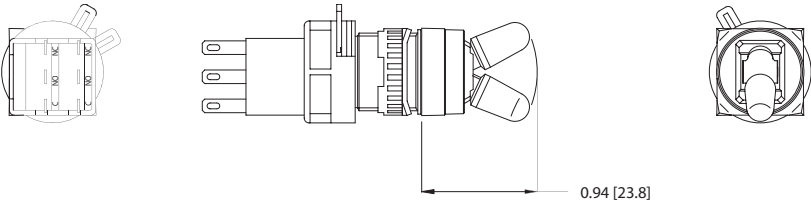

## Terminal Configurations

### Non Illuminated Pushbutton

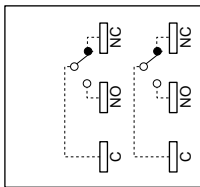

### Pilot Lights

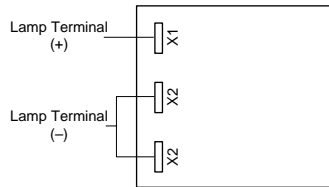

### Illuminated Pushbuttons

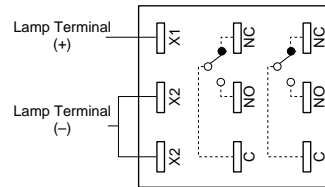

### Buzzer

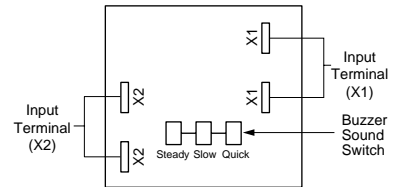

### AL-KH6SP

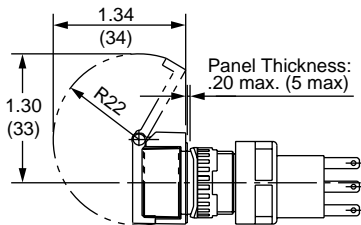
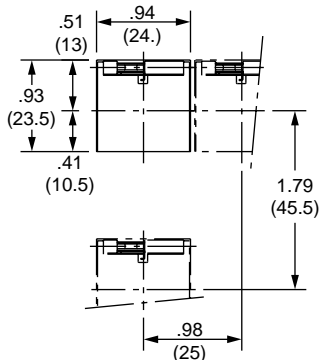

### AL-K6SP

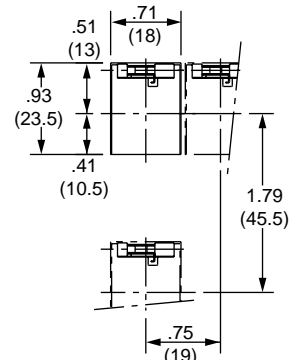

### AL-D6

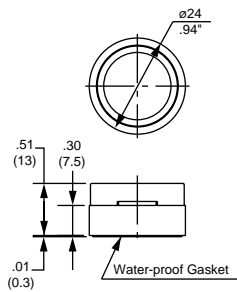

### AL-DQ6

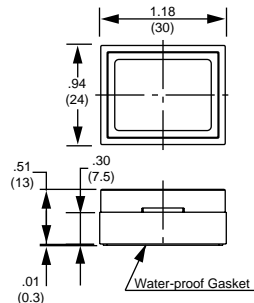

### AL-DH6

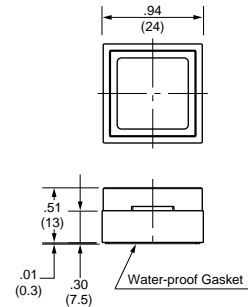

Dimensions con't

H6-VL2

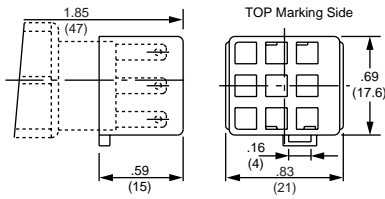

AL-B6

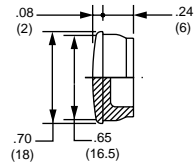

AL-BM6

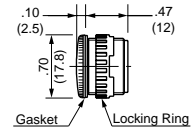

A2

Switches & Pilot Devices

LED Lamp

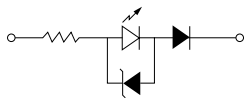

Internal Circuit

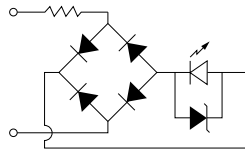
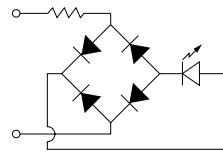

- LED Chip
- Protective Diode
- Zener Diode

## General Instructions

### Pushbutton Assembly

#### Lamp Installation

Lamps can be replaced in two ways:

1. If contacts are accessible (or pushbutton not installed in a panel) then it is easiest to first remove the contacts from the operator. This will allow easy access to the lamp/lamp-holder assembly. Grab lamp, depress slightly, and turn counter clockwise. Lamp can then be removed by pushing it back through the lamp holder.

2. If contacts are not accessible, then the lamp can be replaced by first removing the lens from the operator. Just pull lens straight out either with a fingernail or optional lens removal tool (MT-101). Lamp/lamp-holder assembly can then be removed with lamp removal tool (OR-44). Insert lamp removal tool through operator, depress slightly, turn counter clockwise, then pull lamp/lamp-holder assembly out. Lamp can then be removed by pushing it back through the lamp holder.



#### Engraving Lenses

All buttons and lenses can be engraved directly on the outside surface. Illuminated lenses also allow for engraving on a plate that is underneath the colored section of the lens. Remove the colored section of the lens by pulling on the edge while simultaneously unhooking it from the latches on the lens holder. The marking plate will then be accessible. It can then be engraved or a thin marked insert (such as mylar or paper) can be sandwiched between the marking plate and colored section of the lens.

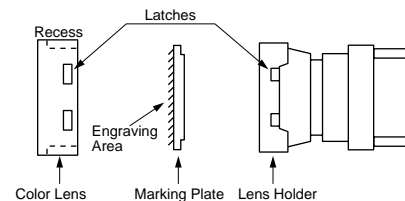

### Panel Mounting

Before any unit can be mounted into a panel, the contact block must be removed. Slide metal locking lever and pull contact off. Loosen and remove the locking ring and square anti-rotation ring from the operator and insert operator through panel cutout from the front of the panel. Slide on anti-rotation ring and tighten locking ring, using locking ring wrench (MT-001). Slide contact block onto operator, observing TOP marking on both parts. Slide metal locking lever in direction indicated by LOCK. The yellow plastic safety lever lock can then be snapped onto the locking lever; this will prevent vibration or maintenance actions from releasing the contact from the operator.

### PCB Mounting

Being able to separate the contacts from the operator allows for assembly of the front panel components (operator and lens) to be performed in tandem with the PC board assembly and soldering. For applications where multiple rows of pushbuttons are mounted closely together, or where other components may obstruct access to the contact locking lever, be sure to include access holes in the PC board (refer to PC board layout dimensions for location). Also be sure to allow for space above and to the side of contact to ensure that no components block the contact block locking lever. PC board pins are designed to rest on the PCB, take this into consideration to ensure that pins do not short closely spaced traces.

