

## Tactile Switch (SMD Type)

## B3FS

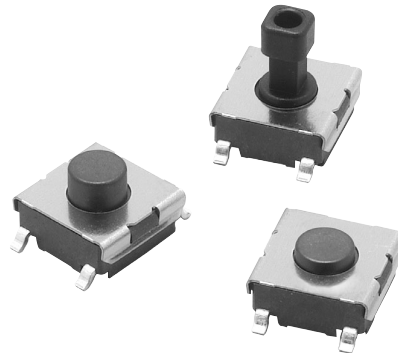

### Surface-mounting Switches Ideal for High-density Mounting

- Tape packing style also available.
- Allows reflow soldering.
- Incorporates a snap-action contact mechanism that ensures sharp switching operations.



## Ordering Information

### ■ List of Models

Type	Plunger type	Height	Operating force (OF)	Bag		Embossed tape		
				Model	Minimum order unit	Model	Minimum order unit	
6 x 6 mm B3FS-1000 models	 (Flat type)	3.1 mm	0.98 N {100 gf}	B3FS-1000	100	B3FS-1000P	3,000	
			1.47 N {150 gf}	B3FS-1002		B3FS-1002P		
	 (Flat type)	4.3 mm	0.98 N {100 gf}	B3FS-1010		B3FS-1010P		1,000
			1.47 N {150 gf}	B3FS-1012		B3FS-1012P		
	 (Projected type)	7.3 mm	0.98 N {100 gf}	B3FS-1050 (See note.)		B3FS-1050P (See note.)		
			1.47 N {150 gf}	B3FS-1052 (See note.)		B3FS-1052P (See note.)		

**Note:** Orders must be made in multiples of the minimum order unit. Switches are not sold individually.

## Specifications

### ■ Ratings/Characteristics

Switching capacity	50 mA, 24 VDC (resistive load)
Ambient temperature	Operating: -25°C to 70°C (with no icing)
Ambient humidity	Operating: 35% to 85%
Contact configuration	SPST-NO
Contact resistance	100 mΩ max. (initial value) (rated: 1 mA, 5 VDC)
Insulation resistance	100 MΩ min. (at 100 VDC)
Dielectric strength	250 VAC, 50/60 Hz for 1 min
Bounce time	5 ms max.
Vibration resistance	Malfunction: 10 to 55 Hz, 1.5-mm double amplitude
Shock resistance	Destruction: 1,000 m/s <sup>2</sup> {approx. 100G} max. Malfunction: 100 m/s <sup>2</sup> {approx. 10G} max.
Life expectancy	Standard models (0.98 N): 1,000,000 operations min. High-force models (1.47 N): 300,000 operations min.
Weight	B3F-1000: Approx. 0.2 g

## Engineering Data

### Operating Force vs. Stroke Characteristics

#### B3F-1000

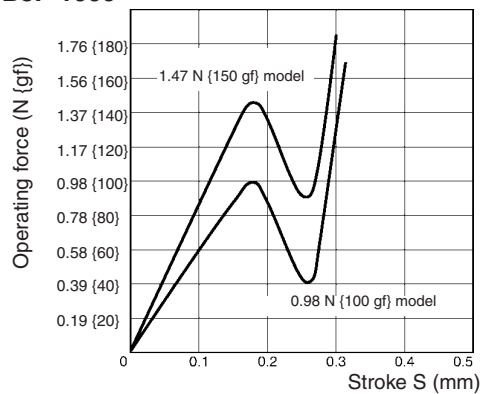

### ■ Operating Characteristics

Item	B3FS-1000	
	0.98 N	1.47 N
Operating force (OF)	0.98±0.29 N {100±30 gf}	1.47±0.49 N {150±50 gf}
Releasing force (RF)	0.2 N {20 gf} min.	0.49 N {50 gf} min.
Pretravel (PT)	0.25 <sup>+0.2</sup> / <sub>-0.1</sub> mm	

## Dimensions

**Note:** All units are in millimeters unless otherwise indicated. Unless otherwise specified, a tolerance of  $\pm 0.4$  mm applies to all dimensions.

### Flat Type

B3FS-1000  
B3FS-1002  
B3FS-1000P  
B3FS-1002P

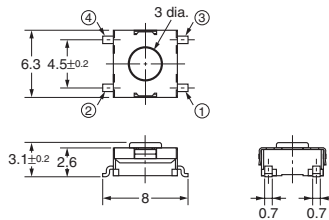

### PCB Pad (Top View) (One-side PCB t= 1.6)

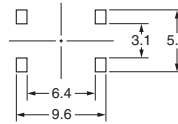

### Terminal Arrangement/ Internal Connection (Top View)

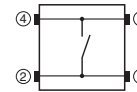

### Flat Type

B3FS-1010  
B3FS-1012  
B3FS-1010P  
B3FS-1012P

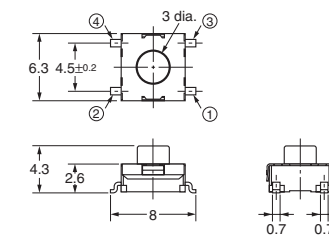

### PCB Pad (Top View) (One-side PCB t= 1.6)

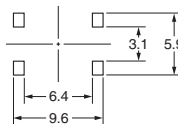

### Terminal Arrangement/ Internal Connection (Top View)

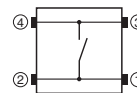

### Projected Type

B3FS-1050  
B3FS-1052  
B3FS-1050P  
B3FS-1052P

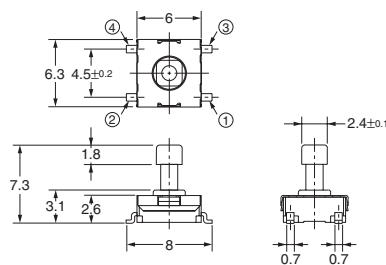

### PCB Pad (Top View) (One-side PCB t= 1.6)

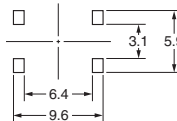

### Terminal Arrangement/ Internal Connection (Top View)

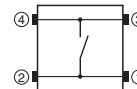

## Key Tops

B32-series Special Key Tops are available for projected plunger models. Refer to page 42 for details.

## Precautions

Be sure to read the precautions common to all Tactile Switches on pages 5 to 7 for correct use.

**ALL DIMENSIONS SHOWN ARE IN MILLIMETERS.**

To convert millimeters into inches, multiply by 0.03937. To convert grams into ounces, multiply by 0.03527.

## Tactile Switch Key Top

## B32

**Key Top Designed Specially for Projected-plunger-type B3F, B3FS, and B3W Switches**

■ Available in a wide range of colors and sizes.

RoHS Compliant (Refer to page 8 for details.)

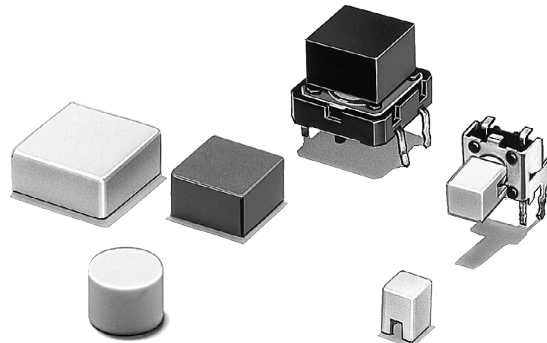

## Ordering Information

For B3F, B3FS, and B3W Switches

Color	6 × 6 mm Switches (B3F-1000, B3F-3000, B3F-6000, B3W-1000, B3FS)			12 × 12 mm Switches (B3F-4000, B3F-5000, B3W-4000)		
	4 × 4 mm Key Top	6 mm dia. Key Top	D-type Key Top	9 × 9 mm Key Top	12 × 12 mm Key Top	9.5-mm dia.
Light gray	B32-1000	B32-2000	B32-2100	B32-1200	B32-1300	B32-1600
Black	B32-1010	B32-2010	B32-2110	B32-1210	B32-1310	B32-1610
Orange	B32-1020	---	---	B32-1220	B32-1320	B32-1620
Yellow	B32-1030	---	---	B32-1230	B32-1330	B32-1630
Blue	B32-1040	---	---	B32-1240	B32-1340	---
White	B32-1060	---	---	B32-1260	B32-1360	---
Red	B32-1080	---	---	B32-1280	B32-1380	---

**Note:** The minimum order unit is 1,000 Switches per package. Orders must be made in multiples of the minimum order unit.

## Specifications

### ■ Characteristics

Ambient operating temperature	-25°C to 70°C at 60% max. humidity (with no icing or condensation)
Ambient operating humidity	35% to 85% (at 5 to 35°C)

# Dimensions

**Note:** All units are in millimeters unless otherwise indicated. Unless otherwise specified, a tolerance of  $\pm 0.4$  mm applies to all dimensions.

## B32-10□0

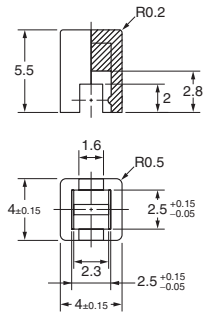

### Reference Dimensions

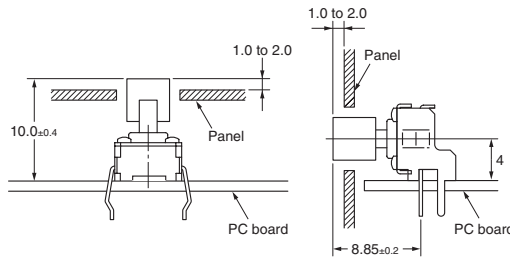

### Panel Cutout

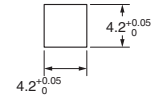

## B32-2000 B32-2100

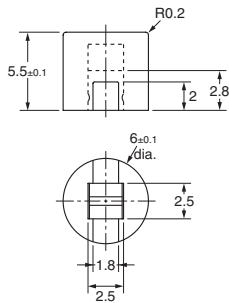

### Reference Dimensions

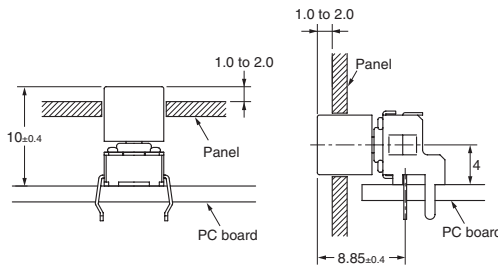

### Panel Cutout

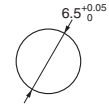

## B32-2100 B32-2110

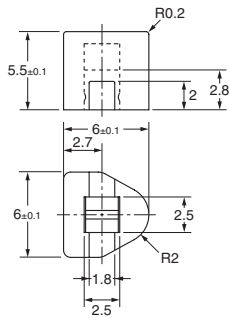

### Reference Dimensions

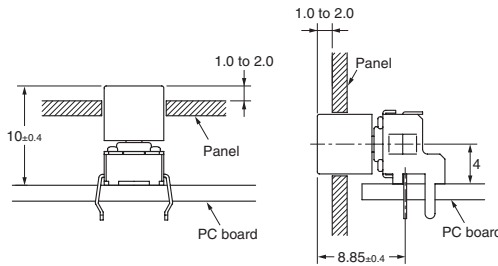

### Panel Cutout

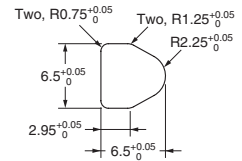

## B32-12□0

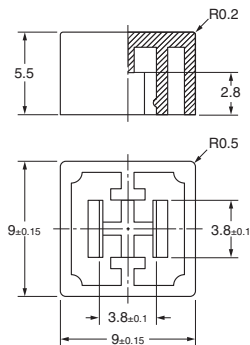

### Reference Dimensions

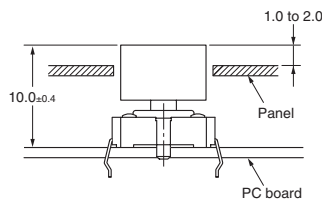

### Panel Cutout

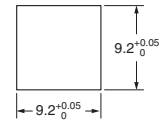

B32-13□0

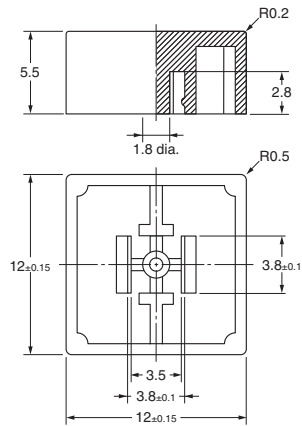
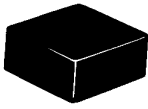

Reference Dimensions

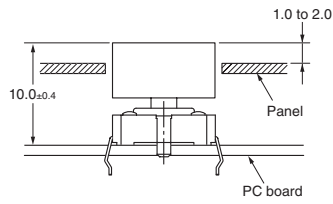

Panel Cutout

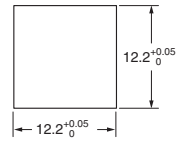

B32-16□0

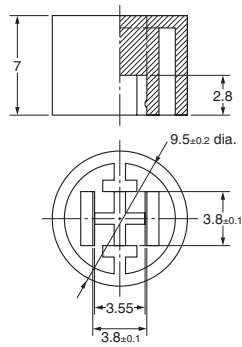

Reference Dimensions

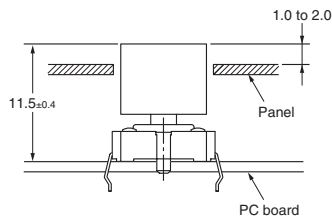

Panel Cutout

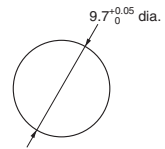

**ALL DIMENSIONS SHOWN ARE IN MILLIMETERS.**  
 To convert millimeters into inches, multiply by 0.03937. To convert grams into ounces, multiply by 0.03527.

## Safety Precautions

### ■ Precautions for Safe Use

Use the Switch within the rated voltage and current ranges, otherwise the Switch may have a shortened life expectancy, radiate heat, or burn out. This particularly applies to the instantaneous voltages and currents when switching.

### ■ Precautions for Correct Use

#### Storage

To prevent degradation, such as discoloration, in the terminals during storage, do not store the Switch in locations that are subject to the following conditions.

1. High temperature or humidity
2. Corrosive gases
3. Direct sunlight

#### Handling

##### 1. Operation

Do not repeatedly operate the Switch with excessive force. Applying excessive pressure or applying additional force after the plunger has stopped may deform the disc spring of the Switch, resulting in malfunction. In particular, applying excessive force to Side-operated Switches may damage the caulking, which in turn may damage the Switch. Do not apply force exceeding the maximum (29.4 N for 1 minute, one time) when installing or operating Side-operated Switches.

Be sure to set up the Switch so that the plunger will operate in a straight vertical line. A decrease in the life of the Switch may result if the plunger is pressed off-center or from an angle.

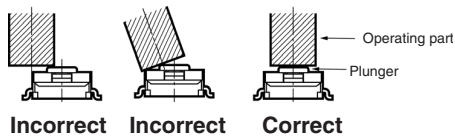

##### 2. Dust Protection

Do not use Switches that are not sealed in dust-prone environments. Doing so may cause dust to penetrate inside the Switch and cause faulty contact. If a Switch that is not sealed must be used in this kind of environment, use a sheet or other measure to protect it against dust.

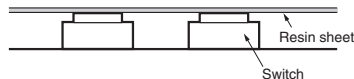

#### PCBs

The Switch is designed for a 1.6-mm thick, single-side PCB.

Using PCBs with a different thickness or using double-sided, through-hole PCBs may result in loose mounting, improper insertion, or poor heat resistance in soldering. These effects will occur, depending on the type of holes and patterns of the PCB. Therefore, it is recommended that a verification test is conducted before use.

If the PCBs are separated after mounting the Switch, particles from the PCBs may enter the Switch. If PCB particles or foreign particles from the surrounding environment, workbench, containers, or stacked PCBs become attached to the Switch, faulty contact may result.

#### Soldering

##### 1. General Precautions

Before soldering the Switch on a multilayer PCB, test to confirm that soldering can be performed properly. Otherwise the Switch may be deformed by the soldering heat on the pattern or lands of the multilayer PCB.

Do not solder the Switch more than twice, including rectification soldering. An interval of five minutes is required between the first and second soldering.

##### 2. Automatic Soldering Baths (B3F, B3W, B3WN, B3M, B3J)

Soldering temperature: 260°C max.

Soldering time: 5 s max. for a 1.6-mm thick single-side PCB

Preheating temperature: 100°C max. (ambient temperature)

Preheating time: Within 60 s

Make sure that no flux will rise above the level of the PCB. If flux overflows onto the mounting surface of the PCB, it may enter the Switch and cause a malfunction.

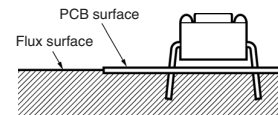

##### 3. Reflow Soldering (Surface Mounting)

Solder the terminals within the heating curve shown in the following diagram.

##### B3S, B3SN, B3FS

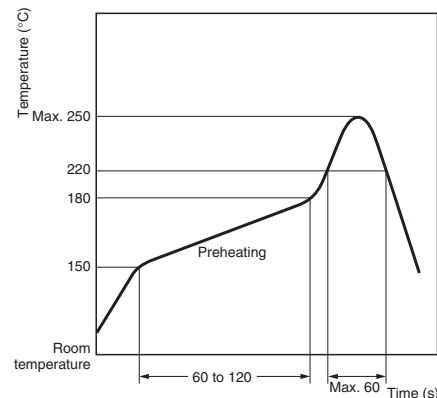

**Note:** The above heating curve applies if the PCB thickness is 1.6 mm.

The peak temperature may vary depending on the reflow bath used. Confirm the conditions beforehand.

Do not use an automatic soldering bath for surface-mounted Switches. The soldering gas or flux may enter the Switch and damage the Switch's push-button operation.

##### 4. Manual Soldering (All Models)

Soldering temperature: 350°C max. at the tip of the soldering iron  
Soldering time: 3 s max. for a 1.6-mm thick, single-side PCB

Before soldering the Switch on a PCB, make sure that there is no unnecessary space between the Switch and the PCB.

#### Washing

##### 1. Washable and Non-washable Models

<b>Washable (sealed types)</b>	B3W, B3WN, B3S, B3SN
<b>Non-washable (standard types)</b>	B3F, B3FS, B3M, B3J, B3DA, B3D

Standard Switches are not sealed, and cannot be washed. Doing so will cause the washing agent, together with flux or dust particles on the PCB, to enter the Switch, resulting in malfunction.

**2. Washing Methods**

Washing equipment incorporating more than one washing bath can be used to clean washable models, provided that the washable models are cleaned for one minute maximum per bath and the total cleaning time does not exceed three minutes.

**3. Washing Agents**

Apply alcohol-based solvents to clean washable models. Do not apply any other agents or water to clean any washable model, as such agents may degrade the materials or performance of the Switch.

**4. Washing Precautions**

Do not impose any external force on washable models while washing.

Do not clean washable models immediately after soldering. The cleaning agent may be absorbed into the Switch through respiration as the Switch cools. Wait for at least three minutes after soldering before cleaning washable models.

Do not use Sealed Switches while submersed in water or in locations exposed to water.

**Switch Packaging (Taping Specification Models)**

**1. Radial Types**

The tape is packaged by fan-folding into the box, as shown in the following diagram.

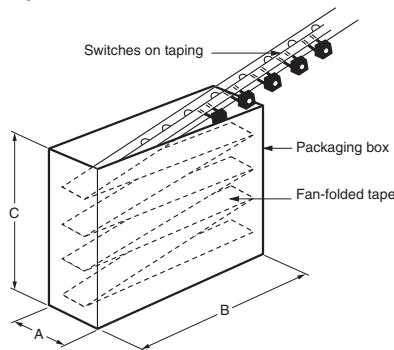

Model	A	B	C
B3F	50 mm	325 mm	275 mm
B3WN	53 mm	326 mm	350 mm

Do not apply any external force to the packaging box, or subject it to vibration. Doing so may deform the Switch terminals.

Remove the tape slowly, making sure that the Switches are not entangled or caught. Otherwise the terminals may be deformed.

Do not store the packaged Switches in locations subject to high temperatures or high humidity. The packaging boxes are sealed with paper tape and are not airtight. Storing the packaged Switches in locations with high temperature or high humidity may result in deterioration of the tape and Switches, and long-term storage under such conditions may cause discoloration of the Switch terminals.

**2. Packaging Specifications for Embossed Taping (B3FS-1000P/-1002P, B3SN)**

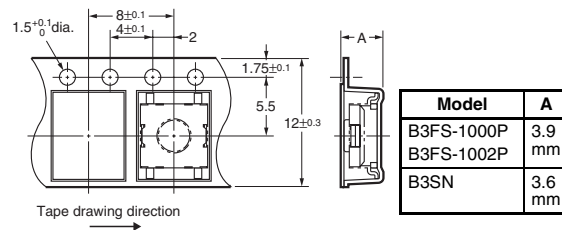
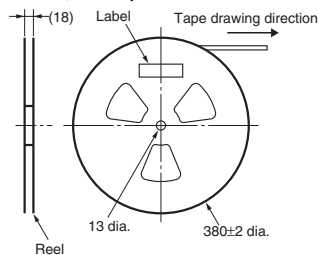

Model	A
B3FS-1000P	3.9 mm
B3FS-1002P	3.9 mm
B3SN	3.6 mm

<b>Standards</b>	Conforms to JEITA.
<b>Package</b>	3,000 Switches
<b>Heat resistance</b>	50°C for 24 hours (without deformation)

**Note:** Switches with ground terminals are packaged with the ground terminal on the opposite side of the guide hole.

**B3FS-1010P**

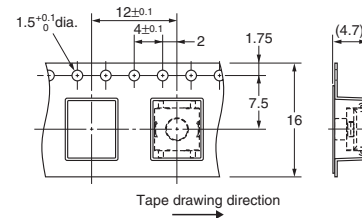
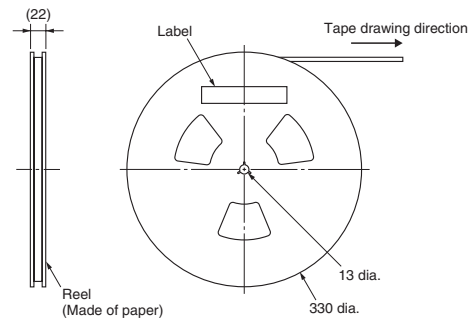

<b>Standards</b>	Conforms to JEITA.
<b>Package</b>	1,000 Switches
<b>Heat resistance</b>	60°C for 24 hours (without deformation)



**B3FS-1050P**

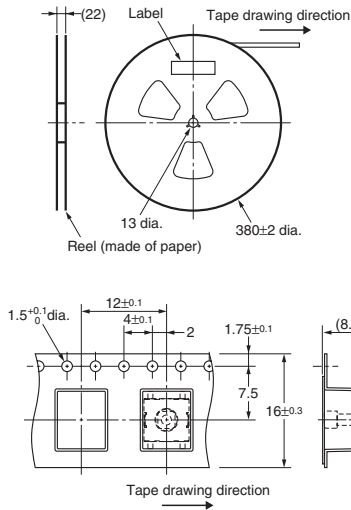

<b>Standards</b>	Conforms to JEITA.
<b>Package</b>	1,000 Switches
<b>Heat resistance</b>	60°C for 24 hours (without deformation)

**B3S**

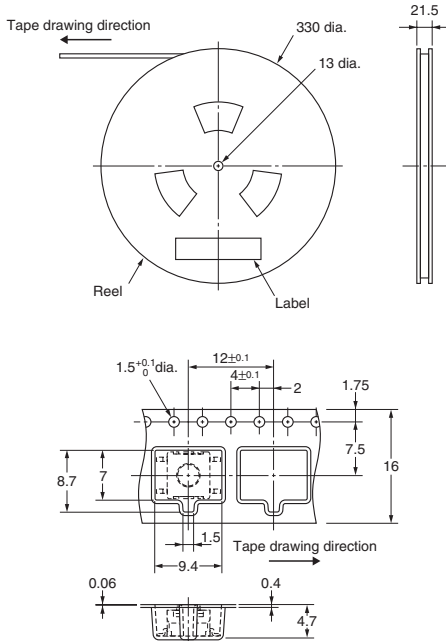

<b>Standards</b>	Conforms to JEITA.
<b>Package</b>	1,000 Switches
<b>Heat resistance</b>	50°C for 24 hours (without deformation)

**Note:** Switches with ground terminals are packaged with the ground terminal on the opposite side of the guide hole.

**LEDs (B3J)**

Make sure that the polarity of the LEDs is correct. The polarity is not indicated on the Switch, but the positive pole is located on the back surface of the Switch on the side without the OMRON mark.

Connect limiting resistors to the LEDs. The Switch does not have built-in limiting resistors, so satisfy the LED characteristics by obtaining the limiting resistance according to the following formula based on the voltage to be used.

$$\text{Limiting resistance (R)} = \frac{\text{Voltage used (E)} - \text{LED forward voltage (VF)}}{\text{LED forward current (IF)}} \quad (\Omega)$$

