

# Description

## Assemblies and combinations

Individual switches in combination with endcaps can easily be built into block assemblies by integrated snap pins. Spacers and housings can be integrated in any given sequence.

## Special circuit boards

If you require a specially constructed PCB (special material, terminals, layout etc.), please consult the factory.

## Stops

Cherry provides many standard combinations of rotation-limiting stops to help tailor our switches exactly to your application. In series PE stops can be installed in the field.

## Colors and legends

The standard switch color is black. The wheels are black with white characters. Special colors for housings, wheels and legends are available upon request. We are able to print letters, symbols or figures according to individual requirements.

## Circuitry

Standard circuitry is break-before-make (bbm). For make-before-break (mbb), please consult the factory.

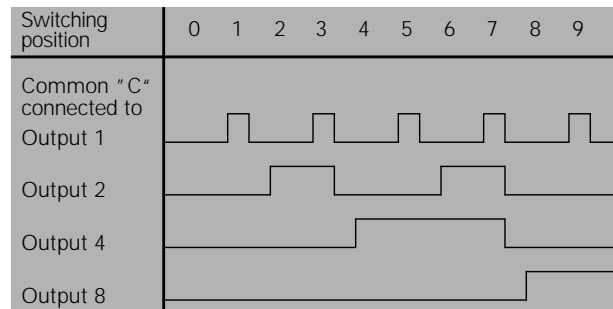

## Codes

For standard codes please refer to individual switch series. Further and special codes available upon request.

## Mounting of components

Many standard codes are available with an extended PCB for mounting of diodes or resistors.

## Truth tables

Table 1: BCD

Readout-symbols	Common C connected to			
	1	2	4	8
0				
1	•			
2		•		
3	•	•		
4			•	
5	•		•	
6		•	•	
7	•	•	•	
8				•
9	•			•

Table 2: Decimal

Readout-symbols	Common C connected to									
	0	1	2	3	4	5	6	7	8	9
0	•									
1		•								
2			•							
3				•						
4					•					
5						•				
6							•			
7								•		
8									•	
9										•

Table 4: Single pole repeating

Readout-symbols	Common C connec. to	
	1	2
+ 0	0	•
- 1	5	•
+ 0	0	•
- 1	5	•
+ 0	0	•
- 1	5	•
+ 0	0	•
- 1	5	•
+ 0	0	•
- 1	5	•

Table 5: Hexadecimal

Readout-symbols	Common C connected to			
	1	2	4	8
0				
1	•			
2		•		
3	•	•		
4			•	
5	•		•	
6		•	•	
7	•	•	•	
8				•
9	•			•
10(A)		•		•
11(B)	•			•
12(C)		•		•
13(D)	•			•
14(E)		•		•
15(F)	•			•

Table 8: BCD + complement

Readout-symbols	Common C connec. to							
	1	2	3	4	1	2	4	8
0					•	•	•	•
1	•				•	•	•	•
2		•			•	•	•	•
3	•	•			•	•	•	•
4			•		•	•	•	•
5	•		•		•	•	•	•
6		•	•		•	•	•	•
7	•	•	•		•	•	•	•
8				•	•	•	•	•
9	•			•	•	•	•	•

Table 11: BCD complement

Readout-symbols	Common C connec. to			
	1	2	4	8
0	•	•	•	•
1		•	•	•
2	•		•	•
3		•		•
4	•	•		•
5		•	•	•
6	•		•	•
7		•		•
8	•	•	•	•
9		•	•	•

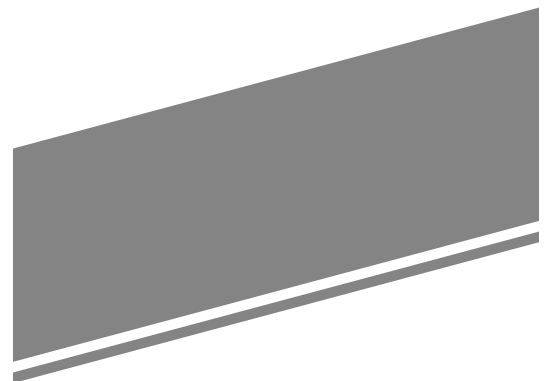

# Serie PA

## Characteristics

- Selector switches with very small dimensions for front-mounting.
- 10 or 16 switching positions. Housing black.
- Indirect operation upon request.
- Extended PCB for mounting of additional components available.
- Connection with Q.C. terminal or solder pins
- Illumination upon request.

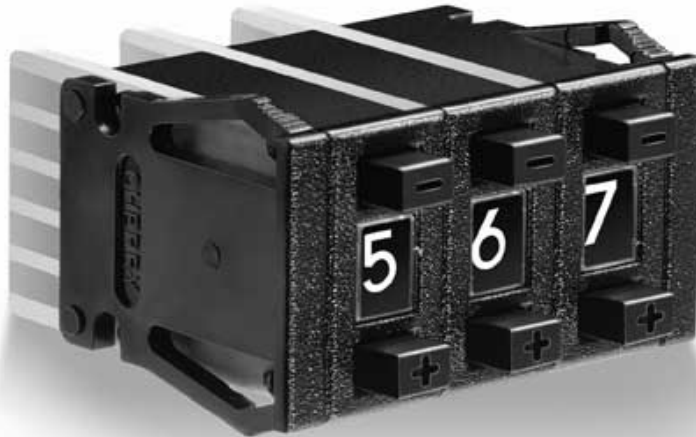

## Technical data

Operating force	approx. 300 cN (with tactile feeling)
Contact resistance	0,1 $\Omega$ max.
Insulating resistance	10 <sup>9</sup> M $\Omega$
Dielectric strength	500 V-
Electrical rating (ohmic resistance)	0,1 A/50 V=
Max. current (non switching current)	1A
Temperature	-20 bis +80 °C
Life cycle (mechanical)	10 <sup>6</sup> operations
Shock	50 g, 11 ms
Vibration	15 g, 10-2000 Hz
Weight	approx. 2 g

## Materials

Housing material	PPO (Noryl)
Contacts	WE alloy No. 2
Printed circuit board	G 10 (FR 4) Glass filled epoxy, copper-plated Au over Ni

## Mounting

Front-mounting, snap-in end-caps. Mounting of units through integrated pins.

## Stops Terminals

Setting through factory only.  
Q.C. terminal gold-plated or solder pins.

## Dimensions in mm

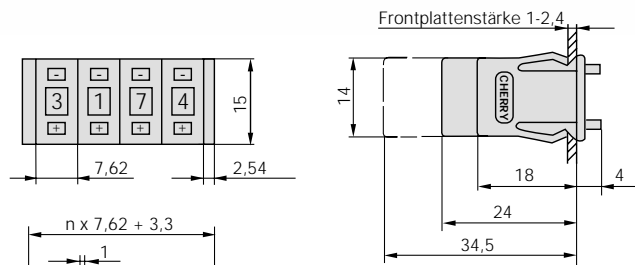

Schalt-Positionen	Fenster-Ausschnitt	Ziffern-Höhe
10	B=3,6 H=4	3
16	B=3,6 H=2,5	1,8

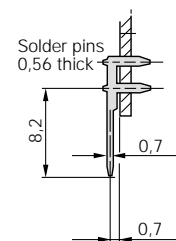
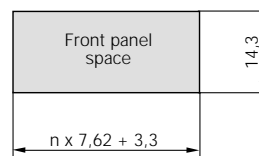
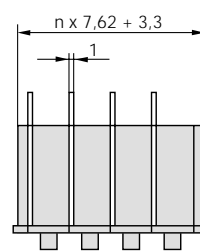

Solder pins not available for codes "Decimal" and "BCD + complement"

## PCB terminals

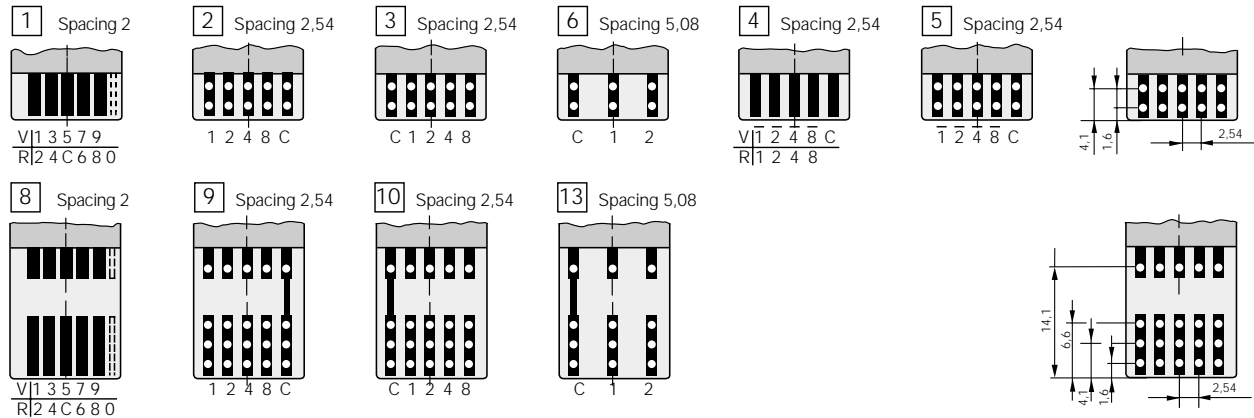

## Codes b

Switching position	Code Other codes on request	Readout	Truth table no (refer to page 3)	PCB-terminal no.	PCB short	PCB extended	Code
10	Dezimal	0 - 9	2	1/8	•	•	A
10	BCD	0 - 9	1	2/9	•	•	C
10	BCD Complement	0 - 9	11	5	•	•	E
10	BCD + Complement	0 - 9	8	4	•	•	F
10	Single pole repeating	+/- alt.	4	6/13	•	•	P
16	Hexadecimal	0 - 15	5	3/10	•	•	G
16	Hexadecimal	0 - 9, A - F	5	3/10	•	•	H

## Terminals c

Terminals	Index
Q.C. terminals	A
Solder pins	F

## PCB versions a

PCB version	Index
short	3
extended	4

## Accessories for assembly

	Stock codes
Endcap left	609-0801
Endcap right	609-0799
Housing 7,62 mm	609-0797
Spacer 2,54 mm	609-0803

## Example

PA: Series
C: Code BCD
A: Q.C. terminal
3: PCB short
4: 4 indiv. Switches, completely assembled with endcaps
00: Standard version

## Ordering index

a	b	c	d	e	f
PA	C	A	3	4	00

e Single switch or qty. or assembled switches (1 - 9) with endcaps  
 f Version (Standard = 00)

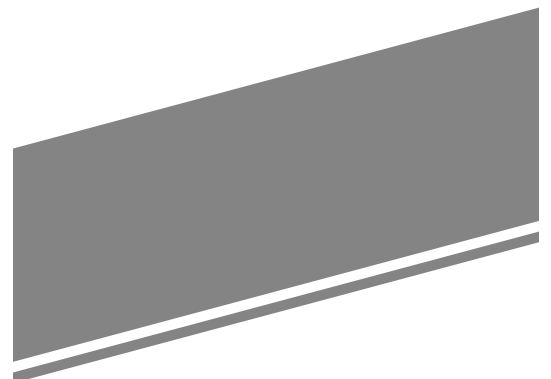

# Series PB

## Characteristics

- Selector switches with only 6 mm width for compact building of blocks with a larger number of modules.
- 10 switching positions. Housing black.
- Connection with solder pins



## Technical data

Operating force	approx. 300 cN (with tactile feeling)
Contact resistance	0,1 $\Omega$ max.
Insulating resistance	10 <sup>3</sup> M $\Omega$
Dielectric strength	500 V-
Electrical rating (ohmic resistance)	0,1 A/50 V=
Max. current (non switching current)	1A
Temperature	-20 bis +80 °C
Life cycle (mechanical)	10 <sup>6</sup> operations
Shock	50 g, 11 ms
Vibration	15 g, 10-2000 Hz
Weight	approx. 2 g

## Materials

Housing material	PPO (Noryl)
Contacts	WE alloy
Printed circuit board	FR 3, copper-plated Au over In

## Mounting

Front-mounting, snap-in end-caps. Mounting of units through integrated pins.

## Stops Terminals

Setting through factory only.  
Solder pins: 0,6 x 0,5 (spacing 2,54)

## Dimensions in mm

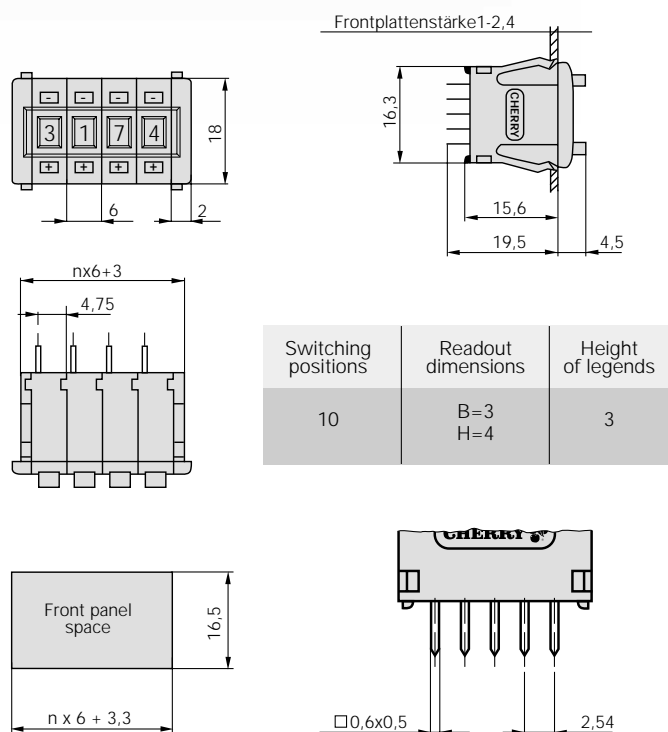

## PCB terminals

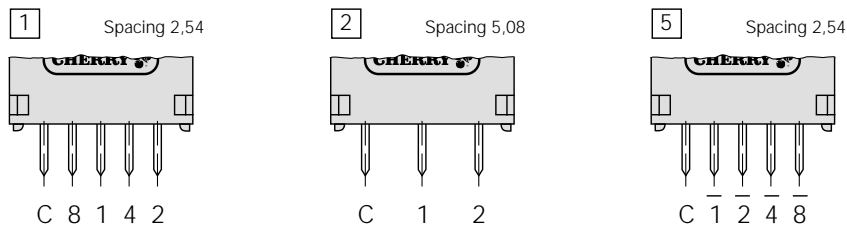

Switching position	Code	Readout	Truth table no.- (refer to page 3)	PCB terminal no.	Code
10	BCD	0 - 9	1	1	C
10	BCD Complement	0 - 9	11	5	E
10	Single pole repeating	+/- alt.	4	2	P

## Terminals c

Terminals	Index
Solder pins	1

## PCB versions a

PCB version	Code
PCB flush with housing with solder pins	E

## Accessories for assembly

Stock codes.

Endcap left	609-1346
Endcap right	609-1347
Housing 6 mm	609-1348

## Example

PB: Series
C: Code BCD
1: Solder pins
E: PCB flush with housing
4: 4 indiv. switches, completely assembled with endcaps
00: Standard version

## Ordering index

a	b	c	d	e	f
PB	C	1	E	4	00

e Single switch or qty. or assembled switches (1 - 9) with endcaps  
 f Version (Standard = 00)

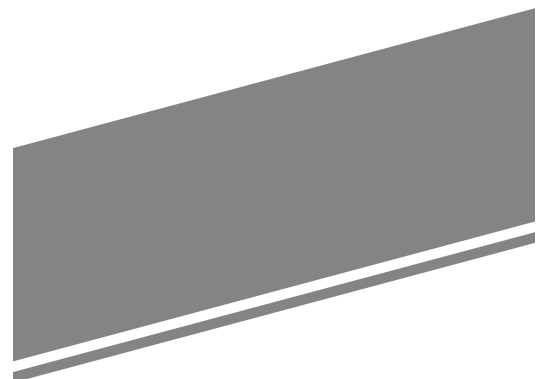

# Series PE

## Characteristics

- Selector switches for easy snap in front-mounting.
- 10 or 16 switching positions. Housing black.
- For switches with 10 switching positions stops can be installed in the field.
- Illumination upon request.



## Technical data

Operating force	approx. 400cN (with tactile feeling)
Contact resistance	0,1 $\Omega$ max.
Insulating resistance	10 <sup>8</sup> M $\Omega$
Dielectric strength	500 V-
Electrical rating (ohmic resistance)	0,1 A/50 V=
Max. current (non switching current)	1 A
Temperature	-20 to +80 °C
Life cycle (mechanical)	10 <sup>6</sup> operations
Shock	50 g, 11 ms
Vibration	15 g, 10-2000 Hz
Weight	approx. 4 g

## Materials

Housing material	PPO (Noryl)
Contacts	WE alloy No. 2
Printed circuit board	G 10 (FR 4), Glass filled epoxy, copper-plated Au over Ni
Mounting	Front-mounting, snap-in endcaps. Mounting of units through integrated pins.

## Stops

Setting through factory or afterwards in the field (10 switching positions). With 16 switching positions stops can only be set in the factory.

## Terminals

Q.C. terminal gold-plated or solder pins.

## Dimensions in mm

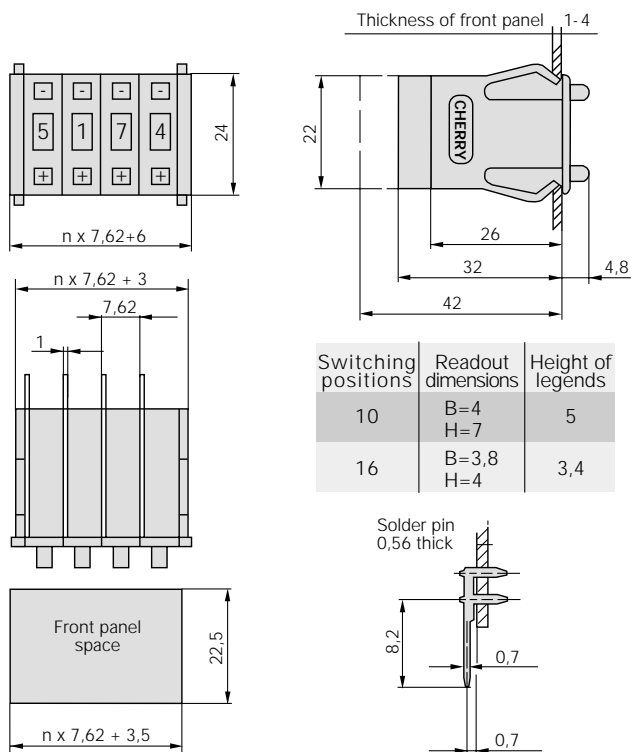

## PCB terminals

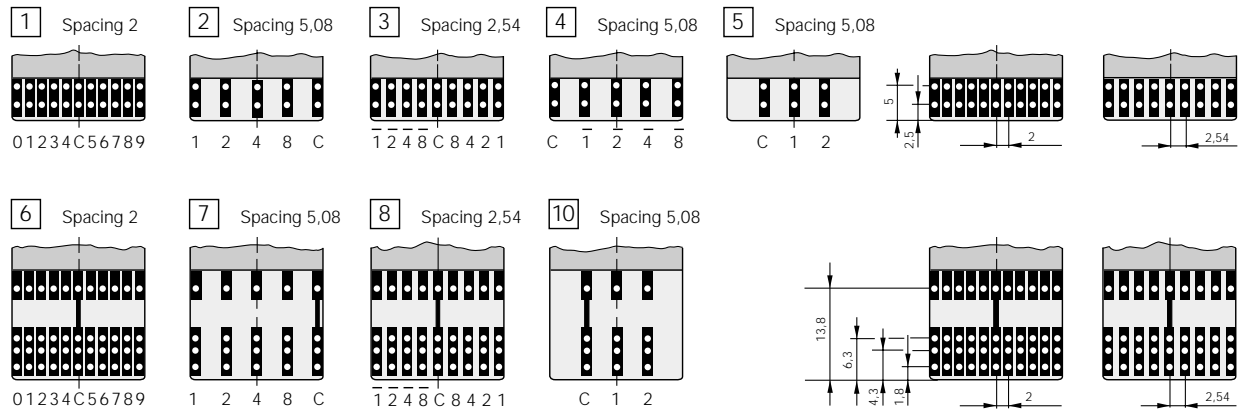

## Codes b

Switching position	Code Other codes on request	Readout	Truth table no. (refer to page 3)	PCB terminal no.	PCB short	PCB extended	Code
10	Decimal	0 - 9	2	1/6	•	•	A
10	BCD	0 - 9	1	2/7	•	•	C
10	BCD Complement	0 - 9	11	4	•	•	E
10	BCD + Complement	0 - 9	8	3/8	•	•	F
10	Single pole repeating	+/- alt.	4	5/10	•	•	P
16	Hexadecimal	0 - 15	5	2/7	•	•	G
16	Hexadecimal	0 - 9, A - F	5	2/7	•	•	H

## Terminals c

Terminals	Index
Q.C. terminal	A
Solder pins	F

## PCB versions a

PCB version	Index
short	3
extended	4

## Accessories for assembly

Accessories	Stock codes
Endcap left	609-0754
Endcap right	609-0756
Housing 7,62 mm	609-0752
Spacer 2,54 mm	609-0760
Spacer 2,54 mm without snap-in brackets	609-1609
Stop pin	607-0013

## Example

PE: Series
C: Code BCD
A: Q.C. terminal
3: PCB short
4: 4 indiv. switches, completely assembled with endcaps
00: Standard version

## Ordering index

a	b	c	d	e	f
PE	C	A	3	4	00

e Single switch or qty. or assembled switches (1 - 9) with endcaps  
 f Version (Standard = 00)

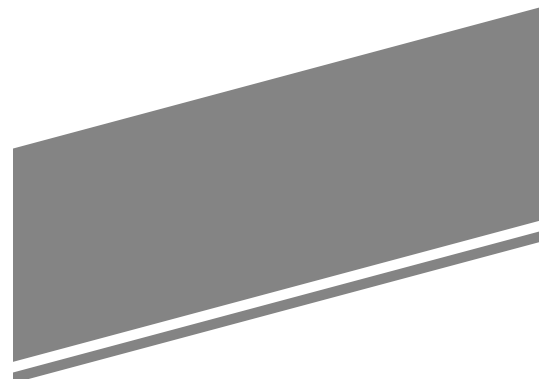

# Connectors



Connectors make the connection of the selector switches very easy. The female connectors are available with and without flange. Terminals of the connectors either solder pin or solder lugs.

Connector		without flange		with flange	
Series PA	Code	Solder pins	Solder lugs	Solder pins	Solder lugs
	C,E,G,H	C2KO-P107	C2KO-N107	C2KF-P109	C2KF-N109
	F	C2KO-P108	C2KO-N108	C2KF-P110	C2KF-N110
	P	C2KO-P130	C2KO-N130	C2KF-P129	C2KF-N129
	A	C2RO-P8AD	C2RO-N8AD	C2RF-P8AD	C2RF-N8AD
Series PE	Code	Solder pins	Solder lugs	Solder pins	Solder lugs
	C,E,G,H	C2RO-P111	C2RO-N111	C2RF-P116	C2RF-N116
	F	C2RO-P113	C2RO-N113	C2RF-P118	C2RF-N118
	P	C2RO-P135	C2RO-N135	C2RF-P136	C2RF-N136

Series	with flange						
	without flange				E	F	G
	Spacing A	B	C	D			
PA	4 x 2,54	1,3	14,3	16	22	28	2,35
PE	10 x 2,0 8 x 2,54	1,3	22,3	24	30	36	2,35

With flange

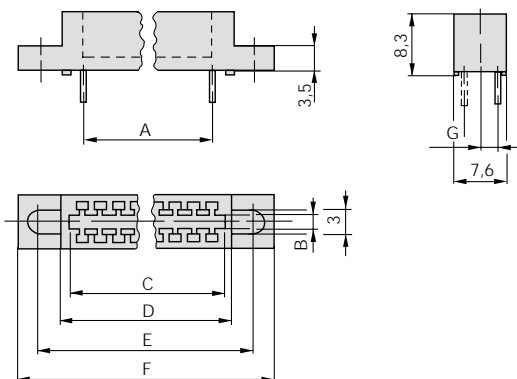

Without flange

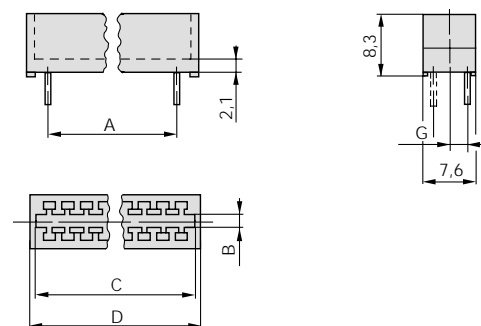

With solder pins

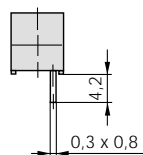

With solder lugs

