

APEM

K range

Power rocker switches and indicators

- Wide range
- Laser etched symbols
- Illuminated or non-illuminated
- Optionally sealed to IP68



A P E M

**Unique
rocker design**

K range

Power rocker switches and indicators

The K range at a glance

A range of mix and match products



KR rocker switches

Attractive rugged rocker switches with more than 3.000.000 possible combinations. Custom laser etching.

Page 3



KL locking rocker switches

Available with 2 or 3 positions, with one locked position. Patented intuitive ergonomics.

Page 12



KI indicators

A complete indicator series with a wide choice of colours and a large number of LEDs. Long life expectancy.

Page 21



KG rocker switches

With a raised protection bezel preventing inadvertent actuation of the rocker.

Page 26

Accessories - Page 34



Hole plug

For future extensions.



Connector

For separate wiring.



Mounting panel units

To limit the number of cut-outs.



Removing tool

APEM will be happy to develop custom product solutions. Please contact us with your requirements.

Attractive rugged rocker switch

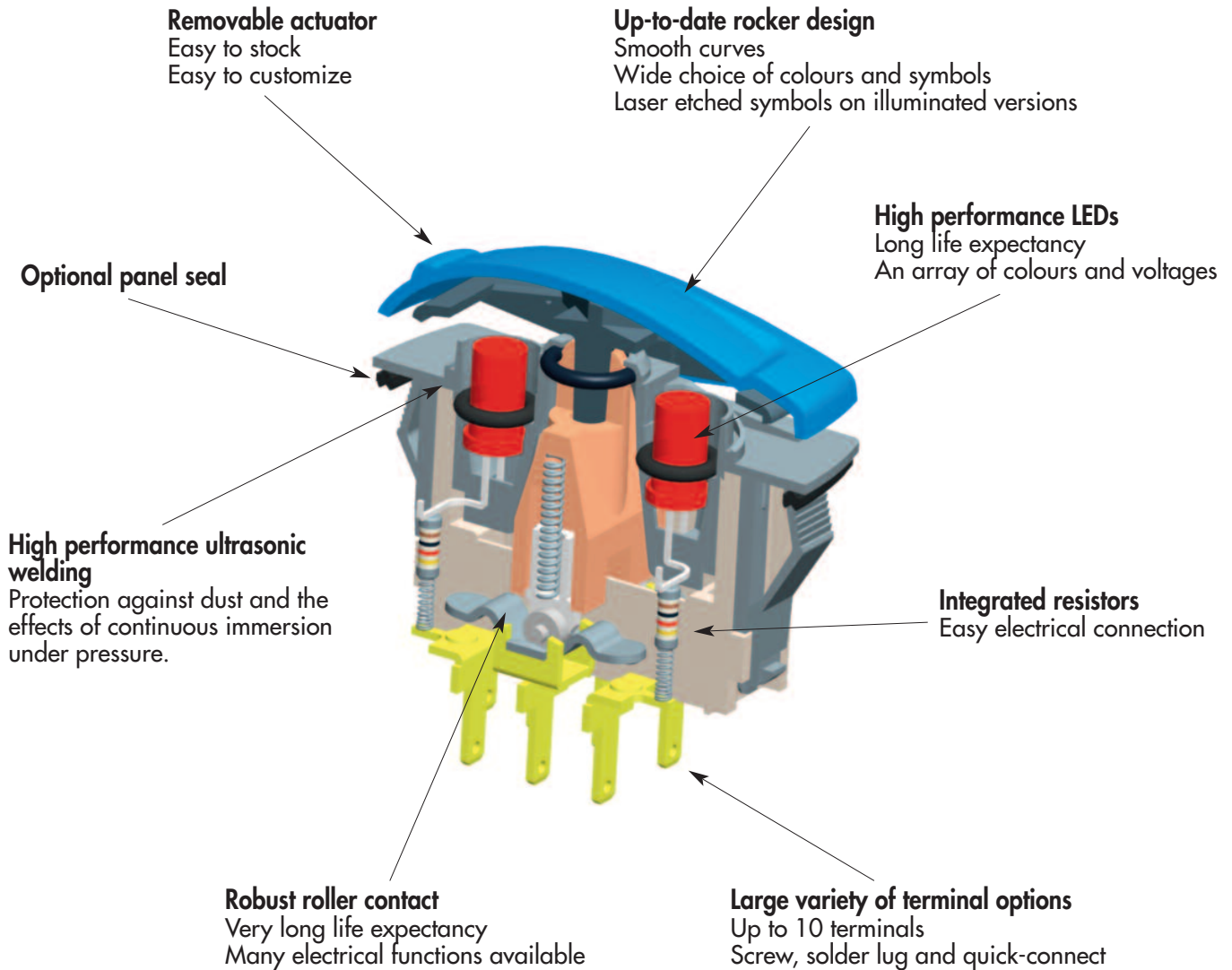

APEM will be happy to develop custom product solutions. Please contact us with your requirements.

KR series

Power rocker switches

Specifications



- Unique rocker design
- Wide choice of colours
- Laser etched symbols
- Illuminated or non-illuminated
- Optionally sealed to IP68

ELECTRICAL SPECIFICATIONS

- Current/voltage rating with resistive load :
 - Silver contacts (A) : 5A 24VDC, 100.000 cycles
 - 10A 24VDC, 10.000 cycles (terminals 6.35 x 0.8 only)
 - Gold plated contacts (D) : 20mA 12V, 150.000 cycles
- Initial contact resistance : 10 mΩ max.
- Insulation resistance : 1.000 MΩ min. at 500VDC
- Dielectric strength : 2.000 Vrms 50 Hz min. between terminals
- Mechanical life : 150.000 cycles min.

ENVIRONMENTAL SPECIFICATIONS

- Degree of protection of sealed versions : frontal sealing to IP68 according to IEC 60529 (submersion under 1 meter of water for more than 30 minutes)
- Salt spray resistance : 96 hours according to IEC 512-6, test 11f
- Vibration resistance : 10-500 Hz / 10 g per IEC 60068-2-6
- Operating temperature : -40°C to +85°C

MATERIALS

- Case : PA 6-6
- Actuator : ABS
- Bezel : PA 6-6
- Terminals : brass, silver plated
- Contacts : silver (A)
or silver, gold plated (D)
- Contact roller : brass, nickel plated

SEALING

Sealing is optional.

To order a sealed product, complete the appropriate box of ordering format on the following pages.

DIMENSIONS

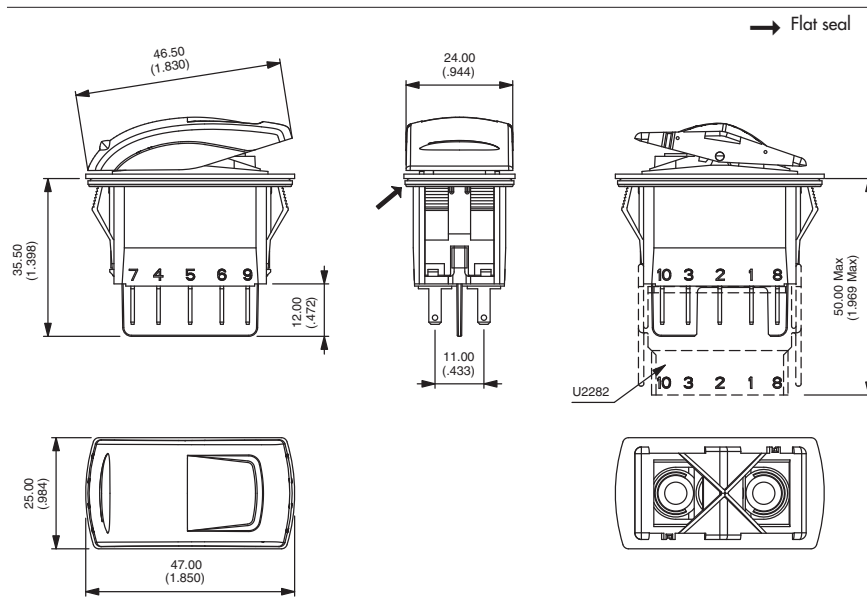

Dimensions : First dimensions are in mm while inches are shown as bracketed numbers.

Tolerance : The general tolerance for dimensions in this brochure is $\pm 0,3$ (.012). Overall dimension tolerance is $\pm 0,5$ (.020).



Packaging unit : 40 pieces

Dimensions, specifications and data shown in this brochure are subject to change without notice.

KR series

Power rocker switches

Selection guide

HOW TO ORDER

- To order a complete product, fill in all the boxes of the following order guide.
- To order case only (without actuator), finish your order number with the LED wiring code.
- To order actuator only (without case), begin the order number with code KRR, then follow the order format from "actuator type" until the end of the options.



CASE + LEADS

KR						Side A	Side B																																																																											
SERIES	Electrical functions		Contacts		Sealing		LEDS																																																																											
Poles	<table border="1"> <tr><td>1</td><td>ON</td><td>-</td><td>OFF</td></tr> <tr><td>4</td><td>ON</td><td>ON</td><td>ON</td></tr> <tr><td>4-1R</td><td>ON</td><td>ON</td><td>MOM</td></tr> <tr><td>5</td><td>MOM</td><td>-</td><td>ON</td></tr> <tr><td>6</td><td>ON</td><td>-</td><td>ON</td></tr> <tr><td>7</td><td>MOM</td><td>OFF</td><td>MOM</td></tr> <tr><td>8</td><td>ON</td><td>OFF</td><td>MOM</td></tr> <tr><td>9</td><td>ON</td><td>OFF</td><td>ON</td></tr> </table>		1	ON	-	OFF	4	ON	ON	ON	4-1R	ON	ON	MOM	5	MOM	-	ON	6	ON	-	ON	7	MOM	OFF	MOM	8	ON	OFF	MOM	9	ON	OFF	ON	<table border="1"> <tr><td>A</td><td>Silver</td></tr> <tr><td>D</td><td>Gold plated</td></tr> </table>		A	Silver	D	Gold plated	<table border="1"> <tr><td>X</td><td>No</td></tr> <tr><td>K</td><td>Yes</td></tr> </table>		X	No	K	Yes	<table border="1"> <tr><td>X</td><td>None</td></tr> <tr><td>A</td><td>LED 6V red</td></tr> <tr><td>B</td><td>LED 6V green</td></tr> <tr><td>C</td><td>LED 6V yellow</td></tr> <tr><td>M</td><td>LED 6V blue</td></tr> <tr><td>R</td><td>LED 6V white</td></tr> <tr><td>D</td><td>LED 12V red</td></tr> <tr><td>E</td><td>LED 12V green</td></tr> <tr><td>F</td><td>LED 12V yellow</td></tr> <tr><td>N</td><td>LED 12V blue</td></tr> <tr><td>S</td><td>LED 12V white</td></tr> <tr><td>J</td><td>LED 24V red</td></tr> <tr><td>K</td><td>LED 24V green</td></tr> <tr><td>L</td><td>LED 24V yellow</td></tr> <tr><td>P</td><td>LED 24V blue</td></tr> <tr><td>T</td><td>LED 24V white</td></tr> </table>		X	None	A	LED 6V red	B	LED 6V green	C	LED 6V yellow	M	LED 6V blue	R	LED 6V white	D	LED 12V red	E	LED 12V green	F	LED 12V yellow	N	LED 12V blue	S	LED 12V white	J	LED 24V red	K	LED 24V green	L	LED 24V yellow	P	LED 24V blue	T	LED 24V white	Wiring See diagrams page 9.	
1	ON	-	OFF																																																																															
4	ON	ON	ON																																																																															
4-1R	ON	ON	MOM																																																																															
5	MOM	-	ON																																																																															
6	ON	-	ON																																																																															
7	MOM	OFF	MOM																																																																															
8	ON	OFF	MOM																																																																															
9	ON	OFF	ON																																																																															
A	Silver																																																																																	
D	Gold plated																																																																																	
X	No																																																																																	
K	Yes																																																																																	
X	None																																																																																	
A	LED 6V red																																																																																	
B	LED 6V green																																																																																	
C	LED 6V yellow																																																																																	
M	LED 6V blue																																																																																	
R	LED 6V white																																																																																	
D	LED 12V red																																																																																	
E	LED 12V green																																																																																	
F	LED 12V yellow																																																																																	
N	LED 12V blue																																																																																	
S	LED 12V white																																																																																	
J	LED 24V red																																																																																	
K	LED 24V green																																																																																	
L	LED 24V yellow																																																																																	
P	LED 24V blue																																																																																	
T	LED 24V white																																																																																	
		Terminals		Terminals (continued)																																																																														
		Screw 0 6 terminals with barrier Solder lug/quick-connect 2 6 terminals with barrier 4 6 terminals w/o barrier A 10 term. with barrier B 10 term. w/o barrier C 10 terminals for use with connector U2292 Quick-connect 6,35x0,8 3 6 terminals with barrier		Quick-connect 6,35x0,8 5 6 terminals w/o barrier D 10 term. with barrier E 10 term. w/o barrier F 10 term. for use with connector U2292 Quick-connect 2,8x0,8 G 10 term. with barrier H 10 term. w/o barrier J 10 terminals for use with connector U2282																																																																														

ACTUATOR

Type	Colour
1 For non-illuminated application 2 For illuminated application	1 Blue 1/4 Dark blue 2 Black 3 Green 4 Grey 5 Yellow 6 Red 7 Ivory 9 Orange A Aluminium bright

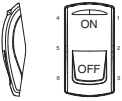
ACTUATOR MARKING

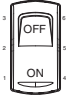
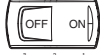
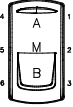
	Area A	Area M	Area B
Orientation	Symbols		
N  O  S  E 			

Symbols : see page 31.
Accessories : see page 34.

 **NOTICE** : please note that not all combinations of above numbers are available. Refer to the following pages for further information.

KR series

Power rocker switches

Case

- To order case only (without rocker), finish your order number with the LED wiring code.

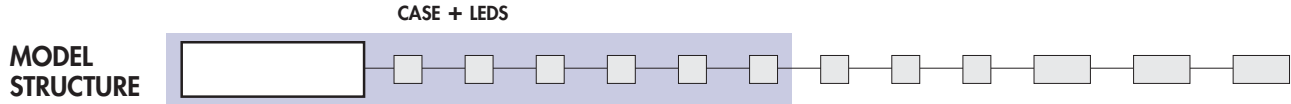



	2-3	1-2
	5-6	4-5
Single pole		
KR31	KR41	ON - OFF
	KR44*	ON ON ON
	KR44-1R*	ON ON MOM
KR35	KR45	MOM - ON
KR36	KR46	ON - ON
KR37	KR47	MOM OFF MOM
KR38	KR48	ON OFF MOM
KR39	KR49	ON OFF ON

Bottom view

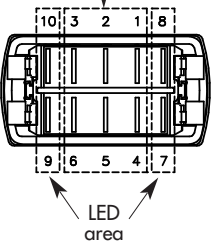

10 terminal version

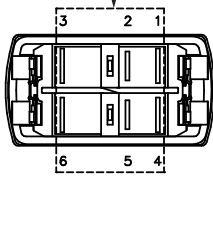

6 terminal version

* Function 4 : single pole in double pole case

ELECTRICAL FUNCTIONS AND CONNECTIONS

In the tables below, terminal connections as viewed from bottom of switch.
Only the contact area is represented.

For single pole models, only terminals 1, 2 and 3 are to be considered (not terminals 6, 5, 4).

x = w/o terminal
o = with terminal
▲ = momentary

	Positions				Positions		
Function 1 * KR31-KR41				Function 8 KR38-KR48			
Function 5 KR35-KR45				Function 9 KR39-KR49			
Function 6 KR36-KR46				Function 4 KR44			
Function 7 KR37-KR47				Function 4-1R KR44-1R			

* Function 1 only available for 6 terminal versions.

KR series

Power rocker switches

Case

TERMINALS

CASE + LEDS

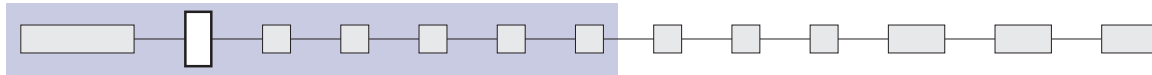

Screw

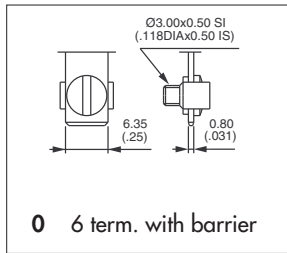

Solder lug / quick-connect

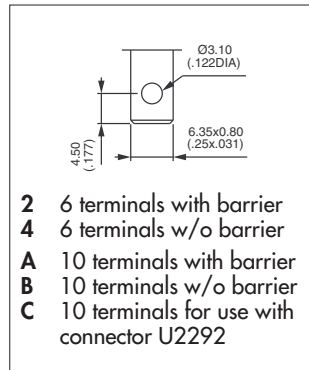

Normalized quick-connect 6,35x0,8

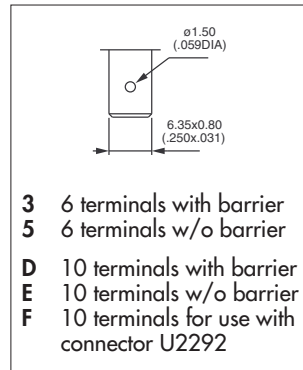

Normalized quick-connect 2,8x0,8

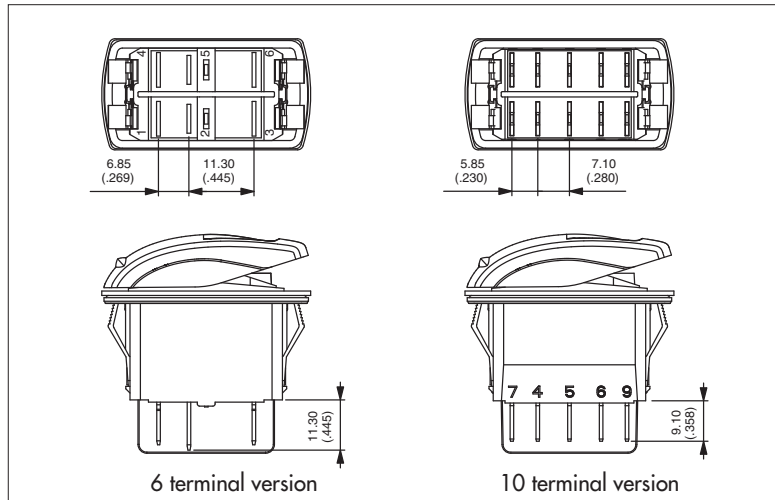
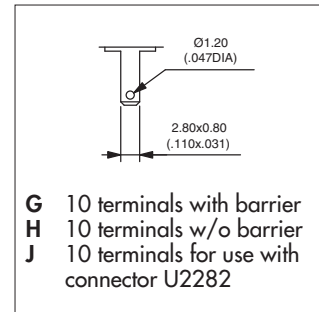

Terminals are marked on the case.

The drawings show the maximum possible number of terminals.

CONTACT MATERIALS

CASE + LEDS

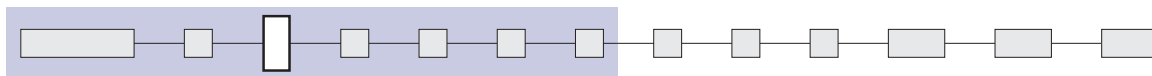

- A** Silver
- D** Silver, gold plated

KR series

Power rocker switches

Case - LEDs

SEALING

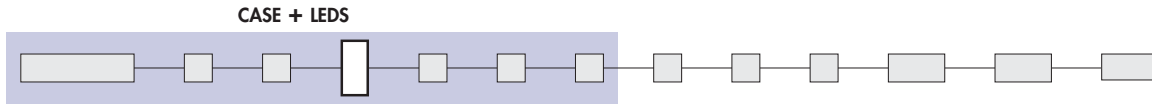

- X No sealing
- K IP68 (switch assembled on panel)

Ultrasonic welding of frame to case is standard on all versions.
The ultrasonic welding and the optional panel seal prevent water and dust from introducing into the switch housing.

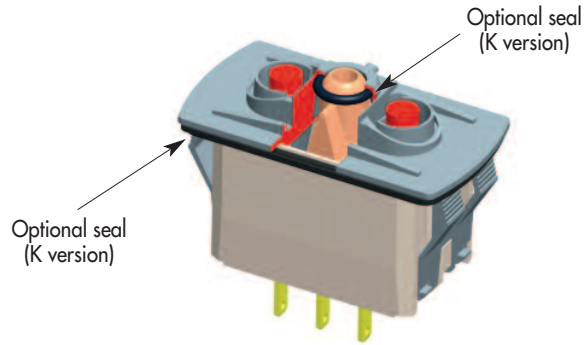

*The product shall be installed professionally.
Test conditions available on request.*

LEDS

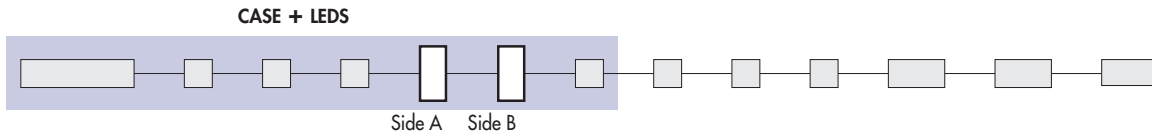

Complete each enlarged box with one of the codes listed below.

- X Without LED

	Red	Green	Yellow	Blue	White
6VDC	A	B	C	M	R
12VDC	D	E	F	N	S
24VDC	J	K	L	P	T

LED consumption : 20mA @ nominal voltage (25°C)

Other illumination solutions : on request.

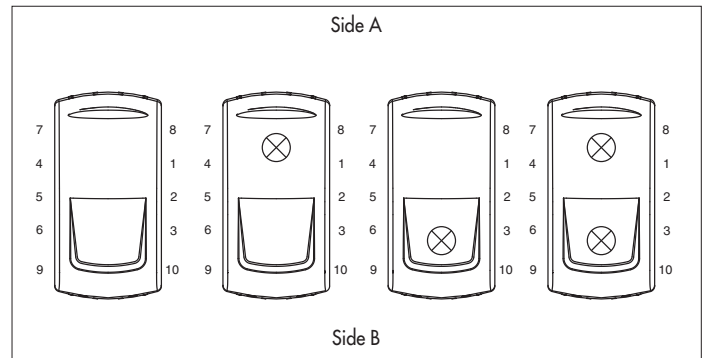

KR series

Power rocker switches

Case - LEDs

WIRING

The LED wiring diagram is shown on the case.

CASE + LEDs

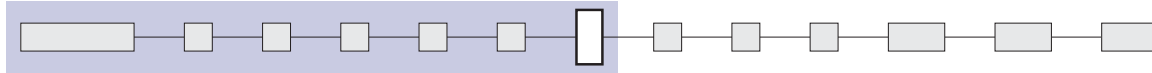

• For 6 terminal versions

LED connected to the load

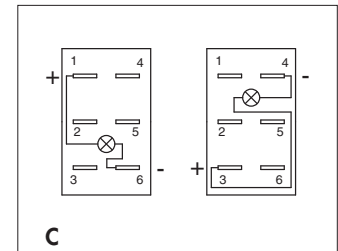
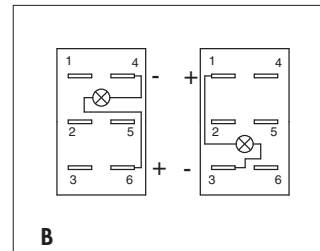
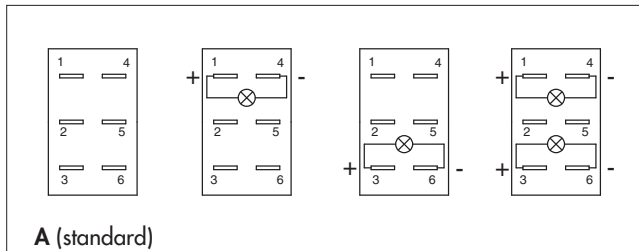

Note : If not available, terminals are added to connect the LED.

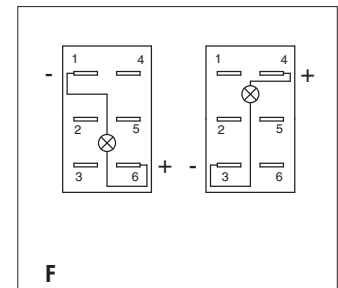
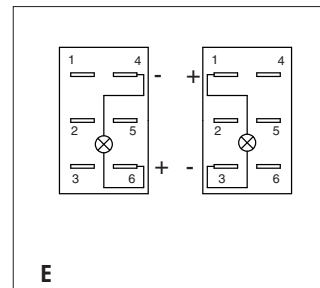
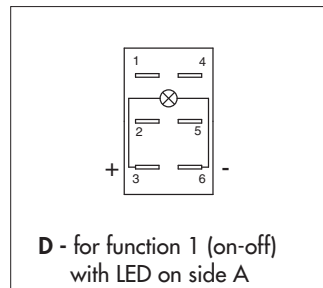

• For 10 terminal versions

Independent LED or integrated functions

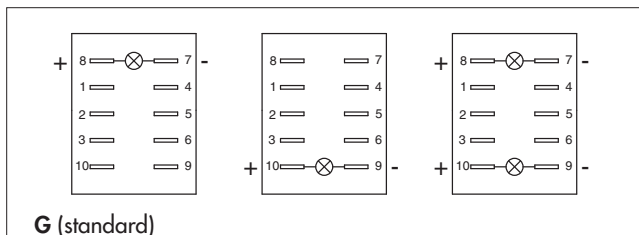

To have independent LEDs.

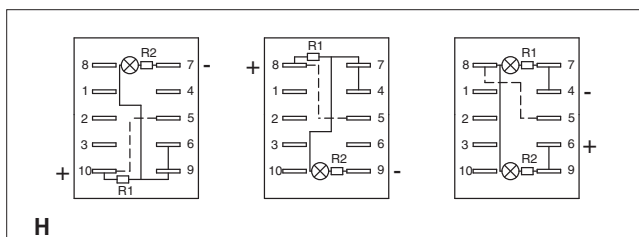

Available in Single Pole only, with H and J quick-connect terminals.

To obtain 2 symbol illumination levels (night illumination when OFF and higher illumination when ON).

Dotted line = external wiring, continuous line = internal wiring

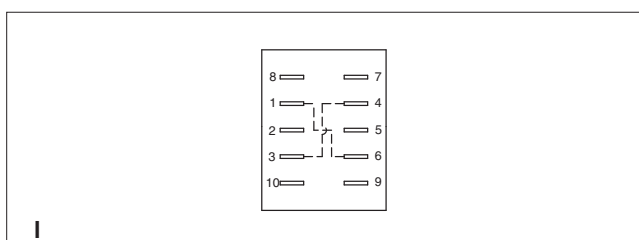

Power supply between 2 and 5 - Load between 1 and 4 or 3 and 6. Available with H and J quick-connect terminals.

To have a polarity inversion (typical application : fan motor). *Dotted line = internal wiring, continuous line = internal wiring*

Please contact us for other wiring solutions.

KR series

Power rocker switches

Actuator - Marking

To order actuator only (without case), begin the order number with code KRR, then follow the order format from "actuator type" until the end of the options.

ACTUATOR TYPE

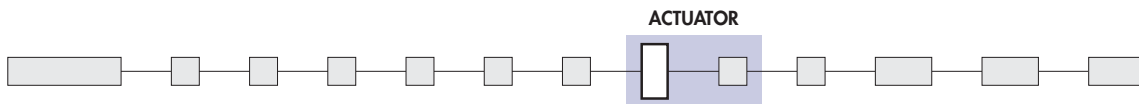

- 1 For non-illuminated application
 - 2 For illuminated application
- Other rocker design : on request.

ACTUATOR COLOUR

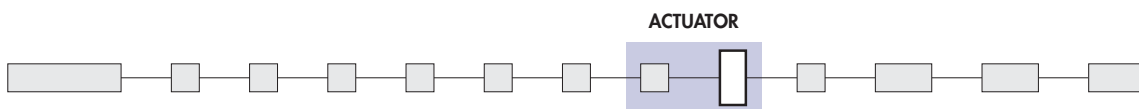

Code	Colour
1	Blue
1/4	Dark blue
2	Black
3	Green

Code	Colour
4	Grey
5	Yellow
6	Red
7	Ivory

Code	Colour
9	Orange
A	Aluminium bright

Note : colour 7 not available on illuminated versions.

A **soft-touch varnish** can be added. Consult us.



MARKING ORIENTATION

If no marking required, leave box blank.

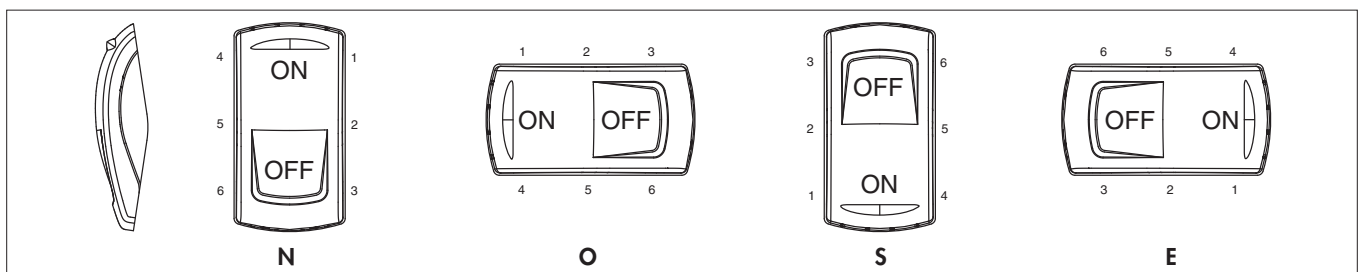
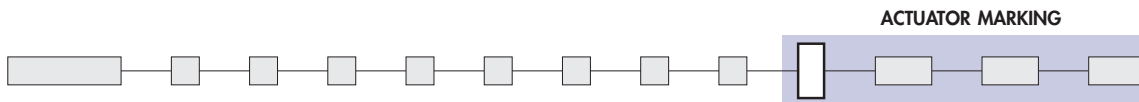

Other orientations : on request

KR series

Power rocker switches

Marking - Mounting

SYMBOLS

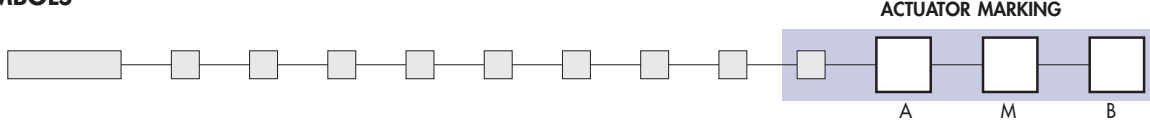

Available symbols : see page 31.

Marking colour

White marking for illuminated rockers (laser etching) and non-illuminated black rockers (pad printing). Black marking for non-illuminated colour rockers (pad printing). Other : on request.

Laser etching resistance

- Water and petrol resistant according to EN61058-1
- Tear resistant (cross-cut test) according to NF ISO 2409 : class 0
- UV resistant according to ISO 4892-2

Marking area

For illuminated versions. The symbol will be included in the hatched area.
Marking in M are : on request.

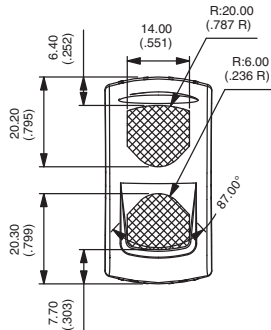
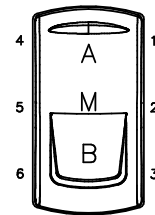

SWITCH PANEL CUT-OUT

Panel thickness : 0,8 mm to 4,6 mm
Recommended panel thickness :
between 2 mm and 3,5 mm

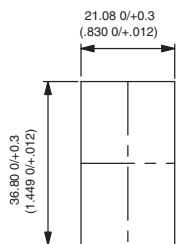

MATRIX MOUNTING

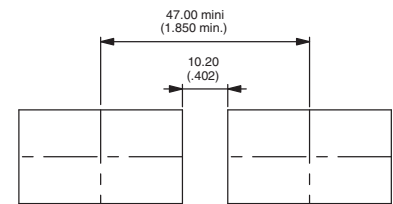
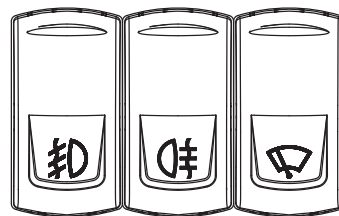
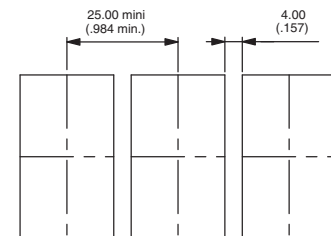

KL series

Locking rocker switches

Distinctive features

Unlocking actuator

Each KL rocker switch includes an unlocking actuator.

This actuator must be pressed to activate the protected function of the rocker. Moreover, two frames protect the unlocking actuator from untimely activation.

This intuitive and secured ergonomics is patented by APEM.



2 position versions (electrical functions 1, 5 and 6)

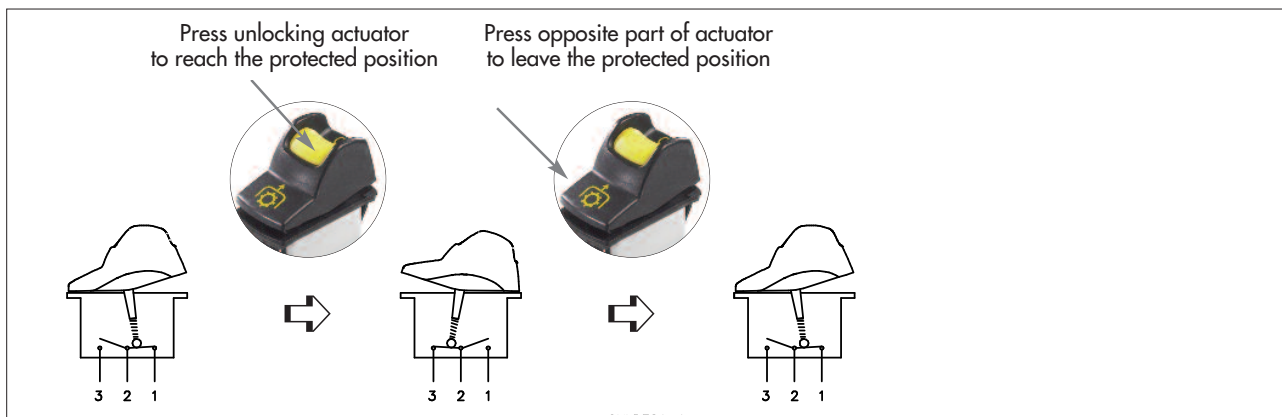

3 position versions (electrical functions 7, 8, 9 4, 4-1R)

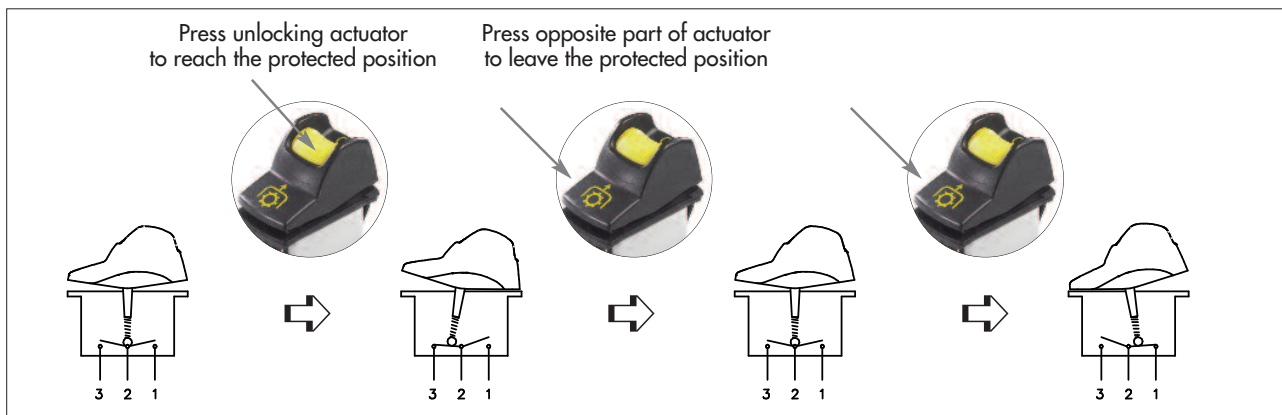

KL series

Locking rocker switches

Specifications



- One protected position
- Patented intuitive ergonomics
- Wide choice of colours
- Laser etched symbols
- Illuminated or non-illuminated

ELECTRICAL SPECIFICATIONS

- Current/voltage rating with resistive load :
 - Silver contacts (A) : 5A 24VDC, 100.000 cycles
 - 10A 24VDC, 10.000 cycles (terminals 6.35 x 0.8 only)
 - Gold plated contacts (D) : 20mA 12V, 150.000 cycles
- Initial contact resistance : 10 mΩ max.
- Insulation resistance : 1.000 MΩ min. at 500VDC
- Dielectric strength : 2.000 Vrms 50 Hz min. between terminals
- Mechanical life : 150.000 cycles min.

MATERIALS

- Case : PA 6-6
- Actuator and unlocking actuator : ABS
- Bezel : PA 6-6
- Terminals : brass, silver plated
- Contacts : silver (A) or silver, gold plated (D)
- Contact roller : brass, nickel plated

ENVIRONMENTAL SPECIFICATIONS

- Degree of protection of sealed versions : frontal sealing to IP68 according to IEC 60529 (submersion under 1 meter of water for more than 30 minutes)
- Salt spray resistance : 96 hours according to IEC 512-6, test 11f
- Operating temperature : -40°C to +85°C

SEALING

Sealing is optional.
To order a sealed product, complete the appropriate box of ordering format on the following pages.

DIMENSIONS

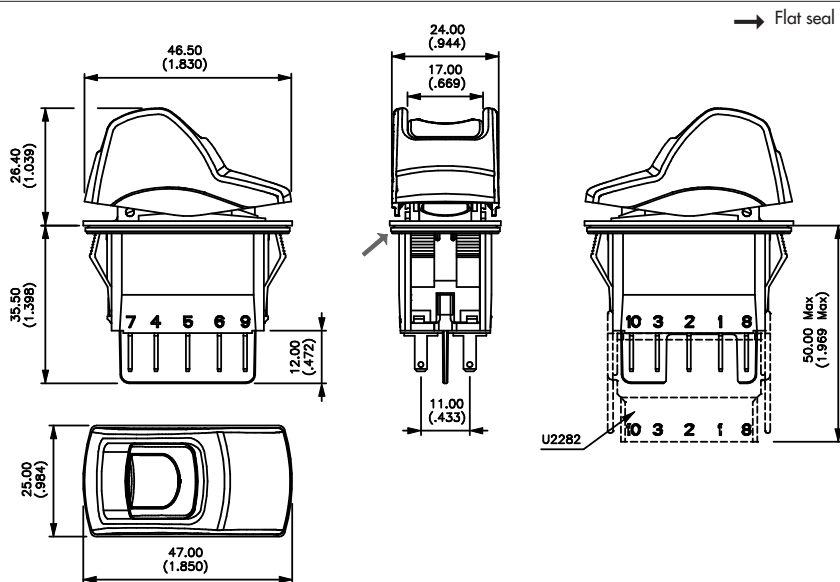

Dimensions : First dimensions are in mm while inches are shown as bracketed numbers.

Tolerance : The general tolerance for dimensions in this brochure is $\pm 0,3$ (.012). Overall dimension tolerance is $\pm 0,5$ (.020).



Packaging unit : 40 pieces

Dimensions, specifications and data shown in this brochure are subject to change without notice.

KL series

Locking rocker switches

Selection guide

• To order a complete product, fill in all the boxes of the following order guide.

CASE + LEDS

KL							Side B		
SERIES	Electrical functions			Contacts	Sealing	LEDS		Wiring	
Poles	1 ON - OFF 4 ON ON ON 4-1R ON ON MOM 5 MOM - ON 7 ON - ON 6 MOM OFF MOM 8 ON OFF MOM 9 ON OFF ON	A Silver	X No	Terminals Screw 0 6 terminals with barrier Solder lug/quick-connect 2 6 terminals with barrier 4 6 terminals w/o barrier A 10 term. with barrier B 10 term. w/o barrier C 10 terminals for use with connector U2292 Quick-connect 6,35x0,8 3 6 terminals with barrier		K Yes	Terminals (continued) Quick-connect 6,35x0,8 5 6 terminals w/o barrier D 10 term. with barrier E 10 term. w/o barrier F 10 term. for use with connector U2292 Quick-connect 2,8x0,8 G 10 term. with barrier H 10 term. w/o barrier J 10 terminals for use with connector U2282		See diagrams page 18.
3 Single pole 4 Double pole	X None A LED 6V red B LED 6V green C LED 6V yellow M LED 6V blue R LED 6V white D LED 12V red E LED 12V green F LED 12V yellow N LED 12V blue S LED 12V white J LED 24V red K LED 24V green L LED 24V yellow P LED 24V blue T LED 24V white								

ACTUATOR

Type	Rocker colour	Unlocking actuator colour
1 For non-illum. application 2 For illuminated application	1 Blue 1/4 Dark blue 2 Black 3 Green 4 Grey 5 Yellow 6 Red 7 Ivory 9 Orange	1 Blue 1/4 Dark blue 2 Black 3 Green 4 Grey 5 Yellow 6 Red 7 Ivory 9 Orange

ACTUATOR MARKING

	Area A	Area B	
Orientation	Symbols	Marking colour	
		Illuminated models Blank White Non-illuminated 1 Blue 2 Black 3 Green 4 Grey 5 Yellow 6 Red 7 White 9 Orange	
Symbols : see page 31. Accessories : see page 34.			



NOTICE : please note that not all combinations of above numbers are available. Refer to the following pages for further information.

KL series

Locking rocker switches

Case

CASE + LEDS

MODEL STRUCTURE

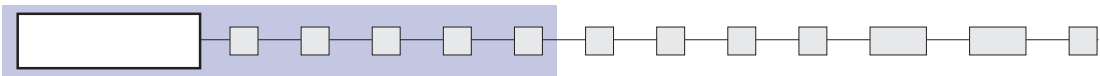



	2-3	1-2
	5-6	4-5
Single pole KL31		
Double pole KL41	ON - OFF	
KL44*	ON ON ON	
KL44-1R*	ON ON MOM	
KL35	MOM - ON	
KL36	ON - ON	
KL37	MOM OFF MOM	
KL38	ON OFF MOM	
KL39	ON OFF ON	

Bottom view

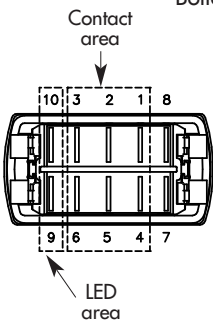

10 terminal version

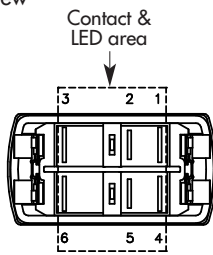

6 terminal version

* Function 4 : single pole in double pole case

ELECTRICAL FUNCTIONS AND CONNECTIONS

In the tables below, terminal connections as viewed from bottom of switch. Only the contact area is represented. For single pole models, only terminals 1, 2 and 3 are to be considered (not 6, 5, 4).

x = w/o terminal
o = with terminal
▲ = momentary

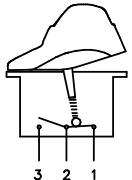
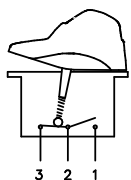
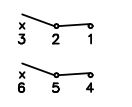
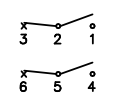
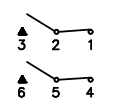
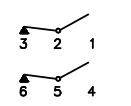
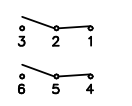
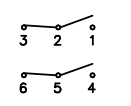
	2 positions	
		
	Press unlocking actuator to unlock.	
Function 1 * KL31-KL41		
Function 5 KL35 - KL45		
Function 6 KL36-KL46		

* **Function 1**
- Only available for 6 terminal versions.
- Illuminated versions only available with "A" wiring.

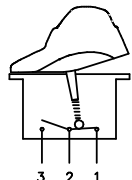
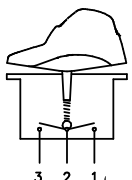
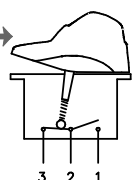
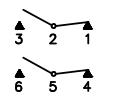
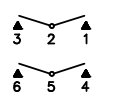
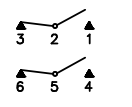
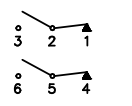
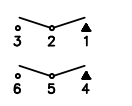
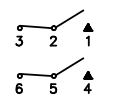
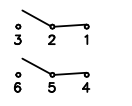
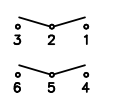
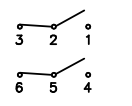
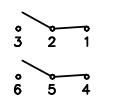
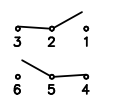
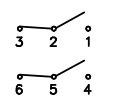
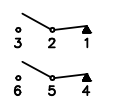
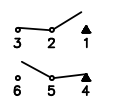
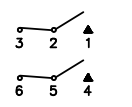
	3 positions		
			
Function 7 KL37-KL47			
Function 8 KL38-KL48			
Function 9 KL39-KL49			
Function 4 KL44			
Function 4-1R KL44-1R			

KL series

Locking rocker switches

Case

TERMINALS

CASE + LEDS

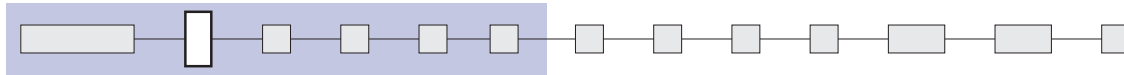

Screw

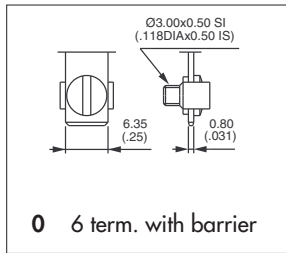

Solder lug / quick-connect

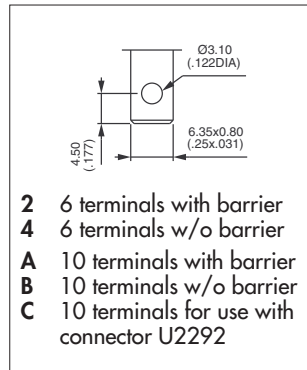

Normalized quick-connect 6,35x0,8

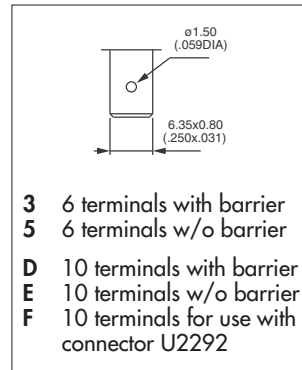

Normalized quick-connect 2,8x0,8

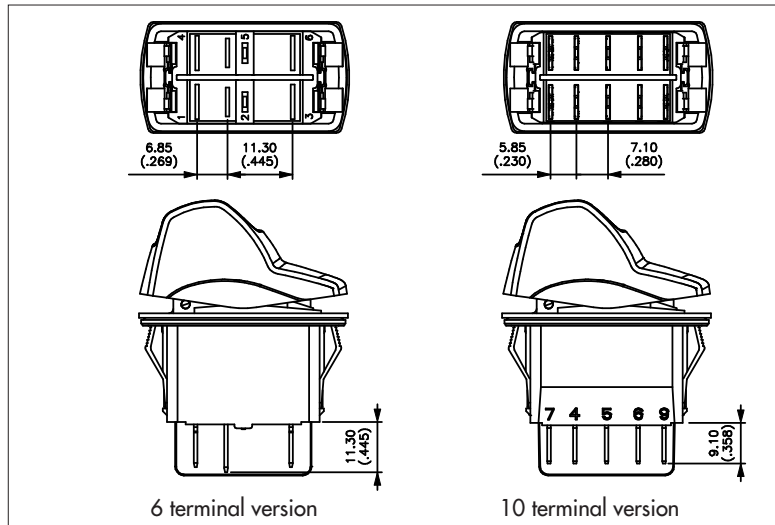
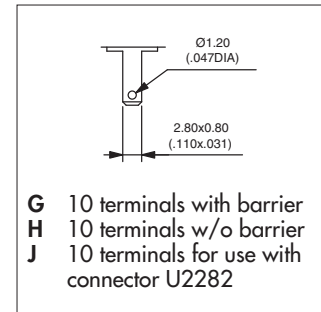

Terminals are marked on the case.

The drawings show the maximum possible number of terminals.

CONTACT MATERIALS

CASE + LEDS

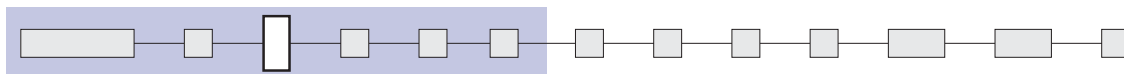

- A** Silver
- D** Silver, gold plated

KL series

Locking rocker switches

Case - LEDs

SEALING

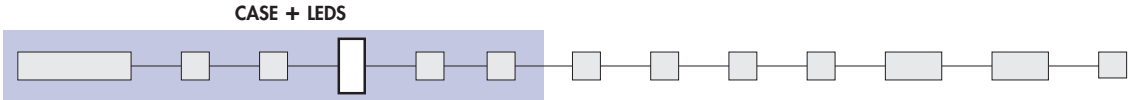

- X No sealing
- K IP68 (switch assembled on panel)

Ultrasonic welding of frame to case is standard on all versions.
 The ultrasonic welding and the optional panel seal prevent water and dust from introducing into the switch housing.

*The product shall be installed professionally.
 Test conditions available on request.*

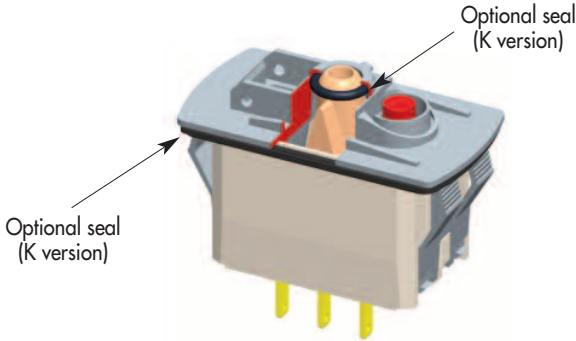

LEDS

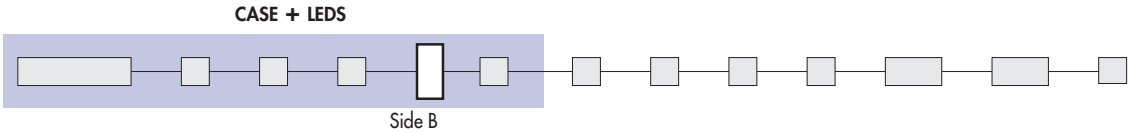

Complete enlarged box with one of the codes listed below.

- X Without LED

	Red	Green	Yellow	Blue	White
6VDC	A	B	C	M	R
12VDC	D	E	F	N	S
24VDC	J	K	L	P	T

LED consumption : 20mA @ nominal voltage (25°C)
 Other illumination solutions : on request.

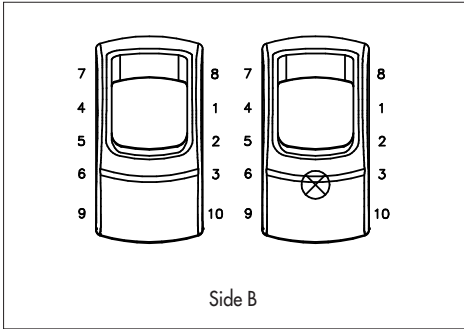

KL series

Locking rocker switches

Case - LED

WIRING

The LED wiring diagram is shown on the case.

CASE + LED

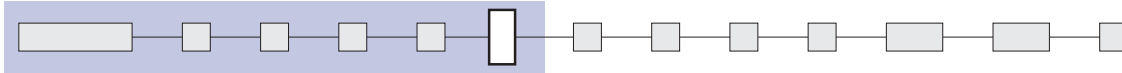

- For 6 terminal versions LED connected to the load

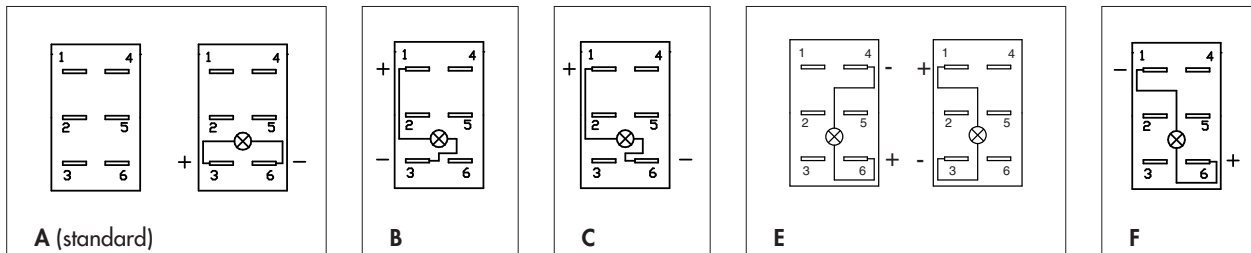

Note : If not available, terminals are added to connect the LED.

- For 10 terminal versions Independent LED or integrated functions

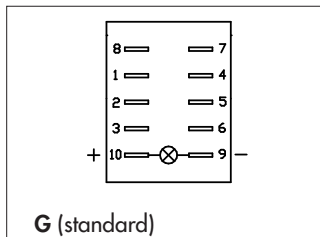

To have independent LED.

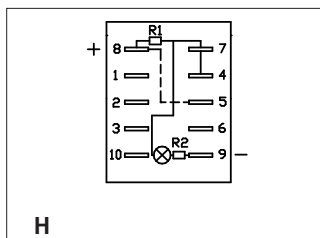

To obtain 2 symbol illumination levels (night illumination when OFF and higher illumination when ON).
Dotted line = external wiring, continuous line = internal wiring

Available in Single Pole only, with H and J quick-connect terminals.

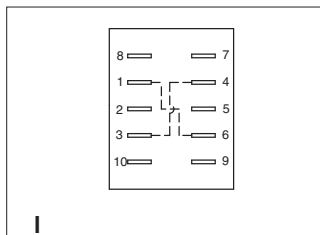

To have a polarity inversion (typical application : fan motor).
Dotted line = internal wiring, continuous line = internal wiring

Power supply between 2 and 5 - Load between 1 and 4 or 3 and 6.
Available with H and J quick-connect terminals.

Please contact us for other wiring solutions.

KL series

Locking rocker switches

Actuator - Marking

ACTUATOR TYPE

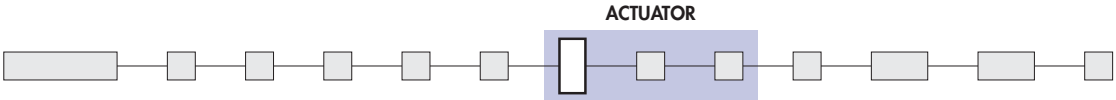

- 1 For non-illuminated application
- 2 For illuminated application

ROCKER COLOUR

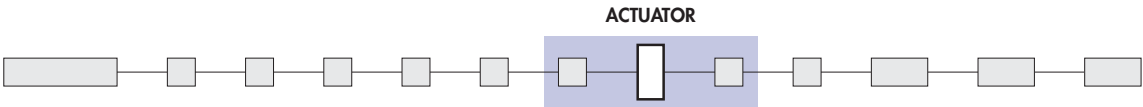

Code	Colour
1	Blue
1/4	Dark blue
2	Black

Code	Colour
3	Green
4	Grey
5	Yellow

Code	Colour
6	Red
7	Ivory
9	Orange

UNLOCKING ACTUATOR COLOUR

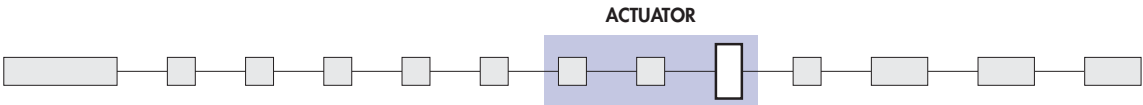

Code	Colour
1	Blue
1/4	Dark blue
2	Black

Code	Colour
3	Green
4	Grey
5	Yellow

Code	Colour
6	Red
7	Ivory
9	Orange

Note : colour 7 not available on illuminated versions

MARKING ORIENTATION

If no marking required, leave box blank.

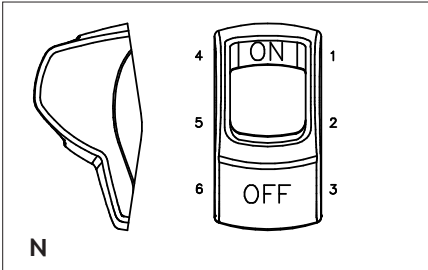
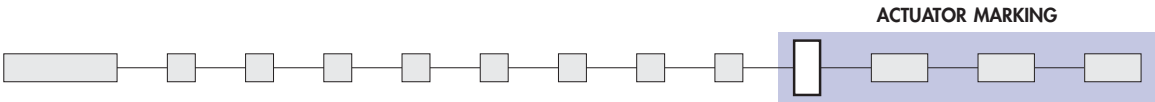

Other orientations : on request

KL series

Locking rocker switches

Marking - Mounting

SYMBOLS

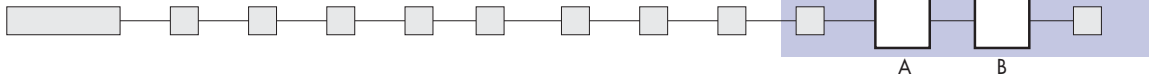

Available symbols : see page 31.

Laser etching resistance

- Water and petrol resistant according to EN61058-1
- Tear resistant (cross-cut test) according to NF ISO 2409 : class 0
- UV resistant according to ISO 4892-2

Marking area - The symbol will be included in the hatched area.

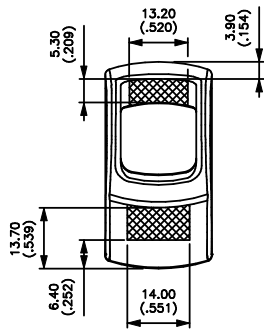
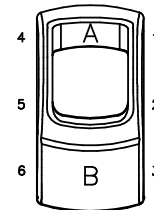

For illuminated versions

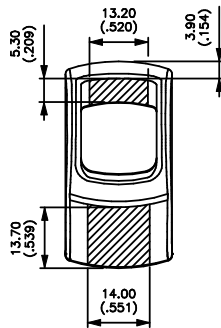

For non-illuminated versions

MARKING COLOUR

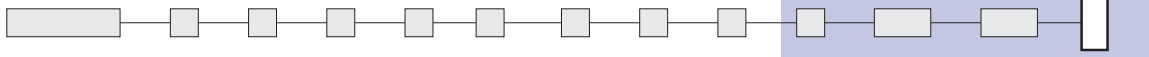

Illuminated models (laser etching)

Blank White

Non-illuminated models (pad printing)

1 : Blue - 2 : Black - 3 : Green - 4 : Grey - 5 : Yellow - 6 : Red - 7 : White - 9 : Orange

SWITCH PANEL CUT-OUT

Panel thickness : 0,8 mm to 4,6 mm

Recommended panel thickness :
between 2 mm and 3,5 mm

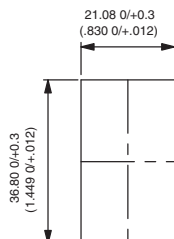

MATRIX MOUNTING

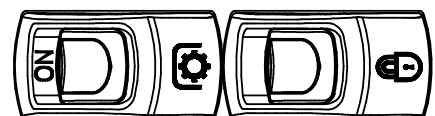
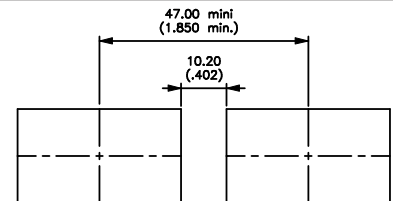
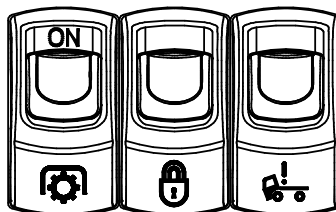
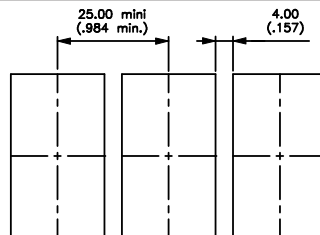



- Wide choice of bezel colours
- Wide choice of LEDs
- Laser etched symbols
- Long life expectancy

ELECTRICAL SPECIFICATIONS

- Operating voltage : 6VDC, 12VDC or 24VDC
- Nominal current : 20mA per LED

ENVIRONMENTAL SPECIFICATIONS

- Degree of protection of sealed versions : frontal sealing to IP68 according to IEC 60529 (submersion under 1 meter of water for more than 30 minutes)
- Salt spray resistance : 96 hours according to IEC 512-6, test 11f
- Operating temperature : -40°C to +85°C

MATERIALS

- Case : ABS
- Bezel : ABS
- Terminals : brass, silver plated

SEALING

Sealing is optional.
To order a sealed product, complete the appropriate box of ordering format on the following pages.

DIMENSIONS

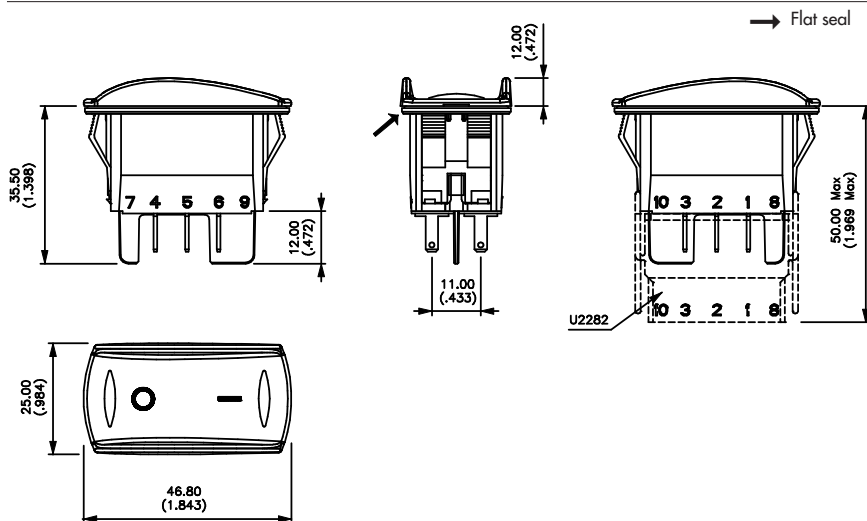

Dimensions : First dimensions are in mm while inches are shown as bracketed numbers.

Tolerance : The general tolerance for dimensions in this brochure is $\pm 0,3$ (.012). Overall dimension tolerance is $\pm 0,5$ (.020).



Packaging unit : 40 pieces

Dimensions, specifications and data shown in this brochure are subject to change without notice.

KI series

LED indicators

Selection guide

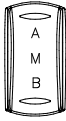
KI		Side A	Side M	Side B			Side A	Side M	Side B		
SERIES	Colours	LEDS			Type of illumination	Symbols	Sealing			Terminals with barrier	
1 Blue 1/4 Dark blue 2 Black 3 Green 4 Grey 5 Yellow 6 Red 9 Orange	X None A LED 6V red B LED 6V green C LED 6V yellow M LED 6V blue R LED 6V white D LED 12V red E LED 12V green F LED 12V yellow N LED 12V blue S LED 12V white J LED 24V red K LED 24V green L LED 24V yellow P LED 24V blue T LED 24V white	X Standard S Super bright		X No K Yes	Marking orientation	C Solder lug / quick-connect F Quick-connect 6,35 J Quick-connect 2,8					
		DC voltage standard									

On request : 48VDC voltage - AC voltage - new design

Symbols : see page 31.

Accessories : see page 34.



NOTICE : please note that not all combinations of above numbers are available. Refer to the following pages for further information.

BEZEL COLOUR

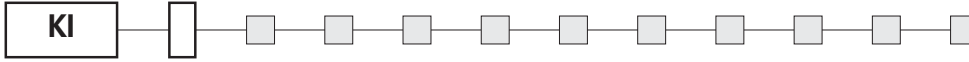

Code	Colour
1	Blue
1/4	Dark blue
2	Black
3	Green

Code	Colour
4	Grey
5	Yellow
6	Red
9	Orange

LEDS

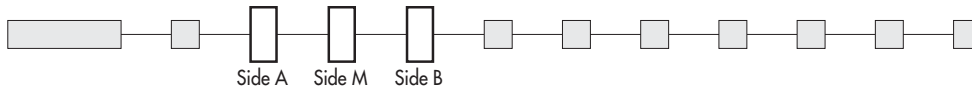

Complete each enlarged box with one of the codes listed below.

X Without LED

	Red	Green	Yellow	Blue	White
6VDC	A	B	C	M	R
12VDC	D	E	F	N	S
24VDC	J	K	L	P	T

LED consumption : 20mA @ nominal voltage (25°C)
Other illumination solutions : on request.

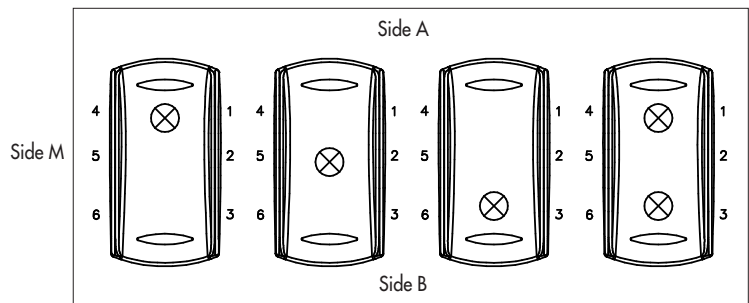

TYPE OF ILLUMINATION

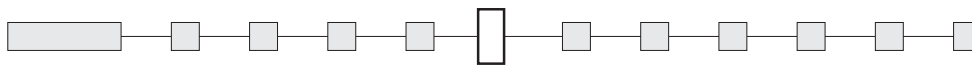

X Standard
S Super bright

MARKING ORIENTATION

If no marking required, leave box blank. Other orientations : on request

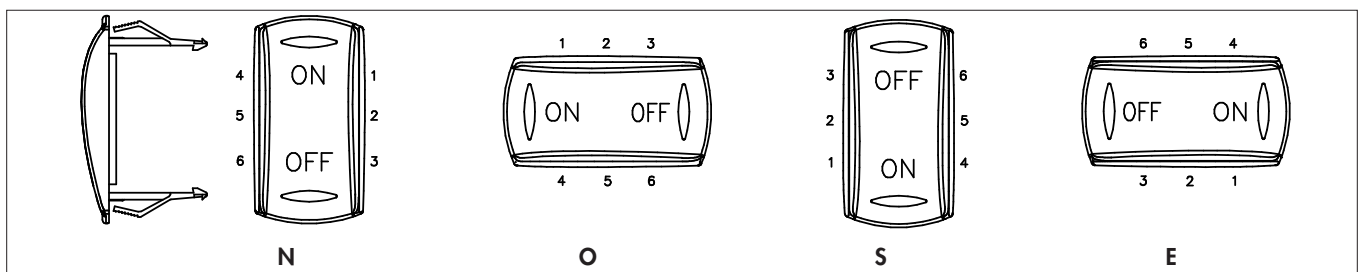
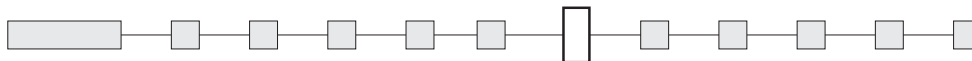

KI series

LED indicators

Marking - Terminals

SYMBOLS

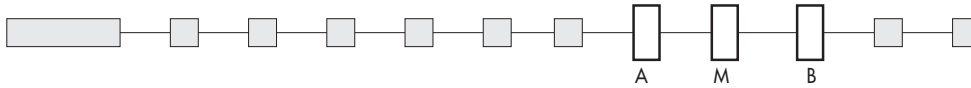

Available symbols : see page 31.

Marking colour

White (laser etching)

Laser etching resistance

- Water and petrol resistant according to EN61058-1
- Tear resistant (cross-cut test) according to NF ISO 2409 : class 0
- UV resistant according to ISO 4892-2

Marking area - The symbol will be included in the hatched area.

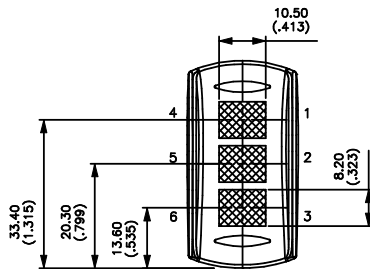
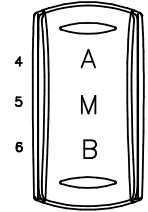

TERMINALS (WITH BARRIER)

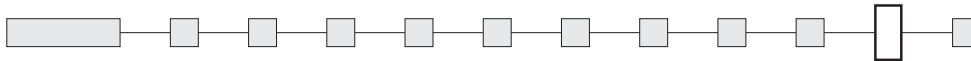

Solder lug / quick-connect

Normalized quick-connect 6,35x0,8

Normalized quick-connect 2,8x0,8

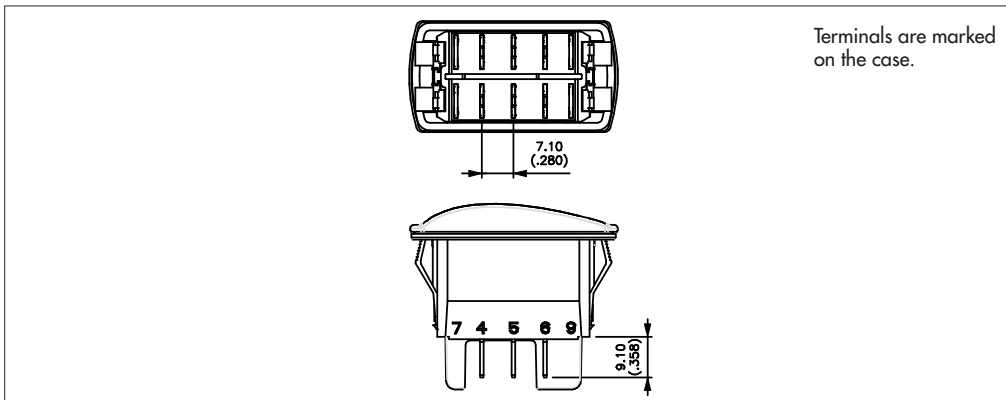
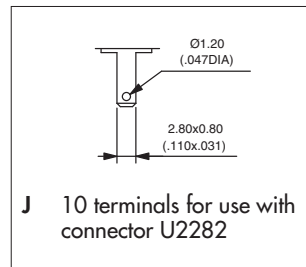
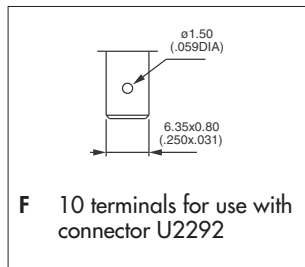
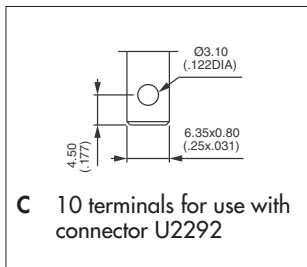

SEALING

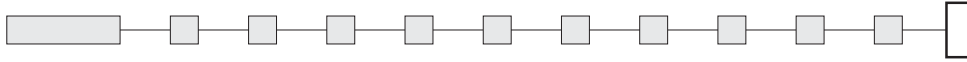

- X No sealing
- K IP68 (switch assembled on panel)

Ultrasonic welding of frame to case is standard on all versions.
The ultrasonic welding and the optional panel seal prevent water and dust from introducing into the switch housing.

*The product shall be installed professionally.
Test conditions available on request.*

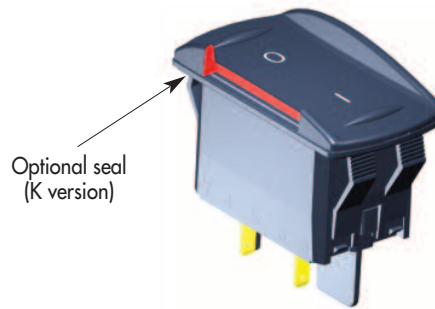

SWITCH PANEL CUT-OUT

Panel thickness : 0,8 mm to 4,6 mm
Recommended panel thickness :
between 2 mm and 3,5 mm

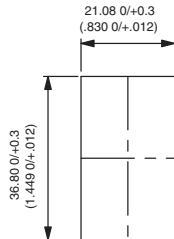

MATRIX MOUNTING

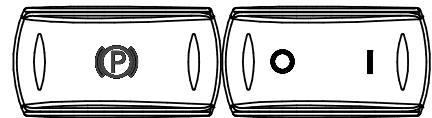
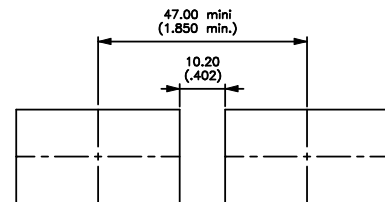
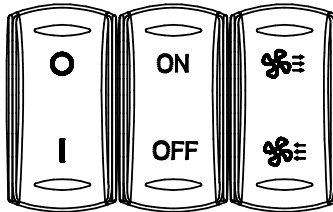
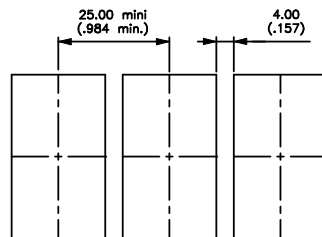

KG series

Power rocker switches

Distinctive features and specifications



- Protected rocker
- Illuminated or non-illuminated
- VDE (EN 61058-1) approved
- Sealed to IP65

ELECTRICAL SPECIFICATIONS

- Current/voltage rating :
 - functions 1 (ON-OFF) and 6 (ON-ON) : 15A 12VDC, 10A 24VDC, 15A 250VAC max., 10mA 14VDC min.
 - functions 4 (ON ON ON) and 4-1R (ON ON MOM) : 8A 12VDC, 5A 24VDC, 8A 250VAC max.
 - other functions : 10A 12VDC, 8A 24VDC, 10A 250VAC max.
- VDE approved ratings : 12(4)A 250VAC, T85/55°C
- Initial contact resistance : 10 mΩ max. at 1A 2VDC
- Insulation resistance : 1.000 MΩ min. at 500VDC
- Dielectric strength : 2.000 Vrms 50 Hz min. between terminals
- Electrical life : 10.000 cycles min.
- Mechanical life : 2 position models : 100.000 cycles min.
3 position models : 30.000 cycles min.

ENVIRONMENTAL SPECIFICATIONS

- Degree of protection : IP65
- Shock resistance : 100 g according to IEC 512-4, test 6c
- Vibration resistance : 10-500 Hz - 10 g according to IEC 512-4, test 6d
- Salt spray resistance : 96 hours according to IEC 512-6, test 11f
- Operating temperature : 2 position models : -40°C to + 85°C
3 position models : -10°C to + 65°C

MATRIX MOUNTING

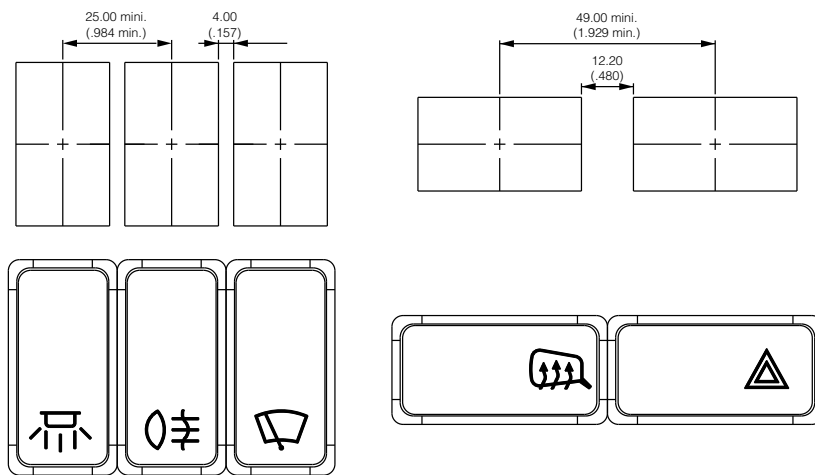

MATERIALS

- Case : thermoplastic UL94-V0
- Terminals : brass, silver plated
- Contacts : silver grain
- Contact roller : brass, nickel plated

AGENCY APPROVAL



EN 61058-1

Availability : double pole models, functions ON-OFF and ON-ON.

Marking : to order switches marked VDE, add "VDE" at the end of model number.

Dimensions : First dimensions are in mm while inches are shown as bracketed numbers.

Tolerance : The general tolerance for dimensions in this brochure is $\pm 0,3$ (.012). Overall dimension tolerance is $\pm 0,5$ (.020).



Packaging unit : 40 pieces

Dimensions, specifications and data shown in this brochure are subject to change without notice.

KG series

Power rocker switches

Case

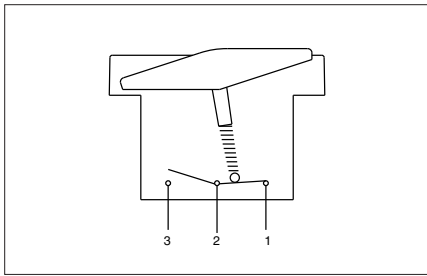

PANEL CUT-OUT

Panel thickness :
0,8 mm to 4,6 mm
Recommended thickness :
between 2 mm and 3,5 mm

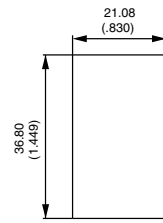

MODEL STRUCTURE

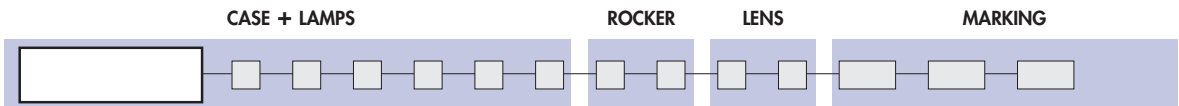

	Single pole	Double pole	2-3	1-2		
	KG31	KG41	5-6	4-5		
						ON - OFF
		KG44*				ON ON ON
	KG35	KG44-1R*				ON ON MOM
	KG36	KG45				MOM - ON
	KG37	KG46				ON - ON
	KG38	KG47				MOM OFF MOM
	KG39	KG48				ON OFF MOM
		KG49				ON OFF ON

* Function 4 : single pole in double pole case

→ Flat seal

TERMINALS

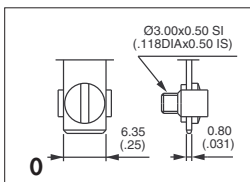
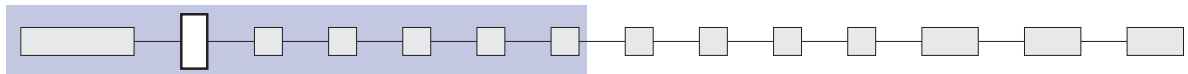

Screw

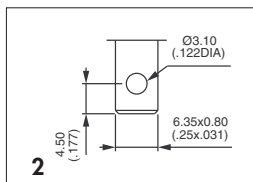

Solder lug / quick-connect

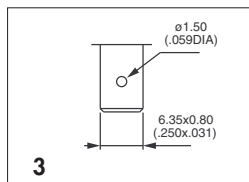

Quick-connect

Terminals 1 to 6 are marked on the case.

Side A : terminals 1 and 4
Side B : terminals 3 and 6

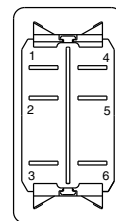

Side A

Side B

CONTACT MATERIALS

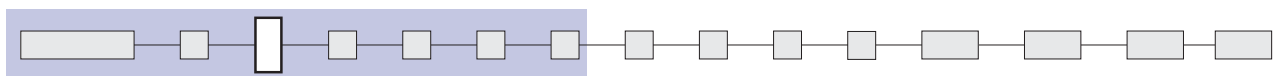

- A Silver grain
Functions ON-OFF and ON-ON : 15A 12VDC , 10A 24VDC , 15A 250VAC max. - 10mA 14 VDC min.
Other functions : 10A 12VDC , 8A 24VDC , 10A 250VAC max.

KG series

Power rocker switches

Lamps

BEZEL

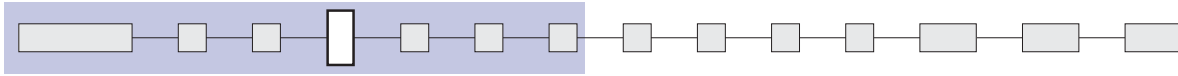

2 Black, sealed to IP65

LAMPS

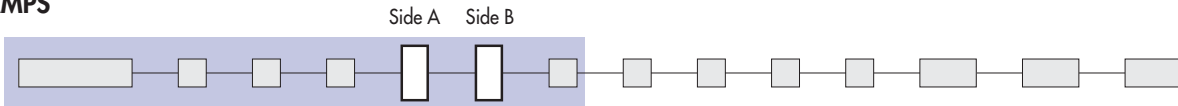

Complete each enlarged box with one of the codes listed below.

X	Without lamp
A	6V LED red
B	6V LED green
C	6V LED yellow
D	12V LED red
E	12V LED green
F	12V LED yellow
G	18V LED red
H	18V LED green
I	18V LED yellow

J	24V LED red
K	24V LED green
L	24V LED yellow
M	Neon 125V
N	Neon 250V
O	Filament 6V
P	Filament 12V
R	Filament 24V
S	Fluorescent 220V
T	Fluorescent 110V

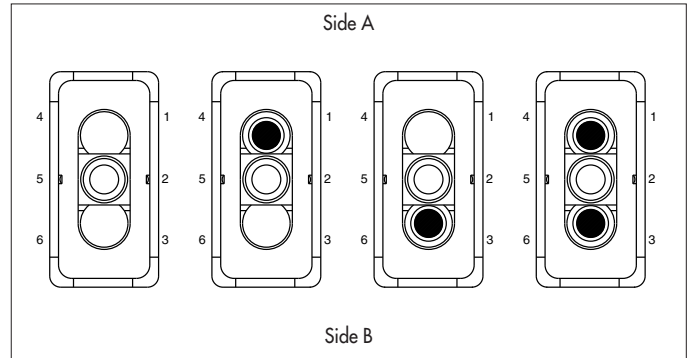

LAMP WIRING

The lamp wiring diagram is shown on the case.

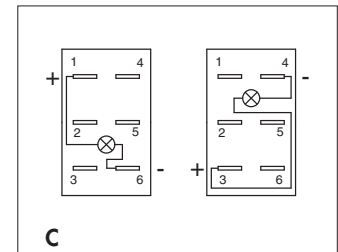
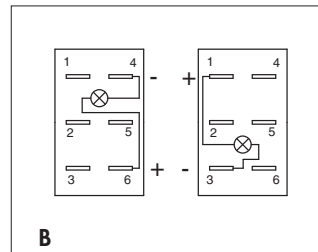
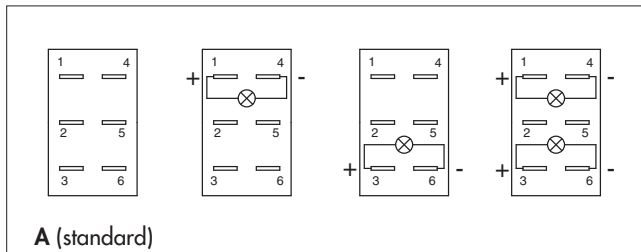
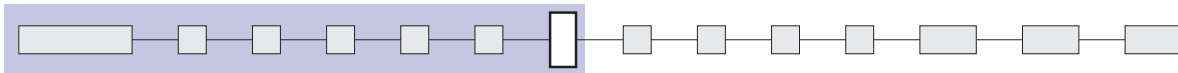

Note : If not available, terminals are added to connect the LED.

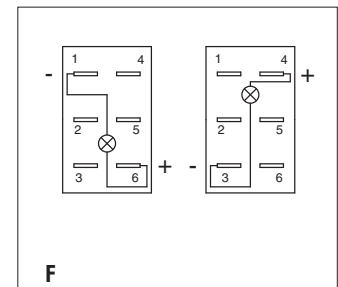
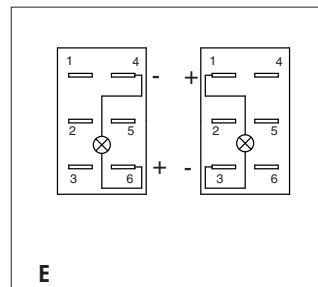
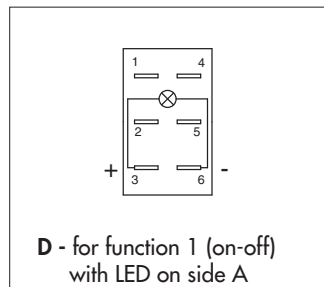

To order case only (without rocker), finish your order number with the lamp wiring code.

KG series

Power rocker switches

Rocker - Lenses

ROCKER COLOUR

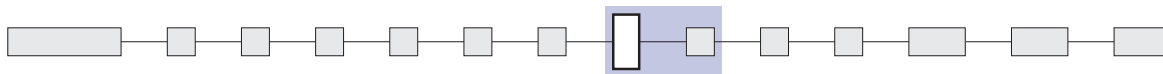

1	Blue
1/4	Dark blue
2	Black
3	Green
4	Grey

5	Yellow
6	Red
7	Ivory
9	Orange

ROCKER SHAPE

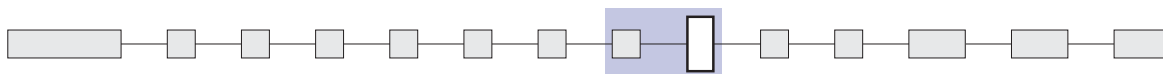

1 Full rocker



4 Opening on side A



6 Opening on side B



8 Opening on sides A and B

Other rocker shapes on customer specifications : on request.

To order rocker only (without case), begin the order number with code KGR, then follow the order format from "rocker colour" until the end of the options.

LENS COLOUR

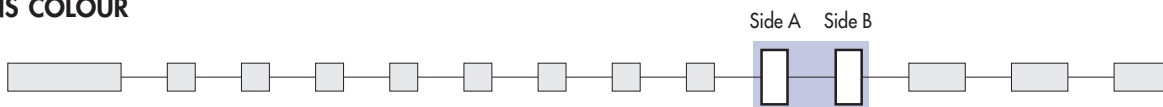

Complete each enlarged box with one of the codes listed below.

X	No lens
1	Blue *
3	Green *
6	Red
9	Orange
B	White
T	Translucent

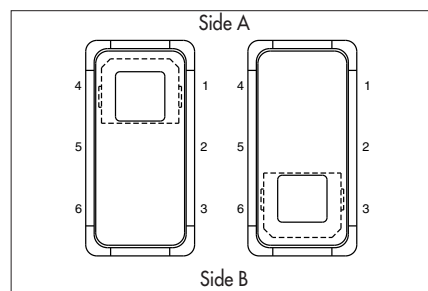
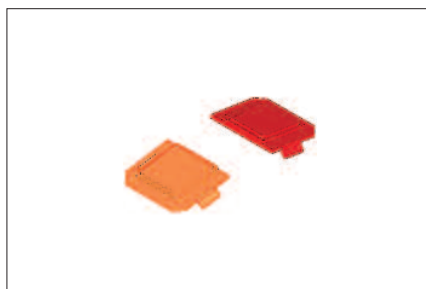

* Blue or green lens recommended with fluorescent lamp.

To order lenses only, begin the order number with the codes :
KGLA for lens A and KGLB for lens B,
then follow the order format from "lens colour" until the end of the options.

KG series

Power rocker switches

Marking

MARKING

If no marking required, leave all boxes blank.

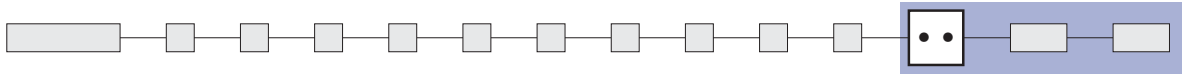

Select one option from each of the tables below.

MARKING METHOD	
C	Hot stamping

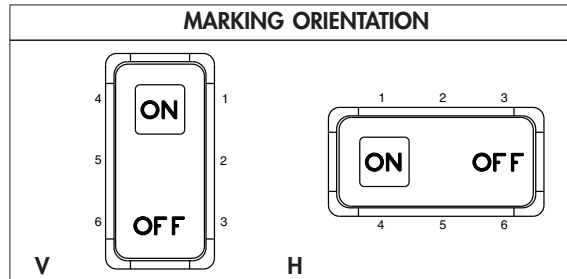

Other orientations :
on request

SYMBOLS

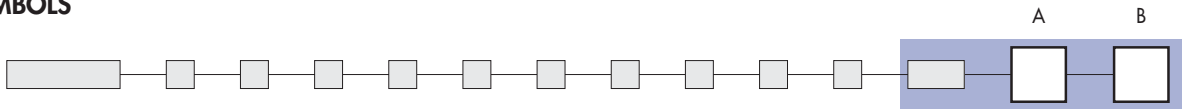

Available symbols : see page 31.

Marking colour

White marking for black rockers - Black marking for colour rockers

Other : on request.

Marking area

For illuminated versions. The symbol will be included in the hatched area.

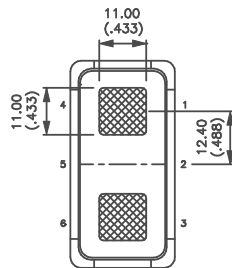
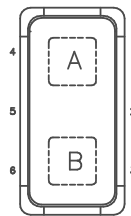























Most symbols meet the ISO 7000 standard "graphical symbols for use on equipments" (code given in bracket in the description). Contact us for symbols not featured in the following tables.















Legend scale :

KR series : 1:1

KL, KG and KI series : depending on space available on the product (see "Symbols" section at the end of each series).

CODE	SYMBOL	DESCRIPTION
XX	None	-
01	ON	-
02	OFF	-
03	O	-
04	I	-
05	II	-
06	STOP	-
07	A	Stop
08	M	Motion
09		Up motion
10		Down motion
11		Hot
12		Cold
13		Hazard warning (0085)
14		Traveller lighting
15		Driver lighting (1421)

CODE	SYMBOL	DESCRIPTION
16		Revolving light
17		Rear ventilator
18		Heating (0637)
19		Door opening
20		Windshield demister/defroster (0635)
21		Windshield wiper (0086)
22		Windshield washer (0088)
23		Ventilator fan (0089)
24		Side mirror defroster
25		Restarting pump
26		Front fog lights (0633)
27		Rear fog lights (0634)
28		Propulsion system trim
29		Beacon (1141)
30		Anchor
31		Electric motor (0011)

CODE	SYMBOL	DESCRIPTION
32		Emergency first aid vehicle (2565)
33		Load tipping (1557)
34		Loading light (2457)
35		Tractor, rear-ward (0089)
36		Combine, direction of movement (1678)
37		Use no forks (2406)
38		Transmission (1166)
39		Working spot light (1145)
40		Engine (0634)
41		Horn (0244)
42		Lock (1656)
43		Taxi sign light (2551)
44		Working light (1024)
45		Working light symmetric (1024)
46		-
47	ASM	-

K range

Power rocker switches and indicators















Symbols













Most symbols meet the ISO 7000 standard "graphical symbols for use on equipments" (code given in bracket in the description). Contact us for symbols not featured in the following tables.













Legend scale :

KR series : 1:1

KL, KG and KI series : depending on space available on the product (see "Symbols" section at the end of each series).

CODE	SYMBOL	DESCRIPTION
48		All wheel drive
49		Differential lock (1662)
50		-
51		-
52		-
53	N	-
54		Rear window wiper (0097)
55		Rear window washer (0099)
56		Lower load (2223)
57		Cab lock (1560)
58		Extraction
59		Pumping in
60		Rear PTO (1572)
61		Front PTO
62		Rockshaft down
63		Rockshaft up

CODE	SYMBOL	DESCRIPTION
64		Indicator
65		Brake release
66		Baggage room left door
67		Baggage room right door
68		Power blinds
69		Engine idle control
70	CRUISE RES/SET	Cruise res/set
71		Driver windows up/down
72		Middle door opening
73		Front door opening
74		Lighting in baggage room
75	CRUISE ON/OFF	Cruise on/off
76	TV	TV
77		Pump
78	WC	Toilet
79		Toilet decontamination

















CODE	SYMBOL	DESCRIPTION
80		Front windshield heating
81	AUS	Aus
82		Radiator fan
83		Remove retarder
84		Restricted speed
85		Preheater
86		ABS detection
87		ECAS detection
88		Engine stop
89	CRUISE RES/CAN	Cruise res/cancel
90		ECAS reset
91		Driver windows heating
92	CRUISE SET+/SET-	Cruise set
93		Air bag up/down
94		Read lighting
95		Lighting main switch

















Most symbols meet the ISO 7000 standard "graphical symbols for use on equipments" (code given in bracket in the description). Contact us for symbols not featured in the following tables.





Legend scale :

KR series : 1:1

KL, KG and KI series : depending on space available on the product (see "Symbols" section at the end of each series).

CODE	SYMBOL	DESCRIPTION
96		Heating using water
97		Low beam
98		Position lights
99		Diesel acceleration
A1		Manual mode
A2		Clockwise cabin rotation
A3		Anticlockwise cabin rotation
A4		-
A5		-
A6		Parking brake
A7		-
A8		-
A9		-
AA		-
AB		-
AC		-

CODE	SYMBOL	DESCRIPTION
AD		-
AE		-
AF		-
AG		Battery charging condition (0247)
AH		Turn signals (0084)
AJ		High beam (0082)
AK		Differential lock, bogie (2600)
AL		Brushing with a rotating brush (0070)
AM		Differential lock, transfer case 4x4 (2475)
AN		Loader bucket, float (1441)
AP		Loader bucket (1437)
AQ		Rear window washer & wiper (0098)
AR		Header drive (1579)
AS		Excavator/backhoe boom side shift (2091)
AT		Chemical water treatment (1851)
AU		Grapple skidder, single function boom (1762)

CODE	SYMBOL	DESCRIPTION
AV		-
AW		-
AY		-
AZ		-
B1	HIGH	-
B2	LOW	-
B3		-

K range

Power rocker switches and indicators

Accessories for KR, KL and KI series

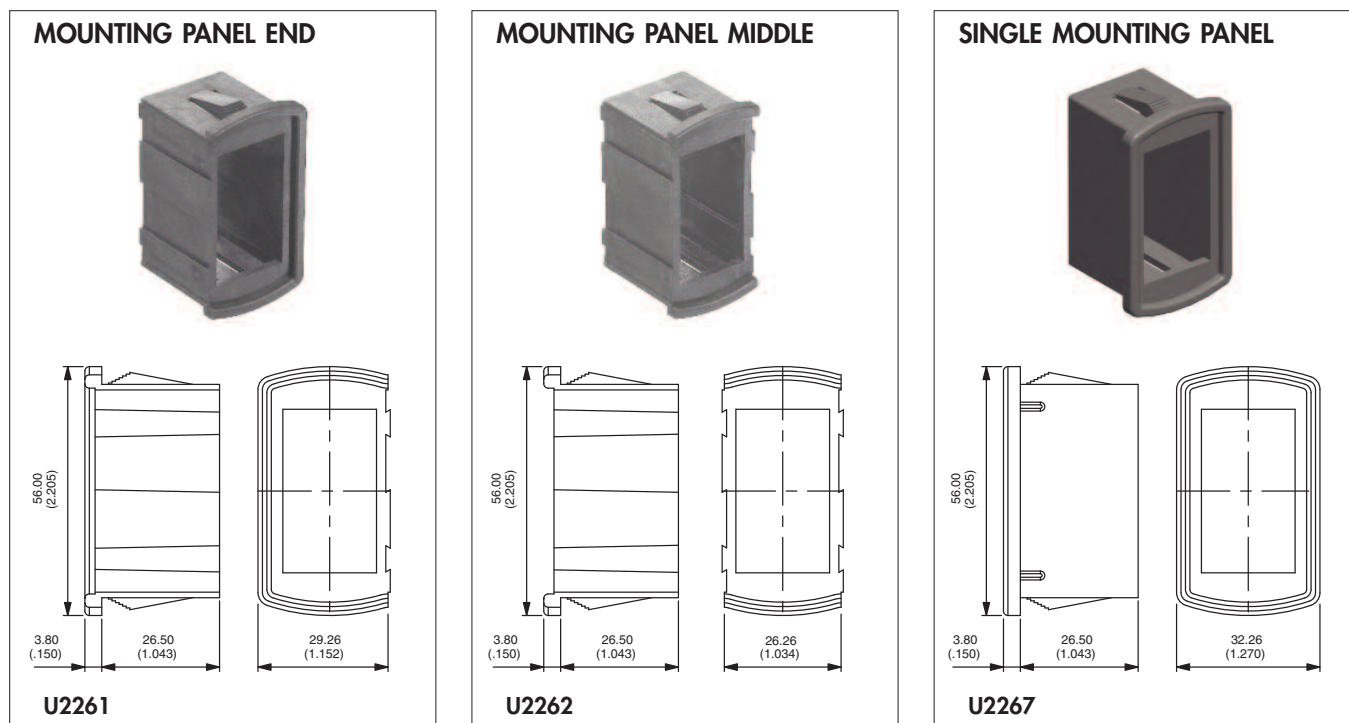

Recommended panel thickness : 1,10 mm - 1,80 mm - 2,60 mm - 3,40 mm - 4,20 mm - 5 mm - 5,80 mm

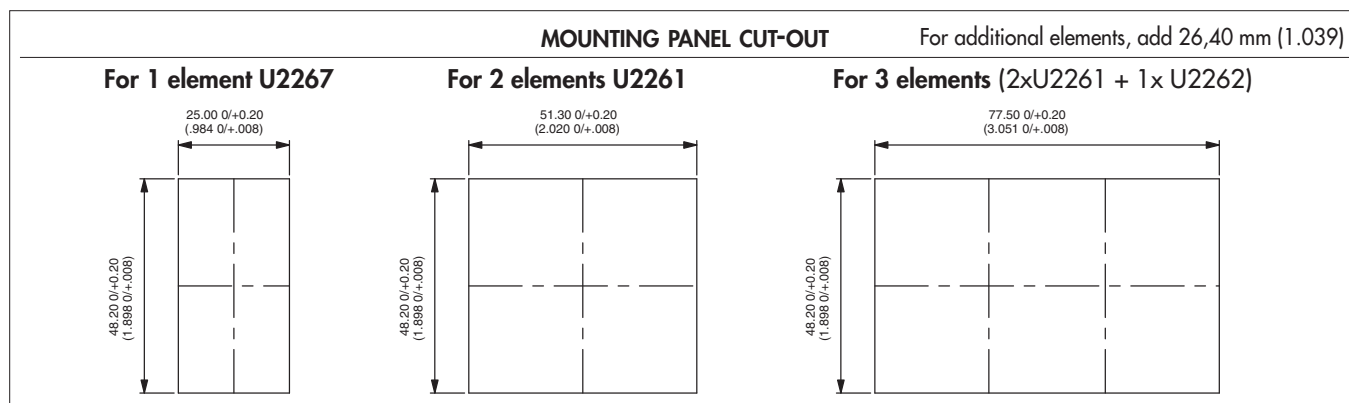

For additional elements, add 26,40 mm (1.039)

ACTUATOR REMOVING TOOL



EXTRACT ACTUATOR (KR ONLY)

Allows the extraction of the rocker / rocker support assembly.
Place the 2 claws under the support and push as indicated by the arrow.

EXTRACT ROCKER (KR ONLY)

Allows to separate the rocker from its support.
Insert the tool between rocker and support as indicated by the arrow. Pull out the tool in the opposite direction.

EXTRACT SWITCH (KR, KL AND KI)

Allows to extract switch from panel mounting units. 2 tools are necessary.
Insert the tools between switch and panel mounting units from the rear to compress the snap-in device. Pull off switch manually.

2 tools are supplied

K range

Power rocker switches and indicators

Accessories for KR, KL and KI series

CONNECTORS

Standard colour : black. Other colours : on request.
Connectors cannot be combined with wiring types H and I.

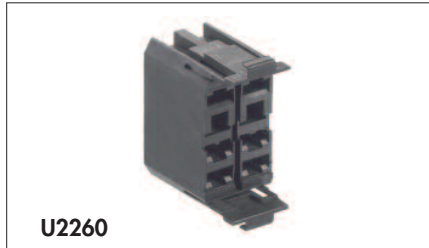

U2260

6 terminal version

For use with terminals type 2, 3, 4 or 5.
6,35 (1/4) tabs to be fitted by the user
(example : AMP/Tyco 0-0141013-2).
Can be used for the KG series.

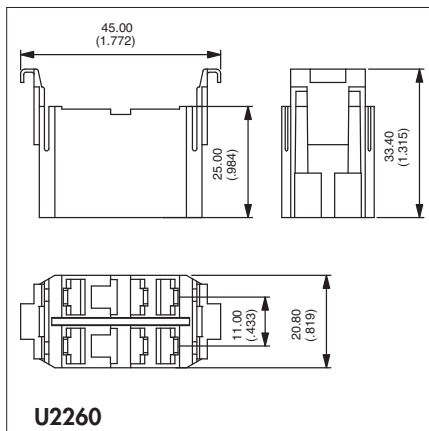

U2260



U2282

10 terminal version

For use with terminals type H or J.
2,8 (.110) tabs to be fitted by the user
(example : AMP/Tyco 0-927779-3).

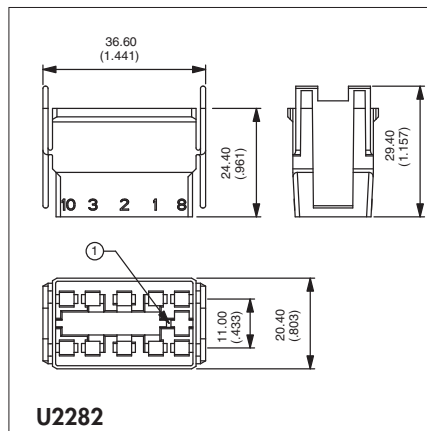

U2282

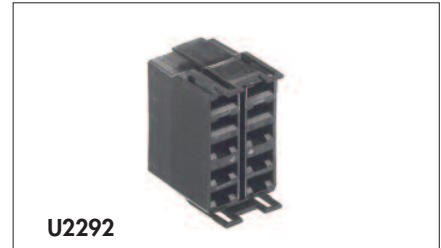

U2292

10 terminal version

For use with terminals type B, C, E or F.
6,35 (1/4) tabs to be fitted by the user
(example : AMP/Tyco 0-0141013-2).

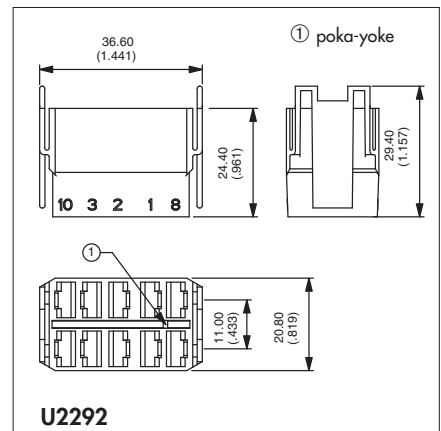

U2292

HOLE PLUGS

Usefull for future extensions.

Code	Colour	Code	Colour
U2271	Blue	U2274	Grey
U2271/4	Dark blue	U2275	Yellow
U2272	Black	U2276	Red
U2273	Green	U2277	Ivory
		U2279	Orange

Recommended panel thickness :
1,50 mm to 6 mm

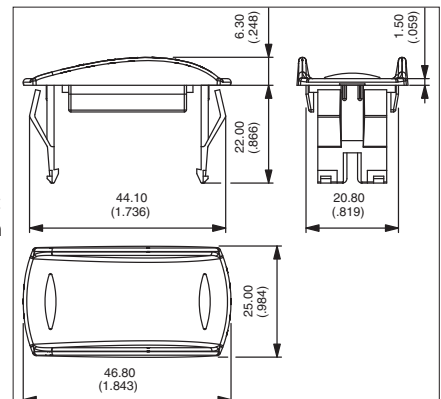

Connectors can be hanged on specific hole plugs. Contact APEM.

APEM, a world of switching capabilities

The APEM group is one of the world's largest manufacturers of switches, switch panels and joysticks.

APEM designs, develops, manufactures and sells electro-mechanical components to multiple industrial markets including: instrumentation, medical, security, communications, industrial automation, avionics, military and transport.

Other APEM embedded products



■ " I " range of pushbuttons

This range consists of several series of IP67 sealed pushbuttons (IP, IB, IS, IF, IA) and a large variety of models: round or square, momentary or latching, illuminated or non-illuminated, plastic or metallic, with optional marking.



■ Specific switch panels

In addition to the switching function, specific switch panels incorporate several other functions such as illumination by LED, backlighting, EMC protection, sealing, connection, support, mounting...

Applications for these products include transport and utility vehicles, agricultural engines and boats.



■ Joysticks

APEM also manufactures joysticks for professional applications. Easy to operate, reliable and designed for extremely long service life, APEM joysticks are offered with a wide range of options allowing to satisfy a large variety of requirements. Several series are available, each one based on a different technology: switch joysticks, potentiometer joysticks and contactless joysticks.



A P E M

Addresses of sales subsidiaries and distributors network on
www.apem.com