

QA4/PBA4

Microswitch Push Button

Momentary

QA4/PBA4

Panel cut-out (mm) \varnothing 6.1

- Characteristics
- for use with V4N/V4NC series
 - long overtravel up to 5 mm
 - simple clip-on attachment
 - round or square bezels
 - push button options

Rating 250 VAC, 5 A

Dimensions (mm) 20 × 6.45 × 38.3

- Actuator
- stainless steel plunger
 - polyamide (PA 6.6) plunger

Approvals UL, CSA

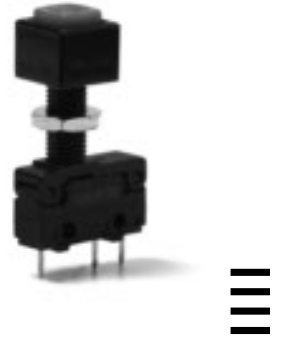

Preferred Range

Ordering Reference	Basic switch	Button	Bezel	Sealing kit	Actuator kit
V4NCT7		PBRR	BZR	PBSLK	QA4

Specifications

Clip-on frame	Glass fibre reinforced polyamide (PA 6.6)
Bezel	ABS polymer - black (PBA4 only)
Cowl	Synthetic rubber (PBA4 only)
"O"-Ring	Nitrile (PBA4 only)
Locknut	Brass nickel plate
Button/Plunger	ABS polymer (PBA4) Stainless steel (QA4)
Basic switches	V4NC (see pages 52 to 55)
Temperature range °C	-10°C to +85°C
Mechanical Life	5 × 10 ⁶ cycles minimum (Mechanism 2 × 10 ⁶ cycles minimum) (Impact free actuation)
Mounting mm (in)	Single hole ∅ 6.4 (0.25) suitable for panels up to 8.0 (0.3) thick
Torque max. Nm	0.4 to be applied to locknut

Dimensions QA4

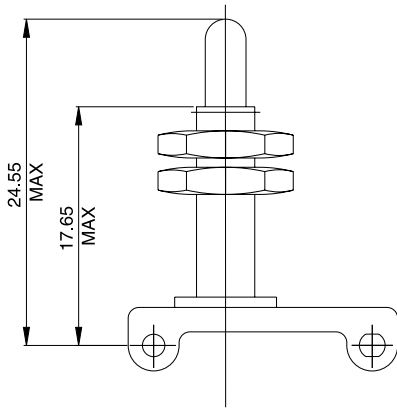

PBA4

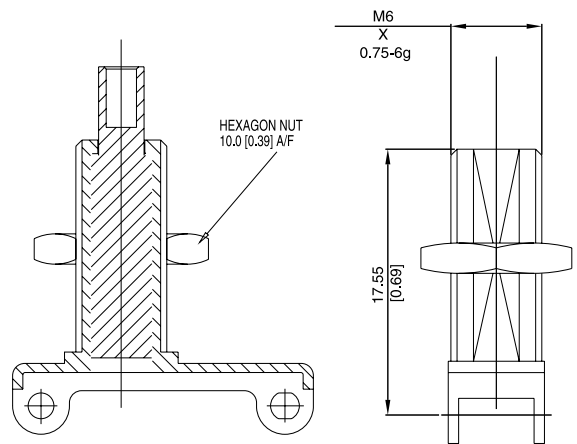

Configuration

Basic switch V4NC... See pages 52 to 55
 V4N... See page 56 to 59

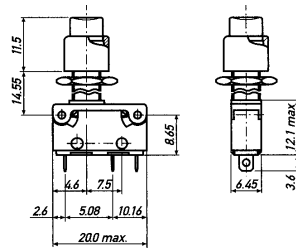

Type coding key for standard products

Actuator kit PB without insert switch, button or bezel
PB-clip-on assembly round or square bezels

Example: PBA4 PBR RED V4N

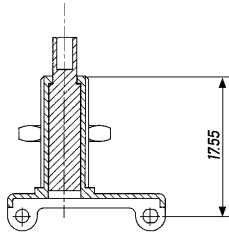

A4 Actuator kit only
AS4 Sealed actuator kit only

Accessories can be ordered separately using bracketed references

- (PB)R Round Button (complete with bezel)
- (PB)S Square Button (complete with bezel)
- (B)ZR Round Bezel
- (B)ZS Square Bezel
- (PB)SLK Sealing Kit (complete with button & bezel)

Round button
Round bezel

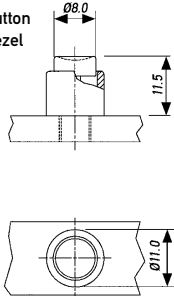

Square button
Square bezel

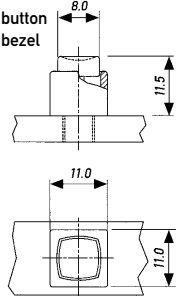

PBSLK

Sealing kit (O-ring and diaphragm)
Bezel and button can be ordered separately

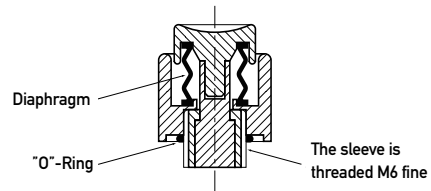

- Button Colours
- RED (R when ordered complete with Insert switch)
 - YELLOW (Y when ordered complete with Insert switch)
 - GREEN (G when ordered complete with Insert switch)
 - BLUE (BU when ordered complete with Insert switch)
 - BLACK (B when ordered complete with Insert switch)
 - WHITE (W when ordered complete with Insert switch)

Example reference V4NT7PBSR is a V4NT7 (basic switch, p. 59) with PBS (square button complete with bezel) and a RED button

Special Features /

Saia-Burgess specialise in customer specific solutions. Additional product variants are available or can be provided. If your requirements cannot be satisfied from the options listed, please contact www.saia-burgess.com or your local SB outlet.



Type coding key for standard products

Actuator kit QA4

without insert switch

Example: QA4 QV4NCT7

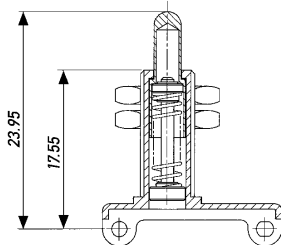

With insert switch

Q followed by switch reference
 V4NC... See pages 52 to 55
 V4N... See pages 56 to 59
 Example reference: QV4NCT7

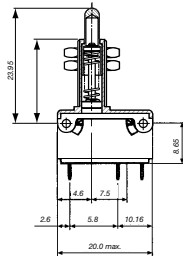

Special Features /



Saia-Burgess specialise in customer specific solutions.
 Additional product variants are available or can be provided.
 If your requirements cannot be satisfied from the options listed,
 please contact www.saia-burgess.com or your local SB outlet.