

RAFIX 16

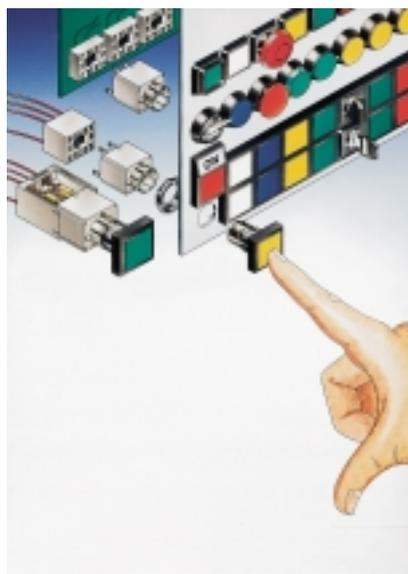

General data

RAFIX 16 control component range

- For a mounting hole diameter of 16.2 mm to IEC 60947
- 250V/6A max.
- Water-jet proof IP65
- Contact blocks: Gold and silver contacts with quick-connect terminals 2.8 x 0.8 mm; Option: PCB plug-in socket
- 3 collar shapes, low-profile design
- The lamps of the pushbuttons can be replaced from the front or rear.
- The contact blocks snap directly onto the actuators without a coupling element and can be easily removed by turning = cost reducing assembly.

The specified data apply only if actuators/signal indicators are combined with contact blocks and lamp sockets within the same product range.

Content

RAFIX 16 pushbutton	2 - 8
RAFIX 16 pushbutton, flush lens, square collar	2 - 9
RAFIX 16 pushbutton, protruding lens, square collar	2 - 10
RAFIX 16 pushbutton, protruding collar, square collar	2 - 11
RAFIX 16 pushbutton, flush lens, round collar	2 - 12
RAFIX 16 pushbutton IP66 with protective cap	2 - 13
RAFIX 16 pushbutton, protruding lens, round collar	2 - 14
RAFIX 16 pushbutton, protruding collar, round collar	2 - 15
RAFIX 16 pushbutton, flush lens, square collar, alignable without gaps	2 - 16
RAFIX 16 selector switch	2 - 18
RAFIX 16 selector switch, square collar	2 - 19
RAFIX 16 selector switch, round collar	2 - 20
RAFIX 16 selector switch, square collar, alignable without gaps	2 - 21
RAFIX 16 keylock switch MICROMECC	2 - 22
RAFIX 16 keylock switch MICROMECC, square collar	2 - 23
RAFIX 16 keylock switch MICROMECC, round collar	2 - 24
RAFIX 16 keylock switch MICROMECC, square collar, alignable without gaps	2 - 25
RAFIX 16 keylock switch, RONIS	2 - 26
RAFIX 16 keylock switch, RONIS, square collar	2 - 27
RAFIX 16 keylock switch, RONIS, round collar	2 - 28
RAFIX 16 keylock switch, RONIS, square collar, alignable without gaps	2 - 29
RAFIX 16 mushroom-headed pushbutton	2 - 30
RAFIX 16 mushroom-headed pushbutton, square collar	2 - 31
RAFIX 16 mushroom-headed pushbutton, round collar	2 - 31
RAFIX 16 mushroom-headed pushbutton, square collar, alignable without gaps	2 - 32
Control components	2 - 3

Stock items are marked
by **bold printed** order numbers.

RAFIX 16 emergency stop pushbutton	2 - 34
RAFIX 16 emergency stop pushbutton, square collar, illuminated	2 - 35
RAFIX 16 emergency stop pushbutton, square collar, dupe-proof	2 - 35
RAFIX 16 emergency stop pushbutton, round collar, illuminated	2 - 36
RAFIX 16 emergency stop pushbutton, round collar, dupe-proof	2 - 36
RAFIX 16 emergency stop pushbutton, square collar, alignable without gaps, illuminated	2 - 37
RAFIX 16 emergency stop pushbutton, square collar, alignable without gaps, dupe-proof	2 - 37
RAFIX 16 safety emergency stop pushbutton, round collar, dupe-proof, non-blocking	2 - 38
RAFIX 16 safety emergency stop pushbutton, round collar, conical, dupe-proof, non-blocking	2 - 38
RAFIX 16 toggle switch	2 - 40
RAFIX 16 toggle switch, square collar	2 - 41
RAFIX 16 toggle switch, round collar	2 - 41
RAFIX 16 toggle switch, square collar, alignable without gaps	2 - 42
RAFIX 16 potentiometer drive	2 - 44
RAFIX 16 potentiometer drive, square collar	2 - 45
RAFIX 16 potentiometer drive, round collar	2 - 45
RAFIX 16 potentiometer drive, square collar, alignable without gaps	2 - 46
RAFIX 16 buzzer	2 - 48
RAFIX 16 buzzer, square collar	2 - 49
RAFIX 16 buzzer, round collar	2 - 49
RAFIX 16 buzzer, square collar, alignable without gaps	2 - 50
RAFIX 16 signal indicator	2 - 52
RAFIX 16 signal indicator, square lens	2 - 53
RAFIX 16 signal indicator, square collar, flush lens	2 - 53
RAFIX 16 signal indicator, square collar, protruding lens	2 - 54
RAFIX 16 signal indicator, round lens	2 - 54
RAFIX 16 signal indicator, round collar, flush lens	2 - 55
RAFIX 16 signal indicator, round collar, protruding lens	2 - 55
RAFIX 16 signal indicator, square collar, alignable without gaps, flush lens	2 - 56
RAFIX 16 signal indicator, square collar, alignable without gaps, protruding lens	2 - 56
RAFIX 16 contact blocks with gold contacts	2 - 58
RAFIX 16 standard contact block, gold contacts, with lamp socket	2 - 60
RAFIX 16 standard contact block, gold contacts, without lamp socket	2 - 60
RAFIX 16 universal contact block, gold contacts, with lamp socket	2 - 61
RAFIX 16 universal contact block, gold contacts, without lamp socket	2 - 61
RAFIX 16 contact blocks with silver contacts	2 - 62
RAFIX 16 standard contact block, silver contacts, with lamp socket	2 - 64
RAFIX 16 standard contact block, silver contacts, without lamp socket	2 - 64
RAFIX 16 universal contact block, silver contacts, with lamp socket	2 - 65
RAFIX 16 universal contact block, silver contacts, without lamp socket	2 - 65
RAFIX 16 lamp socket	2 - 66
RAFIX 16 lamp socket W 2 x 4.6 d	2 - 67
RAFIX 16 lamp socket W 2 x 4.6 d	2 - 68
RAFIX 16 special accessories	2 - 70
PCB plug-in socket	2 - 70
Multipole connector	2 - 71
Female quick-connect terminal DIN 46340-B 2.8-1-MS	2 - 71
Plug distributor	2 - 72
Protection against contact	2 - 72
Protection against contact	2 - 73
Series capacitor	2 - 73
Disassembly tool	2 - 74
Protective cover, suitable for lead seal, for pushbuttons, alignable without gaps	2 - 74
Fixing spanner for hexagon nut	2 - 75
RAFIX 16 insulating housing	2 - 75
RAFIX 16 label holder, flush, for square collar	2 - 76
RAFIX 16 label holder, flush, for round collar	2 - 76
RAFIX 16 label holder, protruding, for square flush fitting collar	2 - 77
Emergency stop label, yellow, round 60 mm, PVC adhesive	2 - 77

General information

RAFIX 16 is a complete control component series for a mounting hole diameter of 16.2 mm. It enables you to design attractive control panels with a minimum of space requirements and at the same time sufficiently large actuating areas.

Actuators

- Mounting hole \varnothing 16.2 mm to DIN EN 50 007

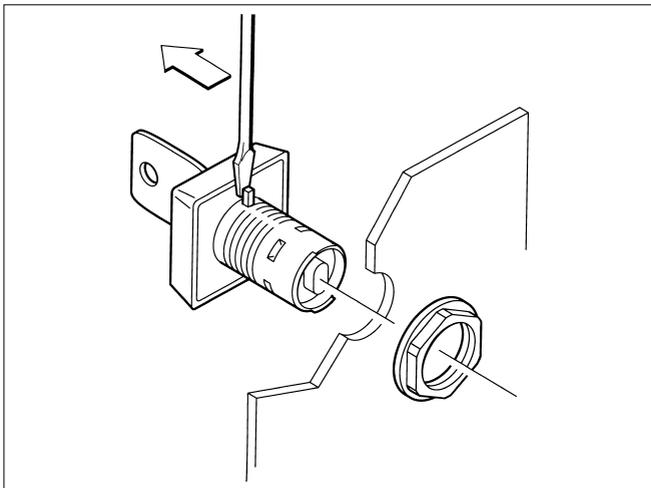
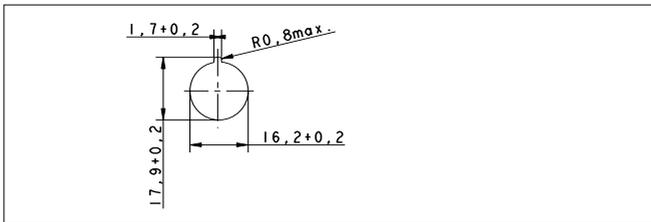

- Locating lug (easily removable).
The locating lug can be easily removed using a screwdriver.
- Degree of protection IP 65 on panel.
This is achieved by a reliable, tried and tested special seal.
- Grid spacing 25 x 25 mm
- Low-profile design, 7 mm height from front panel
- Three collar shapes, in black
 - Square 25 x 25 mm
 - Round 25 mm
 - Square 25 x 25 mm, alignable in flush fitting rows, which avoids accumulation of dirt between the collars.

Contact blocks

- Standard (for actuators with one-way operation)
 - with latching mechanism (latching switch)
 - without latching mechanism (momentary switch)
- Universal (for actuators with two-way operation, e. g. selector switches)
 - without latching mechanism

Contact material

- Silver contacts for mains voltage
- Gold contacts for electronic circuits

Illumination

- Wedge base lamp W 2 x 4.6 d

Assembly

- Single-handed cost-effective assembly method
- Panel thickness 0.5 ... 5 mm
- Fixing with hexagon nut
- Starting torque 1.2 Nm max.

Shock-resistance according to IEC 600 68-2-27

- Shock amplitude: \leq 50 g
- Shock time: 11 ms
- Shock type: half sinusoidal

Environment conditions

- Constant environment: acc. to IEC 600 68-2-3 and 2-30
- Variable environment: acc. to IEC 600 68-2-14 and 2-33

Temperature range

- Operating temperature:
 - non-illuminated: - 25 ... + 70 ° C
 - illuminated: - 25 ... + 55° C
- Storage temperature: - 40 ... + 85° C

CE-Conformity RAFX® 16

Combination actuator and contact block	Order no.	Limit	EU-Directive	
			NSR 73/23	Ma. Dir. 89/392
All actuators All contact blocks with silver contacts	1.3007-.-.- 1.2012-.-.-	6(4) A/250 V AC	●	–
Emergency stop Contact blocks with silver contacts	1.30074.-.- 1.20123.-.-	6(4) A/250 V AC	●	●
Emergency stop, Universal contact blocks with gold contacts	1.30074.-.- 1.20123.-.-	250 mA/42 V AC/DC	–	●
Signal indicator lamp socket	1.62124.-.- 1.71212.-.-	1,2 W/60 V AC/DC	●	–

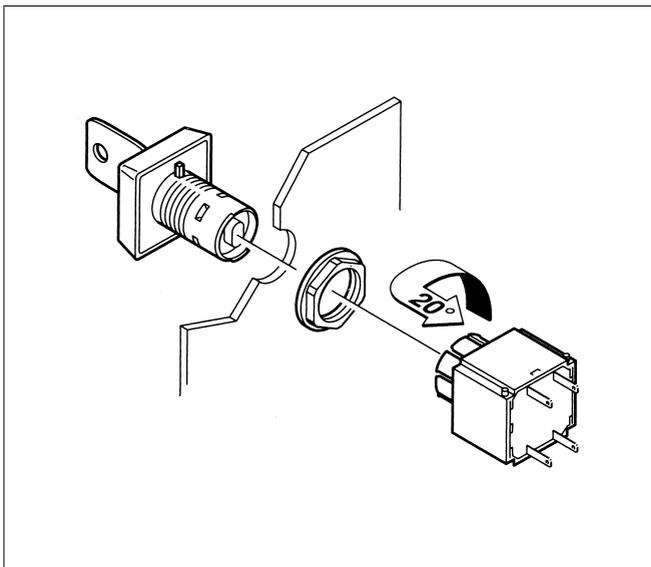
2RAFIX
16

Assembly/Disassembly

Assembly

- Insert the actuator through the panel cut-out from the front.
If there is no locating indent provided in the cut-out, first remove the locating lug using a screwdriver.
- Screw the hexagon nut onto the actuator or signal indicator from the rear and tighten it using a fixing spanner.
- Slide the contact block onto the actuator from the rear with an audible click.
- Install protection against accidental contact, if applicable.
- Connect quick-connect terminals.
- Alternatively, connect crimped female quick-connect terminals to multipole connector and plug it onto the contact block.
- Alternatively, connect the plug-in socket soldered onto

Disassembly

- Turn the contact block by approx. 20° to the left or right – the latches open.
 - Pull the contact block off towards the rear (commercially available flat nose pliers recommended).
- To dismount a PCB, pull the PCB with the soldered plug-in sockets off the mounted contact blocks.

RAFIX 16

Legending

All elements can be labelled using a separate label holder. The label holder is mounted together with the actuator/signal indicator. For order numbers and standard legend, refer to the section "Legending". Non-illuminated pushbuttons and mushroom-headed pushbuttons can be printed or laser engraved.

All illuminated pushbuttons and the majority of the signal indicators can be labelled by means of legend inserts. The legend inserts are fitted between actuator body and lens and can be easily changed.

Rafi can also provide you custom legending. Price and delivery on request.

Lamp replacement from front

Use the disassembly tool to grasp the actuator body and pull it towards the front with the lens.

Alternatively, you can use a screwdriver in place of the disassembly tool. In this case, insert the screwdriver between actuator body and collar and carefully raise the actuator body.

Replace the lamp using a lamp extractor or a suitable insulation sleeve.

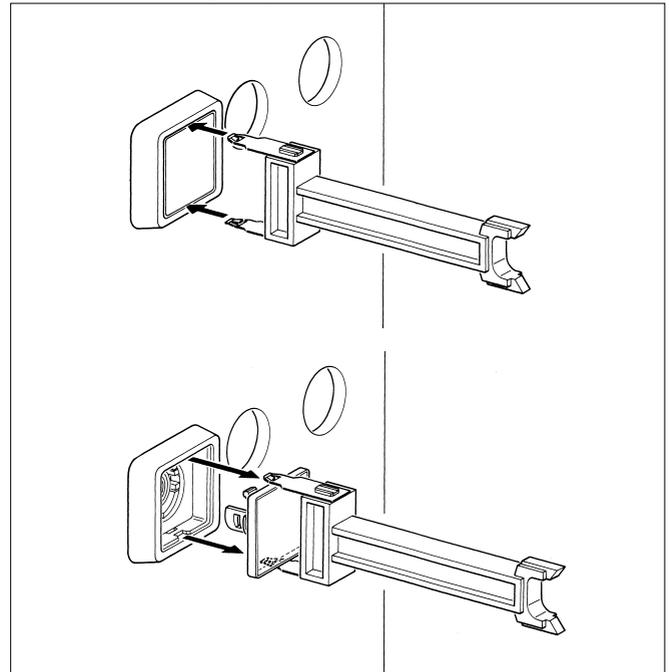

Lamp replacement from front

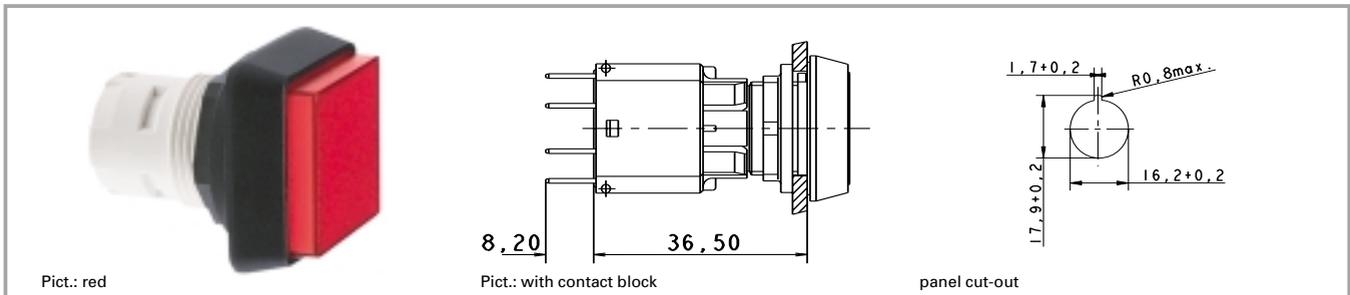
RAFIX 16 pushbutton**2****Technical data****General information**

Form of lens	see order block
Colour of lens	see order block
Form of collar	see order block

Dimensions

Length of collar	see order block
Diameter of collar	see order block
Key grid	25 x 25 mm
Width of collar	see order block
Overall height	see order block
Mounting depth	44.7 mm
Mounting hole	16.2 mm

Mechanical design

Mounting	ring nut
Contact function	according to contact block
Contact arrangement	according to contact block
Illuminability	see order block

Mechanical characteristics

Operating travel	3 mm
Robustness min.	100 N

Other specifications

Operating life	2000000
Degree of protection from front side	IP65
Ambient temp. operating min.	-25 °C
Ambient temp. operating without lamp max.	+70 °C
Storage temperature min.	-40 °C
Storage temperature max.	+85 °C
Resistance to constant environment	according to IEC 600 68-2-3 and 2-30
Resistance at variable environment	according to IEC 600 68-2-14 and 2-33

Accessories RAFIX 16 pushbutton

Description	Photo	Order no.	Page
RAFIX 16 standard contact block, 1 NC + 1 NO, momentary, silver contacts, with lamp socket		1.20.122.001/0000	2 - 64
RAFIX 16 standard contact block, 1 NC + 1 NO, momentary, gold contacts, with lamp socket		1.20.122.011/0000	2 - 60
RAFIX 16 standard contact block, 1 NC + 1 NO, momentary, silver contacts, without lamp socket		1.20.122.021/0000	2 - 64
RAFIX 16 standard contact block, 1 NC + 1 NO, momentary, gold contacts, without lamp socket		1.20.122.031/0000	2 - 60
LED W 2 x 4.6d superbright, white, 24 V		1.90.690.365/0000	5 - 16
Disassembly tool for LUMOTAST 25, RAFIX 16		5.05.800.042/0000	2 - 74 5 - 26
Label holder, flush, for square collar		5.07.620.004/0000	2 - 76

RAFIX 16

Accessories RAFX 16 pushbutton

Description	Photo	Order no.	Page
Fixing spanner for hexagon nut		5.58.002.034/0000	2 - 75

RAFIX 16 pushbutton, flush lens, square collar

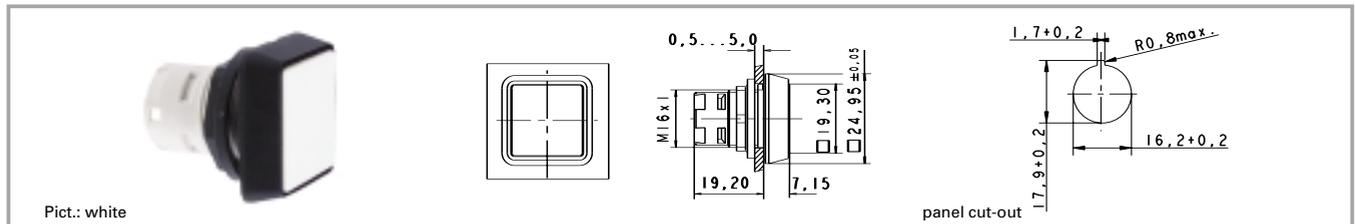

Illuminability	Colour of lens	Order no. complete	Order no. single parts	
			Housing	Lens
yes	transparent colourless	1.30.070.001/1002	1.30.070.501/0000	5.49.077.011/1002
yes	transparent red	1.30.070.001/1306	1.30.070.501/0000	5.49.077.011/1306
yes	transparent yellow	1.30.070.001/1403	1.30.070.501/0000	5.49.077.011/1403
yes	transparent green	1.30.070.001/1505	1.30.070.501/0000	5.49.077.011/1505
yes	transparent blue	1.30.070.001/1607	1.30.070.501/0000	5.49.077.011/1607
no	opaque black	1.30.070.251/0100	1.30.070.751/0000	5.05.510.640/0100
no	opaque white	1.30.070.251/0200	1.30.070.751/0000	5.05.510.640/0200
no	opaque red	1.30.070.251/0300	1.30.070.751/0000	5.05.510.640/0300
no	opaque yellow	1.30.070.251/0400	1.30.070.751/0000	5.05.510.640/0400
no	opaque green	1.30.070.251/0500	1.30.070.751/0000	5.05.510.640/0500
no	opaque blue	1.30.070.251/0600	1.30.070.751/0000	5.05.510.640/0600

Technical data see page 2 - 8

Accessories:

Legend insert, blank, use only for transparent lenses: 5.70.635.000/2000

For the „latching“ function, please use the standard contact block with „latching“ function.

RAFIX 16 pushbutton, protruding lens, square collar

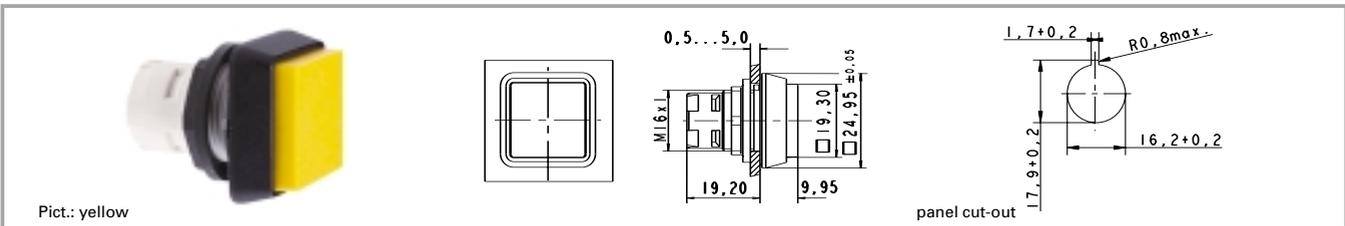

2

RAFIX
16

Illuminability	Colour of lens	Order no. complete	Order no. single parts	
			Housing	Lens
yes	transparent colourless	1.30.070.051/1002	1.30.070.551/0000	5.49.077.012/1002
yes	transparent red	1.30.070.051/1306	1.30.070.551/0000	5.49.077.012/1306
yes	transparent yellow	1.30.070.051/1403	1.30.070.551/0000	5.49.077.012/1403
yes	transparent green	1.30.070.051/1505	1.30.070.551/0000	5.49.077.012/1505
yes	transparent blue	1.30.070.051/1607	1.30.070.551/0000	5.49.077.012/1607
no	opaque black	1.30.070.301/0100		
no	opaque white	1.30.070.301/0200		
no	opaque red	1.30.070.301/0300		
no	opaque yellow	1.30.070.301/0400		
no	opaque green	1.30.070.301/0500		
no	opaque blue	1.30.070.301/0600		

Technical data see page 2 - 8

Accessories:

Legend insert, blank, use only for transparent lenses: 5.70.635.000/2000

For the „latching“ function, please use the standard contact block with „latching“ function.

RAFIX 16

RAFIX 16 pushbutton, protruding collar, square collar

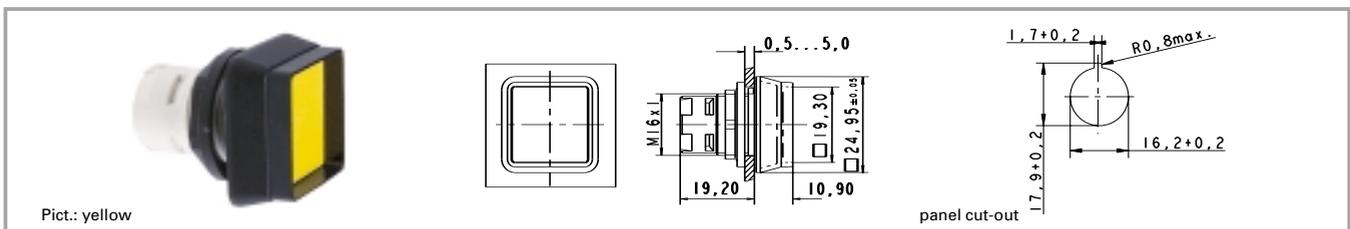

Illuminability	Colour of lens	Order no. complete	Order no. single parts	
			Housing	Lens
yes	transparent colourless	1.30.070.101/1002	1.30.070.601/0000	5.49.077.011/1002
yes	transparent red	1.30.070.101/1306	1.30.070.601/0000	5.49.077.011/1306
yes	transparent yellow	1.30.070.101/1403	1.30.070.601/0000	5.49.077.011/1403
yes	transparent green	1.30.070.101/1505	1.30.070.601/0000	5.49.077.011/1505
yes	transparent blue	1.30.070.101/1607	1.30.070.601/0000	5.49.077.011/1607
no	opaque black	1.30.070.351/0100	1.30.070.851/0000	5.05.510.640/0100
no	opaque white	1.30.070.351/0200	1.30.070.851/0000	5.05.510.640/0200
no	opaque red	1.30.070.351/0300	1.30.070.851/0000	5.05.510.640/0300
no	opaque yellow	1.30.070.351/0400	1.30.070.851/0000	5.05.510.640/0400
no	opaque green	1.30.070.351/0500	1.30.070.851/0000	5.05.510.640/0500
no	opaque blue	1.30.070.351/0600	1.30.070.851/0000	5.05.510.640/0600

Technical data see page 2 - 8

Accessories:

Legend insert, blank, use only for transparent lenses: 5.70.635.000/2000

The protruding collar offers protection against inadvertent operation and thereby fulfils the safety requirements of various machinery manufacturers, particularly in the printing industry.

For the "latching" function, please use the standard contact block with "latching" function.

2

RAFIX 16

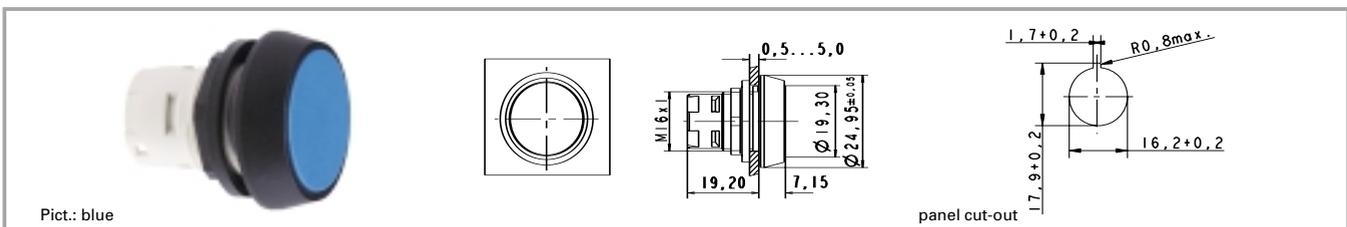
RAFIX 16 pushbutton, flush lens, round collar

Illuminability	Colour of lens	Order no. complete	Order no. single parts	
			Housing	Lens
yes	transparent colourless	1.30.070.021/1002	1.30.070.521/0000	5.49.259.017/1002
yes	transparent red	1.30.070.021/1306	1.30.070.521/0000	5.49.259.017/1306
yes	transparent yellow	1.30.070.021/1403	1.30.070.521/0000	5.49.259.017/1403
yes	transparent green	1.30.070.021/1505	1.30.070.521/0000	5.49.259.017/1505
yes	transparent blue	1.30.070.021/1607	1.30.070.521/0000	5.49.259.017/1607
no	opaque black	1.30.070.271/0100	1.30.070.771/0000	5.05.510.641/0100
no	opaque white	1.30.070.271/0200	1.30.070.771/0000	5.05.510.641/0200
no	opaque red	1.30.070.271/0300	1.30.070.771/0000	5.05.510.641/0300
no	opaque yellow	1.30.070.271/0400	1.30.070.771/0000	5.05.510.641/0400
no	opaque green	1.30.070.271/0500	1.30.070.771/0000	5.05.510.641/0500
no	opaque blue	1.30.070.271/0600	1.30.070.771/0000	5.05.510.641/0600

Technical data see page 2 - 8

Accessories:

Legend insert, blank, use only for transparent lenses: 5.70.637.000/2000

For the "latching" function, please use the standard contact block with "latching" function.

RAFIX 16

RAFIX 16 pushbutton IP66 with protective cap

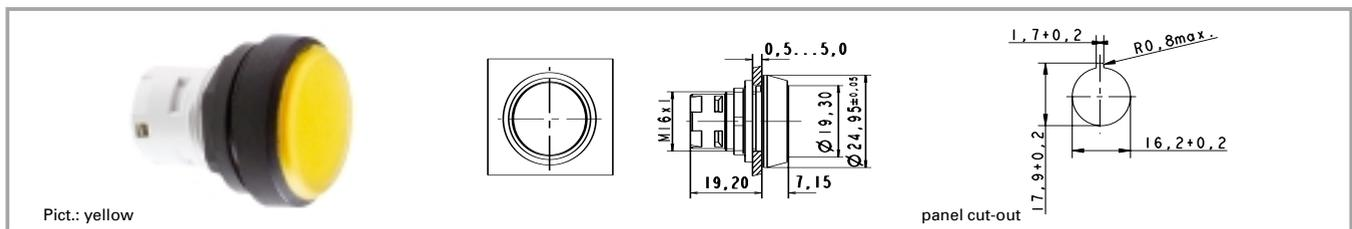

Pict.: yellow

panel cut-out

Illuminability	Colour of lens	Order no. complete	Order no. single parts	
			Housing	Lens
yes	transparent colourless	1.30.070.026/1002		
yes	transparent red	1.30.070.026/1306		
yes	transparent yellow	1.30.070.026/1403		
yes	transparent green	1.30.070.026/1505		
yes	transparent blue	1.30.070.026/1607		
no	opaque black	1.30.070.276/0100		
no	opaque white	1.30.070.276/0200		
no	opaque red	1.30.070.276/0300		
no	opaque yellow	1.30.070.276/0400		
no	opaque green	1.30.070.276/0500		
no	opaque blue	1.30.070.276/0600		

Technical data see page 2 - 8

Accessories:

Legend insert, blank, use only for transparent lenses: 5.70.637.000/2000

Pushbutton for use in hostile environments. A transparent protective cap ensures a degree of protection of IP 66 to DIN/IEC. Operating life: 500,000 operations.

For the "latching" function, please use the standard contact block with "latching" function.

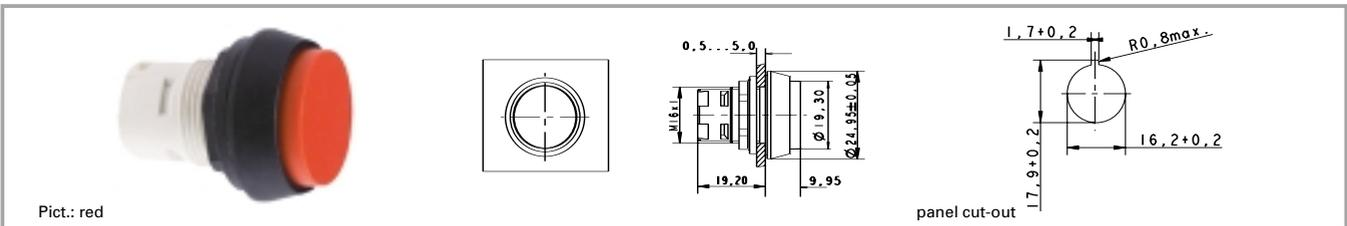
RAFIX 16 pushbutton, protruding lens, round collar

Illuminability	Colour of lens	Order no. complete	Order no. single parts	
			Housing	Lens
yes	transparent colourless	1.30.070.071/1002	1.30.070.571/0000	5.49.259.018/1002
yes	transparent red	1.30.070.071/1306	1.30.070.571/0000	5.49.259.018/1306
yes	transparent yellow	1.30.070.071/1403	1.30.070.571/0000	5.49.259.018/1403
yes	transparent green	1.30.070.071/1505	1.30.070.571/0000	5.49.259.018/1505
yes	transparent blue	1.30.070.071/1607	1.30.070.571/0000	5.49.259.018/1607
no	opaque black	1.30.070.321/0100		
no	opaque white	1.30.070.321/0200		
no	opaque red	1.30.070.321/0300		
no	opaque yellow	1.30.070.321/0400		
no	opaque green	1.30.070.321/0500		
no	opaque blue	1.30.070.321/0600		

Technical data see page 2 - 8

Accessories:

Legend insert, blank, use only for transparent lenses: 5.70.637.000/2000

For the "latching" function, please use the standard contact block with "latching" function.

RAFIX 16

RAFIX 16 pushbutton, protruding collar, round collar

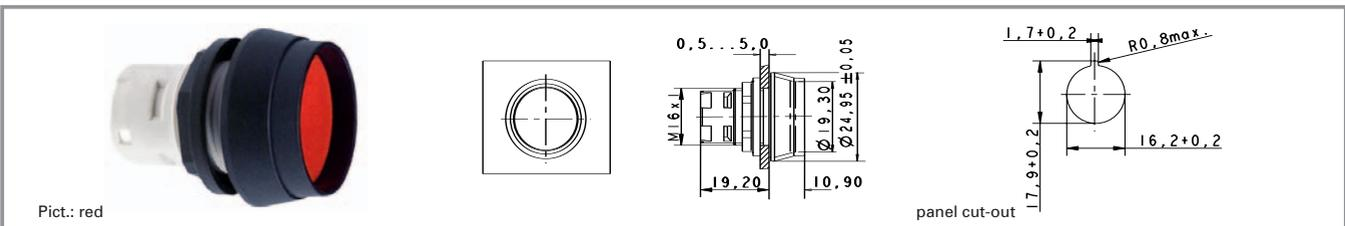

Illuminability	Colour of lens	Order no. complete	Order no. single parts	
			Housing	Lens
yes	transparent colourless	1.30.070.121/1002	1.30.070.621/0000	5.49.259.017/1002
yes	transparent red	1.30.070.121/1306	1.30.070.621/0000	5.49.259.017/1306
yes	transparent yellow	1.30.070.121/1403	1.30.070.621/0000	5.49.259.017/1403
yes	transparent green	1.30.070.121/1505	1.30.070.621/0000	5.49.259.017/1505
yes	transparent blue	1.30.070.121/1607	1.30.070.621/0000	5.49.259.017/1607
no	opaque black	1.30.070.371/0100	1.30.070.871/0000	5.05.510.641/0100
no	opaque white	1.30.070.371/0200	1.30.070.871/0000	5.05.510.641/0200
no	opaque red	1.30.070.371/0300	1.30.070.871/0000	5.05.510.641/0300
no	opaque yellow	1.30.070.371/0400	1.30.070.871/0000	5.05.510.641/0400
no	opaque green	1.30.070.371/0500	1.30.070.871/0000	5.05.510.641/0500
no	opaque blue	1.30.070.371/0600	1.30.070.871/0000	5.05.510.641/0600

Technical data see page 2 - 8

Accessories:

Legend insert, blank, use only for transparent lenses: 5.70.637.000/2000

The protruding collar offers protection against inadvertent operation and thereby fulfils the safety requirements of various machinery manufacturers, particularly in the printing industry.

For the "latching" function, please use the standard contact block with "latching" function.

2

RAFIX
16

RAFIX 16 pushbutton, flush lens, square collar, alignable without gaps

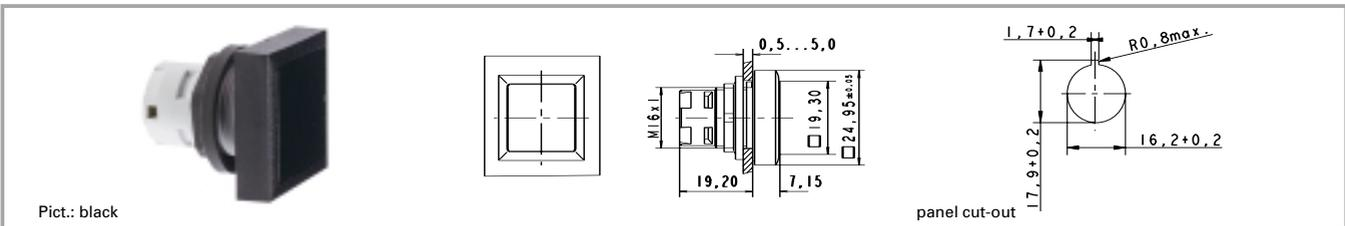

2

RAFIX 16

Illuminability	Colour of lens	Order no. complete	Order no. single parts	
			Housing	Lens
yes	transparent colourless	1.30.070.201/1002	1.30.070.701/0000	5.49.077.011/1002
yes	transparent red	1.30.070.201/1306	1.30.070.701/0000	5.49.077.011/1306
yes	transparent yellow	1.30.070.201/1403	1.30.070.701/0000	5.49.077.011/1403
yes	transparent green	1.30.070.201/1505	1.30.070.701/0000	5.49.077.011/1505
yes	transparent blue	1.30.070.201/1607	1.30.070.701/0000	5.49.077.011/1607
no	opaque black	1.30.070.451/0100	1.30.070.951/0000	5.05.510.640/0100
no	opaque white	1.30.070.451/0200	1.30.070.951/0000	5.05.510.640/0200
no	opaque red	1.30.070.451/0300	1.30.070.951/0000	5.05.510.640/0300
no	opaque yellow	1.30.070.451/0400	1.30.070.951/0000	5.05.510.640/0400
no	opaque green	1.30.070.451/0500	1.30.070.951/0000	5.05.510.640/0500
no	opaque blue	1.30.070.451/0600	1.30.070.951/0000	5.05.510.640/0600

Technical data see page 2 - 8

Accessories:

Legend insert, blank, use only for transparent lenses: 5.70.635.000/2000

For the „latching“ function, please use the standard contact block with „latching“ function.

RAFIX 16 selector switch

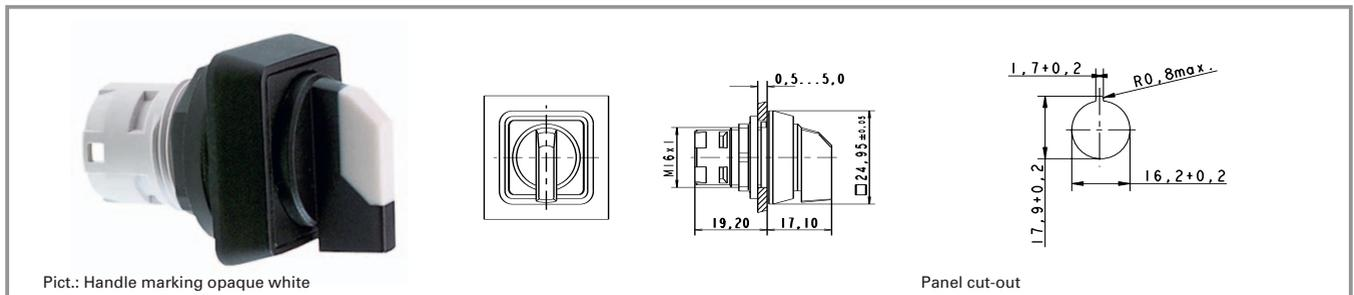

2

RAFIX 16

Technical data

General information

Form of lens handle
 Marking of handle see order block
 Form of collar see order block

Dimensions

Length of collar see order block
 Diameter of collar see order block
 Key grid 25 x 25 mm
 Width of collar see order block
 Overall height 17.1 mm
 Mounting depth 44.7 mm
 Mounting hole 16.2 mm

Mechanical design

Mounting ring nut
 Contact function see order block
 Contact arrangement according to contact block
 Illuminability see order block
 Rotating angle see order block

Mechanical characteristics

Torque max. 1.3 Nm

Other specifications

Operating life 30000
 Degree of protection from front side IP65
 Ambient temp. operating min. -25 °C
 Ambient temp. operating without lamp max. +70 °C
 Ambient temp. operating with lamp max. +55 °C
 Storage temperature min. -40 °C
 Storage temperature max. +85 °C
 Resistance to constant environment according to IEC 600 68-2-3 and 2-30
 Resistance at variable environment according to IEC 600 68-2-14 and 2-33

Accessories RAFIX 16 selector switch

Description	Photo	Order no.	Page
RAFIX 16 universal contact block, 1 NC + 1 NO, momentary, silver contacts, with lamp socket		1.20.123.001/0000	2 - 65
RAFIX 16 universal contact block, 1 NC + 1 NO, momentary, gold contacts, with lamp socket		1.20.123.011/0000	2 - 61
Label holder, flush, for square collar		5.07.620.004/0000	2 - 76
Fixing spanner for hexagon nut		5.58.002.034/0000	2 - 75

For suitable LEDs, filament lamps and other contact blocks, refer to the chapter „RAFIX 16 contact blocks“; for additional accessories, refer to the chapter „RAFIX 16 special accessories“.

RAFIX 16

RAFIX 16 selector switch, square collar

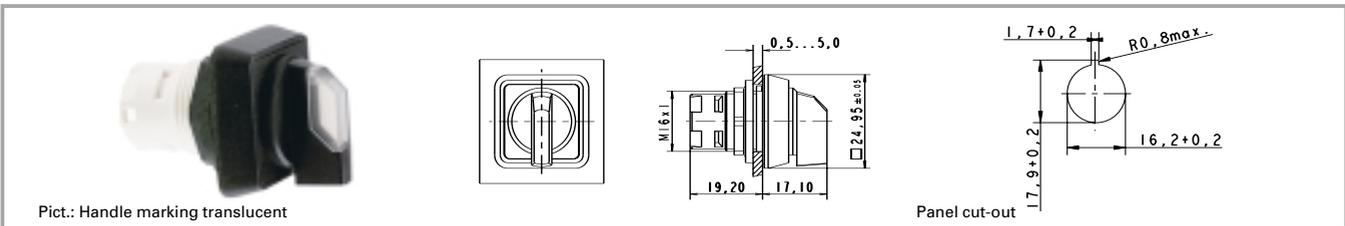

Illuminability	Contact function	Rotating angle		Marking of handle	Order no. complete
yes	momentary	1 x 40°			translucent white 1.30.073.551/2000
yes	momentary	2 x 40°			translucent white 1.30.073.651/2000
yes	latching	L, 1 x 90°			translucent white 1.30.073.501/2000
yes	latching	V, 1 x 90°			translucent white 1.30.073.601/2000
yes	latching	2 x 60°			translucent white 1.30.073.701/2000
yes	latching 1 x 90° and momentary 1 x 40°	latching 90°/momentary 40°			translucent white 1.30.073.751/2000
no	momentary	1 x 40°			opaque white 1.30.073.550/0200
no	momentary	2 x 40°			opaque white 1.30.073.650/0200
no	latching	L, 1 x 90°			1.30.073.500/0200
no	latching	V, 1 x 90°			1.30.073.600/0200
no	latching	2 x 60°			1.30.073.700/0200
no	latching 1 x 90° and momentary 1 x 40°	latching 90°/momentary 40°			1.30.073.750/0200

Technical data see page 2 - 18

Only use contact blocks with "momentary" contact function.
For versions with clockwise and counterclockwise rotation, use universal contact blocks only!
Other handle marking colours available on request.

2

RAFIX 16

RAFIX 16 selector switch, round collar

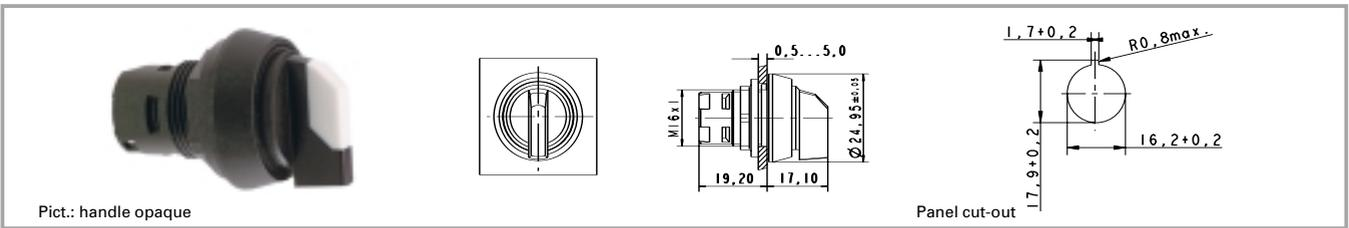

Pict.: handle opaque

Panel cut-out

2

RAFIX
16

Illuminability	Contact function	Rotating angle		Marking of handle	Order no. complete
yes	momentary	1 x 40°			translucent white 1.30.073.571/2000
yes	momentary	2 x 40°			translucent white 1.30.073.671/2000
yes	latching	L, 1 x 90°			translucent white 1.30.073.521/2000
yes	latching	V, 1 x 90°			translucent white 1.30.073.621/2000
yes	latching	2 x 60°			translucent white 1.30.073.721/2000
yes	latching 1 x 90° and momentary 1 x 40°	latching 90°/momentary 40°			translucent white 1.30.073.771/2000
no	momentary	1 x 40°			opaque white 1.30.073.570/0200
no	momentary	2 x 40°			opaque white 1.30.073.670/0200
no	latching	L, 1 x 90°			opaque white 1.30.073.520/0200
no	latching	V, 1 x 90°			opaque white 1.30.073.620/0200
no	latching	2 x 60°			opaque white 1.30.073.720/0200
no	latching 1 x 90° and momentary 1 x 40°	latching 90°/momentary 40°			opaque white 1.30.073.770/0200

Technical data see page 2 - 18

Only use contact blocks with "momentary" contact function.
For versions with clockwise and counterclockwise rotation, use universal contact blocks only!
Other handle marking colours available on request.

RAFIX 16

RAFIX 16 selector switch, square collar, alignable without gaps

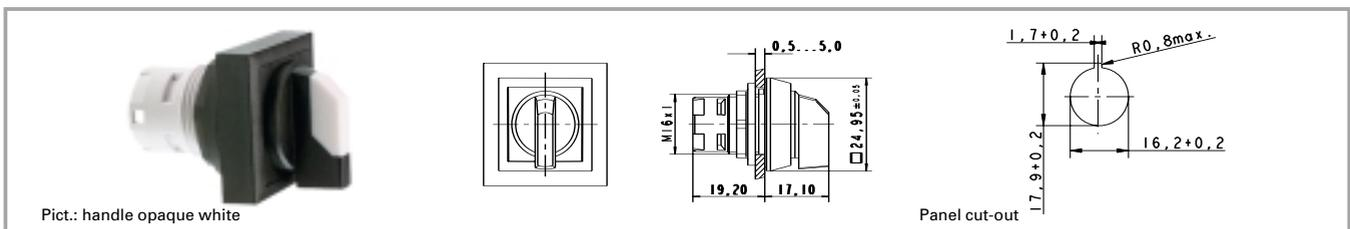

Illuminability	Contact function	Rotating angle		Marking of handle	Order no. complete
yes	momentary	1 x 40°			translucent white 1.30.073.591/2000
yes	momentary	2 x 40°			translucent white 1.30.073.691/2000
yes	latching	L, 1 x 90°			translucent white 1.30.073.541/2000
yes	latching	V, 1 x 90°			translucent white 1.30.073.641/2000
yes	latching	2 x 60°			translucent white 1.30.073.741/2000
yes	latching 1 x 90° and momentary 1 x 40°	latching 90°/momentary 40°			translucent white 1.30.073.791/2000
no	momentary	1 x 40°			opaque white 1.30.073.590/0200
no	momentary	2 x 40°			opaque white 1.30.073.690/0200
no	latching	L, 1 x 90°			opaque white 1.30.073.540/0200
no	latching	V, 1 x 90°			opaque white 1.30.073.640/0200
no	latching	2 x 60°			opaque white 1.30.073.740/0200
no	latching 1 x 90° and momentary 1 x 40°	latching 90°/momentary 40°			opaque white 1.30.073.790/0200

Technical data see page 2 - 18

Only use contact blocks with "momentary" contact function.
For versions with clockwise and counterclockwise rotation, use universal contact blocks only!
Other handle marking colours available on request.

2

RAFIX
16

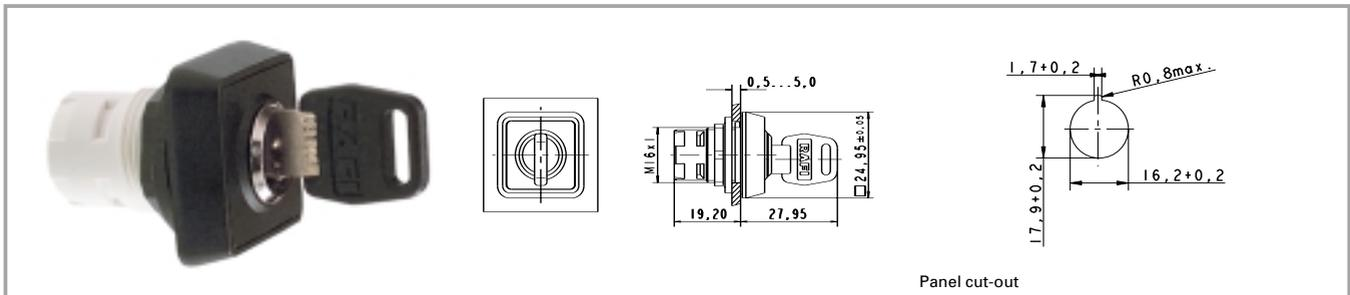
RAFIX 16 keylock switch MICROMECC

Panel cut-out

2**Technical data****General information**

Form of collar see order block

Dimensions

Length of collar see order block
 Diameter of collar see order block
 Key grid 25 x 25 mm
 Width of collar see order block
 Overall height 27.95 mm
 Mounting depth 44.7 mm
 Mounting hole 16.2 mm

Mechanical design

Mounting ring nut
 Contact function see order block
 Contact arrangement according to contact block
 Illuminability no
 Lock Micromec
 Wafers 5
 Lock type 001
 Number of locking positions 500
 Main key yes
 Symmetric key no
 Rotating angle see order block
 Key removal position see order block
 Group key yes
 General key yes

Mechanical characteristics

Torque max. 1.3 Nm

Electrical characteristics

Protection class II

Other specifications

ESD-strength lock / contact 15 kV
 ESD strength key/ front panel 8 kV
 Operating life 65000
 Degree of protection from front side IP65
 Ambient temp. operating min. -25 °C
 Ambient temp. operating without lamp max. +70 °C
 Storage temperature min. -40 °C
 Storage temperature max. +85 °C
 Resistance to constant environment according to IEC 600 68-2-3 and 2-30
 Resistance at variable environment according to IEC 600 68-2-14 and 2-33

Accessories RAFIX 16 keylock switch MICROMECC

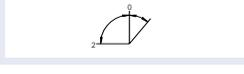
Description	Photo	Order no.	Page
RAFIX 16 universal contact block, 1 NC + 1 NO, momentary, silver contacts, without lamp socket		1.20.123.021/0000	2 - 65
RAFIX 16 universal contact block, 1 NC + 1 NO, momentary, gold contacts, without lamp socket		1.20.123.031/0000	2 - 61
Label holder, flush, for square collar		5.07.620.004/0000	2 - 76
Fixing spanner for hexagon nut		5.58.002.034/0000	2 - 75



RAFIX 16

Accessories RAFX 16 keylock switch MICROMECC

Description	Photo	Order no.	Page
Spare key, black		5.58.007.001/0000	

For other contact blocks, refer to the chapter „RAFIX 16 contact blocks“; for additional accessories, refer to the chapter „RAFIX 16 special accessories“.

RAFIX 16 keylock switch MICROMECC, square collar

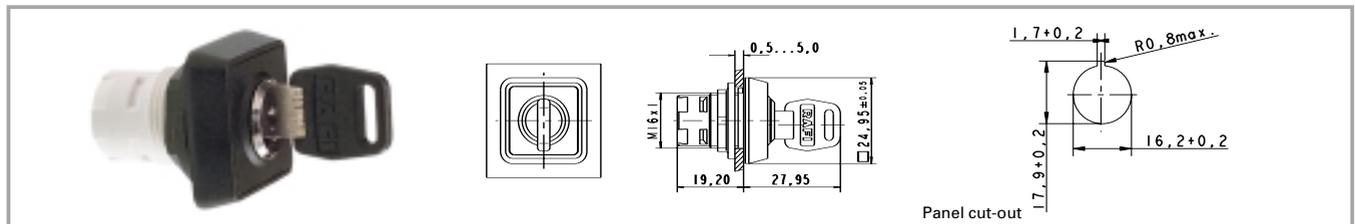

Contact function	Rotating angle	Key removal position	Order no. complete
momentary	1 x 40°	0	1.30.076.501/0000
momentary	2 x 40°	0	1.30.076.701/0000
latching	L, 1 x 90°	0	1.30.076.001/0000
latching	L, 1 x 90°	0+1	1.30.076.051/0000
latching	V, 1 x 90°	0	1.30.076.101/0000
latching	V, 1 x 90°	0+1	1.30.076.151/0000
latching	2 x 90°	0	1.30.076.301/0000
latching	2 x 90°	0+1+2	1.30.076.401/0000
latching 1 x 90° and momentary 1 x 40°	latching 1 x 90°/ momentary 1 x 40°	2	1.30.076.901/0000

Technical data see page 2 - 22

Only use contact blocks with "momentary" contact function. For versions with clockwise and counterclockwise rotation, use universal contact block only.
Included: 2 keys.

2

RAFIX 16

RAFIX 16 keylock switch MICROMECC, round collar

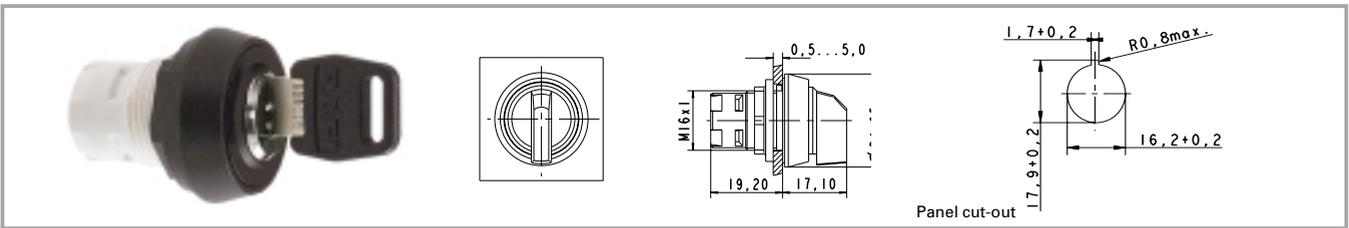

2

RAFIX
16

Contact function	Rotating angle	Key removal position	Order no. complete
momentary	1 x 40°	0	1.30.076.521/0000
momentary	2 x 40°	0	1.30.076.721/0000
latching	L, 1 x 90°	0	1.30.076.021/0000
latching	L, 1 x 90°	0+1	1.30.076.071/0000
latching	V, 1 x 90°	0	1.30.076.121/0000
latching	V, 1 x 90°	0+1	1.30.076.171/0000
latching	2 x 90°	0	1.30.076.321/0000
latching	2 x 90°	0+1+2	1.30.076.421/0000
latching 1 x 90° and momentary 1 x 40°	latching 1 x 90°/ momentary 1 x 40°	2	1.30.076.921/0000

Technical data see page 2 - 22

Only use contact blocks with "momentary" contact function. For versions with clockwise and counterclockwise rotation, use universal contact block only.
Included: 2 keys.



RAFIX 16

RAFIX 16 keylock switch MICROMECC, square collar, alignable without gaps

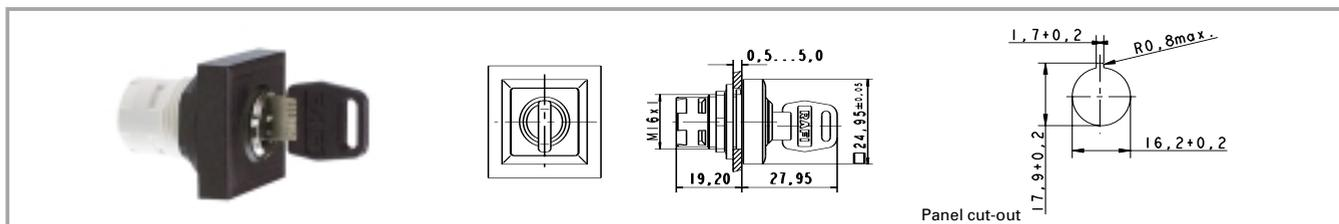

Contact function	Rotating angle	Key removal position	Order no. complete
momentary	1 x 40°	0	1.30.076.541/0000
momentary	2 x 40°	0	1.30.076.741/0000
latching	L, 1 x 90°	0	1.30.076.041/0000
latching	L, 1 x 90°	0+1	1.30.076.091/0000
latching	V, 1 x 90°	0	1.30.076.141/0000
latching	V, 1 x 90°	0+1	1.30.076.191/0000
latching	2 x 90°	0	1.30.076.341/0000
latching	2 x 90°	0+1+2	1.30.076.441/0000
latching 1 x 90° and momentary 1 x 40°	latching 1 x 90°/ momentary 1 x 40°	2	1.30.076.941/0000

Technical data see page 2 - 22

Only use contact blocks with "momentary" contact function. For versions with clockwise and counterclockwise rotation, use universal contact block only.
Included: 2 keys.

2

RAFIX
16

RAFIX 16 keylock switch, RONIS

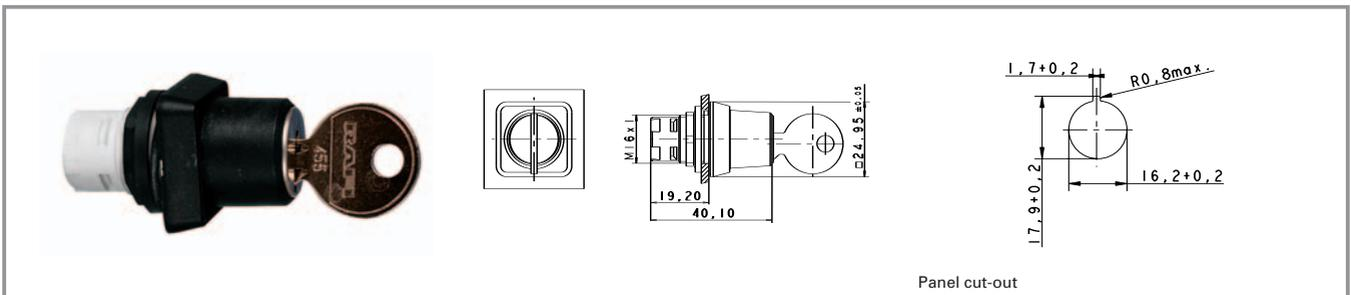

2

RAFIX 16

Technical data

General information

Form of collar see order block

Dimensions

Length of collar see order block
 Diameter of collar see order block
 Key grid 25 x 25 mm
 Width of collar see order block
 Overall height 20.9 mm
 Mounting depth 44.7 mm
 Mounting hole 16.2 mm

Mechanical design

Mounting ring nut
 Contact function see order block
 Contact arrangement according to contact block
 Illuminability no
 Lock Ronis
 Wafers 4
 Lock type 455
 Number of locking positions 200
 Main key no
 Symmetric key no
 Rotating angle see order block
 Key removal position see order block
 Group key no
 General key no

Mechanical characteristics

Robustness min. 100 N

Electrical characteristics

Protection class II

Other specifications

ESD-strength lock / contact 15 kV
 ESD strength key/ front panel 4 kV
 Operating life 65000
 Degree of protection from front side IP65
 Ambient temp. operating min. -25 °C
 Ambient temp. operating max. +70 °C
 Storage temperature min. -40 °C
 Storage temperature max. +85 °C
 Resistance to constant environment according to IEC 600 68-2-3 and 2-30
 Resistance at variable environment according to IEC 600 68-2-14 and 2-33

Accessories Keylock switch, RONIS

Description	Photo	Order no.	Page
RAFIX 16 universal contact block, 1 NC + 1 NO, momentary, silver contacts, without lamp socket		1.20.123.021/0000	2 - 65
RAFIX 16 universal contact block, 1 NC + 1 NO, momentary, gold contacts, without lamp socket		1.20.123.031/0000	2 - 61
Label holder, flush, for square collar		5.07.620.004/0000	2 - 76
Fixing spanner for hexagon nut		5.58.002.034/0000	2 - 75

For other contact blocks, refer to the chapter „RAFIX 16 contact blocks“; for additional accessories, refer to the chapter „RAFIX 16 special accessories“.

RAFIX 16

RAFIX 16 keylock switch, RONIS, square collar

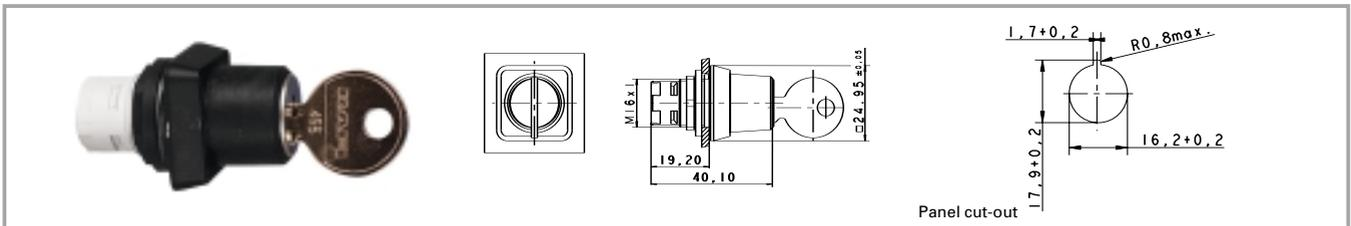

Contact function	Rotating angle	Key removal position	Order no. complete
momentary	1 x 40°	0	1.30.176.501/0000
momentary	2 x 40°	0	1.30.176.701/0000
latching	L, 1 x 90°	0	1.30.176.001/0000
latching	L, 1 x 90°	0+1	1.30.176.051/0000
latching	V, 1 x 90°	0	1.30.176.101/0000
latching	V, 1 x 90°	0+1	1.30.176.151/0000
latching	2 x 90°	0	1.30.176.301/0000
latching	2 x 90°	0+1+2	1.30.176.401/0000

Technical data see page 2 - 26

Only use contact blocks with "momentary" contact function. For versions with clockwise and counterclockwise rotation, use universal contact block only.

Included: 2 keys.

Other lock variants available on request.

2

**RAFIX
16**

RAFIX 16 keylock switch, RONIS, round collar

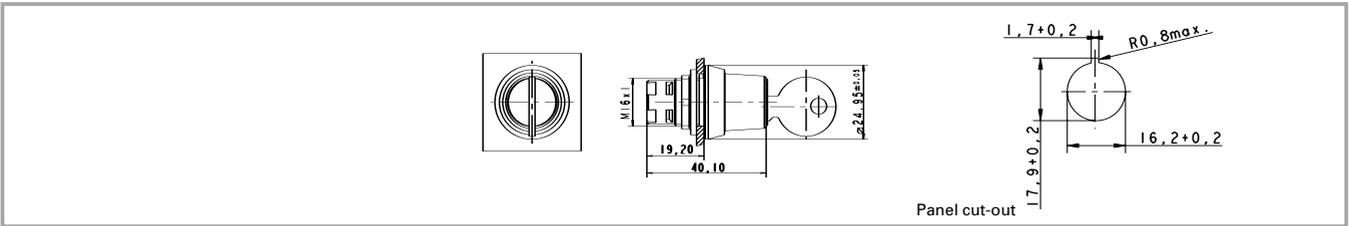

2

RAFIX
16

Contact function	Rotating angle	Key removal position	Order no. complete
momentary	1 x 40°	0	1.30.176.521/0000
momentary	2 x 40°	0	1.30.176.721/0000
latching	L, 1 x 90°	0	1.30.176.021/0000
latching	L, 1 x 90°	0+1	1.30.176.071/0000
latching	V, 1 x 90°	0	1.30.176.121/0000
latching	V, 1 x 90°	0+1	1.30.176.171/0000
latching	2 x 90°	0	1.30.176.321/0000
latching	2 x 90°	0+1+2	1.30.176.421/0000

Technical data see page 2 - 26

Only use contact blocks with "momentary" contact function. For versions with clockwise and counterclockwise rotation, use universal contact block only.
Included: 2 keys.



RAFIX 16

RAFIX 16 keylock switch, RONIS, square collar, alignable without gaps

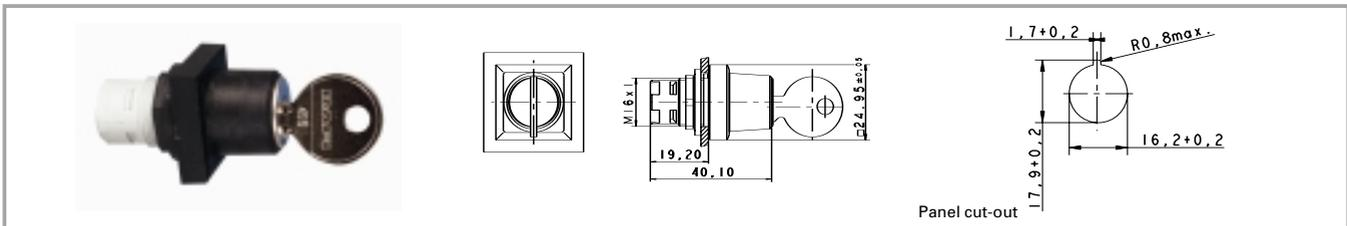

Contact function	Rotating angle	Key removal position	Order no. complete
momentary	1 x 40°	0	1.30.176.541/0000
momentary	2 x 40°	0	1.30.176.741/0000
latching	L, 1 x 90°	0	1.30.176.041/0000
latching	L, 1 x 90°	0+1	1.30.176.091/0000
latching	V, 1 x 90°	0	1.30.176.141/0000
latching	V, 1 x 90°	0+1	1.30.176.191/0000
latching	2 x 90°	0	1.30.176.341/0000
latching	2 x 90°	0+1+2	1.30.176.441/0000

Technical data see page 2 - 26

Only use contact blocks with "momentary" contact function. For versions with clockwise and counterclockwise rotation, use universal contact block only.
Included: 2 keys.

2

RAFIX 16

RAFIX 16 mushroom-headed pushbutton**2**RAFIX
16**Technical data****General information**

Form of lens	protruding lens
Colour of lens	see order block
Form of collar	see order block

Dimensions

Length of collar	see order block
Diameter of collar	see order block
Key grid	25 x 25 mm
Width of collar	see order block
Overall height	12.1 mm
Mounting depth	44.7 mm
Mounting hole	16.2 mm

Mechanical design

Mounting	ring nut
Contact function	according to contact block
Contact arrangement	according to contact block
Illuminability	no

Mechanical characteristics

Operating travel	3 mm
Robustness min.	100 Nm

Other specifications

Operating life	2000000
Degree of protection from front side	IP65
Ambient temp. operating min.	-25 °C
Ambient temp. operating without lamp max.	+70 °C
Storage temperature min.	-40 °C
Storage temperature max.	+85 °C
Resistance to constant environment	according to IEC 600 68-2-3 and 2-30
Resistance at variable environment	according to IEC 600 68-2-14 and 2-33

Accessories RAFIX 16 mushroom-headed pushbutton

Description	Photo	Order no.	Page
RAFIX 16 standard contact block, 1 NC + 1 NO, momentary, silver contacts, without lamp socket		1.20.122.021/0000	2 - 64
RAFIX 16 standard contact block, 1 NC + 1 NO, momentary, gold contacts, without lamp socket		1.20.122.031/0000	2 - 60
Label holder, flush, for square collar		5.07.620.004/0000	2 - 76
Fixing spanner for hexagon nut		5.58.002.034/0000	2 - 75

For other contact blocks, refer to the chapter „RAFIX 16 contact blocks“; for additional accessories, refer to the chapter „RAFIX 16 special accessories“.

RAFIX 16

RAFIX 16 mushroom-headed pushbutton, square collar

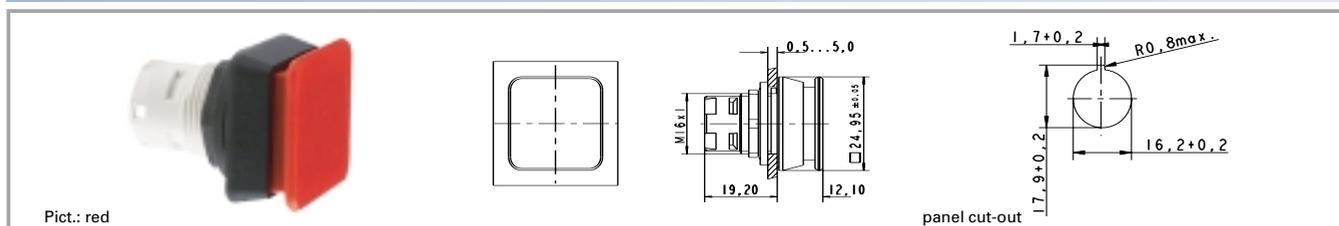

Illuminability	Colour of lens	Order no. complete
no	opaque black	1.30.071.001/0100
no	opaque red	1.30.071.001/0300

Technical data see page 2 - 30

For the "latching" function, please use the standard contact block with "latching" function.

RAFIX 16 mushroom-headed pushbutton, round collar

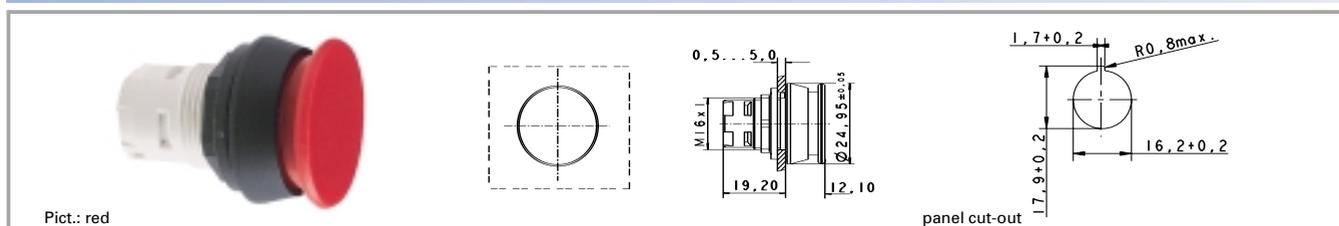

Illuminability	Colour of lens	Order no. complete
no	opaque black	1.30.071.021/0100
no	opaque red	1.30.071.021/0300

Technical data see page 2 - 30

For the "latching" function, please use the standard contact block with "latching" function.

RAFIX 16 mushroom-headed pushbutton, square collar, alignable without gaps

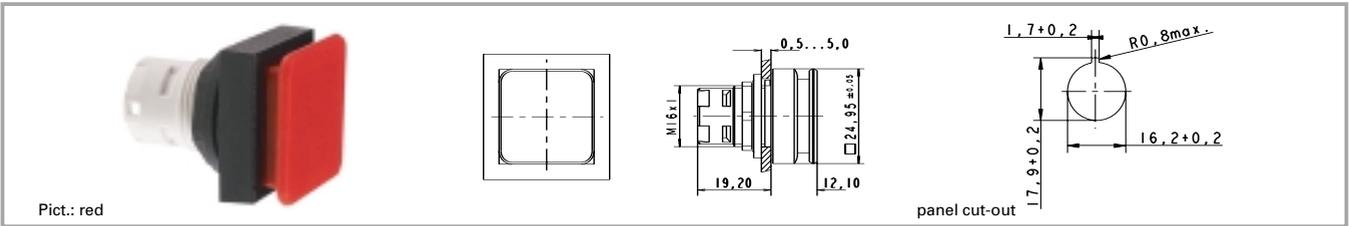

Illuminability	Colour of lens	Order no. complete
no	opaque black	1.30.071.041/0100
no	opaque red	1.30.071.041/0300

Technical data see page 2 - 30

For the "latching" function, please use the standard contact block with "latching" function.

2

RAFIX
16

RAFIX 16 emergency stop pushbutton

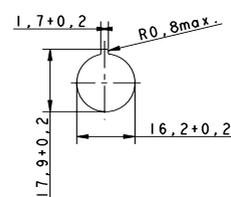

panel cut-out

2

RAFIX 16

Technical data

General information

Form of button see order block
 Colour of button see order block
 Form of collar see order block

Dimensions

Length of collar see order block
 Diameter of collar see order block
 Key grid 25 x 25 mm
 Width of collar see order block
 Overall height see order block
 Mounting depth 44.7 mm
 Mounting hole 16.2 mm

Mechanical design

Mounting ring nut
 Contact function latching
 Contact arrangement according to contact block
 Illuminability see order block

Mechanical characteristics

Robustness min. 100 N
 Robustness acc. IEC 60947-5-5

Other specifications

Operating life 30000
 Degree of protection from front side IP65
 Ambient temp. operating min. -25 °C
 Ambient temp. operating without lamp max. +70 °C
 Ambient temp. operating with lamp max. +55 °C
 Storage temperature min. -40 °C
 Storage temperature max. +85 °C
 Resistance to constant environment according to IEC 600 68-2-3 and 2-30
 Resistance at variable environment according to IEC 600 68-2-14 and 2-33
 Corresponding to CE Ma-Dir. 89/392 Approvals yes IEC 60204, IEC 73

Accessories RAFIX 16 emergency stop pushbutton

Description	Photo	Order no.	Page
RAFIX 16 universal contact block, 1 NC, momentary, silver contacts, without lamp socket		1.20.123.022/0000	2 - 65
RAFIX 16 universal contact block, 1 NC, momentary, gold contacts, without lamp socket		1.20.123.032/0000	2 - 61
Fixing spanner for hexagon nut		5.58.002.034/0000	2 - 75
Emergency stop label, yellow, round 60 mm, PVC adhesive, without legend		5.76.204.400/0400	2 - 77

For suitable LEDs, filament lamps and other contact blocks, refer to the chapter „RAFIX 16 contact blocks“; for additional accessories, refer to the chapter „RAFIX 16 special accessories“.

RAFIX 16

RAFIX 16 emergency stop pushbutton, square collar, illuminated

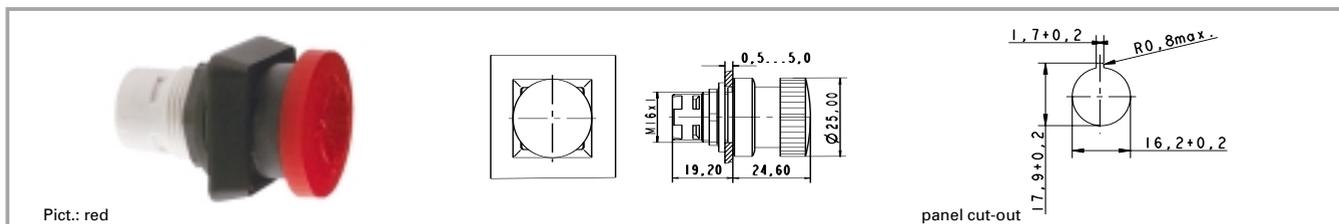

Illuminability	Colour of button	Order no. complete
yes	translucent red	1.30.074.501/0304

Technical data see page 2 - 34

Only use universal contact blocks.

2

RAFIX 16 emergency stop pushbutton, square collar, dupe-proof

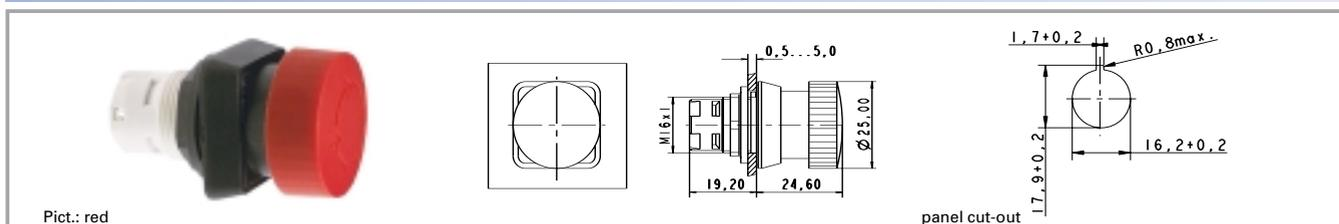

Illuminability	Colour of button	Order no. complete
no	opaque red	1.30.074.101/0301

Technical data see page 2 - 34

Only use universal contact blocks.

The positively driven mechanical arrangement is dupe-proof to EN 418.

RAFIX
16

RAFIX 16 emergency stop pushbutton, round collar, illuminated

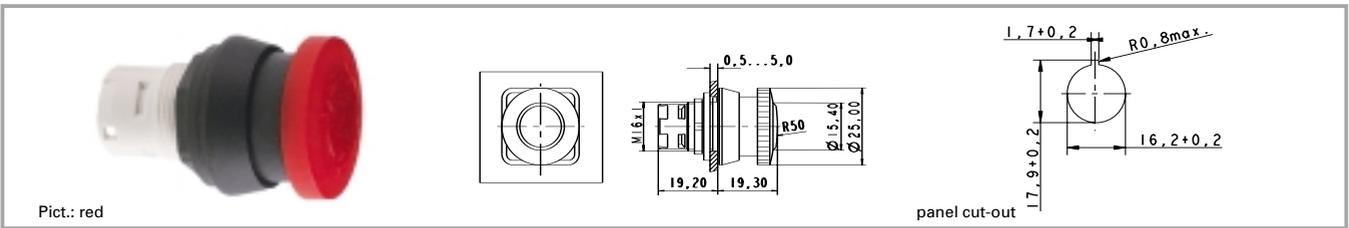

illuminability	Colour of button	Order no. complete
yes	translucent red	1.30.074.521/0304

Technical data see page 2 - 34

Only use universal contact blocks.

2

RAFIX 16

RAFIX 16 emergency stop pushbutton, round collar, dupe-proof

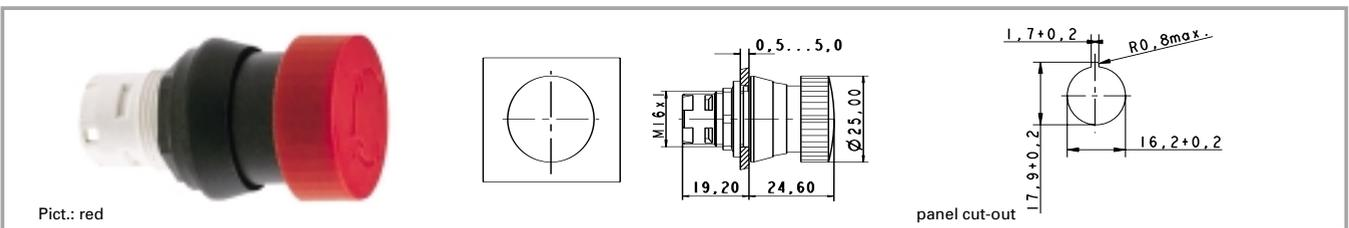

illuminability	Colour of button	Order no. complete
no	opaque red	1.30.074.121/0301

Technical data see page 2 - 34

Only use universal contact blocks.

The positively driven mechanical arrangement is dupe-proof to EN 418.

RAFIX 16

RAFIX 16 emergency stop pushbutton, square collar, alignable without gaps, illuminated

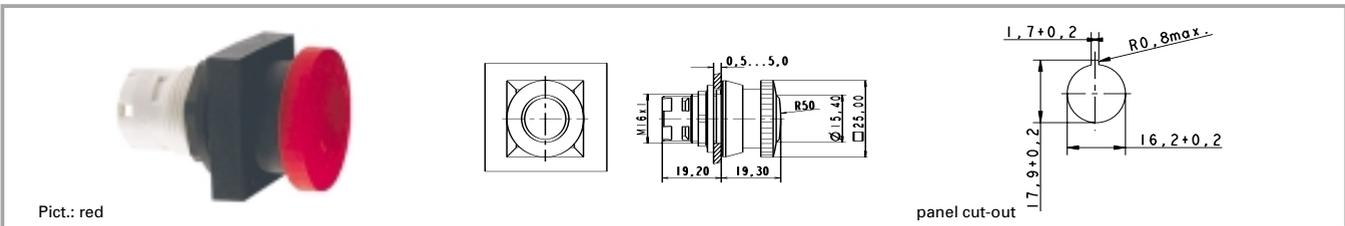

illuminability	Colour of button	Order no. complete
yes	translucent red	1.30.074.541/0304

Technical data see page 2 - 34

Only use universal contact blocks.

RAFIX 16 emergency stop pushbutton, square collar, alignable without gaps, dupe-proof

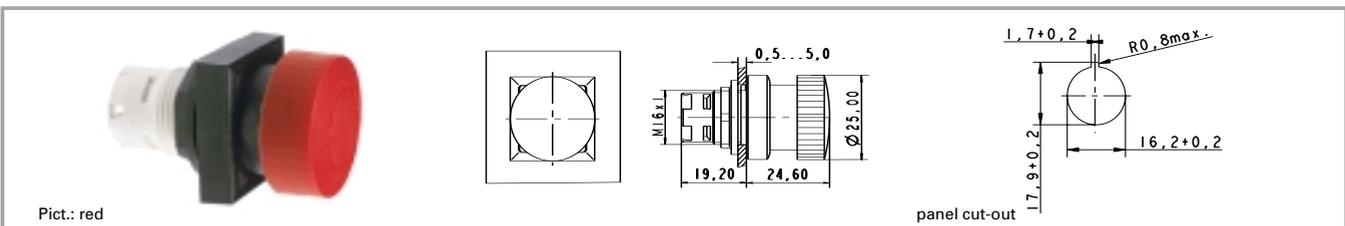

illuminability	Colour of button	Order no. complete
no	opaque red	1.30.074.141/0301

Technical data see page 2 - 34

Only use universal contact blocks.

The positively driven mechanical arrangement is dupe-proof to EN 418.

2

RAFIX 16

RAFIX 16 safety emergency stop pushbutton, round collar, dupe-proof, non-blocking

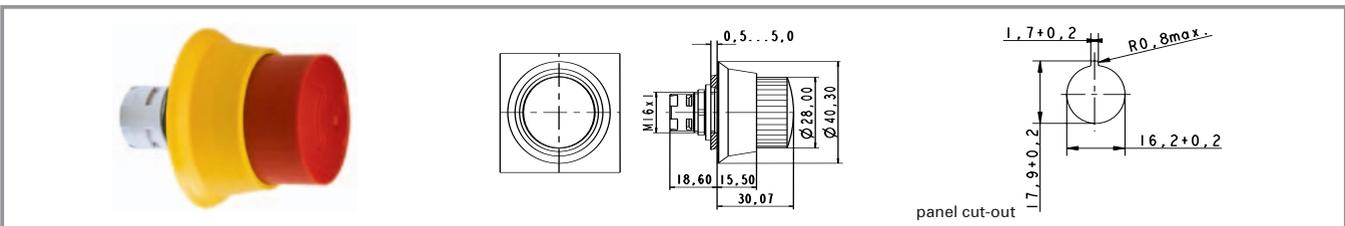

illuminability	Colour of button	Order no. complete
no	opaque red, collar yellow	1.30.074.821/0000

Technical data see page 2 - 34

Only use universal contact blocks.

The positively driven mechanical arrangement is dupe-proof to EN 418.

Special shape prevents blocking: Actuation cannot be interrupted by any jamming objects.

2

RAFIX
16

RAFIX 16 safety emergency stop pushbutton, round collar, conical, dupe-proof, non-blocking

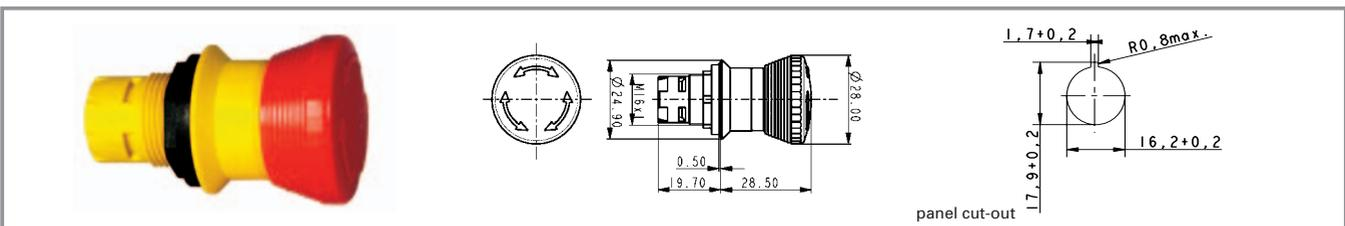

illuminability	Colour of button	Order no. complete
no	opaque red, collar yellow	1.30.074.281/0300

Technical data see page 2 - 34

Only use universal contact blocks.

The positively driven mechanical arrangement is dupe-proof to EN 418.

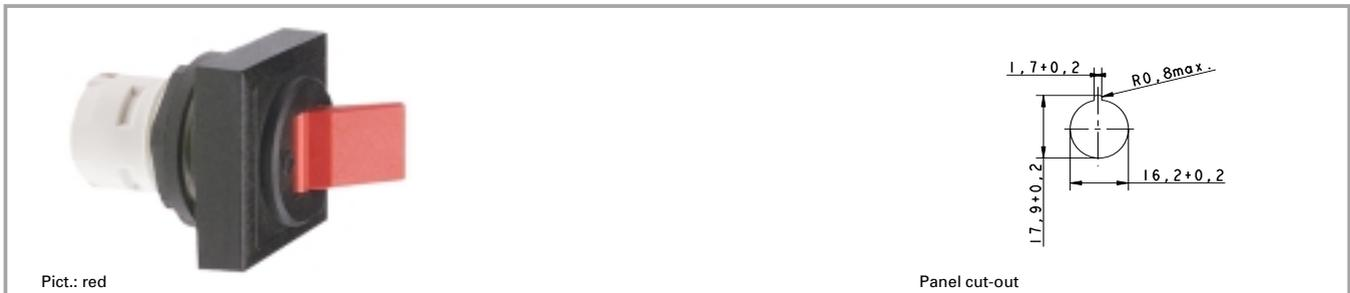
RAFIX 16 toggle switch**2**RAFIX
16**Technical data****General information**

Form of lens	toggle
Colour of toggle	see order block
Form of collar	see order block

Dimensions

Length of collar	see order block
Diameter of collar	see order block
Key grid	25 x 25 mm
Width of collar	see order block
Overall height	18.4 mm
Mounting depth	44.7 mm
Mounting hole	16.2 mm

Mechanical design

Mounting	ring nut
Contact function	latching
Contact arrangement	according to contact block
Illuminability	no

Mechanical characteristics

Robustness min.	100 N
-----------------	-------

Other specifications

Degree of protection from front side	IP65
Ambient temp. operating min.	-25 °C
Ambient temp. operating without lamp max.	+70 °C
Ambient temp. operating with lamp max.	+55 °C
Storage temperature min.	-40 °C
Storage temperature max.	+85 °C
Resistance to constant environment	according to IEC 600 68-2-3 and 2-30
Resistance at variable environment	according to IEC 600 68-2-14 and 2-33
Operating life (operations)	300000

Accessories RAFIX 16 toggle switch

Description	Photo	Order no.	Page
RAFIX 16 standard contact block, 1 NC + 1 NO, momentary, silver contacts, without lamp socket		1.20.122.021/0000	2 - 64
RAFIX 16 standard contact block, 1 NC + 1 NO, momentary, gold contacts, without lamp socket		1.20.122.031/0000	2 - 60
Label holder, flush, for square collar		5.07.620.004/0000	2 - 76
Fixing spanner for hexagon nut		5.58.002.034/0000	2 - 75

For other contact blocks, refer to the chapter „RAFIX 16 contact blocks“; for additional accessories, refer to the chapter „RAFIX 16 special accessories“.

RAFIX 16

RAFIX 16 toggle switch, square collar

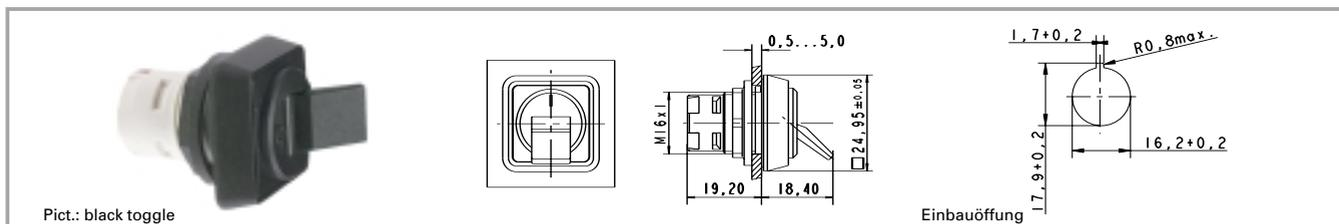

Contact function	Illuminability	Colour of toggle	Order no. complete
latching	no	opaque black	1.30.075.001/0100
latching	no	opaque red	1.30.075.001/0300

Technical data see page 2 - 40

Only use contact blocks with "momentary" contact function.

2

RAFIX
16

RAFIX 16 toggle switch, round collar

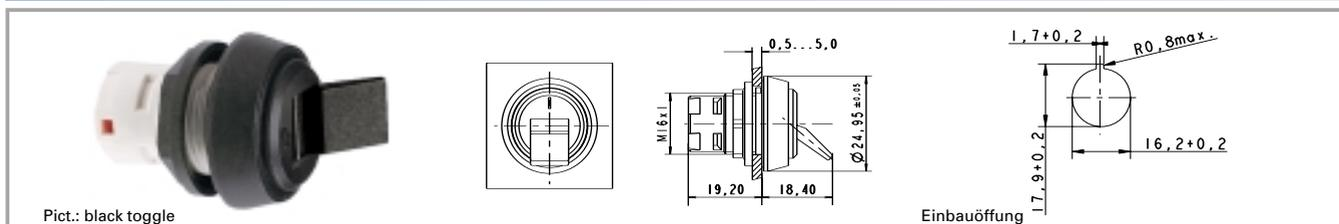

Contact function	Illuminability	Colour of toggle	Order no. complete
latching	no	opaque black	1.30.075.021/0100
latching	no	opaque red	1.30.075.021/0300

Technical data see page 2 - 40

Only use contact blocks with "momentary" contact function.

RAFIX 16 toggle switch, square collar, alignable without gaps

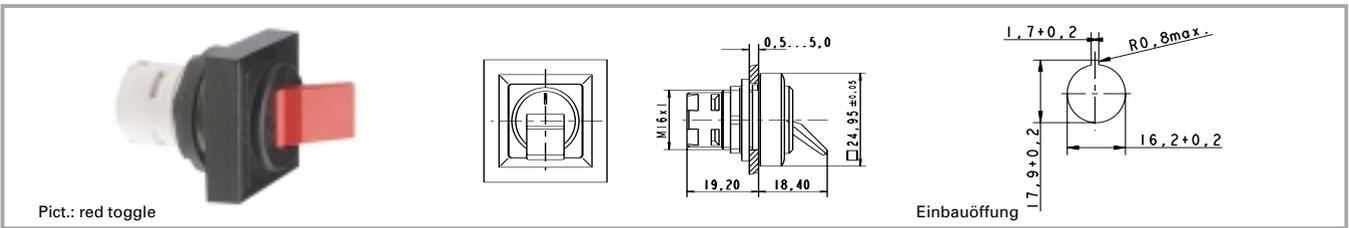

Contact function	Illuminability	Colour of toggle	Order no. complete
latching	no	opaque black	1.30.075.041/0100
latching	no	opaque red	1.30.075.041/0300

Technical data see page 2 - 40

Only use contact blocks with "momentary" contact function.

2

RAFIX
16

RAFIX 16 potentiometer drive

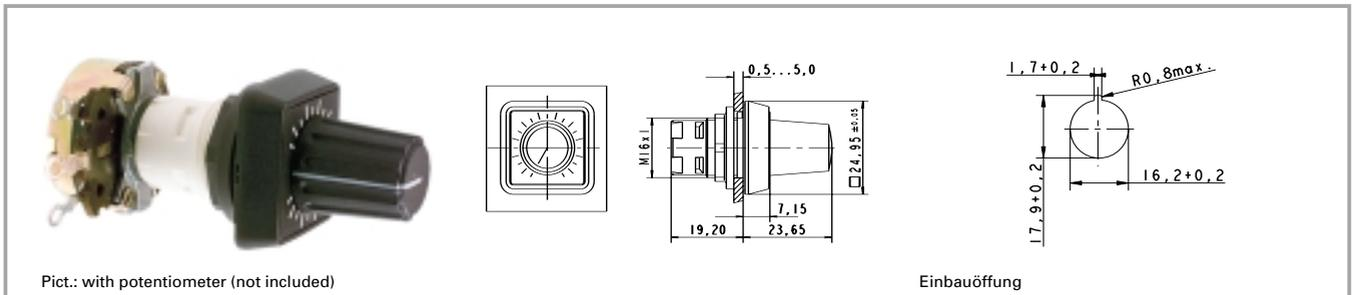

Pict.: with potentiometer (not included)

Einbauöffnung

2

RAFIX 16

Technical data

General information

Form of lens handle
 Colour of handle black
 Form of collar see order block

Dimensions

Length of collar see order block
 Diameter of collar see order block
 Key grid 25 x 25 mm
 Width of collar see order block
 Overall height 23.65 mm
 Mounting depth 19.2 mm
 Mounting hole 16.2 mm

Mechanical design

Mounting ring nut

Other specifications

Degree of protection from front side IP65
 Ambient temp. operating min. -25 °C
 Ambient temp. operating max. +70 °C
 Storage temperature min. -40 °C
 Storage temperature max. +85 °C
 Resistance to constant environment IEC 600 68-2-3 and 2-30
 Resistance at variable environment IEC 600 68-2-14 and 2-33

Accessories Potentiometer drive

Description	Photo	Order no.	Page
Label holder, flush, for square collar		5.07.620.004/0000	2 - 76
Fixing spanner for hexagon nut		5.58.002.034/0000	2 - 75

For additional accessories, refer to the chapter „RAFIX 16 special accessories“.

RAFIX 16

RAFIX 16 potentiometer drive, square collar

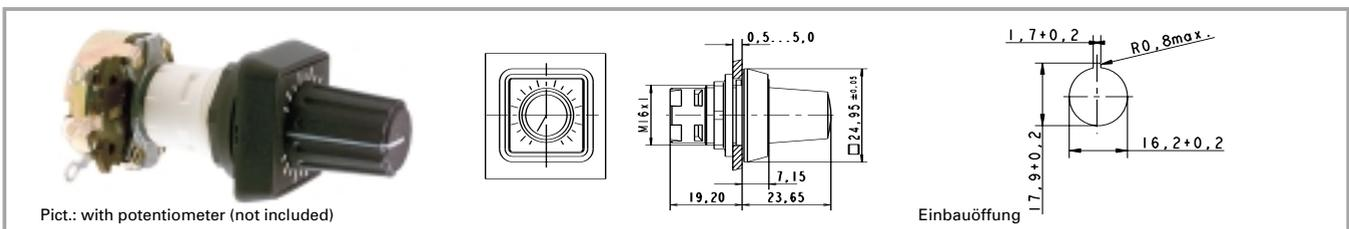

Form of lens	Form of collar	Colour of handle	Order no. complete
handle	square	black	1.30.077.001/0000

Technical data see page 2 - 44

To operate potentiometers with a shaft diameter of 6 mm.
Suitable for potentiometers to DIN 41 450 with a shaft length of 32 mm.
Potentiometer not included.

2

RAFIX
16

RAFIX 16 potentiometer drive, round collar

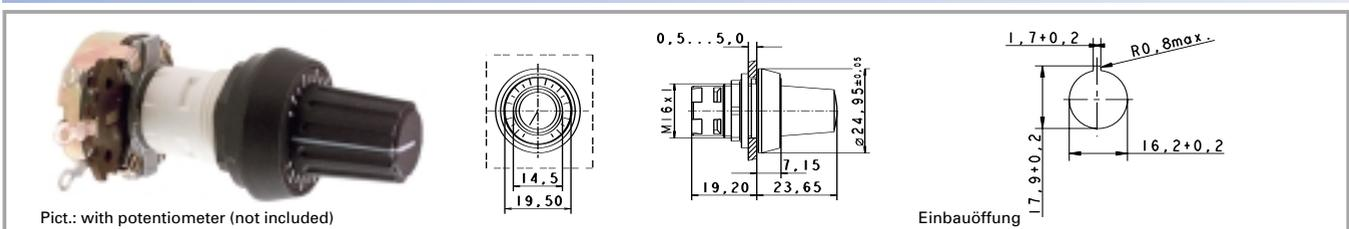

Form of lens	Form of collar	Colour of handle	Order no. complete
handle	round	black	1.30.077.021/0000

Technical data see page 2 - 44

To operate potentiometers with a shaft diameter of 6 mm.
Suitable for potentiometers to DIN 41 450 with a shaft length of 32 mm.
Potentiometer not included.

RAFIX 16 potentiometer drive, square collar, alignable without gaps

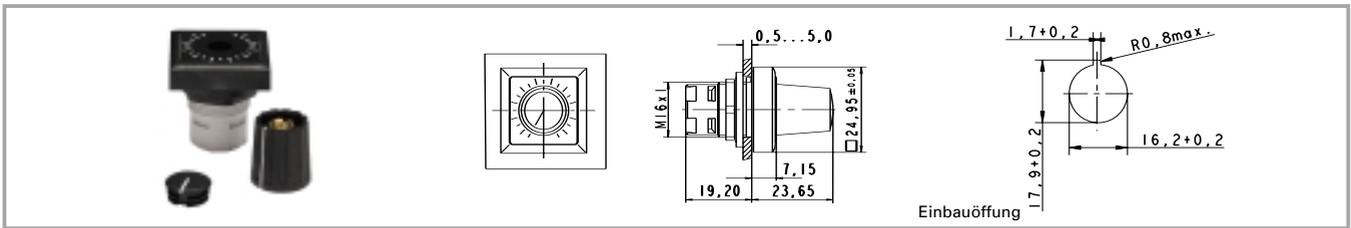

Form of lens	Form of collar	Colour of handle	Order no. complete
handle	square alignable	black	1.30.077.041/0000

2

Technical data see page 2 - 44

To operate potentiometers with a shaft diameter of 6 mm.
Suitable for potentiometers to DIN 41 450 with a shaft length of 32 mm.
Potentiometer not included.

RAFIX
16

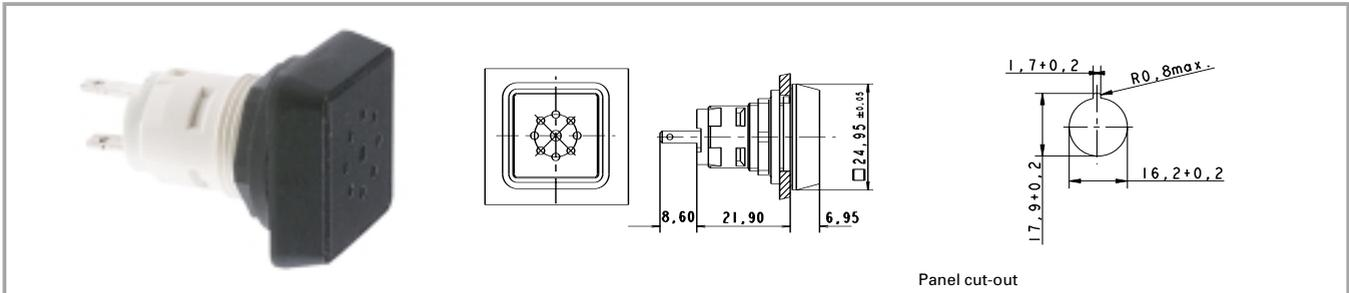
RAFIX 16 buzzer**2****Technical data****General information**

Form of lens	flat lens
Colour of lens	opaque black
Form of collar	see order block
Sound	see order block

Dimensions

Length of collar	see order block
Diameter of collar	see order block
Key grid	25 x 25 mm
Width of collar	see order block
Overall height	6.95 mm
Mounting depth	30.5 mm
Mounting hole	16.2 mm

Mechanical design

Mounting	ring nut
----------	----------

Acoustic characteristics

Sonic pressure, 1 m distance min.	see order block
-----------------------------------	-----------------

Electrical characteristics

Operating voltage DC	24 V
Input current	see order block

Mechanical characteristics

Robustness min.	100 N
-----------------	-------

Other specifications

Degree of protection from front side	IP65
Ambient temp. operating min.	-25 °C
Ambient temp. operating max.	+70 °C
Storage temperature min.	-40 °C
Storage temperature max.	+85 °C
Resistance to constant environment	according to IEC 600 68-2-3 and 2-30
Resistance at variable environment	according to IEC 600 68-2-14 and 2-33

Accessories RAFIX 16 buzzer

Description	Photo	Order no.	Page
Fixing spanner for hexagon nut		5.58.002.034/0000	2 - 75

For additional accessories, refer to the chapter „RAFIX 16 special accessories“.

RAFIX 16

RAFIX 16 buzzer, square collar

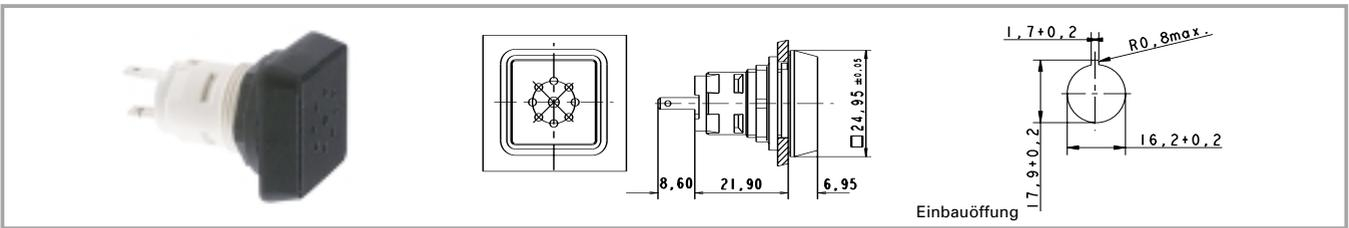

Sound	Operating voltage DC	Input current	Sonic pressure, 1 m distance min.	Order no. complete
continuos beep	24 V	25 mA	70 dB	1.30.078.001/0100

Technical data see page 2 - 48

12 V DC available on request.

2

RAFIX 16 buzzer, round collar

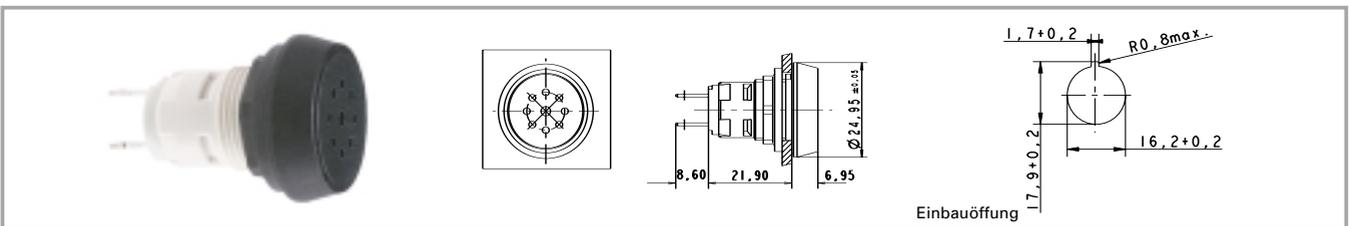

Sound	Operating voltage DC	Input current	Sonic pressure, 1 m distance min.	Order no. complete
continuos beep	24 V	25 mA	70 dB	1.30.078.021/0100

Technical data see page 2 - 48

12 V DC available on request.

RAFIX
16

RAFIX 16 buzzer, square collar, alignable without gaps

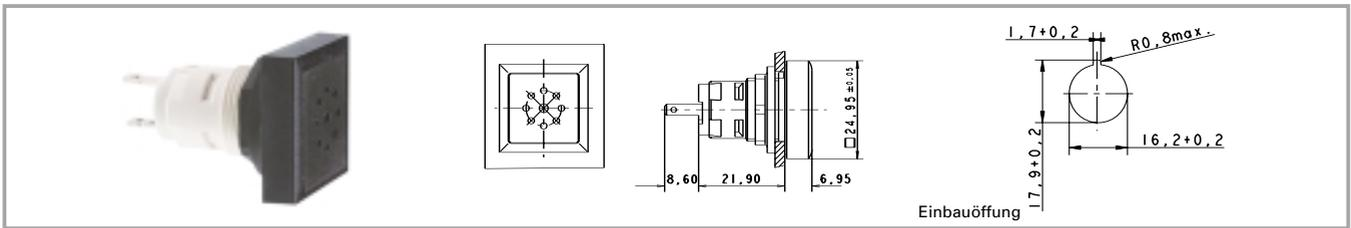

Sound	Operating voltage DC	Input current	Sonic pressure, 1 m distance min.	Order no. complete
continuos beep	24 V	25 mA	70 dB	1.30.078.041/0100

Technical data see page 2 - 48

12 V DC available on request.

2

RAFIX
16

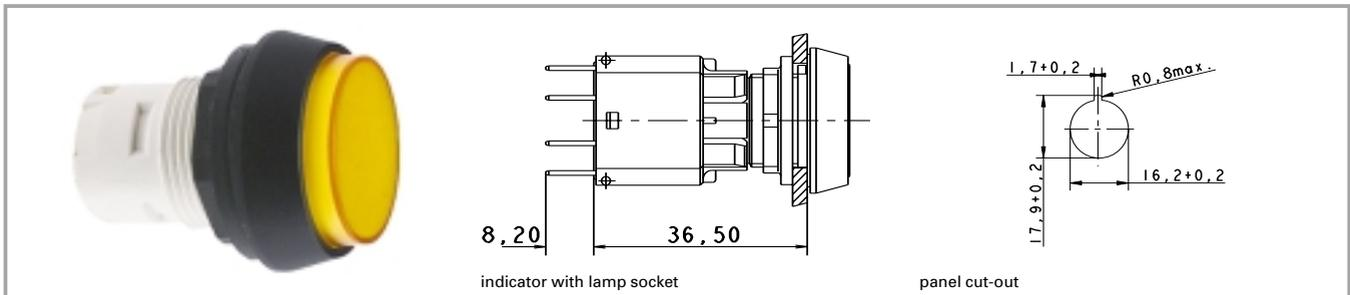
RAFIX 16 signal indicator**2**RAFIX
16**Technical data****General information**

Form of lens	see order block
Colour of lens	see order block
Form of collar	see order block

Dimensions

Length of collar	see order block
Diameter of collar	see order block
Key grid	25 x 25 mm
Width of collar	see order block
Overall height	see order block
Mounting depth	30.5/44.7 mm
Mounting hole	16.2 mm

Mechanical design

Mounting	ring nut
Illuminability	yes

Mechanical characteristics

Robustness min.	100 N
-----------------	-------

Other specifications

Degree of protection from front side	IP65
Ambient temp. operating min.	-25 °C
Ambient temp. operating without lamp max.	+70 °C
Ambient temp. operating with lamp max.	+55 °C
Storage temperature min.	-40 °C
Storage temperature max.	+85 °C
Resistance to constant environment	according to IEC 600 68-2-3 and 2-30
Resistance at variable environment	according to IEC 600 68-2-14 and 2-33

Accessories RAFIX 16 signal indicator

Description	Photo	Order no.	Page
RAFIX 16 lamp socket W 2 x 4.6 d		1.71.212.001/0000	2 - 67
RAFIX 16 lamp socket W 2 x 4.6 d		1.71.212.011/0000	2 - 68
LED W 2 x 4.6d superbright, white, 24 V		1.90.690.365/0000	5 - 16
Disassembly tool for LUMOTAST 25, RAFIX 16		5.05.800.042/0000	2 - 74 5 - 26
Label holder, flush, for square collar		5.07.620.004/0000	2 - 76
Fixing spanner for hexagon nut		5.58.002.034/0000	2 - 75

For suitable LEDs and filament lamps, refer to the chapter „RAFIX 16 lamp sockets“; for additional accessories, refer to the chapter „RAFIX 16 special accessories“.

RAFIX 16

RAFIX 16 signal indicator, square lens

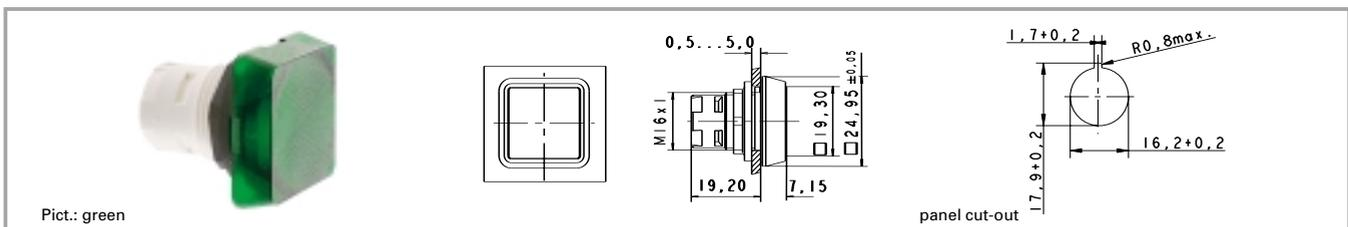

Form of lens	Form of collar	Colour of lens	Order no. complete	Order no. single parts	
				Housing	Lens
lens square		transparent colourless	1.65.124.001/1002	1.65.124.101/0000	5.49.263.006/1002
lens square		transparent red	1.65.124.001/1306	1.65.124.101/0000	5.49.263.006/1306
lens square		transparent yellow	1.65.124.001/1403	1.65.124.101/0000	5.49.263.006/1403
lens square		transparent green	1.65.124.001/1505	1.65.124.101/0000	5.49.263.006/1505
lens square		transparent blue	1.65.124.001/1607	1.65.124.101/0000	5.49.263.006/1607

Technical data see page 2 - 52

Legending can only be made externally on a label holder.

RAFIX 16 signal indicator, square collar, flush lens

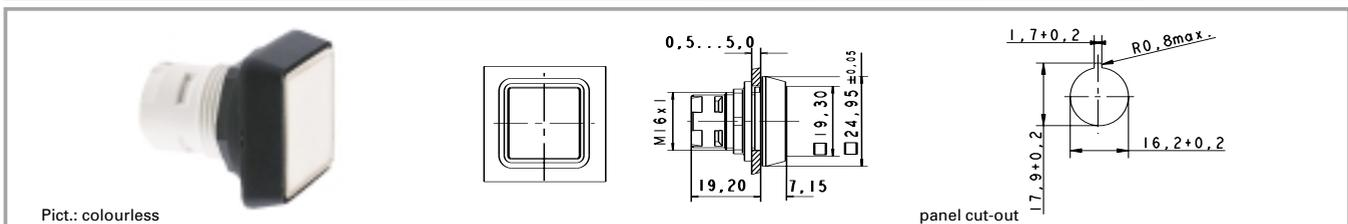

Form of lens	Form of collar	Colour of lens	Order no. complete	Order no. single parts	
				Housing	Lens
flat lens	square	transparent colourless	1.65.124.301/1002	1.65.124.401/0000	5.49.077.011/1002
flat lens	square	transparent red	1.65.124.301/1306	1.65.124.401/0000	5.49.077.011/1306
flat lens	square	transparent yellow	1.65.124.301/1403	1.65.124.401/0000	5.49.077.011/1403
flat lens	square	transparent green	1.65.124.301/1505	1.65.124.401/0000	5.49.077.011/1505
flat lens	square	transparent blue	1.65.124.301/1607	1.65.124.401/0000	5.49.077.011/1607

Technical data see page 2 - 52

Accessories:

Legend insert, blank, use only for transparent lenses: 5.70.635.000/2000

RAFIX 16 signal indicator, square collar, protruding lens

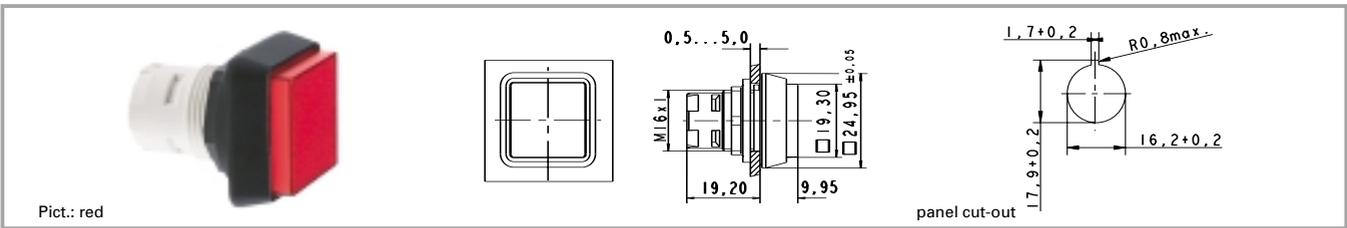

Form of lens	Form of collar	Colour of lens	Order no. complete	Order no. single parts	
				Housing	Lens
protruding lens	square	transparent colourless	1.65.124.351/1002	1.65.124.451/0000	5.49.077.012/1002
protruding lens	square	transparent red	1.65.124.351/1306	1.65.124.451/0000	5.49.077.012/1306
protruding lens	square	transparent yellow	1.65.124.351/1403	1.65.124.451/0000	5.49.077.012/1403
protruding lens	square	transparent green	1.65.124.351/1505	1.65.124.451/0000	5.49.077.012/1505
protruding lens	square	transparent blue	1.65.124.351/1607	1.65.124.451/0000	5.49.077.012/1607

Technical data see page 2 - 52

Accessories:

Legend insert, blank, use only for transparent lenses: 5.70.635.000/2000

RAFIX 16 signal indicator, round lens

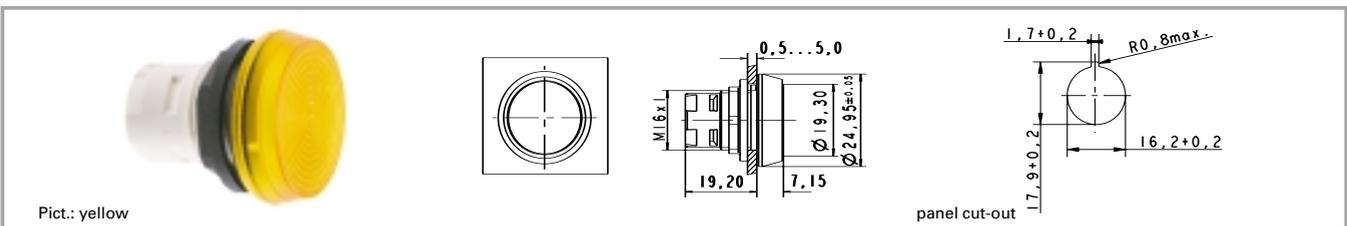

Form of lens	Form of collar	Colour of lens	Order no. complete	Order no. single parts	
				Housing	Lens
lens round	round	transparent colourless	1.65.124.021/1002	1.65.124.101/0000	5.49.263.007/1002
lens round	round	transparent red	1.65.124.021/1306	1.65.124.101/0000	5.49.263.007/1306
lens round	round	transparent yellow	1.65.124.021/1403	1.65.124.101/0000	5.49.263.007/1403
lens round	round	transparent green	1.65.124.021/1505	1.65.124.101/0000	5.49.263.007/1505
lens round	round	transparent blue	1.65.124.021/1607	1.65.124.101/0000	5.49.263.007/1607

Technical data see page 2 - 52

Accessories:

Legending can only be made externally on a label holder.

RAFIX 16

RAFIX 16 signal indicator, round collar, flush lens

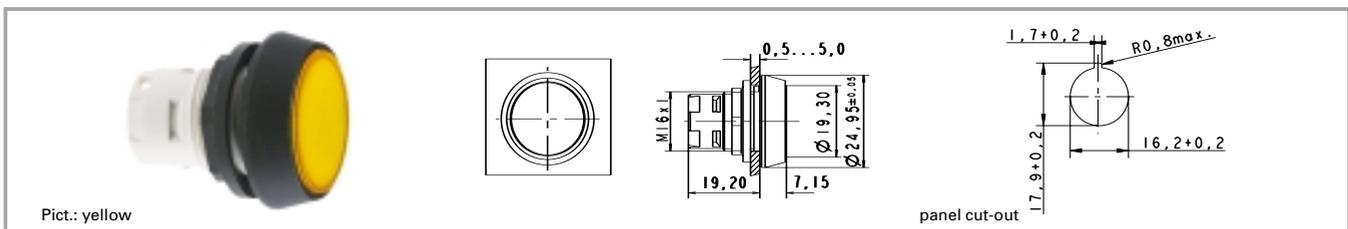

Form of lens	Form of collar	Colour of lens	Order no. complete	Order no. single parts	
				Housing	Lens
flat lens	round	transparent colourless	1.65.124.321/1002	1.65.124.421/0000	5.49.259.017/1002
flat lens	round	transparent red	1.65.124.321/1306	1.65.124.421/0000	5.49.259.017/1306
flat lens	round	transparent yellow	1.65.124.321/1403	1.65.124.421/0000	5.49.259.017/1403
flat lens	round	transparent green	1.65.124.321/1505	1.65.124.421/0000	5.49.259.017/1505
flat lens	round	transparent blue	1.65.124.321/1607	1.65.124.421/0000	5.49.259.017/1607

Technical data see page 2 - 52

Accessories:

Legend insert, blank, use only for transparent lenses: 5.70.637.000/2000

RAFIX 16 signal indicator, round collar, protruding lens

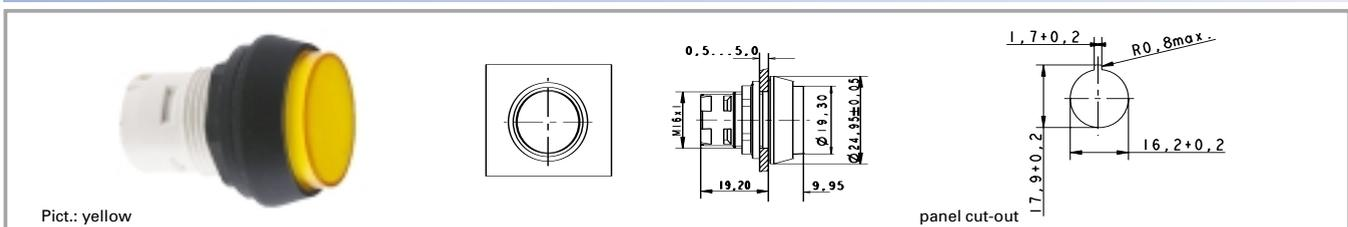

Form of lens	Form of collar	Colour of lens	Order no. complete	Order no. single parts	
				Housing	Lens
protruding lens	round	transparent colourless	1.65.124.371/1002	1.65.124.471/0000	5.49.259.018/1002
protruding lens	round	transparent red	1.65.124.371/1306	1.65.124.471/0000	5.49.259.018/1306
protruding lens	round	transparent yellow	1.65.124.371/1403	1.65.124.471/0000	5.49.259.018/1403
protruding lens	round	transparent green	1.65.124.371/1505	1.65.124.471/0000	5.49.259.018/1505
protruding lens	round	transparent blue	1.65.124.371/1607	1.65.124.471/0000	5.49.259.018/1607

Technical data see page 2 - 52

Accessories:

Legend insert, blank, use only for transparent lenses: 5.70.637.000/2000

RAFIX 16 signal indicator, square collar, alignable without gaps, flush lens

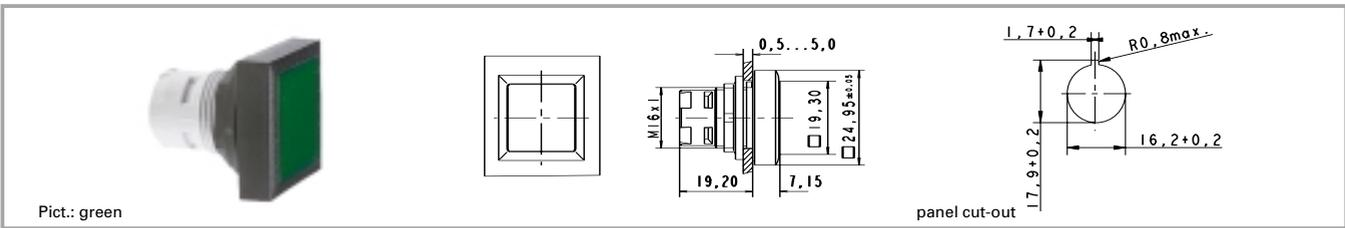

Form of lens	Form of collar	Colour of lens	Order no. complete	Order no. single parts	
				Housing	Lens
flat lens	square alignable	transparent colourless	1.65.124.551/1002	1.65.124.651/0000	5.49.077.011/1002
flat lens	square alignable	transparent red	1.65.124.551/1306	1.65.124.651/0000	5.49.077.011/1306
flat lens	square alignable	transparent yellow	1.65.124.551/1403	1.65.124.651/0000	5.49.077.011/1403
flat lens	square alignable	transparent green	1.65.124.551/1505	1.65.124.651/0000	5.49.077.011/1505
flat lens	square alignable	transparent blue	1.65.124.551/1607	1.65.124.651/0000	5.49.077.011/1607

Technical data see page 2 - 52

Accessories:

Legend insert, blank, use only for transparent lenses: 5.70.635.000/2000

RAFIX 16 signal indicator, square collar, alignable without gaps, protruding lens

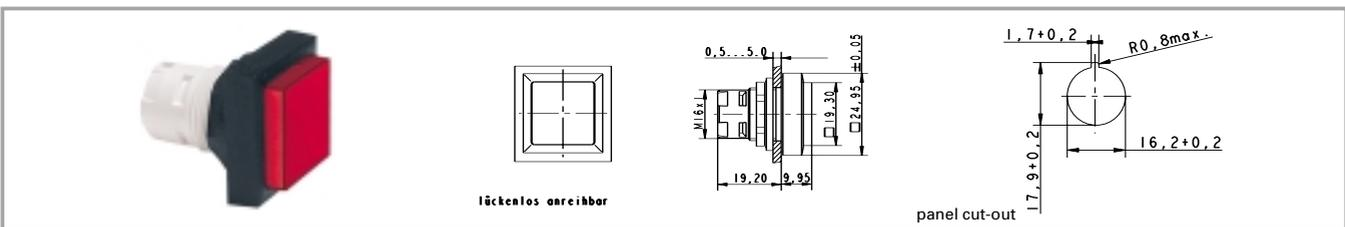

Form of lens	Form of collar	Colour of lens	Order no. complete	Order no. single parts	
				Housing	Lens
protruding lens	square alignable	transparent colourless	1.65.124.501/1002	1.65.124.661/0000	5.49.077.012/1002
protruding lens	square alignable	transparent red	1.65.124.501/1306	1.65.124.661/0000	5.49.077.012/1306
protruding lens	square alignable	transparent yellow	1.65.124.501/1403	1.65.124.661/0000	5.49.077.012/1403
protruding lens	square alignable	transparent green	1.65.124.501/1505	1.65.124.661/0000	5.49.077.012/1505
protruding lens	square alignable	transparent blue	1.65.124.501/1607	1.65.124.661/0000	5.49.077.012/1607

Technical data see page 2 - 52

Accessories:

Legend insert, blank, use only for transparent lenses: 5.70.635.000/2000

2

RAFIX 16

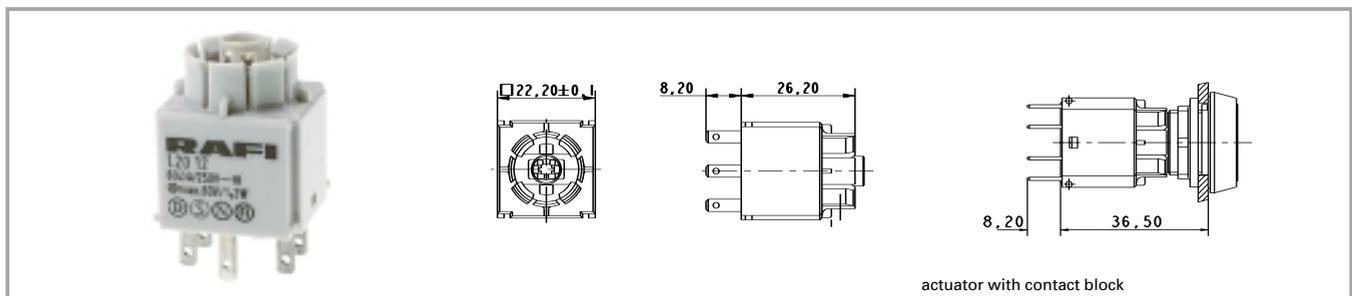
RAFIX 16 contact blocks with gold contacts

2
Technical data
Dimensions

Length	22.2 mm
Width	22.2 mm
Height	34.4 mm
Mounting depth (with actuator / indicator)	44.7 mm

Mechanical design

Mounting	snap on actuator
Contact system	bridgecontact self cleaning
Contact materials	Au
Contact arrangement	see order block
Contact function	see order block
Lamp socket	see order block
Terminals	quick connector 2.8 x 0.8
Terminal marking	according to DIN 50013, X1 = +, X2 = -
Operating travel	3 mm
Robustness	100 N

Mechanical characteristics

Robustness	acc. IEC 60947-5-5
------------	--------------------

Electrical characteristics

Rated voltage min.	0.02 V
Rated voltage max. (AC/DC)	42 V
Rated current min.	0.001 A
Rated current max.	0.25 A

Operating life switching element (momentary)	2000000
Contact resistance when new max.	50 mΩ

Other specifications

Protection class	II
Shock resistance acc. to IEC 60068-2-27	amplitude < 50g, 11ms, half sinusoidal
Ambient temp. operating min.	-25 °C
Ambient temp. operating without lamp max.	+70 °C
Ambient temp. operating with lamp max.	+55 °C
Storage temperature min.	-40 °C
Storage temperature max.	+85 °C
Colour code	white bottom
Resistance to constant environment	IEC 600 68-2-3 and 2-30
Resistance at variable environment	IEC 600 68-2-14 and 2-33
Mechanical operating life latching (operations)	see order block
Resistance to vibrations acc. to IEC 60068-2-6	10 g at 20 ... 500 Hz

Accessories RAFIX 16 contact blocks with gold contacts

Description	Photo	Order no.	Page
Filament lamp, W 2 x 4.6d base, 24 - 30 V		1.90.120.005/0000	5 - 4
Filament lamp, W 2 x 4.6d base, 60 V		1.90.120.009/0000	5 - 4
Filament lamp, W 2 x 4.6d base, 48 V		1.90.120.010/0000	5 - 4
Filament lamp, W 2 x 4.6d base, 24 V		1.90.120.011/0000	5 - 4

RAFIX 16

Accessories RAFIX 16 contact blocks with gold contacts

Description	Photo	Order no.	Page
Filament lamp, W 2 x 4.6d base, 12 V		1.90.120.012/0000	5 - 4
Filament lamp, W 2 x 4.6d base, 6 V		1.90.120.013/0000	5 - 4
LED W 2 x 4.6d superbright, red, 24 V		1.90.690.361/0000	5 - 16
LED W 2 x 4.6d superbright, green, 24 V		1.90.690.362/0000	5 - 16
LED W 2 x 4.6d superbright, yellow, 24 V		1.90.690.363/0000	5 - 16
LED W 2 x 4.6d superbright, blue, 24 V		1.90.690.364/0000	5 - 16
LED W 2 x 4.6d superbright, white, 24 V		1.90.690.365/0000	5 - 16
Multipole connector		5.05.510.421/0000	2 - 71
PCB plug-in socket, 10 contacts (universal application)		5.05.510.644/0000	2 - 70
Female quick-connect terminal DIN 46340-B 2.8-1-MS		5.37.540.024/8622	2 - 71
Plug distributor		5.37.540.029/6000	2 - 72
Protection against contact		5.55.103.105/0100	2 - 72

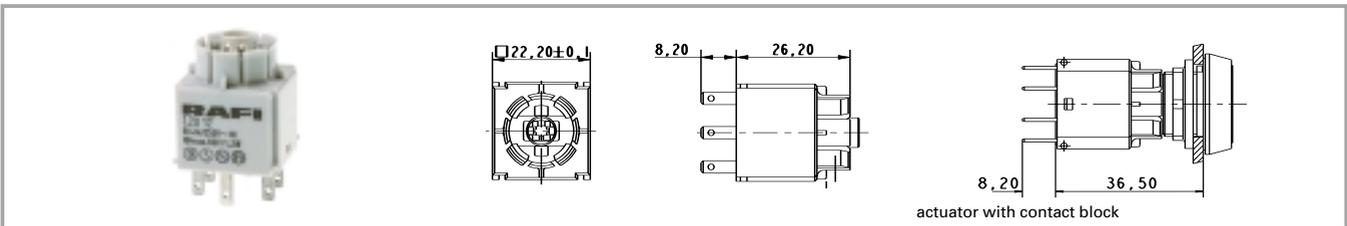
RAFIX 16 standard contact block, gold contacts, with lamp socket

Contact function	Contact arrangement	Lamp socket	Rated voltage max. (AC/DC)	Rated current max.	Order no. complete
momentary	1 NC + 1 NO	W 2 x 4.6d	42 V	0.25 A	1.20.122.011/0000
momentary	2 NO	W 2 x 4.6d	42 V	0.25 A	1.20.122.012/0000
momentary	2 NC	W 2 x 4.6d	42 V	0.25 A	1.20.122.013/0000
latching	1 NC + 1 NO	W 2 x 4.6d	42 V	0.25 A	1.20.122.051/0000
latching	2 NO	W 2 x 4.6d	42 V	0.25 A	1.20.122.052/0000

Technical data see page 2 - 58

Standard contact blocks have one common contact chamber and one actuator plunger.

Contact blocks with "latching" contact function are used as switches.

When combined with pushbuttons and mushroom actuators, the switching position is visible, releasing is effected by actuating again.

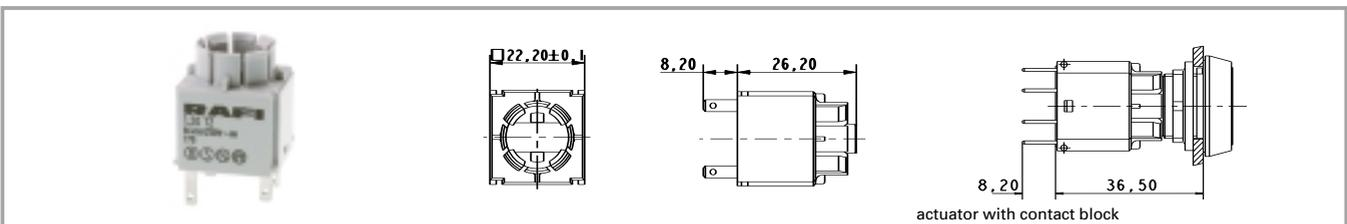
RAFIX 16 standard contact block, gold contacts, without lamp socket

Contact function	Contact arrangement	Lamp socket	Rated voltage max. (AC/DC)	Rated current max.	Order no. complete
momentary	1 NC + 1 NO		42 V	0.25 A	1.20.122.031/0000
momentary	2 NO		42 V	0.25 A	1.20.122.032/0000
momentary	2 NC		42 V	0.25 A	1.20.122.033/0000
latching	1 NC + 1 NO		42 V	0.25 A	1.20.122.071/0000
latching	2 NO		42 V	0.25 A	1.20.122.072/0000

Technical data see page 2 - 58

Standard contact blocks have one common contact chamber and one actuator plunger.

Contact blocks with "latching" contact function are used as switches.

When combined with pushbuttons and mushroom actuators, the switching position is visible, releasing is effected by actuating again.

RAFIX 16

RAFIX 16 universal contact block, gold contacts, with lamp socket

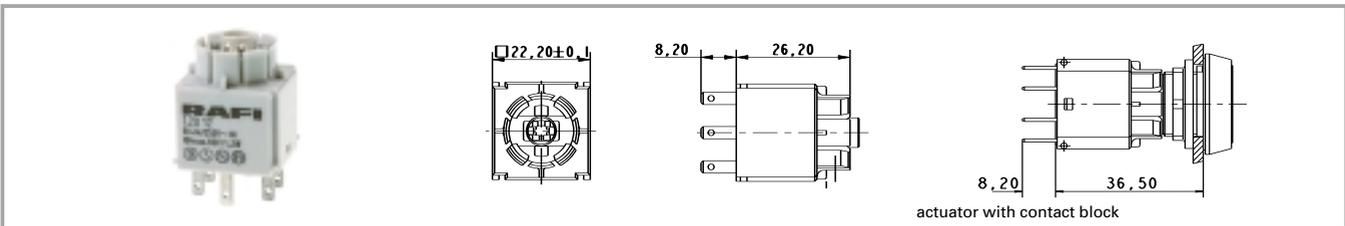

Contact function	Contact arrangement	Lamp socket	Rated voltage max. (AC/DC)	Rated current max.	Order no. complete
momentary	1 NC + 1 NO	W 2 x 4.6d	42 V	0.25 A	1.20.123.011/0000
momentary	1 NC	W 2 x 4.6d	42 V	0.25 A	1.20.123.012/0000
momentary	1 NO	W 2 x 4.6d	42 V	0.25 A	1.20.123.013/0000
momentary	2 NC	W 2 x 4.6d	42 V	0.25 A	1.20.123.014/0000
momentary	2 NO	W 2 x 4.6d	42 V	0.25 A	1.20.123.015/0000

Technical data see page 2 - 58

Universal contact blocks have two separate contact chambers and two actuator plungers for alternating actuation directions. Two different polarities can be switched. The NC contacts are positive opening contacts to IEC 60947-5-1.

RAFIX 16 universal contact block, gold contacts, without lamp socket

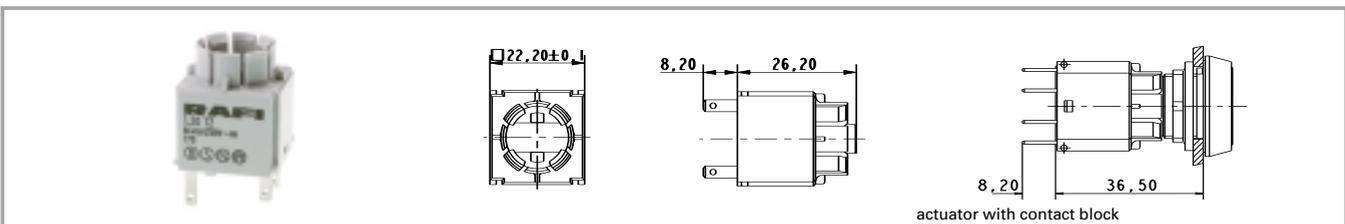

Contact function	Contact arrangement	Lamp socket	Rated voltage max. (AC/DC)	Rated current max.	Order no. complete
momentary	1 NC + 1 NO		42 V	0.25 A	1.20.123.031/0000
momentary	1 NC		42 V	0.25 A	1.20.123.032/0000
momentary	1 NO		42 V	0.25 A	1.20.123.033/0000
momentary	2 NC		42 V	0.25 A	1.20.123.034/0000
momentary	2 NO		42 V	0.25 A	1.20.123.035/0000

Technical data see page 2 - 58

Universal contact blocks have two separate contact chambers and two actuator plungers for alternating actuation directions. Two different polarities can be switched. The NC contacts are positive opening contacts to IEC 60947-5-1.

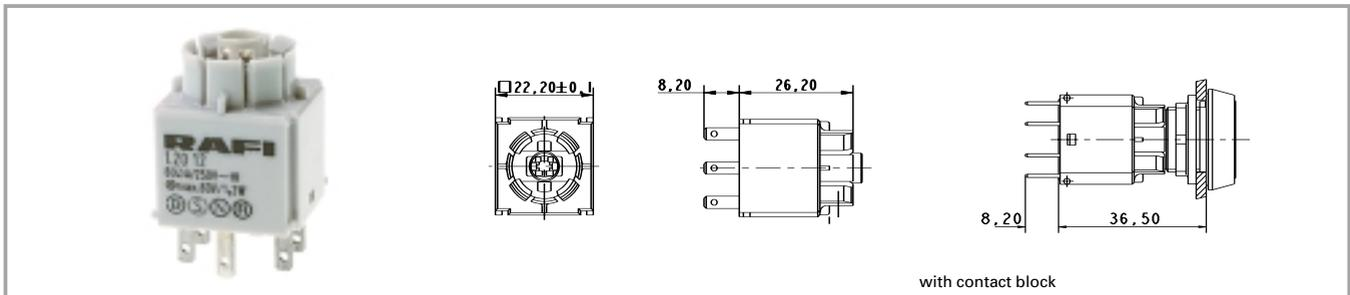
RAFIX 16 contact blocks with silver contacts

2
Technical data
Dimensions

Length	22.2 mm
Width	22.2 mm
Height	34.4 mm
Mounting depth (with actuator / indicator)	44.7 mm

Mechanical design

Mounting	snap on actuator
Contact system	bridgecontact self cleaning
Contact materials	Ag
Contact arrangement	see order block
Contact function	see order block
Lamp socket	see order block
Terminals	quick connector 2.8 x 0.8
Terminal marking	according to DIN 50013, X1 = +, X2 = -
Operating travel	3 mm
Robustness	100 N

Mechanical characteristics

Robustness	acc. IEC 60947-5-5
------------	--------------------

Electrical characteristics

Rated insulation voltage acc. to VDE 0110, AC	250 V
Rated insulation voltage acc. to VDE 0110, DC	300 V
Ohmic rated current I_R	6 A
Rated motor current $I_{M\text{ nenn}}$	4 A
Application category acc. to VDE 0660 Teil 200	AC 15B 300 V
Application category acc. to VDE 0660 Teil 200	DC 13Q 300 V
Rated insulation voltage U_i , AC	250 V
Rated insulation voltage U_i , DC	300 V
Rated voltage U_E / Rated current I_E , AC	250 V/1,5 A, 120 V/3,0 A V
Rated voltage U_E / Rated current I_E , DC	250 V/0,27 A, 125 V/0,55 A, 60 V/1 A, 24 V/2 A V

Thermic rated current

I_{the} , AC	5 A
Thermic rated current I_{the} , DC	2.5 A
Operating life switching element AC	100000 at 6A, 800000 at 2A
Operating life switching element DC	250000 at 220 V/0.2 A, 1000000 at 24 V/2 A
Rated power DC	$10 \times I_E$
Rated power AC	$1.1 \times I_E$
Contact resistance when new max.	20 m Ω

Other specifications

Protection class	II
Approvals	ENEC 25 T 70 (55), UL, CSA
Corresponding to EU directive N 72/73	yes
Shock resistance acc. to IEC 60068-2-27	amplitude < 50g, 11ms, half sinusoidal
Ambient temp. operating min.	-25 °C
Ambient temp. operating without lamp max.	+70 °C
Ambient temp. operating with lamp max.	+55 °C
Storage temperature min.	-40 °C
Storage temperature max.	+85 °C
Colour code	grey bottom
Resistance to constant environment	according to IEC 600 68-2-3 and 2-30
Resistance at variable environment	according to IEC 600 68-2-14 and 2-33
Mechanical operating life latching (operations)	100000
Resistance to vibrations acc. to IEC 60068-2-6	10 g at 20 ... 500 Hz
Flame class acc. to UL 94	V 0
Hot wire ignition acc. to IEC 60695-2-1	yes



RAFIX 16

Accessories RAFIX 16 contact blocks with silver contacts

Description	Photo	Order no.	Page
Filament lamp, W 2 x 4.6d base, 24 - 30 V		1.90.120.005/0000	5 - 4
Filament lamp, W 2 x 4.6d base, 60 V		1.90.120.009/0000	5 - 4
Filament lamp, W 2 x 4.6d base, 48 V		1.90.120.010/0000	5 - 4
Filament lamp, W 2 x 4.6d base, 24 V		1.90.120.011/0000	5 - 4
Filament lamp, W 2 x 4.6d base, 12 V		1.90.120.012/0000	5 - 4
Filament lamp, W 2 x 4.6d base, 6 V		1.90.120.013/0000	5 - 4
LED W 2 x 4.6d superbright, red, 24 V		1.90.690.361/0000	5 - 16
LED W 2 x 4.6d superbright, green, 24 V		1.90.690.362/0000	5 - 16
LED W 2 x 4.6d superbright, yellow, 24 V		1.90.690.363/0000	5 - 16
LED W 2 x 4.6d superbright, blue, 24 V		1.90.690.364/0000	5 - 16
LED W 2 x 4.6d superbright, white, 24 V		1.90.690.365/0000	5 - 16
Multipole connector		5.05.510.421/0000	2 - 71
PCB plug-in socket, 10 contacts (universal application)		5.05.510.644/0000	2 - 70
Female quick-connect terminal DIN 46340-B 2.8-1-MS		5.37.540.024/8622	2 - 71
Plug distributor		5.37.540.029/6000	2 - 72
Protection against contact		5.55.103.105/0100	2 - 72

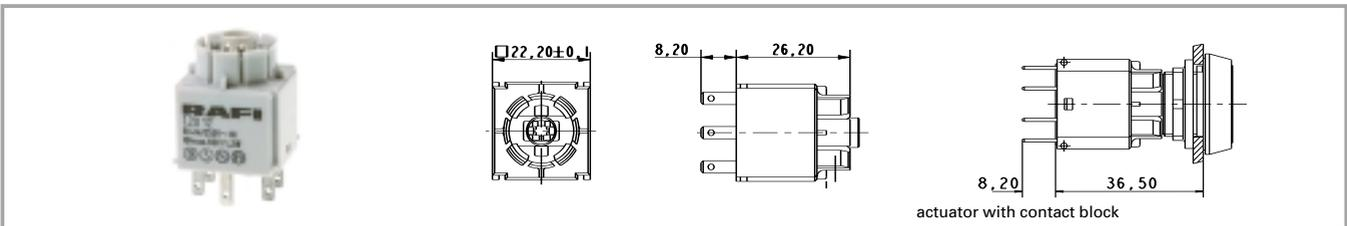
RAFIX 16 standard contact block, silver contacts, with lamp socket

Contact function	Contact arrangement	Lamp socket	Rated insulation voltage U_i , AC	Ohmic rated current I_R	Order no. complete
momentary	1 NC + 1 NO	W 2 x 4.6d	250 V	6 A	1.20.122.001/0000
momentary	2 NO	W 2 x 4.6d	250 V	6 A	1.20.122.002/0000
momentary	2 NC	W 2 x 4.6d	250 V	6 A	1.20.122.003/0000
latching	1 NC + 1 NO	W 2 x 4.6d	250 V	6 A	1.20.122.041/0000
latching	2 NO	W 2 x 4.6d	250 V	6 A	1.20.122.042/0000

Technical data see page 2 - 62

Standard contact blocks have one common contact chamber and one actuator plunger.

Contact blocks with „latching“ contact function are used as switches. When combined with pushbuttons and mushroom actuators, the switching position is visible, releasing is effected by actuating again.

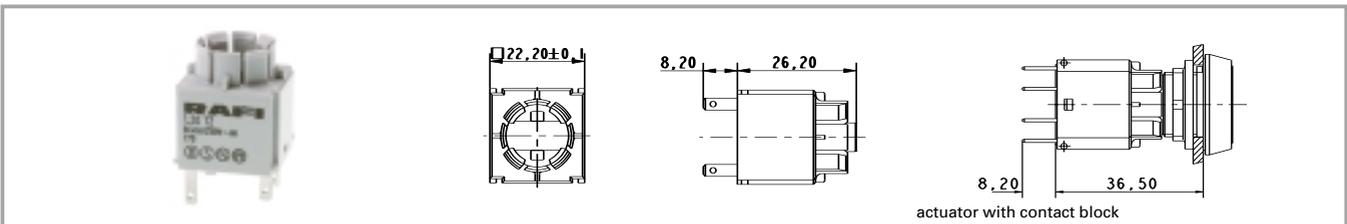
RAFIX 16 standard contact block, silver contacts, without lamp socket

Contact function	Contact arrangement	Lamp socket	Rated insulation voltage U_i , AC	Ohmic rated current I_R	Order no. complete
momentary	1 NC + 1 NO		250 V	6 A	1.20.122.021/0000
momentary	2 NO		250 V	6 A	1.20.122.022/0000
momentary	2 NC		250 V	6 A	1.20.122.023/0000
latching	1 NC + 1 NO		250 V	6 A	1.20.122.061/0000
latching	2 NO		250 V	6 A	1.20.122.062/0000

Technical data see page 2 - 62

Standard contact blocks have one common contact chamber and one actuator plunger.

Contact blocks with „latching“ contact function are used as switches. When combined with pushbuttons and mushroom actuators, the switching position is visible, releasing is effected by actuating again.

RAFIX 16

RAFIX 16 universal contact block, silver contacts, with lamp socket

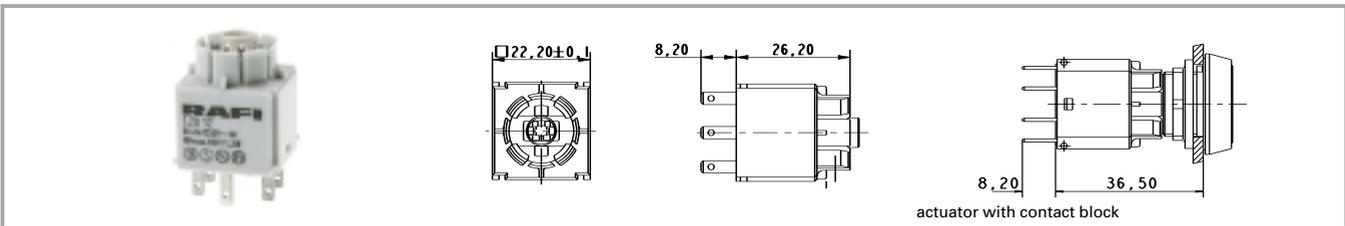

Contact function	Contact arrangement	Lamp socket	Rated insulation voltage U_i , AC	Ohmic rated current I_R	Order no. complete
momentary	1 NC + 1 NO	W 2 x 4.6d	250 V	6 A	1.20.123.001/0000
momentary	1 NC	W 2 x 4.6d	250 V	6 A	1.20.123.002/0000
momentary	1 NO	W 2 x 4.6d	250 V	6 A	1.20.123.003/0000
momentary	2 NC	W 2 x 4.6d	250 V	6 A	1.20.123.004/0000
momentary	2 NO	W 2 x 4.6d	250 V	6 A	1.20.123.005/0000

Technical data see page 2 - 62

Universal contact blocks have two separate contact chambers and two actuator plungers. This makes it possible to switch two different polarities. The NC contacts are positive opening contacts to IEC 60947-5-1.

RAFIX 16 universal contact block, silver contacts, without lamp socket

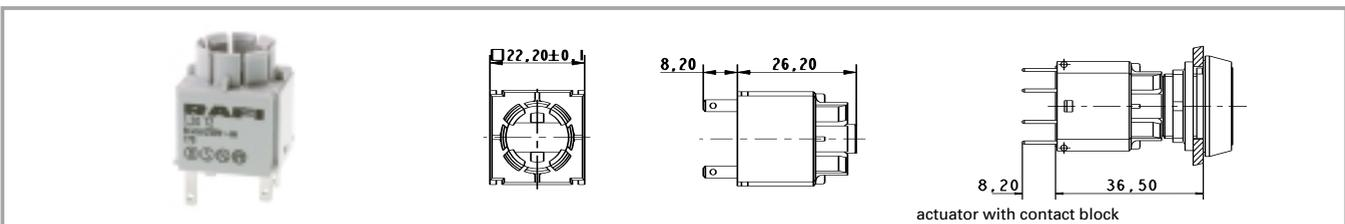

Contact function	Contact arrangement	Lamp socket	Rated insulation voltage U_i , AC	Ohmic rated current I_R	Order no. complete
momentary	1 NC + 1 NO		250 V	6 A	1.20.123.021/0000
momentary	1 NC		250 V	6 A	1.20.123.022/0000
momentary	1 NO		250 V	6 A	1.20.123.023/0000
momentary	2 NC		250 V	6 A	1.20.123.024/0000
momentary	2 NO		250 V	6 A	1.20.123.025/0000

Technical data see page 2 - 62

Universal contact blocks have two separate contact chambers and two actuator plungers. This makes it possible to switch two different polarities. The NC contacts are positive opening contacts to IEC 60947-5-1.

RAFIX 16 lamp socket**2**RAFIX
16**Technical data****Dimensions**

Length	see order block
Width	see order block
Height	see order block
Mounting depth	see order block

Mechanical design

Mounting	see order block
Lamp socket	wedge-base W 2 x 4.6d
Terminals	quick connector 2.8 x 0.8
Terminal marking	X1 = anode, X2 = cathode
Robustness	100 N

Electrical characteristics

Rated voltage max.	60 V
Rated power max.	1.2 W

Other specifications

Approvals	ENEC 25 T 70 (55), UL, CSA
-----------	----------------------------

Shock resistance acc. to IEC 60068-2-27

amplitude < 50g, D 11ms, half sinusoidal

Ambient temp. operating min.

-25 °C

Ambient temp. operating with lamp max.

+55 °C

Storage temperature min.

-40 °C

Storage temperature max.

+85 °C

Resistance to constant environment

according to IEC 600 68-2-3 and 2-30

Resistance at variable environment

according to IEC 600 68-2-14 and 2-33 V 0

Flame class acc. to UL 94

Hot wire ignition acc. to IEC 60695-2-1

yes

Resistance to vibrations acc. to IEC 60068-2-6

10 g at 20 ... 500 Hz

Accessories RAFIX 16 lamp socket

Description	Photo	Order no.	Page
Filament lamp, W 2 x 4.6d base, 24 - 30 V		1.90.120.005/0000	5 - 4
Filament lamp, W 2 x 4.6d base, 60 V		1.90.120.009/0000	5 - 4
Filament lamp, W 2 x 4.6d base, 48 V		1.90.120.010/0000	5 - 4
Filament lamp, W 2 x 4.6d base, 24 V		1.90.120.011/0000	5 - 4
Filament lamp, W 2 x 4.6d base, 12 V		1.90.120.012/0000	5 - 4
Filament lamp, W 2 x 4.6d base, 6 V		1.90.120.013/0000	5 - 4
LED W 2 x 4.6d superbright, red, 24 V		1.90.690.361/0000	5 - 16

RAFIX 16

Accessories RAFIX 16 lamp socket

Description	Photo	Order no.	Page
LED W 2 x 4.6d superbright, green, 24 V		1.90.690.362/0000	5 - 16
LED W 2 x 4.6d superbright, yellow, 24 V		1.90.690.363/0000	5 - 16
LED W 2 x 4.6d superbright, blue, 24 V		1.90.690.364/0000	5 - 16
LED W 2 x 4.6d superbright, white, 24 V		1.90.690.365/0000	5 - 16
PCB plug-in socket, 2 contacts (lamp socket)		5.05.510.649/0000	2 - 70
Protection against contact		5.55.103.105/0100	2 - 72

2

RAFIX
16

RAFIX 16 lamp socket W 2 x 4.6 d

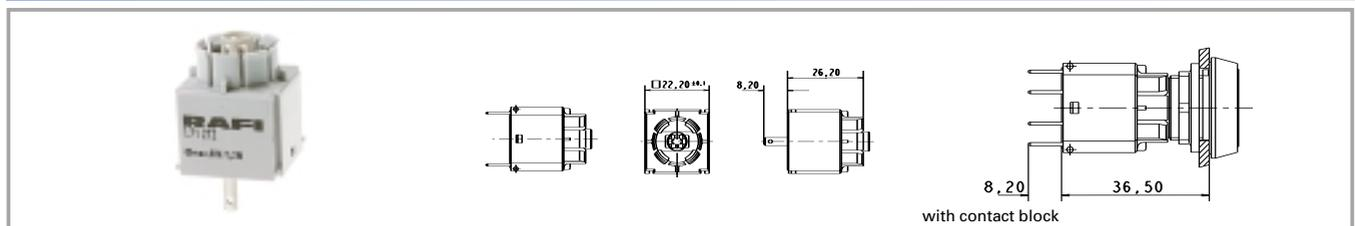

Rated voltage max.	Rated power max.	Lamp socket	Mounting	Mounting depth	Order no. complete
60 V	1.2 W	wedge-base W 2 x 4.6d	click on signal indicator	44.7 mm	1.71.212.001/0000

Technical data see page 2 - 66

A notch on the lamp socket identifies the cathode side.

RAFIX 16 lamp socket W 2 x 4.6 d

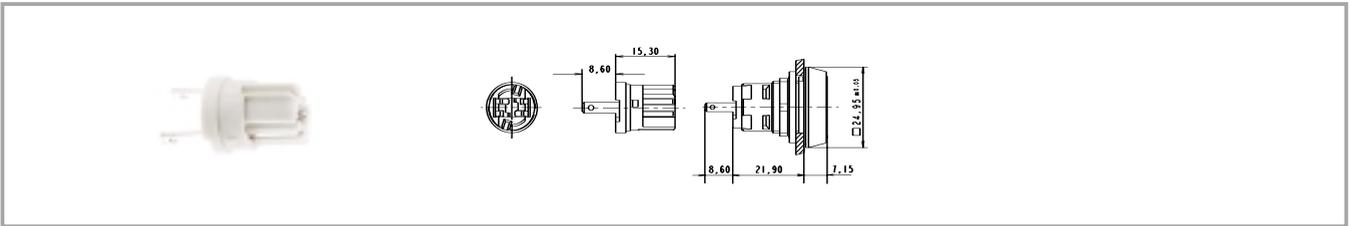

Rated voltage max.	Rated power max.	Lamp socket	Mounting	Mounting depth	Order no. complete
60 V	1.2 W	wedge-base W 2 x 4.6d	snap into signal indicator	30.5 mm	1.71.212.011/0000

Technical data see page 2 - 66

A notch on the lamp socket identifies the cathode side.

2

RAFIX
16

RAFIX 16 special accessories



2

PCB plug-in socket

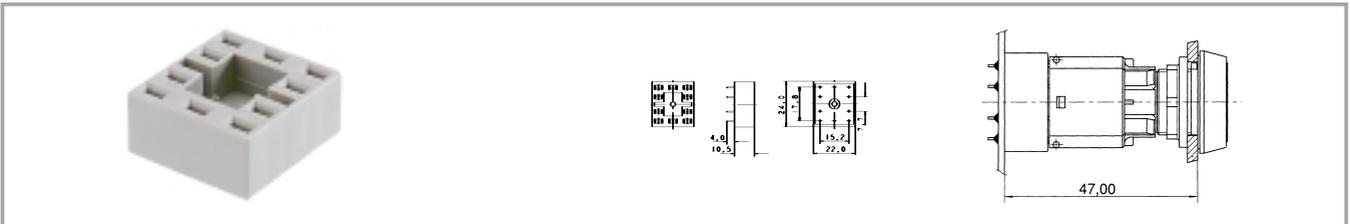

RAFIX
16

Short text	Feature 1	Feature 2	Order no.
PCB plug-in socket, 10 contacts (universal application)	22 mm	24 mm	5.05.510.644/0000
PCB plug-in socket, 6 contacts (2 NO, lamp socket)	22 mm	24 mm	5.05.510.645/0000
PCB plug-in socket, 6 contacts (1 NC, 1 NO, lamp socket)	22 mm	24 mm	5.05.510.646/0000
PCB plug-in socket, 6 contacts (2 NC, lamp socket)	22 mm	24 mm	5.05.510.647/0000
PCB plug-in socket, 4 contacts (2 NC)	22 mm	24 mm	5.05.510.648/0000
PCB plug-in socket, 2 contacts (lamp socket)	22 mm	24 mm	5.05.510.649/0000

For soldering onto PCBs. The PCB carrying the plug-in sockets is plugged onto the contact blocks/lamp sockets. Additional fixing of the PCB to the contact block is not required. Solder terminals for PCB 3.5 mm long, for 1.3 mm hole.

RAFIX 16

Multipole connector

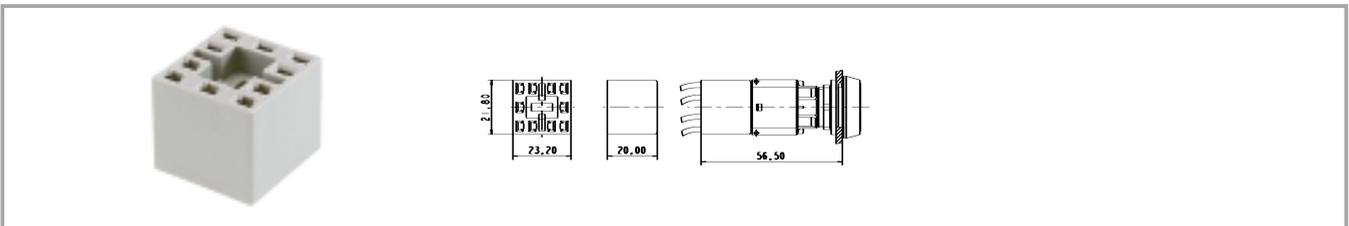

Short text	Feature 1	Feature 2	Order no.
Multipole connector	21.8 mm	23.2 mm	5.05.510.421/0000

Makes it possible to simultaneously connect all terminals of a contact block. Can be fitted with 2.8 mm female quick-connect terminals.

Female quick-connect terminal DIN 46340-B 2.8-1-MS

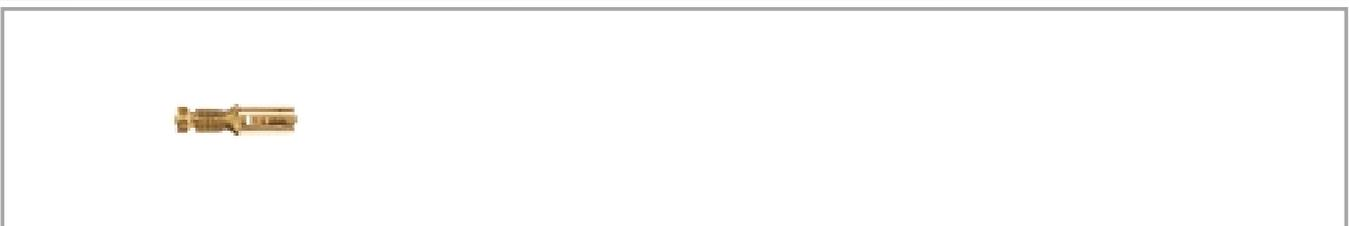

Short text	Feature 1	Feature 2	Order no.
Female quick-connect terminal DIN 46340-B 2.8-1-MS			5.37.540.024/8622

With latching detent for mating with a multipole connector.

Plug distributor



Short text	Feature 1	Feature 2	Order no.
Plug distributor			5.37.540.029/6000

For mounting on the quick-connect terminals of contact blocks. The double number of contacts facilitates loop-through.

Protection against contact

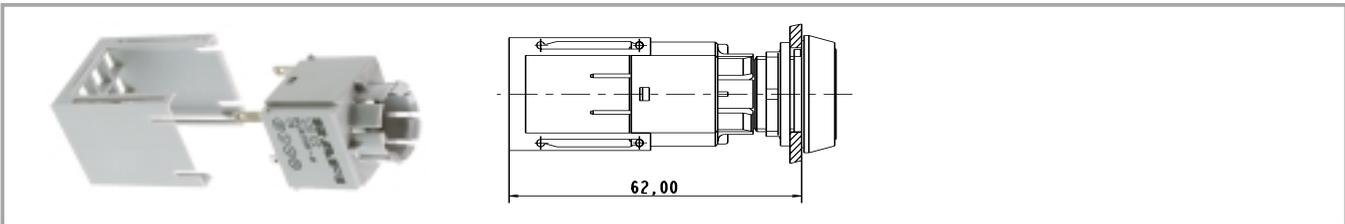

Short text	Feature 1	Feature 2	Order no.
Protection against contact			5.55.103.105/0100

Assembly sequence: Snap the protection against contact onto the contact block, connect wires to quick-connect terminals of contact block, pull protection against contact over the terminals; this ensures finger-proof condition to VBG 4.

2

RAFIX
16

RAFIX 16

Protection against contact



Short text	Feature 1	Feature 2	Order no.
Protection against contact (VBG 4 with lamp socket 1.71.212.011)			5.55.103.134/0700

You can use the protection against contact to cover the terminals of the lamp socket 1.71.212.011/0000 so that they are finger-proof to VBG 4.

Series capacitor



Short text	Feature 1	Feature 2	Order no.
Series capacitor, 125 V/48 V~, 50 Hz, 25 mA			5.03.771.333/0000
Series capacitor, 230 V/48 V~, 50 Hz, 25 mA			5.03.771.334/0000

Fully encapsulated, with a 2.8 x 0.8 mm quick-connect tab in a touch-proof arrangement.

Disassembly tool

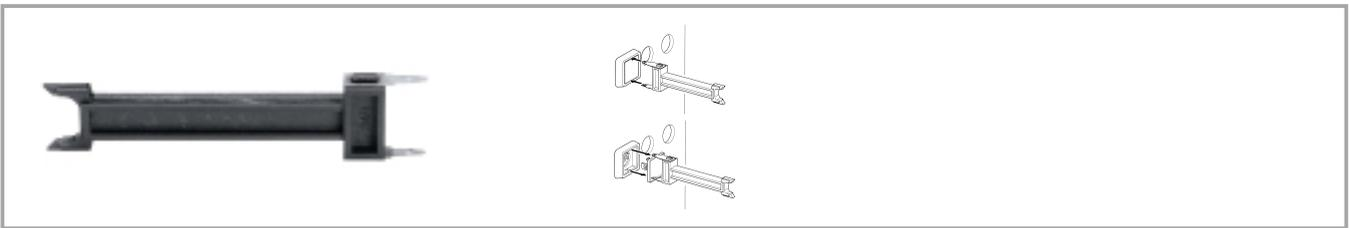

Short text	Feature 1	Feature 2	Order no.
Disassembly tool for LUMOTAST 25, RAFIX 16			5.05.800.042/0000

For replacing pushbutton and signal indicator lenses.

Protective cover, suitable for lead seal, for pushbuttons, alignable without gaps

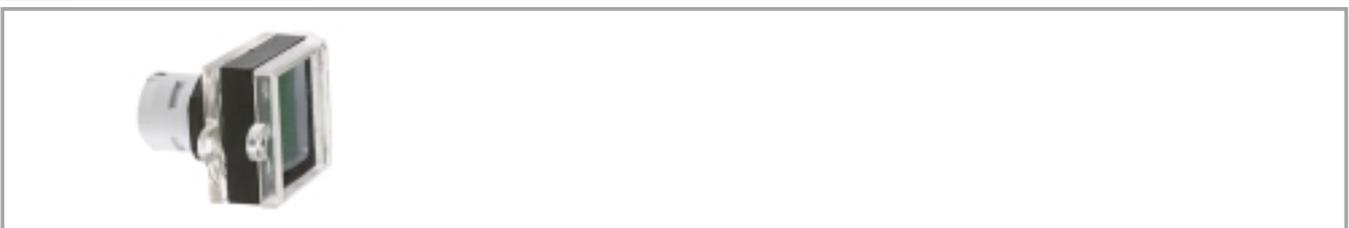

Short text	Feature 1	Feature 2	Order no.
Protective cover, suitable for lead seal			5.05.800.055/0000

To prevent inadvertent operation. The legend is easily visible even when the cap is closed.

2

RAFIX
16

RAFIX 16

Fixing spanner for hexagon nut



Short text	Feature 1	Feature 2	Order no.
Fixing spanner for hexagon nut			5.58.002.034/0000

RAFIX 16 insulating housing

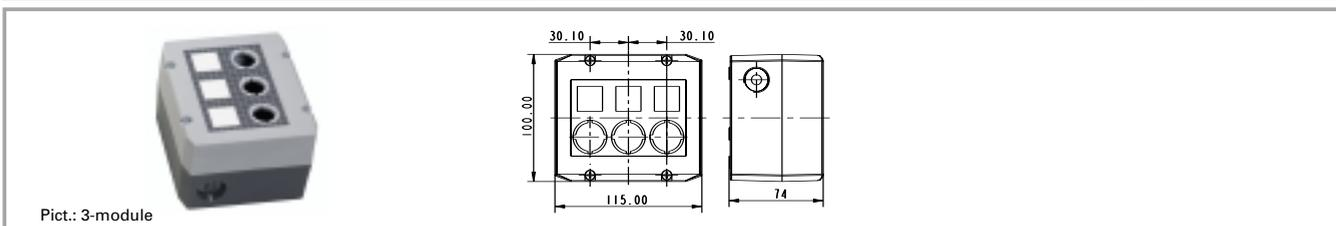

Short text	Feature 1	Feature 2	Order no.
RAFIX 16 insulating housing, 1-module, light grey/dark grey	55 mm	100 mm	1.20.810.001/0000
RAFIX 16 insulating housing, 1-module, yellow/yellow	55 mm	100 mm	1.20.810.002/0000
RAFIX 16 insulating housing, 2-module, light grey/dark grey	115 mm	100 mm	1.20.820.001/0000
RAFIX 16 insulating housing, 3-module, light grey/dark grey	115 mm	100 mm	1.20.830.001/0000
RAFIX 16 insulating housing, 4-module, light grey/dark grey	145 mm	100 mm	1.20.840.001/0000
Label sheet for housings			5.40.451.283/0000

- Attractive plastic housing to accommodate up to 4 control components
- 2 cable entries prepared: 1-,2-,3-part: M20x1,5, 4-part: M25x1,5
- Degree of protection IP 65 to DIN
- All grey housings with overlay, legending possible with legend inserts
- Wall mounting with 2 screws through housing bottom prepared
- Dimensions x (feature 1) x 100 mm x 74 mm
- Accessories: 50 pre-perforated legend inserts on a DIN A4 sheet for printing with a PC printer

RAFIX 16 label holder, flush, for square collar

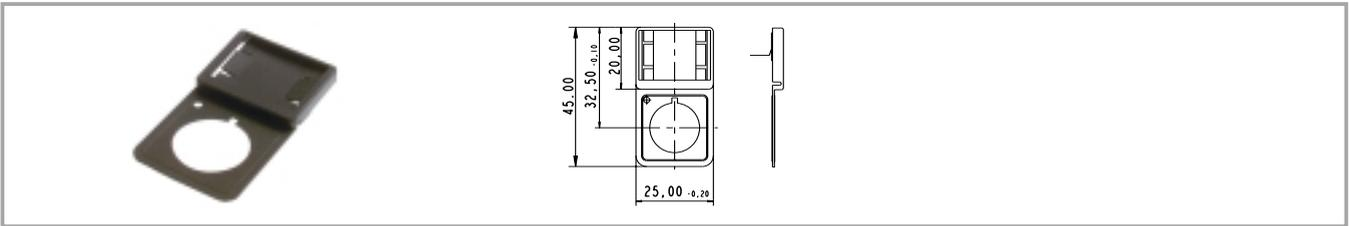

Short text	Feature 1	Feature 2	Order no.
Label holder, flush, for square collar			5.07.620.004/0000

Accessories:
Legend label 23 x 16 for label holder, without legend: 5.73.111.000/0000
Legending available on request.

2

RAFIX
16

RAFIX 16 label holder, flush, for round collar

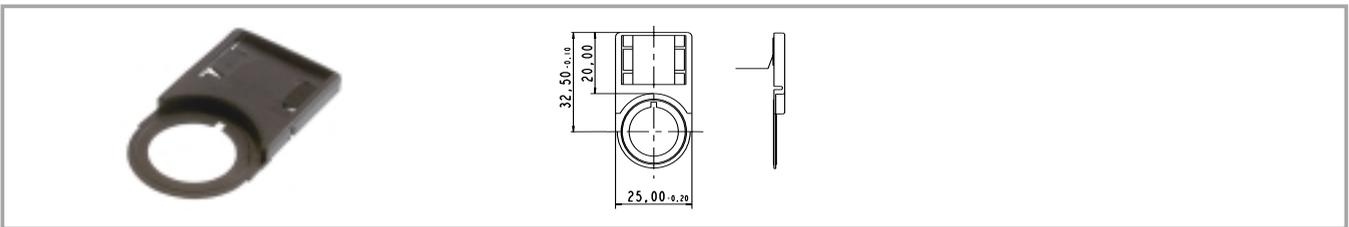

Short text	Feature 1	Feature 2	Order no.
Label holder, flush, for round collar			5.07.620.006/0000

Accessories:
Legend label 23 x 16 for label holder, without legend: 5.73.111.000/0000
Legending available on request.

RAFIX 16

RAFIX 16 label holder, protruding, for square flush fitting collar

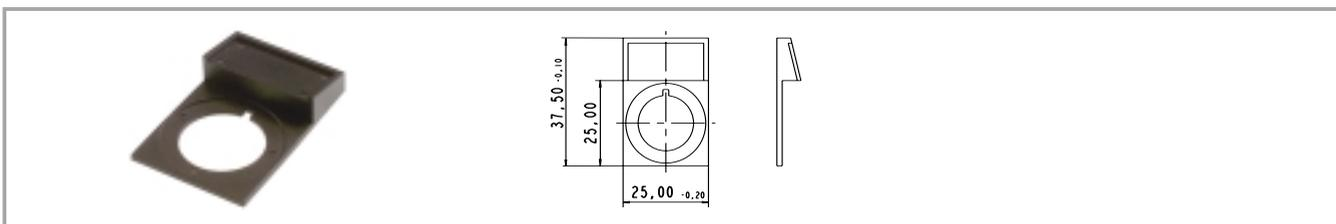

Short text	Feature 1	Feature 2	Order no.
Label holder, protruding, for square flush fitting collar			5.07.620.007/0000

Accessories:

Legend label 23 x 16, without legend: 5.73.112.000/0000

Legending available on request.

Emergency stop label, yellow, round 60 mm, PVC adhesive



Short text	Feature 1	Feature 2	Order no.
Emergency stop label, yellow, round 60 mm, PVC adhesive, without legend	60 mm		5.76.204.400/0400
Emergency stop label, yellow, round 60 mm, PVC adhesive, with legend "NOT-AUS"	60 mm		5.76.204.401/0400
Emergency stop label, yellow, round 60 mm, PVC adhesive, with legend "EMERGENCY STOP"	60 mm		5.76.204.403/0400