

# Solid State Relays Industrial, 1-Phase Analog Switching Type RM1E

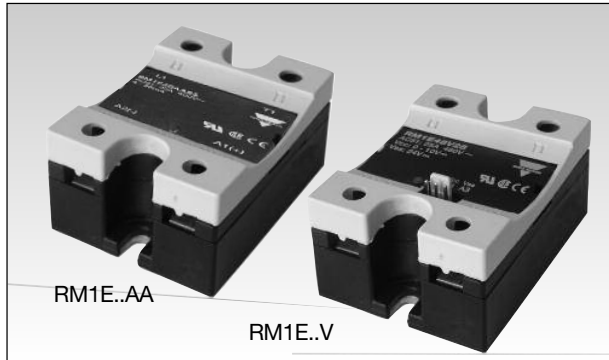

- AC Solid State Relay
- Analog switching (phase-angle control) for resistive and slightly inductive load applications
- 4 - 20mA or 0 -10V control input
- Rated operational current: 25, 50, 75 and 100 AACrms
- Rated operational voltage: Up to 600 VACrms
- Variable intensity LED-indication according to input current
- Integral snubber network
- Polarized lockable control connector for safe connection for voltage controlled version

## Product Description

The analog switching relay works in accordance with the phase angle control principle, i.e., the output switching point in the AC sine wave depends on the control input which can be either 4-20mA or 0-10VDC. 4 mA or 0VDC correspond to

zero output power whilst 20 mA or 10VDC correspond to full output power (near linear power response). The relay switches off every time the output current crosses zero, and switches ON in accordance with the applied control input.

## Ordering Key

**RM 1E 60 AA 50**

- Solid State Relay
- Number of Poles
- Switching mode
- Rated operational voltage
- Control input
- Rated operational current

## Type Selection

Switching mode	Rated operational voltage	Rated operational current	Control input
E: Analog switching	23: 230 VACrms* 40: 400 VACrms 48: 480 VACrms 60: 600 VACrms	25: 25 AACrms 50: 50 AACrms 75: 75 AACrms 100: 100 AACrms	AA: 4 - 20 mADC V: 0-10VDC**

\* For nominal operational voltage of 110VACrms, use RM1E23...  
\*\* RM1E..V.. require an external supply voltage

## Selection Guide

Rated operational voltage	Blocking voltage	Control input	Rated operational current			
			25 A	50 A	75A	100 A
230 VAC	650 V <sub>p</sub>	4 - 20 mA 0-10 VDC	RM1E23AA25 RM1E23V25	RM1E23AA50 RM1E23V50		RM1E23AA100 RM1E23V100
400 VAC	850 V <sub>p</sub>	4 - 20 mA	RM1E40AA25	RM1E40AA50		RM1E40AA100
480 VAC	1200 V <sub>p</sub>	4 - 20 mA 0-10 VDC	RM1E48AA25 RM1E48V25	RM1E48AA50 RM1E48V50	RM1E48AA75	RM1E48AA100 RM1E48V100
600 VAC	1400 V <sub>p</sub>	4 - 20 mA 0-10 VDC	RM1E60AA25 RM1E60V25	RM1E60AA50 RM1E60V50		RM1E60AA100 RM1E60V100

## General Specifications

	RM 1E 23 ...	RM 1E 40 ...	RM 1E 48 ...	RM 1E 60 ...
Operational voltage range RM1E..AA.. RM1E..V..	90 to 280 VAC 90 to 265 VAC	340 to 460 VAC -	90 to 550 VAC 200 to 550 VAC	410 to 660 VAC 410 to 660 VAC
Blocking voltage	650 V <sub>p</sub>	850 V <sub>p</sub>	1200 V <sub>p</sub>	1400 V <sub>p</sub>
Operational frequency range	45 to 65 Hz	45 to 65 Hz	45 to 65 Hz	45 to 65 Hz
Power factor	> 0.75	> 0.75	> 0.75	> 0.75
Approvals	UL, cUL, CSA*	UL, cUL, CSA*	UL, cUL, CSA*	UL, cUL, CSA*
CE-marking	Yes	Yes	Yes	Yes**

\* Approvals pending for RM1E..V..

\*\* Heatsink must be connected to ground for 600V types

Specifications are subject to change without notice (02.11.2010)

## Output Specifications

	RM1E...25	RM1E...50	RM1E...75	RM1E...100
Rated operational current AC51 Ta=25 °C AC53a Ta=25 °C	25 AACrms 5 AACrms	50 AACrms 15 AACrms	75 AACrms 20 AACrms	100 AACrms 20 AACrms
Minimum operational current	150 mA	250 mA	400 mA	400 mA
Rep. overload current t=1s	55 AACrms	125 AACrms	150 AACrms	150 AACrms
Non-rep. surge current t=10ms	325 A <sub>p</sub>	600 A <sub>p</sub>	1150 A <sub>p</sub>	1150 A <sub>p</sub>
Off-state leakage current	< 3 mA	< 3 mA	< 3 mA	< 3 mA
I <sup>2</sup> t for fusing t= 10 ms	525 A <sup>2</sup> s	1800 A <sup>2</sup> s	6600 A <sup>2</sup> s	6600 A <sup>2</sup> s
Critical dV/dt off-state min.	1000 V/μs	1000 V/μs	1000 V/μs	1000 V/μs

## Input Specifications

	RM1E..AA..
<b>Current controlled input</b>	
Control current range (A1-A2)	4-20 mADC
Pick up current	4.2 mADC
Drop out current	4.1 mADC
Response time (input to output)	≤ 20 ms
Voltage drop	< 10 VDC @ 20 mA
Dynamic impedance	≥ 330 Ω
Max. allowable input current	50 mA
Reverse polarity protected	Yes

	RM1E..V..
<b>Voltage controlled input</b>	
Supply voltage, V <sub>ss</sub> (A3-A2)	24 VDC ±20%
Max. supply current	15 mA @ 19.2 VDC 20 mA @ 30 VDC
Control voltage, V <sub>cc</sub> (A1-A2)	0-10VDC
Pick up voltage	0.2 VDC
Drop out voltage	0.1VDC
Control input current	0.15 mA @10 VDC
Response time (input to output)	≤ 20 ms
Supply reverse protected	Yes

Note: The use of twisted pair cable for the control input is recommended

## Housing Specifications

<b>Weight</b>	
25 A, 50 A	Approx. 60 g
75 A, 100 A	Approx. 100 g
<b>Housing material</b>	Noryl, black
<b>Baseplate</b>	
25 A, 50 A	Aluminium
75 A, 100 A	Copper, nickel-plated
<b>Relay</b>	
Mounting screws	M5
Mounting torque	1.5-2.0 Nm
<b>Power terminal</b>	
Mounting screws	M5 x 9mm
Mounting torque	2.4 Nm
<b>Control terminal (RM1E..AA..)</b>	
Mounting screws	M3 x 9mm
Mounting torque	0.5 Nm
<b>Control terminal (RM1E..V..)</b>	
3 pin connector	0.64mm square pin with 2.54mm centre distance, tin plated brass
<b>Housing</b>	Nylon, UL94V-0

## Functional Diagram

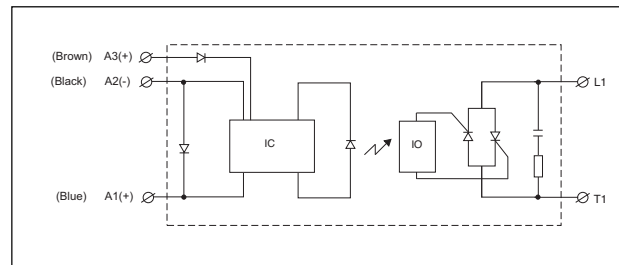
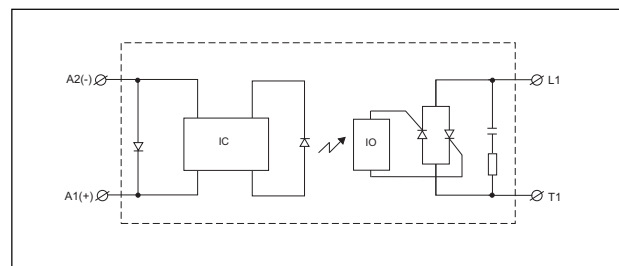



## Thermal Specifications

Operating temperature	-20° to +70°C (4° to +158 °F)
Storage temperature	-20° to +100°C (-4° to +212 °F)
Junction temperature	≤125°C (257 °F)

## Isolation

Rated isolation voltage	
Input to output	≥ 4000 Vrms
Output to case	≥ 4000 Vrms

## Heatsink Dimensions (load current versus ambient temperature)

With the output fully ON (360° conduction angle)

RM1E..25

Load current [A]	Thermal resistance [K/W]						Power dissipation [W]
	20	30	40	50	60	70	
25.0	3.23	2.80	2.37	1.94	1.51	1.09	23
22.5	3.70	3.21	2.73	2.24	1.75	1.26	21
20.0	4.30	3.74	3.17	2.61	2.05	1.49	18
17.5	5.07	4.41	3.76	3.10	2.44	1.78	15
15.0	6.12	5.33	4.54	3.75	2.96	2.17	13
12.5	7.58	6.61	5.64	4.66	3.69	2.72	10
10.0	9.80	8.55	7.30	6.05	4.80	3.55	8
7.5	13.5	11.80	10.09	8.37	6.66	4.94	6
5.0	-	18.3	15.7	13.04	10.39	7.74	4
2.5	-	-	-	-	-	7	2

Ambient temp. [°C]

RM1E..50

Load current [A]	Thermal resistance [K/W]						Power dissipation [W]
	20	30	40	50	60	70	
50.0	1.25	1.07	0.88	0.70	0.52	0.34	55
45.0	1.46	1.25	1.04	0.84	0.63	0.42	48
40.0	1.73	1.49	1.25	1.01	0.77	0.52	41
35.0	2.08	1.80	1.51	1.23	0.94	0.66	35
30.0	2.56	2.22	1.87	1.53	1.18	0.84	29
25.0	3.24	2.81	2.38	1.95	1.52	1.09	23
20.0	4.26	3.71	3.15	2.59	2.03	1.47	18
15.0	5.99	5.22	4.45	3.67	2.90	2.12	13
10.0	9.49	8.27	7.06	5.85	4.64	3.43	8
5.0	-	17.5	15.0	12.4	9.91	7.39	4

Ambient temp. [°C]

RM1.60..50

Load current [A]	Thermal resistance [K/W]						Power dissipation [W]
	20	30	40	50	60	70	
50.0	0.99	0.81	0.63	0.44	0.26	0.08	55
45.0	1.28	1.07	0.86	0.65	0.44	0.23	48
40.0	1.64	1.40	1.15	0.91	0.67	0.42	41
35.0	2.11	1.82	1.54	1.25	0.96	0.67	35
30.0	2.60	2.25	1.90	1.55	1.20	0.85	29
25.0	3.30	2.86	2.43	1.99	1.55	1.11	23
20.0	4.36	3.79	3.22	2.65	2.08	1.51	18
15.0	6.1	5.4	4.6	3.77	2.97	2.18	13
10.0	9.76	8.52	7.3	6.0	4.8	3.54	8
5.0	--	--	15.47	12.85	10.24	7.6	4

Ambient temp. [°C]

RM1E...75

Load current [A]	Thermal resistance [K/W]						Power dissipation [W]
	20	30	40	50	60	70	
75.0	1.00	0.88	0.75	0.63	0.50	0.38	80
67.5	1.15	1.00	0.86	0.72	0.57	0.43	70
60.0	1.33	1.16	1.00	0.83	0.66	0.50	60
52.5	1.56	1.37	1.17	0.98	0.78	0.59	51
45.0	1.88	1.65	1.41	1.18	0.94	0.71	43
37.5	2.33	2.04	1.75	1.46	1.17	0.87	34
30.0	3.01	2.64	2.26	1.88	1.51	1.13	27
22.5	4.16	3.64	3.12	2.60	2.08	1.56	19
15.0	6.46	5.66	4.85	4.04	3.23	2.42	12
7.5	13.42	11.74	10.06	8.39	6.71	5.03	6

Ambient temp. [°C]

## Heatsink Dimensions (load current versus ambient temperature) - Cont ...

### RM1E..100

Load current [A]	Thermal resistance [K/W]						Power dissipation [W]
	20	30	40	50	60	70	
100.0	0.60	0.52	0.43	0.34	0.26	0.17	117
90.0	0.74	0.64	0.54	0.44	0.34	0.24	101
80.0	0.91	0.79	0.68	0.56	0.45	0.33	87
70.0	1.09	0.96	0.82	0.68	0.55	0.41	73
60.0	1.33	1.16	1.00	0.83	0.66	0.50	60
50.0	1.66	1.45	1.24	1.04	0.83	0.62	48
40.0	2.16	1.89	1.62	1.35	1.08	0.81	37
30.0	3.01	2.64	2.26	1.88	1.51	1.13	27
20.0	4.73	4.14	3.55	2.96	2.37	1.78	17
10.0	9.94	8.70	7.45	6.21	4.97	3.73	8

Ambient temp. [°C]

## Dimensions

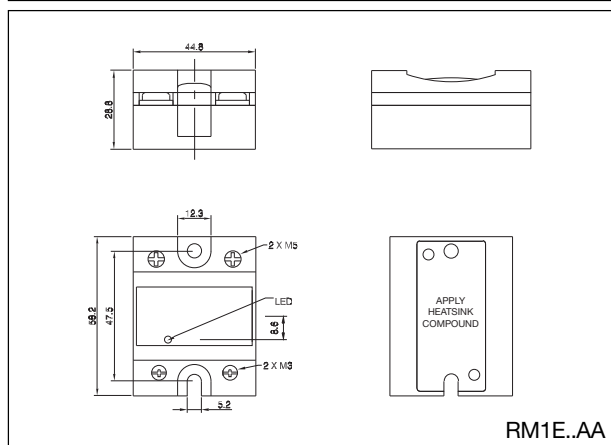

All dimensions in mm

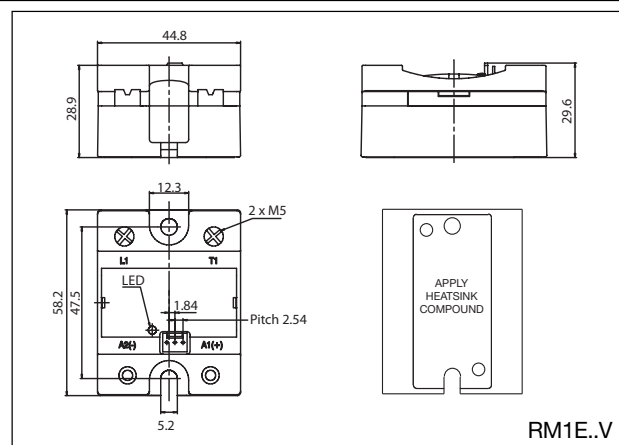

## Applications

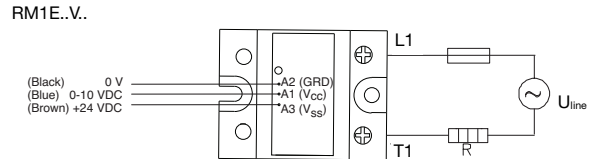
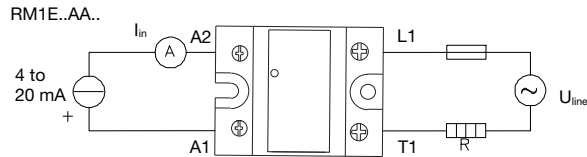

### Transfer Characteristics

Output power as a function of control input

Control current (mA)	Control voltage (VDC)	Output power
4	0	0
8	2.5	25
12	5	50
16	7.5	75
20	10	99

This relay is suitable for control of heaters, lighting and slightly inductive loads such as small fans. The relay can also be used for soft turn-on of high-power incandescent lamps.

## Heatsink Selection

Carlo Gavazzi Heatsink (see Accessories)	Thermal resistance...	..for power dissipation
No heatsink required	----	N/A
RHS 300	5.00 K/W	> 0 W
RHS 100	3.00 K/W	> 25 W
RHS 45C	2.70 K/W	> 55 W
RHS 45B	2.00 K/W	> 60 W
RHS 90A	1.35 K/W	> 60 W
RHS 45C plus fan	1.25 K/W	> 0 W
RHS 45B plus fan	1.20 K/W	> 0 W
RHS 112A	1.10 K/W	> 100 W
RHS 301	0.80 K/W	> 80 W
RHS 90A plus fan	0.45 K/W	> 0 W
RHS 112A plus fan	0.40 K/W	> 0 W
RHS 301 plus fan	0.25 K/W	> 0 W
Consult your distributor	<0.25 K/W	N/A
Infinite heatsink	----	N/A
- No solution		

Note: For power dissipation values smaller than those shown above, please refer to the corresponding heatsink curve in the SSR Accessories Section is referred to.

## Ribbon Cable Selection

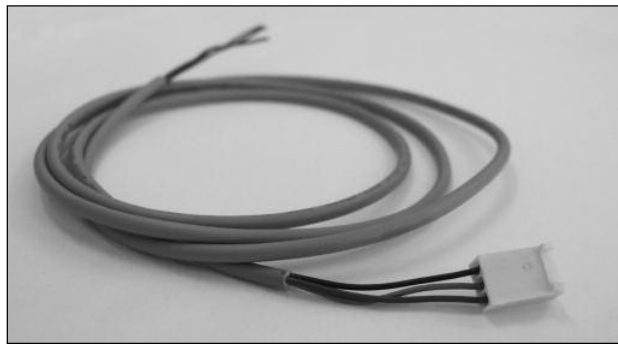

**RCS 3-100-1**

R-System \_\_\_\_\_  
 Cable sense \_\_\_\_\_  
 3-wire \_\_\_\_\_  
 Cable length in cm \_\_\_\_\_  
 1 connector mounted \_\_\_\_\_