

Monitoring Relays

3UG Monitoring Relays for Electrical and Additional Measurements

Line monitoring

Overview



Solid-state line monitoring relays provide maximum protection for mobile machines and plants or for unstable networks. Network and voltage faults can be detected early and rectified before far greater damage ensues.

Depending on the version, the relays monitor phase sequence, phase failure with and without N conductor monitoring, phase unbalance, undervoltage or overvoltage. With the 3UG46 17 or 3UG46 18 relay, a wrong direction of rotation can also be corrected automatically.

Function

3UG45 11 monitoring relays

The 3UG45 11 phase sequenced relay monitors the phase sequence in a three-phase network. No adjustments are required for operation. The device has an internal power supply and works using the closed-circuit principle. If the phase sequence at the terminals L1-L2-L3 is correct, the output relay picks up after the delay time has elapsed and the LED is lit. If the phase sequence is wrong, the output relay remains in its rest position.

Note:

When one phase fails, connected loads (motor windings, lamps, transformers, coils, etc.) create a feedback voltage at the terminal of the failed phase due to the network coupling. Because the 3UG45 11 relays are not resistant to voltage feedback, such a phase failure is not detected. Should this be required, then the 3UG45 12 monitoring relay must be used.

Correct phase sequence

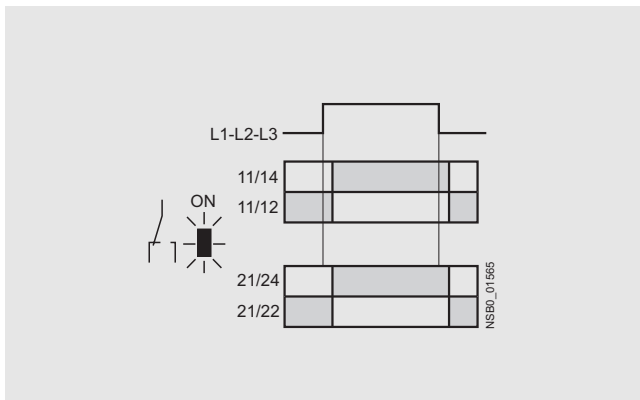

Wrong phase sequence

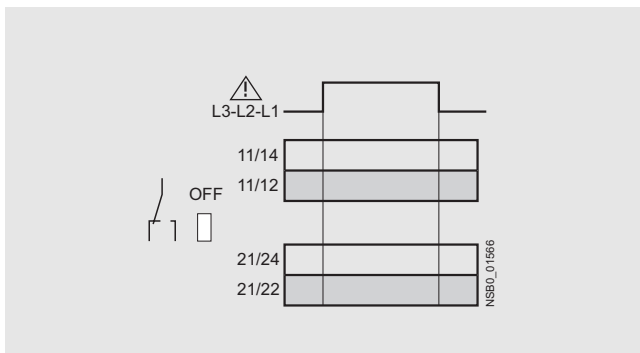

3UG45 12 monitoring relays

The 3UG45 12 line monitoring relay monitors three-phase networks with regard to phase sequence, phase failure and phase unbalance of 10 %. Thanks to a special measuring method, a phase failure is reliably detected in spite of the wide voltage range from 160 to 690 V AC and feedback through the load of up to 90 %. The device has an internal power supply and works using the closed-circuit principle. No adjustments are required. When the mains voltage is switched on, the green LED is lit. If the phase sequence at the terminals L1-L2-L3 is correct, the output relay picks up. If the phase sequence is wrong, the red LED flashes and the output relay remains in its rest position. If a phase fails, the red LED is permanently lit and the output relay drops.

Note:

The red LED is a fault diagnostic indicator and does not show the current relay status. The 3UG45 12 monitoring relay is suitable for line frequencies of 50/60 Hz.

Phase failure

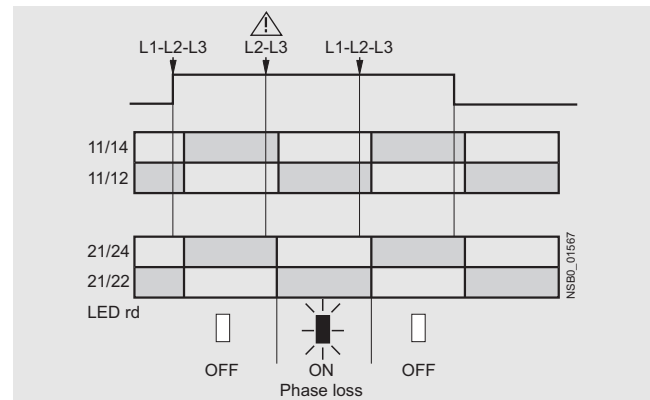

Wrong phase sequence

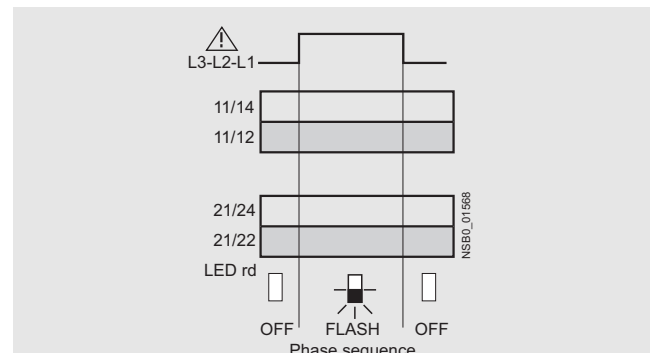

Monitoring Relays

3UG Monitoring Relays for Electrical and Additional Measurements

Line monitoring

3UG45 13 monitoring relays

The 3UG45 13 line monitoring relay monitors three-phase networks with regard to phase sequence, phase failure, phase unbalance of 20 % and undervoltage. The device has an internal power supply and works using the closed-circuit principle. The hysteresis is 5 %. The integrated response delay time is adjustable from 0 to 20 s and responds to undervoltage. If the direction is incorrect, the device switches off immediately. Thanks to a special measuring method, a phase failure is reliably detected in spite of the wide voltage range from 160 to 690 V AC and feedback through the load of up to 80 %. When the mains voltage is switched on, the green LED is lit. If the phase sequence at the terminals L1-L2-L3 is correct, the output relay picks up. If the phase sequence is wrong, the red LED flashes and the output relay remains in its rest position. If a phase fails, the red LED is permanently lit and the output relay drops.

Note:

The red LED is a fault diagnostic indicator and does not show the current relay status. The 3UG45 13 monitoring relay is suitable for line frequencies of 50/60 Hz.

Phase failure and undervoltage

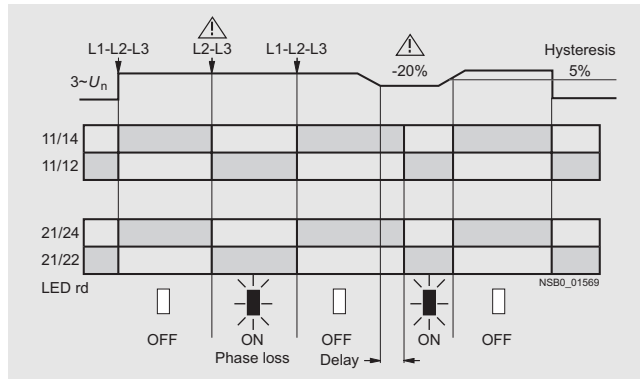

Wrong phase sequence

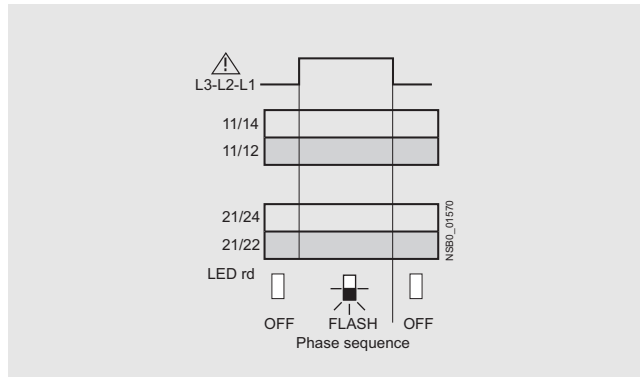

3UG46 14 monitoring relays

The 3UG46 14 line monitoring relay has a wide voltage range and an internal power supply. The device is equipped with a display and is parameterized using three buttons. It monitors three-phase networks with regard to phase unbalance from 5 to 20 %, phase failure, undervoltage and phase sequence. The hysteresis is adjustable from 1 to 20 V. In addition the device has a response delay and ON-delay from 0 to 20 s in each case. The integrated response delay time responds to phase unbalance and undervoltage. If the direction is incorrect, the device switches off immediately. Thanks to a special measuring method, a phase failure is reliably detected in spite of the wide voltage range from 160 to 690 V AC and feedback up to 80 % through the load.

The 3UG46 14 monitoring relay can be operated on the basis of either the open-circuit or closed-circuit principle and with manual or auto RESET.

With the closed-circuit principle selected

Wrong phase sequence

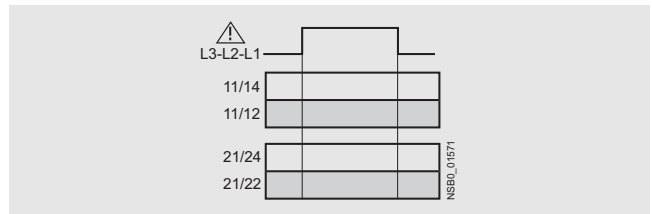

Phase failure

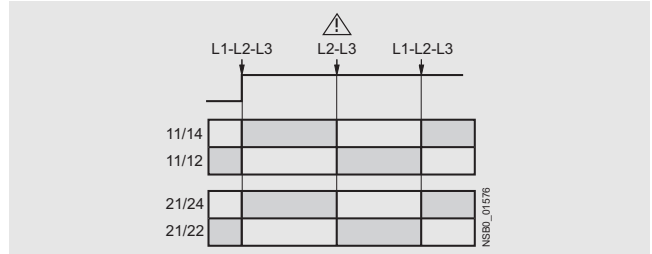

Undervoltage

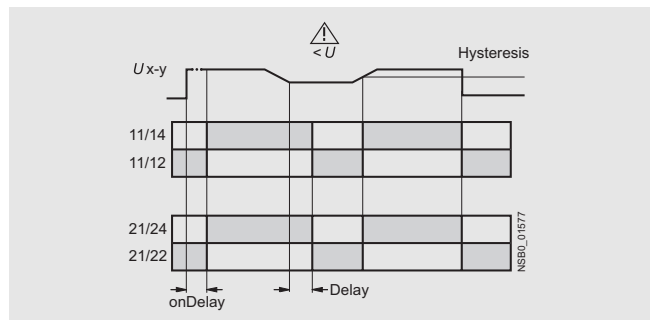

Unbalance

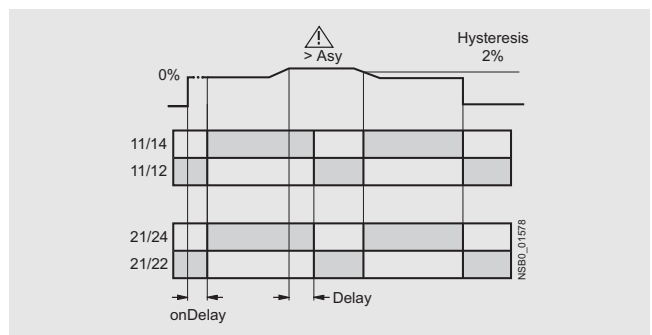

Monitoring Relays

3UG Monitoring Relays for Electrical and Additional Measurements

Line monitoring

3UG46 15/3UG46 16 monitoring relays

The 3UG46 15/3UG46 16 line monitoring relay has a wide voltage range and an internal power supply. The device is equipped with a display and is parameterized using three buttons. The 3UG46 15 device monitors three-phase networks with regard to phase failure, undervoltage, overvoltage and phase sequence. The 3UG46 16 monitoring relay monitors the neutral conductor as well. The hysteresis is adjustable from 1 to 20 V. In addition the device has two separately adjustable delay times for overvoltage and undervoltage from 0 to 20 s in each case. If the direction is incorrect, the device switches off immediately. Thanks to a special measuring method, a phase failure is reliably detected in spite of the wide voltage range from 160 to 690 V AC and feedback through the load of up to 80 %.

The 3UG46 15/ 3UG46 16 monitoring relay can be operated on the basis of either the open-circuit or closed-circuit principle and with manual or auto RESET.

With the closed-circuit principle selected

Wrong phase sequence

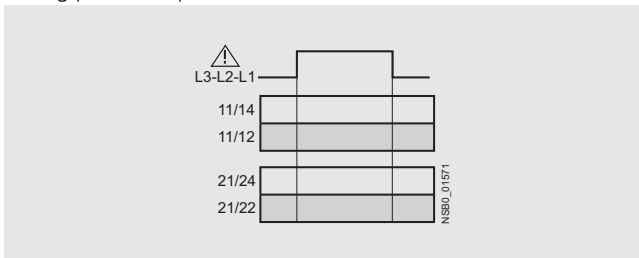

Phase failure

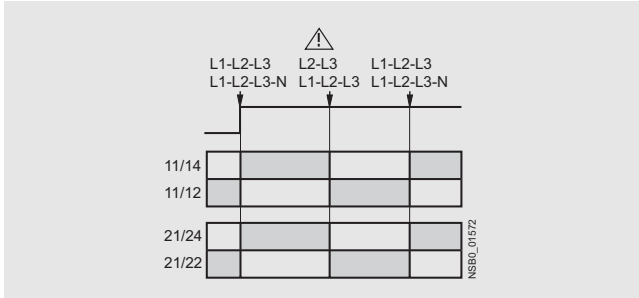

Undervoltage

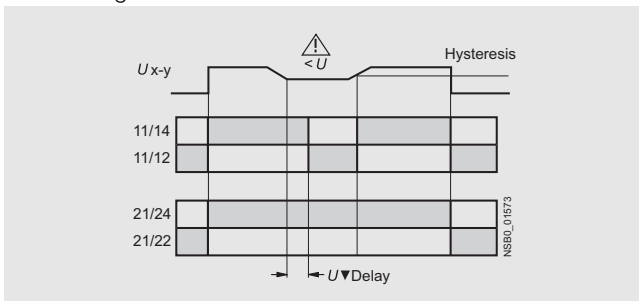

Overvoltage

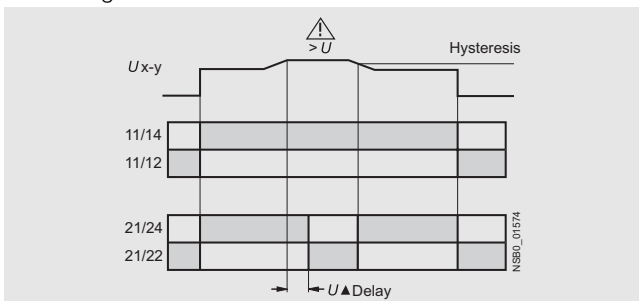

3UG46 17/3UG46 18 monitoring relays

The 3UG46 17/ 3UG46 18 line monitoring relay has an internal power supply and can automatically correct a wrong direction of rotation. Thanks to a special measuring method, a phase failure is reliably detected in spite of the wide voltage range from 160 to 690 V AC and feedback through the load of up to 80 %. The device is equipped with a display and is parameterized using three buttons. The 3UG46 17 line monitoring relay monitors three-phase networks with regard to phase sequence, phase failure, phase unbalance, undervoltage and overvoltage. The 3UG46 18 monitoring relay monitors the neutral conductor as well. The hysteresis is adjustable from 1 to 20 V. In addition the device has delay times from 0 to 20 s in each case for overvoltage, undervoltage, phase failure and phase unbalance. The 3UG46 17/ 3UG46 18 monitoring relay can be operated on the basis of either the open-circuit or closed-circuit principle and with manual or auto RESET.

The one changeover contact is used for warning or disconnection in the event of line faults (voltage, unbalance), the other responds only to a wrong phase sequence. In conjunction with a contactor reversing assembly it is thus possible to change the direction automatically.

With the closed-circuit principle selected

Phase failure

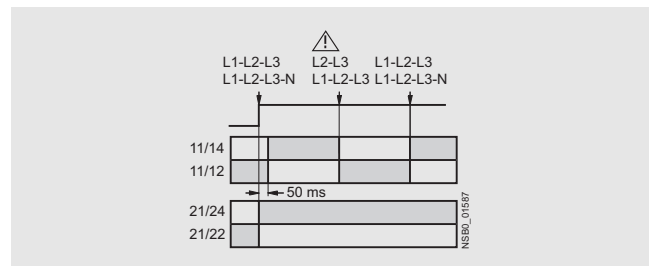

Undervoltage

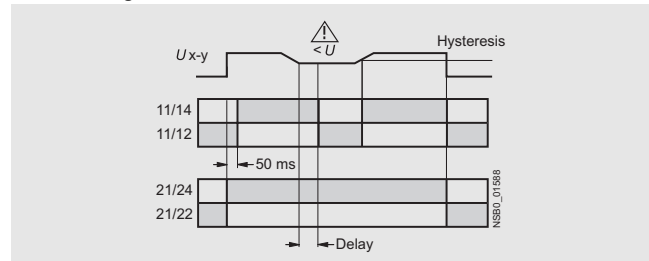

Overvoltage

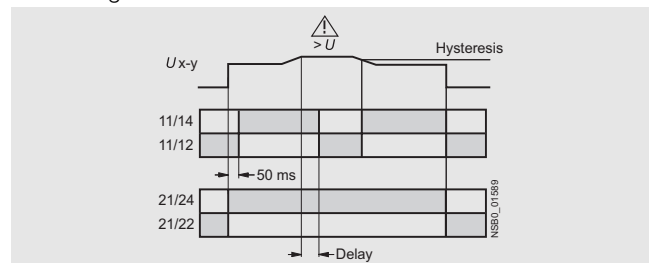

Unbalance

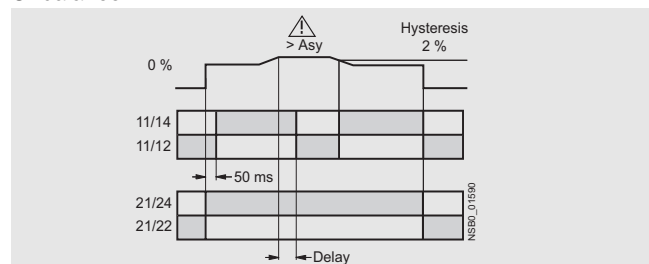

7

Monitoring Relays

3UG Monitoring Relays for Electrical and Additional Measurements

Line monitoring

Technical specifications

		3UG45 11- ..N20	3UG45 11- ..P20	3UG45 11- ..Q20	3UG45 12	3UG45 13	3UG46 14	3UG46 15 3UG46 16 3UG46 17 3UG46 18	
General data									
Rated control supply voltage U_s	V	160 ... 260	320 ... 500	420 ... 690	160 ... 690				
Rated frequency	Hz	50/60							
Rated power, typical									
• At 230 V AC	W/VA	2/4	--	--	2/2.5				
• At 400 V AC	W/VA	--	2/8	--	2/3.5				
• At 460 V AC	W/VA	--	--	2/8	2/4				
Width	mm	22.5							
RESET		Auto-RESET				Automatic/manual			
Principle of operation		Closed-circuit						Closed-circuit, open-circuit (3UG46 17/3UG46 18: closed-circuit)	
Availability time after application of U_s	ms	200			1000				
Response time on reaching a switching threshold	ms	Max. 450							
Adjustable tripping delay time	s	--					0.1 ... 20		
Adjustable ON-delay time	s	--						0.1 ... 20	--
Mains buffering time, min.	ms	10			30				
Rated insulation voltage U_i	V	690							
Degree of pollution 3 Overvoltage category III according to VDE 0110									
Rated impulse withstand voltage	kV	6							
Permissible ambient temperature									
• During operation	°C	-25 ... +60							
• During storage	°C	-40 ... +85							
EMC tests¹⁾		IEC 60947-1/ IEC 61000-6-2 / IEC 61000-6-4							
Degree of protection		IP40 IP20							
• Enclosures									
• Terminals									
Vibration resistance according to IEC 60068-2-6	Hz/mm	1-6/15; 6-500, 20 m/s ²							
Shock resistance according to IEC 60068 Part 2-27	g/ms	15/11							
Conductor cross-section		M3 (standard screwdriver size 2 and Pozidriv 2)							
• Screw terminals									
- Solid	mm ²	1 x (0.5 ... 4) / 2 x (0.5 ... 2.5)							
- Finely stranded with end sleeve	mm ²	1 x (0.5 ... 2.5) / 2 x (0.5 ... 1.5)							
- AWG conductors, solid or stranded	AWG	2 x (20 ... 14)							
- Tightening torque	Nm	0.8 ... 1.2							
• Spring-loaded terminals									
- Solid	mm ²	2 x (0.25 ... 1.5)							
- Finely stranded, with end sleeves according to DIN 46228	mm ²	2 x (0.25 ... 1.5)							
- Finely stranded	mm ²	2 x (0.25 ... 1.5)							
- AWG conductors, solid or stranded	AWG	2 x (24 ... 16)							
Measuring circuit									
Measuring range AC 50/60 Hz rms value	V	160 ... 260	320 ... 500	420 ... 690	160 ... 690				
Setting range	V					200...690	160...690		
Measuring accuracy	%	--				±5			
Repeat accuracy at constant parameters	%	--				±1			
Setting accuracy		--				±10 % referred to set value	±1 V		
Accuracy of digital display		--					+/-1 digit		
Deviations for temperature fluctuations	%/°C	--				±0.1			
Hysteresis for voltage	V	--				5 % of set value	1 ... 20 V		
Hysteresis for unbalance	%	--					2 % of limit value	2 % of limit value for 3UG46 17/ 3UG46 18	
Deviation for frequency fluctuation	%	--				±1 %			

¹⁾ Note: This is a Class A product. In the household environment this device may cause radio interference. In this case the user must introduce suitable measures.

Monitoring Relays

3UG Monitoring Relays for Electrical and Additional Measurements

Line monitoring

	3UG45 11- ..N20	3UG45 11- ..P20	3UG45 11- ..Q20	3UG45 12	3UG45 13	3UG46 14	3UG46 15 3UG46 16 3UG46 17 3UG46 18
Control circuit							
Load capacity of the output relay							
• Thermal current limit I_{th}	A	5					
Rated operational current I_o at							
• AC-15/24 ... 400 V	A	3					
• DC-13/24 V	A	1					
• DC-13/125 V	A	0.2					
• DC-13/250 V	A	0.1					
Minimum contact load at 17 V DC	mA	5					
Output relay with DIAZED fuse	A	4					
gL/gG operational class							
Electrical endurance AC-15	Million oper. cycles	0.1					
Mechanical endurance	Million oper. cycles	10					

Dimensional drawings

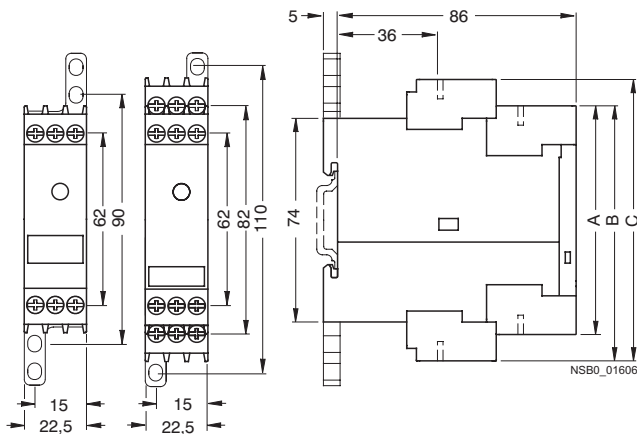

Type	3UG45 11-.A 3UG45 12-.A	3UG45 11-.B 3UG45 12-.B 3UG45 13 3UG46 14 3UG46 15 3UG46 17	3UG46 16 3UG46 18
	A	B	C

Removable terminals

Spring-loaded terminal	84	94	103
Screw terminal	83	92	102

Monitoring Relays

3UG Monitoring Relays for Electrical and Additional Measurements

Line monitoring

Schematics

3UG45 11-A
3UG45 12-A

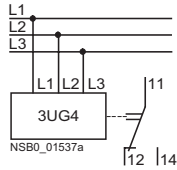

3UG45 11-B
3UG45 12-B
3UG45 13
3UG46 14
3UG46 15
3UG46 17

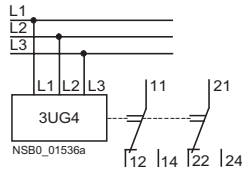

3UG46 16
3UG46 18

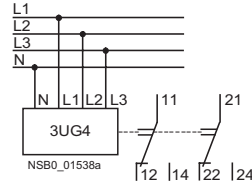

Position of the connection terminals

3UG45 11-A
3UG45 12-A

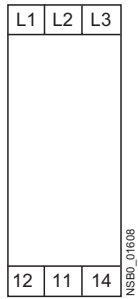

3UG45 11-B
3UG45 12-B
3UG45 13
3UG46 14
3UG46 15
3UG46 17

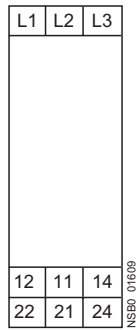

3UG46 16
3UG46 18

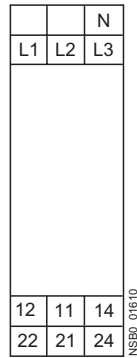

Monitoring Relays

3UG Monitoring Relays for Electrical and Additional Measurements

Voltage monitoring

Overview



The relays monitor single-phase AC and DC voltages against the set threshold value for overshoot and undershoot. The products differ with regard to their power supply (internal or external).

Function

3UG46 33 monitoring relays

The 3UG46 33 voltage monitoring relay has an internal power supply and performs overshoot, undershoot or window monitoring of the voltage depending on how it is parameterized.

The device is equipped with a display and is parameterized using three buttons.

The operating and measuring range extends from 17 V to 275 V AC/DC. The threshold values for overshoot or undershoot can be freely configured within this range. If one of these threshold values is reached, the output relay responds according to the set principle of operation as soon as the tripping delay time has elapsed. This delay time U_{Del} can be set from 0.1 to 20 s like the ON-delay time on_{Del} .

The hysteresis is adjustable from 0.1 to 150 V. The device can be operated on the basis of either the open-circuit or closed-circuit principle and with manual or auto RESET. One output changeover contact is available as signaling contact.

With the closed-circuit principle selected

Overvoltage

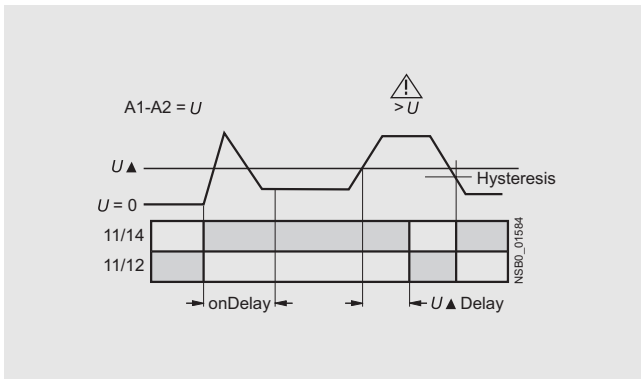

Undervoltage

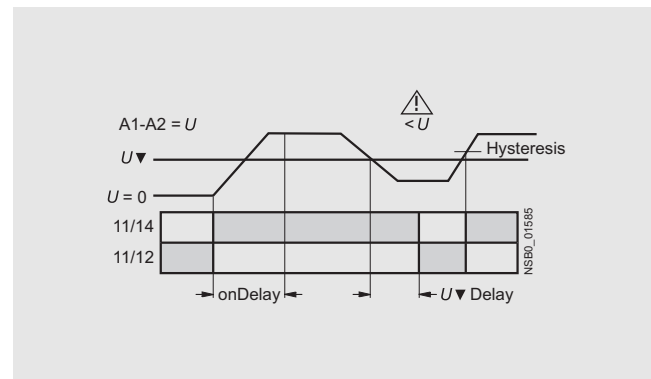

Window monitoring

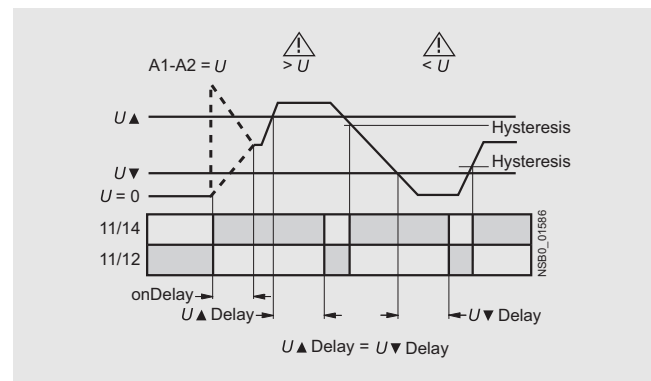

Monitoring Relays

3UG Monitoring Relays for Electrical and Additional Measurements

Voltage monitoring

3UG46 31/3UG46 32 monitoring relays

The 3UG46 31/3UG46 32 voltage monitoring relay is supplied with an auxiliary voltage of 24 V AC/DC or 24 to 240 V AC/DC and performs overshoot, undershoot or window monitoring of the voltage depending on how it is parameterized. The device is equipped with a display and is parameterized using three buttons.

The measuring range extends from 0.1 V to 60 V or 10 to 600 V AC/DC. The threshold values for overshoot or undershoot can be freely configured within this range. If one of these threshold values is reached, the output relay responds according to the set principle of operation as soon as the delay time has elapsed. This delay time U_{Del} can be set from 0.1 to 20 s.

The hysteresis is adjustable from 0.1 to 30 V or 0.1 to 300 V. The device can be operated on the basis of either the open-circuit or closed-circuit principle and with manual or auto RESET. One output changeover contact is available as signaling contact.

With the closed-circuit principle selected

Overvoltage

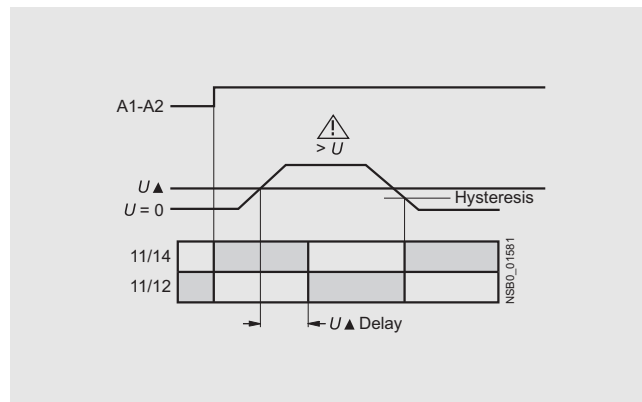

Undervoltage

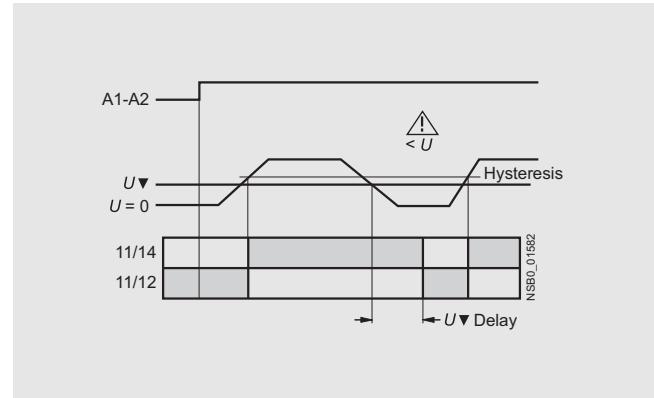

Window monitoring

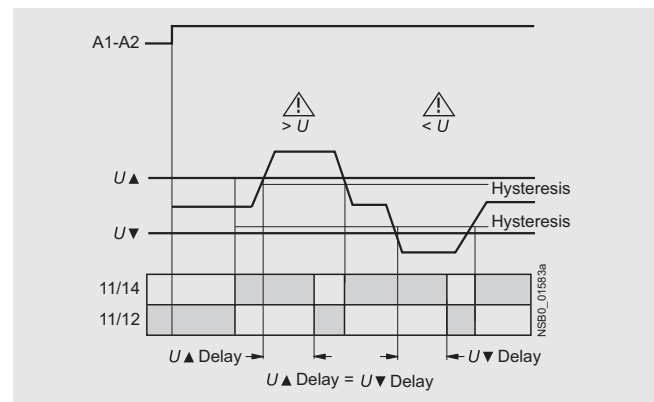

Monitoring Relays

3UG Monitoring Relays for Electrical and Additional Measurements

Voltage monitoring

Technical specifications

		3UG46 31- .AA	3UG46 31- .AW	3UG46 32- .AA	3UG46 32- .AW	3UG46 33
General data						
Rated control supply voltage U_s	V	24 AC/DC	24 ... 240 AC/DC	24 AC/DC	24 ... 240 AC/DC	17 ... 275 AC/DC
Rated frequency for AC	Hz	50/60				40 ... 500
Operating range	V	20.4 ... 27.6	20.4 ... 264	20.4 ... 27.6	20.4 ... 264	17...275
Rated power in W/VA	VA	2/4				
Width	mm	22.5				
RESET		Automatic / manual				
Availability time after application of U_s	ms	1000				
Response time on reaching a switching threshold	ms	450				
Adjustable tripping delay time	s	0.1 ... 20				
Adjustable ON-delay time	s	--				0.1 ... 20
Mains buffering time , min.	ms	10				
Rated insulation voltage U_i Degree of pollution 3 Overvoltage category III according to VDE 0110	V	690				
Rated impulse withstand voltage U_{imp}	kV	6				
Safe isolation according to EN 60947-1	V	300				
Permissible ambient temperature • During operation • During storage	°C	-25 ... +60 -40 ... +85				
EMC tests¹⁾		IEC 60947-1 / IEC 61000-6-2 / IEC 61000-6-4				
Degree of protection • Enclosures • Terminals		IP40 IP20				
Vibration resistance according to IEC 60068-2-6	Hz/mm	1-6/15; 6-500, 20 m/s ²				
Shock resistance according to IEC 60068 Part 2-27	g/ms	15/11				
Conductor cross-section • Screw terminals - Solid - Finely stranded with end sleeve - AWG conductors, solid or stranded - Tightening torque • Spring-loaded terminals - Solid - Finely stranded, with end sleeves according to DIN 46228 - Finely stranded - AWG conductors, solid or stranded	mm ² mm ² AWG Nm mm ² mm ² mm ² AWG	M3 (standard screwdriver size 2 and Pozidriv 2) 1 x (0.5 ... 4) / 2 x (0.5 ... 2.5) 1 x (0.5 ... 2.5) / 2 x (0.5 ... 1.5) 2 x (20 ... 14) 0.8 ... 1.2 2 x (0.25 ... 1.5) 2 x (0.25 ... 1.5) 2 x (0.25 ... 1.5) 2 x (24 ... 16)				
Measuring circuit						
Permissible measuring range single-phase AC/DC voltage	V	0.1 ... 68		10 ... 650		17 ... 275
Setting range single-phase voltage	V	0.1 ... 60		10 ... 600		17 ... 275
Measuring frequency	Hz	40 ... 500				40 ... 500
Measuring accuracy	%	5				
Repeat accuracy at constant parameters	%	1				
Accuracy of digital display		±1 digit				
Deviations for temperature fluctuations	%/°C	±0.1				
Hysteresis for single-phase voltage	V	0.1 ... 30		0.1 ... 300		0.1 ... 150
Control circuit						
Load capacity of the output relay • Thermal current limit I_{th}	A	5				
Rated operational current I_e at • AC-15/24 ... 400 V • DC-13/24 V • DC-13/125 V • DC-13/250 V	A	3 1 0.2 0.1				
Minimum contact load at 17 V DC	mA	5				
Output relay with DIAZED fuse gL/gG operational class	A	4				
Electrical endurance AC15	Million oper. cycles	0.1				
Endurance with contactor relay	Million oper. cycles	10				

¹⁾ Note: This is a Class A product. In the household environment this device may cause radio interference. In this case the user must introduce suitable measures.



Monitoring Relays

3UG Monitoring Relays for Electrical and Additional Measurements

Voltage monitoring

Dimensional drawings

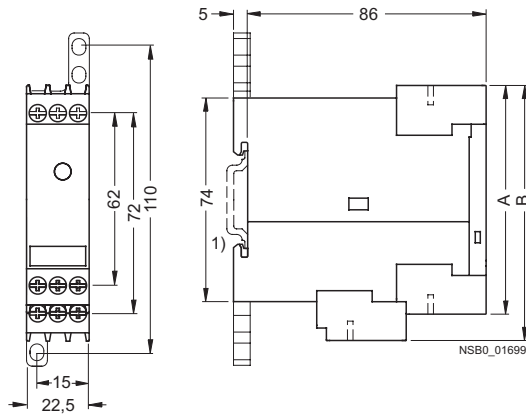

Type	3UG46 31 3UG46 32 3UG46 33	3UG46 31 3UG46 32 3UG46 33
	A	B

Removable terminals

Spring-loaded terminal	84	94
Screw terminal	83	92

¹⁾ For standard mounting rail according to EN 60715.

Schematics

3UG46 31-AA30
3UG46 32-AA30

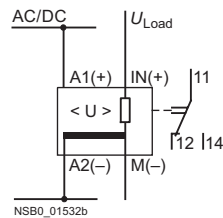

3UG46 31-AW30
3UG46 32-AW30

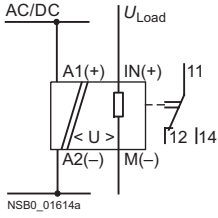

3UG46 33

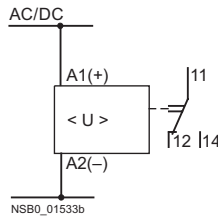

Position of the connection terminals

3UG46 31
3UG46 32

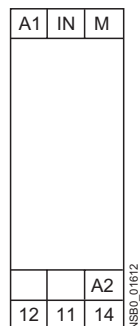

3UG46 33

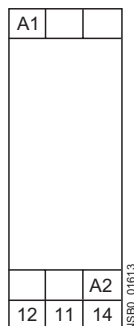

Monitoring Relays

3UG Monitoring Relays for Electrical and Additional Measurements

Current monitoring

Overview

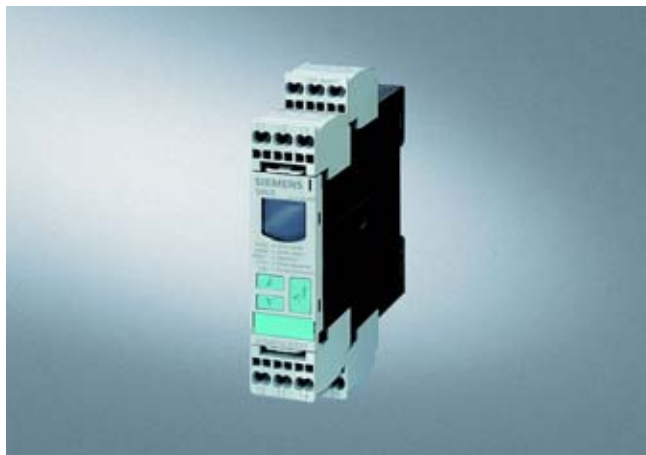

The relays monitor single-phase currents for overshoot and undershoot against the set threshold. They differ with regard to their measuring ranges and voltage types.

Function

3UG46 21/3UG46 22 monitoring relays

The 3UG46 21/3UG46 22 current monitoring relay is supplied with an auxiliary voltage of 24 V AC/DC or 24 to 240 V AC/DC and performs overshoot, undershoot or window monitoring of the current depending on how it is parameterized. The device is equipped with a display and is parameterized using three buttons.

The measuring range extends from 3 to 500 mA or 0.05 to 10 A. The rms value of the current is measured. The threshold values for overshoot or undershoot can be freely configured within this range. If one of these threshold values is reached, the output relay responds according to the set principle of operation as soon as the tripping delay time I_{Del} has elapsed. This time and the ON-delay time on_{Del} are adjustable from 0.1 to 20 s.

The hysteresis is adjustable from 0.1 to 250 mA or 0.01 to 5 A. The device can be operated on the basis of either the open-circuit or closed-circuit principle and with manual or auto RESET. One output changeover contact is available as signaling contact.

With the closed-circuit principle selected

Current overshoot

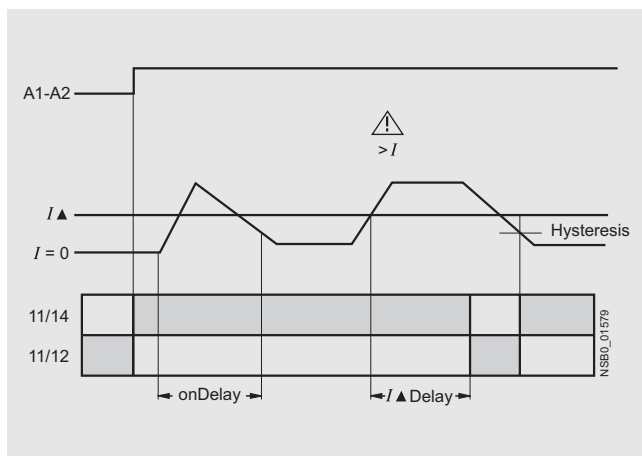

Current undershoot

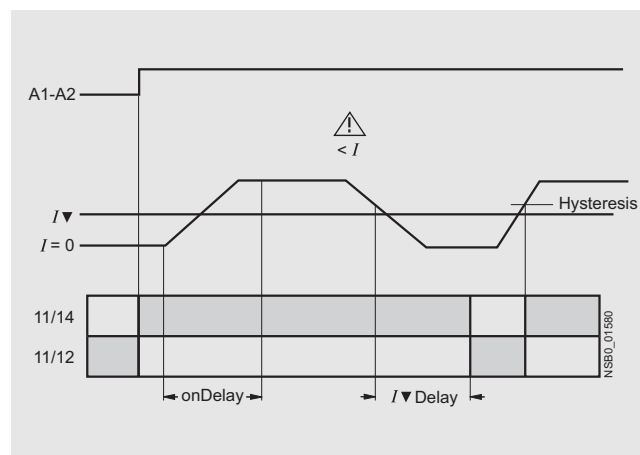

Window monitoring

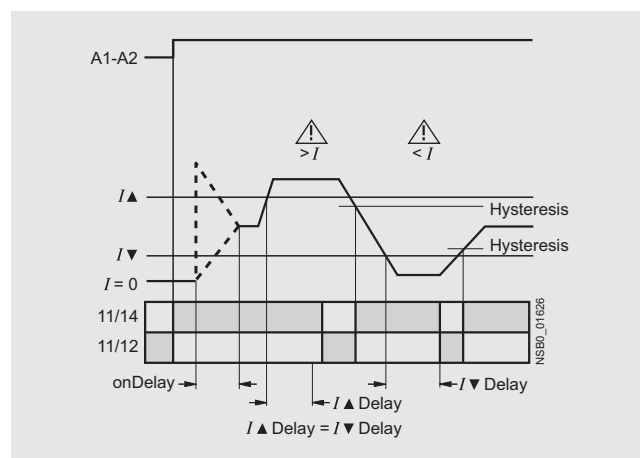

7

Monitoring Relays

3UG Monitoring Relays for Electrical and Additional Measurements

Current monitoring

Technical specifications

		3UG46 21-.AA	3UG46 21-.AW	3UG46 22-.AA	3UG46 22-.AW
General data					
Rated control supply voltage U_s	V	24	24 ... 240	24	24 ... 240
Rated frequency	Hz	50/60			
Operating range	V	20.4 ... 26.4	20.4 ... 264	20.4 ... 26.4	20.4 ... 264
Rated power	W/VA	2/4			
Width	mm	22.5			
RESET		Automatic/ manual			
Availability time after application of U_s	ms	1000			
Response time on reaching a switching threshold	ms	450			
Adjustable tripping delay time	s	0.1 ... 20			
Adjustable ON-delay time	s	0.1 ... 20			
Mains buffering time, min.	ms	10			
Rated insulation voltage U_i Degree of pollution 3; overvoltage category III according to VDE 0110	V	690			
Rated impulse withstand voltage U_{imp}	kV	6			
Safe isolation according to EN 60947-1	V	300			
Permissible ambient temperature					
• During operation	°C	-25 ... +60			
• During storage	°C	-40 ... +85			
EMC tests¹⁾		IEC 60947-1/ IEC 61000-6-2 / IEC 61000-6-4			
Degree of protection					
• Enclosure		IP40			
• Terminals		IP20			
Vibration resistance according to IEC 60068-2-6	Hz/mm	1-6/15; 6-500.20 m/s ²			
Shock resistance according to IEC 60068 Part 2-27	g/ms	15/11			
Conductor cross-section					
• Screw terminals					
- Solid	mm ²	M3 (standard screwdriver size 2 and Pozidriv 2)			
- Finely stranded with end sleeve	mm ²	1 x (0.5 ... 4) / 2 x (0.5 ... 2.5)			
- AWG conductors, solid or stranded	AWG	1 x (0.5 ... 2.5) / 2 x (0.5 ... 1.5)			
- Tightening torque	Nm	2 x (20 ... 14)			
• Spring-loaded terminals					
- Solid	mm ²	0.8 ... 1.2			
- Finely stranded, with end sleeves according to DIN 46228	mm ²	2 x (0.25 ... 1.5)			
- Finely stranded	mm ²	2 x (0.25 ... 1.5)			
- AWG conductors, solid or stranded	AWG	2 x (0.25 ... 1.5)			
	AWG	2 x (24 ... 16)			
Measuring circuit					
Measuring range for single-phase AC/DC current	A	0.003 ... 0.6		0.05 ... 15	
Setting range for single-phase current	A	0.003 ... 0.5		0.05 ... 10	
Load supply voltage	V	24	Max. 300 ²⁾ Max. 500 ³⁾	24	Max. 300 ²⁾ Max. 500 ³⁾
Measuring accuracy	%	5			
Repeat accuracy at constant parameters	%	1			
Accuracy of digital display		±1 digit			
Deviations for temperature fluctuations	%/°C	±0.1			
Hysteresis for single-phase current		0.1 ... 250 mA		0.01 ... 5 A	
Permissible overcurrent, continuous	A	0.6		15	
Permissible overcurrent, < 1 s	A	5		50	
Protection against destruction, DIAZED gL/gG	A	2		16	
Measuring circuit internal resistance, shunt	mΩ	500		5	
Control circuit					
Load capacity of the output relay					
• Thermal current limit I_{th}	A	5			
Rated operational current I_e at					
• AC-15/24 ... 400 V	A	3			
• DC-13/24 V	A	1			
• DC-13/125 V	A	0.2			
• DC-13/250 V	A	0.1			
Minimum contact load at 17 V DC	mA	5			
Output relay with DIAZED fuse gL/gG	A	4			
Electrical endurance AC15	Million oper. cycles	0.1			
Endurance with contactor relay	Million oper. cycles	10			

¹⁾ Note: This is a Class A product. In the household environment this device may cause radio interference. In this case the user must introduce suitable measures.

²⁾ With safe isolation.

³⁾ With easy isolation.

Monitoring Relays

3UG Monitoring Relays for Electrical and Additional Measurements

Current monitoring

Dimensional drawings

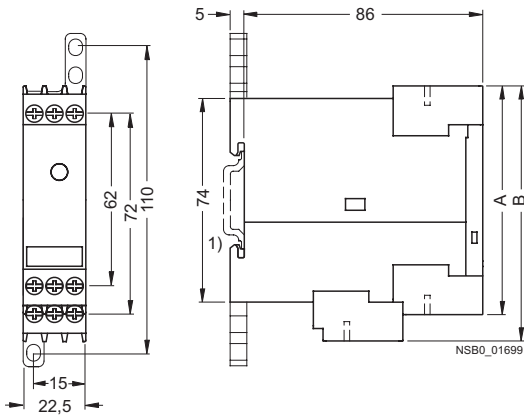

Type	3UG46 21	3UG46 22
	A	B
Removable terminals		
Spring-loaded terminal	84	94
Screw terminal	83	92

1) For standard mounting rail according to EN 60715.

Schematics

3UG46 21-AA30 3UG46 22-AA30

Operation with separate control circuit and load circuit

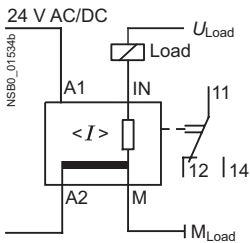

Operation with joint control circuit and load circuit

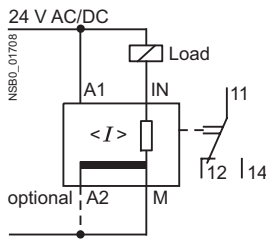

3UG46 21-AW30 3UG46 22-AW30

1-phase operation

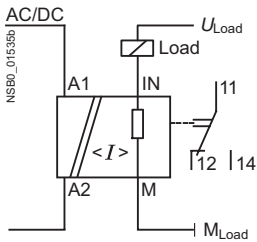

3-phase operation

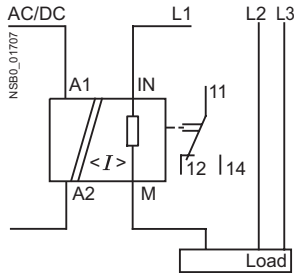

Wiring diagram for 24 V AC/DC (only 3UG46 21-AA30)

From the following circuit diagrams it is clear that loads in measuring circuits have to be in the current flow upstream from the monitoring relay. Otherwise the monitoring relay could be destroyed and the short-circuit current could cause damage to the plant.

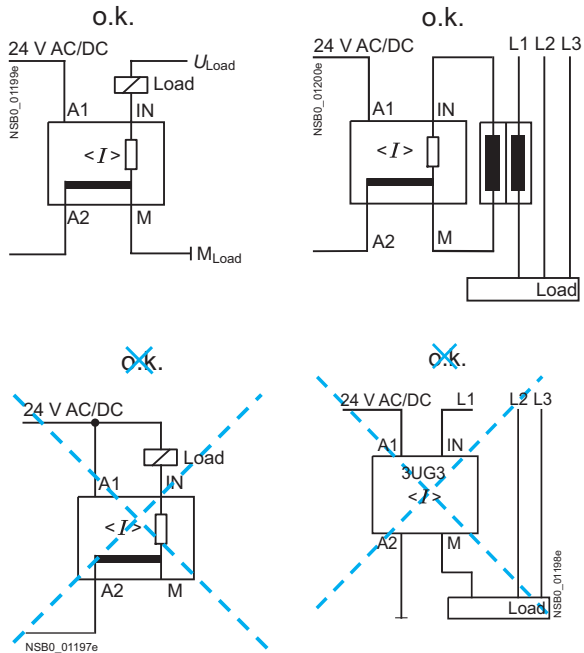

Position of the connection terminals

3UG46 21 3UG46 22

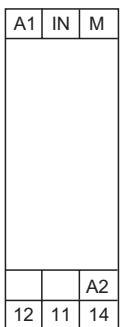

Configuring note:

A2 and M are electrically connected internally!

For applications in which the load to be monitored and the monitoring relay are supplied from the same power supply, there is no need for connection A2!

The load current must always flow through M or the monitoring relay may be destroyed!



Monitoring Relays

3UG Monitoring Relays for Electrical and Additional Measurements

Power factor and active current monitoring

Overview

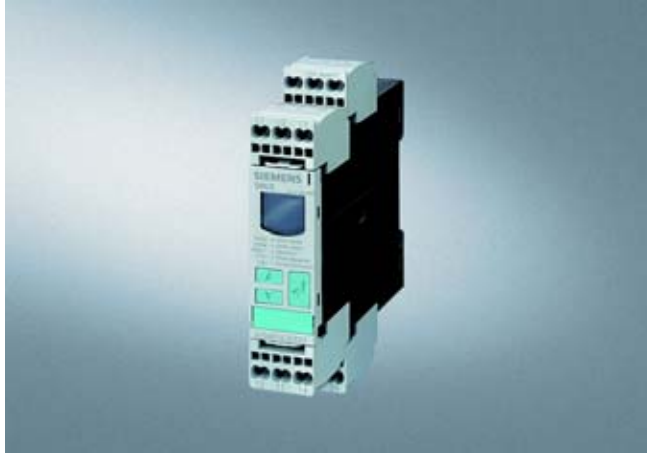

The 3UG46 41 power factor and active current monitoring device enables the load monitoring of motors.

Whereas power factor monitoring is used above all for monitoring no-load operation, the active current monitoring option can be used to observe and evaluate the load factor over the entire torque range.

Function

3UG46 41 monitoring relays

The 3UG46 41 monitoring relay is self-powered and serves the single-phase monitoring of the power factor or performs overshoot, undershoot or window monitoring of the active current depending on how it is parameterized.

The load to be monitored is connected in front of the IN terminal. The load current flows over the IN and Ly/N terminals. The setting range for the power factor is 0.1 ... 0.99 and for the active current I_{res} 0.2 ... 10 A.

If the supply voltage is switched on and no load current is flowing, the display indicates $I < 0,2$ and a symbol for overshoot, undershoot or window monitoring.

If the motor is now switched on and the current exceeds 0.2 A, the set ON-delay time begins. During this time, an undershooting or overshooting of the set limit values will not lead to a relay response of the changeover contact.

If the operational flowing active current and/or the power factor value falls below or exceeds the respective set threshold value, the spike delay begins. When this time has expired, the relay changes its switch position. The relevant measured variables for overshooting and undershooting in the display flashes.

The relay operates either according to the open-circuit or closed-circuit principle.

If the device is set to Auto-RESET (Memory = No), depending on the set principle of operation, the switching relay returns to its initial state and the flashing ends when the hysteresis threshold is reached.

If manual reset is selected in the menu (Memory = Yes), the switching relay remains in its current switching state and the current measured value and the symbol for undershooting and overshooting continues to flash, even when the measured variable reaches a permissible value again. This stored fault status can be reset by pressing the UP▲ and DOWN▼ key simultaneously for 2 seconds, or by switching the supply voltage off and back on again.

With the closed-circuit principle selected

Display outside the measuring range limits

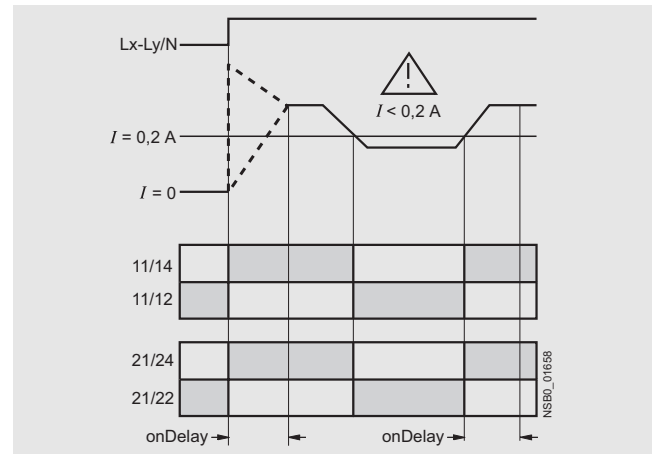

Overshooting of active current

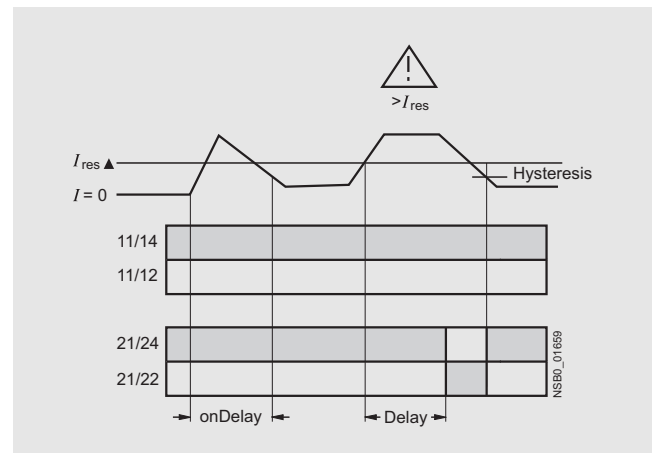

Monitoring Relays

3UG Monitoring Relays for Electrical and Additional Measurements

Power factor and active current monitoring

Undershooting of active current

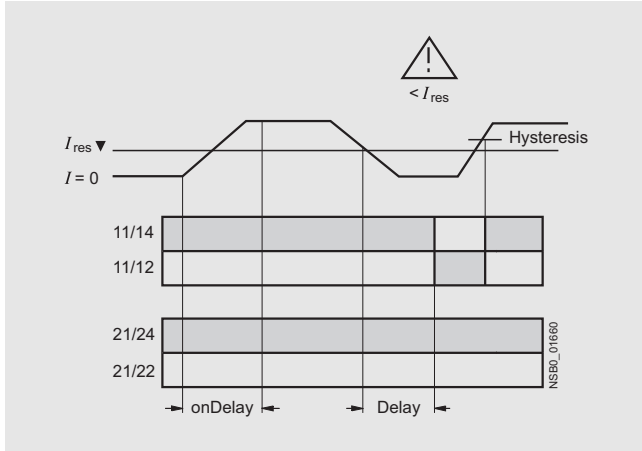

Undershooting of power factor

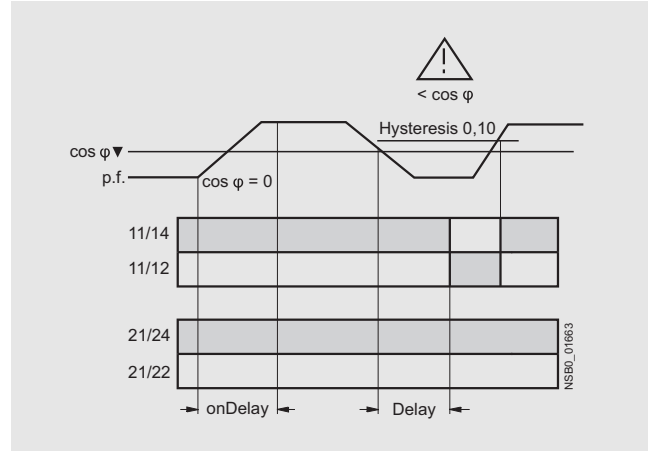

Window monitoring of active current

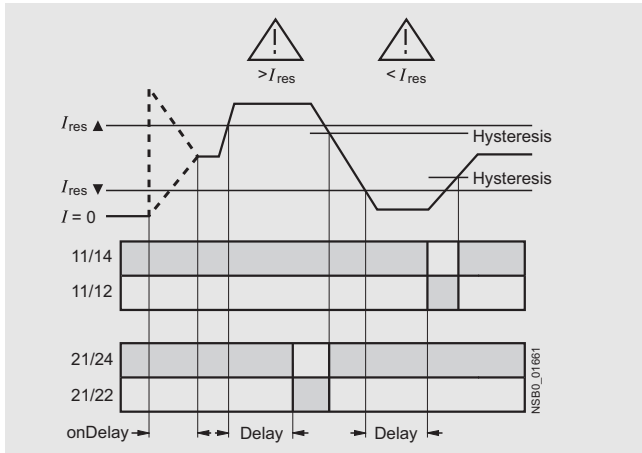

Window monitoring of power factor

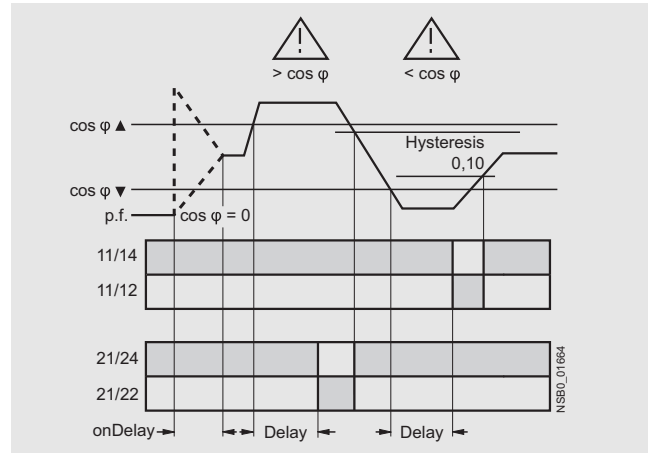

Overshooting of power factor

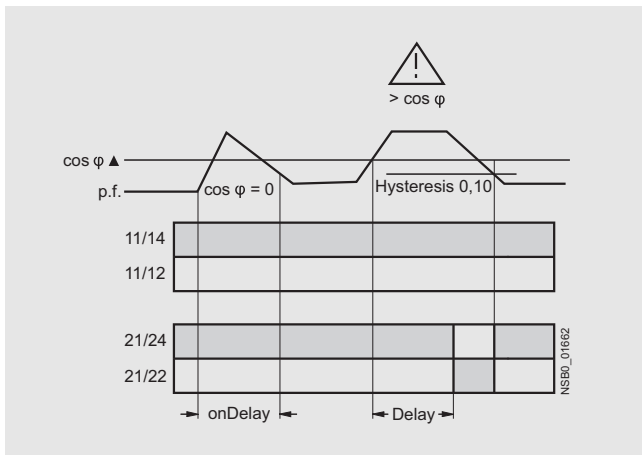

Legend

p.f.: power factor
 $\cos \phi$: power factor

Monitoring Relays

3UG Monitoring Relays for Electrical and Additional Measurements

Power factor and active current monitoring

Technical specifications

Type	3UG46 41	
General data		
Rated control supply voltage U_s	V	90 ... 690
Rated frequency	Hz	50/60
Rated power, typical		
• At 200 V AC	VA	2.0
• At 400 V AC	VA	2.7
• At 460 V AC	VA	3.1
Width	mm	22.5
RESET		Automatic / manual
Principle of operation		Closed-circuit principle, open-circuit principle
Availability time after application of U_s	ms	1000
Response time on reaching a switching threshold	ms	450
Adjustable tripping delay time	s	0.1 ... 20
Adjustable ON-delay time	s	0 ... 99
Mains buffering time, min.	ms	10
Rated insulation voltage U_i	V	690
Degree of pollution 3 Overvoltage category III according to VDE 0110		
Rated impulse withstand voltage	kV	6
Permissible ambient temperature		
• During operation	°C	-25 ... +60
• During storage	°C	-40 ... +85
EMC tests ¹⁾		IEC 60947-1 / IEC 61000-6-2 / IEC 61000-6-4
Degree of protection		
• Enclosures		IP40
• Terminals		IP20
Vibration resistance according to IEC 60068-2-6	Hz/mm	5 ... 25/0.75
Shock resistance according to IEC 60068 Part 2-27	g/ms	15/11
Conductor cross-section		
• Screw terminals		M3 (standard screwdriver size 2 and Pozidriv 2)
- Solid	mm ²	1 x (0.5 ... 4) / 2 x (0.5 ... 2.5)
- Finely stranded with end sleeve	mm ²	1 x (0.5 ... 2.5) / 2 x (0.5 ... 1.5)
- AWG conductors, solid or stranded	AWG	2 x (20 ... 14)
- Tightening torque	Nm	0.8 ... 1.2
• Spring-loaded terminals		
- Solid	mm ²	2 x (0.25 ... 1.5)
- Finely stranded, with end sleeves according to DIN 46228	mm ²	2 x (0.25 ... 1.5)
- Finely stranded	mm ²	2 x (0.25 ... 1.5)
- AWG conductors, solid or stranded	AWG	2 x (24 ... 16)
Measuring circuit		
Measurable active current I_{res}	A	0.2 ... 10
Max. permissible load current	A	10
Peak current < 1 s	A	50
Adjustable response value		0.1 ... 0.99
Phase displacement angle		
DIAZED protection, gL/gG operational class	A	16
Measuring accuracy	%	10
Repeat accuracy at constant parameters	%	1
Accuracy of digital display		± 1 digit
Deviations for temperature fluctuations	%/°C	± 0.1
Hysteresis Phase angle		0.10
Hysteresis Active current monitoring	A	0.1 ... 2.0

¹⁾ Note: This is a Class A product. In the household environment this device may cause radio interference. In this case the user must introduce suitable measures.

Monitoring Relays

3UG Monitoring Relays for Electrical and Additional Measurements

Power factor and active current monitoring

Type	3UG46 41	
Control circuit		
Number of CO contacts for auxiliary contacts		2
Load capacity of the output relay		
• Thermal current I_{th}	A	5
Rated operational current I_o at		
• AC-15/230 V	A	3
• DC-13/24 V	A	1
• DC-13/110 V	A	0.2
• DC-13/230 V	A	0.1
Minimum contact load at 17 V DC	mA	5
Output relay with DIAZED fuse gL/gG operational class	A	4
Electrical endurance AC-15	Million oper. cycles	0.1
Mechanical endurance	Million oper. cycles	10

Dimensional drawings

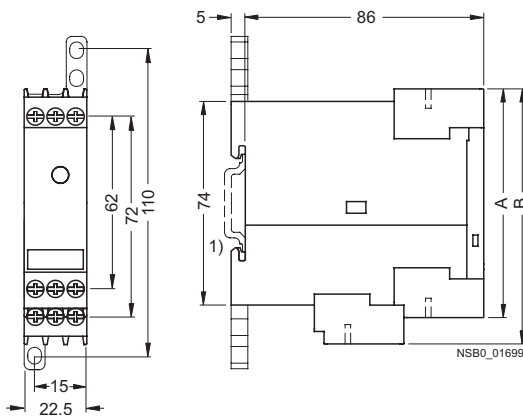

Type	3UG46 41	
Removable terminals	A	B
Spring-loaded terminals	84	94
Screw terminal	83	92

¹⁾ For standard mounting rail according to EN 60715.

Monitoring Relays

3UG Monitoring Relays for Electrical and Additional Measurements

Power factor and active current monitoring

Schematics

1-phase motors

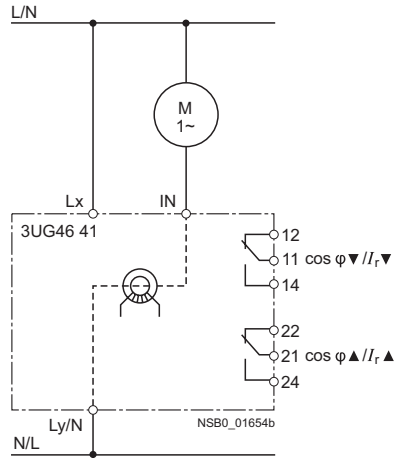

3-phase motors

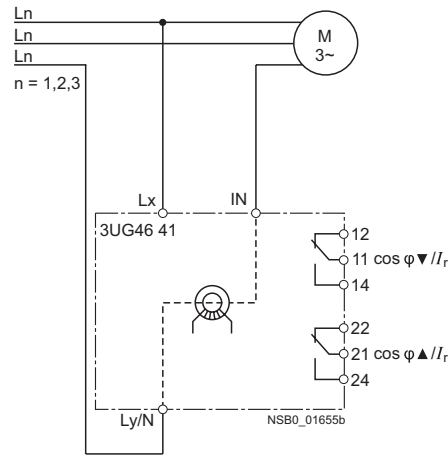

3-phase motors with transformers for currents > 10 A

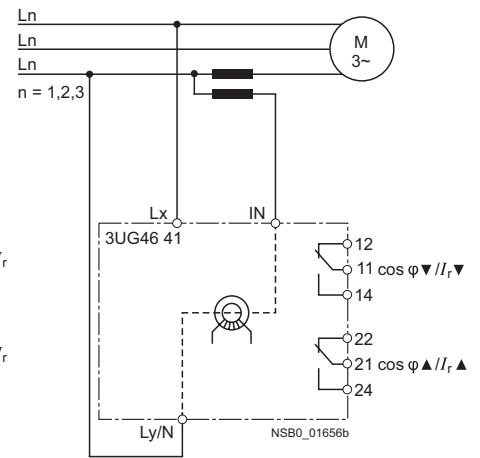

Position of the connection terminals

3UG46 41

Lx	Ly/N	IN
12	11	14
22	21	24

NSB0_01657

Monitoring Relays

3UG Monitoring Relays for Electrical and Additional Measurements

Insulation monitoring
for ungrounded AC networks

Overview



Relay for monitoring the insulation resistance between the ungrounded single or three-phase AC supply and a protective conductor

- Measuring principle with superimposed DC voltage
- Two selectable measuring ranges of 1 ... 110 k Ω
- Stepless setting within the measuring range
- Selectable:
 - Auto reset function with fixed hysteresis or
 - Storage of the tripping operation
- Test function with test button and terminal connections on the front
- Switching output: 1 CO contact
- Insulation fault indication with a red LED
- Supply voltage indication with a green LED
- Electro-magnetically compatible according to EN 50081 and EN 61000-6-2.

Function

The monitoring relay measures the insulation resistance between the ungrounded AC supply and an associated protective conductor.

A superposed DC measuring voltage is used to perform the measurement.

The monitoring relay is divided into two ranges for an insulation resistance range from 1 ... 100 k Ω . A range switch on the front can be used to switch over between a 1 ... 11 k Ω range and a 10 ... 110 k Ω range. Within the selected range, the monitoring relay can be steplessly adapted to the respective insulation conditions.

If the insulation resistance undershoots the set response value, the output relay is excited and the red LED (fault indication) is lit.

If the insulation resistance exceeds 1.6 times (corresponding to 60 % hysteresis) the set response value, the output relay will return to the rest position.

Test functions

The "Test" button on the front can be used to simulate a ground fault. If the "Test" button is pressed for at least 300 ms, the output relay is energized and the fault LED lights up. An external test button can be connected to terminal Y1. The function is activated by closing (> 300 ms).

Fault storage and RESET

If terminals Y1 and Y2 are jumpered, the monitoring relay is set to fault storage mode. If the set insulation resistance is under-shot, the output relay is excited and remains tripped even after the insulation resistance rises above 1.6 times the set value again. Fault storage can be reset by briefly pressing the RESET button, briefly jumpering (< 300 ms) the Y1 and PE/ground terminals or by switching off and on the supply voltage.

Note:

The monitoring relay is designed for AC voltage systems. Series-connected rectifiers must be galvanically isolated from the measuring relay.

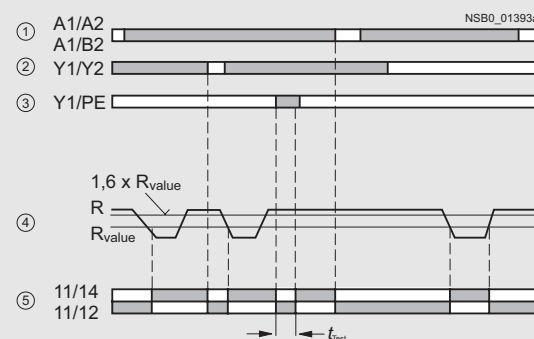

- ① = Supply voltage
A1-B2/A1-A2 for AC 115V/230V
A1-A2 for AC/DC 24 ... 240V
- ② = Remote connection-Save-Reset
- ③ = Button on the front Test/Reset
- ④ = Insulation resistance R of the network
- ⑤ = Normally open contact
- $t_{\text{test}} = > \text{approx. } 300 \text{ ms}$

7

Monitoring Relays

3UG Monitoring Relays for Electrical and Additional Measurements

Insulation monitoring for ungrounded AC networks

Technical specifications

			3UG30 81
Control circuit			
Operating range of the control supply voltage			-15 %... +10 %
Rated power	24 ... 240 V AC	VA/W	8 / 2
	110 ... 130 V AC	VA	3
	220 ... 240 V AC	VA	3
Frequency of the rated control supply voltage			Hz 50 ... 60
Measuring circuit L/PE/ground			
• Response value	k		1...110
• Minimum internal resistance for AC	k		100
• Minimum internal resistance for DC	k		100
• DC measurement voltage	V		30 DC
• Insulation voltage	V		415 AC
• Reset/test function terminals (max. 10 m)			Y1-Y2
• Delay time in case of response	s		1
Output relay			1 CO contact, open-circuit principle
General data			
Rated insulation voltage U_i	Between supply, measurement, and output circuit	V	400 according to IEC 60947-1
Overvoltage category	According to IEC 664		III
Degree of pollution	According to IEC 664		3
Impulse withstand voltage U_{imp}	According to VDE 0435, Part 303	kV	4
Degree of protection	According to EN 60529		IP50 enclosure, IP20 terminals
Shock resistance	According to IEC 60068 Part 2-27	g/ms	10
Vibration resistance	According to IEC 60068-2-6	Hz/mm	10-55/0.35
Permissible ambient temperature			
• During operation	°C		-25 ... 65
• During storage	°C		-40 ... 85
Permissible mounting position			Any
Conductor cross-section	Solid	mm ²	2 x 0.75 ... 2.5
	Finely stranded with end sleeve	mm ²	2 x 0.75 ... 2.5

Dimensional drawings

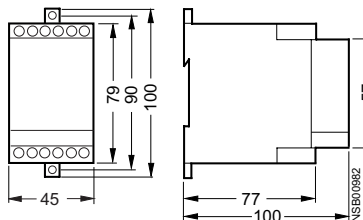

Schematics

Connection diagram for networks up to 400 V AC

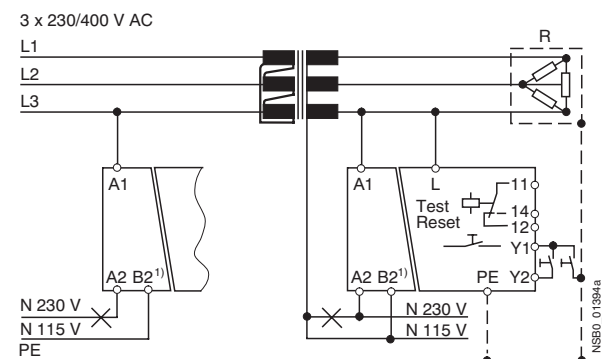

A1-B2/A1-A2 for AC 115 V/230 V
A1-A2 for AC/DC 24...240 V

¹⁾ Only 3UG3081-1AK20.

Monitoring Relays

3UG Monitoring Relays for Electrical and Additional Measurements

Insulation monitoring
for ungrounded DC networks

Overview



Relay for monitoring the insulation resistance between ungrounded pure DC networks and a protective conductor

- Measuring principle for differential current measurement
- Response value can be set continuously from 10 ... 110 kΩ
- Selectable
 - Auto reset function with hysteresis or
 - Storage of the tripping operation
- Front selector switch for open-circuit and closed-circuit principle for the output relay
- Test function with test buttons on the front for L+ and L- and over terminal connections
- Switching output: 1 CO contact
- Insulation fault indicator for L+ and L- through two red LEDs
- Supply voltage indication with a green LED
- Electro-magnetically compatible according to EN 50081 and EN 61000-6-2.

Function

The monitoring relay measures the insulation resistance between the positive and negative supply voltage in an ungrounded DC voltage network and a corresponding protective conductor.

The measurement is based on the DC residual current measurement principle. The response value can be adjusted steplessly in the range from 10 ... 110 kΩ and thus can be adapted to the corresponding conditions. If the insulation resistance falls below the set response value, the output relay triggers (depending on the setting of the open/closed-circuit principle selector switch) and a fault LED lights up.

A ground fault is evaluated separately for L+ and L- and indicated by means of a corresponding LED.

Note:

Due to the measurement principle, a symmetrical ground fault on terminals L+ and L- cannot be evaluated.

Test function

A ground fault can be simulated using the Test L+ and Test L- buttons on the front. If the test button is pressed for at least 1 s, the status of the output relay changes and the corresponding fault LED lights up.

An external test button can be connected to terminals Y1-Y3 for L+ and terminals Y4-Y3 for L-. The function is triggered by means of a NO contact.

Fault storage and RESET

If terminals Y2 and Y3 are linked, the monitoring relay is set to fault storage mode.

If the insulation resistance falls below the set value, the output relay triggers (depending on the setting of the open/closed circuit selector switch), and stays in this state even if the insulation resistance rises again above the hysteresis value (typical: 2 times the set value). This fault storage can be deleted by pressing and releasing the L+ RESET button, opening the Y2-Y3 connection or by switching off the supply voltage.

Open/closed-circuit principle selector switch

The principle of operation of the output relay can be adjusted by means of a selector switch on the front panel.

If the relay is to respond in the event of a fault (contact symbol open), the open-circuit principle must be selected. If the relay however is to trigger in the event of a fault (contact symbol closed), the closed-circuit principle must be selected.

Note:

The position of the selector switch has no effect upon the fault LEDs. The LEDs always light up if the insulation resistance on L+ or L- falls below the set value.

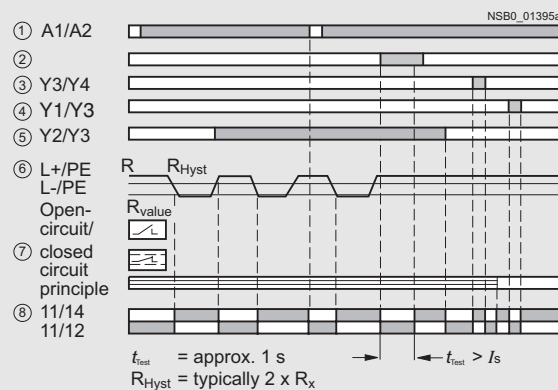

Monitoring Relays

3UG Monitoring Relays for Electrical and Additional Measurements

Insulation monitoring for ungrounded DC networks

Technical specifications

		3UG30 82	
Control circuit			
Operating range of the control supply voltage		-15 %... +10 %	
Rated power	24 ... 240 V AC/DC	VA/W	8 / 2
Frequency of the rated control supply voltage		Hz	50 ... 60
Measuring circuit			
• Response value		k	10 ... 110
• Minimum internal resistance for DC		k	57
• Measurement DC voltage		V	24 ... 240
• Max. DC insulation voltage (L+/PE/ground, L-/PE/ground)		V DC	300
• Reset/test function terminals (max. 10 m)			Y1/Y3, Y4/Y3
• Delay time in case of response		s	1
Output relay		1 changeover contact, open-circuit or closed-circuit principle	
General data			
Rated insulation voltage U_i	Between supply, measurement, and output circuit	V	400
Insulation resistance	According to IEC 664		III
Overvoltage category	According to IEC 664		3
Degree of pollution	According to IEC 664		3
Impulse withstand voltage U_{imp}	According to VDE 0435, Part 303	V	4000
Degree of protection	According to EN 60529		IP50 enclosure, IP20 terminals
Shock resistance	According to IEC 60068 Part 2-27	g/ms	10
Vibration resistance	According to IEC 60068-2-6	Hz/mm	10-55/0.35
Permissible ambient temperature			
• During operation		°C	-25 ... +65
• During storage		°C	-40 ... +85
Permissible mounting position		Any	
Conductor cross-section			
	Solid	mm ²	2 x 0.75 ... 2.5
	Finely stranded with end sleeve	mm ²	2 x 0.75 ... 2.5

Dimensional drawings

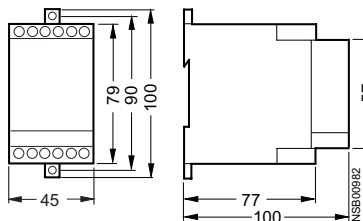

Circuit diagram

Connection diagram for 24...240 V DC

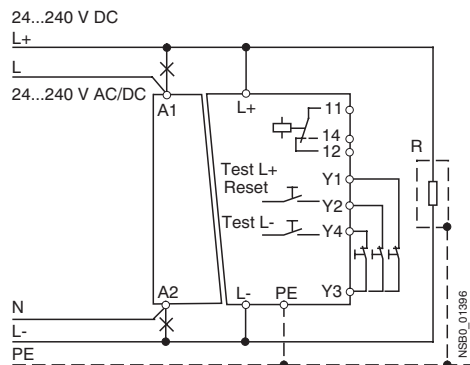

Monitoring Relays

3UG Monitoring Relays for Electrical and Additional Measurements

Level monitoring

Overview



The 3UG35 01 level monitoring relay is used together with the 2- or 3-pole sensors to monitor the levels of conductive liquids.

Function

The principle of operation is based on measuring the electrical resistance of the liquid between two immersion sensors and a reference terminal. If the measured value is lower than the sensitivity set at the front, the output relay changes its switching state. In order to exclude electrolytic phenomena in the liquid, the sensors are supplied with alternating current.

Two-level control: the output relay changes its switching state as soon as the liquid level reaches the maximum sensor, while the minimum sensor is submerged. The relay returns to its original switching state as soon as the minimum sensor no longer has contact with the liquid.

For safe resetting, the supply voltage must be interrupted for at least 0.5 s (T3).

The delay times T1 and T2 of the output relay have not been included in the diagram in order to enhance clarity.

Note:

It is also possible to connect other resistance sensors to the Min and Max terminals in the range 5 ... 100 k Ω , e.g. photoresistors, temperature sensors, encoders based on resistance etc. The monitoring relay can therefore also be used for other applications apart from monitoring the levels of liquids.

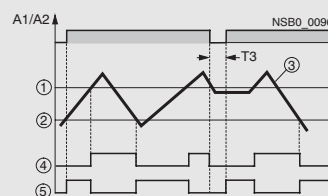

- ① Maximum level ¹⁾
- ② Minimum level ¹⁾
- ③ Monitored level
- ④ Output relay
Function OVER
- ⑤ Output relay
Function UNDER

¹⁾ Determined by the arrangement of the probes in the monitored liquid.

Monitoring Relays

3UG Monitoring Relays for Electrical and Additional Measurements

Level monitoring

Technical specifications

Type	3UG30/3UG35			
Load capacity of the output relay	Rated operational current I_e	A	Max. 8	
	AC-15/24 ... 400 V	A	3	
	DC-13/24 V	A	1	
	DC-13/125 V	A	0.2	
	DC-13/250 V	A	0.1	
Minimum contact load		mA	5 /17 V for a fault of 1 ppm	
Output relay with DIAZED fuse¹⁾	gL/gG operational class	A	4	
Electrical endurance	Operating cycles		1 x 10 ⁵	
Mechanical endurance	Operating cycles		2 x 10 ⁶	
Ambient temperature	During operation	°C	-20 ... + 50	
	During storage	°C	-30 ... + 70	
Conductor connection	Solid	mm ²	2 x (0.5 ... 2.5)	
	Finely stranded, with end sleeves	mm ²	2 x (0.5 ... 1.5)	
Degree of protection	Terminals		IP20	
	Enclosures		IP40	
Vibration resistance	According to IEC 60068-2-6	Hz/mm	10 ... 150/0.035	

¹⁾ Short-circuits without any relay contact welding according to DIN VDE 0660 Part 200.

Rated control supply voltage U_s		V	See Catalog LV 1, Selection data (electrical isolation by means of a transformer)	
Voltage tolerance			0.85 ... 1.1 x U_s	
Maximum power consumption		W/VA	3 / 6	
Function	Inlet or outlet monitoring		UNDER/OVER selector switch at the front	
Sensitivity	Adjustable	kΩ	5 ... 100	
Setting accuracy	At maximum sensitivity	%	±30	
Repeat accuracy	At constant parameters	%	± 0.1	
Sensor length	Max.	m	100	
Electrode voltage	Max.	V	24 (50/60 Hz)	
Electrode current	Max.	mA	1 (50/60 Hz)	
Conductor capacity	Of the sensor cable ¹⁾	nF	10	
Delay time	• T1 at Max/M terminal	ms	Typically 500 (ON-delay with OVER, OFF-delay with UNDER)	
	• T2 at MIN/M terminal	ms	Typically 300 (OFF-delay with OVER, ON-delay with UNDER)	
Mains buffering time		ms	300	

¹⁾ The sensor cable does not necessarily have to be shielded, but it is not recommended to lay this cable parallel to the power supply lines. It is also possible to use a shielded cable, whereby the shield has to be connected to the M terminal.

Level monitoring sensors

Type		3UG32 07-3A three-pole	3UG32 07-2A two-pole	3UG32 07-2B two-pole	3UG32 07-1B single-pole	3UG32 07-1C single-pole	
Length		mm	500	500	--	--	
Insulation	Teflon insulation (PTFE)		Yes	Yes	--	Yes	
Installation			Vertical	Vertical	Lateral	Lateral	
Screw-in gland width A/F			22				
Thread		Inch	R 3/8				
Connection cable		mm ²	3 x 0.5, 2 m long				
Operating temperature		°C	90				
Operating pressure		bar	10				
Assignment	• Cable/Electrode	Cable brown	Center electrode	Not assignable	Gland	Gland	Gland
		Cable white	Not assignable	Not assignable	Not assignable	Electrode	Electrode
		Cable green	Not assignable	--	Not assignable	--	--

Monitoring Relays

3UG Monitoring Relays for Electrical and Additional Measurements

Level monitoring

Dimensional drawings

3UG35 01

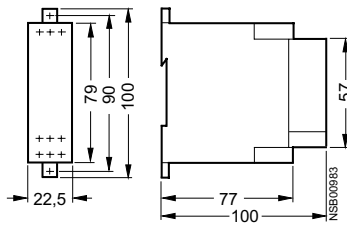

Level monitoring sensors

3UG32 07-3A three-pole wire electrode

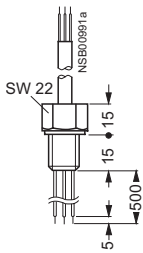

3UG32 07-1B single-pole bow electrode

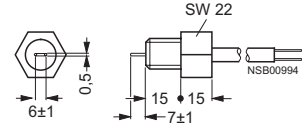

3UG32 07-1C single-pole electrode, rugged version

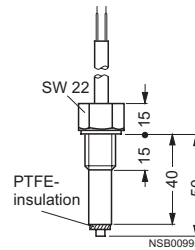

3UG32 07-2A two-pole wire electrode

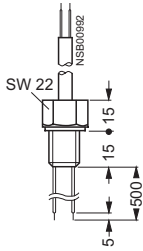

3UG32 07-2B two-pole bow electrode

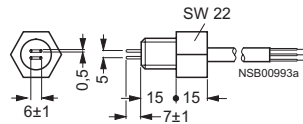

Schematics

3UG35 01

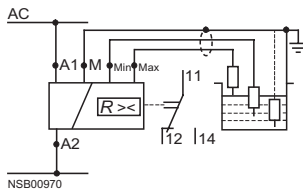

Monitoring Relays

3UG Monitoring Relays for Electrical and Additional Measurements

Speed monitoring

Overview



The 3UG30 51 monitoring relay is used together with a sensor to monitor operating mechanisms for underspeeding.

Function

The underspeed monitoring relay operates according to the principle of retriggerable OFF-delay. During the time (value) set on the front side, another pulse must arrive at input IN1 or IN2 to ensure that the output relay remains picked up. The monitoring relay evaluates the rising edge of the signal, i.e. a continuous signal is also recognized as a missing pulse. If the retrigger pulse does not arrive, indicating a reduction in speed, the output relay drops. In order to be able to start an operating mechanism, the output relay remains picked up during the ON-delay time T , even if the speed is still below the set value (motor starting override time). The first pulse must come within this time.

The monitoring relay can be used for all functions where a continuous pulse signal needs to be monitored (belt travel monitoring, completeness monitoring, passing monitoring, clock-time monitoring).

Speed monitoring without memory (NO MEMORY)

When the speed of the operating mechanism drops below the set value, the output relay drops. It picks up again when the speed is greater than the set value plus the fixed hysteresis.

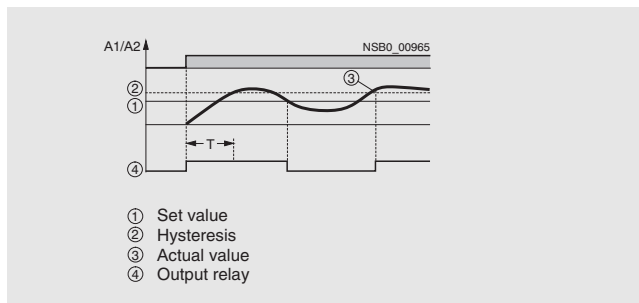

Speed monitoring with memory (MEMORY)

When the output relay drops, this state remains stored even when the speed reaches a permissible value again. The stored state can be ended by a control signal at the reset terminal or by interrupting the supply voltage for at least 200 ms.

