

## MOS FET Relays

### G3VM-2(F)L

### Analog-switching MOS FET Relays with 350-V Load Voltage and Current Limit.

- A 4-pin Relay available with the same terminal-pin position as 4-pin photocouplers.
- Approved standards: UL1577 (File No. E80555)
- Current-limiting model additionally released.

RoHS compliant

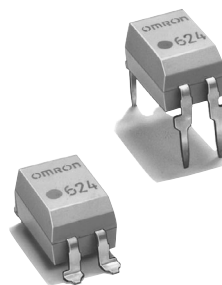

**Note:** The actual product is marked differently from the image shown here.

### Application Examples

- Electronic automatic exchange systems
- Cordless telephones
- Multi-functional telephones
- Measurement devices

### List of Models

Contact form	Terminals	Load voltage (peak value)	Model	Current limit	Number per stick	Number per tape
SPST-NO	PCB terminals	350 VAC	G3VM-2L	Yes	100	---
	Surface-mounting terminals		G3VM-2FL			---
			G3VM-2FL(TR)			1,500

### Dimensions

**Note:** All units are in millimeters unless otherwise indicated.

#### G3VM-2L

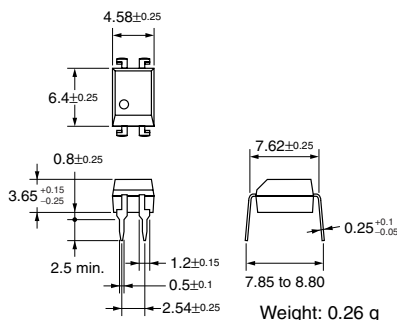

**Note:** The actual product is marked differently from the image shown here.

#### G3VM-2FL

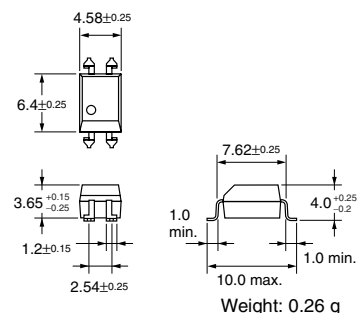

**Note:** The actual product is marked differently from the image shown here.

### Terminal Arrangement/Internal Connections (Top View)

#### G3VM-2L

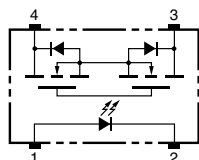

#### G3VM-2FL

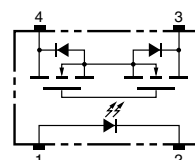

### PCB Dimensions (Bottom View)

#### G3VM-2L

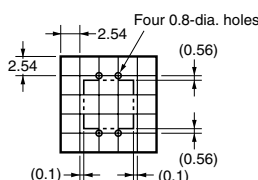

### Actual Mounting Pad Dimensions (Recommended Value, Top View)

#### G3VM-2FL

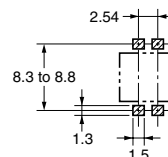

## Absolute Maximum Ratings (Ta = 25°C)

Item	Symbol	Rating	Unit	Measurement Conditions	
Input	LED forward current	$I_F$	50	mA	
	Repetitive peak LED forward current	$I_{FP}$	1	A	
	LED forward current reduction rate	$\Delta I_F/^\circ\text{C}$	-0.5	mA/°C	Ta ≥ 25°C
	LED reverse voltage	$V_R$	6	V	
	Connection temperature	$T_j$	125	°C	
Output	Output dielectric strength	$V_{OFF}$	350	V	
	Continuous load current	$I_O$	120	mA	
	ON current reduction rate	$\Delta I_{ON}/^\circ\text{C}$	-1.2	mA/°C	Ta ≥ 25°C
	Connection temperature	$T_j$	125	°C	
Dielectric strength between input and output (See note 1.)		$V_{I-O}$	2,500	Vrms	AC for 1 min
Operating temperature		$T_a$	-40 to +85	°C	With no icing or condensation
Storage temperature		$T_{stg}$	-55 to +125	°C	With no icing or condensation
Soldering temperature (10 s)		---	260	°C	10 s

**Note:** 1. The dielectric strength between the input and output was checked by applying voltage between all pins as a group on the LED side and all pins as a group on the light-receiving side.

## Electrical Characteristics (Ta = 25°C)

Item	Symbol	Minimum	Typical	Maximum	Unit	Measurement conditions	
Input	LED forward voltage	$V_F$	1.0	1.15	1.3	V	$I_F = 10 \text{ mA}$
	Reverse current	$I_R$	---	---	10	μA	$V_R = 6 \text{ V}$
	Capacity between terminals	$C_T$	---	30	---	pF	$V = 0, f = 1 \text{ MHz}$
	Trigger LED forward current	$I_{FT}$	---	1	3	mA	$I_O = 120 \text{ mA}$
Output	Maximum resistance with output ON	$R_{ON}$	---	22	35	Ω	$I_F = 5 \text{ mA}, I_O = 120 \text{ mA}$
	Current leakage when the relay is open	$I_{LEAK}$	---	---	1.0	μA	$V_{OFF} = 350 \text{ V}$
Limit current	$I_{LIM}$	150	---	300	mA	$I_F = 5 \text{ mA}, V_{DD} = 5 \text{ V}, t = 5 \text{ ms}$	
Capacity between I/O terminals	$C_{I-O}$	---	0.8	---	pF	$f = 1 \text{ MHz}, V_s = 0 \text{ V}$	
Insulation resistance	$R_{I-O}$	1,000	---	---	MΩ	$V_{I-O} = 500 \text{ VDC}, R_{oH} \leq 60\%$	
Turn-ON time	$t_{ON}$	---	---	1.0	ms	$I_F = 5 \text{ mA}, R_L = 200 \Omega, V_{DD} = 20 \text{ V}$ (See note 2.)	
Turn-OFF time	$t_{OFF}$	---	---	1.0	ms		

**Note:** 2. Turn-ON and Turn-OFF Times

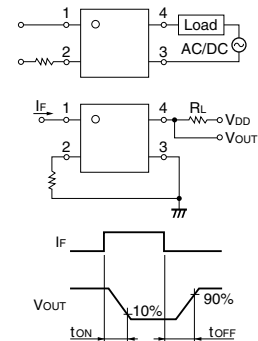

## Recommended Operating Conditions

Use the G3VM under the following conditions so that the Relay will operate properly.

Item	Symbol	Minimum	Typical	Maximum	Unit
Output dielectric strength	$V_{DD}$	---	---	280	V
Operating LED forward current	$I_F$	5	7.5	25	mA
Continuous load current	$I_O$	---	---	100	mA
Operating temperature	$T_a$	-20	---	65	°C

## Engineering Data

### Load Current vs. Ambient Temperature

#### G3VM-2(F)L

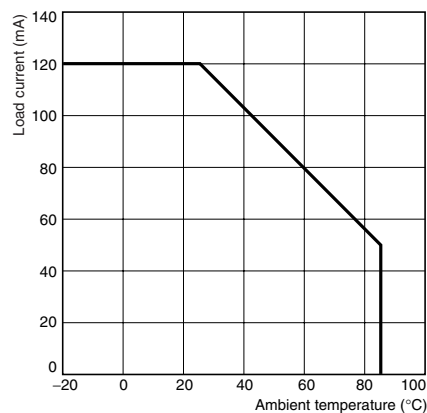

## Safety Precautions

Refer to "Common Precautions" for all G3VM models.

## Common Precautions

### ⚠ WARNING

Be sure to turn OFF the power when wiring the Relay, otherwise an electric shock may be received.

### ⚠ WARNING

Do not touch the charged terminals of the SSR, otherwise an electric shock may be received.

### ⚠ Caution

Do not apply overvoltage or overcurrent to the I/O circuits of the SSR, otherwise the SSR may malfunction or burn.

### ⚠ Caution

Be sure to wire and solder the Relay under the proper soldering conditions, otherwise the Relay in operation may generate excessive heat and the Relay may burn.

## Typical Relay Driving Circuit Examples

### C-MOS

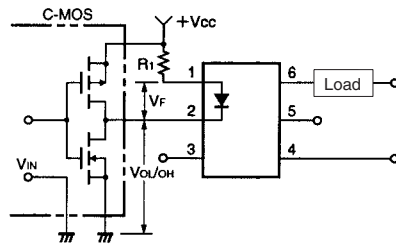

### Transistor

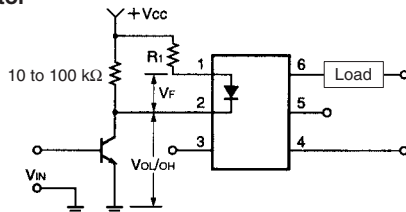

Use the following formula to obtain the LED current limiting resistance value to assure that the relay operates accurately.

$$R_1 = \frac{V_{CC} - V_{OL} - V_F(ON)}{5 \text{ to } 20 \text{ mA}}$$

Use the following formula to obtain the LED forward voltage value to assure that the relay releases accurately.

$$V_{F(OFF)} = V_{CC} - V_{OH} < 0.8 \text{ V}$$

## Protection from Surge Voltage on the Input Terminals

If any reversed surge voltage is imposed on the input terminals, insert a diode in parallel to the input terminals as shown in the following circuit diagram and do not impose a reversed voltage value of 3 V or more.

### Surge Voltage Protection Circuit Example

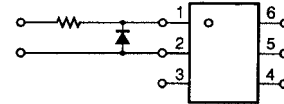

## Protection from Spike Voltage on the Output Terminals

If a spike voltage exceeding the absolute maximum rated value is generated between the output terminals, insert a C-R snubber or clamping diode in parallel to the load as shown in the following circuit diagram to limit the spike voltage.

### Spike Voltage Protection Circuit Example

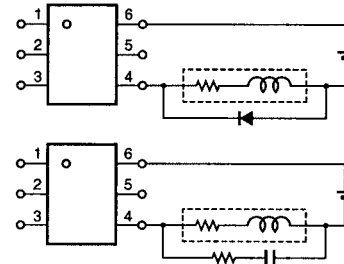

## Unused Terminals (6-pin models only)

Terminal 3 is connected to the internal circuit. Do not connect anything to terminal 3 externally.

## Pin Strength for Automatic Mounting

In order to maintain the characteristics of the relay, the force imposed on any pin of the relay for automatic mounting must not exceed the following.

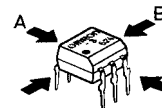

In direction A: 1.96 N

In direction B: 1.96 N

## Load Connection

Do not short-circuit the input and output terminals while the relay is operating or the relay may malfunction.

### AC Connection

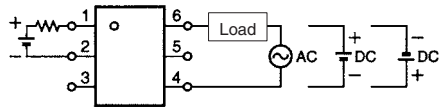

### DC Single Connection

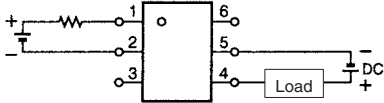
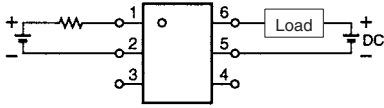

### DC Parallel Connection

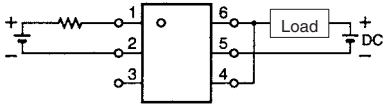

## Solder Mounting

Perform solder mounting under the following recommended conditions to prevent the temperature of the Relays from rising.

### <Flow Soldering>

#### Through-hole Mounting (Once Only)

Solder type	Preheating	Soldering
Lead solder SnPb	150°C 60 to 120 s	230 to 260°C 10 s max.
Lead-free solder SnAgCu	150°C 60 to 120 s	245 to 260°C 10 s max.

**Note:** We recommend that the suitability of solder mounting be verified under actual conditions.

### <Reflow Soldering>

#### Surface Mounting DIP or SOP Packages (Twice Max.)

Solder type	Preheating	Soldering	
Lead solder SnPb	140→160°C 60 to 120 s	210°C 30 s max.	Peak 240°C max.
Lead-free solder SnAgCu	180→190°C 60 to 120 s	230°C 30 to 50 s	Peak 260°C max.

#### Surface Mounting SSOP Packages (Twice Max.)

Solder type	Preheating	Soldering	
Lead solder SnPb	140→160°C 60 to 120 s	210°C 30 s max.	Peak 240°C max.
Lead-free solder SnAgCu	150→180°C 120 s max.	230°C 30 s max.	Peak 250°C max.

- Note:**
1. We recommend that the suitability of solder mounting be verified under actual conditions.
  2. Tape cut SSOPs are packaged without humidity resistance. Use manual soldering to mount them.

### Manual Soldering (Once Only)

Manually solder at 350°C for 3 s or less or at 260°C for 10 s or less.

## SSOP Handling Precautions

### <Humidity-resistant Packaging>

Component packages can crack if surface-mounted components that have absorbed moisture are subjected to thermal stress when mounting. To prevent this, observe the following precautions.

1. Unopened components can be stored in the packaging at 5 to 30°C and a humidity of 90% max., but they should be used within 12 months.
2. After the packaging has been opened, components can be stored at 5 to 30°C and a humidity of 60% max., but they should be mounted within 168 hours.
3. If, after opening the packaging, the humidity indicator turns pink to the 30% mark or the expiration data is exceeded, bake the components while they are still on the taping reel, and use them within 72 hours. Do not bake the same components more than once.
 

Baking conditions: 60±5°C, 64 to 72 h

Expiration date: 12 months from the seal date (given on the label)
4. If the same components are baked repeatedly, the tape detachment strength will change, causing problems when mounting. When mounting using dehumidifying measures, always take countermeasures against component damage from static electricity.
5. Do not throw or drop components. If the laminated packaging material is damaged, airtightness will be lost.
6. Tape cut SSOPs are packaged without humidity resistance. Use manual soldering to mount them.