

Solid State Relays SOLITRON MIDI Modbus Communication Interface Type RJ1P MB



- AC semiconductor contactor
- MODBUS RTU interface over RS485
- RJ45 sockets for easy installation
- Dual sockets for daisy chaining
- Multi-function – 4 selectable modes of operation: ON/OFF, Phase angle, Distributed full cycle, Burst firing
- Operational ratings up to 50 AACrms and 230 VAC
- Temperature monitoring with over-temperature protection
- Opto isolation: > 4000 VACrms
- LED status indication

Product Description

The RJ1P MB series is a solid state relay equipped with a fieldbus communication interface.

The relay operates under control of a microcontroller that handles communication, monitors operational parameters and controls the SSR thyristor firing. The RJ1P MB supports

the Modbus RTU communication protocol, operating over an RS485 interface.

The communication interface allows modification and reading of several parameters very quickly through a single connection. Diagnostic information is easily accessible for troubleshooting and repair.

Ordering Key **RJ 1 P 23 MBT 50 E BC**

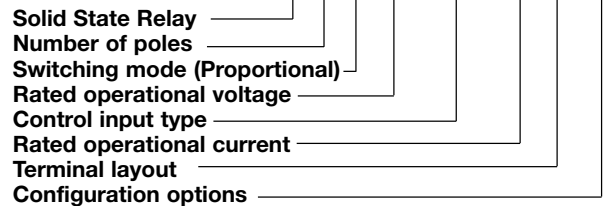

Type Selection

Switching mode	Rated operational voltage	Control input	Rated operational current	Terminal layout	Options
P: Proportional Output	23: 230VACrms	MBT: 2-wire Modbus RTU	50: 50AACrms	E: Contactor layout	BC: Basic Controller CS: Current Sensing CV: Current & Voltage Sensing

Selection Guide

Rated operational voltage	Blocking voltage	Supply voltage	Control input	Rated operational current (50 A)
230VACrms	650Vp	24VDC	RS485 interface (2-wire)	RJ1P23MBT50EBC RJ1P23MBT50ECS RJ1P23MBT50ECV

General Specifications

Operational voltage range	90 - 265 VAC	Output power resolution	
Blocking voltage	650 V _p	Mode 0 ON/ OFF	1/1
Power factor	>0,9 @ 230VAC _{RMS}	Mode 1 Phase angle	1/256
Operational frequency range	45-65 Hz	Mode 2 Full cycle	1/256
Output indication	Green LED (dual intensity)	Mode 3 Burst firing	1/32 – 1/256 depending on time-base setting
Alarm indication	Red LED	Pollution degree	2
Data indication	Orange LED, flashing	Installation category	III
SSR fault detection	Yes	Approvals	UL, cUL
Over temperature protection	Yes	CE-marking	Yes
Output power	0 – 99.6%		

Thermal Specifications

Operating temperature	-30 to +70°C (-22 to +158 °F)
Storage temperature	-40 to +100°C (-40 to +212 °F)

Isolation

Rated isolation voltage	
Input to output	≥ 4000 VACrms
Output to case	≥ 4000 VACrms

Housing Specifications

Weight	Approx. 415 g
Housing material	PBT
Control terminal cable size	
Min	1 x 0.5 mm ² (1 x AWG20)
Max	1 x 4.0 mm ² (1 x AWG12) or 2 x 2.5 mm ² (2 x AWG14)
Mounting torque max.	1 Nm Posidriv 0 bit
Control terminal screw	M3
Power terminal cable size	
Min	1 x 4 mm ² (1 x AWG12)
Max	1 x 25 mm ² (1 x AWG3) or 2 x 10 mm ² (2 x AWG6)
Mounting torque max.	2.4 Nm Posidriv 2 bit
Power terminal screw	M5
Data Connection	Shielded RJ45

Data Specification

Interface	RS485
Bus Loading	1/8 unit load
Communication protocol	Modbus RTU
Data line ESD voltage withstand	15KV HBM
Parity	Selectable - None, Odd, Even
Data Rate	9600, 19200, 38400, 57600, 115200 baud
Devices on Bus	247
Address configuration	DIP-SWITCH

Dimensions

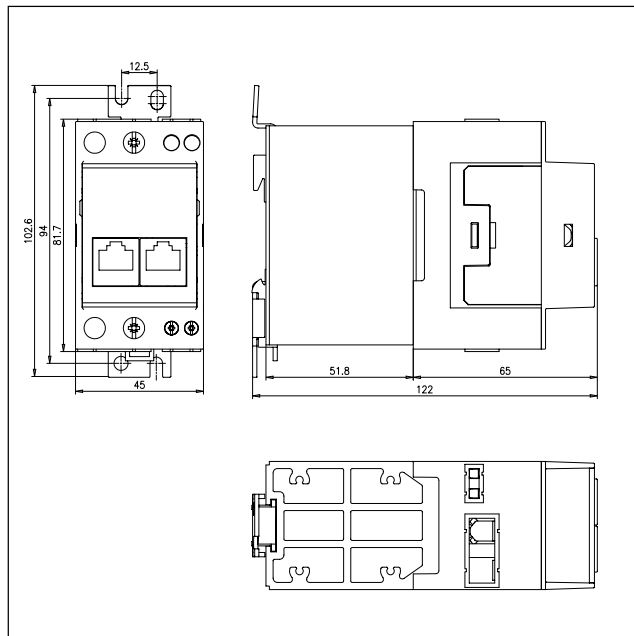

All dimensions in mm

Output Specifications

Rated operational current AC51 @Ta=25°C	50AACrms
Min. operational current	500mAACrms
Rep. overload current t=1 s (Tj init.=25°C)	< 200AACrms
Non-rep. surge current t=10 ms (Tj init.=25°C)	1900A _p
Off-state leakage current, @ rated voltage and frequency	< 3 mA _{rms}
i ² t for fusing t=10 ms	18000A ² s
Max. On-state voltage drop @ rated current	1.6V _{rms}
Critical dV/dt off-state	1000V/μs

Supply Specifications

Supply voltage range (according to EN 61131-2)	19.2 - 30 VDC
Supply current @ 19.2 VDC @ 30 VDC	13mA 10mA
Supply status indication	Green LED, half intensity

Terminal Layout

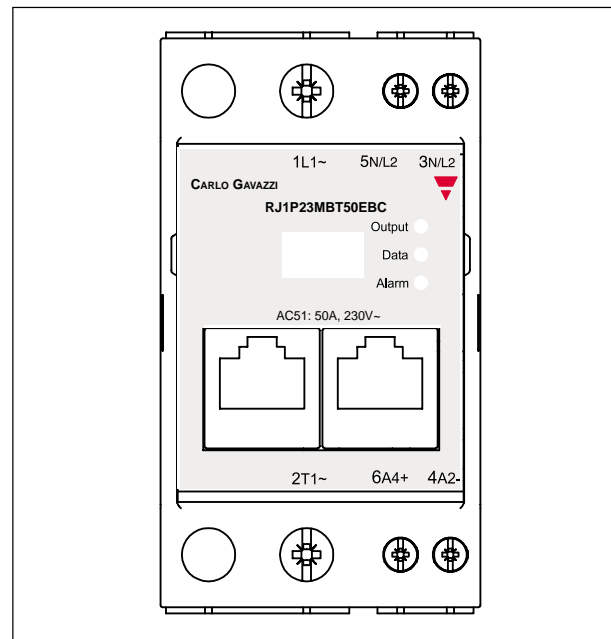

Note: Terminals 5N/L2 and 3N/L2 are available only on RJ1P23MBT50ECV

Functional Diagram

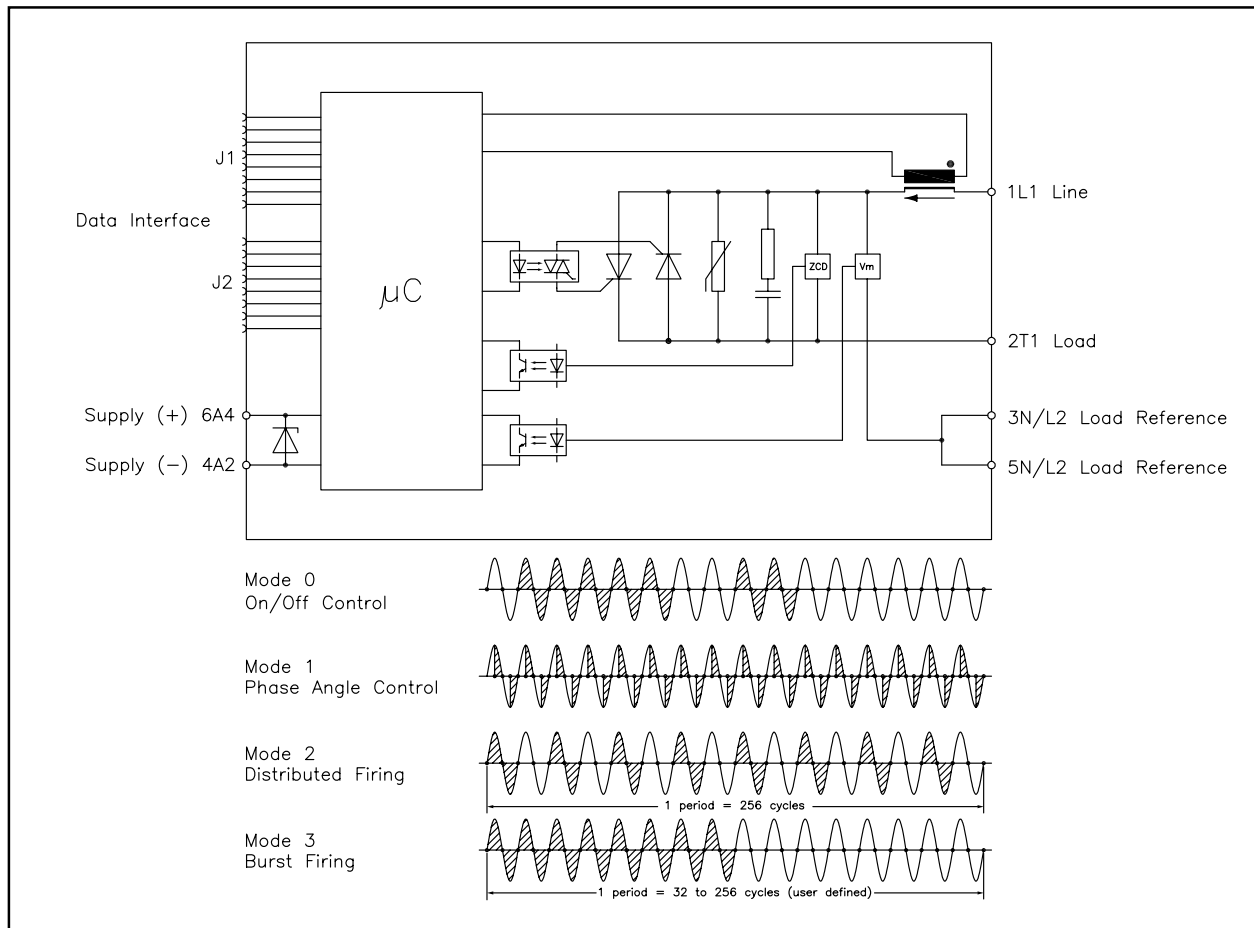

Alarms and Features

BC - Basic Controller

- **Internal temperature measurement from -32 to +128°C**
- **Power control by:**

On/Off	Mode 0
Phase angle	Mode 1
Distributed firing	Mode 2
Burst firing	Mode 3
- **Fault detection:** Over temperature, SSR fault (shorted, 1/2 wave conduction, open circuit), Phase Loss, Full Load Loss

CS - Adds Current Sensing capability

Same features as RJ1P23MBT50EBC with additional:

- **Current monitoring**

CV - Adds Current and Voltage sensing capability

Same features as RJ1P23MBT50ECS with additional:

- **Voltage monitoring**
- **Power measurement**

LED indication

The Green LED (Output) is a dual purpose indicator. When 24V power is applied the Green LED is dimly lit. When the output thyristors are activated, the Green LED is lit up more brightly in tandem with application of power to the load.

The Yellow LED (Data) shows communication activity. It lights up for the period of time that the relay is involved in communication over the RS485 bus. This applies for both transmission and reception.

The Red LED (Alarm) lights up

when there are communication errors or when the relay is operating abnormally. In the case of communication errors, the Alarm LED is reset by the next valid communication sequence. When there is abnormal operation the Alarm LED resets when the operating con-

ditions revert back to normal. All three LEDs flashing continuously indicate that the device is in configuration mode (Modbus address set to unsupported value). Details shown in product manual.

Derating Curve

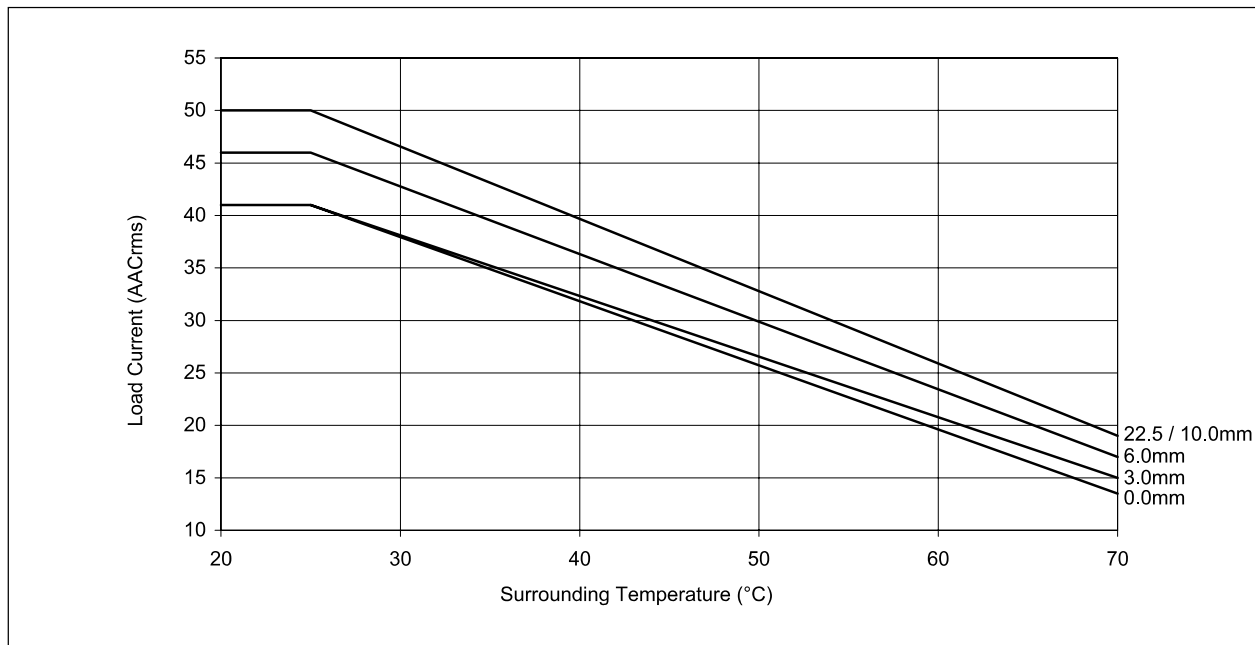

Dissipation Curve

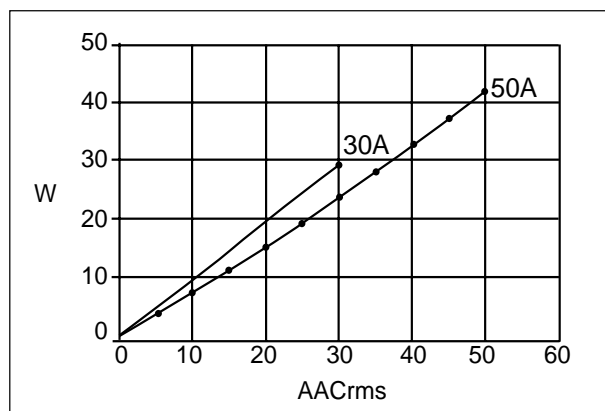

Connection Examples

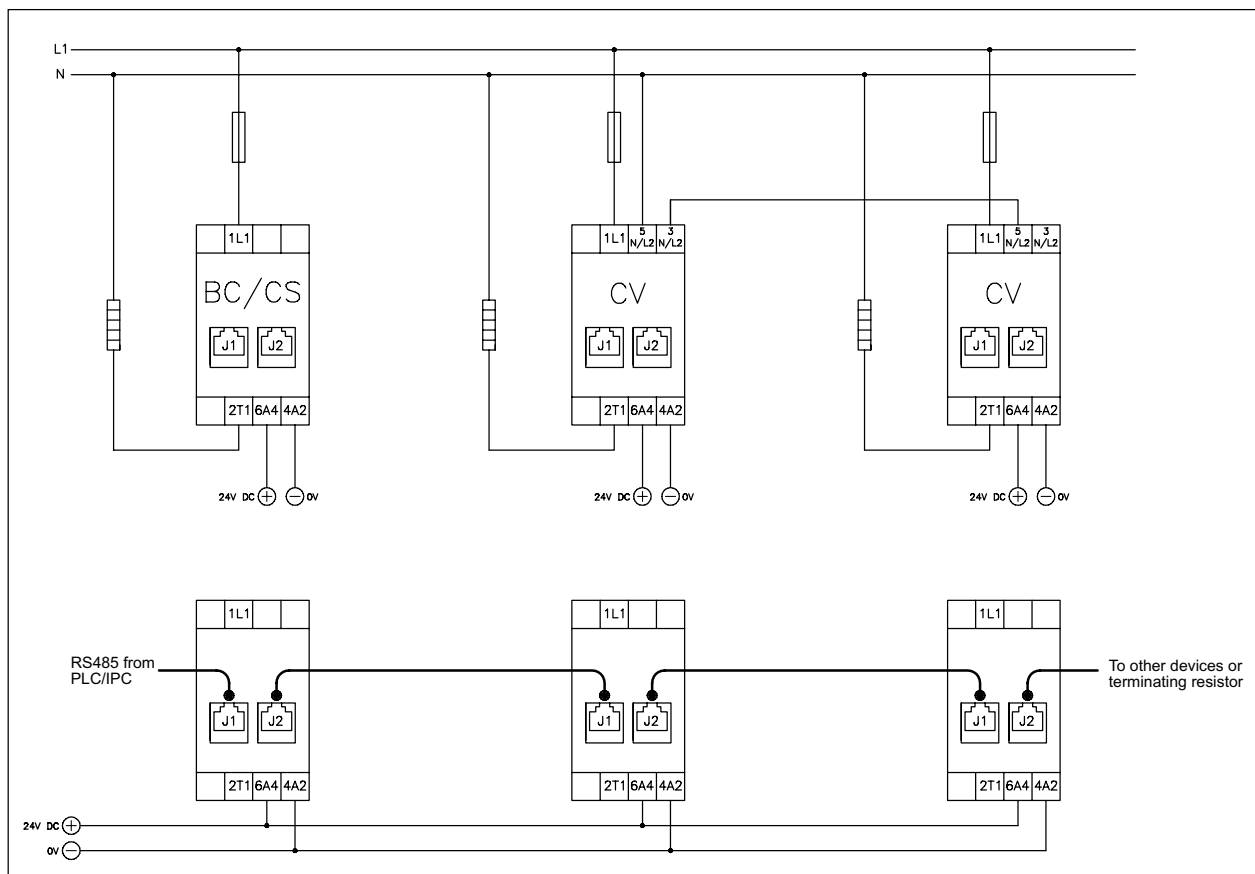

Notes:

1. A terminating resistor (value 100 Ω to 130 Ω) must be fitted at each end of the RS485 network.
2. 24V power may be applied through terminals 6A4, 4A2 or through the RJ-45 connector. If daisy chaining several devices using standard ethernet patch leads, the connection to 6A4, 4A2 is optional for the second and successive devices. For large networks it is necessary to connect 6A4, 4A2 every 25th device.
3. Max. no of daisy chained devices may be limited by patch-lead conductor diameter and length.
4. Refer to product handbook for detailed installation instructions.

Operation

Mode 0 – ON/OFF control

In Mode 0 the relay operates as a standard ON/OFF relay with zero switching. In this mode the relay can deliver either 0% or 100% power. This mode is ideal for systems where the process controller employs a digital process variable, similar to that used in standard solid state relay applications.

Mode 1 – Phase angle control

In Mode 1 the load power is adjusted by delaying the thyristor switching signal according to the required power. The resulting output is a chopped sine-wave. The relay switches itself off every half cycle. Timings are calculated such that a linear power response curve is obtained. This mode is suited for loads where continuous control of power is required.

Mode 2 – Distributed firing

In Mode 2 full cycles are switched ON/OFF over a period of 256 mains cycles. The number of cycles that are switched ON corresponds to the value specified in the load power register. This mode uses an algorithm that distributes the ON cycles evenly over the 256 cycle period.

Mode 3 – Burst firing

In Mode 3 full cycles are switched ON/OFF over a period of mains cycles as defined by the Time-Base Register. Mode 3 uses an algorithm that will switch ON a number of cycles in a continuous burst for a time period corresponding to the required power.