

Solid State Relays SOLITRON MIDI Current Sensing Type RJCS, RJCSR



- AC semiconductor contactor
- Integrated current monitoring
- Zero switching
- Direct copper bonding (DCB) technology
- LED-indication
- Cage clamp output terminals
- 4-32 VDC control input
- Operational ratings up to 50 AACrms and 600 VAC
- Local and remote alarm status
- Set-point adjustable
- Time delay adjustable
- Local and remote setup

Product Description

The SOLITRON Midi Current Sensing is a compact, single-phase SSR that is sensitive to variations in load conditions in industrial heating applications. This microprocessor-based device is ideal for detection of partial load failure and to ensure the highest process quality. Current sensing is integrated inside to eliminate the need to install an external current transformer. A membrane "button" on the front is used to effect a simple "teach in" of the current setpoint. Alarm delay time is set by a potentiometer. A drop in setpoint current of more than 13% will trigger an

open collector alarm. Up to 50 alarm outputs can be connected in parallel to a standard PLC input. Typical conditions that can be detected are heater break or open-circuit, blown fuse, semiconductor short-circuit and faulty power connection. Device over-temperature protection is integrated as a standard feature. The product is ready to mount on DIN-rail or chassis and comes with integral heatsink. The standard housing dimensions enable straightforward replacement of alternative products.

Ordering Key **RJCSR1A60D50EPNO**

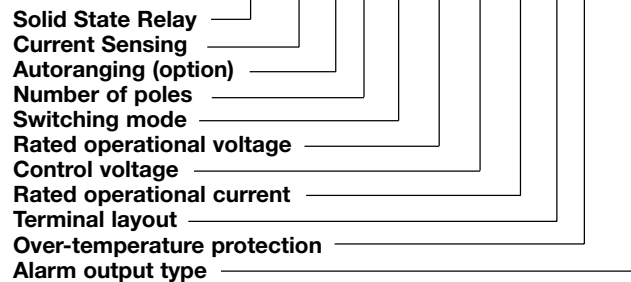

Type Selection

Options	Switching mode	Rated operational voltage	Control voltage	Rated operational current	Terminal layout	Protection	Alarm output type
R: Autoranging	A: Zero switching	23: 230 VACrms 60: 600 VACrms	D: 4-32 VDC	30: 30 AACrms 50: 50 AACrms	E: Contactor	P: Over-temp. protection	NO: NPN, Normally open PO: PNP, Normally open

Selection Guide

Options	Rated operational voltage	Blocking voltage	Control voltage	Supply voltage	Alarm output type	Rated operational current 30 A	Rated operational current 50A
-	230 VACrms	650 Vp	4 - 32 VDC	24 VDC	NPN, NO PNP, NO	-	RJCS1A23D50EPNO RJCS1A23D50EPPO
-	600 VACrms	1200 Vp	4 - 32 VDC	24 VDC	NPN, NO PNP NO	-	RJCS1A60D50EPNO RJCS1A60D50EPPO
Auto-ranging	230 VACrms	650 Vp	4 - 32 VDC	24 VDC	NPN, NO PNP, NO	RJCSR1A23D30EPNO RJCSR1A23D30EPPO	RJCSR1A23D50EPNO RJCSR1A23D50EPPO
-	600 VACrms	1200 Vp	4 - 32 VDC	24 VDC	NPN, NO PNP NO	RJCSR1A60D30EPNO RJCSR1A60D30EPPO	RJCSR1A60D50EPNO RJCSR1A60D50EPPO

General Specifications

	RJCS.1.23..	RJCS.1.60..
Operational voltage range	24 to 265 VAC	42 to 660 VAC
Blocking voltage	650 V _p	1200 V _p
Operational frequency range	45 to 65 Hz	45 to 65 Hz
Power factor	≥ 0.5 @ 230 VACrms	≥ 0.5 @ 600 VACrms
Approvals	UL, cUL	
CE-marking	Yes	
Supply status indication	Green LED, half intensity	
Control status indication	Green LED	
Over-temperature alarm trip indication	Red LED, intermittent	
Alarm indication (except for over-temperature trip)	Red LED	

Input Specifications

Control voltage range	4 - 32 VDC
Pick-up voltage	3.8 VDC
Reverse voltage A1-A4, A2-A4	32 VDC
Drop-out voltage	1.2 VDC
Maximum control input current	1.5 mA
Response time pick-up	≤ 1/2 cycle
Response time drop-out	≤ 1/2 cycle

Supply Specifications

Power supply voltage, V _{cc}	24 VDC ± 15%
Max. supply current	22 mA (per device)
Max. PLC current @ 24VDC during normal conditions	275 μA (per device)

Alarm Specifications

Output current, i _o	≤50 mADC
Output voltage	
NPN	1 + 0.15i _o
PNP	V _{cc} - 1 - 0.15i _o
No. of outputs in parallel	≤50

Dissipation Curve

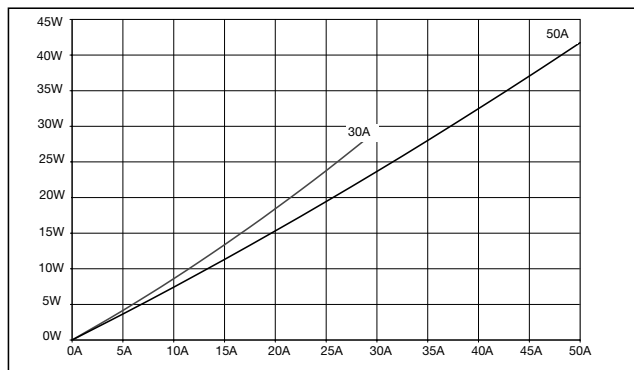

Housing Specifications

Weight	Approx. 450 g
Housing material	PBT Flame retardant
Control terminal cable size	
Min	1 x 0.5 mm ² (1 x AWG20)
Max	1 x 4.0 mm ² (1 x AWG12) or 2 x 2.5 mm ² (2 x AWG14)
Mounting torque max.	0.6 Nm Posidriv 0 bit
Control terminal screws	M3
Power terminal cable size	
Min	1 x 4 mm ² (1 x AWG12)
Max	1 x 25 mm ² (1 x AWG3) or 2 x 10 mm ² (2 x AWG6)
Mounting torque max.	2.5 Nm Posidriv 2 bit
Power terminal screws	M5

Thermal Specifications

Operating temperature	-20 to +70°C (-4 to +158 °F)
Storage temperature	-40 to +100°C (-40 to +212 °F)

Isolation

Rated isolation voltage	
Input to output	≥ 4000 VACrms
Output to case	≥ 4000 VACrms

Output Specifications

		RJCS.1...30	RJCS.1...50
Rated operational current AC51 @Ta=25°C		30 AACrms	50 AACrms
Measuring range	RJCS1A... RJCSR1A...	- 0.3 - 30 AACrms	8 - 50 ACrms 0.5 - 50 AACrms
Min. TEACH current	RJCS1A... RJCSR1A...	- 0.3 AACrms	8 AACrms 0.5 AACrms
Min. partial load current	RJCS1A... RJCSR1A...	- 0.05 AACrms	1.3 AACrms 0.083 AACrms
Non rep. surge current (t=10ms)		600 Ap	1900 Ap
Off-state leakage current @rated voltage and frequency		< 5 mArms	< 5 mArms
I ² t for fusing (t = 10 ms)		1800 A ² s	18000 A ² s
On-state voltage drop @ rated current		1.6 Vrms	1.6 Vrms
Critical dV/dt off-state		1000 V/μs	1000 V/μs

Connection Examples

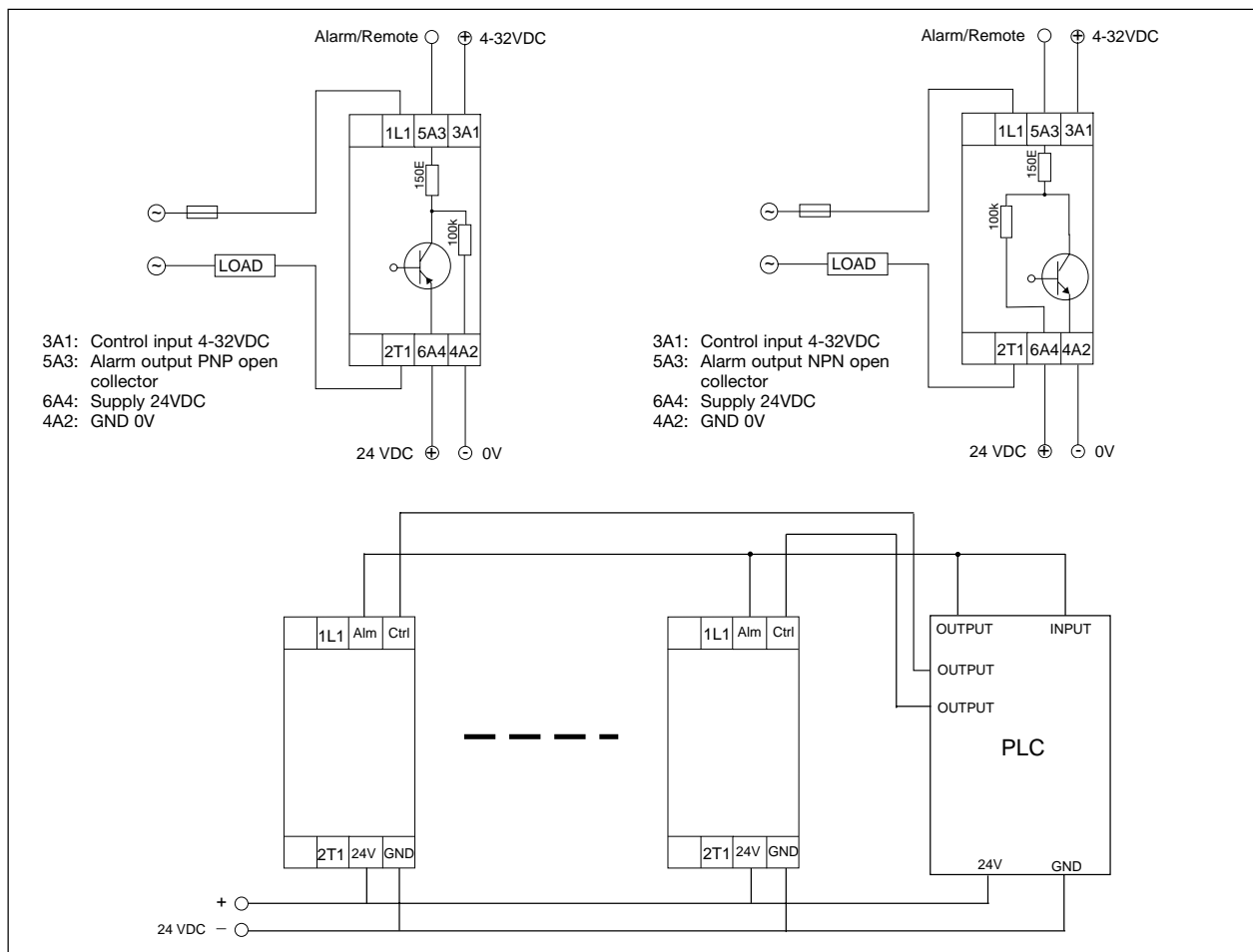

Notes:

1. Control input (terminal A1) and 24VDC supply (terminal A3) must have common ground
2. RJCSc ... and PLC should be sourced from the same 24VDC supply
3. RJCSc ... PO and RJCSc ...NO should not be connected to the same alarm line
4. It is recommended that up to 6 identical loads are connected in parallel

Alarm Operation

1.1 Current Setpoint

The current setpoint is the nominal operating current that is expected when all the heater loads are functioning properly. If the heater loads are faulty or the supply voltage is not close to the nominal level, the wrong setpoint will be stored.

1.2 Initialisation

When the device is shipped, no setpoint is stored in the flash memory. Both green and red LEDs will flash intermittently to indicate that a setpoint must be stored using the **TEACH** procedure. The load will not go on when the control is applied so long as a **TEACH** command is successful.

1.3 Local Functions

Local functions can be activated by using the push button on the front of the device. While an alarm is being issued by any SSR connected to the common alarm line or a remote command is being issued, no local commands are accepted.

1.3.1 Local TEACH

Press and hold the push button for approximately 3 seconds. The red LED will flash after each second. After the LED flashes 3 times, release the button. If the "teach" command has been accepted the heater loads are automatically switched ON. The red LED will flash quickly 10 times. When the current setpoint has been stored successfully, the red and green LEDs will scroll intermittently to indicate that the **TEACH** procedure has been completed. The load will now be switched on or off according to the control input's status. It is very important to hold the button down for only 3 flashes of the red LED to make a successful **TEACH**. If the **TEACH** procedure is not successful, the device will automatically reset to factory default (i.e. no setpoint stored).

1.3.2 Local RESET

When an alarm has occurred the device can be locally **RESET** by pressing the push button for 1 second. The red LED will flash once. This will reset the alarm. If the alarm condition has been cleared

the device will return to normal operation. If the alarm condition is still active, the device will automatically go back to alarm status.

1.3.3 Local TEST

In the absence of a signal on the "control input" terminal, a local **TEST** can be made by pressing and holding the button for 5 seconds. After the red LED flashes 5 times, release the button. The device will switch ON the loads for 1 second. This test detects if there is an under-current or heater break alarm condition.

1.4 Remote Setup Procedure

Remote functions can be activated with a PLC or any other logic controller by applying timed pulses to the alarm terminal: >10V for RJCS...PO and <10V for RJCS...NO.

1.4.1 Remote TEACH

Apply a 3 second pulse. The red LED will flash after each second. After the LED flashes 3 times and the "teach" command has been accepted, the heater loads (of all SSRs connected to the same alarm line) are automatically switched ON and the red LED will flash quickly 10 times. When the current setpoint has been stored successfully, the red and green LEDs will scroll intermittently to indicate that the **TEACH** procedure has been completed. The load will now be switched on or off according to the control input's status

1.4.2 Remote RESET/UNBLOCK

When an alarm has occurred the device can be remotely **RESET** by applying a 1 second pulse. A 1 second pulse will also unblock local **TEACH** of all SSRs connected to the similar alarm line. The red LED will flash once. This will reset the alarm. If the alarm condition has been cleared the device will return to normal operation. In RJCS only, if the alarm condition is still active, the device will automatically go back to alarm status.

1.4.3 Remote BLOCK

Applying a 5 second pulse will induce the device to

block local **TEACH**. After this, no local **TEACH** commands are accepted. To unblock this situation, a remote **RESET** must be issued. In the case of the RJCS, if 24V supply is removed, local **TEACH BLOCK** is lost. Another **REMOTE BLOCK** should be issued.

2 Alarms

2.1 Alarm DELAY

A potentiometer on the front of the device allows a time delay on the heater break alarm between 2s and 40s for the RJCS1A... and between 0 and 40s for the RJCSR1A...

For heaters having a low cold resistance, the time for the inrush current to decay to a value less than 13% of the current setpoint, must be added to the potentiometer alarm delay setting plus a further 20ms.

For an alarm signal to occur, the alarm condition must persist throughout this time period. The alarm output is enabled only after this time delay has passed. However, if the control input is disabled for a period of time equal to four times the delay setting, the internal alarm delay timer is reset automatically. (see example)

2.2 Relay remains OFF due to Line Voltage Loss or Thyristor Open Circuit Failure. (85ms for RJCSR and 500ms for RJCS)

The device generates one pulse with duration of 7 seconds on the alarm terminal. This alarm is non-latching. The red LED remains ON after this alarm condition until a **RESET** is issued.

2.3 Heater Break.

A **Heater Break** alarm is given if the current measured through the device is 13% less than the current setpoint stored in the flash memory for a period of time greater or equal to the alarm delay potentiometer setting. The device generates one pulse with duration of 8 seconds on the alarm terminal. The alarm signal is non-latching. The red LED remains ON after this alarm condition until a **RESET** is made. If the measured cur-

rent changes to within 10% of the Current Setpoint, before the **Alarm DELAY** time has elapsed, the **Alarm DELAY** timer is reset.

2.4 Over-temperature or Over-current.

This alarm occurs if any one of following two conditions is true:

1. The device detects an internal over-temperature condition at any time during operation and switches off the output. The red LED flashes intermittently.
2. A current above the nominal device rating is measured during current setpoint **TEACH**. This action erases the current setpoint from flash memory and both red and green LEDs will flash intermittently until a **TEACH** procedure with an acceptable current is carried out.

In both cases, the device generates one pulse with duration of 9 seconds on the alarm terminal. The alarm signal is non-latching.

2.5 Thyristor Short Circuit. (110ms for RJCSR and 90ms for RJCS)

The device generates one pulse with duration of 10 seconds on the alarm terminal. The alarm signal is non-latching.

The red LED remains ON after this alarm condition until a **RESET** is made.

2.6 Alarms Connected in Parallel to one PLC Input and one PLC Output.

For **REMOTE** operation, up to 50 devices can be connected in parallel to at least one PLC input. This PLC input must also be connected in parallel to the PLC output. The PLC input must be programmed to detect alarms while the PLC output must be programmed to supply the pulses required for **REMOTE Setup**. When more than one device is present, pulses from the PLC output or alarm pulses from any device will cause the red LEDs on all devices in parallel to flash intermittently for a max. of 6.25 seconds. After this time, it is only devices with an alarm condition that will have their red LED on.

Specifications are subject to change without notice (05.07.2007)

Example

Let the alarm delay setting be 2s (min). If the full load current is set at 30A, then there will be an alarm condition if the current is under 26.1A for more

than 2s. (Any fluctuation in the load current that is present for <2s will not be signalled – this is intended to eliminate false alarms due to

short duration under-voltage conditions on the supply phase). If the control input goes off within the 2s, the alarm timer will not be reset

provided the control input goes on again within 8s (4x2s).

Alarm Operation

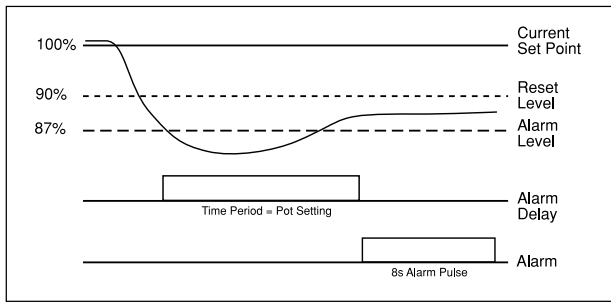

Alarm Condition

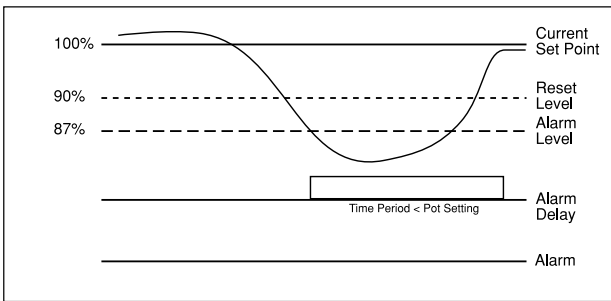

Reset Condition

Dimensions

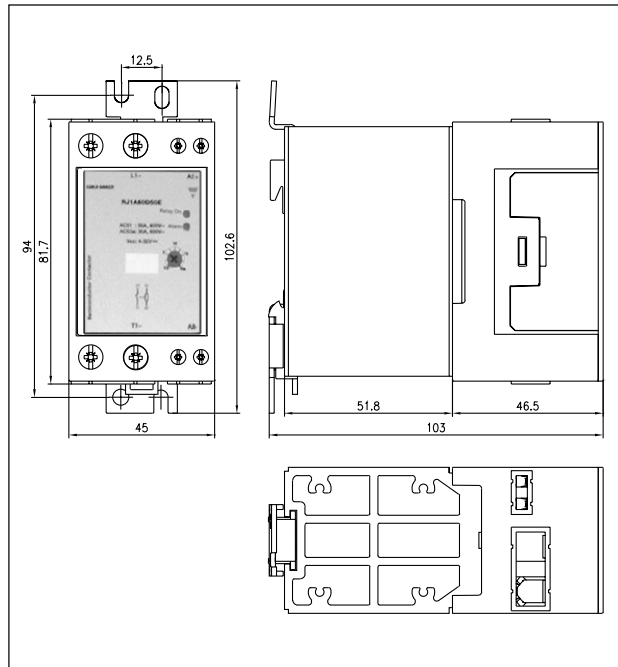

All dimensions in mm.

Panel Mounting

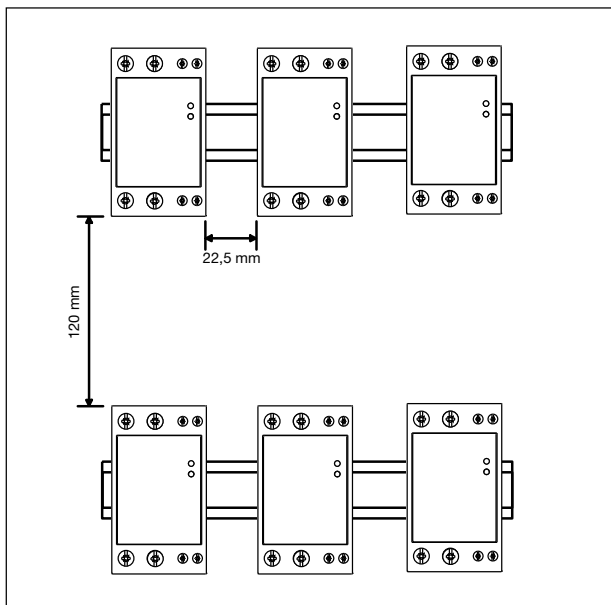

The dimensions shown are valid for nominal ratings.

Derating vs. Spacing Curves

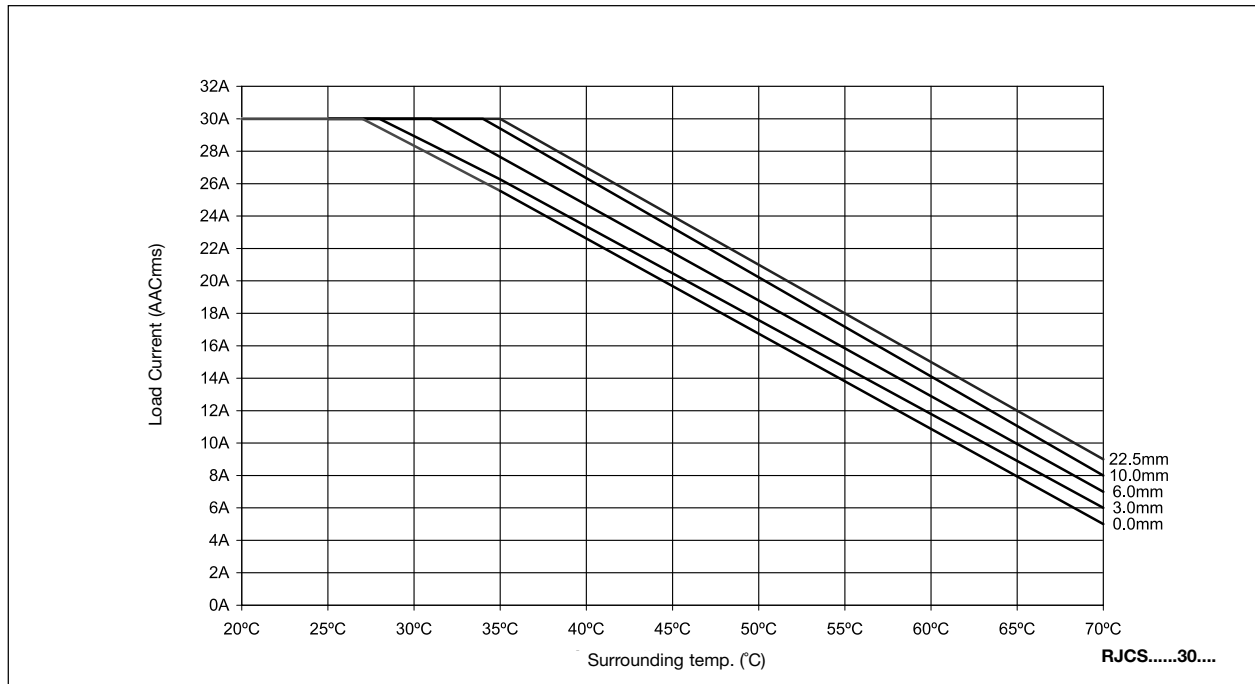

Note: Based on 100% duty cycle

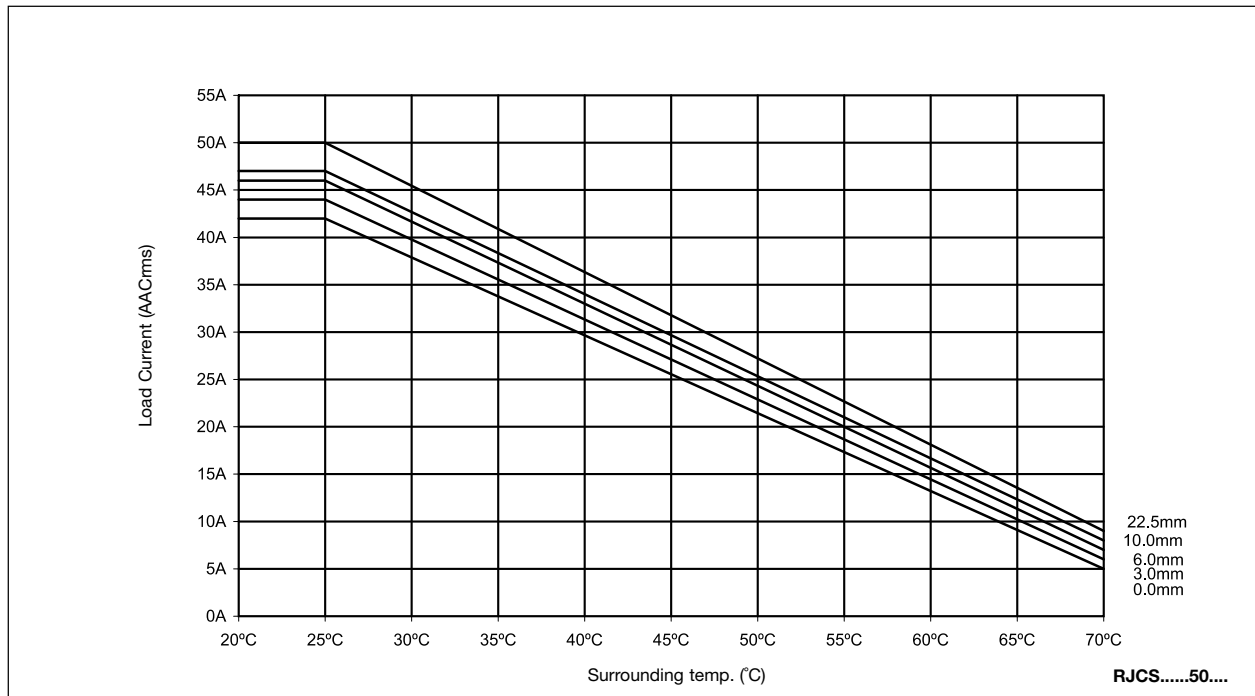

Note: Based on 100% duty cycle

Setup and Alarms

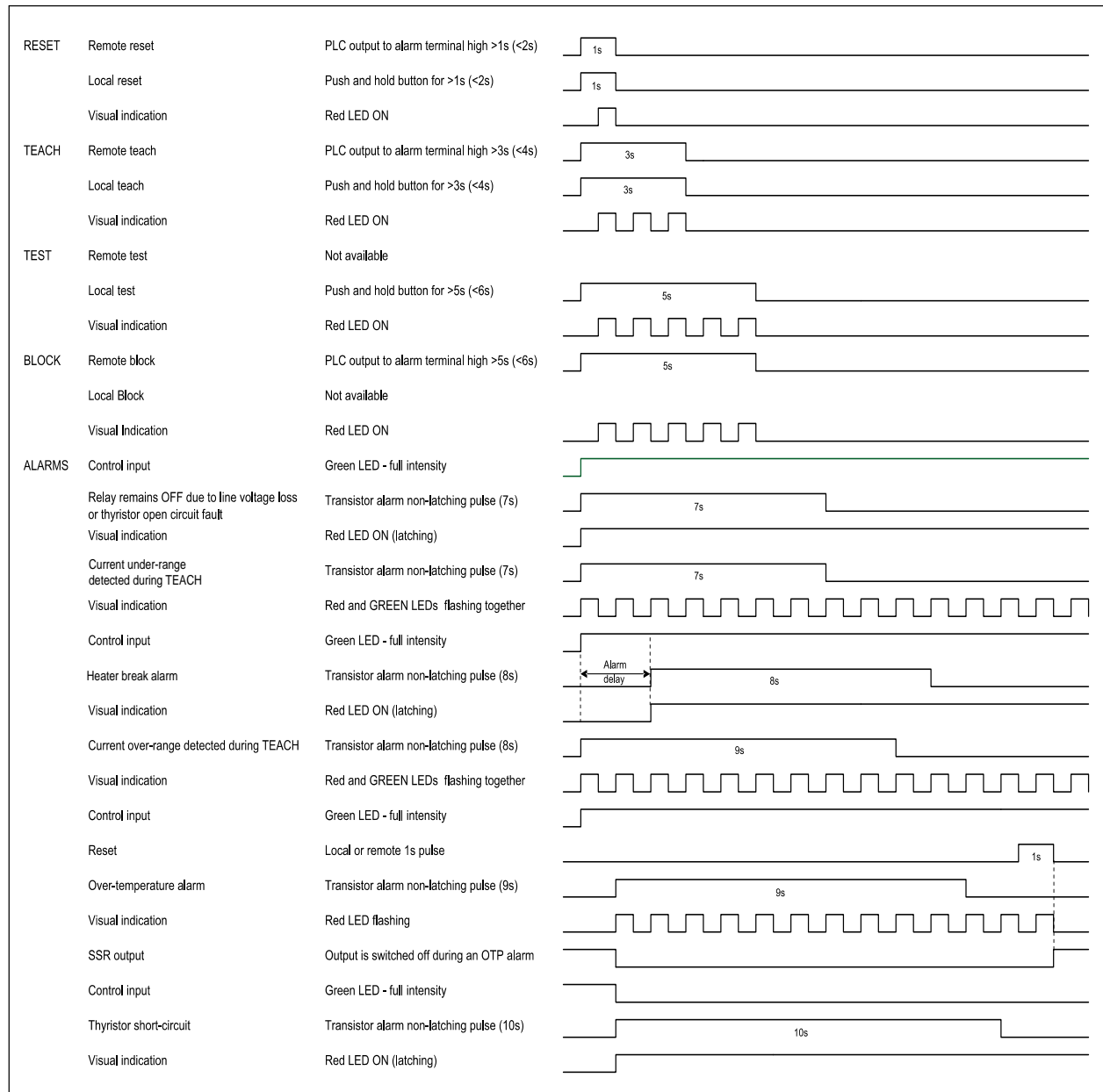

Note: Above shows pulses for PNP device