



GUARDIAN Electric Manufacturing

ISO 9001 / AS9100 Certified Company

Woodstock, IL 60098 Ph. (815)334-3600 Fax (815)337-0377

Or visit us at our website www.guardian-electric.com

Model T4 x 16

DC Tubular Solenoid

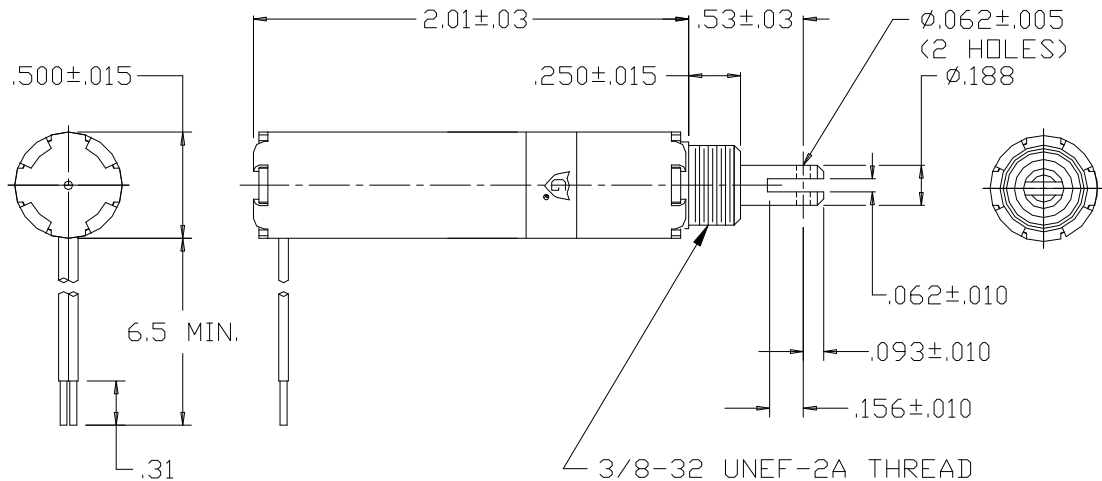

Solenoid shown energized and fully seated.

Supplied with mounting bracket, hex nut and lockwasher (not shown).

Spring kits are available (consult factory).

Total Weight: 1.35 oz.

Plunger Weight: .36 oz.

Model No.	Part No.	Duty Cycle	Voltage	Resistance (Ω)	Power (W)	Current (mA)
T4x16-I-12	A420-066020-00	Intermittent	12VDC	17.7	8.5	678
T4x16-C-12	A420-066019-00	Continuous	12VDC	45.1	3.4	266
T4x16-I-24	A420-066022-00	Intermittent	24VDC	72.7	8.3	330
T4x16-C-24	A420-066021-00	Continuous	24VDC	173	3.5	139

When ordering, please refer to Part No., as listed above.

Consult factory for custom configurations.

Stroke (in.)	Pull Force (oz.)								Holding Force (oz.)
	0.050	0.125	0.250	0.375	0.500	0.625	0.750	1.000	
Continuous Duty	5	3	1	N/A	N/A	N/A	N/A	N/A	23
Intermittent Duty	8	4	2	N/A	N/A	N/A	N/A	N/A	28

UL Recognition

Recognized under the  Component Recognition Program of **Underwriters Laboratories, Inc.**

Continuous Duty

100% 'On' Time

Intermittent Duty

25% 'On' Time, (100 Seconds 'On' Max. Followed By 300 Seconds 'Off' Min.)

RoHS

These parts comply with **RoHS** Directive 2002/95/EC