

DIN 48 x 48-mm Multifunctional Timer Series

- Conforms to EN61812-1 and EN60664-1 (VDE0110) 4 kV/2.
- Conforms to EMC standards (EN50081-2 and EN50082-2).
- Approved by UL and CSA.
- Lloyds/NK approvals.
- Six-language instruction manual provided.

■ Broad Line-up of H3CR Series

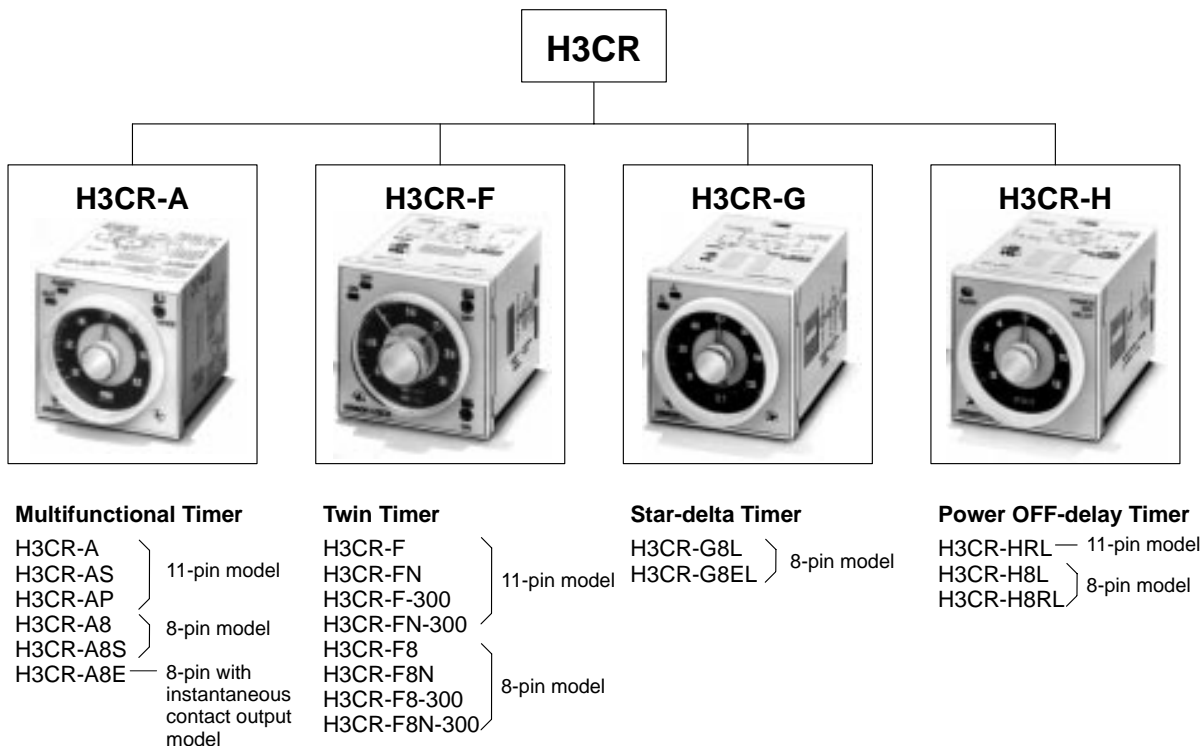

Note: H3CR-AS, H3CR-A8S: Transistor output models

Contents

Solid-state Timer

H3CR-A	4
H3CR-F	23
H3CR-G	29
H3CR-H	36

Common to ALL Timers

Operation	45
Accessories	47
Precautions	51

Solid-state Timer

H3CR-A

DIN 48 x 48-mm State-of-the-art Multifunctional Timer

- A wider power supply range reduces the number of timer models kept in stock.
- A wide range of applications through six or four operating modes.
- Reduced power consumption. (Except for H3CR-A8E)
- Enables easy sequence checks through instantaneous outputs for a zero set value at any time range.
- Length, when panel-mounted with a Socket, of 80 mm or less.
- Time Setting Rings enable consistent settings and limit the setting range.
- Panel Covers enable various panel designs.
- PNP input models available.
- Rich variety of inputs: Start, reset, and gate functions (11-pin models and -AP models)



Ordering Information

11-pin Models

Output	Supply voltage	Input type	Time range	Operating mode (see note 2)	Model	
Contact	100 to 240 VAC (50/60 Hz)/ 100 to 125 VDC	No-voltage input	0.05 s to 300 h	Six multi-modes: A, B, B2, C, D, E	H3CR-A	
	24 to 48 VAC (50/60 Hz)/ 12 to 48 VDC					
	100 to 240 VAC (50/60 Hz)/ 100 to 125 VDC			Dual-modes: G, J	H3CR-A-300	
	24 to 48 VAC (50/60 Hz)/ 12 to 48 VDC					
	100 to 240 VAC (50/60 Hz)/ 100 to 125 VDC	Voltage input	Six multi-modes: A, B, B2, C, D, E	H3CR-AP		
	24 to 48 VAC (50/60 Hz)/ 12 to 48 VDC					
		100 to 240 VAC (50/60 Hz)/ 100 to 125 VDC	No-voltage input	0.1 s to 600 h		H3CR-A-301
		24 to 48 VAC (50/60 Hz)/ 12 to 48 VDC				
Transistor (Photocoupler)	24 to 48 VAC (50/60 Hz)/ 12 to 48 VDC		0.05 s to 300 h		H3CR-AS	

8-pin Models

Output	Supply voltage	Input type	Time range	Operating mode (see note 2)	Model
Contact	100 to 240 VAC (50/60 Hz)/ 100 to 125 VDC	No-input available	0.05 s to 300 h	Four multi-modes: A, B2, E, J (Power supply start)	H3CR-A8
	24 to 48 VAC (50/60 Hz)/ 12 to 48 VDC				
	100 to 240 VAC (50/60 Hz)/ 100 to 125 VDC		0.1 s to 600 h		H3CR-A8-301
	24 to 48 VAC (50/60 Hz)/ 12 to 48 VDC				
Transistor (Photocoupler)	24 to 48 VAC (50/60 Hz)/ 12 to 48 VDC		0.05 s to 300 h		H3CR-A8S
Time-limit contact and instantaneous contact	100 to 240 VAC (50/60 Hz)/ 100 to 125 VDC				H3CR-A8E
	24 to 48 VDC/VAC (50/60 Hz)				

Note: 1. Specify both the model number and supply voltage when ordering.

Example: H3CR-A 100 to 240 VAC (50/60 Hz)/100 to 125 VDC

Supply voltage

2. The operating modes are as follows

A: ON-delay	D: Signal OFF-delay
B: Flicker OFF start	E: Interval
B2: Flicker ON start	G: Signal ON/OFF-delay
C: Signal ON/OFF-delay	J: One-shot

Model Number Legend:

H3CR-A□□□-□

1 2 3 4

1. Number of Pins

None: 11-pin models

8: 8-pin models

2. Input Type for 11-pin Models

None: No-voltage input (NPN type)

P: Voltage input (PNP type)

3. Output

None: Relay output (DPDT)

S: Transistor output (NPN/PNP universal use)

E: Relay output (SPDT) with instantaneous relay output (SPDT)

4. Suffix

300: Dual mode models (signal ON/OFF-delay and one-shot)

301: Double time scale (range) models (0.1 s to 600 h)

■ Accessories (Order Separately)

Name/specifications		Models
Flush Mounting Adapter		Y92F-30
		Y92F-70
		Y92F-71
Mounting Track	50 cm (l) x 7.3 mm (t)	PFP-50N
	1 m (l) x 7.3 mm (t)	PFP-100N
	1 m (l) x 16 mm (t)	PFP-100N2
End Plate		PFP-M
Spacer		PFP-S
Protective Cover		Y92A-48B
Track Mounting/ Front Connecting Socket	8-pin	P2CF-08
	8-pin, finger safe type	P2CF-08-E
	11-pin	P2CF-11
	11-pin, finger safe type	P2CF-11-E
Back Connecting Socket	8-pin	P3G-08
	8-pin, finger safe type	P3G-08 with Y92A-48G (see note 1)
	11-pin	P3GA-11
	11-pin, finger safe type	P3GA-11 with Y92A-48G (see note 1)
Time Setting Ring	Setting a specific time	Y92S-27
	Limiting the setting range	Y92S-28
Panel Cover (see note 2)	Light gray (5Y7/1)	Y92P-48GL
	Black (N1.5)	Y92P-48GB
	Medium gray (5Y5/1)	Y92P-48GM
Hold-down Clip (see note 3)	For PL08 and PL11 Sockets	Y92H-7
	For PF085A Socket	Y92H-8

- Note:**
1. Y92A-48G is a finger safe terminal cover which is attached to the P3G-08 or P3GA-11 Socket.
 2. The Time Setting Ring and Panel Cover are sold together.
 3. Hold-down Clips are sold in sets of two.

Specifications

■ General

Item	H3CR-A/-AS	H3CR-AP	H3CR-A8/-A8S	H3CR-A8E
Operating mode	A: ON-delay B: Flicker OFF start B2: Flicker ON start C: Signal ON/OFF-delay D: Signal OFF-delay E: Interval G: Signal ON/OFF-delay (Only for H3CR-A-300) J: One-shot (Only for H3CR-A-300)		A: ON-delay (power supply start) B2: Flicker ON start (power supply start) E: Interval (power supply start) J: One-shot (power supply start)	
Pin type	11-pin		8-pin	
Input type	No-voltage input	Voltage input	---	
Time-limit output type	H3CR-A/-A8/-AP: Relay output (DPDT) H3CR-AS/-A8S: Transistor output (NPN/PNP universal)*			Relay output (SPDT)
Instantaneous output type	---			Relay output (SPDT)
Mounting method	DIN track mounting, surface mounting, and flush mounting			
Approved standards	UL508, CSA C22.2 No.14, NK, Lloyds Conforms to EN61812-1 (VDE0435/P2021), IEC60664-1 (VDE0110) 4kV/2, EN60947-5-1 (for contact output), and EN60947-5-2 (for non-contact output).			

*The internal circuits are optically isolated from the output. This enables universal application as NPN or PNP transistor.

■ Time Ranges

Note: When the time setting knob is turned below "0" until the point where the time setting knob stops, the output will operate instantaneously at all time range settings.

Standard (0.05-s to 300-h) Models

Time unit		s (sec)	min	h (hrs)	x10 h (10 h)
Full scale setting	1.2	0.05 to 1.2	0.12 to 1.2		1.2 to 12
	3	0.3 to 3			3 to 30
	12	1.2 to 12			12 to 120
	30	3 to 30			30 to 300

Double (0.1-s to 600-h) Models

Time unit		s (sec)	min	h (hrs)	x10 h (10 h)
Full scale setting	2.4	0.1 to 2.4	0.24 to 2.4		2.4 to 24
	6	0.6 to 6			6 to 60
	24	2.4 to 24			24 to 240
	60	6 to 60			60 to 600

■ Ratings

Rated supply voltage (see note 1)	100 to 240 VAC (50/60 Hz)/100 to 125 VDC, 24 to 48 VAC (50/60 Hz)/12 to 48 VDC (24 to 48 VAC/VDC for H3CR-A8E) (see note 2)
Operating voltage range	85% to 110% of rated supply voltage (90% to 110% at 12 VDC)
Power reset	Minimum power-opening time: 0.1 s
Input	<p><u>No-voltage Input</u> ON impedance: 1 kΩ max. ON residual voltage: 1 V max. OFF impedance: 100 kΩ min.</p> <p><u>Voltage Input</u> Max. permissible capacitance between inputs lines (terminals 6 and 7): 1,200 pF Load connectable in parallel with inputs (terminals 6 and 7).</p> <ul style="list-style-type: none"> 100 to 240 VAC/100 to 125 VDC High (logic) level: 85 to 264 VAC/85 to 137.5 VDC Low (logic) level: 0 to 10 VAC/0 to 10 VDC 24 to 48 VAC/12 to 48 VDC High (logic) level: 20.4 to 52.8 VAC/10.8 to 52.8 VDC Low (logic) level: 0 to 2.4 VAC/0 to 1.2 VDC
Power consumption	<p>H3CR-A/-A8</p> <ul style="list-style-type: none"> 100 to 240 VAC/100 to 125 VDC (When at 240 VAC, 60 Hz) Relay ON: approx. 2.1 VA (1.6 W) Relay OFF: approx. 1.3 VA (1.1 W) 24 to 48 VAC/12 to 48 VDC (When at 24 VDC) Relay ON: approx. 0.8 W Relay OFF: approx. 0.2 W <p>H3CR-AP (see note 3)</p> <ul style="list-style-type: none"> 100 to 240 VAC/100 to 125 VDC (When at 240 VAC, 60 Hz) Relay ON: approx. 2.5 VA (2.2 W) Relay OFF: approx. 1.8 VA (1.7 W) 24 to 48 VAC/12 to 48 VDC (When at 24 VDC) Relay ON: approx. 0.9 W Relay OFF: approx. 0.3 W <p>H3CR-A8E</p> <ul style="list-style-type: none"> 100 to 240 VAC/100 to 125 VDC (When at 240 VAC, 60 Hz) Relay ON/OFF: approx. 2 VA (0.9 W) 24 to 48 VAC/VDC (When at 24 VDC) Relay ON/OFF: approx. 0.9 W <p>H3CR-AS/-A8S</p> <ul style="list-style-type: none"> 24 to 48 VAC/12 to 48 VDC (When at 24 VDC) Output ON: 0.3 W Output OFF: 0.2 W
Control outputs	Time limit contacts: 5 A at 250 VAC/30 VDC, resistive load ($\cos\phi = 1$) Transistor output: Open collector (NPN/PNP), 100 mA max. at 30 VDC max., residual voltage: 2 V max. Instantaneous contact: 5 A at 250 VAC, resistive load ($\cos\phi = 1$)

- Note:**
- DC ripple rate: 20% max. if the power supply incorporates a single-phase, full-wave rectifier.
 - Each 24-to-48-VAC/12-to-48-VDC model causes an inrush current of approximately 0.85 A. Pay careful attention when attempting to turn ON power to such a model with non-contact output from a device such as a sensor.
 - The values are for when the terminals 2 and 7 and terminals 10 and 6 are short-circuited, and include the consumption current of the input circuit.

■ Characteristics

Accuracy of operating time	±0.2% FS max. (±0.2%±10 ms max. in a range of 1.2 s)
Setting error	±5% FS ±50 ms (see note)
Reset time	Min. power-opening time: 0.1 s max. Min. pulse width: 0.05 s (H3CR-A/-AS)
Reset voltage	10% max. of rated voltage
Influence of voltage	±0.2% FS max. (±0.2%±10 ms max. in a range of 1.2 s)
Influence of temperature	±1% FS max. (±1%±10 ms max. in a range of 1.2 s)
Insulation resistance	100 MΩ min. (at 500 VDC)
Dielectric strength	2,000 VAC (1,000 VAC for H3CR-A□S), 50/60 Hz for 1 min (between current-carrying metal parts and exposed non-current-carrying metal parts) 2,000 VAC (1,000 VAC for H3CR-A□S), 50/60 Hz for 1 min (between control output terminals and operating circuit) 2,000 VAC, 50/60 Hz for 1 min (between contacts of different polarities) 1,000 VAC, 50/60 Hz for 1 min (between contacts not located next to each other) 2,000 VAC, 50/60 Hz for 1 min (between input and control output terminals and operation circuit)
Impulse withstand voltage	3 kV (between power terminals) for 100 to 240 VAC/100 to 125 VDC, 1 kV for 24 to 48 VAC/12 to 48 VDC 4.5 kV (between current-carrying terminal and exposed non-current-carrying metal parts) for 100 to 240 VAC/100 to 125 VDC, 1.5 kV for 24 to 48 VAC/12 to 48 VDC and 24 to 48 VAC/VDC
Noise immunity	±1.5 kV (between power terminals) and ±600 V (between no-voltage input terminals), square-wave noise by noise simulator (pulse width: 100 ns/1 μs, 1-ns rise)
Static immunity	Malfunction: 8 kV Destruction: 15 kV
Vibration resistance	Destruction: 10 to 55 Hz with 0.75-mm double amplitude each in 3 directions for 2 hours each Malfunction: 10 to 55 Hz with 0.5-mm double amplitude each in 3 directions for 10 minutes each
Shock resistance	Destruction: 1,000 m/s ² 3 times each in 6 directions Malfunction: 100 m/s ² 3 times each in 6 directions
Ambient temperature	Operating: -10°C to 55°C (with no icing) Storage: -25°C to 65°C (with no icing)
Ambient humidity	Operating: 35% to 85%
Life expectancy	Mechanical: 20,000,000 operations min. (under no load at 1,800 operations/h) Electrical: 100,000 operations min. (5 A at 250 VAC, resistive load at 1,800 operations/h)
EMC	(EMI) EN50081-2 Emission Enclosure: EN55011 Group 1 class A Emission AC Mains: EN55011 Group 1 class A (EMS) EN50082-2 Immunity ESD: EN61000-4-2: 4 kV contact discharge (level 2) 8 kV air discharge (level 3) Immunity RF-interference from AM Radio Waves: ENV50140: 10 V/m (80 MHz to 1 GHz) (level 3) Immunity RF-interference from Pulse-modulated Radio Waves: ENV50204: 10 V/m (900±5 MHz) (level 3) Immunity Conducted Disturbance: ENV50141: 10 V (0.15 to 80 MHz) (level 3) Immunity Burst: EN61000-4-4: 2 kV power-line (level 3) 2 kV I/O signal-line (level 4) Immunity Surge: EN61000-4-5: 1 kV line to line 2 kV line to ground (level 3)
Case color	Light gray (Munsell 5Y7/1)
Degree of protection	IP40 (panel surface)
Weight	Approx. 90 g

Note: The value is ±5% FS +100 ms to -0 ms max. when the C, D, or G mode signal of the H3CR-AP is OFF.

Engineering Data

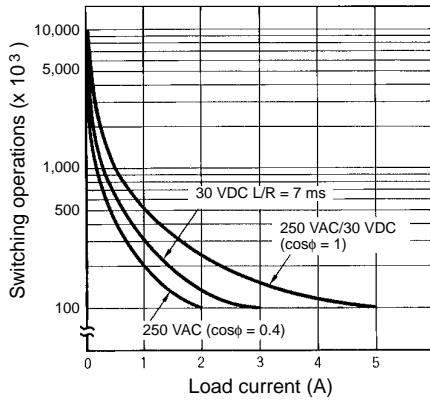

Reference: A maximum current of 0.15 A can be switched at 125 VDC ($\cos\phi = 1$) and a maximum current of 0.1 A can be switched if L/R is 7 ms. In both cases, a life of 100,000 operations can be expected. The minimum applicable load is 10 mA (100 mA for H3CR-A8E) at 5 VDC (failure level: P).

Nomenclature

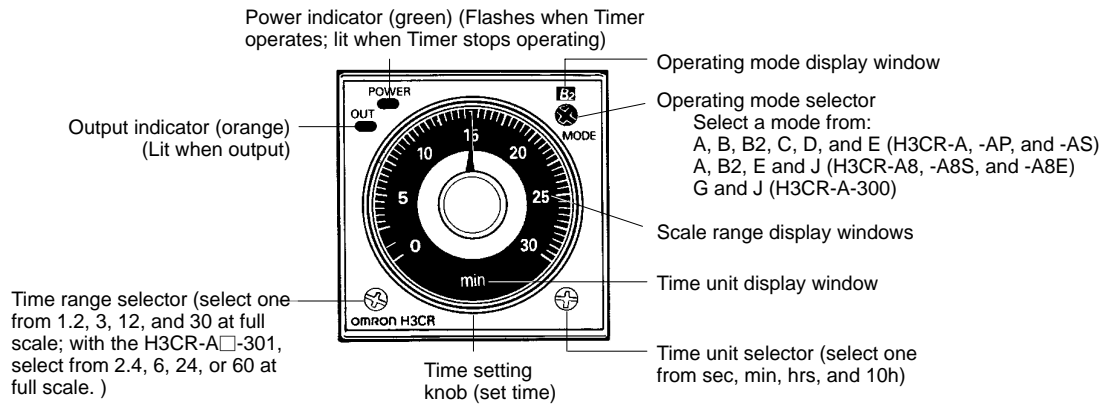

Operation

■ Block Diagrams

H3CR-A/AS

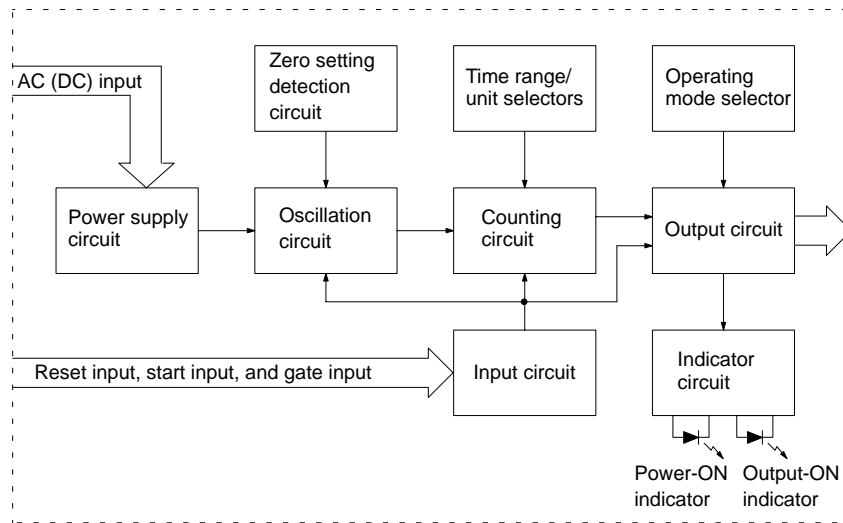

H3CR-AP

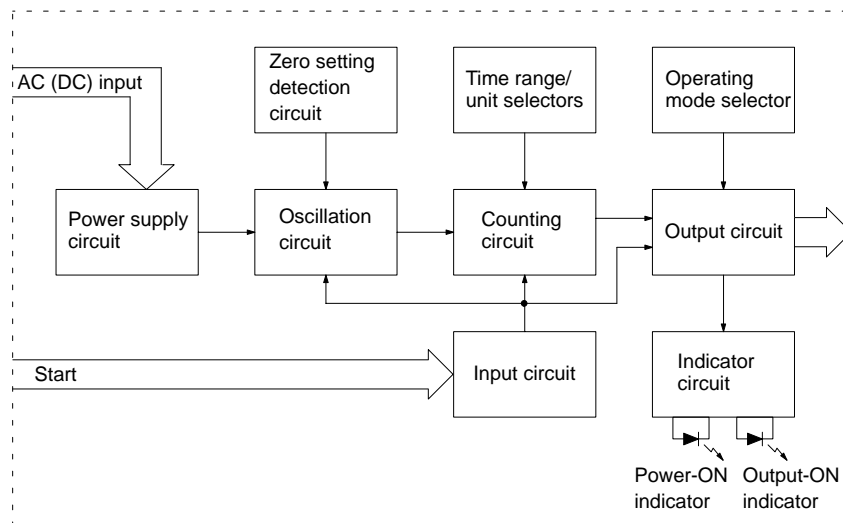

H3CR-A8/A8S

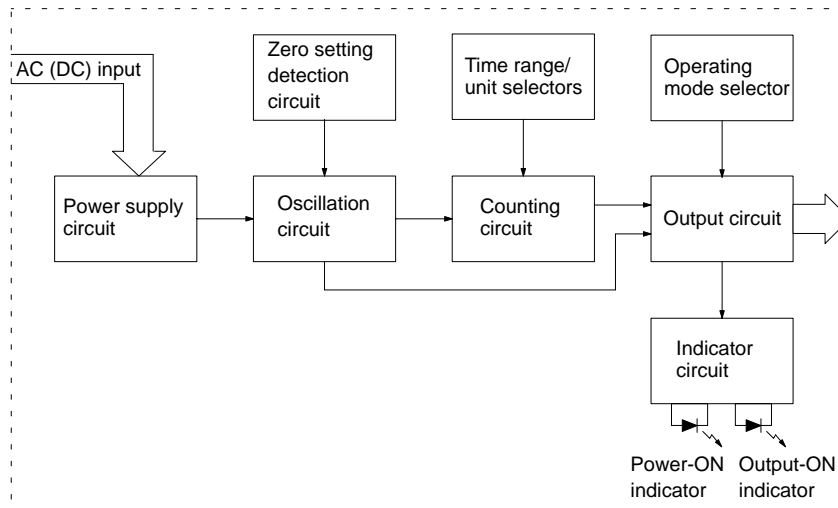

H3CR-A8E

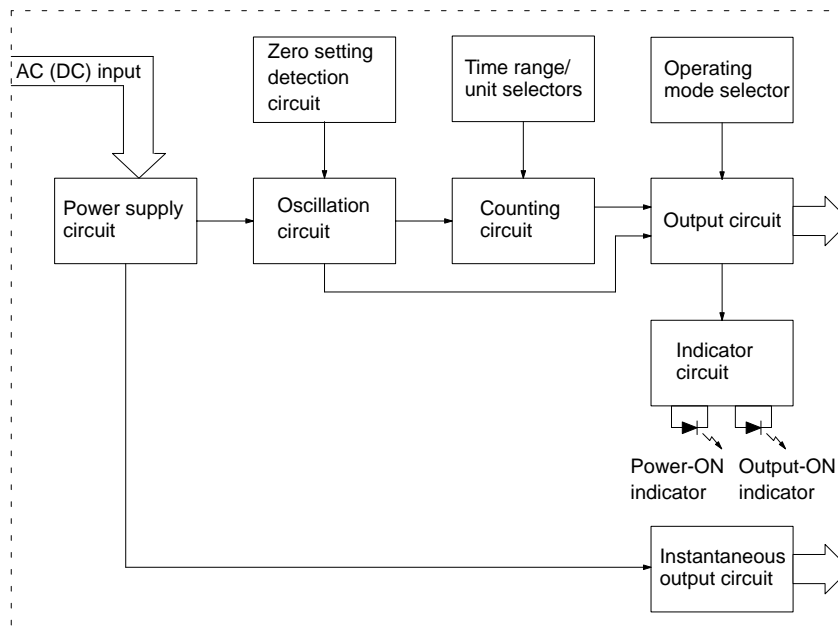

■ I/O Functions

Inputs (for -A/-AS models)	Start	Starts time-measurement.
	Reset	Interrupts time-measurement and resets time-measurement value. No time-measurement is made and control output is OFF while the reset input is ON.
	Gate	Prohibits time-measurement.
Outputs	Control output	Outputs are turned ON according to designated output mode when preset value is reached.

Note: H3CR-AP incorporates start input only.

■ Timing Chart

Note: 1. The minimum power-opening time ("Rt") is 0.1 s and the minimum pulse width is 0.05 s.

2. The letter "t" in the timing charts stands for the set time and "t-a" means that the period is less than the time set.

H3CR-A/-AS/-AP*

*H3CR-AP model incorporates start input only.

Operating mode	Timing chart	
A: ON-delay		<div style="border: 1px solid black; padding: 5px; width: fit-content;">Basic operation</div> <p>Note: Start input is invalid while the Timer is in operation.</p>
B: Flicker OFF start		<div style="border: 1px solid black; padding: 5px; width: fit-content;">Basic operation</div> <p>Note: Start input is invalid while the Timer is in operation.</p>
B2: Flicker ON start		<div style="border: 1px solid black; padding: 5px; width: fit-content;">Basic operation</div> <p>Note: Start input is invalid while the Timer is in operation.</p>
C: Signal ON/OFF-delay		<div style="border: 1px solid black; padding: 5px; width: fit-content;">Basic operation</div> <p>Note: Start input is valid and re-triggerable while the Timer is in operation.</p>

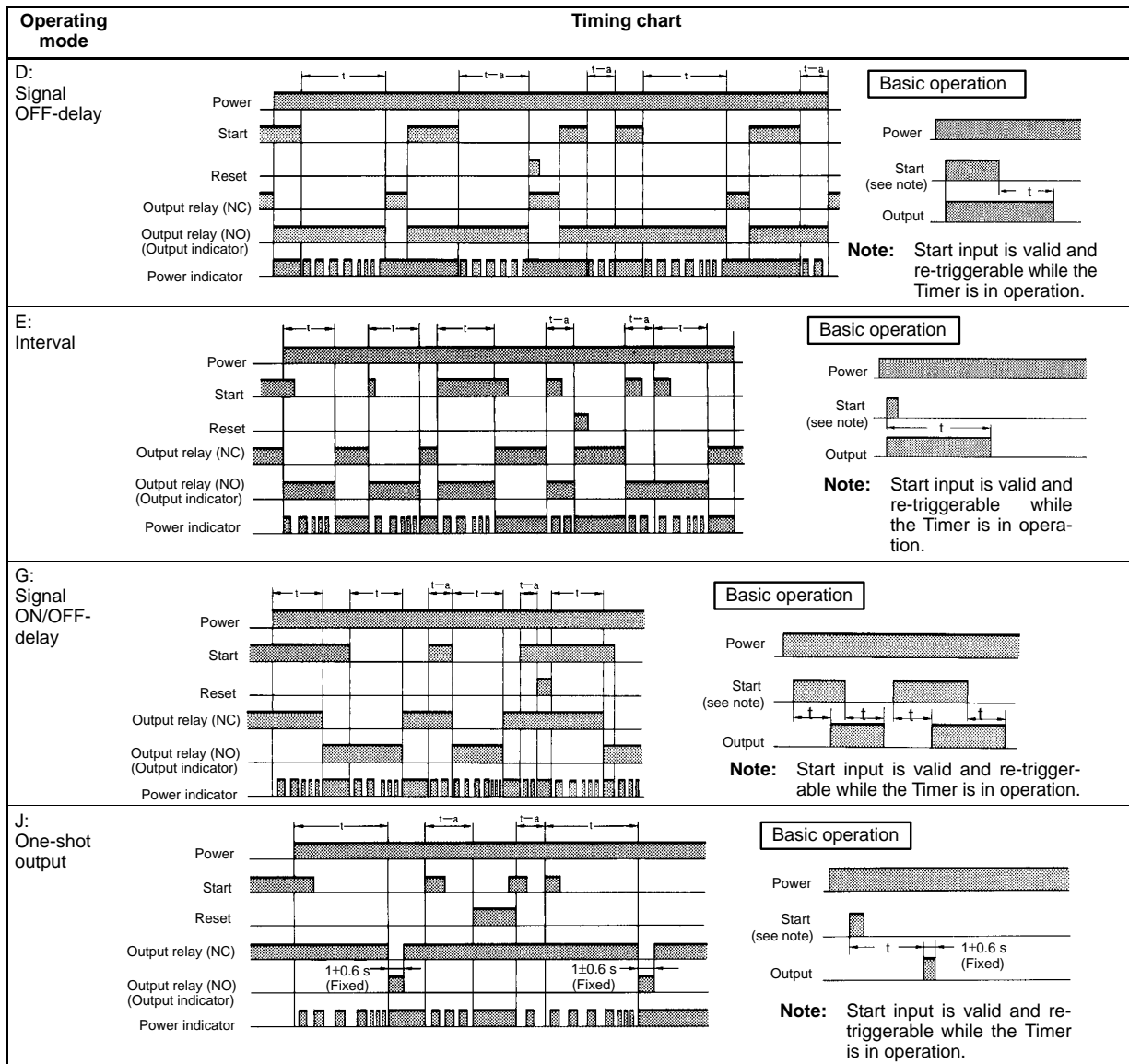

Gate Signal Input

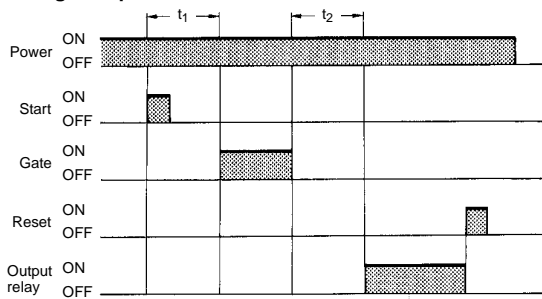

- Note:**
1. This timing chart indicates the gate input in operating mode A (ON-delay operation).
 2. The set time is the sum of t_1 and t_2 .
 3. H3CR-AP model incorporates start input only.

H3CR-A8/-A8S

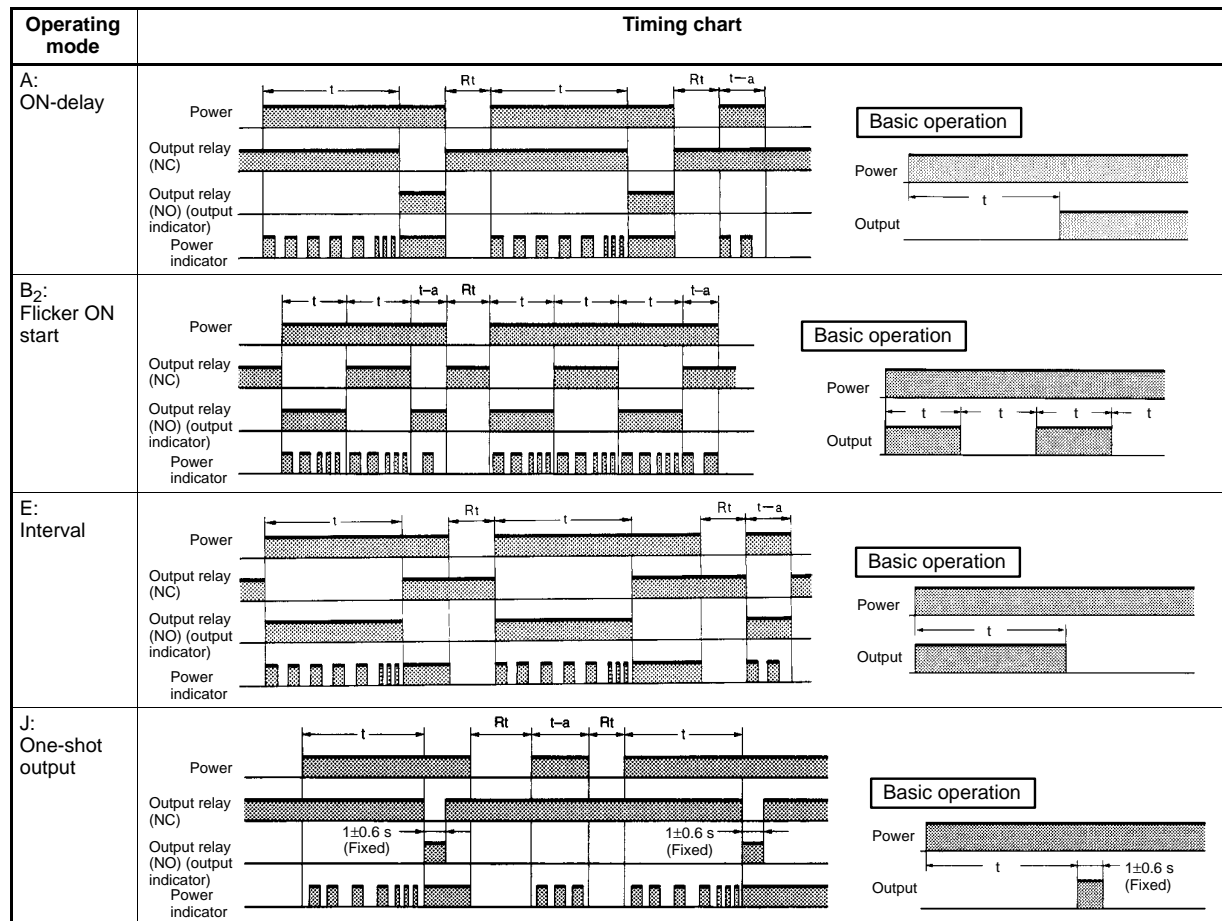

H3CR-A8E

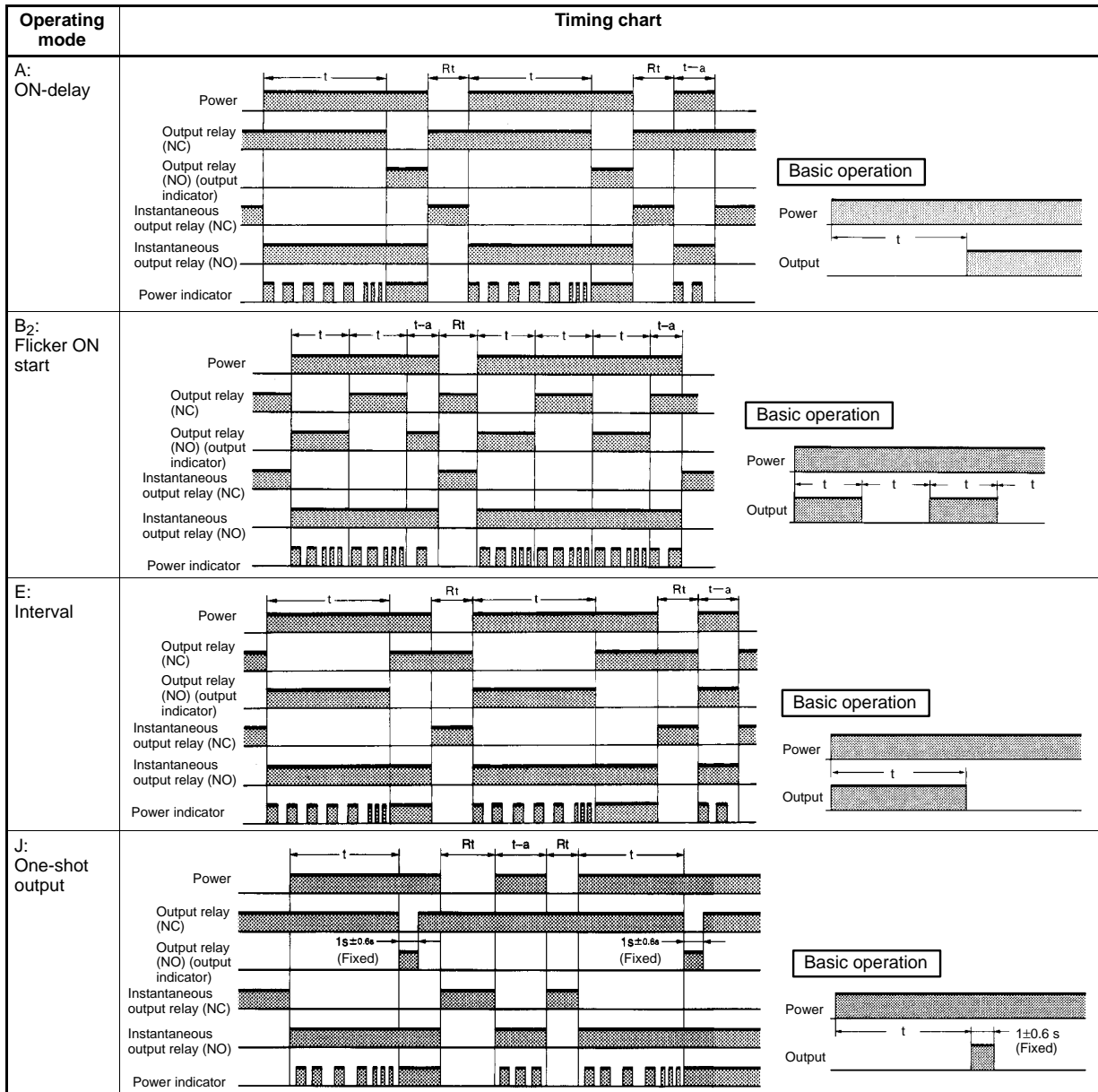

Dimensions

Note: All units are in millimeters unless otherwise indicated.

**H3CR-A
H3CR-AP
H3CR-AS**

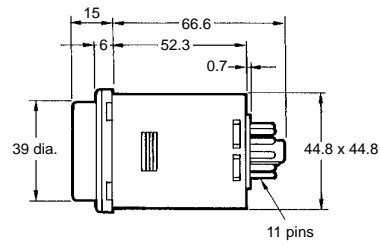
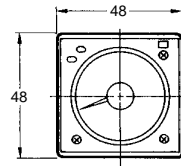
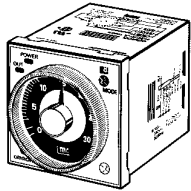

**H3CR-A8
H3CR-A8S
H3CR-A8E**

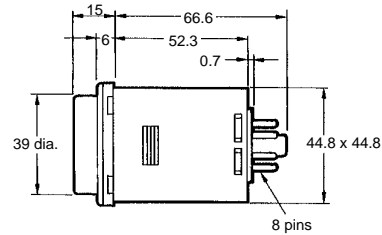
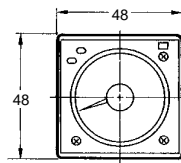
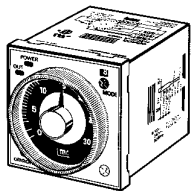

Dimensions with Set Ring

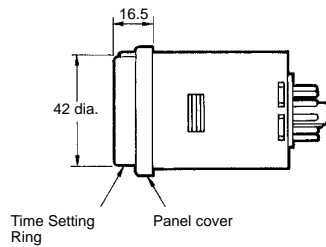
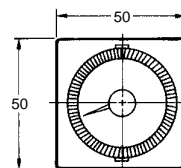
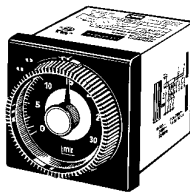

Dimensions with Front Connecting Socket P2CF-08-□/ P2CF-11-□

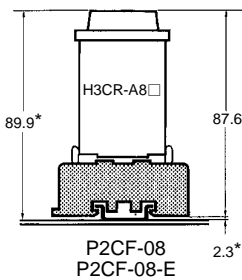
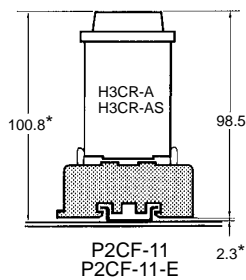

Dimensions with Back Connecting Socket P3G-08/P3GA-11

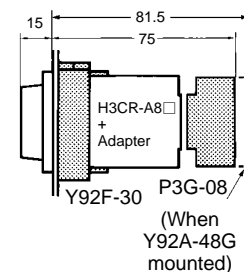
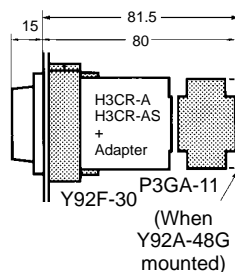

*These dimensions vary with the kind of DIN track (reference value).

Installation

Terminal Arrangement

Note: The delayed contact of conventional Timers was indicated as 

The contact symbol of the H3CR-A is indicated as  because its operating mode is six multi-modes (four multi-modes for the H3CR-A8).

11-pin Models

H3CR-A (Contact Output)

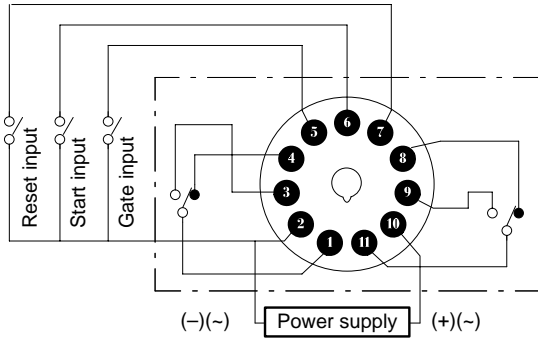

H3CR-AS (Transistor Output)

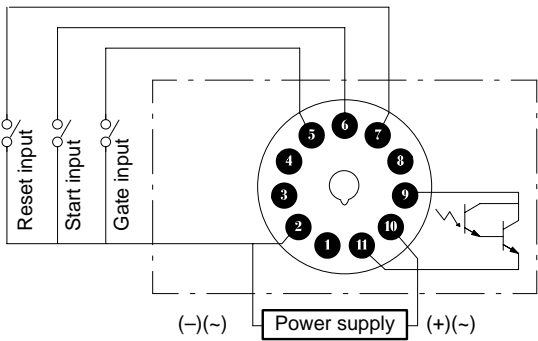

Note: Terminals 1, 3, 4, and 8 are empty. Terminals 2, 5, 6, 7, and 10 are the same as for the H3CR-A.

H3CR-AP (Contact Output)

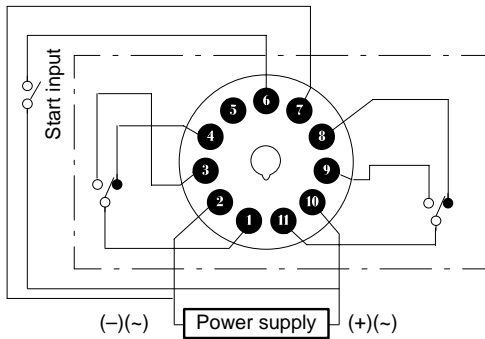

Note: Terminal 5 is empty.

8-pin Models

H3CR-A8 (Contact Output)

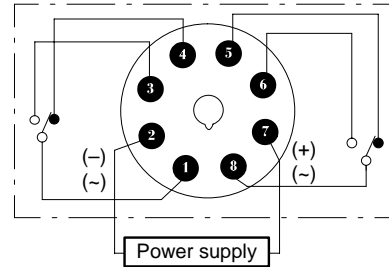

H3CR-A8S (Transistor Output)

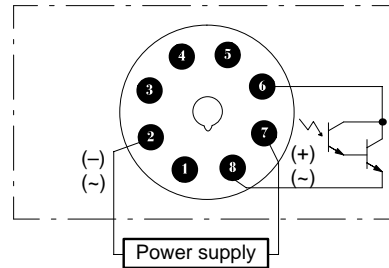

Note: Terminals 1, 3, 4, and 5 are empty. Terminals 2 and 7 are the same as for the H3CR-A8.

H3CR-A8E (Contact Output)

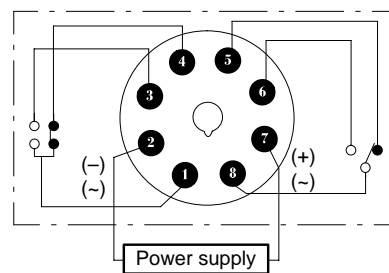

Input Connections

H3CR-A/-AS

The inputs of the H3CR-A/-AS are no-voltage (short-circuit or open) inputs.

No-voltage Inputs

No-contact Input

(Connection to NPN open collector output sensor.)

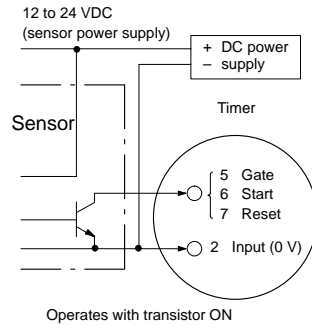

Contact Input

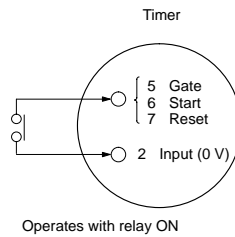

No-contact Input

(Connection to a voltage output sensor.)

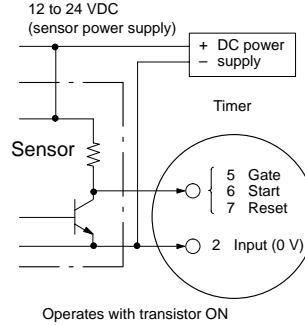

No-voltage Input Signal Levels

No-contact input	1. Short-circuit level Transistor ON Residual voltage: 1 V max. Impedance when ON: 1 k Ω max.
	2. Open level Transistor OFF Impedance when OFF: 100 k Ω min.
Contact input	Use contacts which can adequately switch 0.1 mA at 5 V

H3CR-AP

The start input of the H3CR-AP is voltage input. (Voltage imposition or open)

Voltage Inputs

No-contact Input

(Connection to PNP open collector output sensor)

12 to 24 VDC

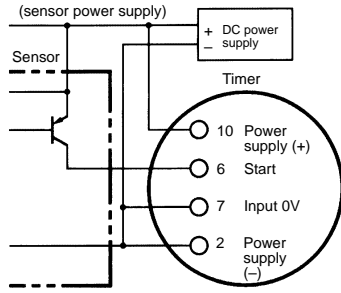

Operates with PNP transistor ON

No-contact Input

(Connection to NPN open collector output sensor)

12 to 24 VDC

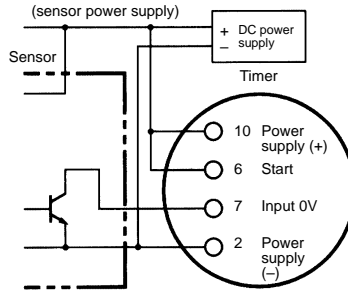

Operates with NPN transistor ON

Contact Input

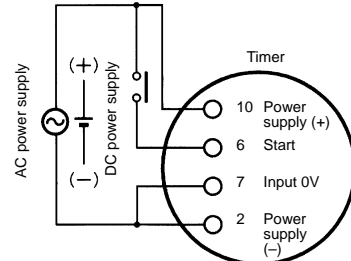

Operates with relay ON

Note: The input circuit is isolated from the power supply circuit. Thus, an NPN transistor can be connected.

Note: Refer to the signal levels in the following table and be aware of the minimum applicable load of the relay.

Voltage Input Signal Levels

No-contact input	1. Transistor ON Residual voltage: 1 V max. The voltage between terminals 6 and 7 must be 10.8 VDC min.
	2. Transistor OFF Leakage current: 0.01 mA max. The voltage between terminals 6 and 7 must be 1.2 VDC max.
Contact input	Use contacts that can adequately switch 0.1 mA at each operating voltage. The voltage between terminals 6 and 7 with contacts ON or OFF must satisfy the specified value. Contacts ON 100-to-240-VAC and 100-to-125-VDC models: 85 to 264 VAC or 85 to 137.5 VDC 24-to-48-VAC and 12-to-48-VDC models: 20.4 to 52.8 VAC or 10.8 to 52.8 VDC Contacts OFF 100-to-240-VAC and 100-to-125-VDC models: 0 to 10 VAC or 0 to 10 VDC 24-to-48-VAC and 12-to-48-VDC models: 0 to 2.4 VAC or 0 to 1.2 VDC

Application Examples

A Mode: ON-delay

ON-delay operation (A mode) is a basic mode.

1. Power-ON Start/Power-OFF Reset

The Power-ON start/Power-OFF reset operation is a standard operating method.

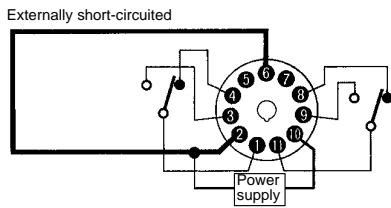
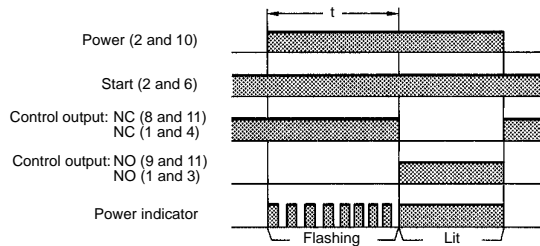

2. Signal Start/Signal Reset

The Signal start/Signal reset operation is useful for remote control of the Timer.

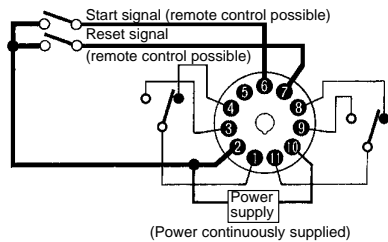
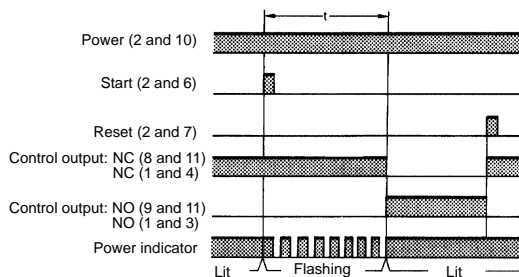

3. Control of Integrated Time with Gate Signal

With a gate signal, the Power-ON start operation and Signal start operation can be controlled (the operation can be interrupted).

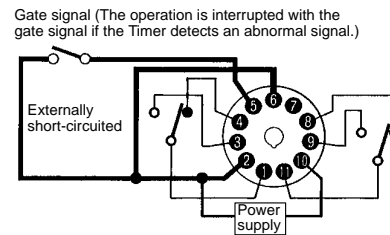
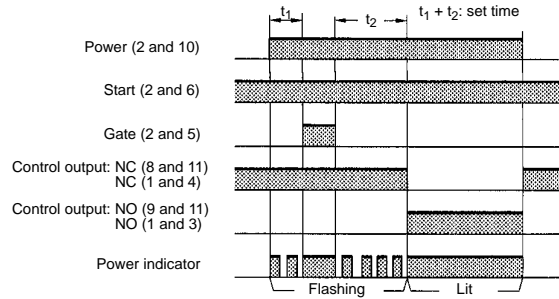

B/B2 Mode: Flicker

The flicker operation in the B and B2 modes can be effectively applied to lamp or buzzer (ON and OFF) alarms or the monitoring of an intermittent operation with a display.

1. Power-ON Start/Power-OFF Reset (in B Mode)

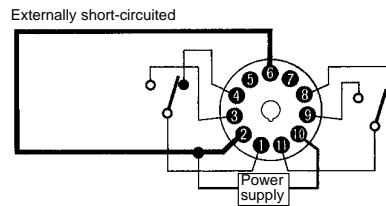
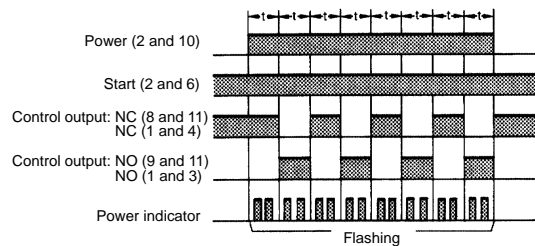

2. Signal Start/Signal Reset (in B Mode)

If there is an abnormal signal, flashing starts. When the abnormal condition is restored, a reset signal stops the display flashing.

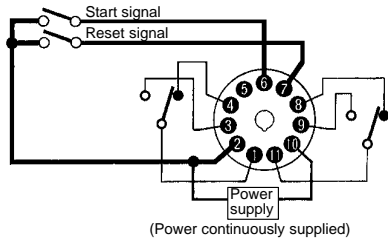
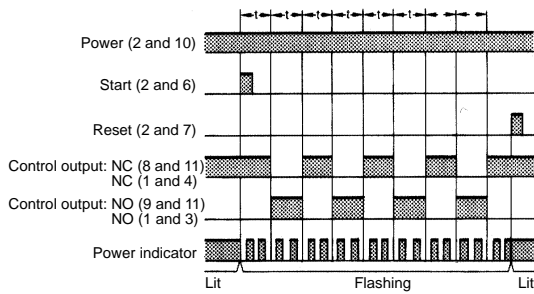

2. Signal-ON-OFF Start/Instantaneous Operation/Time-limit Reset

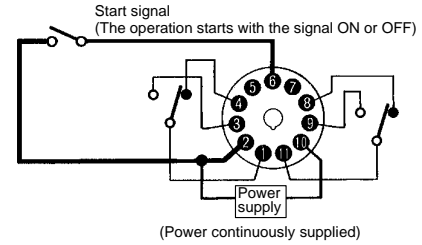
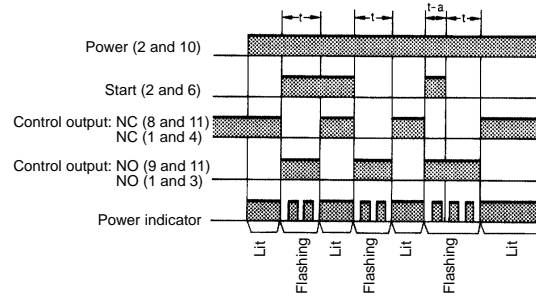

C Mode: Signal ON/OFF-delay

The Signal ON/OFF-delay operation (C mode) is useful for the control of distribution of products on a production line into boxes by the specified number or time.

1. Power-ON Start/Instantaneous Operation/Time-limit Reset

A set of these functions is useful for the operation of a machine for a specified period when power is ON.

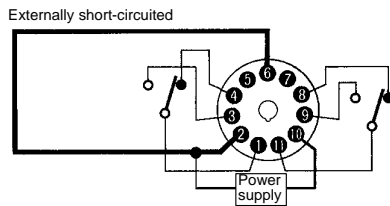
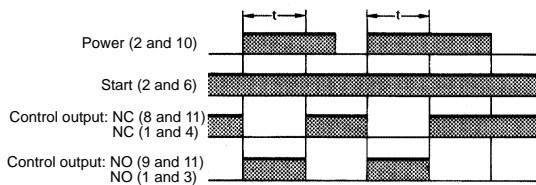

D Mode: Signal OFF-delay

Signal OFF-delay operation (D mode) can be effectively used to keep a load operating for a certain period. For example, this function enables the cooling fan for a lamp or heater to operate for a certain period after the lamp or heater is switched OFF.

1. Power-ON Start/Instantaneous Operation/Time-limit Reset

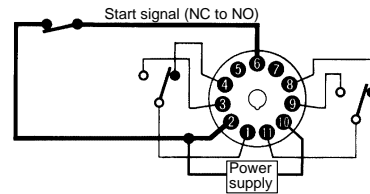
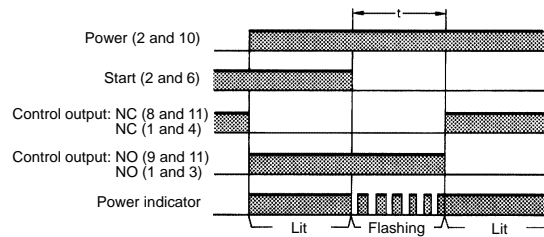

2. Signal Start/Instantaneous Operation/Time-limit Reset

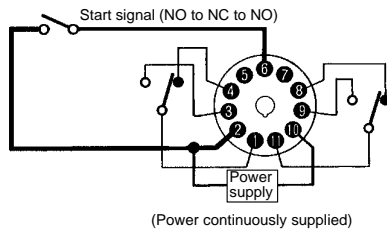
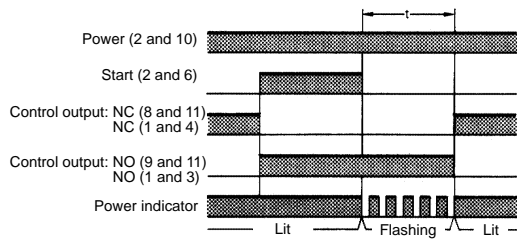

2. Signal Start/Instantaneous Operation/Time-limit Reset

This function is useful for the repetitive control such as the filling of liquid for a specified period after each Signal start input.

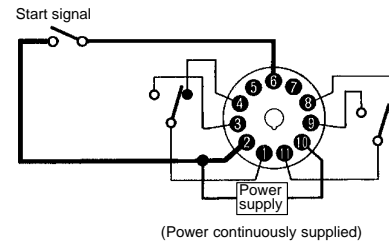
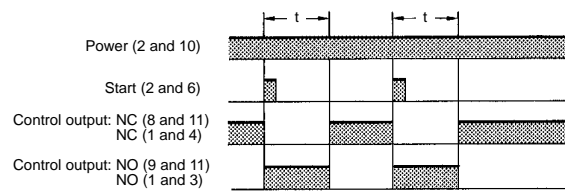

E Mode: Interval

1. Power-ON Start/Instantaneous Operation/Time-limit Reset

This function is useful for the operation of a machine for a specified period after power is ON.

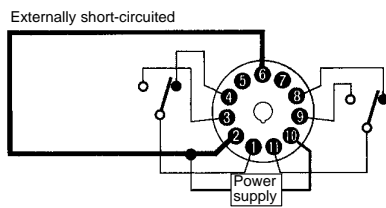
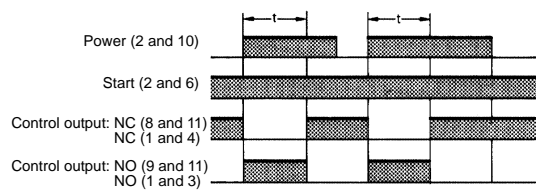

Solid-state Twin Timers

H3CR-F

DIN 48 x 48-mm Twin Timers

- Wide power supply ranges of 100 to 240 VAC and 48 to 125 VDC respectively.
- Independent ON- and OFF-time settings. Furthermore, combinations of long ON- or OFF-time and short OFF- or ON-time settings are possible.
- Fourteen time ranges from 0.05 s to 30 h or from 1.2 s to 300 h depending on the model to be used.
- Models with a flicker ON start or flicker OFF start are available.
- Easy sequence checks through instantaneous outputs for a zero set value at any time range.
- Length, when panel-mounted with a Socket, of 80 mm or less.
- 11-pin and 8-pin models are available.



Ordering Information

Operating modes	Supply voltage	0.05 s to 30 h models		1.2 s to 300 h models	
		11-pin models	8-pin models	11-pin models	8-pin models
Flicker OFF start	100 to 240 VAC	H3CR-F	H3CR-F8	H3CR-F-300	H3CR-F8-300
	24 VAC/DC				
	12 VDC				
	48 to 125 VDC				
Flicker ON start	100 to 240 VAC	H3CR-FN	H3CR-F8N	H3CR-FN-300	H3CR-F8N-300
	24 VAC/DC				
	12 VDC				
	48 to 125 VDC				

Note: Specify both the model number and supply voltage when ordering.

Example: H3CR-F 24 VAC/DC

Supply voltage

Model Number Legend:

H3CR - -
 1 2 3 4

1. Classification

F: Twin timers

2. Configuration

None: 11-pin socket

8: 8-pin socket

3. Twin Timer Mode

None: Flicker OFF start

N: Flicker ON start

4. Time Range

None: 0.05 s to 30 h models

300: 1.2 s to 300 h models

■ Accessories (Order Separately)

Name/specifications		Models
Flush Mounting Adapter		Y92F-30
		Y92F-73
		Y92F-74
Mounting Track	50 cm (l) x 7.3 mm (t)	PFP-50N
	1 m (l) x 7.3 mm (t)	PFP-100N
	1 m (l) x 16 mm (t)	PFP-100N2
End Plate		PFP-M
Spacer		PFP-S
Protective Cover		Y92A-48B
Track Mounting/ Front Connecting Socket	8-pin	P2CF-08
	8-pin, finger safe type	P2CF-08-E
	11-pin	P2CF-11
	11-pin, finger safe type	P2CF-11-E
Back Connecting Socket	8-pin	P3G-08
	8-pin, finger safe type	P3G-08 with Y92A-48G (see note 1)
	11-pin	P3GA-11
	11-pin, finger safe type	P3GA-11 with Y92A-48G (see note 1)
Hold-down Clip (see note 2)	For PL08 and PL11 Sockets	Y92H-7
	For PF085A Socket	Y92H-8

- Note:**
1. Y92A-48G is a finger safe terminal cover which is attached to the P3G-08 or P3GA-11 Socket.
 2. Hold-down Clips are sold in sets of two.

Specifications

■ General

Item	H3CR-F	H3CR-F8	H3CR-FN	H3CR-F8N
Operating mode	Flicker OFF start		Flicker ON start	
Pin type	11-pin	8-pin	11-pin	8-pin
Operating/Reset method	Time-limit operation/Time-limit reset or self-reset			
Output type	Relay output (DPDT)			
Mounting method	DIN track mounting, surface mounting, and flush mounting			
Approved standards	UL508, CSA C22.2 No.14, NK, Lloyds Conforms to EN61812-1 (VDE0435/P2021), IEC60664-1 (VDE0110) 4kV/2, and EN60947-5-1 (for contact output).			

■ Time Ranges

0.05 s to 30 h Models

Time unit		s (sec)	x10 s (10 s)	min	h (hrs)
Setting	1.2	0.05 to 1.2	1.2 to 12	0.12 to 1.2	
	3	0.3 to 3	3 to 30	0.3 to 3	
	12	1.2 to 12	12 to 120	1.2 to 12	
	30	3 to 30	30 to 300	3 to 30	

Note: Instantaneous output is available at any time range. To obtain instantaneous output, set to below 0.

1.2 s to 300 h Models

Time unit		x10 s (10 s)	x10 min (10 min)	h (hrs)	x10 h (10 h)
Setting	1.2	1.2 to 12	1.2 to 12	0.12 to 1.2	1.2 to 12
	3	3 to 30	3 to 30	0.3 to 3	3 to 30
	12	12 to 120	12 to 120	1.2 to 12	12 to 120
	30	30 to 300	30 to 300	3 to 30	30 to 300

Note: Instantaneous output is available at any time range. To obtain instantaneous output, set to below 0.

■ Ratings

Rated supply voltage (see note)	100 to 240 VAC (50/60 Hz), 12 VDC, 24 VAC/DC (50/60 Hz), 48 to 125 VDC
Operating voltage range	85% to 110% of rated supply voltage; 90% to 110% with 12-VDC models
Power reset	Minimum power-opening time: 0.1 s
Power consumption	100 to 240 VAC: approx. 10 VA (2.1 W) at 240 VAC 24 VAC/VDC: approx. 2 VA (1.7 W) at 24 VAC approx. 1 W at 24 VDC 48 to 125 VDC: approx. 1.5 W at 125 VDC 12 VDC: approx. 1 W at 12 VDC
Control outputs	Contact output: 5 A at 250 VAC/30 VDC, resistive load ($\cos\phi = 1$)

Note: A power supply with a ripple of 20% max. (single-phase power supply with full-wave rectification) can be used with each DC Model.

■ Characteristics

Accuracy of operating time	±0.2% FS max. (±0.2% FS ±10 ms max. in ranges of 1.2 and 3 s)
Setting error	±5% FS ±50 ms max.
Reset time	0.1 s max.
Reset voltage	10 % max. of rated voltage
Influence of voltage	±0.2% FS max. (±0.2% FS ±10 ms max. in ranges of 1.2 and 3 s)
Influence of temperature	±1% FS max. (±1% FS ±10 ms max. in ranges of 1.2 and 3s)
Insulation resistance	100 MΩ min. (at 500 VDC)
Dielectric strength	2,000 VAC, 50/60 Hz for 1 min (between current-carrying metal parts and exposed non-current-carrying metal parts) 2,000 VAC, 50/60 Hz for 1 min (between control output terminals and operating circuit) 2,000 VAC, 50/60 Hz for 1 min (between contacts of different polarities) 1,000 VAC, 50/60 Hz for 1 min (between contacts not located next to each other)
Impulse withstand voltage	3 kV (between power terminals) for 100 to 240 VAC, 48 to 125 VDC 1 kV for 12 VDC, 24 VAC/DC 4.5 kV (between current-carrying terminal and exposed non-current-carrying metal parts) for 100 to 240 VAC, 48 to 125 VDC 1.5 kV for 12 VDC, 24 VAC/DC
Noise immunity	±1.5 kV (between power terminals), square-wave noise by noise simulator (pulse width: 100 ns/1 μs, 1-ns rise) ±400 V for 12 VDC
Static immunity	Malfunction: 8 kV Destruction: 15 kV
Vibration resistance	Destruction: 10 to 55 Hz with 0.75-mm single amplitude for 2 hrs each in three directions Malfunction: 10 to 55 Hz with 0.5-mm single amplitude for 10 min each in three directions
Shock resistance	Destruction: 980 m/s ² three times each in six directions Malfunction: 98 m/s ² three times each in six directions
Ambient temperature	Operating: -10°C to 55°C (with no icing) Storage: -25°C to 65°C (with no icing)
Ambient humidity	Operating: 35% to 85%
Life expectancy	Mechanical: 20 million operations min. (under no load at 1,800 operations/h) Electrical: 100,000 operations min. (5 A at 250 VAC, resistive load at 1,800 operations/h)
EMC	(EMI) EN50081-2 Emission Enclosure: EN55011 Group 1 class A Emission AC Mains: EN55011 Group 1 class A (EMS) EN50082-2 Immunity ESD: EN61000-4-2: 4 kV contact discharge (level 2) 8 kV air discharge (level 3) Immunity RF-interference from AM Radio Waves: ENV50140: 10 V/m (80 MHz to 1 GHz) (level 3) Immunity RF-interference from Pulse-modulated Radio Waves: ENV50204: 10 V/m (900±5 MHz) (level 3) Immunity Conducted Disturbance: ENV50141: 10 V (0.15 to 80 MHz) (level 3) Immunity Burst: EN61000-4-4: 2 kV power-line (level 3) 2 kV I/O signal-line (level 4) Immunity Surge: EN61000-4-5: 1 kV line to line (level 3) 2 kV line to ground (level 3)
Case color	Light Gray (Munsell 5Y7/1)
Enclosure ratings	IP40 (panel surface)
Weight	Approx. 100 g

Engineering Data

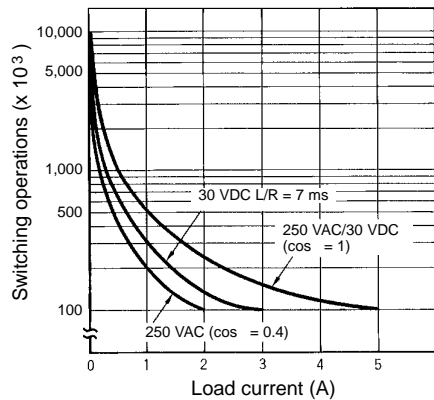

Reference: A maximum current of 0.15 A can be switched at 125 VDC (cos = 1) and a maximum current of 0.1 A can be switched if L/R is 7 ms. In both cases, a life of 100,000 operations can be expected. The minimum applicable load is 10 mA at 5 VDC (failure level: P).

Nomenclature

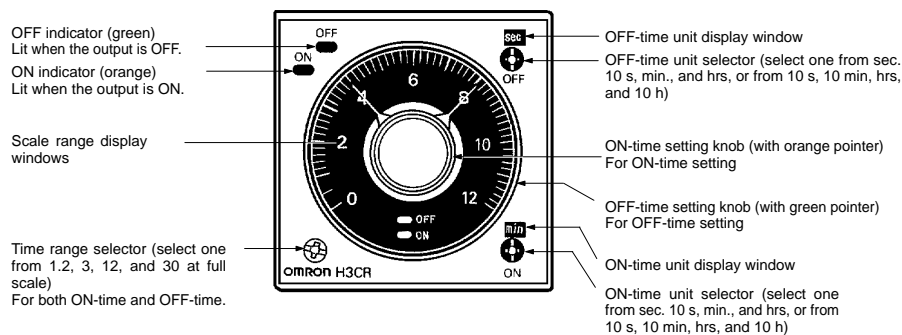

Operation

Block Diagrams

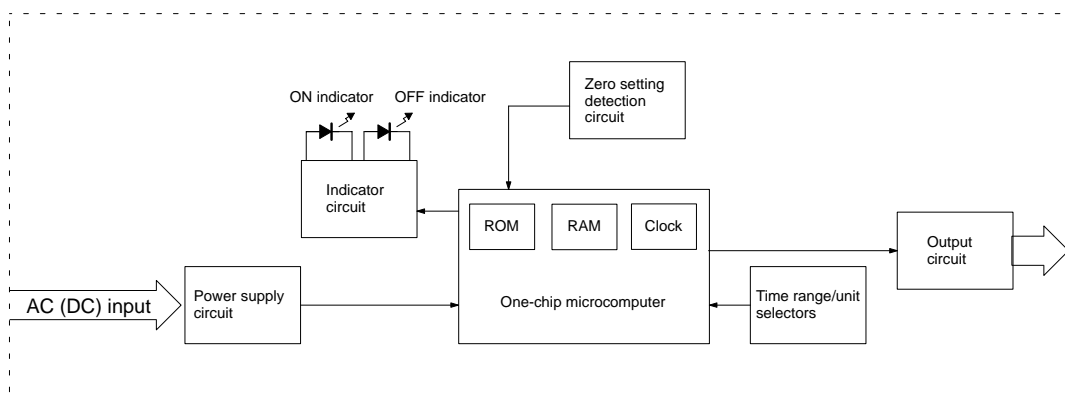

I/O Functions

Inputs	---	
Outputs	Control output	Outputs are turned ON/OFF according to the time set by the ON- and OFF-time setting knob.

■ Timing Chart

t_{ON} : ON set time
 t_{OFF} : OFF set time

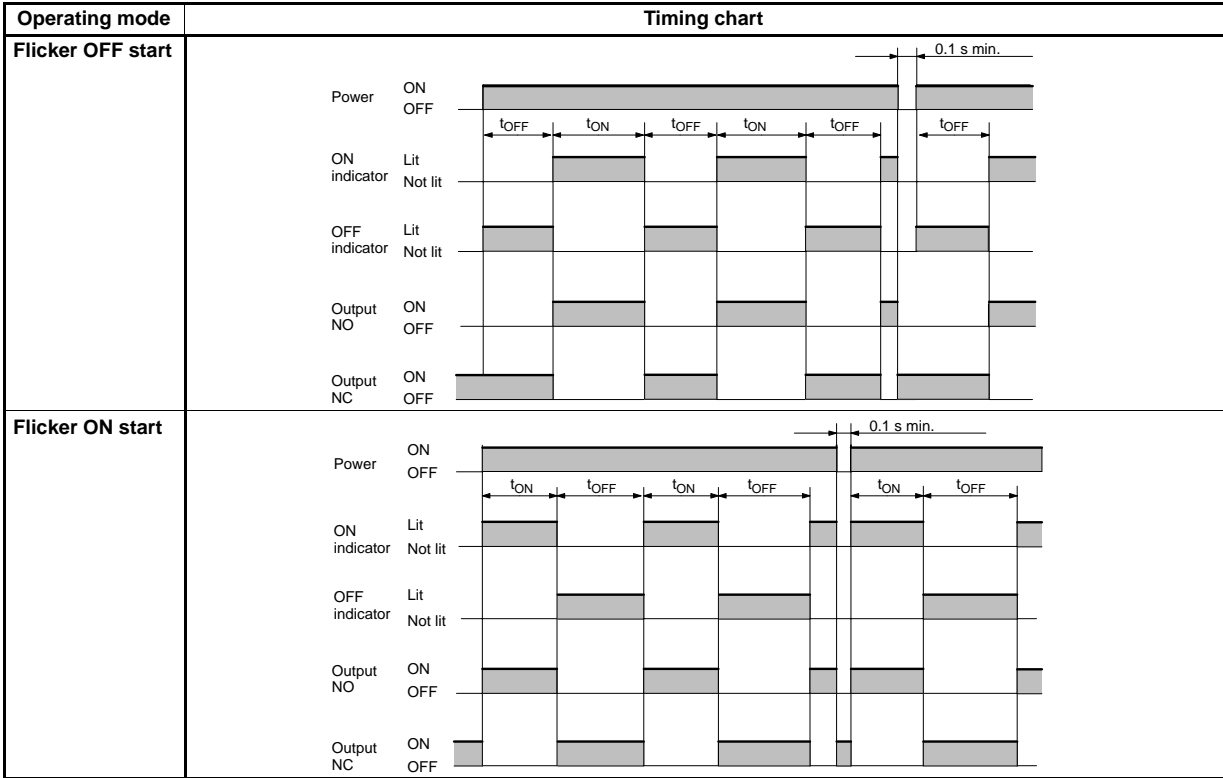

- Note:**
1. The reset time requires a minimum of 0.1 s.
 2. When power is supplied in flicker ON start mode, the OFF indicator lights momentarily. This, however, has no effect on the performance of the Timer.

Dimensions

Note: All units are in millimeters unless otherwise indicated.

H3CR-F
H3CR-FN
H3CR-F-300
H3CR-FN-300

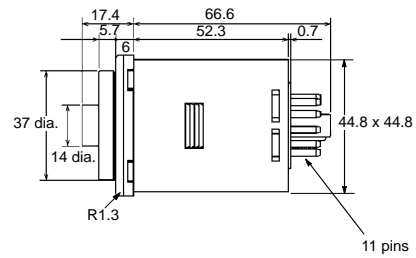
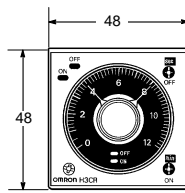
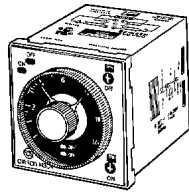

H3CR-F8
H3CR-F8N
H3CR-F8-300
H3CR-F8N-300

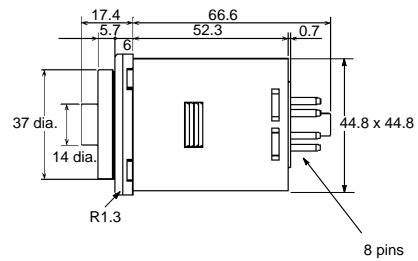
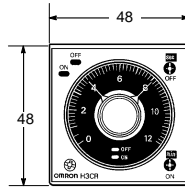
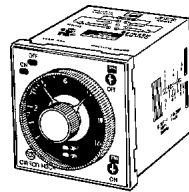

Dimensions with Front Connecting Socket

P2CF-08-□/ P2CF-11-□

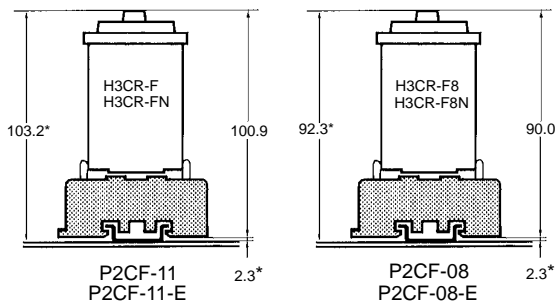

Dimensions with Back Connecting Socket

P3G-08/P3GA-11

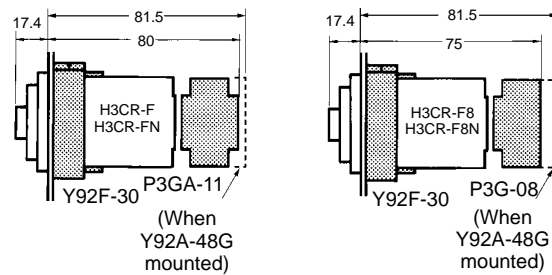

*These dimensions vary with the kind of DIN track (reference value).

Installation

Terminal Arrangement

H3CR-F8
H3CR-F8N
H3CR-F8-300
H3CR-F8N-300

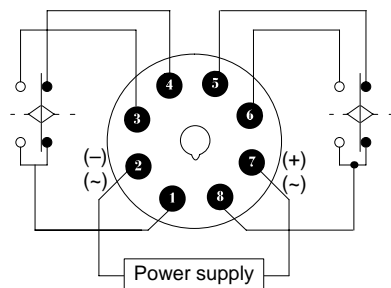

H3CR-F
H3CR-FN
H3CR-F-300
H3CR-FN-300

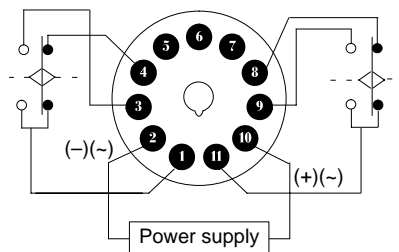

Note: Leave terminals 5, 6, and 7 open.
Do not use them as relay terminals.

Solid-state Star-delta Timer

H3CR-G

DIN 48 x 48-mm Star-delta Timer

- A wide star-time range (up to 120 seconds) and star-delta transfer time range (up to 0.5 seconds).



Ordering Information

Outputs	Supply voltage	8-pin models
Time-limit contact	100 to 120 VAC	H3CR-G8L
	200 to 240 VAC	
Time-limit contact and instantaneous contact	100 to 120 VAC	H3CR-G8EL
	200 to 240 VAC	

Note: Specify both the model number and supply voltage when ordering.

Example: H3CR-G8L 100 to 120 VAC

Supply voltage

Model Number Legend:

H3CR -
 1 2 3 4

1. Classification

G: Star-delta timer

2. Configuration

8: 8-pin socket

3. Outputs

None: Star-delta operation contact

E: Star-delta operation contact and instantaneous contact

4. Dimensions

L: Long-body model

■ Accessories (Order Separately)

Name/specifications		Models
Flush Mounting Adapter		Y92F-30
		Y92F-70
		Y92F-71
Mounting Track	50 cm (l) x 7.3 mm (t)	PFP-50N
	1 m (l) x 7.3 mm (t)	PFP-100N
	1 m (l) x 16 mm (t)	PFP-100N2
End Plate		PFP-M
Spacer		PFP-S
Protective Cover		Y92A-48B
Track Mounting/ Front Connecting Socket	8-pin	P2CF-08
	8-pin, finger safe type	P2CF-08-E
Back Connecting Socket	8-pin	P3G-08
	8-pin, finger safe type	P3G-08 with Y92A-48G (see note 1)
Time Setting Ring	Setting a specific time	Y92S-27
	Limiting the setting range	Y92S-28
Panel Cover (see note 2)	Light gray (5Y7/1)	Y92P-48GL
	Black (N1.5)	Y92P-48GB
	Medium gray (5Y5/1)	Y92P-48GM
Hold-down Clip (see note 3)	For PL08 and PL11 Sockets	Y92H-1
	For PF085A Socket	Y92H-2

- Note:**
1. Y92A-48G is a finger safe terminal cover which is attached to the P3G-08 Socket.
 2. The Time Setting Ring and Panel Cover are sold together.
 3. Hold-down Clips are sold in sets of two.

Specifications

■ General

Item	H3CR-G8L	H3CR-G8EL
Functions	Star-delta timer	Star-delta timer with instantaneous output
Pin type	8-pin	
Operating/Reset method	Time-limit operation/Self-reset	
Output type	Time-limit: SPST-NO (star operation circuit) SPST-NO (delta operation circuit)	Time-limit: SPST-NO (star operation circuit) SPST-NO (delta operation circuit) Instantaneous: SPST-NO
Mounting method	DIN track mounting, surface mounting, and flush mounting	
Approved standards	UL508, CSA C22.2 No.14, NK, Lloyds Conforms to EN61812-1 (VDE0435/P2021), IEC60664-1 (VDE0110) 4kV/2, and EN60947-5-1 (for contact output).	

■ Time Ranges

Time unit	Star operation time ranges	
Full scale setting	6	0.5 to 6 s
	12	1 to 12 s
	60	5 to 60 s
	120	10 to 120 s

Star-delta transfer time	Programmable at 0.05 s, 0.1 s, 0.25 s or 0.5 s
--------------------------	--

■ Ratings

Rated supply voltage	100 to 120 VAC (50/60 Hz), 200 to 240 VAC (50/60 Hz)
Operating voltage range	85% to 110% of rated supply voltage
Power reset	Minimum power-opening time: 0.5 s
Power consumption	100 to 120 VAC: approx. 6 VA (2.6 W) at 120 VAC 200 to 240 VAC: approx. 12 VA (3.0 W) at 240 VAC
Control outputs	Relay output: 5 A at 250 VAC/30 VDC, resistive load ($\cos\phi = 1$)

■ Characteristics

Accuracy of operating time	±0.2% FS max.	
Setting error	±5% FS ±50 ms max.	
Accuracy of Star-delta transfer time	±25% FS + 5 ms max.	
Reset voltage	10 % max. of rated voltage	
Influence of voltage	±0.2% FS max.	
Influence of temperature	±1% FS max.	
Insulation resistance	100 MΩ min. (at 500 VDC)	
Dielectric strength	2,000 VAC, 50/60 Hz for 1 min (between current-carrying metal parts and exposed non-current-carrying metal parts) 2,000 VAC, 50/60 Hz for 1 min (between control output terminals and operating circuit) 2,000 VAC, 50/60 Hz for 1 min (between contacts of different polarities) 1,000 VAC, 50/60 Hz for 1 min (between contacts not located next to each other)	
Impulse withstand voltage	3 kV (between power terminals) 4.5 kV (between current-carrying terminal and exposed non-current-carrying metal parts)	
Noise immunity	±1.5 kV (between power terminals), square-wave noise by noise simulator (pulse width: 100 ns/1 μs, 1-ns rise)	
Static immunity	Malfunction: 8 kV Destruction: 15 kV	
Vibration resistance	Destruction: 10 to 55 Hz with 0.75-mm single amplitude for 2 hrs each in three directions Malfunction: 10 to 55 Hz with 0.5-mm single amplitude for 10 min each in three directions	
Shock resistance	Destruction: 980 m/s ² three times each in six directions Malfunction: 294 m/s ² three times each in six directions	
Ambient temperature	Operating: -10°C to 55°C (with no icing) Storage: -25°C to 65°C (with no icing)	
Ambient humidity	Operating: 35% to 85%	
Life expectancy	Mechanical: 20 million operations min. (under no load at 1,800 operations/h) Electrical: 100,000 operations min. (5 A at 250 VAC, resistive load at 1,800 operations/h)	
EMC	(EMI) Emission Enclosure: Emission AC Mains: (EMS) Immunity ESD: Immunity RF-interference from AM Radio Waves: Immunity RF-interference from Pulse-modulated Radio Waves: Immunity Conducted Disturbance: ENV50141: Immunity Burst: Immunity Surge:	EN50081-2 EN55011 Group 1 class A EN55011 Group 1 class A EN50082-2 EN61000-4-2: 4 kV contact discharge (level 2) 8 kV air discharge (level 3) ENV50140: 10 V/m (80 MHz to 1 GHz) (level 3) ENV50204: 10 V/m (900±5 MHz) (level 3) 10 V (0.15 to 80 MHz) (level 3) EN61000-4-4: 2 kV power-line (level 3) 2 kV I/O signal-line (level 4) EN61000-4-5: 1 kV line to line (level 3) 2 kV line to ground (level 3)
Case color	Light Gray (Munsell 5Y7/1)	
Enclosure ratings	IP40 (panel surface)	
Weight	H3CR-G8L: approx. 110 g; H3CR-G8EL: approx. 130 g	

Engineering Data

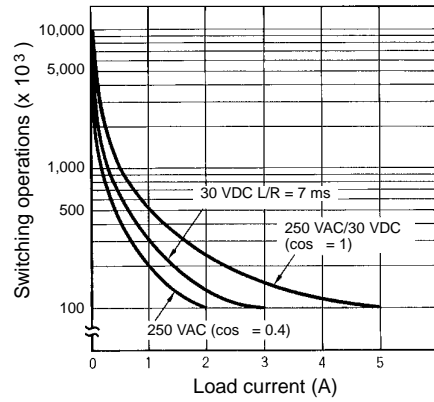

Reference: A maximum current of 0.15 A can be switched at 125 VDC (cos = 1) and a maximum current of 0.1 A can be switched if L/R is 7 ms. In both cases, a life of 100,000 operations can be expected. The minimum applicable load is 10 mA at 5 VDC (failure level: P).

Nomenclature

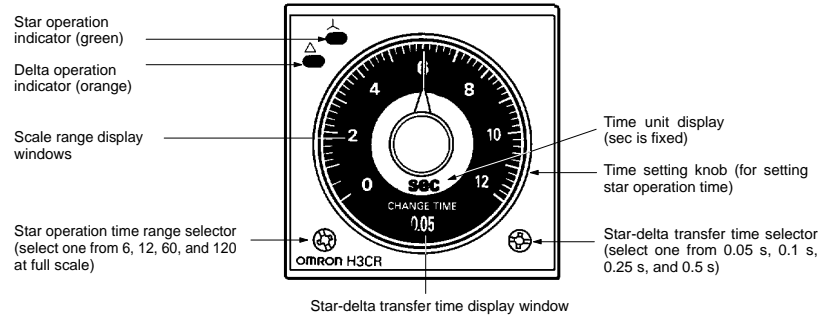

Operation

■ Block Diagrams

H3CR-G8L

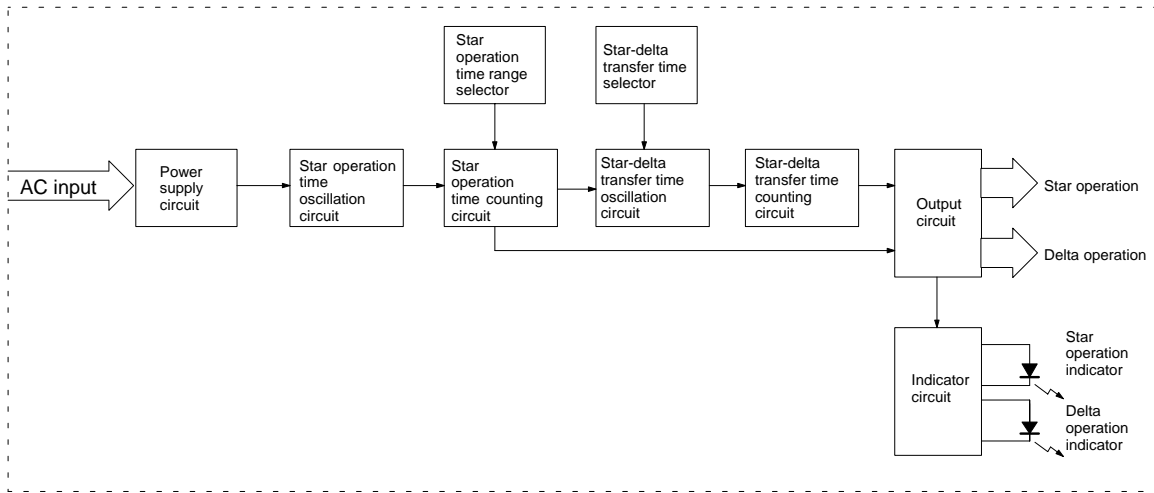

H3CR-G8EL

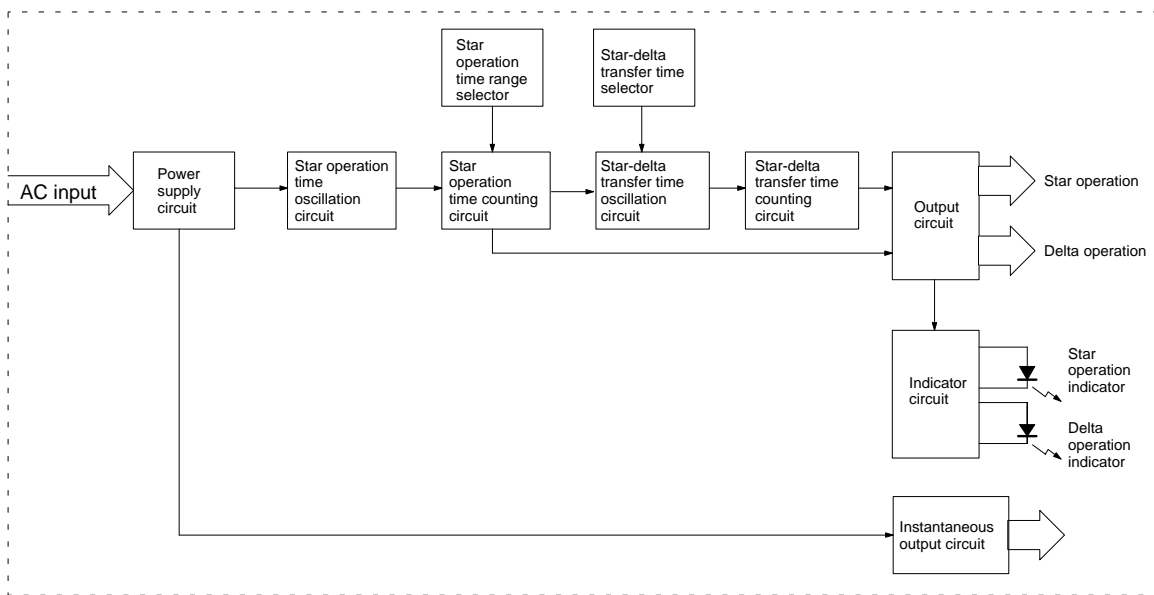

■ I/O Functions

Inputs		---
Outputs	Control output	If the time reaches the value set with the time setting knob, the star operation output will be turned OFF and there will be delta operation output after the set star-delta transfer time has elapsed.

■ Timing Chart

t1: Star operation time setting
 t2: Star-delta transfer time

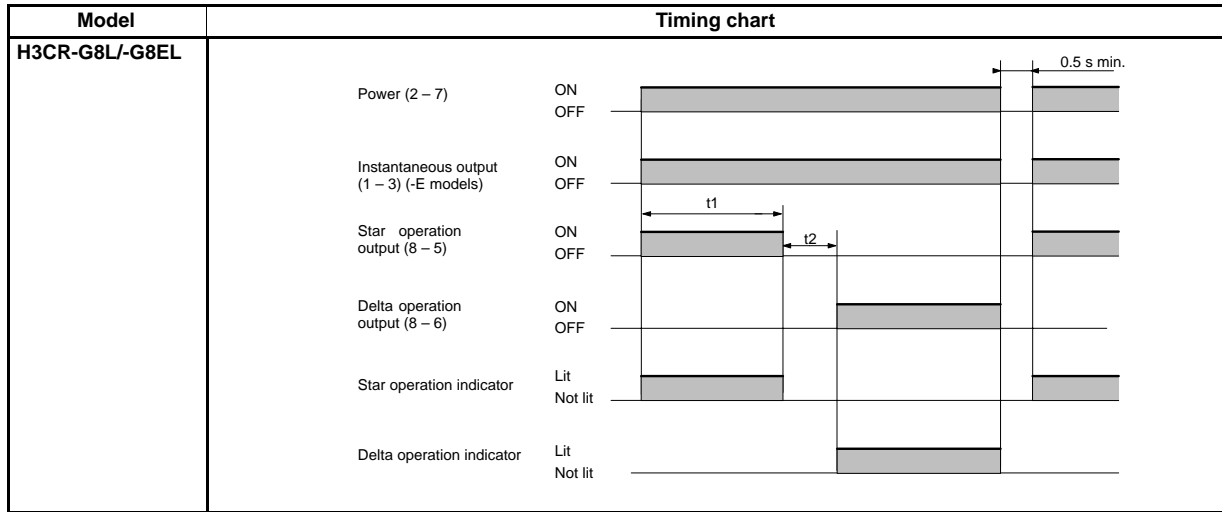

Dimensions

Note: All units are in millimeters unless otherwise indicated.

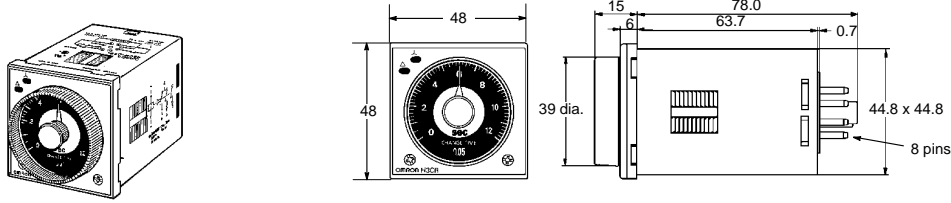

Dimensions with Set Ring

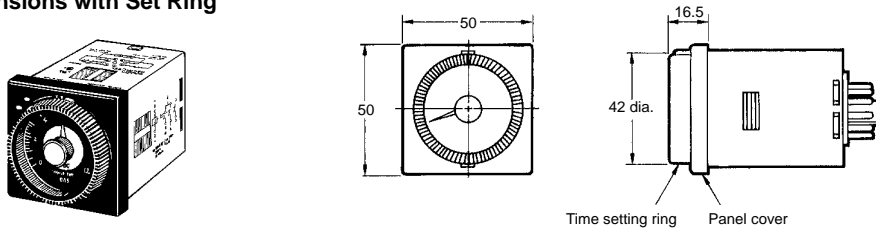

Dimensions with Front Connecting Socket P2CF-08-□

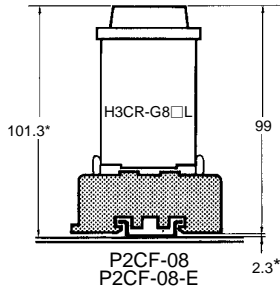

Dimensions with Back Connecting Socket P3G-08

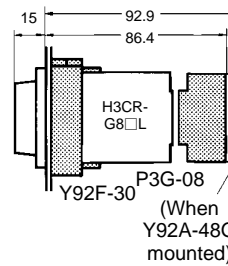

*These dimensions vary with the kind of DIN track (reference value).

Installation

Terminal Arrangement

H3CR-G8L

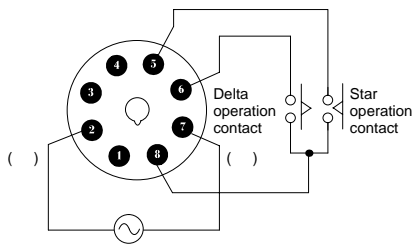

Note: Leave terminals 1, 3, and 4 open. Do not use them as relay terminals.

H3CR-G8EL

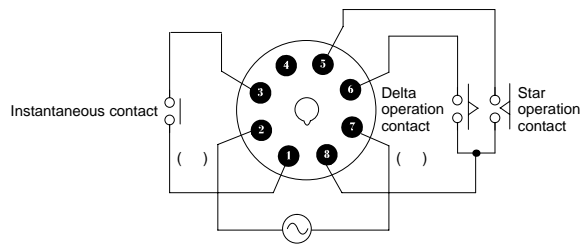

Note: Leave terminal 4 open. Do not use them as relay terminals.

Solid-state Power OFF-delay Timer

H3CR-H

DIN 48 x 48-mm Power OFF-delay Timer

- Long power OFF-delay times;
S-series: up to 12 seconds,
M-series: up to 12 minutes.
- Models with forced-reset input are available.
- 11-pin and 8-pin models are available.



Ordering Information

Input	Output	Supply voltage	S-series		M-series	
			11-pin models	8-pin models	11-pin models	8-pin models
---	DPDT	100 to 120 VAC	---	H3CR-H8L	---	H3CR-H8L
		200 to 240 VAC				
		24 VAC/DC				
		48 VDC				
		100 to 125 VDC				
With reset input	DPDT	100 to 120 VAC	H3CR-HRL	---	H3CR-HRL	---
		200 to 240 VAC				
		24 VAC/DC				
		48 VDC				
		100 to 125 VDC				
	SPDT	100 to 120 VAC	---	H3CR-H8RL	---	H3CR-H8RL
		200 to 240 VAC				
		24 VAC/DC				
		48 VDC				
		100 to 125 VDC				

Note: Specify both the supply voltage and time unit code (S or M) in addition to the model number when ordering.

Example: H3CR-H8L 24 VAC/DC M

Time unit code

Supply voltage

Model Number Legend:

H3CR -
 1 2 3 4

1. Classification

H: Power OFF-delay timer

2. Configuration

None: 11-pin socket

8: 8-pin socket

3. Input

None: Without reset input

R: With reset input

4. Dimensions

L: Long-body model

■ Accessories (Order Separately)

Name/specifications		Models
Flush Mounting Adapter		Y92F-30
		Y92F-70
		Y92F-71
Mounting Track	50 cm (∅) x 7.3 mm (t)	PFP-50N
	1 m (∅) x 7.3 mm (t)	PFP-100N
	1 m (∅) x 16 mm (t)	PFP-100N2
End Plate		PFP-M
Spacer		PFP-S
Protective Cover		Y92A-48B
Track Mounting/ Front Connecting Socket	8-pin	P2CF-08
	8-pin, finger safe type	P2CF-08-E
	11-pin	P2CF-11
	11-pin, finger safe type	P2CF-11-E
Back Connecting Socket	8-pin	P3G-08
	8-pin, finger safe type	P3G-08 with Y92A-48G (see note 1)
	11-pin	P3GA-11
	11-pin, finger safe type	P3GA-11 with Y92A-48G (see note 1)
Hold-down Clip (see note 2)	For PL08 and PL11 Sockets	Y92H-1
	For PF085A Socket	Y92H-2

Note: 1. Y92A-48G is a finger safe terminal cover which is attached to the P3G-08 or P3GA-11 Socket.
2. Hold-down Clips are sold in sets of two.

Specifications

■ General

Item	H3CR-H8L	H3CR-H8RL	H3CR-HRL
Operating/Reset method	Instantaneous operation/Time-limit reset	Instantaneous operation/Time-limit reset/Forced reset	
Pin type	8-pin		11-pin
Input type	---	No-voltage	
Output type	Relay output (DPDT)	Relay output (SPDT)	Relay output (DPDT)
Mounting method	DIN track mounting, surface mounting, and flush mounting		
Approved standards	UL508, CSA C22.2 No.14, NK, Lloyds Conforms to EN61812-1 (VDE0435/P2021), IEC60664-1 (VDE0110) 4kV/2, and EN60947-5-1 (for contact output).		

■ Time Ranges

Time unit	S-series		M-series
	s (sec)		min
Setting	0.6	0.05 to 0.6	
	1.2	0.1 to 1.2	
	6	0.5 to 6	
	12	1 to 12	
Min. power ON time	0.1 s min.		2 s min.

Note: If the above minimum power ON time is not secured, the H3CR may not operate. Be sure to secure the above minimum power ON time.

■ Ratings

Rated supply voltage (see note 1)	100 to 120 VAC (50/60 Hz), 200 to 240 VAC (50/60 Hz), 24 VAC/VDC (50/60 Hz), 48 VDC, 100 to 125 VDC
Operating voltage range	85% to 110% of rated supply voltage
No-voltage input (see note 2)	ON-impedance: 1 k Ω max. ON residual voltage: 1 V max. OFF impedance: 500 k Ω min.
Power consumption	100 to 120 VAC: approx. 0.23 VA (0.22 W) at 120 VAC 200 to 240 VAC: approx. 0.35 VA (0.3 W) at 240 VAC 24 VAC/DC: approx. 0.17 VA (0.15 W) at 24 VAC approx. 0.1 W at 24 VDC 48 VDC: approx. 0.18 W at 48 VDC 100 to 125 VDC: approx. 0.5 W at 125 VDC
Control outputs	Contact output: 5 A at 250 VAC/30 VDC, resistive load ($\cos\phi = 1$)

Note: 1. A power supply with a ripple of 20% max. (single-phase power supply with full-wave rectification) can be used with each DC Model.
2. For contact input, use contacts which can adequately switch 0.1 mA at 5 V.

■ Characteristics

Accuracy of operating time	±0.2% FS max. (±0.2% FS ±10 ms max. in ranges of 0.6 and 1.2 s)
Setting error	±5% FS ±50 ms max.
Operation start voltage	30 % max. of rated voltage
Influence of voltage	±0.2% FS max. (±0.2% FS ±10 ms max. in ranges of 0.6 and 1.2 s)
Influence of temperature	±1% FS max. (±1% FS ±10 ms max. in ranges of 0.6 and 1.2 s)
Insulation resistance	100 MΩ min. (at 500 VDC)
Dielectric strength	2,000 VAC, 50/60 Hz for 1 min (between current-carrying metal parts and exposed non-current-carrying metal parts) 2,000 VAC, 50/60 Hz for 1 min (between control output terminals and operating circuit) 2,000 VAC, 50/60 Hz for 1 min (between contacts of different polarities) 1,000 VAC, 50/60 Hz for 1 min (between contacts not located next to each other)
Impulse withstand voltage	3 kV (between power terminals) for 100 to 120 VAC, 200 to 240 VAC, 100 to 125 VDC; 1 kV for 24 VAC/DC, 48 VDC 4.5 kV (between current-carrying terminal and exposed non-current-carrying metal parts) for 100 to 120 VAC, 200 to 240 VAC, 100 to 125 VDC; 1.5 kV for 24 VAC/DC, 48 VDC
Noise immunity	±1.5 kV (between power terminals) and ±600 V (between input terminals), square-wave noise by noise simulator (pulse width: 100 ns/1 s, 1-ns rise); ±1 kV (between power terminals) for 48 VDC
Static immunity	Malfunction: 8 kV Destruction: 15 kV
Vibration resistance	Destruction: 10 to 55 Hz with 0.75-mm single amplitude for 2 hrs each in three directions Malfunction: 10 to 55 Hz with 0.5-mm single amplitude for 10 min each in three directions
Shock resistance	Destruction: 980 m/s ² three times each in six directions Malfunction: 98 m/s ² three times each in six directions
Ambient temperature	Operating: -10°C to 55°C (with no icing) Storage: -25°C to 65°C (with no icing)
Ambient humidity	Operating: 35% to 85%
Life expectancy	Mechanical: 10 million operations min. (under no load at 1,200 operations/h) Electrical: 100,000 operations min. (5 A at 250 VAC, resistive load at 1,200 operations/h)
EMC	(EMI) EN50081-2 Emission Enclosure: EN55011 Group 1 class A Emission AC Mains: EN55011 Group 1 class A (EMS) EN50082-2 Immunity ESD: EN61000-4-2: 4 kV contact discharge (level 2) 8 kV air discharge (level 3) Immunity RF-interference from AM Radio Waves: ENV50140: 10 V/m (80 MHz to 1 GHz) (level 3) Immunity RF-interference from Pulse-modulated Radio Waves: ENV50204: 10 V/m (900±5 MHz) (level 3) Immunity Conducted Disturbance: ENV50141: 10 V (0.15 to 80 MHz) (level 3) Immunity Burst: EN61000-4-4: 2 kV power-line (level 3) 2 kV I/O signal-line (level 4) Immunity Surge: EN61000-4-5: 1 kV line to line (level 3) 2 kV line to ground (level 3)
Case color	Light Gray (Munsell 5Y7/1)
Enclosure ratings	IP40 (panel surface)
Weight	Approx. 120 g

Engineering Data

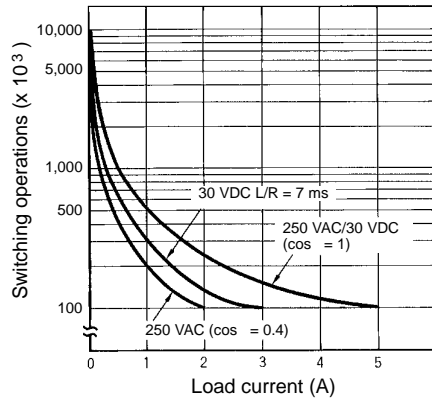

Reference: A maximum current of 0.15 A can be switched at 125 VDC (cos = 1) and a maximum current of 0.1 A can be switched if L/R is 7 ms. In both cases, a life of 100,000 operations can be expected. The minimum applicable load is 10 mA at 5 VDC (failure level: P).

Nomenclature

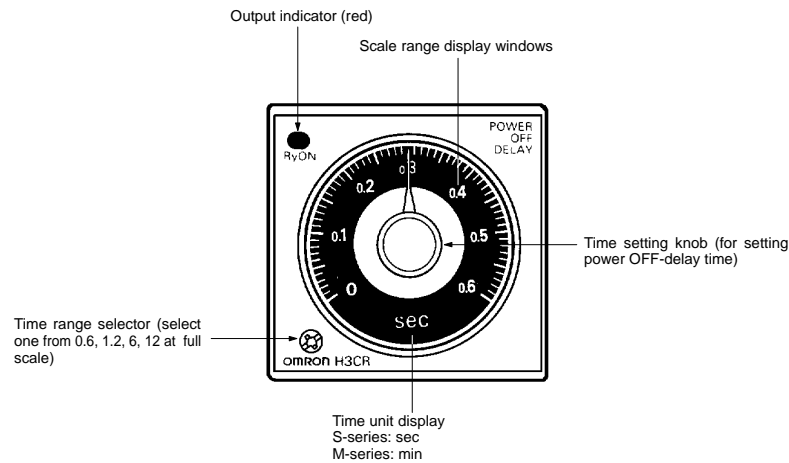

Operation

■ Block Diagrams

Without Reset Input (H3CR-H8L)

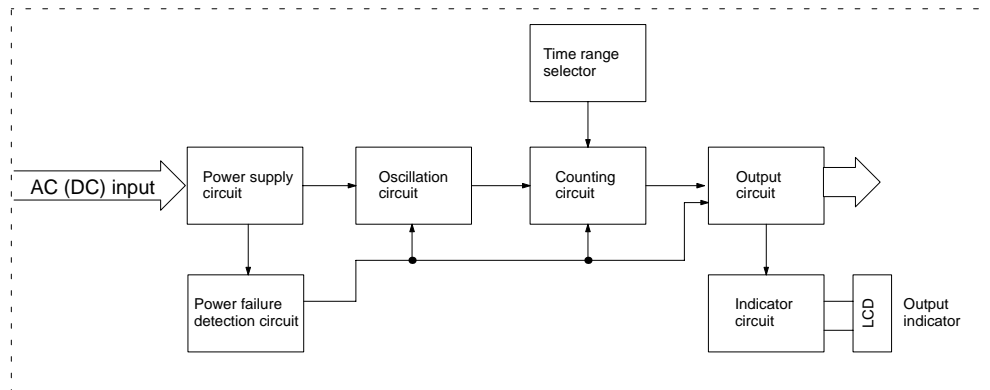

With Reset Input (H3CR-H8RL/H8L)

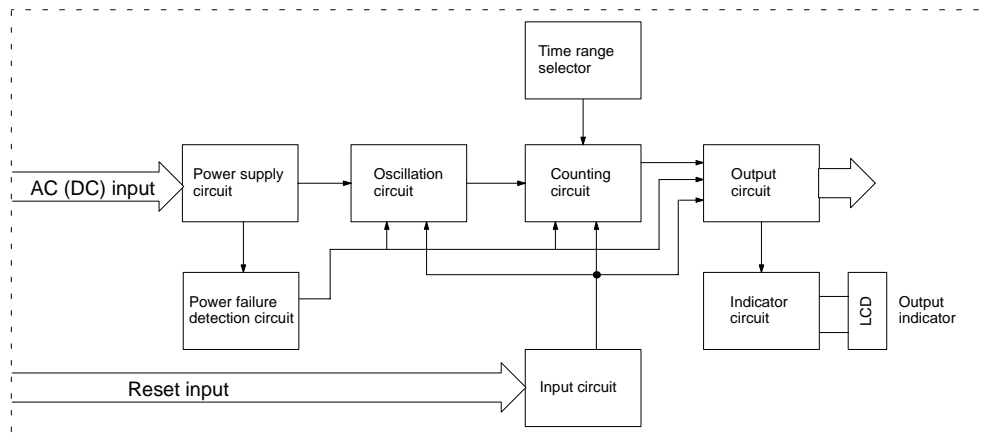

■ I/O Functions

Inputs	Reset	Turns off the control output and resets the elapsed time.
Outputs	Control output	Operates instantaneously when the power is turned on and time-limit resets when the set time is up after the power is turned off.

■ Timing Chart

t: Set time

Rt: Minimum power ON time (S-series: 0.1 s min.; M-series: 2 s min.)

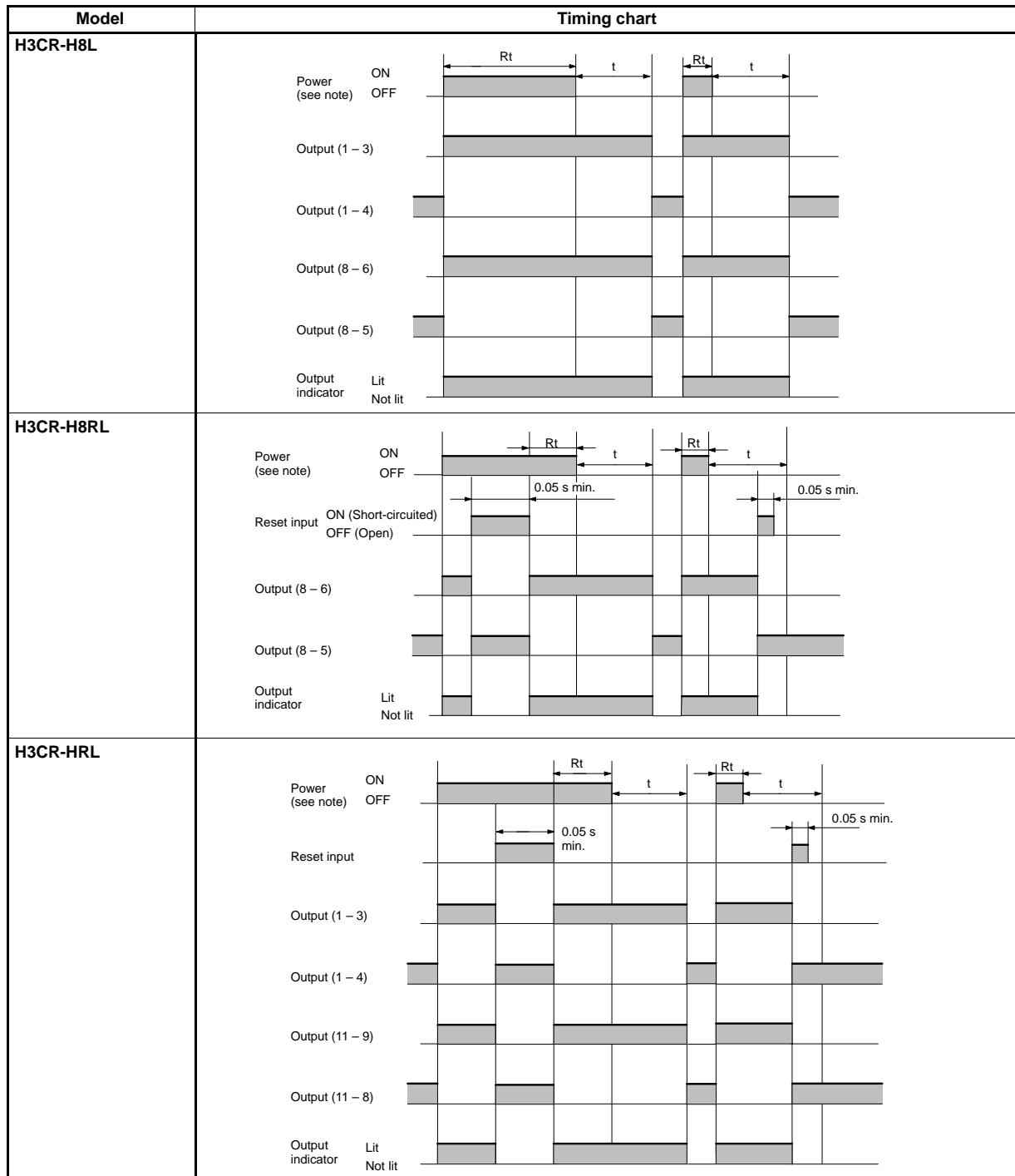

Note: If the power is turned ON until the set time is up, the timer will be retriggered.

Dimensions

Note: All units are in millimeters unless otherwise indicated.

H3CR-H8L H3CR-H8RL

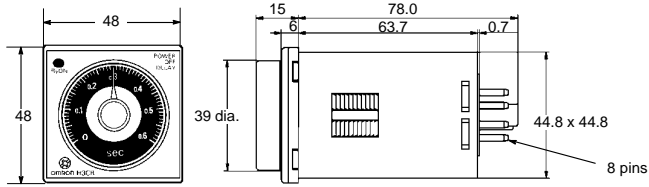
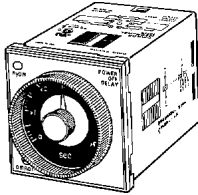

H3CR-HRL

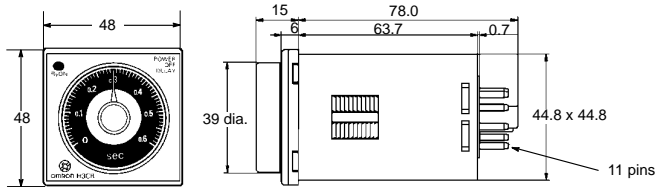
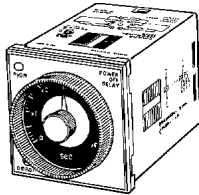

Dimensions with Front Connecting Socket P2CF-08-□/ P2CF-11-□

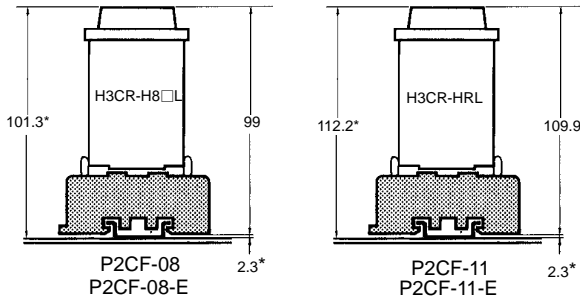

Dimensions with Back Connecting Socket P3G-08/P3GA-11

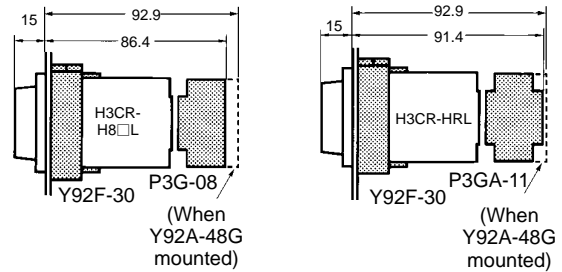

*These dimensions vary with the kind of DIN track (reference value).

Installation

■ Terminal Arrangement

Note: DC models, including 24 VAC/DC models, have polarity.

8-pin Models

Without Reset Input (H3CR-H8L)

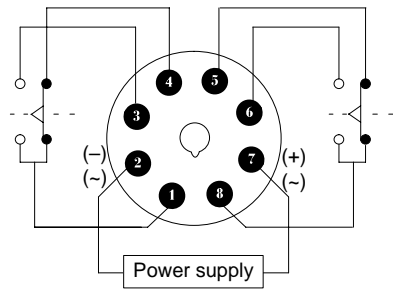

With Reset Input (H3CR-H8RL)

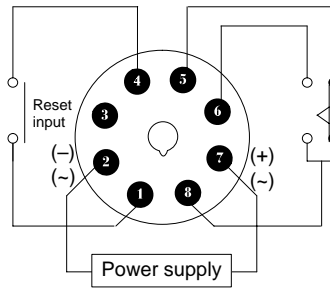

Note: Leave terminal 3 open. Do not use them as relay terminals.

11-pin Model

With Reset Input (H3CR-HRL)

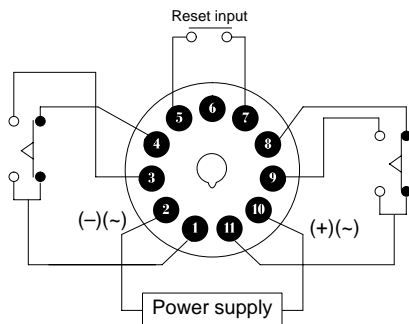

Note: Leave terminal 6 open. Do not use them as relay terminals.

Operation

Note: The undermentioned is common for all H3CR models.

Basic Setting

Setting of Selectors

The selectors can be turned clockwise and counterclockwise to select the desired time unit, time range, or operating mode. Each selector has a snap mechanism that secures the selector at a given position. Set the selector at a position at which it is secured. Do not set it midway between two securing positions or a malfunction could result from improper setting.

Selection of Operating Mode

• H3CR-A Multifunctional Timer

Turn the operating mode selector with a screwdriver until the desired operating mode (H3CR-A/AP/AS: A, B, B2, C, D, or E, H3CR-A8/A8S/A8E: A, B2, E or J, H3CR-A-300: G or J) appears in the display window located above the selector.

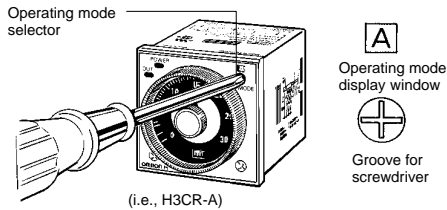

Selection of Time Unit and Time Range

• H3CR-A Multifunctional Timer

The desired time unit (sec, min, hrs, or 10h) is displayed in the window below the time setting knob by turning the time unit selector located at the lower right corner of the front panel. A time range (1.2, 3, 12, or 30/2.4, 6, 24, or 60 for H3CR-A□-301) is selected with the time range selector at the lower left corner of the front panel, and the selected time range appears (in the window at the lower right part) within the plastic frame of the time setting knob.

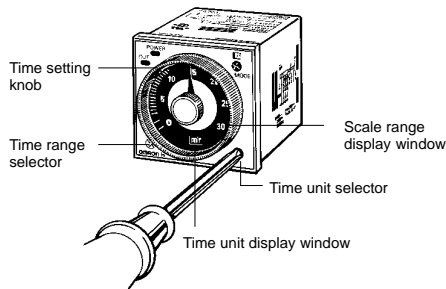

• H3CR-F Twin Timers

A time range (0 to 1.2, 0 to 3, 0 to 12, or 0 to 30) is selected for ON- and OFF-time using the time range selector at the lower left corner of the front panel, and the selected time range appears within the plastic frame of the time setting knob (= scale range display windows).

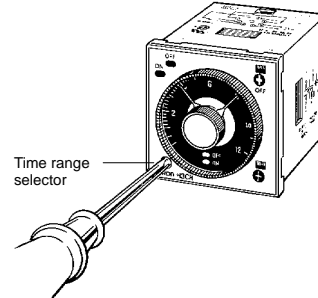

For ON-time, the desired time unit (sec, 10 s, min, and hrs, or 10 s, 10 min, hrs, and 10 h) is indicated in the ON-time unit display window at the lower right corner of the front panel and can be changed by turning the ON-time unit selector located below the ON-time unit display window.

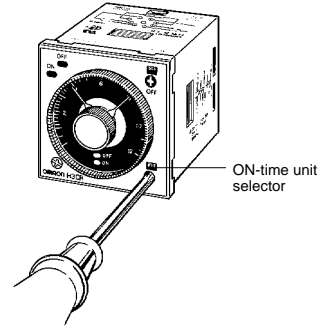

For OFF-time, the desired time unit (sec, 10 s, min, and hrs, or 10 s, 10 min, hrs, and 10 h) is indicated in the OFF-time unit display window at the upper right corner of the front panel and can be changed by turning the OFF-time unit selector located below the OFF-time unit display window.

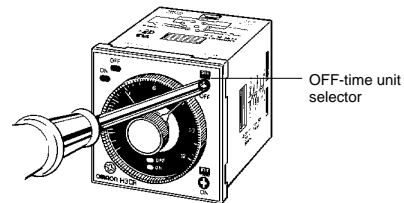

• H3CR-G Star-delta Timers

A star operation time range (0 to 6, 0 to 12, 0 to 60, or 0 to 120 seconds) is selected with the star operation time range selector at the lower left corner of the front panel.

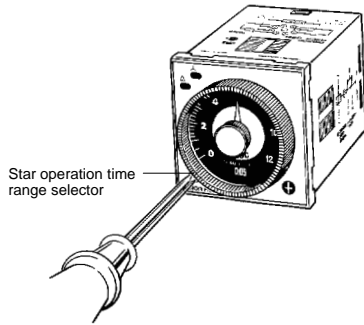

The time required for switching (0.05, 0.1, 0.25, or 0.5 second) from the star operation to the delta operation of the H3CR-G can be selected with the star-delta transfer time selector at the lower right corner of the front panel.

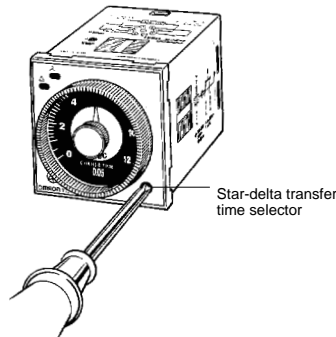

• H3CR-H Power OFF-delay Timers

A time range (0 to 0.6, 0 to 1.2, 0 to 6, and 0 to 12) is selected with the time range selector at the lower left corner of the front panel. No time unit selector is available. When ordering the H3CR-H, specify S (for the second unit) or M (for the minute unit) for your H3CR-H.

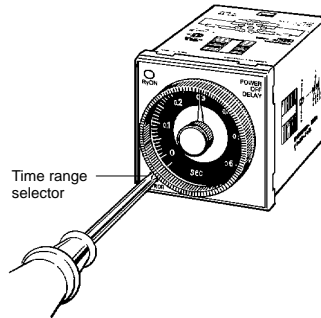

Setting of Time

Use the time setting knob to set the desired time.

■ Using the Time Setting Ring for H3CR-A/G

Setting a Specific Time

Mount the Panel Cover on the Timer, set the desired time with the time setting knob, and place Time Setting Ring A onto the time setting knob so that the time setting notch of Time Setting Ring A is in the center of the reset lock position of the Panel Cover.

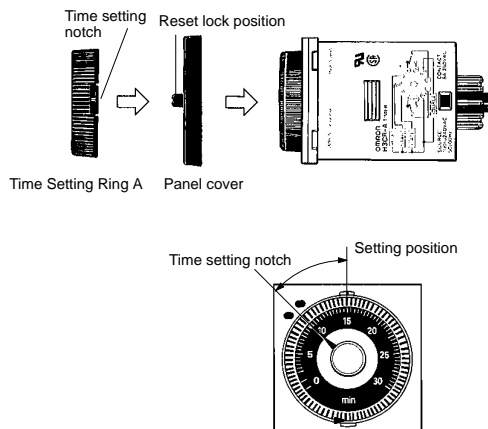

Example: To set the time to 10 s.

Limiting the Setting Range

Example: To set a range of 10 and 20 s. Mount the Panel Cover on the Timer, set the time setting knob to 10 s (the lower limit of the setting range), and place Time Setting Ring C onto the time setting knob so that the stopper of Time Setting Ring C is on the right edge of the reset lock position of the Panel cover. Next, set the time setting knob to 20 s (the upper limit of the setting range), place Time Setting Ring B onto the time setting knob so that the stopper of Time Setting Ring B is on the left edge of the reset lock position of the Panel Cover.

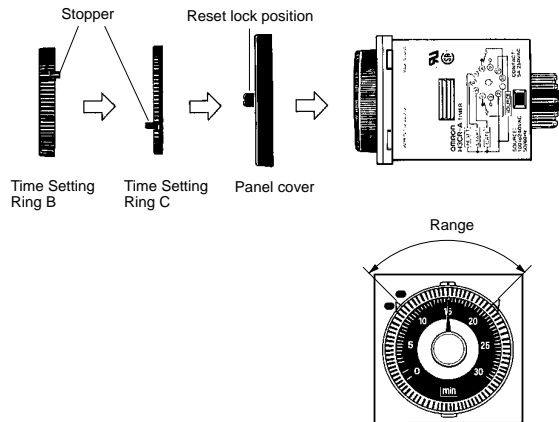

Accessories (Order Separately)

Note: The undermentioned is common for all H3CR models.

Note: All units are in millimeters unless otherwise indicated.

Flush Mounting Adaptor

Y92F-30

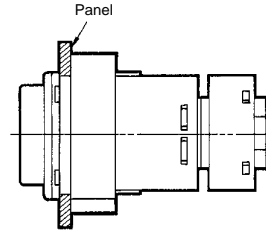
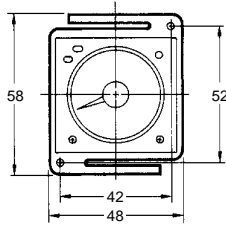
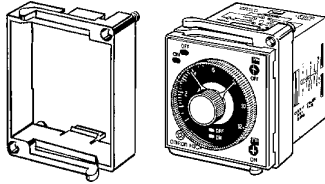

Note: The adapters for two or more timers mounted in a vertical line are different in orientation from those mounted in a horizontal line.

N can be obtained as follows (n: the number of H3CR models arranged side by side)

Without a Cover: $N = (48n - 2.5) +1/-0$

With the Protective Cover: $N = (51n - 5.5) +1/-0$

With the Panel Cover: $N = (50n - 4.5) +1/-0$

Panel Cutout

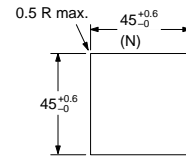

Y92F-70/-73

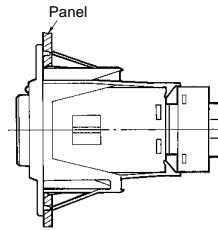
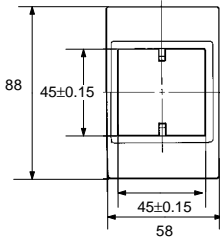
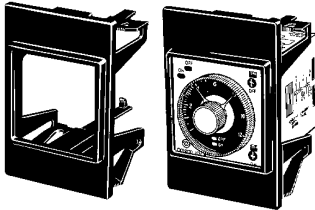

Panel Cutout

Adapter mounting hole Two, 4.5 dia.

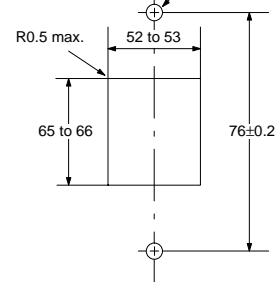

Y92F-71/-74

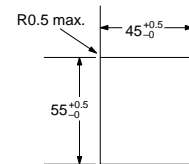
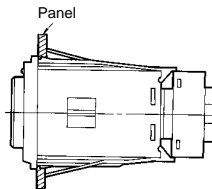
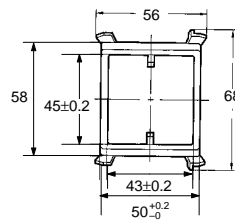
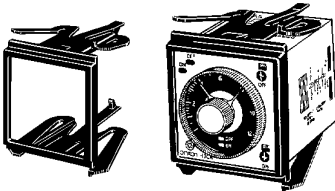

Note: The mounting panel thickness should be 1 to 3.2 mm.

Note: The mounting panel thickness should be 1 to 3.2 mm.

Track Mounting/Front Connecting Socket

P2CF-08

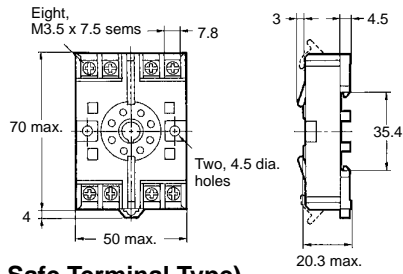
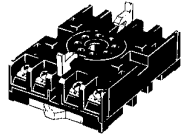

**Terminal Arrangement/
Internal Connections
(Top View)**

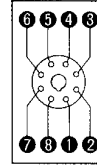

Surface Mounting Holes

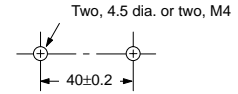

P2CF-08-E (Finger Safe Terminal Type)

Conforming to VDE0106/P100

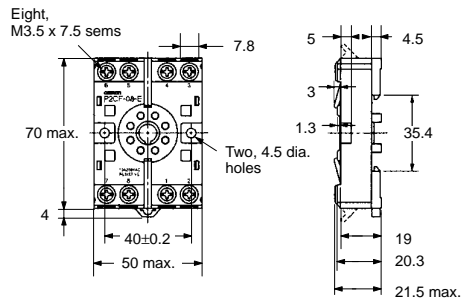
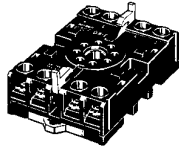

**Terminal Arrangement/
Internal Connections
(Top View)**

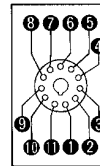

Surface Mounting Holes

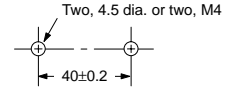

Track Mounting/Front Connecting Socket

P2CF-11

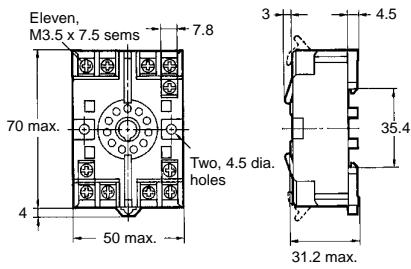
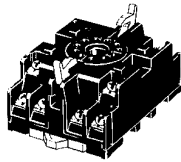

**Terminal Arrangement/
Internal Connections
(Top View)**

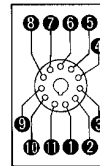

Surface Mounting Holes

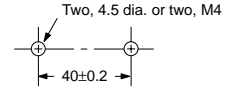

P2CF-11-E (Finger Safe Terminal Type)

Conforming to VDE0106/P100

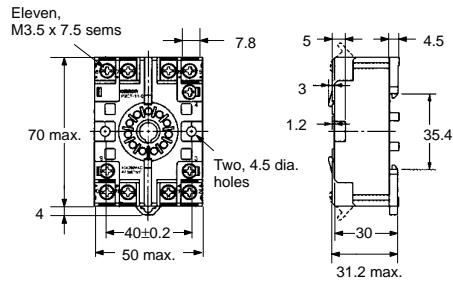
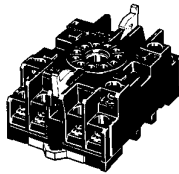

Back Connecting Socket
P3G-08

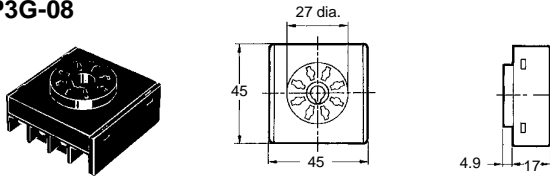

**Terminal Arrangement/
Internal Connections
(Bottom View)**

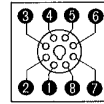

P3GA-11

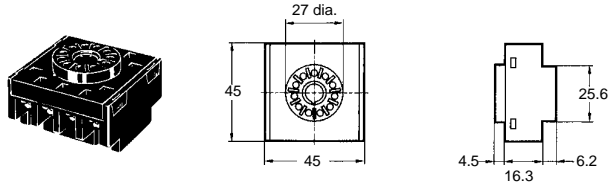

**Terminal Arrangement/
Internal Connections
(Bottom View)**

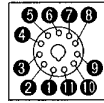

Finger Safe Terminal Cover
Conforming to VDE0106/P100

Y92A-48G

(Attachment for P3G-08/P3GA-11 Socket)

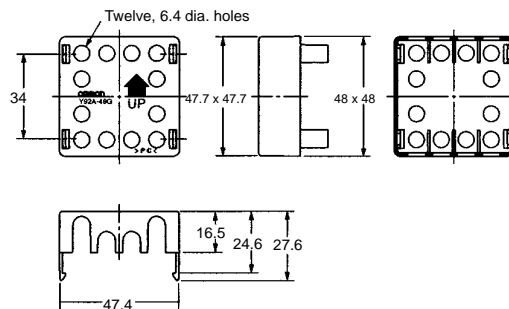
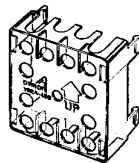

Mounting Track
PFP-100N, PFP-50N

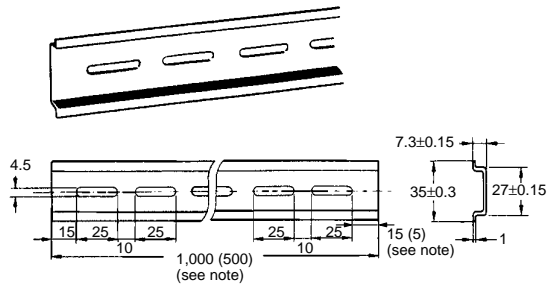

PFP-100N2

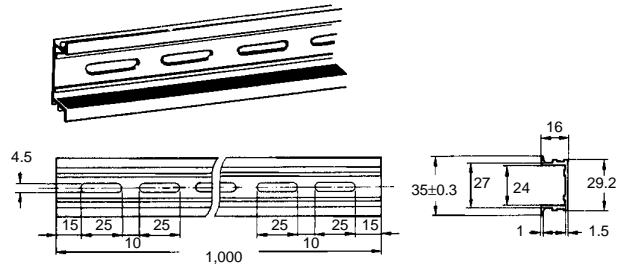

Note: The value shown in parentheses are for the PFP-50N.

End Plate
PFP-M

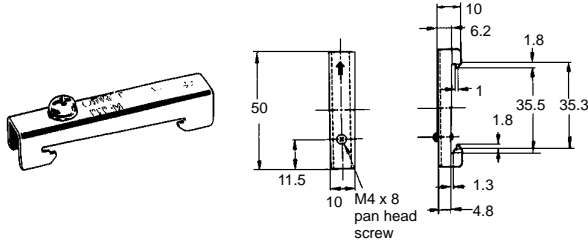

Spacer
PFP-S

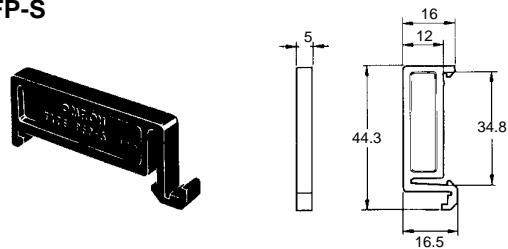

**Protective Cover
Y92A-48B**

The protective cover protects the front panel, particularly the time setting section, against dust, dirt, and water. It also prevents the set value from being altered due to accidental contact with the time setting knob.

- Note:**
1. The Y92A-48B Protective Cover is made of a hard plastic and therefore it must be removed to change the timer set value.
 2. The Protective Cover cannot be mounted if the Panel Cover (sold separately) is used on the Timer.

Y92A-48B

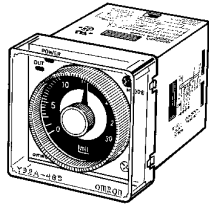

Hold-down Clip

Hold-down clips are sold in sets of two.

Y92H-7/-1
For PL08 and PL11 Sockets

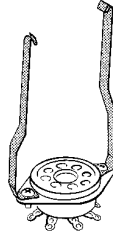

Y92H-8/-2
For PF085A Socket

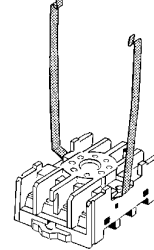

Time Setting Ring/Panel Cover for H3CR-A/-G

There are three types of Panel Covers (Y92P-48GL, Y92P-48GB, and Y92P-48GM), all of which are available in three colors. Use the most suitable type of Panel Cover with the design of the scaling plate according to the application.

When setting a given time for the Timer, use of the Y92S-27 or Y92S-28 Time Setting Ring facilitates the time setting operation and minimizes possible setting errors by operators.

The Y92F-73 or Y92F-74 Flush Mounting Adapter or the Protective Cover cannot be used.

The Time Setting Ring and Panel Cover should be used as a pair.

Setting a specific time	Time Setting Ring A (Y92S-27) and Panel Cover (Y92P-48GL, -48GB, or -48GM)
Limiting the setting range	Time Setting Ring B or C (Y92S-28), and Panel Cover (Y92P-48GL, -48GB, or -48GM)

Y92S-27
Time Setting A



Y92S-28
Time Setting B



Y92S-28
Time Setting C



Y92P-48GL
Light Gray

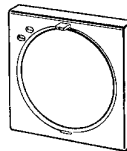

Y92P-48GB
Black

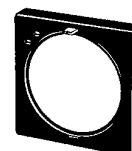

Y92P-48GM
Medium Gray

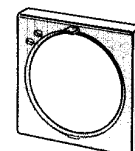

Precautions (Common)

Note: The undermentioned is common for all H3CR models.

■ Changing the Setting

Do not change the time unit, time range, or operation mode while the Timer is in operation, otherwise the Timer may malfunction.

The time unit and time range can be set with the respective selectors turned clockwise or counterclockwise.

The selectors are of notched so that they will snap when they are properly set. Do not set the selectors midway between notches, otherwise the Timer may break or malfunction.

Do not use H3CR-A models (except for H3CR-A□S) in flicker mode, or H3CR-F models at the lowest selector setting. Doing so may result in damage to contacts.

■ Power Supplies

Pay the utmost attention not to make mistakes in polarity when wiring the Timer.

The H3CR Series uses a transformerless power supply. Do not touch the input terminals while the supply voltage is applied, otherwise an electric shock may be received.

A DC power supply can be connected if its ripple factor is 20% or less and the mean voltage is within the rated operating voltage range of the Timer.

An AC power supply can be connected to the power input terminals without regard to polarity. A DC power supply must be connected to the power input terminals as designated according to the polarity of the terminals.

Make sure that the voltage is applied within the specified range, otherwise the internal elements of the Timer may be damaged.

Connect the power supply voltage through a relay or switch in such a way that the voltage reaches a fixed value at once, otherwise the Timer may not be reset or a timer error may result.

Be aware that the operating voltage will rise by 5% if the rated voltage is applied to the Timer continuously while the ambient temperature is close to the maximum permissible ambient temperature.

The power supply circuit of any H3CR-A model (except for H3CR-A□S), H3CR-F 100-to-240-VAC model, and H3CR-G model is a switching circuit. If the power line connected to the power supply circuit has a transformer with high inductance, a counter-electromotive voltage will be induced by the inductance. To suppress the voltage, apply a CR filter to the power supply line.

■ Operating Environment

Do not use the Timer in the following locations.

- Locations with radical temperature changes.
- Locations with high humidity that may result in condensation.
- Locations with excessive vibration or shock.
- Locations with corrosive gas or dust.
- Locations where the Timer is exposed to sprayed water, oil, or chemicals.

Organic solvents (such as paint thinner) as well as strong acid or alkali solutions will damage the outer casing of the Timer.

If the Timer is used in an area with excessive electronic noise, be sure to separate the Timer, wires, and input device as far as possible from the noise sources. Furthermore, it is recommended that the input signal wiring be shielded to prevent electronic interference.

Using a surge absorber is recommended if surge voltages occur.

■ Precautions for EN61812-1 Conformance

The H3CR Series as a built-in timer conforms to EN61812-1 provided that the following conditions are satisfied.

Make sure that no voltage is applied to any terminals before dismantling the Timer from the Socket.

The output section of the H3CR is provided only with basic isolation. Provide supplementary basic isolation on the load side connected to the output so that reinforced isolation required by the EN61812-1 will be ensured.

The H3CR itself is designed under the following conditions:

- Overvoltage category III
- Pollution degree 2
- Isolation
 - Operation parts: Reinforced isolation
 - With clearance of 5.5 mm and creepage distance of 5.5 mm at 230 VAC
 - Output: Basic isolation (see note)
 - With clearance of 3 mm and creepage distance of 3 mm at 230 VAC

Note: The 11-pin model ensures basic isolation by itself and also ensures basic isolation with the 11-pin model mounted to the OMRON P2CF-11-□ or P3GA-11 Socket.

Connect the two output contacts different in polarity to the loads so that they will be the same in potential.

■ Others

If the Timer is mounted to a control board, dismantle the Timer from the control board or short-circuit the control board circuitry before carrying out a voltage withstand test between the electric circuitry and non-charged metal part of the Timer. This protects the internal circuitry of the Timer from damage.

Precautions (H3CR-A)

Note: The undermentioned is common for all H3CR-A models.

■ Power Supplies

For the power supply of an input device of the H3CR-A□/-A□S/AP, use an isolating transformer with the primary and secondary windings mutually isolated and the secondary winding not grounded.

Example: H3CR-A

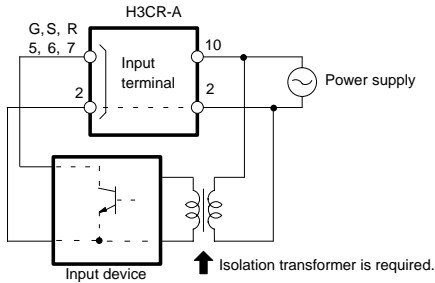

The H3CR-A□/-A□S/AP's power supply terminal 2 is a common terminal for input signals to the Timer. Do not disconnect the wires on terminal 2, otherwise the internal circuitry of the Timer will be damaged.

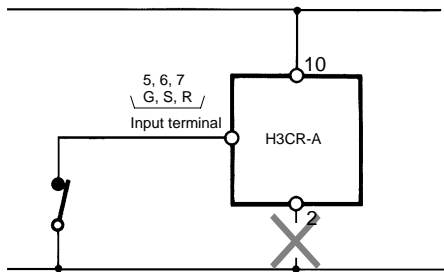

Make sure that the voltage is applied within the specified range, otherwise the internal elements of the Timer may be damaged.

■ Input/Output

Relationship between Input and Power Supply Circuits (except for H3CR-A8E)

The H3CR-A (except for H3CR-A8E) uses transformerless power supply. When connecting a relay or transistor as an external signal input device, pay attention to the following points to prevent short-circuiting due to a sneak current to the transformerless power supply. If a relay or transistor is connected to two or more Timers, the input terminals of those Timers must be wired properly so that they will not differ in phase, otherwise the terminals will be short-circuited to one another.

Incorrect

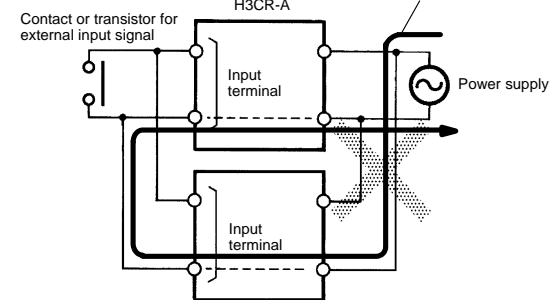

Correct

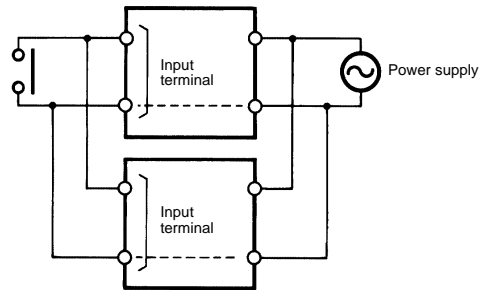

It is impossible to provide two independent power switches as shown below regardless of whether or not the Timers are different in phase.

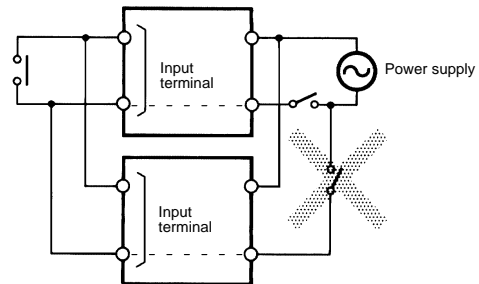

Relationship between Input and Power Supply Circuits (H3CR-A□/A□S)

An appropriate input is applied to the input signal terminals of the H3CR-A□/A□S when one of the input terminals is short-circuited with the common terminal (terminal 2) for the input signals. Never use terminal 10 as the common terminal for this purpose, otherwise the internal circuit of the Timer will be damaged.

Incorrect

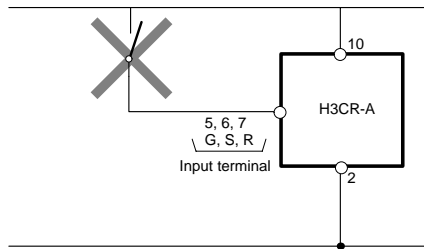

Correct

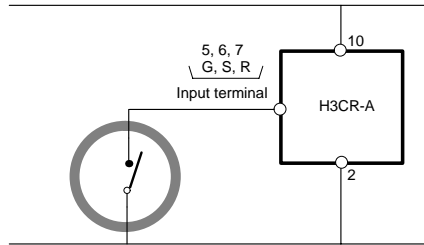

Do not connect a relay or any other load between input terminals, otherwise the internal circuit of the Timer will be damaged due to the high-tension voltage applied to the input terminals.

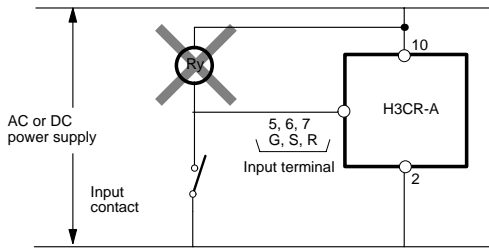

Relationship between Input and Power Supply Circuits (H3CR-AP)

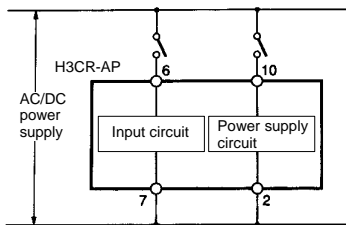

Since the input circuit and the power supply circuit are configured independently, the input circuit can be turned ON or OFF irrespective of the ON/OFF state of the power supply. It must be noted that a voltage equivalent to the power supply voltage is applied to the input circuit.

If a relay or transistor is connected to two or more Timers, the input terminals of those Timers must be wired properly so that they will not be different in phase or the terminals will be short-circuited to one another (refer to the figures below).

Incorrect

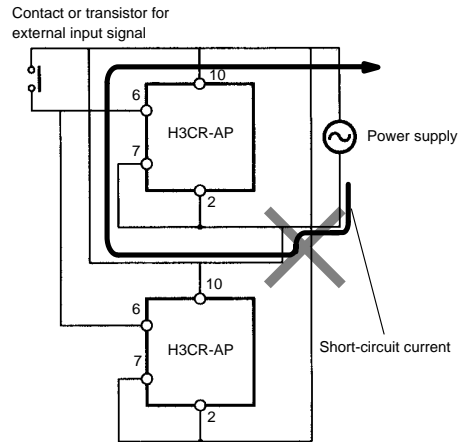

Correct

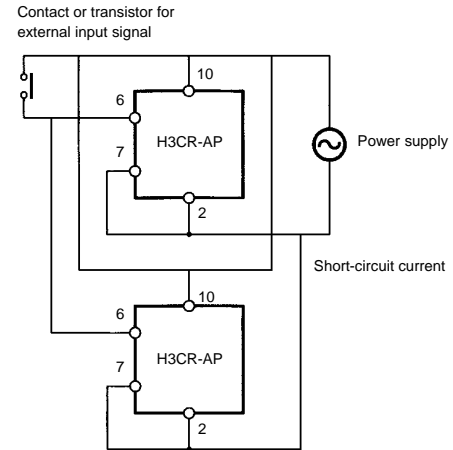

Common to All H3CR-A Models

With the H3CR-AP, input wires must be as short as possible. If the floating capacity of wires exceeds 1,200 pF (approx. 10 m for cables with 120 pF/m), the operation will be affected. Pay particular attention when using shielded cables.

The H3CR-A□S transistor output is isolated from the internal circuitry by a photocoupler. Therefore, either NPN or PNP output is possible.

Precautions (H3CR-H)

Note: The undermentioned is common for all H3CR-H models.

■ Power Supplies

The H3CR-H has a large inrush current; provide sufficient power supply capacity. If the power supply capacity is too small, there may be delays in turning ON the output.

With the H3CR-H□RL, for the power supply of an input device, use an isolating transformer, of which the primary and secondary windings are mutually isolated and the secondary winding is not grounded.

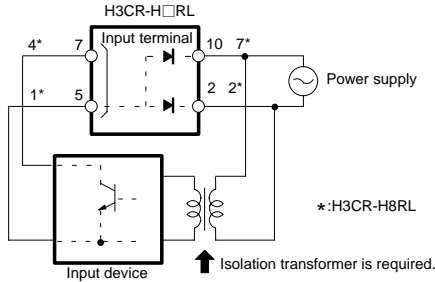

■ Input/Output (H3CR-H□RL)

An appropriate input is applied to the input signal terminal of the Timer when the input terminal for the input signal is short-circuited. Do not attempt to connect any input terminal to any terminal other than the input terminal or to apply voltage across other than the specified input terminals or the internal circuits of the Timer may be damaged.

The H3CR-H□RL uses transformerless power supply. When connecting a relay or transistor as an external signal input device, pay attention to the following points to prevent short-circuiting due to a sneak current to the transformerless power supply.

If input is made simultaneously from one input contact or a transistor to the H3CR-H and a Timer whose common input terminals are used as power terminals, such as the H3CR-A, a short-circuit current will be generated. Either input through isolated contacts, or isolate the power supply for one of the Timers.

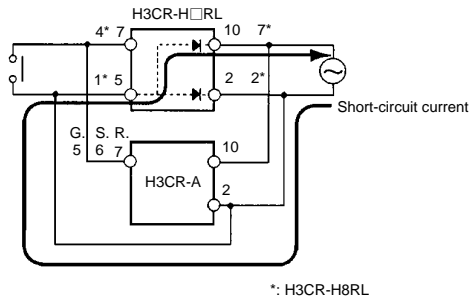

■ Wiring

The H3CR-H has a high impedance circuit. Therefore, the H3CR-H may not be reset if the H3CR-H is influenced by inductive voltage. In order to eliminate any influence of inductive voltage, the wires connected to the H3CR-H must be as short as possible and should not be installed alongside power lines. If the H3CR-H is influenced by inductive voltage that is 30% or more of the rated voltage, connect a CR filter with a capacitance of approximately 0.1 μF and a resistance of approximately 120 Ω or a bleeder resistor between the power supply terminals. If there is any residual voltage due to current leakage, connect a bleeder resistor between the power supply terminals.

■ Operation

An interval of 3 s minimum is required to turn on the H3CR-H after the H3CR-H is turned off. If the H3CR-H is turned on and off repeatedly with an interval of shorter than 3 s, the internal parts of the H3CR-H may deteriorate or the H3CR-H may malfunction.

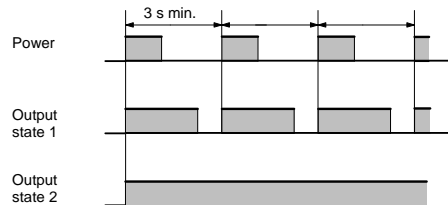

After the forced reset function of the H3CR-H is activated, an interval of 3 s minimum is required to activate the forced reset function again. If the forced reset function is activated repeatedly with an interval of shorter than 3 s, the internal parts of the H3CR-H may deteriorate and the H3CR-H may malfunction.

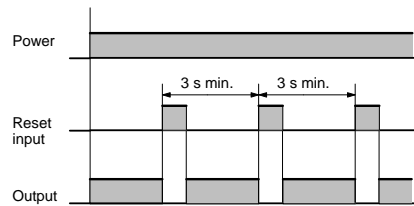

If it is required that the output be turned on repeatedly with an interval of shorter than 3 s, consider use of the H3CR-A in mode D (signal OFF-delay).

■ Others

If the H3CR-H is dropped or experiences some other kind of shock, because a latching relay is used for output, contacts may be reversed or go into a neutral state. If the H3CR-H is dropped, reconfirm correct operation.

ALL DIMENSIONS SHOWN ARE IN MILLIMETERS.

To convert millimeters into inches, multiply by 0.03937. To convert grams into ounces, multiply by 0.03527.

Cat. No. L084-E1-3 **In the interest of product improvement, specifications are subject to change without notice.**

OMRON Corporation

Industrial Automation Company

Measuring and Supervisory Controls Division
28th Fl., Crystal Tower Bldg.,
1-2-27, Shiromi, Chuo-ku,
Osaka 540-6028 Japan
Tel: (81)6-6949-6035/Fax: (81)6-6949-6069

Printed in Japan
0200-2M (0696) (A)