

Features

**Mono-function and multi-function timer range
22.5 mm wide**

87.01 - 1 Pole - Multi-function and multi-voltage
87.02 - 2 Pole - Multi-function and multi-voltage,
(timed + instantaneous options)
External time setting potentiometer option

- Wide supply voltage range:
(24...240)V AC / (24...48)V DC
- LED indicator
- Time setting from 0.05 seconds to 60 hours
- 35 mm rail (EN 50022) mounting

87.01



- Multi-function
- 1 pole
- 35 mm rail (EN 50022) mount

87.02



- Multi-function
- Timing can be regulated using ext. Potentiometer
- 2 timed contacts or 1 timed + 1 instantaneous contact
- 35 mm rail (EN 50022) mount

87.01 / 87.02
Screw terminal

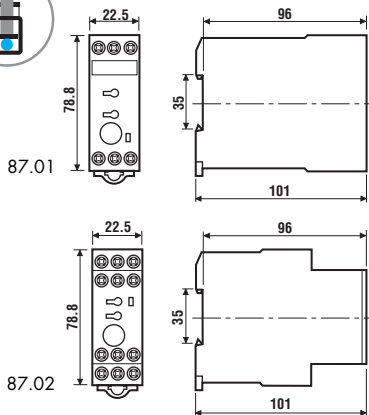

AI: ON delay
BE: Signal OFF delay
CE: Signal ON and OFF Delay
DE: Signal ON pulse
DI: ON pulse
EE α: Signal OFF pulse
GI: Fixed pulse delayed
SW: Symmetrical recycling: ON start

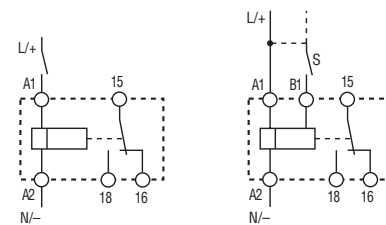

Wiring diagram (without signal START) Wiring diagram (with signal START)

AI: ON delay
BE: Signal OFF delay
CE: Signal ON and OFF Delay
DE: Signal ON pulse
DI: ON pulse
EE α: Signal OFF pulse
GI: Fixed pulse delayed
SW: Symmetrical recycling: ON start

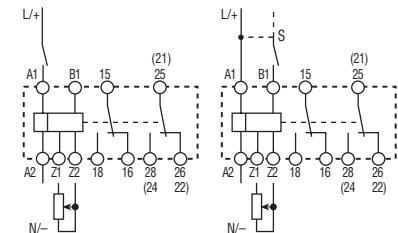

Wiring diagram (without signal START) Wiring diagram (with signal START)

Contact specification		87.01	87.02
Contact configuration		1 CO (SPDT)	2 CO (DPDT)
Rated current/Maximum peak current	A	8/30	8/30
Rated voltage/Maximum switching voltage V AC		250/400	250/400
Rated load AC1	VA	2,000	2,000
Rated load AC15 (230 V AC)	VA	400	400
Single phase motor rating (230 V AC)	kW	0.185	0.185
Breaking capacity DC1: 30/110/220 V	A	8/0.5/0.2	8/0.5/0.2
Minimum switching load	mW (V/mA)	300 (10/5)	300 (10/5)
Standard contact material		AgCdO	AgCdO
Supply specification			
Nominal voltage (U _N)	V AC (50/60 Hz)	24...240	24...240
	V DC	24...48	24...48
Rated power AC/DC	VA (50 Hz)/W	5/0.5	5/0.5
Operating range	AC	(0.85...1.1)U _N	(0.85...1.1)U _N
	DC	(0.85...1.2)U _N	(0.85...1.2)U _N
Technical data			
Specified time range		See page 6	See page 6
Repeatability	%	± 2	± 2
Recovery time	ms	50	50
Minimum control impulse	ms	50	50
Setting accuracy-full range	%	± 5	± 5
Electrical life at rated load in AC1	cycles	100-10 ³	100-10 ³
Ambient temperature range (Contact current)	°C	-20...+70	-20...+60 / -20...+70 (< 5 A)
Protection category		IP 20	IP 20
Approvals (according to type)			

Features

**Mono-function and multi-function timer range
22.5 mm wide**

87.11 - ON delay, multi-voltage

87.21 - ON pulse, multi-voltage

87.31 - Symmetrical recycling, multi-voltage

- 1 Pole output contact
- Wide supply voltage range:
(24...240)V AC / (24...48)V DC
- LED indicator
- Time setting:
Types 87.11/21 - 0.05 seconds to 60 hours
Type 87.31 - 0.5 seconds to 10 seconds
- 35 mm rail (EN 50022) mount

87.11 / 87.21 / 87.31
Screw terminal

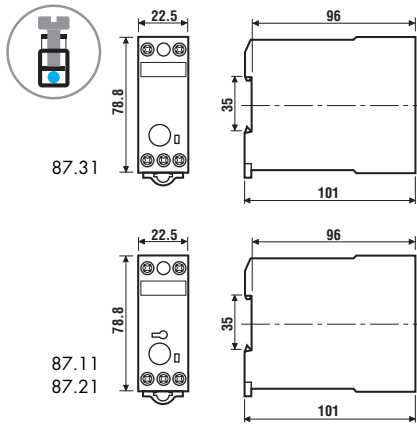

87.11



- Mono-function
- 35 mm rail (EN 50022) mount

AI: ON delay

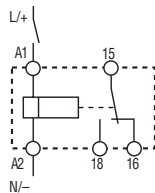

Wiring diagram
(without signal START)

87.21



- Mono-function
- 35 mm rail (EN 50022) mount

DI: ON pulse

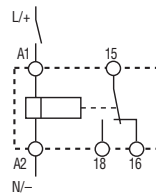

Wiring diagram
(without signal START)

87.31



- Mono-function
- 35 mm rail (EN 50022) mount

SW: Symmetrical recycling: ON start

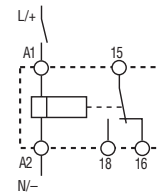

Wiring diagram
(without signal START)

Contact specification				
Contact configuration		1 CO (SPDT)	1 CO (SPDT)	1 CO (SPDT)
Rated current/Maximum peak current	A	8/30	8/30	8/30
Rated voltage/Maximum switching voltage	V AC	250/400	250/400	250/400
Rated load AC1	VA	2,000	2,000	2,000
Rated load AC15 (230 V AC)	VA	400	400	400
Single phase motor rating (230 V AC)	kW	0.185	0.185	0.185
Breaking capacity DC1: 30/110/220 V	A	8/0.5/0.2	8/0.5/0.2	8/0.5/0.2
Minimum switching load	mW (V/mA)	300 (10/5)	300 (10/5)	300 (10/5)
Standard contact material		AgCdO	AgCdO	AgCdO
Supply specification				
Nominal voltage (U _N)	V AC (50/60 Hz)	24...240	24...240	24...240
	V DC	24...48	24...48	24...48
Rated power AC/DC	VA (50 Hz)/W	5/0.5	5/0.5	5/0.5
Operating range	AC	(0.85...1.1)U _N	(0.85...1.1)U _N	(0.85...1.1)U _N
	DC	(0.85...1.2)U _N	(0.85...1.2)U _N	(0.85...1.2)U _N
Technical data				
Specified time range		See page 6	See page 6	See page 6
Repeatability	%	± 0.2	± 0.2	± 0.2
Recovery time	ms	50	50	50
Minimum control impulse	ms	—	—	—
Setting accuracy-full range	%	± 5	± 5	± 5
Electrical life at rated load in AC1	cycles	100 · 10 ³	100 · 10 ³	100 · 10 ³
Ambient temperature range	°C	-20...+70	-20...+70	-20...+70
Protection category		IP 20	IP 20	IP 20
Approvals (according to type)				

Features

**Mono-function and multi-function timer range
22.5 mm wide**

- 87.41 - Signal OFF delay, multi-voltage, 1 Pole**
- 87.61 - True OFF delay, multi-voltage, 1 Pole**
- 87.62 - True OFF delay, multi-voltage, 2 Pole**

- Wide supply voltage range:
Type 87.41, (24...240)V AC / (24...48)V DC
Types 87.61/62, (24...240)V AC/DC
- LED indicator
- Time setting range:
Type 87.41 - 0.05 seconds to 60 hours
Types 87.61/62 - 0.15 seconds to 10 minutes
- 35 mm rail (EN 50022) mount

87.41 / 87.61 / 87.62
Screw terminal

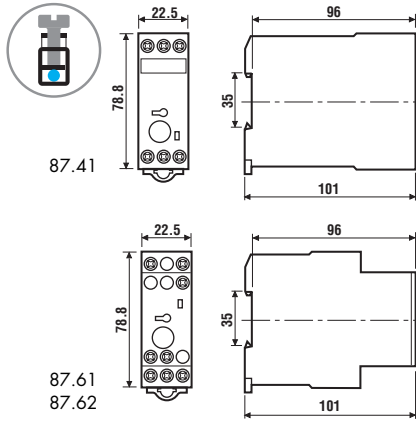

87.41



- Mono-function
- 1 pole
- 35 mm rail (EN 50022) mount

BE: Signal OFF delay

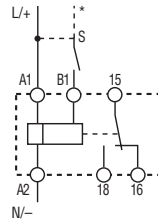

Wiring diagram
(with signal START)

87.61



- Mono-function
- 1 pole
- 35 mm rail (EN 50022) mount

BI: True OFF delay

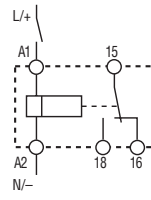

Wiring diagram
(without signal START)

87.62



- Mono-function
- 2 pole
- 35 mm rail (EN 50022) mount

BI: True OFF delay

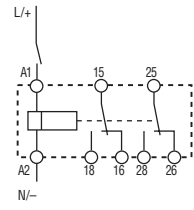

Wiring diagram
(without signal START)

Contact specification

Contact configuration		1 CO (SPDT)	1 CO (SPDT)	2 CO (DPDT)
Rated current/Maximum peak current	A	8/30	5/10	5/10
Rated voltage/Maximum switching voltage	V AC	250/400	250/400	250/400
Rated load AC1	VA	2,000	1,250	1,250
Rated load AC15 (230 V AC)	VA	400	250	250
Single phase motor rating (230 V AC)	kW	0.185	0.125	0.125
Breaking capacity DC1: 30/110/220 V	A	8/0.5/0.2	5/0.5/0.2	5/0.5/0.2
Minimum switching load	mW (V/mA)	300 (10/5)	300 (10/5)	300 (10/5)
Standard contact material		AgCdO	AgCdO	AgCdO

Supply specification

Nominal voltage (U _N)	V AC (50/60 Hz)	24...240	24...240	24...240
	V DC	24...48	24...240	24...240
Rated power AC/DC	VA (50 Hz)/W	5/0.5	1.5/1.5	1.5/1.5
Operating range	AC	(0.85...1.1)U _N	(0.85...1.1)U _N	(0.85...1.1)U _N
	DC	(0.85...1.2)U _N	(0.85...1.2)U _N	(0.85...1.2)U _N

Technical data

Specified time range		See page 6	See page 6	See page 6
Repeatability	%	± 0.2	± 1	± 1
Recovery time	ms	50	50	50
Minimum control impulse	ms	50	300 ms (A1 - A2)	300 ms (A1 - A2)
Setting accuracy-full range	%	± 5	± 5	± 5
Electrical life at rated load in AC1	cycles	100 · 10 ³	100 · 10 ³	100 · 10 ³
Ambient temperature range	°C	-20...+70	-20...+70	-20...+70
Protection category		IP 20	IP 20	IP 20

Approvals (according to type)



Features

**Mono-function and multi-function timer range
22.5 mm wide**

**87.82 - Star-Delta timer, multi-voltage,
star and delta output contacts**

87.91 - Multi-function Recycling timer, 1 Pole

- Wide supply range:
(24...240)V AC / (24...48)V DC
- LED indicator
- Time setting voltage range:
Type 87.82 - 0.05 minute to 1 minute
Type 87.91 - 0.05 seconds to 60 hours
- 35 mm rail (EN 50022) mount

87.82



- Mono-function: Star - delta
- 2 pole
- 35 mm rail (EN 50022) mount

87.91



- Multi-function recycling
- 1 pole
- 35 mm rail (EN 50022) mount

87.82 / 87.91
Screw terminal

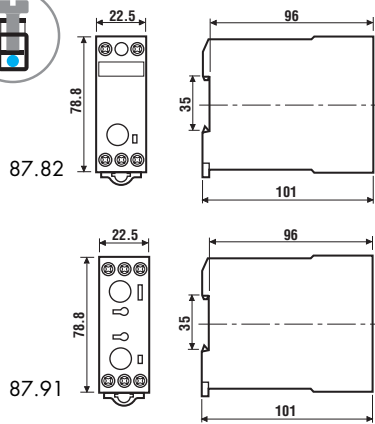

SD: Star - delta

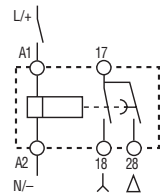

Wiring diagram
(without signal START)

- LI:** Asymmetrical recycling (ON starting)
- LE:** Signal asymmetrical recycling (ON starting)
- PI:** Asymmetrical recycling (OFF starting)
- PE:** Signal asymmetrical recycling (OFF starting)

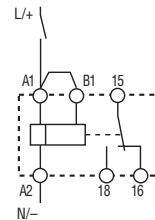

Wiring diagram
(without signal START)

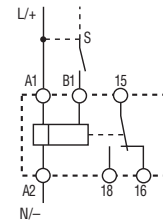

Wiring diagram
(with signal START)

Contact specification			
Contact configuration		2 NO (DPST-NO)	1 CO (SPDT)
Rated current/Maximum peak current	A	8/30	8/30
Rated voltage/Maximum switching voltage	V AC	250/400	250/400
Rated load AC1	VA	2,000	2,000
Rated load AC15 (230 V AC)	VA	400	400
Single phase motor rating (230 V AC)	kW	0.185	0.185
Breaking capacity DC1: 30/110/220 V	A	8/0.5/0.2	8/0.5/0.2
Minimum switching load	mW (V/mA)	300 (10/5)	300 (10/5)
Standard contact material		AgCdO	AgCdO
Supply specification			
Nominal voltage (U _N)	V AC (50/60 Hz)	24...240	24...240
	V DC	24...48	24...48
Rated power AC/DC	VA (50 Hz)/W	5/0.5	5/0.5
Operating range	AC	(0.85...1.1)U _N	(0.85...1.1)U _N
	DC	(0.85...1.2)U _N	(0.85...1.2)U _N
Technical data			
Specified time range		See page 6	See page 6
Repeatability	%	± 0.2	± 0.2
Recovery time	ms	50	50
Minimum control impulse	ms	—	50
Setting accuracy-full range	%	± 5	± 5
Electrical life at rated load in AC1	cycles	100 · 10 ³	100 · 10 ³
Ambient temperature range	°C	-20...+70	-20...+70
Protection category		IP 20	IP 20
Approvals (according to type)			

Ordering information

Example: 87 series multi-function timer 8 A, 1 CO (SPDT) contact, (24...240)V AC (50/60 Hz) and (24...48)V DC supply.

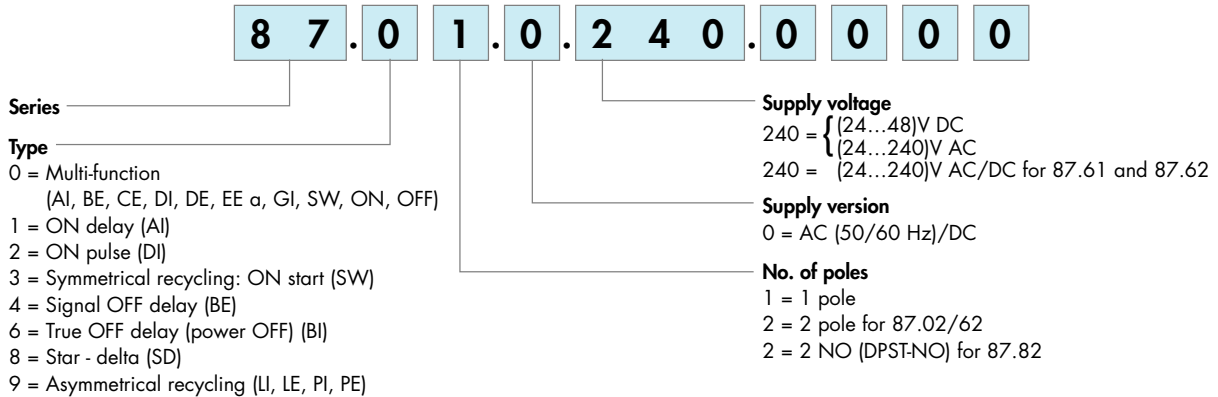

Technical data

Insulation			
Dielectric strength	between input and output circuit	V AC	4,000
	insulation (1.2/50 μs) between input and output	kV	6
	between open contacts	V AC	1,000
	between adjacent contacts	V AC	2,000 (Type 87.02, 87.62)
EMC specifications			
Type of test	Reference standard		
Electrostatic discharge	contact discharge	EN 61000-4-2	8 kV
	air discharge	EN 61000-4-2	8 kV
Radio-frequency electromagnetic field (80 ÷ 1000 MHz)		EN 61000-4-3	10 V/m
Fast transients (burst) (5-50 ns, 5 kHz) on Supply terminals		EN 61000-4-4	6 kV
Surges (1.2/50 μs) on Supply terminals	common mode	EN 61000-4-5	4 kV
	differential mode	EN 61000-4-5	4 kV
Radio-frequency common mode (0.15 ÷ 80 MHz) on Supply terminals		EN 61000-4-6	10 V
Radiated and conducted emission		EN 55022	classe B
Other data			
Signal control (B1)			
	current absorption	1 mA	
	max cable length (capacity of ≤ 10 nF / 100 m)	250 m	
	when applying a control signal to B1, which is different from the supply voltage at A1/A2	B1 is isolated from A1 and A2 by an opto-coupler, and can therefore be operated at a voltage other than the supply voltage If using a control signal of between (24... 48) V DC and a supply voltage of (24...240) V AC; ensure that the signal – is connected to A2 and the + is applied to B1, and that L is applied to A1 and N to A2	
	*When applying a control signal to B1 it is recommended to attach a bypass resistance 56 kΩ/2 W across A1 - A2		
	External potentiometer for 87.02	Use a 10 kΩ/ ≥ 0,25 W linear potentiometer. Maximum cable length 10 m. When using an external potentiometer, remove the bridge between Z1 and Z2, and set the timer's potentiometer to its minimum setting. Consider the voltage potential at the potentiometer to be the same as the timer supply voltage.	
Power lost to the environment		87.01/02/11/21/31/41/91	87.61/62
	without contact current	W	5
	with rated current	W	1.5
Screw torque		Nm	1.2
	Max. wire size	solid cable	stranded cable
		mm ²	1x4 / 2x2.5
	AWG	1x12 / 2x14	1x12 / 2x16

Time scales

Type	Function Code	Function	Time ranges - minimum to maximum span										
			s	s	s	min	min	min	h	h	h	h	
			0,05	0,15	0,5	0,05	0,15	0,5	0,05	0,15	0,5	3	
			1	3	10	1	3	10	1	3	10	60	
87.01/ 87.02	AI	ON delay	•	•	•	•	•	•	•	•	•	•	•
	BE	Signal OFF delay	•	•	•	•	•	•	•	•	•	•	•
	CE	Signal ON and OFF delay	•	•	•	•	•	•	•	•	•	•	•
	DI	ON pulse	•	•	•	•	•	•	•	•	•	•	•
	DE	Signal ON pulse	•	•	•	•	•	•	•	•	•	•	•
	EE a	Signal OFF pulse	•	•	•	•	•	•	•	•	•	•	•
	GI	Fixed pulse (0,5s) delayed	•	•	•	•	•	•	•	•	•	•	•
	SW	Symmetrical recycling: ON start	•	•	•	•	•	•	•	•	•	•	•
87.11	AI	ON delay	•	•	•	•	•	•	•	•	•	•	
87.21	DI	ON pulse	•	•	•	•	•	•	•	•	•	•	
87.31	SW	Symmetrical recycling: ON start			•								
87.41	BE	Signal OFF delay	•	•	•	•	•	•	•	•	•	•	
87.61/ 87.62	BI	True OFF delay (power OFF)		0.15	•	0.07		•					
				2.5		1.3							
87.82	SD	Star - delta ($T_U = \sim 60$ ms)				•							
87.91	LI	Asymmetrical recycling (ON start)	•	•	•	•	•	•	•	•	•	•	
	LE	Signal asymmetrical recycling (ON start)	•	•	•	•	•	•	•	•	•	•	
	PI	Asymmetrical recycling (OFF start)	•	•	•	•	•	•	•	•	•	•	
	PE	Signal asymmetrical recycling (OFF start)	•	•	•	•	•	•	•	•	•	•	



Potentiometer for remote time setting of 87.02 timer.
10 kΩ/0.25 W linear. Panel hole diameter - 22.5 mm

087.02.2

Functions

U = Supply Voltage

S = Signal switch

C = Output Contact

LED** Green	Timing	NO output contact	Contacts Timed		DIP switch	Contacts Instantaneous*	
			Open	Closed		Open	Closed
	None	Open	15 - 18 25 - 28*	15 - 16 25 - 26*		21 - 24*	21 - 22*
	In progress	Open	15 - 18 25 - 28*	15 - 16 25 - 26*		21 - 22*	21 - 24*
	In progress	Closed	15 - 16 25 - 26*	15 - 18 25 - 28*		21 - 22*	21 - 24*
	None	Closed	15 - 16 25 - 26*	15 - 18 25 - 28*		21 - 22*	21 - 24*

* 25-26-28 only for type 87.02 with 2 timed contacts. 21-22-24 only for type 87.02 with 1 instantaneous contact + 1 timed positioning the front DIP switch.

** The LED on types 87.61 and 87.62 is illuminated when supply voltage is supplied to timer.

Wiring diagram

Multi-function without signal START

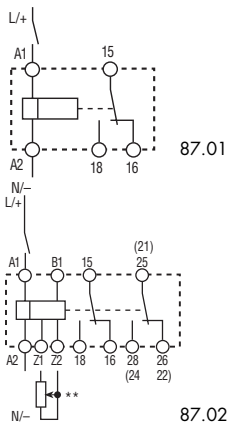

with signal START

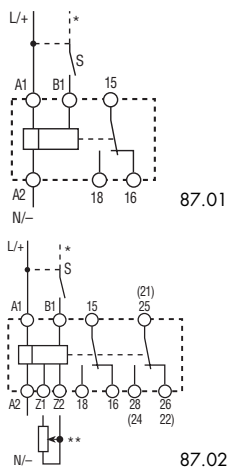

* A voltage other than the supply voltage can be applied to the command START (B1).

Example:

A1 - A2 = 230 V AC

B1 - A2 = 24 V AC

** Type 87.02: regulated using an external potentiometer (10 kΩ - 0.25 W).

NB.: remove link between Z1-Z2 and position the Timer potentiometer on "zero".

Type 87.01 87.02



(AI) ON delay.

Apply power to timer. Output contacts transfer after preset time has elapsed. Reset occurs when power is removed.

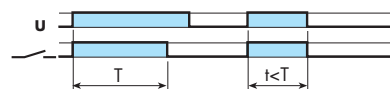

(DI) ON pulse.

Apply power to timer. Output contacts transfer immediately. After the preset time has elapsed, contacts reset.

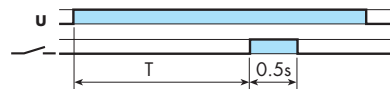

(GI) Fixed pulse (0.5s) delayed.

Apply power to timer. Output contacts transfer after preset time has elapsed. Reset occurs after a fixed time of 0.5s.

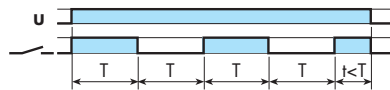

(SW) Symmetrical recycling: ON start.

Apply power to timer. Output contacts transfer immediately and cycle between ON and OFF for as long as power is applied. The ratio is 1:1 (time on = time off).

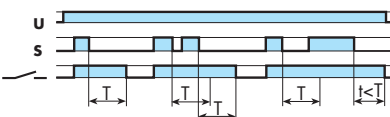

(BE) Signal OFF delay.

Power is permanently applied to the timer. The output contacts transfer immediately on closure of the Signal Switch (S). Opening the Signal Switch initiates the preset delay, after which time the output contacts reset.

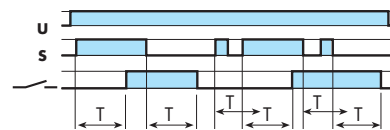

(CE) Signal ON and OFF delay.

Power is permanently applied to the timer. Closing the Signal Switch (S) initiates the preset delay, after which time the output contacts transfer. Opening the Signal switch initiates the same preset delay, after which time the output contacts reset.

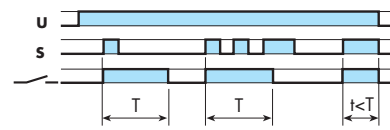

(DE) Signal ON pulse.

Power is permanently applied to the timer. On momentary or maintained closure of Signal Switch (S), the output contacts transfer, and remain so for the duration of the preset delay, after which they reset.

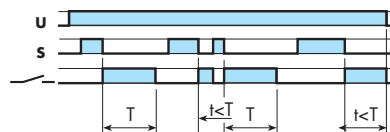

(EE a) Signal OFF pulse.

Power is permanently applied to the timer. On opening of the Signal Switch (S) the output contacts transfer, and remain so for the duration of the preset delay, after which they reset.

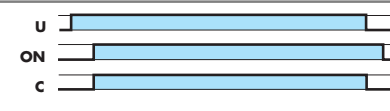

Permanently ON.

Selecting the function ON when power is applied to the relay the first contact transfers immediately and remains in that position.

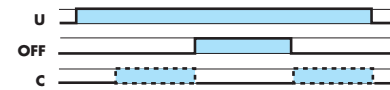

Permanently OFF.

The contact returns to the original position when the OFF function is selected.

Functions

Wiring diagram

Mono-function without signal START

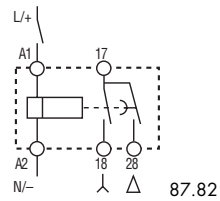
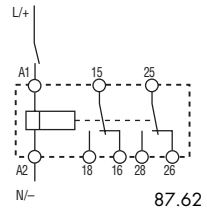
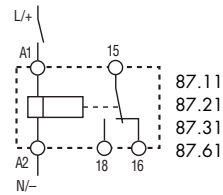

with signal START (S)

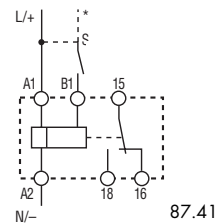

Asymmetrical recycler without signal START

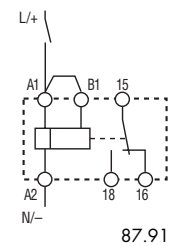

with signal START (S)

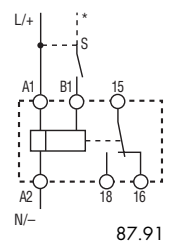

Type 87.11



(AI) ON delay.
Apply power to timer. Output contacts transfer after preset time has elapsed. Reset occurs when power is removed.

87.21

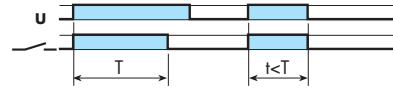

(DI) ON pulse.
Apply power to timer. Output contacts transfer immediately. After the preset time has elapsed, contacts reset.

87.31

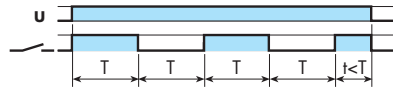

(SW) Symmetrical recycling: ON start.
Apply power to timer. Output contacts transfer immediately and cycle between ON and OFF for as long as power is applied. The ratio is 1:1 (time on = time off).

87.61

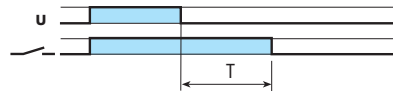

(BI) True OFF delay (power OFF).
Apply power to timer (minimum 300 ms). Output contacts transfer immediately. Removal of power initiates the preset delay, after which time the output contacts reset.

87.62

87.82

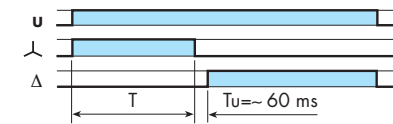

(SD) Star - delta.
Apply power to timer. The star contact (Λ) closes immediately. After preset delay has elapsed the star contact (Λ) resets. After a further fixed time of ~60 ms the delta contact (Δ) closes and remains in that position, until reset on power off.

87.41

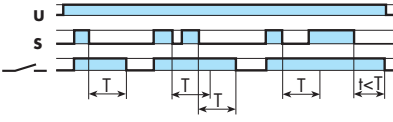

(BE) Signal OFF delay.
Power is permanently applied to the timer. The output contacts transfer immediately on closure of the Signal Switch (S). Opening the Signal Switch initiates the preset delay, after which time the output contacts reset.

87.91

switch position

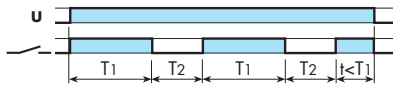

(LI) Asymmetrical recycling (ON start).
Apply power to timer. Output contacts transfer immediately and cycle between ON and OFF for as long as power is applied. The ON and OFF times are independently adjustable.

switch position

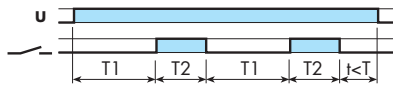

(PI) Asymmetrical recycling (OFF start).
Apply power to timer. Output contacts transfer after time T1 has elapsed and cycle between OFF and ON for as long as power is applied. The ON and OFF times are independently adjustable.

switch position

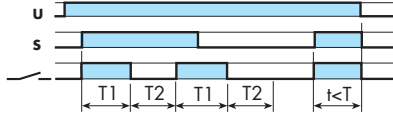

(LE) Signal asymmetrical recycling (ON start)
Power is permanently applied to the timer. Closing Signal Switch (S) causes the output contacts to transfer immediately and cycle between ON and OFF, until opened.

switch position

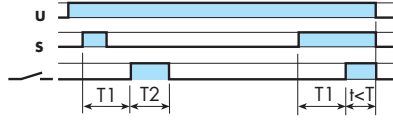

(PE) Signal asymmetrical recycling (OFF start).
Power is permanently applied to the timer. Closing the Signal Switch (S) initiates delay T1 after which the output contacts transfer and continue to cycle between OFF and ON, until the Signal Switch is opened.