

Ultra-compact and Slim DPDT Relay

- Dimensions of 5.7 × 10.6 × 9 mm (W × L × H) represent a reduction of approximately 56% in mounting area compared with the OMRON G6S, for higher-density mounting.
- Dielectric strength of 1,500 VAC and an impulse withstand voltage of 2,500 V for 2 × 10 μs (conforms to North American Telcordia specifications (formerly Bellcore)).
- Conforms to FCC Part 68 (i.e., impulse withstand voltage of 1,500 V for 10 × 160 μs between coil and contacts and between contacts of the same polarity).
- Single-winding latching models to save energy.
- Conforms to UL60950 (File No. E41515)/CSA C22.2 No. 60950 (File No. LR31928).

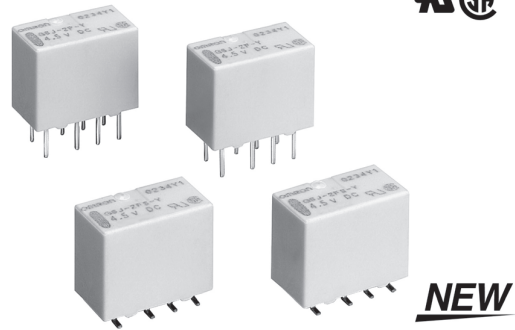

RoHS Compliant Refer to pages 16 to 17 for details.

Ordering Information

Classification				Single-side stable	Single-winding latching
DPDT	Plastic sealed	PCB terminal		G6J-2P-Y	G6JU-2P-Y
		Surface mount terminal	Short	G6J-2FS-Y	G6JU-2FS-Y
			Long	G6J-2FL-Y	G6JU-2FL-Y

Note: 1. When ordering, add the rated coil voltage to the model number.
Example: G6J-2P-Y 12 VDC

└── Rated coil voltage

2. When ordering tape packing, add "-TR" to the model number.
Example: G6J-2P-Y-TR 12 VDC

└── Tape packing

Be sure since "-TR" is not part of the relay model number, it is not marked on the relay case.

Model Number Legend:

G6J - -

1 2 3 4

1. Relay function

None: Single-side stable relay

U: Single-winding latching relay

2. Contact form

2: DPDT

3. Terminal shape

P: PCB terminals

FS: Surface-mounting terminals, short

FL: Surface-mounting terminals, long

4. Special function

Y: Improved product for soldering heat resistance

Application Examples

Telephones, communications equipment, measurement devices, office automation machines, and audio-visual products.

Specifications

■ Standard Specifications

Contact mechanism: Crossbar twin Ag (Au-alloy contact)

Enclosure rating: Plastic-sealed

■ Coil Ratings

Single-side Stable Relays (G6J-2P-Y, G6J-2FS-Y, G6J-2FL-Y)

Rated voltage	3 VDC	4.5 VDC	5 VDC	12 VDC	24 VDC
Rated current	48.0 mA	32.6 mA	28.9 mA	12.3 mA	9.2 mA
Coil resistance	62.5 Ω	137.9 Ω	173.1 Ω	976.8 Ω	2,600.5 Ω
Must operate voltage	75% max. of rated voltage				
Must release voltage	10% min. of rated voltage				
Max. voltage	150% of rated voltage				
Power consumption	Approx. 140 mW				Approx. 230 mW

- Note:**
1. The rated current and coil resistance are measured at a coil temperature of 23°C with a tolerance of ±10%.
 2. The operating characteristics are measured at a coil temperature of 23°C.
 3. The maximum voltage is the highest voltage that can be imposed on the Relay coil instantaneously.

Single-winding Latching Relays (G6JU-2P-Y, G6JU-2FS-Y, G6JU-2FL-Y)

Rated voltage	3 VDC	4.5 VDC	5 VDC	12 VDC
Rated current	33.7 mA	22.0 mA	20.4 mA	9.0 mA
Coil resistance	89.0 Ω	204.3 Ω	245.5 Ω	1,329.2 Ω
Must set voltage	75% max. of rated voltage			
Must reset voltage	75% max. of rated voltage			
Max. voltage	150% of rated voltage			
Power consumption	Approx. 100 mW			

- Note:**
1. The rated current and coil resistance are measured at a coil temperature of 23°C with a tolerance of ±10%.
 2. The operating characteristics are measured at a coil temperature of 23°C.
 3. The maximum voltage is the highest voltage that can be imposed on the Relay coil instantaneously.

■ Contact Ratings

Load	Resistive load
Rated load	0.3 A at 125 VAC, 1 A at 30 VDC
Rated carry current	1 A
Max. switching voltage	125 VAC, 110 VDC
Max. switching current	1 A

■ Characteristics

Item		Single-side Stable Relays	Single-winding Latching Relays
		G6J-2P-Y, G6J-2FS-Y, G6J-2FL-Y	G6JU-2P-Y, G6JU-2FS-Y, G6JU-2FL-Y
Contact resistance (See note 1.)		100 mΩ max.	
Operating (set) time (See note 2.)		3 ms max. (approx. 1.6 ms)	
Release (reset) time (See note 2.)		3 ms max. (approx. 1.0 ms)	3 ms max. (approx. 0.9 ms)
Minimum set/reset signal width		---	10 ms
Insulation resistance (See note 3.)		1,000 MΩ min. (at 500 VDC)	
Dielectric strength	Coil and contacts	1,500 VAC, 50/60 Hz for 1 min	
	Contacts of different polarity	1,000 VAC, 50/60 Hz for 1 min	
	Contacts of same polarity	750 VAC, 50/60 Hz for 1 min	
Impulse withstand voltage	Coil and contacts	2,500 VAC, 2 x 10 μs	
	Contacts of different polarity	1,500 VAC, 10 x 160 μs	
	Contacts of same polarity		
Vibration resistance		Destruction: 10-55-10 Hz 2.5-mm single amplitude (5-mm double amplitude) Malfunction: 10-55-10 Hz 1.65-mm single amplitude (3.3-mm double amplitude)	
Shock resistance		Destruction: 1,000 m/s ² (approx. 100G) Malfunction: 750 m/s ² (approx. 75G)	
Life expectancy		Mechanical: 50,000,000 operations min. (at 36,000 operations/hour) Electrical: 100,000 operations min. (with a rated load at 1,800 operations/hour)	
Failure rate (P level) (See note 4.)		10 μA at 10 mVDC	
Ambient temperature		-40 to 85°C (with no icing or condensation)	
Ambient humidity		5% to 85%	
Weight		Approx. 1.0 g	

Note: The above values are initial values.

Note: 1. The contact resistance was measured with 10 mA at 1 VDC with a fall-of-potential method.

2. Values in parentheses are actual values.

3. The insulation resistance was measured with a 500-VDC Megger Tester applied to the same parts as those for checking the dielectric strength.

4. This value was measured at a switching frequency of 120 operations/min and the criterion of contact resistance is 50 Ω. This value may vary depending on the operating frequency, operating conditions, expected reliability level of the relay, etc. Always double-check relay suitability under actual load conditions.

Engineering Data

Maximum Switching Capacity

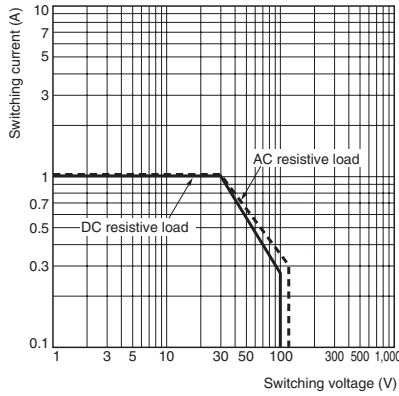

Ambient Temperature vs. Maximum Voltage

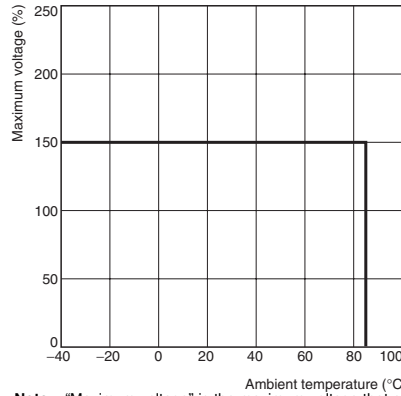

Note: "Maximum voltage" is the maximum voltage that can be applied to the Relay coil.

Ambient Temperature vs. Switching Current

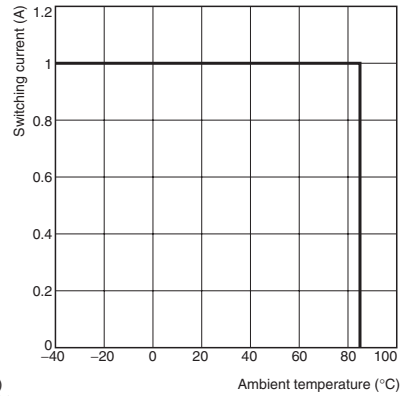

Electrical Endurance

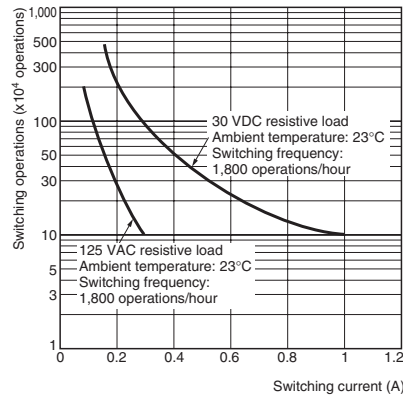

Ambient Temperature vs. Must Operate or Must Release Voltage

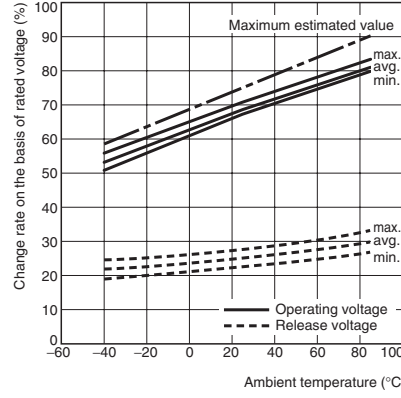

Shock Malfunction

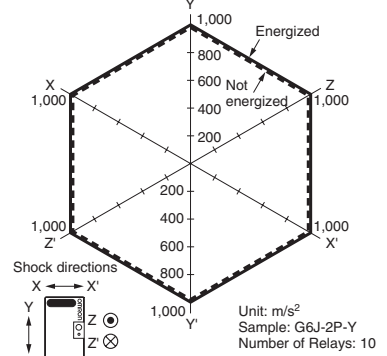

Conditions: Shock is applied in ±X, ±Y, and ±Z directions three times each with and without energizing the Relays to check the number of contact malfunctions.

Electrical Endurance (with Operate and Release Voltage) (See note 1.)

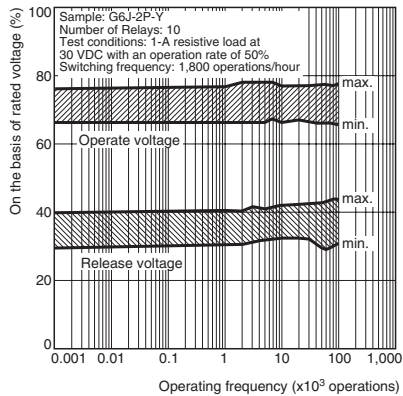

Electrical Endurance (Contact resistance) (See note 1.)

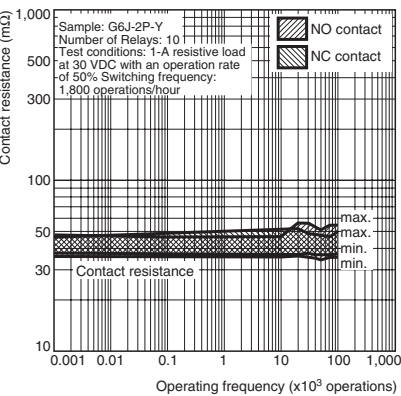

Contact Reliability Test (See notes 1 and 2.)

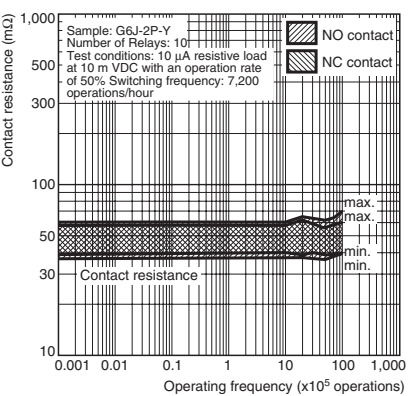

Note: 1. The tests were conducted at an ambient temperature of 23°C.
2. The contact resistance data are periodically measured reference values and are not values from each monitoring operation. Contact resistance values will vary according to the switching frequency and operating environment, so be sure to check operation under the actual operating conditions before use.

Mutual Magnetic Interference

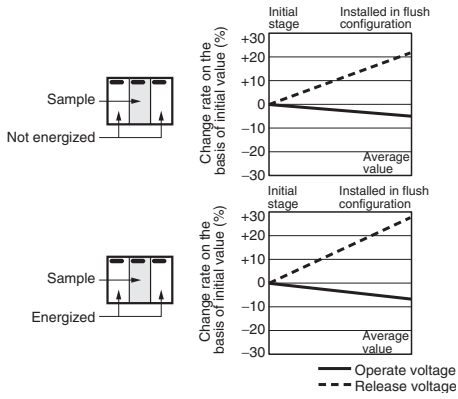

Mutual Magnetic Interference

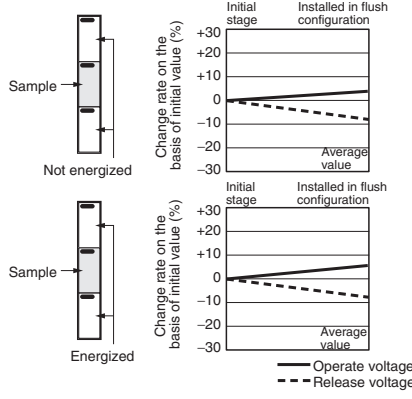

External Magnetic Interference

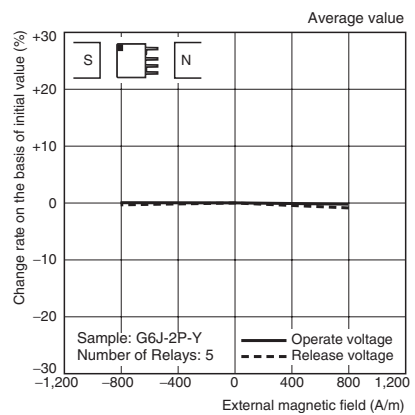
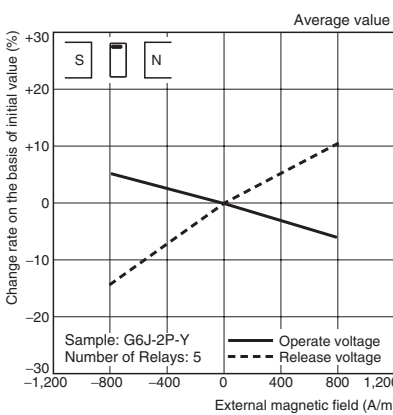
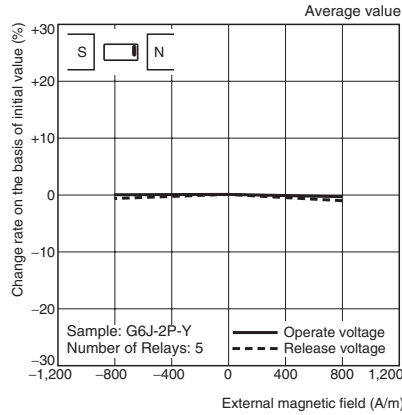

High-frequency Characteristics (Isolation) (See notes 1 and 2.)

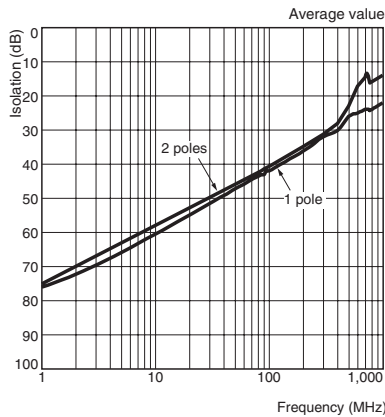

High-frequency Characteristics (Insertion Loss) (See notes 1 and 2.)

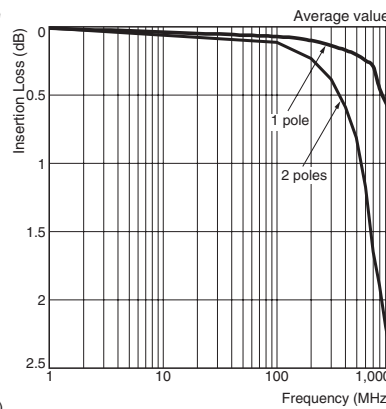

High-frequency Characteristics (Return Loss, V.SWR) (See notes 1 and 2.)

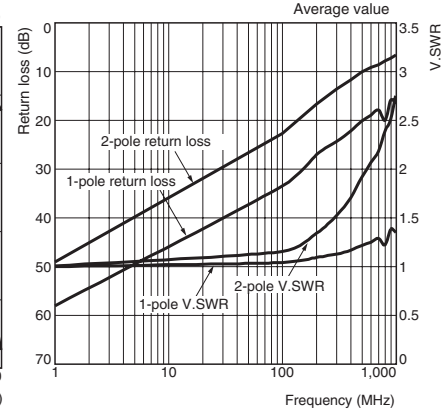

- Note:**
1. The tests were conducted at an ambient temperature of 23°C.
 2. High-frequency characteristics depend on the PCB to which the Relay is mounted. Always check these characteristics, including endurance, in the actual machine before use.

Operate and Release Time Distribution (See note.)

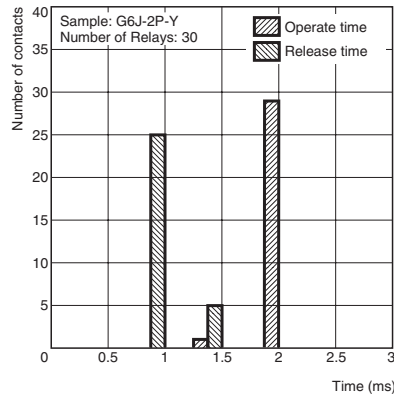

Operate and Release Bounce Time Distribution (See note.)

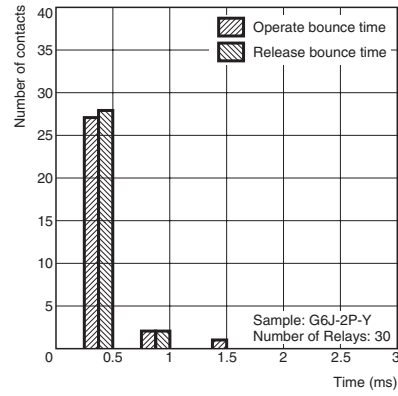

Vibration Resistance

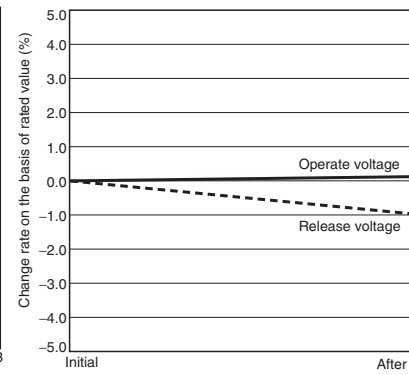

Note: The tests were conducted at an ambient temperature of 23°C.

Dimensions

Note: All units are in millimeters unless otherwise indicated.

G6J-2P-Y G6JU-2P-Y

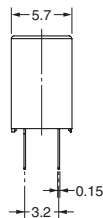
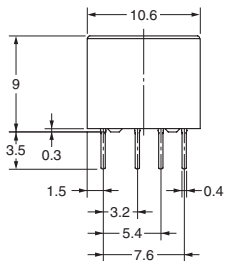
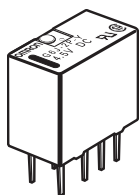

Note: Each value has a tolerance of ± 0.3 mm.

Mounting Dimensions (Bottom View)

Tolerance ± 0.1 mm

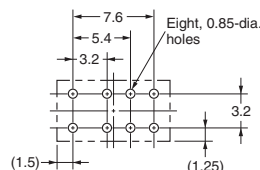

Terminal Arrangement/ Internal Connections (Bottom View)

G6J-2P-Y

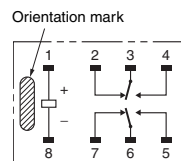

G6JU-2P-Y

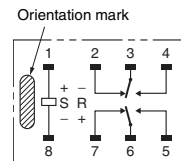

G6J-2FS-Y G6JU-2FS-Y

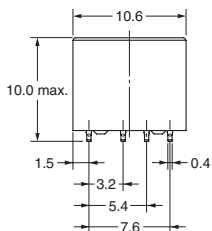
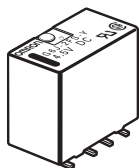

Note: Each value has a tolerance of ± 0.3 mm.

Mounting Dimensions (Top View)

Tolerance ± 0.1 mm

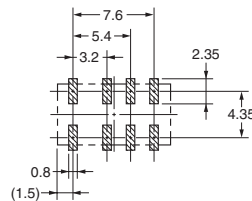

Terminal Arrangement/ Internal Connections (Top View)

G6J-2FS-Y

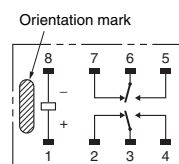

G6JU-2FS-Y

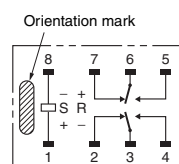

G6J-2FL-Y G6JU-2FL-Y

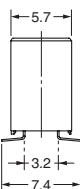
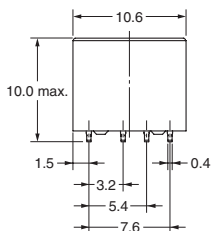
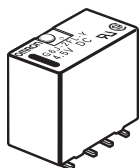

Note: Each value has a tolerance of ± 0.3 mm.

Mounting Dimensions (Top View)

Tolerance ± 0.1 mm

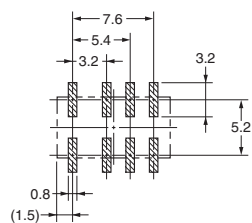

Terminal Arrangement/ Internal Connections (Top View)

G6J-2FL-Y

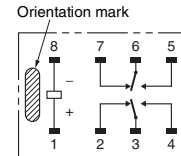

G6JU-2FL-Y

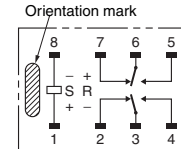

Stick Packing and Tape Packing

1. Stick Packing

Relays in stick packing are arranged so that the orientation mark of each Relay is on the left side.

Always confirm that the Relays are in the correct orientation when mounting the Relays to the PCBs.

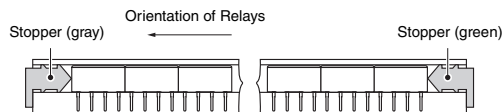

Stick length: 555 mm (stopper not included)

No. of Relays per stick: 50

2. Tape Packing (Surface-mounting Terminal Relays)

When ordering Relays in tape packing, add the prefix “-TR” to the model number, otherwise the Relays in stick packing will be provided.

Tape type: TB2412R (EIAJ (Electronic Industrial Association of Japan))

Reel type: R24D (EIAJ (Electronic Industrial Association of Japan))

Relays per reel: 400

Direction of Relay Insertion

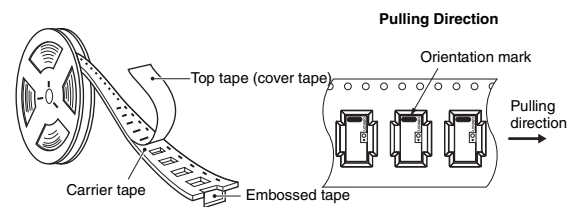

Reel Dimensions

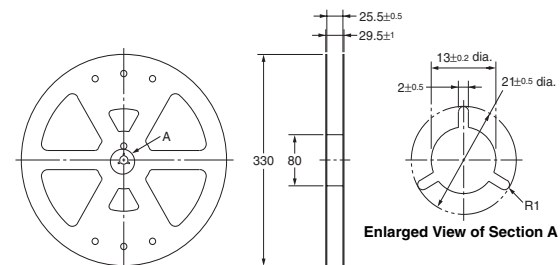

Carrier Tape Dimensions

G6J-2FS-Y, G6JU-2FS-Y

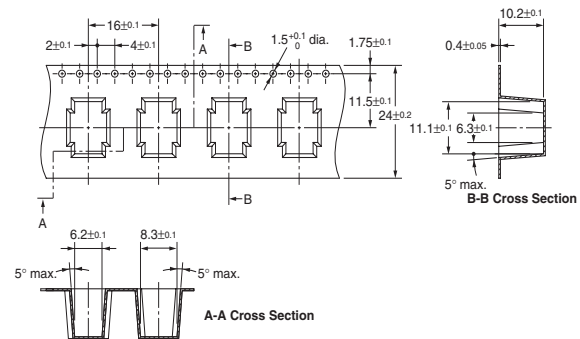

G6J-2FL-Y, G6JU-2FL-Y

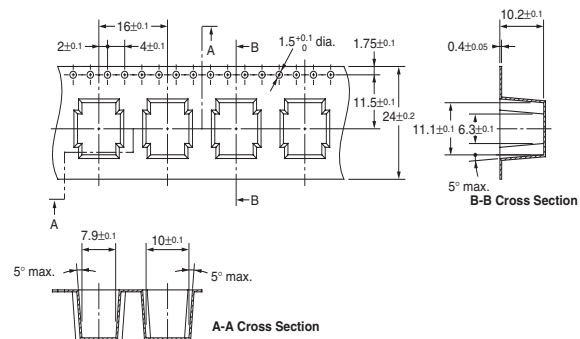

Recommended Soldering Method

IRS Method (for Surface-mounting Terminal Relays)

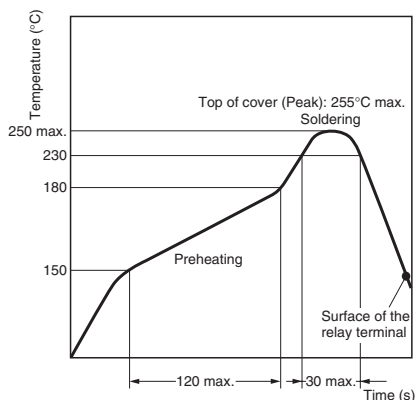

Note: Temperatures are given for the surface of the terminal.

■ Approved Standards

UL approval: UL60950 (File No. E41515)

CSA approval: C22.2 No. 60950 (File No. LR31928)

Contact form	Coil rating	Contact rating	Number of test operations
DPDT	G6J-2P-Y, 2FS-Y, 2FL-Y: 3 to 24 VDC	1 A at 30 VDC	6,000
	G6JU-2P-Y, 2FS-Y, 2FL-Y: 3 to 24 VDC	0.5 A at 60 VDC	
		0.3 A at 125 VAC	

- The thickness of cream solder to be applied should be between 150 and 200 μm on OMRON's recommended PCB pattern.
- In order to perform correct soldering, it is recommended that the correct soldering conditions be maintained as shown below on the left-hand side.

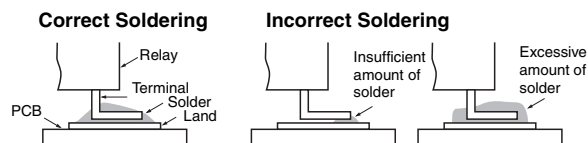

Visually check that the Relay is properly soldered.

Precautions

Refer to page 25 for information on general precautions. Be sure to read these precautions before using the Relay.

Correct Use

• Long Term Current Carrying

Under a long-term current carrying without switching, the insulation resistance of the coil goes down gradually due to the heat generated by the coil itself. Furthermore, the contact resistance of the Relay will gradually become unstable due to the generation of film on the contact surfaces. A Latching Relay can be used to prevent these problems. When using a single-side stable relay, the design of the fail-safe circuit provides protection against contact failure and open coils.

Handling of Surface-mounting Relays

Use the Relay as soon as possible after opening the moisture-proof package. If the Relay is left for a long time after opening the moisture-proof package, the appearance may suffer and seal failure may occur after the solder mounting process. To store the Relay after opening the moisture-proof package, place it into the original package and sealed the package with adhesive tape.

When washing the product after soldering the Relay to a PCB, use a water-based solvent or alcohol-based solvent, and keep the solvent temperature to less than 40°C. Do not put the relay in a cold cleaning bath immediately after soldering.

Soldering

Soldering temperature: Approx. 250°C (At 260°C if the DWS method is used.)

Soldering time: Approx. 5 s max. (Approx. 2 s for the first time and approx. 3 s for the second time if the DWS method is used.)

Be sure to adjust the level of the molten solder so that the solder will not overflow onto the PCB.

Claw Securing Force During Automatic Insertion

During automatic insertion of Relays, make sure to set the securing force of the claws to the following values so that the Relay characteristics will be maintained.

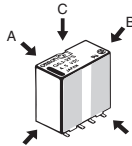

Direction A: 4.90 N max.

Direction B: 9.80 N max.

Direction C: 9.80 N max.

 Secure the claws to the area indicated by shading. Do not attach them to the center area or to only part of the Relay.

Environmental Conditions During Operation, Storage, and Transportation

Protect the Relays from direct sunlight and keep the Relays under normal temperature, humidity, and pressure.

Mounting Latching Relays

Make sure that the vibration or shock that is generated from other devices, such as Relays in operation, on the same panel and imposed on the Latching Relays does not exceed the rated value, otherwise the Latching Relays that have been set may be reset or vice versa. The Latching Relays are reset before shipping. If excessive vibration or shock is imposed, however, the Latching Relays may be set accidentally. Be sure to apply a reset signal before use.

Maximum Voltage

The maximum voltage of the coil can be obtained from the coil temperature increase and the heat-resisting temperature of coil insulating sheath material. (Exceeding the heat-resisting temperature may result in burning or short-circuiting.) The maximum voltage also involves important restrictions which include the following:

- Must not cause thermal changes or deterioration of the insulating material.
- Must not cause damage to other control devices.
- Must not cause any harmful effect on people.
- Must not cause fire.

Therefore, be sure not to exceed the maximum voltage specified in the catalog.

As a rule, the rated voltage must be applied to the coil. A voltage exceeding the rated value, however, can be applied to the coil provided that the voltage is less than the maximum voltage. It must be noted that continuous voltage application to the coil will cause a coil temperature increase thus affecting characteristics such as electrical life and resulting in the deterioration of coil insulation.

Coating

Relays mounted on PCBs may be coated or washed. Do not apply silicone coating or detergent containing silicone, otherwise the silicone coating or detergent may remain on the surface of the Relays.

Other Handling

Please don't use the relay if it suffered the dropping shock. Because there is a possibility of something damage for initial performance.

ALL DIMENSIONS SHOWN ARE IN MILLIMETERS.

To convert millimeters into inches, multiply by 0.03937. To convert grams into ounces, multiply by 0.03527.

Cat. No. K125-E1-02