

Subminiature, Sensitive SPDT Signal Switching Relay

- High sensitivity: 98-mW pickup coil power.
- Impulse withstand voltage meets FCC Part 68 requirements.
- Fully sealed construction.
- Unique moving loop armature reduces relay size, magnetic interference, and contact bounce time.
- Single- and double-winding latching types also available.

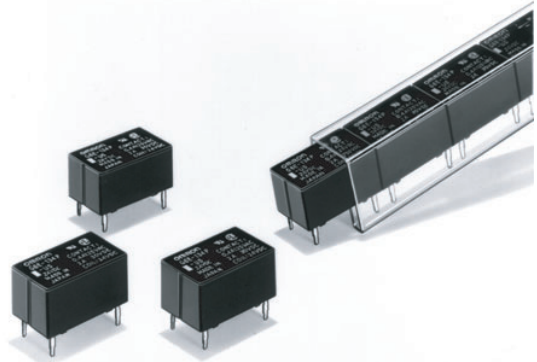

RoHS Compliant Refer to pages 16 to 17 for details.



Ordering Information

Contact form		Terminal	Single-side stable	Single-winding latching	Double-winding latching
SPDT	Bifurcated crossbar	Straight terminal	G6E-134P-US	G6EU-134P-US	G6EK-134P-US
		Self-clinching terminal	G6E-134C-US	G6EU-134C-US	G6EK-134C-US

Note: When ordering, add the rated coil voltage to the model number.
Example: G6E-134P-US 12 VDC

Rated coil voltage

Model Number Legend

G6E - - - VDC
1 2 3 4 5 6 7 8 9

1. Relay Function

None: Single-side stable
U: Single-winding latching
K: Double-winding latching

2. Contact Form

1: SPDT

3. Contact Type

3: Bifurcated crossbar
Ag (Au-Alloy) contact
9: Bifurcated crossbar
AgNi (Au-Alloy) contact

4. Enclosure Ratings

4: Fully sealed

5. Terminals

P: Straight PCB
C: Curved tail

6. Special Function

L: Low sensitivity coil (400 mW)

7. Approved Standards

US: UL, CSA certified

8. Special Function

U: For ultrasonically cleanable

9. Rated Coil Voltage

3, 5, 6, 9, 12, 24, 48 VDC

Specifications

■ Coil Ratings

Single-side Stable, Bifurcated Crossbar Contact Type

Rated voltage	3 VDC	5 VDC	6 VDC	9 VDC	12 VDC	24 VDC	48 VDC
Rated current	66.7 mA	40 mA	33.3 mA	22.2 mA	16.7 mA	8.3 mA	8.3 mA
Coil resistance	45 Ω	125 Ω	180 Ω	405 Ω	720 Ω	2,880 Ω	5,760 Ω
Coil inductance (H) (ref. value)	Armature OFF	0.08	0.18	0.31	0.62	1.20	4.70
	Armature ON	0.06	0.17	0.24	0.50	0.99	3.90
Must operate voltage	70% max. of rated voltage						
Must release voltage	10% min. of rated voltage						
Max. voltage	190% of rated voltage at 23°C						170% of rated voltage at 23°C
Power consumption	Approx. 200 mW						Approx. 400 mW

Single-winding Latching, Bifurcated Crossbar Contact Type

Rated voltage	3 VDC	5 VDC	6 VDC	9 VDC	12 VDC	24 VDC
Rated current	66.7 mA	40 mA	33.3 mA	22.2 mA	16.7 mA	8.3 mA
Coil resistance	45 Ω	125 Ω	180 Ω	405 Ω	720 Ω	2,880 Ω
Coil inductance (H) (ref. value)	Armature OFF	0.05	0.13	0.19	0.45	0.84
	Armature ON	0.04	0.12	0.17	0.40	0.79
Must set voltage	70% max. of rated voltage					
Must reset voltage	70% max. of rated voltage					
Max. voltage	190% of rated voltage at 23°C					
Power consumption	Approx. 200 mW					

Double-winding Latching, Bifurcated Crossbar Contact Type

Rated voltage	3 VDC	5 VDC	6 VDC	9 VDC	12 VDC	24 VDC	
Set coil	Rated current	66.7 mA	40 mA	33.3 mA	22.2 mA	16.7 mA	
	Coil resistance	45 Ω	125 Ω	180 Ω	405 Ω	720 Ω	
	Coil inductance (H) (ref. value)	Armature OFF	0.03	0.09	0.12	0.25	0.44
		Armature ON	0.03	0.08	0.11	0.22	0.41
Reset coil	Rated current	66.7 mA	40 mA	33.3 mA	22.2 mA	16.7 mA	
	Coil resistance	45 Ω	125 Ω	180 Ω	405 Ω	720 Ω	
	Coil inductance (H) (ref. value)	Armature OFF	0.03	0.09	0.12	0.25	0.44
		Armature ON	0.03	0.08	0.11	0.22	0.41
Must set voltage	70% max. of rated voltage						
Must reset voltage	70% max. of rated voltage						
Max. voltage	190% of rated voltage at 23°C						
Power consumption	Set coil: Approx. 200 mW Reset coil: Approx. 200 mW						

- Note:**
1. The rated current and coil resistance are measured at a coil temperature of 23°C with a tolerance of ±10%.
 2. Operating characteristics are measured at a coil temperature of 23°C.
 3. The maximum voltage is the highest voltage that can be imposed on the relay coil.

■ Contact Ratings

Load	Resistive load ($\cos\phi = 1$)	Inductive load ($\cos\phi = 0.4$; L/R = 7 ms)
Rated load	0.4 A at 125 VAC; 2 A at 30 VDC	0.2 A at 125 VAC; 1 A at 30 VDC
Contact material	Ag (Au-Alloy)	
Rated carry current	3 A	
Max. switching voltage	250 VAC, 220 VDC	
Max. switching current	3 A	3 A
Max. switching power	50 VA, 60 W	25 VA, 30 W
Failure rate (reference value) (See note.)	10 μA at 10 mVDC	

- Note:** P level: $\lambda_{60} = 0.1 \times 10^{-6}/\text{operation}$
This value was measured at a switching frequency of 120 operations/min and the criterion of contact resistance is 50 Ω. This value may vary depending on the operating environment. Always double-check relay suitability under actual operating conditions.

■ Characteristics

Contact resistance (See note 1.)	50 mΩ max.
Operate (set) time (See note 2.)	5 ms max. (approx. 2.9 ms; 48 VDC type: approx. 2.4 ms)
Release (reset) time (See note 2.)	5 ms max. (approx. 1.3 ms)
Min. set/reset signal width	Latching type: 15 ms min. (at 23°C)
Max. operating frequency	Mechanical: 36,000 operations/hr Electrical: 1,800 operations/hr (under rated load)
Insulation resistance (See note 3.)	1,000 MΩ min. (at 500 VDC)
Dielectric withstand voltage	1,500 VAC, 50/60 Hz for 1 min between coil and contacts 1,000 VAC, 50/60 Hz for 1 min between contacts of same polarity
Impulse withstand voltage	1,500 V (10 x 160 μs) (conforms to FCC Part 68)
Vibration resistance	Destruction: 10 to 55 to 10 Hz, 2.5-mm single amplitude (5-mm double amplitude) Malfunction: 10 to 55 to 10 Hz, 1.65-mm single amplitude (3.3-mm double amplitude)
Shock resistance	Destruction: 1,000 m/s ² Malfunction: 300 m/s ²
Endurance	Mechanical: 100,000,000 operations min. (at 36,000 operations/hr) Electrical: 100,000 operations min. (0.4 A at 125 VAC resistive load; 0.2 A at 125 VAC inductive load) 500,000 operations min. (2 A at 30 VDC resistive load; 1 A at 30 VDC inductive load) 200,000 operations min. (3 A at 30 VDC resistive load)
Ambient temperature	Operating: -40°C to 70°C (with no icing)
Ambient humidity	5% to 85%
Weight	Approx. 2.7 g

Note: The values here are initial values.

Note: 1. The contact resistance was measured with 1 A at 5 VDC using a voltage-drop method.

2. Values in parentheses are actual values.

3. The insulation resistance was measured with a 500-VDC megohmmeter applied to the same parts as those used for checking the dielectric strength.

■ Approved Standards

UL508 (File No. E41515)/CSA C22.2, No.14 (File No. LR31928)

Contact form	Coil ratings	Contact ratings
SPDT	3 to 48 VDC	0.2 A, 250 VAC (general use) 0.6 A, 125 VAC (general use) 2 A, 30 VDC (resistive) 0.6 A, 125 VDC (resistive, Ag contact only)

Engineering Data

Maximum Switching Power

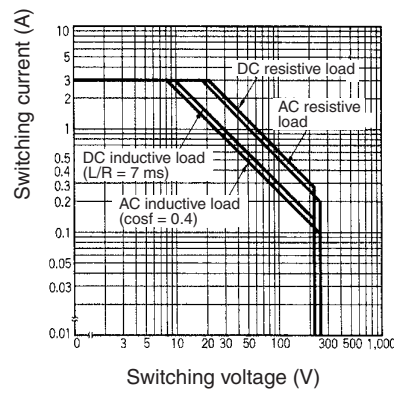

Endurance

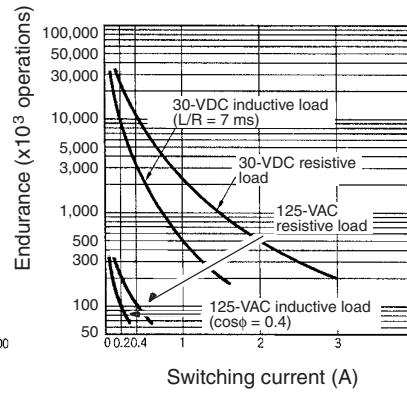

Ambient Temperature vs. Maximum Coil Voltage

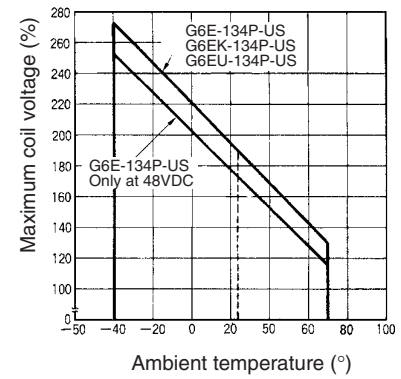

Note: The maximum coil voltage refers to the maximum value in a varying range of operating power voltage, not a continuous voltage.

Dimensions

Note: 1. All units are in millimeters unless otherwise indicated.

2. Orientation marks are indicated as follows:  

G6E-134P-US
G6E-194P-US

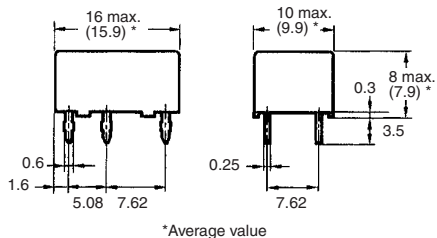
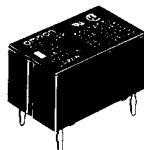

*Average value

**Terminal Arrangement/
Internal Connections
(Bottom View)**

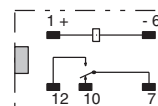

G6E-134C-US
G6E-194C-US

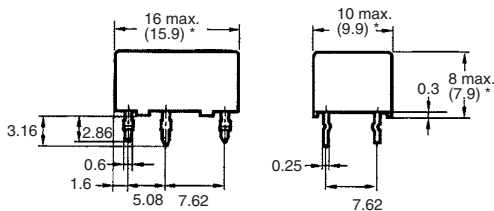
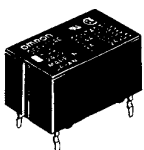

*Average value

**Mounting Holes
(Bottom View)**

Tolerance: ± 0.1

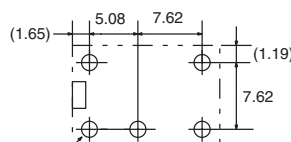

Five, 1.0-dia. holes

G6EU-134P-US
G6EU-194P-US

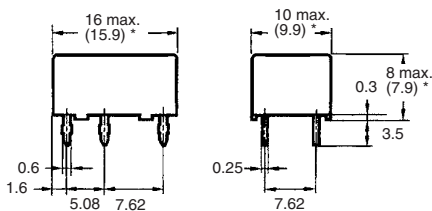
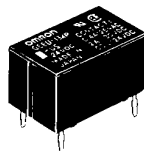

*Average value

**Terminal Arrangement/
Internal Connections
(Bottom View)**

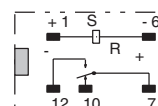

**Mounting Holes
(Bottom View)**

Tolerance: ± 0.1

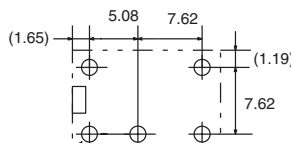

Five, 1.0-dia. holes

G6EU-134C-US
G6EU-194C-US

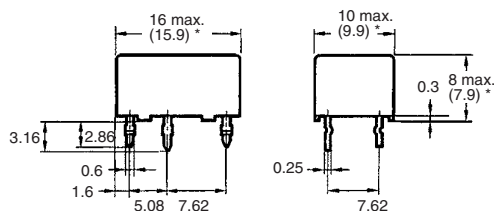
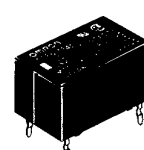

*Average value

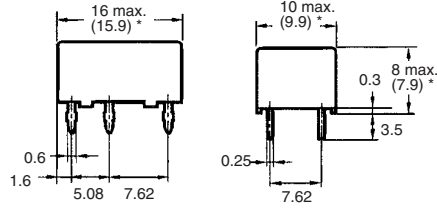
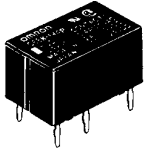
G6EK-134P-US
G6EK-194P-US

*Average value

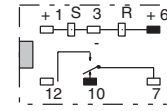
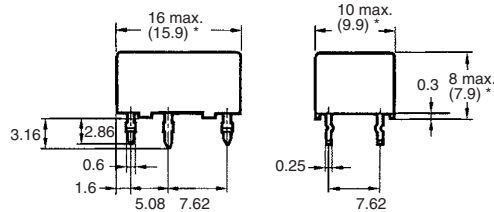
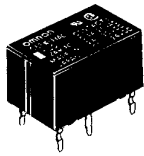
**Terminal Arrangement/
Internal Connections
(Bottom View)**

G6EK-134C-US
G6EK-194C-US

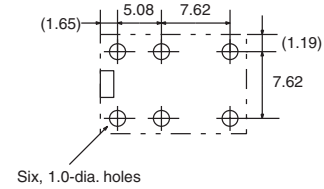
*Average value

**Mounting Holes
(Bottom View)**
Tolerance: ± 0.1 

Six, 1.0-dia. holes

Precautions

Refer to page 25 for information on general precautions. Be sure to read these precautions before using the Relay.

■ Precautions for Correct Use

Long-term Continuously ON Contacts

Using the Relay in a circuit where the Relay will be ON continuously for long periods (without switching) can lead to unstable contacts because the heat generated by the coil itself will affect the insulation, causing a film to develop on the contact surfaces. We recommend using a latching relay (magnetic-holding relay) in this kind of circuit. If a single-side stable model must be used in this kind of circuit, we recommend using a fail-safe circuit design that provides protection against contact failure or coil burnout.

Installation

Do not reverse the polarity of the coil (+, -).

Provide sufficient space between Relays when mounting two or more on the same PCB, as shown in the following diagram.

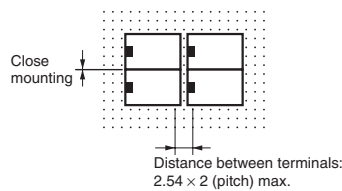

Close mounting

Distance between terminals:
2.54 × 2 (pitch) max.

Wiring

Refer to the following diagram when wiring to switch a DC load. The difference in polarity applied to the contacts will affect the endurance of the Relay due to the amount of contact movement. To extend the endurance characteristics beyond the performance ratings, wire the common (pin 7) terminal to the positive (+) side.

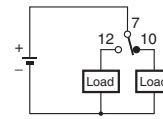

Wiring Diagram

Ultrasonic Cleaning

Do not use ultrasonic cleaning on standard relay models. Doing so may result in resonance, coil burnout, and contact adhesion within the Relay. Use a model designed for ultrasonic cleaning if ultrasonic cleaning is required.

Relay Handling

When washing the product after soldering the Relay to a PCB, use a water-based solvent or alcohol-based solvent, and keep the solvent temperature to less than 40°C. Do not put the Relay in a cold cleaning bath immediately after soldering.

ALL DIMENSIONS SHOWN ARE IN MILLIMETERS.

To convert millimeters into inches, multiply by 0.03937. To convert grams into ounces, multiply by 0.03527.