

General-purpose Relays MK-S New Model

General-purpose Relays Featuring Mechanical Indicator and Lockable Test Button

- Built-in operation indicator (mechanical and LED), and new models with lockable test button.
- Nameplate provided on models with lockable test button.
- RoHS Compliant.
- UL approval for most models. (UL approval pending for models with built-in LED indicators.)



Features

Two-way Action Test Button

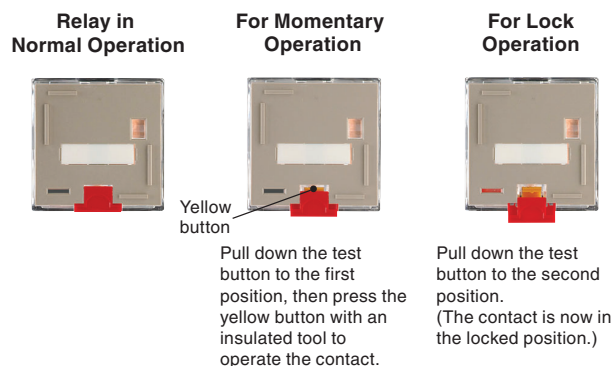

Model Number Structure

Model Number Legend

MKS□□□□□-□-□
1 2 3 4 5 6 7

1. Contact Form

- 2: DPDT
- 3: 3PDT

2. Terminals

- P: Plug-in

3. Mechanical Indicator/Test Button

- Blank: Mechanical indicator
- I: Mechanical indicator and lockable test button

4. LED Indicator

- Blank: Standard
- N: LED indicator

5. Coil Polarity

- Blank: Standard
- 1: Reverse polarity (DC coil only)

6. Surge Absorption

- Blank: Standard
- D: Surge absorber diode (DC coil only)
- V: Surge absorber varistor (AC coil only)

7. Internal Connections

- Blank: Standard
- 2 or 5: Non-standard connections (Refer to "Terminal Arrangement/Internal Connection".)

8. Rated Voltage

- (Refer to "Coil Ratings".)

Ordering Information

■ List of Models

Type	Terminals	Contact form	Internal connections (See note 3.)	With mechanical indicator	With mechanical indicator and lockable test button	Coil ratings
Standard Models	Plug-in	DPDT	Standard	MKS2P	MKS2PI	AC/DC
			Non-standard	MKS2P-2	MKS2PI-2	
		3PDT	Standard	MKS3P	MKS3PI	
			Non-Standard	MKS3P-2	MKS3PI-2	
				MKS3P-5	MKS3PI-5	
Models with LED Indicator (See note 2.)	Plug-in	DPDT	Standard	MKS2PN(1)	MKS2PIN(1)	AC/DC
			Non-standard	MKS2PN(1)-2	MKS2PIN(1)-2	
		3PDT	Standard	MKS3PN(1)	MKS3PIN(1)	
			Non-Standard	MKS3PN(1)-2	MKS3PIN(1)-2	
				MKS3PN(1)-5	MKS3PIN(1)-5	
Models with Diode (See note 2.)	Plug-in	DPDT	Standard	MKS2P(1)-D	MKS2PI(1)-D	DC
			Non-standard	MKS2P(1)-D-2	MKS2PI(1)-D-2	
		3PDT	Standard	MKS3P(1)-D	MKS3PI(1)-D	
			Non-Standard	MKS3P(1)-D-2	MKS3PI(1)-D-2	
				MKS3P(1)-D-5	MKS3PI(1)-D-5	
Models with LED Indicator and Diode	Plug-in	DPDT	Standard	MKS2PN-D	MKS2PIN-D	DC
			Non-standard	MKS2PN-D-2	MKS2PIN-D-2	
		3PDT	Standard	MKS3PN-D	MKS3PIN-D	
			Non-Standard	MKS3PN-D-2	MKS3PIN-D-2	
				MKS3PN-D-5	MKS3PIN-D-5	
Models with Varistor	Plug-in	DPDT	Standard	MKS2P-V	MKS2PI-V	AC
			Non-standard	MKS2P-V-2	MKS2PI-V-2	
		3PDT	Standard	MKS3P-V	MKS3PI-V	
			Non-Standard	MKS3P-V-2	MKS3PI-V-2	
				MKS3P-V-5	MKS3PI-V-5	
Models with LED Indicator and Varistor	Plug-in	DPDT	Standard	MKS2PN-V	MKS2PIN-V	AC
			Non-standard	MKS2PN-V-2	MKS2PIN-V-2	
		3PDT	Standard	MKS3PN-V	MKS3PIN-V	
			Non-Standard	MKS3PN-V-2	MKS3PIN-V-2	
				MKS3PN-V-5	MKS3PIN-V-5	

Note: 1. When ordering, add the rated voltage to the model number. Rated voltages are given in the coil ratings table in the specifications.

Example: MKS3P 24 VDC
_____ Rated voltage

2. The DC coil comes in two types: standard coil polarity and reverse coil polarity. Refer to *Terminal Arrangement and Internal Connections*.

Example: MKS2PIN1-2 24 VDC
_____ Reverse coil polarity

3. Refer to *Terminal Arrangement and Internal Connections* for non-standard internal connections.

■ List of Models (Order Separately)

Item	Type	Model
Track-mounted Socket	8-pin	PF083A-E
	11-pin	PF113A-E
	8-pin	PF083A-D
	11-pin	PF113A-D
Hold-down Clip (For PF083A-E and PF113A-E)		PFC-A1

Specifications

■ Ratings

Coil Ratings

Rated voltage	Rated current		Coil resistance	Must operate voltage	Must release voltage	Max. voltage	Power consumption	
	50 Hz	60 Hz						
AC	6 V	443 mA	385 mA	3.1 Ω	80% max. of rated voltage	30% min. of rated voltage at 60 Hz 25% min. of rated voltage at 50 Hz	110% of rated voltage	Approx. 2.3 VA at 60 Hz Approx. 2.7 VA at 50 Hz
	12 V	221 mA	193 mA	13.7 Ω				
	24 V	110 mA	96.3 mA	48.4 Ω				
	100 V	26.6 mA	23.1 mA	760 Ω				
	110 V	24.2 mA	21.0 mA	932 Ω				
	200 V	13.3 mA	11.6 mA	3,160 Ω				
	220 V	12.1 mA	10.5 mA	3,550 Ω				
	230 V	10.0 mA	11.5 mA	4,250 Ω				
DC	240 V	11.0 mA	9.6 mA	4,480 Ω	15% min. of rated voltage		Approx. 1.4 W	
	6 V	224 mA		26.7 Ω				
	12 V	112 mA		107 Ω				
	24 V	55.8 mA		430 Ω				
	48 V	28.1 mA		1,710 Ω				
	100 V	13.5 mA		7,390 Ω				
	110 V	12.3 mA		8,960 Ω				

- Note:**
1. The rated current and coil resistance are measured at a coil temperature of 23°C with tolerances of +15%/–20% for AC rated current and ±15% for DC coil resistance.
 2. Performance characteristic data are measured at a coil temperature of 23°C.
 3. The maximum voltage is one that is applicable instantaneously to the Relay coil at 23°C and not continuously.
 4. For DC-operated Relays with the LED indicator built-in, add an LED current of approx. 5 mA to the rated current.

Contact Ratings

Load	Resistive load (cosφ = 1)	Inductive load (cosφ = 0.4)
Contact mechanism	Single	
Contact material	AgSnIn	
Rated load	NO	7 A, 250 VAC
	NC	
Rated carry current	10 A	
Max. switching voltage	250 VAC, 250 VDC	
Max. switching current	10 A	
Max. switching power	NO	2,500 VA/300 W
	NC	

■ Characteristics

Contact resistance	100 mΩ max.
Operate time	AC: 20 ms max. DC: 30 ms max.
Release time	20 ms max. (40 ms max. for built-in Diode Relays)
Max. operating frequency	Mechanical: 18,000 operations/h Electrical: 1,800 operations/h (under rated load)
Insulation resistance	100 MΩ min. (at 500 VDC)
Dielectric strength	2,500 VAC 50/60 Hz for 1 min between coil and contacts 1,000 VAC 50/60 Hz for 1 min between contacts of same polarity and terminals of the same polarity 2,500 VAC 50/60 Hz for 1 min between current-carrying parts, non-current-carrying parts, and opposite polarity
Insulation method	Basic insulation
Impulse withstand voltage	4.5 kV between coil and contacts (with 1.2 × 50 μs impulse wave) 3.0 kV between contacts of different polarity (with 1.2 × 50 μs impulse wave)
Pollution degree	3
Rated insulation voltage	250 V
Vibration resistance	Destruction: 10 to 55 to 10 Hz, 0.75-mm single amplitude (1.5-mm double amplitude) Malfunction: 10 to 55 to 10 Hz, 0.5-mm single amplitude (1.0-mm double amplitude)
Shock resistance	Destruction: 1,000 m/s ² (approx. 100 G) Malfunction: 100 m/s ² (approx. 10 G)
Endurance	Mechanical: 5,000,000 operations min. (at 18,000 operations/h under rated load) Electrical: 100,000 operations h. (at 1,800 operations/h under rated load)
Failure rate P level (reference value)	10 mA at 1 VDC
Ambient temperature	Operating: -40 to 60°C (with no icing or condensation)
Ambient humidity	Operating: 5% to 85%
Weight	Approx. 90 g

- Note:** 1. The values given above are initial values.
2. P level: $\lambda_{60} = 0.1 \times 10^{-6}$ /operation
3. Ambient temperature of models with LED indicator is -25 to 60°C.

■ Approved Standards

UL508 (File No. E41515)

Coil ratings	Contact ratings	Operations
6 to 110 VDC 6 to 240 VAC	N.O. contact 10 A, 250 V AC 50/60 Hz (Resistive) 10 A, 30 V DC (Resistive) 7 A, 250 V AC 50/60 Hz (General Use)	6,000
	N.C. contact 5 A, 250 V AC 50/60 Hz (Resistive) 5 A, 30 V DC (Resistive) 7 A, 250 V AC 50/60 Hz (General Use)	6,000

CSA Standard: CSA Certification by

UL US: **CSA C22.2 No. 14**

Note: Applications have been submitted for UL and CSA certification for models with built-in LED indicators.

IEC Standard/TUV Certification:

IEC61810-1 (Certification No. R50104853)

Coil ratings	Contact ratings	Operations
6, 12, 24, 48, 100, 110 VDC 6, 12, 24, 100, 110, 200, 220, 240 VAC	N.O. contact 10 A, 250 V AC 50/60 Hz (Resistive) 10 A, 30 V DC (Resistive) 7 A, 250 V AC 50/60 Hz (General Use)	100,000
	N.C. contact 5 A, 250 V AC 50/60 Hz (Resistive) 5 A, 30 V DC (Resistive) 7 A, 250 V AC 50/60 Hz (General Use)	100,000

Note: When Relays are mounted on the PF083A-E or PF113A-E, the maximum carrying current is 9 A.

Engineering Data

■ Reference Data

Maximum Switching Power

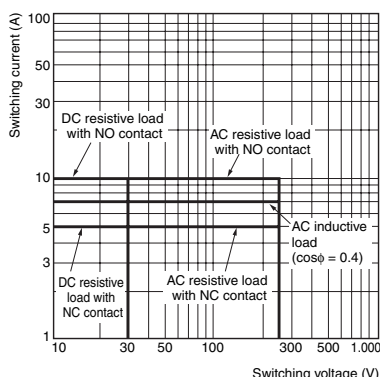

Rated Carry Current vs. Ambient Rated Temperature

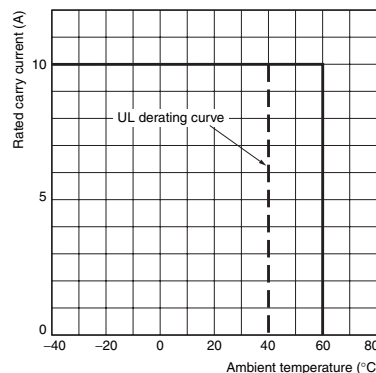

Note: The lower limit of the ambient operating temperature for models with built-in operation indicators is -25°C.

Dimensions

Note: All units are in millimeters unless otherwise indicated.

Models without Test Button

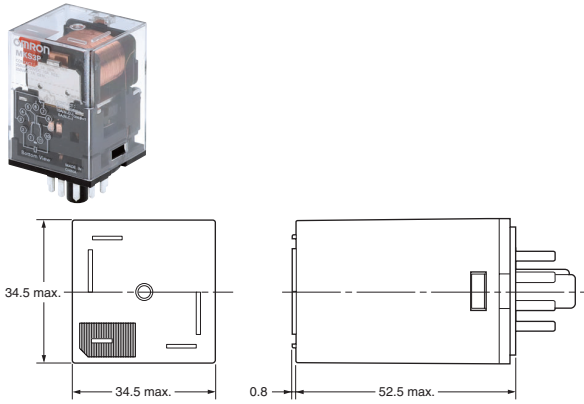

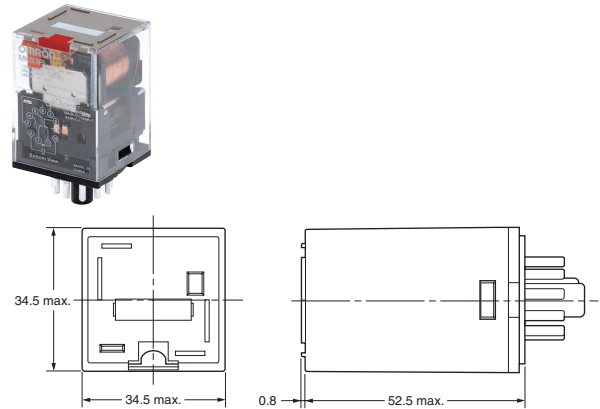

Models with Lockable Test Button

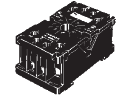
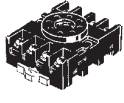

Sockets

See below for Socket dimensions.

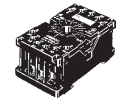
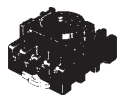
Socket	Surface-mounting Socket (for track or screw mounting)		
	Finger-protection models		---
Maximum carry current	10 A		5 A
2 poles	PF083A-E 	PF083A-D 	PF083A 
3 poles	PF113A-E 	PF113A-E-D 	PF113A 

Note: Use the Surface-mounting Sockets (i.e., finger-protection models) with "-E" at the end of the model number. When using the PF083A and PF113A, be sure not to exceed the Socket's maximum carry current of 5 A. Using at a current exceeding 5 A may lead to burning. Round terminals cannot be used for finger-protection models. Use Y-shaped terminals.

PF083A-E (Conforming to EN 50022)

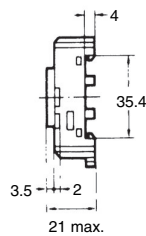
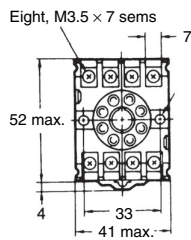

Terminal Arrangement

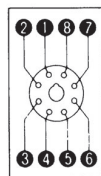

Mounting Holes

Two, M4 or two 4.5-dia. holes

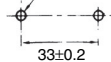

PF113A-E (Conforming to EN 50022)

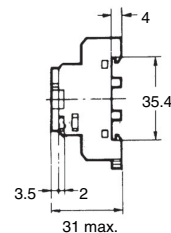
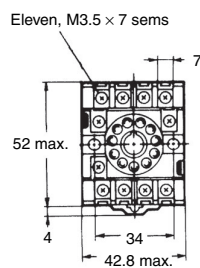

Terminal Arrangement

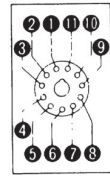

Mounting Holes

Two, M4 or two 4.5-dia. holes



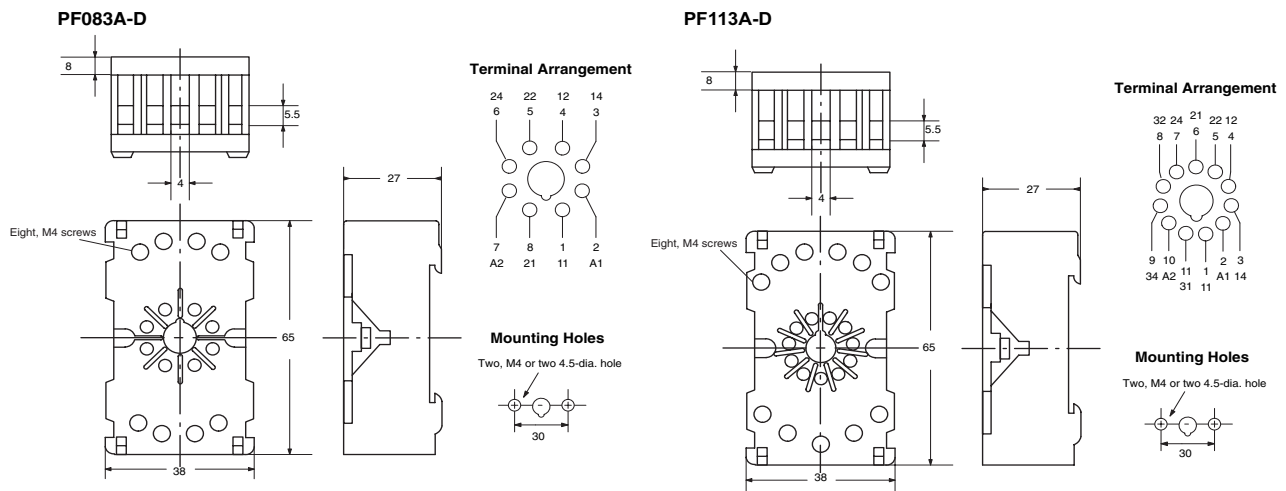

Hold-down Clips

PFC-A1

(2 pieces per set)

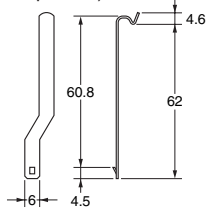

Mounting Tracks

PFP-100N, PFP-50N (Conforming to EN 50022)

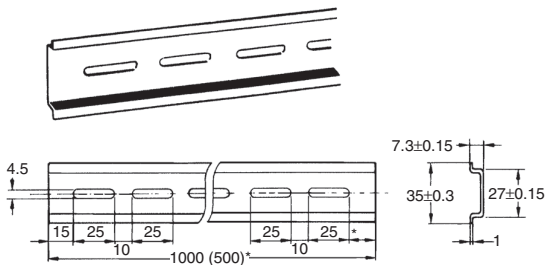

* This dimension applies to the PFP-50N Mounting Track.

PFP-100N2 (Conforming to EN 50022)

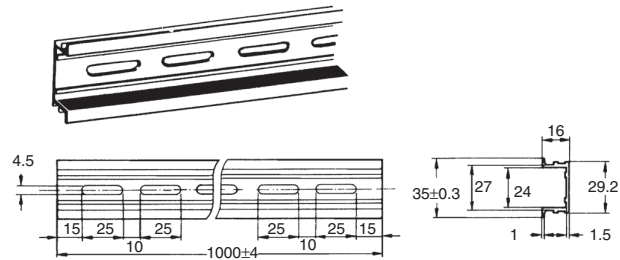

* A total of twelve 25 × 4.5 elliptic holes is provided with six holes cut from each track end at a pitch of 10 mm.

Mounting Height with Sockets

Surface-mounting Sockets

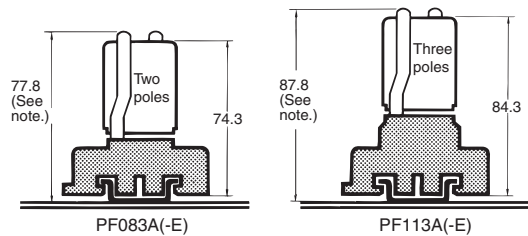

Note: PF083A(-E) and PF113A(-E) allow either track or screw mounting.

Terminal Arrangement/Internal Connection (Bottom View)

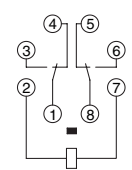
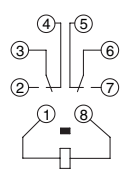
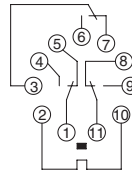
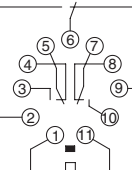
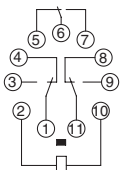
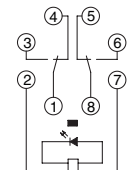
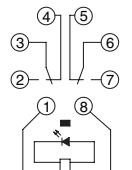
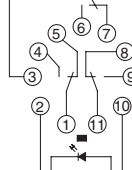
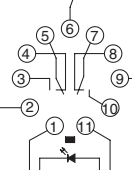
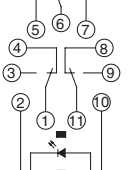
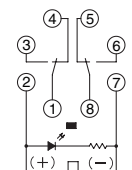
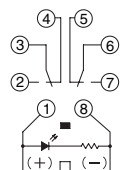
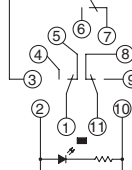
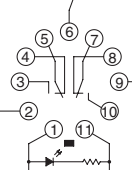
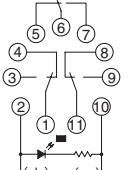
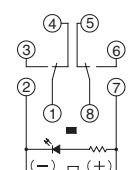
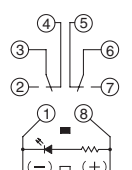
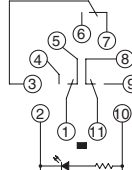
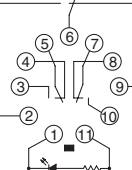
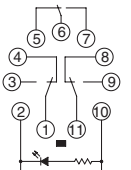
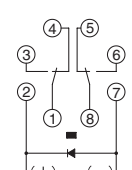
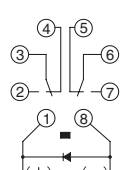
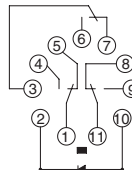
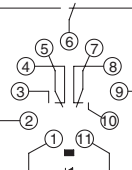
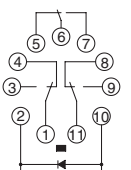
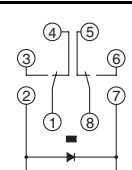
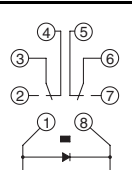
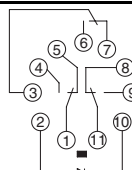
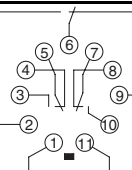
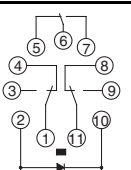
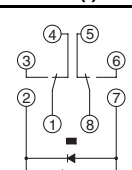
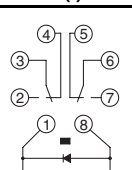
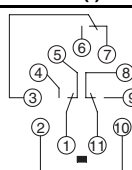
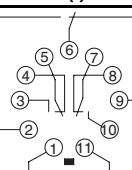
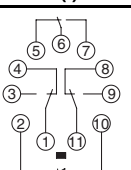
Standard Models (AC/DC Coil)	MKS2P(I) 	MKS2P(I)-2 	MKS3P(I) 	MKS3P(I)-2 	MKS3P(I)-5 
Models with LED Indicator (AC Coil)	MKS2P(I)N 	MKS2P(I)N-2 	MKS3P(I)N 	MKS3P(I)N-2 	MKS3P(I)N-5 
Models with Diode (DC Coil: Standard Polarity)	MKS2P(I)N 	MKS2P(I)N-2 	MKS3P(I)N 	MKS3P(I)N-2 	MKS3P(I)N-5 
Models with LED Indicator and Diode (DC Coil: Reverse Polarity)	MKS2P(I)N1 	MKS2P(I)N1-2 	MKS3P(I)N1 	MKS3P(I)N1-2 	MKS3P(I)N1-5 
Standard Models (DC Coil: Standard Polarity)	MKS2P(I)-D 	MKS2P(I)-D-2 	MKS3P(I)-D 	MKS3P(I)-D-2 	MKS3P(I)-D-5 
Models with Diode (DC Coil: Reverse Polarity)	MKS2P(I)1-D 	MKS2P(I)1-D-2 	MKS3P(I)1-D 	MKS3P(I)1-D-2 	MKS3P(I)1-D-5 
Models with LED indicator (DC Coil)	MKS2P(I)N-D 	MKS2P(I)N-D-2 	MKS3P(I)N-D 	MKS3P(I)N-D-2 	MKS3P(I)N-D-5 

**Models with Varistor
(AC Coil)**

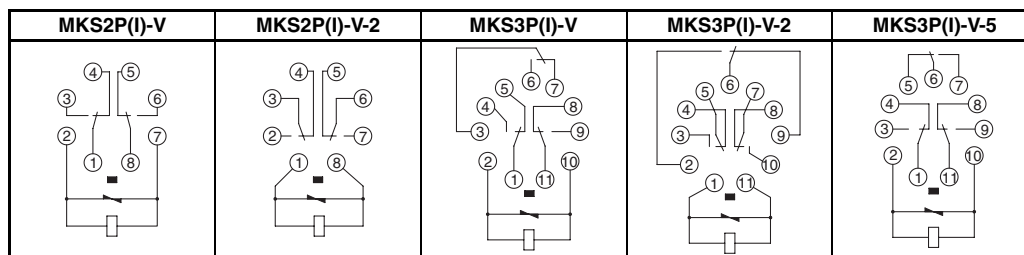

**Models with
LED indicator and
Varistor
(AC Coil)**

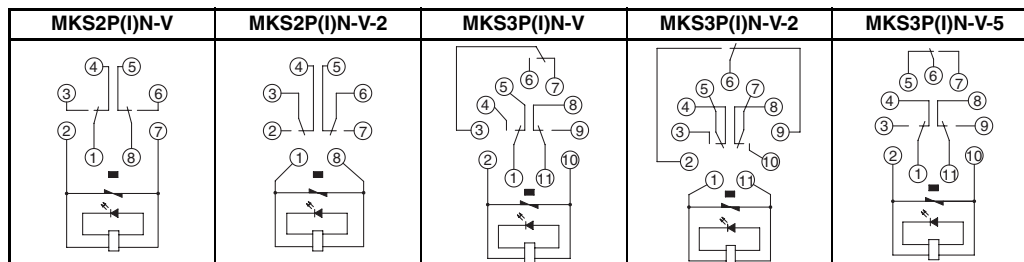

Safety Precautions

■ Safety Precautions for Correct Use

Installation

Mount the MK-S with the marking at the bottom.

Handling

Check the coil polarity of models with built-in diodes and wire them correctly (DC operation coil).

Test Button

Do not use the test button for any purpose other than testing. Be sure not to touch the test button accidentally as this will turn the contacts ON. Before using the test button, confirm that circuits, the load, and any other connected item will operate safely.

Check that the test button is released before turning ON relay circuits.

If the test button is pulled out too forcefully, it may bypass the momentary testing position and go straight into the locked position.

Use an insulated tool when you operate the test button.

Models with test buttons or LED indicators fulfill the requirements for reinforced insulation between live parts and the front of cover only when the Relay is in a complete condition, i.e. with the nameplate, nameplate frame, test button, and slider in place. If any of these parts are removed, only the requirements for basic insulation are fulfilled.

Warranty and Application Considerations

Read and Understand this Catalog

Please read and understand this catalog before purchasing the products. Please consult your OMRON representative if you have any questions or comments.

Warranty and Limitations of Liability

WARRANTY

OMRON's exclusive warranty is that the products are free from defects in materials and workmanship for a period of one year (or other period if specified) from date of sale by OMRON.

OMRON MAKES NO WARRANTY OR REPRESENTATION, EXPRESS OR IMPLIED, REGARDING NON-INFRINGEMENT, MERCHANTABILITY, OR FITNESS FOR PARTICULAR PURPOSE OF THE PRODUCTS. ANY BUYER OR USER ACKNOWLEDGES THAT THE BUYER OR USER ALONE HAS DETERMINED THAT THE PRODUCTS WILL SUITABLY MEET THE REQUIREMENTS OF THEIR INTENDED USE. OMRON DISCLAIMS ALL OTHER WARRANTIES, EXPRESS OR IMPLIED.

LIMITATIONS OF LIABILITY

OMRON SHALL NOT BE RESPONSIBLE FOR SPECIAL, INDIRECT, OR CONSEQUENTIAL DAMAGES, LOSS OF PROFITS, OR COMMERCIAL LOSS IN ANY WAY CONNECTED WITH THE PRODUCTS, WHETHER SUCH CLAIM IS BASED ON CONTRACT, WARRANTY, NEGLIGENCE, OR STRICT LIABILITY.

In no event shall the responsibility of OMRON for any act exceed the individual price of the product on which liability is asserted.

IN NO EVENT SHALL OMRON BE RESPONSIBLE FOR WARRANTY, REPAIR, OR OTHER CLAIMS REGARDING THE PRODUCTS UNLESS OMRON'S ANALYSIS CONFIRMS THAT THE PRODUCTS WERE PROPERLY HANDLED, STORED, INSTALLED, AND MAINTAINED AND NOT SUBJECT TO CONTAMINATION, ABUSE, MISUSE, OR INAPPROPRIATE MODIFICATION OR REPAIR.

Application Considerations

SUITABILITY FOR USE

OMRON shall not be responsible for conformity with any standards, codes, or regulations that apply to the combination of products in the customer's application or use of the products.

Take all necessary steps to determine the suitability of the product for the systems, machines, and equipment with which it will be used.

Know and observe all prohibitions of use applicable to this product.

NEVER USE THE PRODUCTS FOR AN APPLICATION INVOLVING SERIOUS RISK TO LIFE OR PROPERTY WITHOUT ENSURING THAT THE SYSTEM AS A WHOLE HAS BEEN DESIGNED TO ADDRESS THE RISKS, AND THAT THE OMRON PRODUCTS ARE PROPERLY RATED AND INSTALLED FOR THE INTENDED USE WITHIN THE OVERALL EQUIPMENT OR SYSTEM.

Disclaimers

PERFORMANCE DATA

Performance data given in this catalog is provided as a guide for the user in determining suitability and does not constitute a warranty. It may represent the result of OMRON's test conditions, and the users must correlate it to actual application requirements. Actual performance is subject to the OMRON *Warranty and Limitations of Liability*.

CHANGE IN SPECIFICATIONS

Product specifications and accessories may be changed at any time based on improvements and other reasons. Consult with your OMRON representative at any time to confirm actual specifications of purchased product.

DIMENSIONS AND WEIGHTS

Dimensions and weights are nominal and are not to be used for manufacturing purposes, even when tolerances are shown.

ALL DIMENSIONS SHOWN ARE IN MILLIMETERS.

To convert millimeters into inches, multiply by 0.03937. To convert grams into ounces, multiply by 0.03527.

Cat. No. J168-E1-01 **In the interest of product improvement, specifications are subject to change without notice.**

OMRON Corporation

Industrial Automation Company

Control Devices Division H.Q.

Shiokoji Horikawa, Shimogyo-ku,

Kyoto, 600-8530 Japan

Tel: (81)75-344-7109/Fax: (81)75-344-7149

Printed in Japan

????-?M (????) (?)