

Modular components

Selection :
pages 1/516 to 1/519
Characteristics :
pages 1/520 and 1/521
References :
pages 1/522 and 1/523
Dimensions and schemes :
pages 1/524 and 1/525

Standard contactors, type GC

Presentation and standards

Presentation

Designed for use in modular panels and enclosures, these contactors feature :

- **Easy installation**
 - quick clip-on fixing onto 35 mm omega rail,
 - easy connection by means of ready-to-tighten captive, pozidrive screw terminals.
- **Compact size**

All units have a common depth of 60 mm and width in modules of 17.5 mm (width of one module : 17.5 mm).
- **User safety**
 - use of materials conforming to strictest fire safety standards,
 - live parts protected against direct finger contact,
 - completely safe operation,
 - indication of contact state on front face.

Standards

The new range of modular contactors has been designed taking into account the requirements of **new international standards IEC 1095 and EN 61095**.

This standard is specific to :

"Electromagnetic contactors for domestic and similar use".

It has very strict requirements, meeting the expectations of users, with regard to the safety of equipment and persons in "premises and areas accessible to the public".

Conformity with this standard makes it possible to obtain the following quality labels without the need for additional tests: NF-USE, VDE, CEBEC.

Applications

Modular contactors are designed for switching single-phase, 3-phase or 4-phase resistive loads up to 100 A.

Power switching

The new range of contactors has multiple applications in industrial, agricultural and commercial premises, hospitals and the home, i.e. wherever switching of a specific supply is required. For example :

- lighting,
- heating,
- ventilation,
- motorised shutters or gates.

1

GC-25

1-10

Modular components

Selection :
 pages 1/516 to 1/519
 Characteristics :
 pages 1/520 and 1/521
 References :
 pages 1/522 and 1/523
 Dimensions and schemes :
 pages 1/524 and 1/525

Standard contactors, type GC

Setting-up precautions

Setting-up precautions

The contactor controls must be bounce free. If not, connect a coil suppression block (GAP-21, 22 or 23) across the coil terminals ≤ 250 V (ref. 1).
 When several contactors which operate at the same time are mounted side by side, a GAC-5 ventilation 1/2 module must be fitted every 2 contactors (ref. 2).

It is advisable to mount electronic units at the bottom of the modular panel and to separate them from electromechanical units by a space equal to one module (ref. 3) or by 2 ventilation modules GAC-5.

1

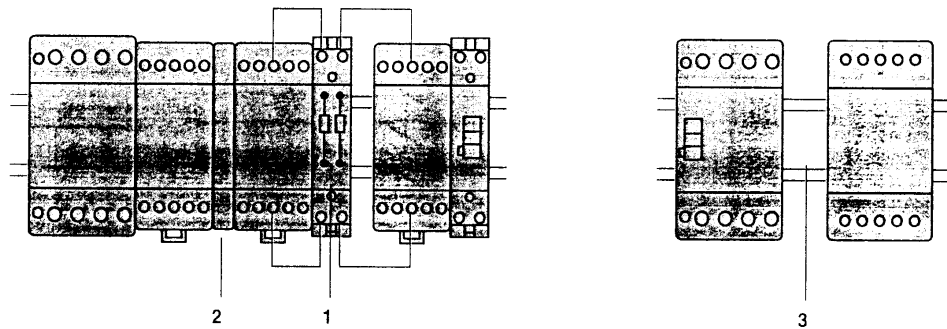

Derating of contactors mounted in a modular enclosure if the temperature within the enclosure is > 40 °C

40 °C	50 °C	60 °C (1)	Contactor rating
16 A	14 A	13 A	16 A
25 A	22 A	20 A	25 A
40 A	36 A	32 A	40 A
63 A	57 A	50 A	63 A
100 A	87 A	80 A	100 A

(1) Ventilation 1/2 module must be fitted

10

Modular components

Selection :
pages 1/516 to 1/519
Characteristics :
pages 1/520 and 1/521
References :
pages 1/522 and 1/523
Dimensions and schemes :
pages 1/524 and 1/525

Modular contactors

Contactors selection for lighting circuits

Lighting (Maximum number of lamps depending on the power of each unit)

Presentation of installations according to type of supply:
Single-phase circuit, 230 V

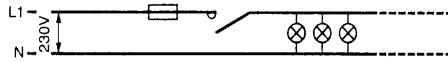

3-phase circuit, 230 V

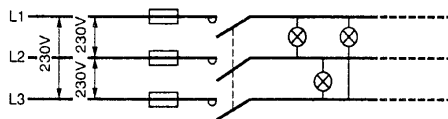

3-phase circuit, 400 V (with neutral)

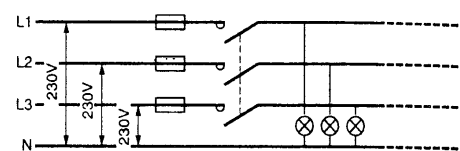

The maximum number of lamps which can be operated per phase is equal to the number of lamps in the "single-phase 230 V" table divided by $\sqrt{3}$.

The maximum number of lamps which can be operated per phase is equal to the total number of lamps in the "single-phase 230 V" table.

Contactors rating indicated below for a single-phase 230 V circuit (single-pole).

Fluorescent lamps with starter

Single fitting	Non corrected					With parallel correction					Contactor rating
	P in W	I in A	C in μ F	Maximum number of lamps		P in W	I in A	C in μ F	Maximum number of lamps		
	20	0.39	-	22	30	20	0.43	-	20	30	16 A
	40	0.43	-	28	46	40	0.70	-	25	46	25 A
	50	0.70	-	17	27	50	0.80	-	16	27	40 A
	80	0.80	-	10	16	80	1.2	-	10	16	63 A
	110	1.2	-	7	10	110	1.2	-	7	10	63 A
	20	0.19	5	15	20	40	0.29	7	15	20	16 A
	40	0.46	7	15	20	58	0.57	7	15	20	25 A
	80	0.79	16	10	14	80	1.2	16	10	14	40 A
	110	1.2	20	7	10	110	1.2	20	7	10	63 A
Twin fitting	Non corrected					With series correction					Contactor rating
P in W	I in A	C in μ F	Maximum number of lamps		P in W	I in A	C in μ F	Maximum number of lamps			
	2 x 18	0.44	-	20	30	2 x 18	0.26	3.5	15	20	16 A
	2 x 36	0.82	-	11	16	2 x 36	0.48	4.5	11	16	25 A
	2 x 58	1.34	-	7	10	2 x 58	0.78	7	7	10	40 A
	2 x 80	1.64	-	5	8	2 x 80	1.2	9	5	8	63 A
	2 x 140	2.2	-	4	6	2 x 140	1.2	18	4	6	63 A
	75	1.2	-	15	20	123	1.2	20	15	20	16 A
	42	1.2	-	10	16	67	1.2	16	10	16	25 A
	25	1.2	-	7	10	42	1.2	10	7	10	40 A
	21	1.2	-	5	6	34	1.2	6	5	6	63 A
	16	1.2	-	4	6	25	1.2	6	4	6	63 A

High pressure mercury vapour lamps

P in W	Non corrected						With parallel correction						Contactor rating		
	Ib in A	C in μ F	Maximum number of lamps				P in W	Ib in A	C in μ F	Maximum number of lamps					
50	0.6	-	15	20	34	53	50	0.35	7	10	15	20	28	43	16 A
80	0.8	-	10	15	27	40	80	0.50	8	10	13	20	25	38	25 A
125	1.15	-	8	10	20	28	125	0.7	10	10	10	11	20	17	40 A
250	2.15	-	4	6	10	15	250	1.5	18	4	6	8	12	7	63 A
400	3.25	-	2	4	6	10	400	2.4	25	3	2	4	5	5	63 A
700	5.4	-	1	2	4	6	700	4	40	2	1	3	3	5	63 A
1000	5.7	-	-	-	-	-	1000	5.7	60	-	-	-	-	-	63 A

Ib : value of current drawn by each lamp at its rated operational voltage.

C : unit capacitance for each lamp.

P and C correspond to values normally quoted by lamp manufacturers.



Modular components

Selection :
pages 1/516 to 1/519
Characteristics :
pages 1/520 and 1/521
References :
pages 1/522 and 1/523
Dimensions and schemes :
pages 1/524 and 1/525

Modular contactors

Contactors selection for lighting circuits

Lighting (maximum number of lamps depending on the power of each unit)

Contactor rating indicated below for a single-phase 230 V circuit (single-pole).

Low pressure sodium vapour lamps

	Non corrected						With parallel correction						Contactor rating
	P in W	18	35	55	90	135	180	18	35	55	90	135	
I _a in A	0.35	1.4	1.4	2.1	3.1	3.1	0.35	0.6	0.6	0.9	0.9	0.9	0.9
C in µF	-	-	-	-	-	-	5	20	20	26	45	40	-
Maximum number of lamps	18	4	5	3	2	2	14	3	3	2	1	1	16A
	34	9	9	6	4	4	21	5	5	4	2	2	25 A
	57	14	14	9	6	6	40	10	10	8	4	5	40 A
	91	24	24	19	10	10	60	15	15	11	6	7	63 A

High pressure sodium vapour lamps

	Non corrected					With parallel correction					Contactor rating
	P in W	70	150	250	400	1000	70	150	250	400	
I _a in A	1	1.8	3	4.4	10.3	0.6	0.7	1.5	2.5	6	-
C in µF	-	-	-	-	-	12	12	32	25	45	-
Maximum number of lamps	8	4	2	1	-	6	6	2	2	1	16 A
	12	7	4	3	1	9	9	3	4	2	25 A
	20	13	8	5	2	18	18	6	8	4	40 A
	32	18	11	8	3	25	25	9	12	6	63 A

Metal iodine or halogen vapour lamps

	Non corrected						With parallel correction						Contactor rating	
	P in W	35	70	150	250	400	1000	39	70	150	250	400		1000
I _a in A	0.3	0.5	1	1.5	2.5	6	0.3	0.5	1	1.5	2.5	6	5.5	
C in µF	-	-	-	-	-	-	6	12	20	32	45	85	60	
Maximum number of lamps	27	16	8	5	3	1	12	6	4	3	2	-	1	16 A
	40	24	12	8	5	2	18	9	6	4	3	1	2	25 A
	68	42	20	14	8	4	31	16	10	7	5	3	3	40 A
	106	64	32	21	13	5	50	25	15	10	7	4	5	63 A

Incandescent and halogen lamps

									Contactor rating
	P in W	60	75	100	150	200	300	500	
I _a in A	0.26	0.32	0.44	0.65	0.87	1.30	2.17	4.4	-
Maximum number of lamps	30	25	19	12	10	7	4	2	16A
	45	38	28	18	14	10	6	3	25 A
	85	70	50	35	26	18	10	6	40 A
	125	100	73	50	37	25	15	8	63 A

Halogen lamps used with transformer

					Contactor rating
	P in W	60	80	105	
I _a in A	0.26	0.35	0.45	0.65	-
Maximum number of lamps	9	8	6	4	16 A
	14	12	9	6	25 A
	27	23	18	13	40 A
	40	35	27	19	63 A

I_a : value of current drawn by each lamp at its rated operational voltage.

C : unit capacitance for each lamp.

I_a and C correspond to values normally quoted by lamp manufacturers.

Modular components

Modular contactors

Characteristics :
pages 1/520, 1/521
References :
pages 1/522, 1/523
Dimensions and schemes :
pages 1/524, 1/525

Selection for heating circuits

1

Heating (AC-7a)

Single-phase, 2-pole switching

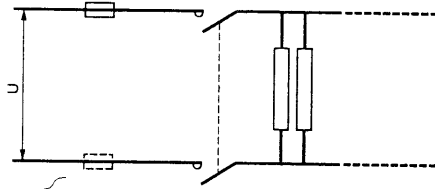

3-phase switching

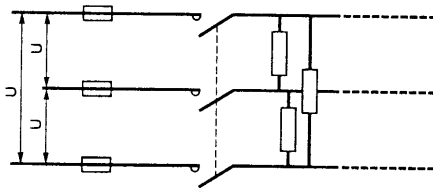

Heating by resistive elements or by infra-red radiators, convectors or radiators, heating ducts, industrial furnaces. The current peak between the hot and cold states must not exceed 2 to 3 In at the moment of switch-on.

Maximum power in kW according to electrical durability

Electrical durability in operating cycles	100 x 10 ³	150 x 10 ³	200 x 10 ³	500 x 10 ³	10 ⁶	Contactor rating
Single-phase switching 230 V (2-pole)	3.5	3	2.2	1	0.8	16 A
	5.4	4.6	3.5	1.6	1.2	25 A
	8.6	7.4	5.6	2.6	1.9	40 A
	13.6	11.6	8.8	4	3	63 A
	21.6	18.4	14	6.4	4.8	100 A
3-phase switching 400 V (3-pole)	10	9	6.5	3.2	2.2	16 A
	16	14	10	5	3.5	25 A
	26	22	17	7.5	6	40 A
	41	35	26.5	12	9	63 A
	64.8	55.2	42	19.2	14.4	100 A

Modular components

Modular contactors

Characteristics :
pages 1/520, 1/521
References :
pages 1/522, 1/523
Dimensions and schemes :
pages 1/524, 1/525

Selection for motor control

Motor control (AC-7b)

Single-phase circuit, 230 V

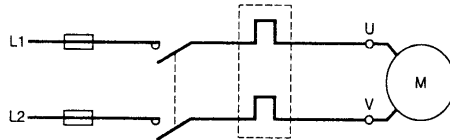

3-phase circuit, 400 V

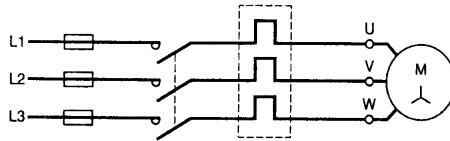

Maximum power in kW

230 V single-phase capacitor motor (2-pole)	400 V 3-phase motor	Contactor rating (lth)
0.55	2.2	16 A
1.1	4	25 A
2.2	7.5	40 A
4	11	63 A



Modular components

Standard contactors, type GC

Selection :
pages 1/516 to 1/519
References :
pages 1/522 and 1/523
Dimensions and schemes :
pages 1/524 and 1/525

Characteristics

Type	GC16	GC25	GC40	GC63	GC100
------	------	------	------	------	-------

Environment

Rated insulation voltage (Ui)	Conforming to IEC 1095, EN 16095	V	500
	Conforming to VDE 0110	V	500
Rated impulse withstand voltage (Uimp)		kV	4 in enclosure
Conforming to standards			IEC 1095, EN 61095, VDE 0660 and IEC 947-5 for auxiliary contacts
Approvals			NF- USE, VDE, CEBEC, ÖVE
Degree of protection	Conforming to VDE 0106		Protection against direct finger contact (IP 20 open, IP 40 in enclosure)
Protective treatment	Standard version		"TC"
Ambient air temperature around the device	Storage	°C	- 40... + 70
	Operation	°C	- 5... + 50 (0.85...1.1 Uc)
Maximum operating altitude	Without derating	m	3000
Operating positions	Without derating		± 30° in relation to normal vertical mounting position
Shock resistance 1/2 sine wave = 10 ms	Contacteur open		10 g
	Contacteur closed		15 g
Vibration resistance 5...300 Hz	Contacteur open		2 g
	Contacteur closed		3 g
Flame resistance Opacity and toxicity of fumes			Conforming to IEC 1095, EN 61095 Conforming to NF F 16-101 and 16-102

Pole characteristics

Number of poles			2, 3 or 4					
Rated operational current (Ie) (Ue ≤ 440 V)	In AC-7a (heating)	A	16	25	40	63	100	
	In AC-7b (motor control)	A	5	8.5	15	25	-	
Rated operational voltage (Ue)	Up to	V	250 two-pole contactors, 415 three and four-pole contactors					
Frequency limits	Of the operational current	Hz	400					
Conventional thermal current (Ith)	θ ≤ 50 °C	A	16	25	40	63	100	
Rated making and breaking capacity	Conforming to IEC 1095 (AC-7b) I rms 400 V 3-phase	A	40	68	120	200	-	
Permissible short time rating with no current flow for the previous 15 minutes and with θ ≤ 40 °C	For 10 s	A	128	200	320	504	800	
	For 30 s	A	40	62	100	157	250	
Short-circuit protection by fuse or circuit breaker U ≤ 440 V	gG fuse	A	16	25	40	63	100	
	Circuit breaker I ² t (at 3 kA rms prospective)	230 V	A ² s	5000	10000	16000	18000	-
		400 V	A ² s	9000	14000	17500	20000	-
Average impedance per pole	At Ith and 50 Hz	mΩ	2.5	2.5	2	2	2	
Power dissipated per pole	For the above operational currents	W	0.65	1.6	1.6	1.6	3.2	
Maximum cabling c.s.a.	Flexible cable without cable end	1 conductor	mm ²	6	6	25	25	35
		2 conductors	mm ²	4	4	16	16	-
	Flexible cable with cable end	1 conductor	mm ²	6	6	16	16	35
		2 conductors	mm ²	1.5	1.5	4	4	-
	Solid cable without cable end	1 conductor	mm ²	6	6	25	25	35
		2 conductors	mm ²	4	4	16	16	35

Modular components

Standard contactors, type GC

Selection
pages 1.521 and 1.522
References
pages 1.522 and 1.523
Dimensions and schemes
pages 1.524 and 1.525

Characteristics

Type		GC16, GC25 single or 2-pole	GC16, GC25 3 or 4-pole	GC40, GC63 3 or 4-pole	GC100 4-pole
			GC40, GC63 2-pole	GC100 2-pole	

Control circuit characteristics

Rated control circuit voltage (Uc)	50 or 60 Hz	V	12...240 V, for other voltages, please consult your Regional Sales Office				
Control voltage limits ($\theta \leq 50^\circ\text{C}$)	50 Hz coils	Operational	0.85...1.1 Uc				
		Drop out	0.2...0.75 Uc				
Average coil consumption at 20 °C and at Uc ~ 50 Hz		Inrush	VA	15	34	53	106
		Sealed	VA	3.8	4.6	6.5	13
Maximum heat dissipation	50/60 Hz	W	1.3	1.6	2.1	4.2	
Operating times (1)		Closing "C"	ms	10...30			
		Opening "O"	ms	10...25			
Mechanical durability	In operating cycles		10 ⁶				
Maximum operating rate at ambient temperature $\leq 50^\circ\text{C}$	In operating cycles per hour		300				
Maximum cabling c.s.a.	Flexible cable without cable end	1 or 2 conductors	mm ²	2.5			
	Flexible cable with cable end	1 conductor	mm ²	2.5			
		2 conductors	mm ²	1.5			
	Solid cable without cable end	1 or 2 conductors	mm ²	1.5			
Tightening torque		N.m	1.4				

Instantaneous auxiliary contact characteristics

Rated operational voltage (Ue)	Up to	V	250
Rated insulation voltage (Ui)	Conforming to IEC 947-5	V	500
	Conforming to VDE 0110	V	500
Conventional thermal current (Ith)	For ambient $\theta \leq 50^\circ\text{C}$	A	5
Mechanical durability	Operating cycles		10 ⁶
Maximum cabling c.s.a.	Flexible or solid conductor	mm ²	2.5
Tightening torque		N.m	1.4

Modular components

Standard contactors, type GC

Selection :
pages 1/516 to 1/519
Characteristics :
pages 1/520 and 1/521
Dimensions and schemes :
pages 1/524 and 1/525

References

Maximum current rating category AC-1	Number of poles		Number of 17.5 mm modules	Sold in lots of	Basic reference. Complete with code indicating control circuit voltage (2)	Weight kg
	d	b				
A						
16	1	-	1	12	GC-1610●●	0.110
	2	-	1	12	GC-1620●●	0.110
	4	-	2	6	GC-1640●●	0.230
	1	1	1	12	GC-1611●●	0.110
	2	2	2	6	GC-1622●●	0.230
25	1	-	1	12	GC-2510●●	0.110
	2	-	1	12	GC-2520●●	0.110
	3	-	2	6	GC-2530●●	0.230
	4	-	2	6	GC-2540●●	0.230
	1	1	1	12	GC-2511●●	0.110
	2	2	2	6	GC-2522●●	0.230
	-	2	1	12	GC-2502●●	0.110
	-	4	2	6	GC-2504●●	0.230
40	2	-	2	6	GC-4020●●	0.230
	3	-	3	4	GC-4030●●	0.350
	4	-	3	4	GC-4040●●	0.390
	1	1	2	6	GC-4011●●	0.230
	2	2	3	4	GC-4022●●	0.390
	-	2	2	6	GC-4002●●	0.230
	-	4	3	4	GC-4004●●	0.390
	63	2	-	2	6	GC-6320●●
3		-	3	4	GC-6330●●	0.390
4		-	3	4	GC-6340●●	0.390
1		1	2	6	GC-6311●●	0.340
2		2	3	4	GC-6322●●	0.390
-		2	2	6	GC-6302●●	0.340
-		4	3	4	GC-6304●●	0.390
100		2	-	3	4	GC-10020●●▲
	4	-	6	2	GC-10040●●▲	0.780

(2) Standard control circuit voltages (variable delivery times, please consult your Regional Sales Office).

Volts	12	24	48	110	220/240
50 Hz	J5	B5	E5	F5	M5
60 Hz	J6	B6	E6	F6	M6



GC-2520

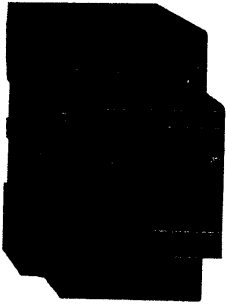

GC-4040

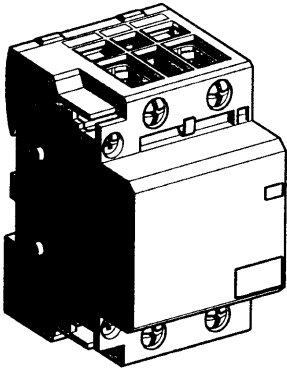

GC-10020

Modular components

Standard contactors, type GC

Selection :
pages 1/516 to 1/519
Characteristics :
pages 1/520 and 1/521
Dimensions and schemes :
pages 1/524 and 1/525

References

Instantaneous auxiliary contact blocks



GAC-05●●

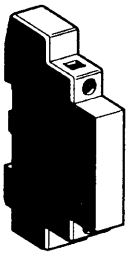

GAP-2●

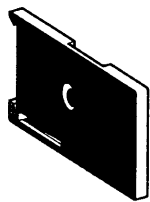

GAC-5



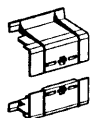

GA1-C●

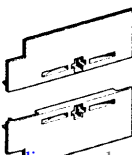

GW-254



Number of contacts	Number of poles			Reference	Weight kg
					
2	1	1	-	GAC-0521	0.016
-	-	2	-	GAC-0531	0.016
-	-	-	1	GAC-0511	0.016

Accessories

Description	For use on contactor	Number of modules	Operational voltage in V	Sold in lots of	Unit reference	Weight kg
Coil suppression block comprising 2 RC circuits	-	1	24...48	10	GAP-21	0.090
	-	-	48...110	10	GAP-22	0.090
	-	-	220...240	10	GAP-23	0.090
Ventilation 1/2 module clips onto  rail	-	1/2	-	10	GAC-5	0.015
Cover plates	-	1/2	-	10	GA1-C7	0.001
	-	1	-	10	GA1-C6	0.001
Sealable terminal covers (1 top part + 1 bottom part)	16 or 25 A 3 or 4 contacts	2	-	1	GW-254	0.040
	40 or 63 A 2 contacts	2	-	1	GW-632	0.040
	40 or 63 A 3 or 4 contacts	3	-	1	GW-634	0.050

1

10

Modular components

Selection :
pages 1/516 to 1/519
Characteristics :
pages 1/520 and 1/521
References :
pages 1/522 and 1/523
Dimensions and schemes :
page 1/525

Standard contactors, type GC

Dimensions

Contactors

Common side view

1

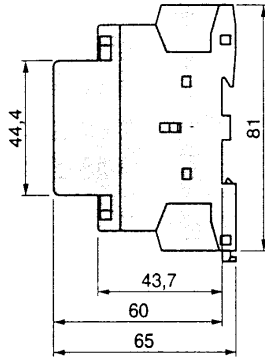

GC-1610, 1611, 1620
GC-2502, 2510, 2511, 2520
1 module

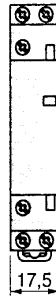

GC-1622, 1640
GC-2504, 2522, 2530, 2540
2 modules

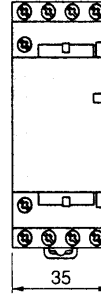

GC-4002, 4011, 4020
GC-6302, 6311, 6320
2 modules

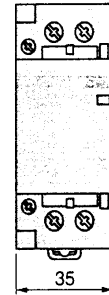

GC-4004, 4022, 4030, 4040
GC-6304, 6322, 6330, 6340
3 modules

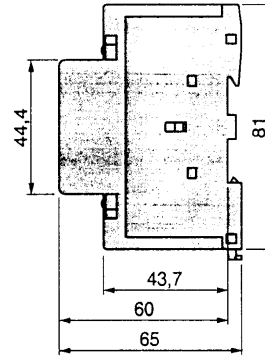
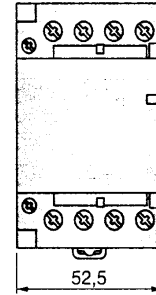

GC-10020
3 modules

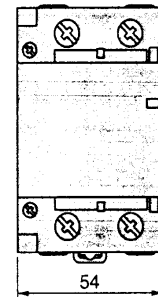

GC-10040
6 modules

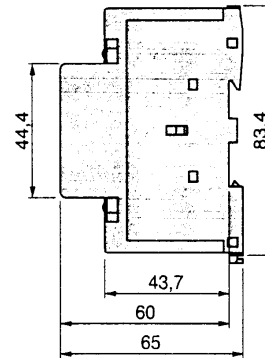
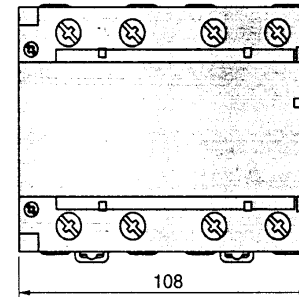

10

Modular components

Selection :
pages 1/516 to 1/519
Characteristics :
pages 1/520 and 1/521
References :
pages 1/522 and 1/523
Dimensions :
page 1/524

Standard contactors, type GC

Dimensions, schemes

Dimensions

Auxiliary contacts
GAC-0511, 0531 and 0521

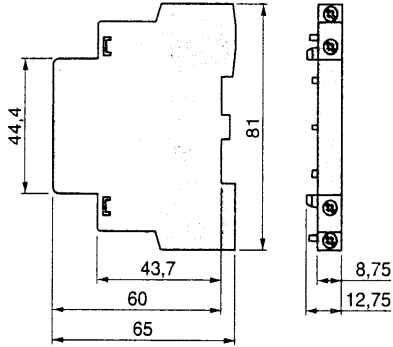

Coil suppression block
GAP-21, 22, and 23

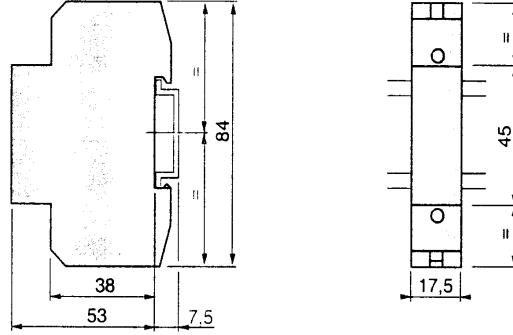

Clip-on ventilation module
GAC-5

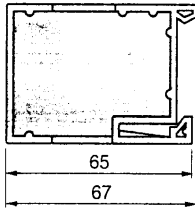

Cover plates
GA1-C6

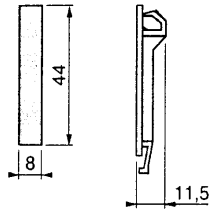

GA1-C7

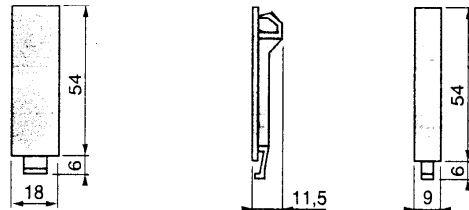

Schemes

contactors
GC-●●10

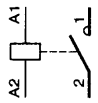

GC-●●20

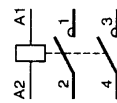

GC-●●30

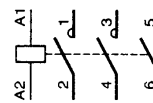

GC-●●40

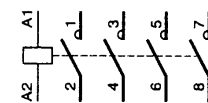

GC-●●11

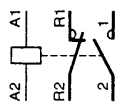

GC-●●22

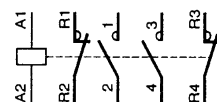

GC-●●02

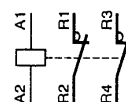

GC-●●04

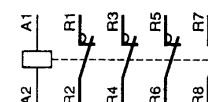

Auxiliary contacts
GAC-0521

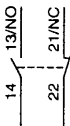

GAC-0531

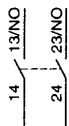

GAC-0511

