

Slim, Miniature Relay with 1-pole 5-A Switching Capability

- RoHS compliant.
- Slim 5-mm width and miniature size. (20.3 x 5.08 x 12.5 mm max.)
- Ideal for high-density mounting.
- Delivers high switching performance (5 A at 250 VAC/30 VDC) and enables various loads all in a slim, miniature size.
- Highly sensitive coil type (120 mW) also available.
- Satisfies EN 61131-2 (PLC) and EN 61010 (measuring instrument/control equipment) reinforced insulation requirement.

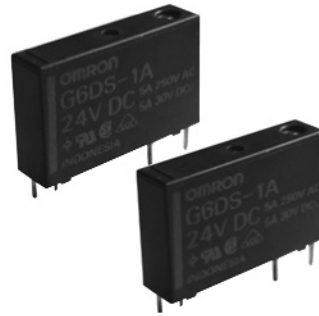

Application Examples

PLCs, I/O modules, I/O ports, Timers, Temperature Controllers, and Control Boards.

Ordering Information

Classification	Contact form	Enclosure ratings	Model
Standard	SPST-NO	Fully sealed	G6DS-1A
High-sensitivity			G6DS-1A-H

Note: When ordering, add the rated coil voltage to the model number.

Example: G6DS-1A 12 VDC

Rated coil voltage

Model Number Legend

G6DS - - VDC
 1 2 3 4

1. Number of Poles

1: 1 pole

2. Contact Form

A: SPST-NO

3. Classification

None: Standard

H: High-sensitivity

4. Rated Coil Voltage

5, 12, 24 VDC

Specifications

■ Coil Ratings

Item	Standard			High-sensitivity		
	5 VDC	12 VDC	24 VDC	5 VDC	12 VDC	24 VDC
Rated voltage	5 VDC	12 VDC	24 VDC	5 VDC	12 VDC	24 VDC
Rated current	36 mA	15 mA	7.5 mA	24 mA	10 mA	5 mA
Coil resistance	139 Ω	800 Ω	3,200 Ω	208 Ω	1,200 Ω	4,800 Ω
Must operate voltage	70% max. of rated voltage					
Must release voltage	5% min. of rated voltage					
Max. voltage	160% of rated voltage (at 23°C)					
Power consumption	Approx. 180 mW			Approx. 120 mW		

- Note:**
- The rated current and coil resistance are measured at a coil temperature of 23°C with a tolerance of ±10%.
 - Operating characteristics are measured at a coil temperature of 23°C.
 - “Max. voltage” refers to the maximum voltage that can be applied to the relay coil. It is not the maximum voltage that can be applied continuously.

■ Contact Ratings

Item	Resistive load (cos φ = 1)	Inductive load (cos φ = 0.4, L/R=7 ms)
Rated load	5 A at 250 VAC, 5 A at 30 VDC	2 A at 250 VAC, 2 A at 30 VDC
Contact material	AgNi	
Rated carry current	5 A	
Max. switching voltage	250 VAC, 30 VDC	
Max. switching current	5 A	
Max. switching power	1,250 VA, 150 W	
Failure rate (ref. value)	5 mA at 24 VDC	

Note: P level: $\lambda_{60} = 0.1 \times 10^{-6}$ /operation.

■ Characteristics

Contact resistance	100 mΩ max.	
Operate time	10 ms max.	
Release time	5 ms max.	
Insulation resistance	1,000 MΩ min. (at 500 VDC)	
Dielectric strength	3,000 VAC, 50/60 Hz for 1 min between coil and contacts 750 VAC, 50/60 Hz for 1 min between contacts of same polarity	
Impulse withstand voltage	6,000 V (1.2 x 50 μs) between coil and contacts	
Insulation Distance	Creepage (Typ)	6.4 mm
	Clearance (Typ)	5.2 mm
Tracking Resistance (CTI)	175 V	
Vibration resistance	Destruction: 10 to 55 to 10 Hz, 0.75-mm single amplitude (1.5-mm double amplitude) Malfunction: 10 to 55 to 10 Hz, 0.75-mm single amplitude (1.5-mm double amplitude)	
Shock resistance	Destruction: 1,000 m/s ² Malfunction: 150 m/s ² (standard type). 130 m/s ² (high-sensitivity type)	
Endurance	Mechanical: 20,000,000 operations min. (at 18,000 operations/hr) Electrical: 100,000 operations min. (at 1,800 operations/hr) for standard type. 80,000 operations min. (at 1,800 operations/hr) for high-sensitivity type.	
Ambient temperature	Operating: -40°C to 85°C (with no icing)	
Ambient humidity	Operating: 5% to 85%	
Weight	Approx. 2.3 g	

Note: The data shown above are initial values.

- The contact resistance is possible with 1 A applied at 5 VDC using a fall-of-potential method.
- The insulation resistance is possible between coil and contacts and between contacts of the same polarity at 500 VDC.

Engineering Data

Maximum Switching Power

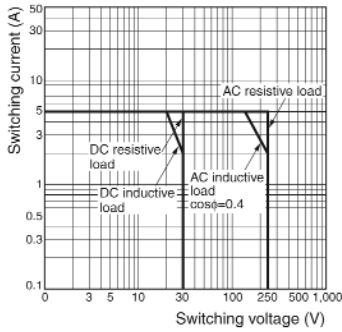

Endurance

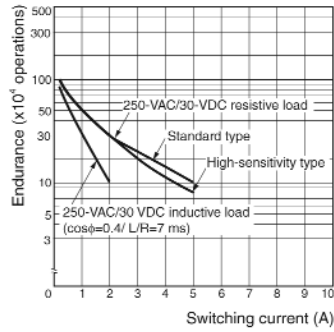

Ambient Temperature vs. Maximum Coil Voltage

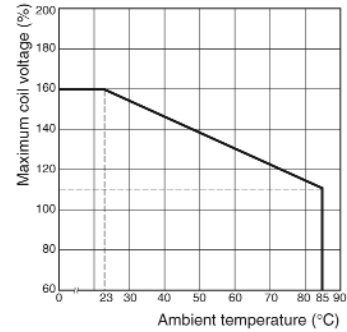

Note: The maximum coil voltage is the maximum voltage that can be applied to the relay coil

Ambient Temperature vs. Operating/Recovery Voltage G6DS-1A

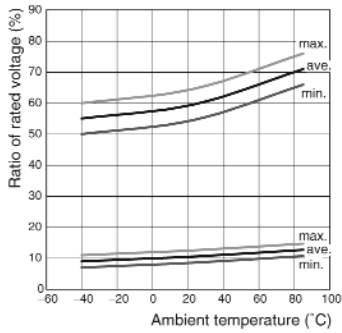

Malfunctioning Shock G6DS-1A

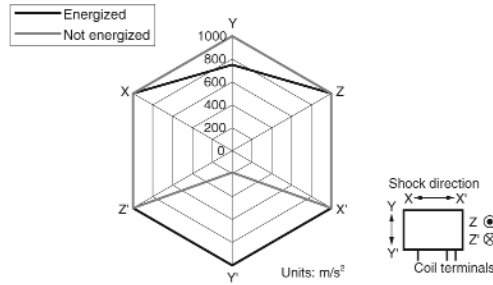

Measurement conditions: Impose a shock in the ±X, ±Y, and ±Z directions three times each with the Relay energized to check the shock values that cause the Relay to malfunction.

■ Approved Standards

The rated values approved by each of the safety standards may be different from the performance characteristics individually defined in this catalogue.

UL 508 (File No. E41515)/CSA C22.2 No.14 (File No. LR31928)

Model	Contact form	Coil ratings	Contact ratings
G6DS-1A	SPST-NO	5 to 24 VDC	5 A, 250 VAC (Resistive & General Use)
G6DS-1A-H			5 A, 30 VDC (Resistive & General Use)
G6DS-1A-H	SPST-NO	5 to 24 VDC	5 A, 250 VAC (Resistive & General Use)
G6DS-1A			5 A, 30 VDC (Resistive & General Use)

EN61810-1 (License No. B161)

Model	Contact form	Coil ratings	Contact ratings
G6DS-1A	SPST-NO	5, 12, 24 VDC	5 A, 250 VAC (cos φ = 1.0)
G6DS-1A-H			5 A, 30 VDC (0 ms)
G6DS-1A-H	SPST-NO	5, 12, 24 VDC	5 A, 250 VAC (cos φ = 1.0)
G6DS-1A			5 A, 30 VDC (0 ms)

Dimensions

Note: All units are in millimeters unless otherwise indicated.

G6D-1A/1A-H

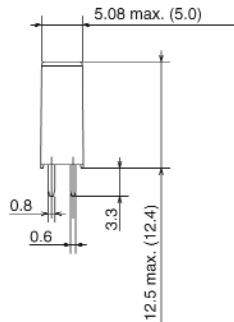
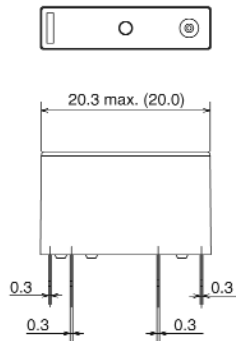
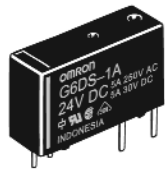

Terminal Arrangement/ Internal Connections (Bottom View)

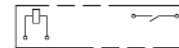

Mounting Holes (Bottom View)

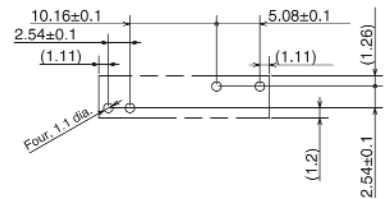

Precautions

More than two relays can be closely mounted right side up as shown in the following illustration.

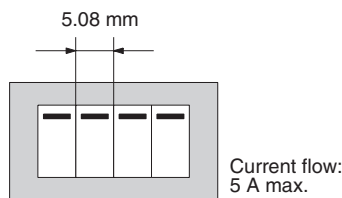

More than two relays can be closely mounted upside down as shown in the following illustration.

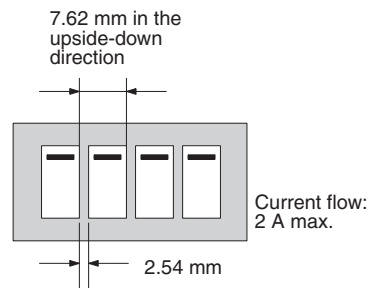

Note: The space between each relay required for heat radiation may vary with operating conditions. Contact your OMRON representative for details.

ALL DIMENSIONS SHOWN ARE IN MILLIMETERS.

To convert millimeters into inches, multiply by 0.03937. To convert grams into ounces, multiply by 0.03527.