

Features

1 Pole - Low profile (15.4 mm height)
43.41 - 1 Pole - 10 A (3.2 mm pin pitch)
43.41-0300 - 1 Pole NO - 10 A (5 mm pin pitch)
43.61-0300 - 1 Pole NO - 16 A (5 mm pin pitch)

PCB mount - direct or via PCB socket (43.41 version)

- Sensitive DC coil:
 - 250 mW (10 A version)
 - 400 mW (16 A version)
- Very high coil-contact isolation 10 mm, 6 kV (1.2/50 μs)
- Cadmium Free contacts (preferred version)
- Flux proof: RT II standard, (RT III option)

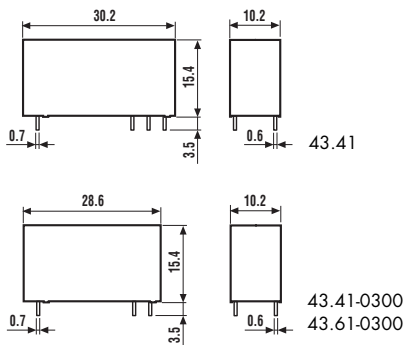

43.41



- 3.2 mm contact pin pitch
- 1 Pole CO, 10 A
- PCB direct or via socket

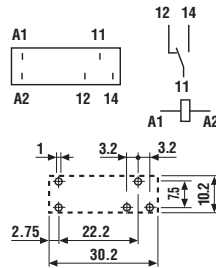

Copper side view

43.41-0300



- 5 mm contact pin pitch
- 1 Pole NO, 10 A
- PCB mount

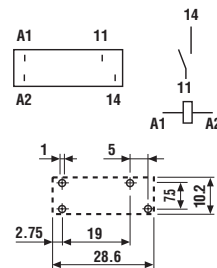

Copper side view

43.61-0300



- 5 mm contact pin pitch
- 1 Pole NO, 16 A
- PCB mount

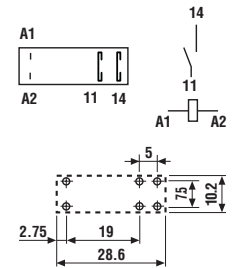

Copper side view

Contact specification		43.41	43.41-0300	43.61-0300
Contact configuration		1 CO (SPDT)	1 NO (SPST-NO)	1 NO (SPST-NO)
Rated current/Maximum peak current	A	10/15	10/15	16/25
Rated voltage/Maximum switching voltage V AC		250/400	250/400	250/400
Rated load AC1	VA	2,500	2,500	4,000
Rated load AC15 (230 V AC)	VA	500	500	750
Single phase motor rating (230 V AC)	kW	—	—	—
Breaking capacity DC1: 30/110/220 V	A	10/0.3/0.12	10/0.3/0.12	16/0.3/0.12
Minimum switching load	mW (V/mA)	300 (5/5)	300 (5/5)	300 (5/5)
Standard contact material		AgNi	AgNi	AgNi
Coil specification		43.41	43.41-0300	43.61-0300
Nominal voltage (U _N)	V AC (50/60 Hz)	—	—	—
	V DC	3 - 6 - 9 - 12 - 18 - 24 - 36 - 48	3 - 6 - 9 - 12 - 18 - 24 - 36 - 48	12 - 24 - 48
Rated power AC/DC	VA (50 Hz)/W	—/0.25	—/0.25	—/0.4
Operating range	AC	—	—	—
	DC	(0.7...1.5)U _N	(0.7...1.5)U _N	(0.7...1.2)U _N
Holding voltage	AC/DC	—/0.4 U _N	—/0.4 U _N	—/0.4 U _N
Must drop-out voltage	AC/DC	—/0.05 U _N	—/0.05 U _N	—/0.05 U _N
Technical data		43.41	43.41-0300	43.61-0300
Mechanical life AC/DC	cycles	—/10 · 10 ⁶	—/10 · 10 ⁶	—/10 · 10 ⁶
Electrical life at rated load AC1	cycles	100 · 10 ³	100 · 10 ³	50 · 10 ³
Operate/release time	ms	6/4	6/2	6/2
Insulation between coil and contacts (1.2/50 μs)	kV	6 (10 mm)	6 (10 mm)	6 (10 mm)
Dielectric strength between open contacts V AC		1,000	1,000	1,000
Ambient temperature range	°C	−40...+85	−40...+85	−40...+85
Environmental protection		RT II	RT II	RT II
Approvals (according to type)				

Ordering information

Example: 43 series low-profile PCB relay, 1 CO (SPDT), 24 V DC coil.

	4	3	.	4	.	1	.	7	.	0	2	4	.	2	A	0	B	0	C	0	D	0
Series																						
Type																						
4 = PCB - 3.2 mm pinning (CO/SPDT, 10 A)																						
PCB - 5 mm pinning (NO/SPST-NO, 10 A)																						
6 = PCB - 5 mm pinning (NO/SPST-NO, 16 A)																						
No. of poles																						
1 = 1 pole																						
Coil version																						
7 = Sensitive DC (only for 43.41)																						
9 = DC (only for 43.61)																						
Coil voltage																						
See coil specifications																						
A: Contact material																						
0 = AgNi																						
2 = AgCdO																						
4 = AgSnO ₂																						
5 = AgNi + Au (5 μm)																						
B: Contact circuit																						
0 = CO (SPDT) - (for 43.41 only)																						
3 = NO (SPST)																						
D: Special versions																						
0 = Flux proof (RT II)																						
1 = Wash tight (RT III)																						
C: Options																						
0 = None																						

Selecting features and options: only combinations in the same row are possible.
Preferred selections for best availability are shown in **bold**.

Type	Coil version	A	B	C	D
43.41	sensitive DC	0 - 2 - 4 - 5	0 - 3	0	0 - 1
43.61	DC	0 - 2 - 4	3	0	0

Technical data

Insulation					
Insulation according to EN 61810-1	insulation rated voltage	V	250		400
	rated impulse withstand voltage	kV	4		4
	pollution degree		3		2
	overvoltage category		III		III
Insulation between coil and contacts (1.2/50 μs)		kV	6 (10 mm)		
Dielectric strength between open contacts		V AC	1,000		
Conducted disturbance immunity					
Burst (5...50)ns, 5 kHz, on A1 - A2			EN 61000-4-4		level 4 (4 kV)
Surge (1.2/50 μs) on A1 - A2 (differential mode)			EN 61000-4-5		level 3 (2 kV)
Other data					
Bounce time: NO/NC		ms	3/6		
Vibration resistance (5...55)Hz, max. ± 1 mm: NO/NC		g	15/3		
Shock resistance		g	15		
Power lost to the environment	without contact current	W	0.25 (43.41)		0.4 (43.61)
	with rated current	W	1.3 (43.41)		2 (43.61)
Recommended distance between relays mounted on PCB		mm	≥ 5		

Contact specification

F 43 - Electrical life (AC) v contact current

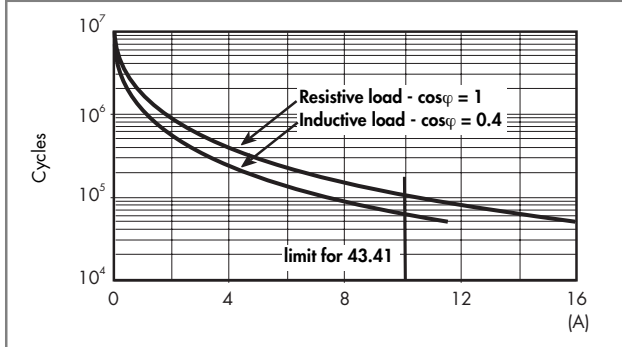

H 43 - Maximum DC1 breaking capacity

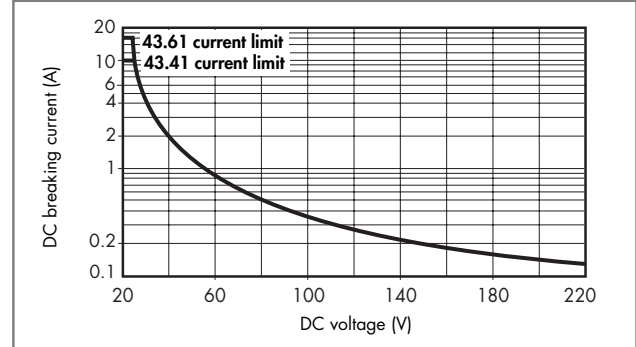

- When switching a resistive load (DC1) having voltage and current values under the curve, an electrical life of $\geq 100 \cdot 10^3$ for 43.41 and $\geq 50 \cdot 10^3$ for 43.61 can be expected.
- In the case of DC13 loads, the connection of a diode in parallel with the load will permit a similar electrical life as for a DC1 load. Note: the release time for the load will be increased.

Coil specifications

DC coil data - 0.25 W sensitive (type 43.41)

Nominal voltage U_N	Coil code	Operating range		Resistance R	Rated coil consumption I at U_N
		U_{min}	U_{max}		
V		V	V	Ω	mA
3	7.003	2.2	4.5	36	83.5
6	7.006	4.2	9	150	40
9	7.009	6.5	13.5	324	27.7
12	7.012	8.4	18	580	20.7
18	7.018	13	27	1,296	13.8
24	7.024	16.8	36	2,200	10.9
36	7.036	25.2	54	5,184	6.9
48	7.048	33.6	72	9,200	5.2

R 43 - DC coil operating range v ambient temperature

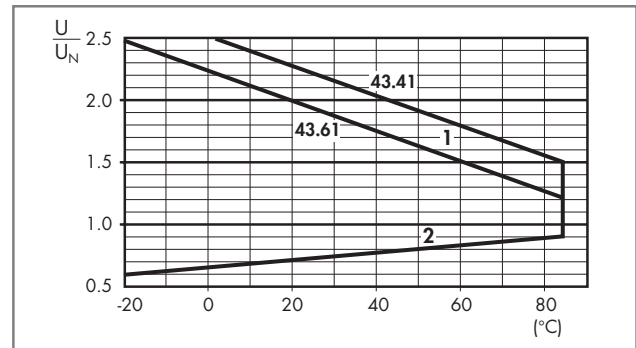

- 1 - Max. permitted coil voltage.
- 2 - Min. pick-up voltage with coil at ambient temperature.

DC coil data - 0.4 W standard (type 43.61)

Nominal voltage U_N	Coil code	Operating range		Resistance R	Rated coil consumption I at U_N
		U_{min}	U_{max}		
V		V	V	Ω	mA
12	9.012	8.4	14.4	360	33.3
24	9.024	16.8	28.8	1,400	17.1
48	9.048	33.6	57.6	5,760	8.3



95.23

Approvals
(according to type):



PCB socket (for changeover contacts only)	95.23 (blue)	95.23.0 (black)
For relay type	43.41	43.41
Accessories		
Metal retaining clip (supplied with socket - packaging code SNA)	095.43	
Technical data		
Rated values	10 A - 250 V	
Insulation	6 kV (1.2/50 μs) between coil and contacts	
Protection category	IP 20	
Ambient temperature	°C -40...+70	

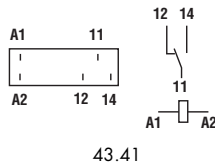

43.41

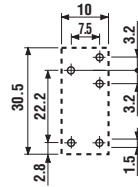
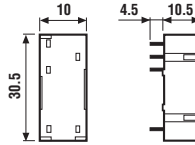

95.23

Copper side view

Packaging codes

How to code and identify retaining clip and packaging options for sockets.

Example:



A Standard packaging

SN Metal retaining clip

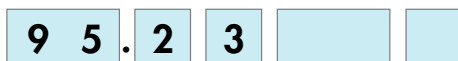

Without retaining clip