

## Features

1 or 2 Pole 16 A Step relays for direct 35 mm rail (EN 60715) mounting

- 17.4 mm wide
- Test button with mechanical indicators
- Choice of 6 switching sequences
- AC coils and DC coils
- Identification label
- Possible to connect illuminated push buttons with the additional part 026.00
- 35 mm rail (EN 60715) mount
- Cadmium free contact material

20.21



- Single phase switch 1 NO (SPST-NO)
- 35 mm rail (EN 60715) mount

20.22, 24, 26, 28



- Double phase switch
- 35 mm rail (EN 60715) mount

20.23



- Double phase switch 1NO+1NC (SPST-NO+SPST-NC)
- 35 mm rail (EN 60715) mount

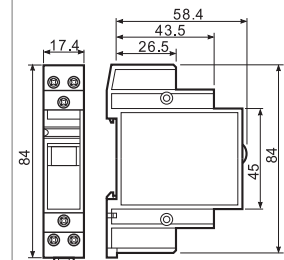
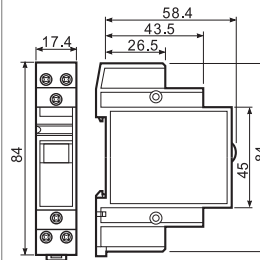
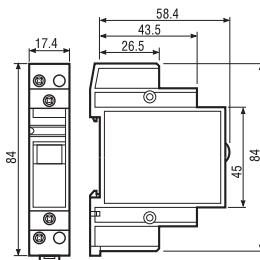
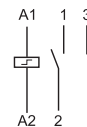
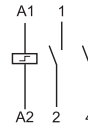
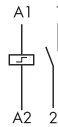

FOR UL HORSEPOWER AND PILOT DUTY RATINGS  
SEE "General technical information" page V

Contact specification		20.21	20.22, 24, 26, 28	20.23
Contact configuration		1 NO (SPST-NO)	2 NO (DPST-NO)	1NO+1NC (SPST-NO+SPST-NC)
Rated current/Maximum peak current	A	16/30	16/30	16/30
Rated voltage/Maximum switching voltage V AC		250/400	250/400	250/400
Rated load AC1	VA	4,000	4,000	4,000
Rated load AC15 (230 V AC)	VA	750	750	750
Nominal lamp rating:incandescent (230 V)	W	2,000	2,000	2,000
compensated fluorescent (230 V)	W	750	750	750
uncompensated fluorescent (230 V)	W	1,000	1,000	1,000
halogen (230 V)	W	2,000	2,000	2,000
Minimum switching load	mW (V/mA)	1,000 (10/10)	1,000 (10/10)	1,000 (10/10)
Standard contact material		AgNi	AgNi	AgNi
Coil specification				
Nominal voltage (U <sub>N</sub> )	V AC (50/60 Hz)	8 - 12 - 24 - 48 - 110 - 120 - 230 - 240		
	V DC	12 - 24 - 48 - 110	12 - 24 - 48 - 110	12 - 24 - 48 - 110
Rated power AC/DC	VA (50 Hz)/W	6.5/5	6.5/5	6.5/5
Operating range	AC	(0.85...1.1)U <sub>N</sub> (50 Hz)/(0.9...1.1)U <sub>N</sub> (60 Hz)		
	DC	(0.9...1.1)U <sub>N</sub>	(0.9...1.1)U <sub>N</sub>	(0.9...1.1)U <sub>N</sub>
Technical data				
Mechanical life AC/DC	cycles	300 · 10 <sup>3</sup>	300 · 10 <sup>3</sup>	300 · 10 <sup>3</sup>
Electrical life at rated load in AC1	cycles	100 · 10 <sup>3</sup>	100 · 10 <sup>3</sup>	100 · 10 <sup>3</sup>
Minimum/Maximum impulse duration		0.1s/1h (according to EN 60669)	0.1s/1h (according to EN 60669)	0.1s/1h (according to EN 60669)
Insulation between coil and contacts (1.2/50 μs)	kV	4	4	4
Ambient temperature range	°C	-40...+40	-40...+40	-40...+40
Protection category		IP 20	IP 20	IP 20
Approvals (according to type)				

## Ordering information

Example: 20 series relay, 35 mm rail (EN 60715) mount, double phase switch, 2 NO (DPST-NO) 16 A contacts, coil rated at 12 V DC, AgSnO<sub>2</sub> contacts.

**2 0 . 2 2 . 9 . 0 1 2 . 4 0 0 0**

**Series**

**Type**

2 = 35 mm rail (EN 60715) mount

**No. of poles**

- 1 = Single phase switch 1 NO (SPST-NO)
- 2 = Double phase switch 2 NO (DPST-NO)
- 3 = Double phase switch 1 NC+1 NO (SPST-NO+SPST-NC)
- 4 = 4 sequence double phase switch 2 NO (DPST-NO)
- 6 = 3 sequence double phase switch 2 NO (DPST-NO)
- 8 = 4 sequence double phase switch 2 NO (DPST-NO)

**Contact material**

- 0 = AgNi standard
- 4 = AgSnO<sub>2</sub>

**Coil voltage**

See coil specifications

**Coil version**

- 8 = AC (50/60 Hz)
- 9 = DC

## Technical data

### Insulation

Dielectric strength		
between supply and contacts	V AC	3,500
between open contacts	V AC	2,000
between adjacent contacts	V AC	2,000

### Other data

Power lost to the environment					
with rated current and coil deenergised	W	1.3 (20.21, 20.23, 20.28)	2.6 (20.22, 20.24, 20.26)		
Screw torque	Nm	0.8		0.8	
Max. wire size	<b>Coil terminals</b>		<b>Contact terminals</b>		
		solid cable	stranded cable	solid cable	stranded cable
	mm <sup>2</sup>	1x4 / 2x2.5	1x2.5 / 2x2.5	1x6 / 2x4	1x4 / 2x2.5
	AWG	1x12 / 2x14	1x14 / 2x14	1x10 / 2x12	1x12 / 2x14

If the coil is operated for a prolonged period of time, adequate ventilation of the relays must be provided - suggested gap of 9 mm between adjacent relays.

## Coil specifications

### DC version data

Nominal voltage U <sub>N</sub>	Coil code	Operating range		Resistance R	Consumption I at U <sub>N</sub>
		U <sub>min</sub>	U <sub>max</sub>		
V		V	V	Ω	mA
12	9.012	10.8	13.2	27	440
24	9.024	21.6	26.4	105	230
48	9.048	43.2	52.8	440	110
110	9.110	99	121	2,330	47

### AC version data

Nominal voltage U <sub>N</sub>	Coil code	Operating range		Resistance R	Consumption I at U <sub>N</sub> (50 Hz)
		U <sub>min</sub>	U <sub>max</sub>		
V		V	V	Ω	mA
8	8.008	6.8	8.8	4	800
12	8.012	10.2	13.2	7.5	550
24	8.024	20.4	26.4	27	275
48	8.048	40.8	52.8	106	150
110	8.110	93.5	121	590	64
120	8.120	102	132	680	54
230	8.230	196	253	2,500	28
240	8.240	204	264	2,700	27.5

Type	Number of steps	Sequence			
		1	2	3	4
20.21	2				
20.22	2				
20.23	2				
20.24	4				
20.26	3				
20.28	4				

**Wiring diagrams**

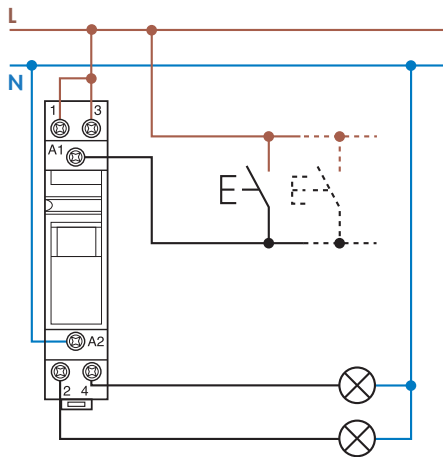

Example: 230 V AC supply voltage.

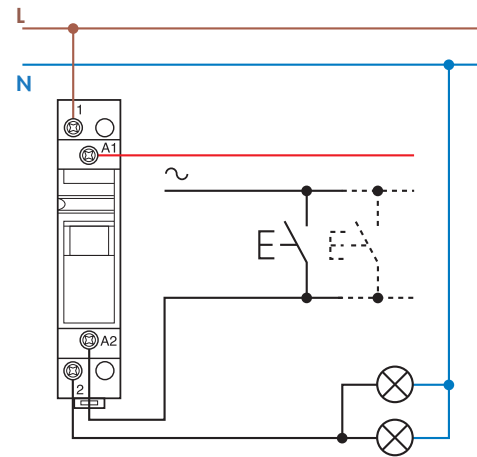

Example: 24 V AC supply voltage.

**Accessories**

**Module for use with illuminated push-buttons**

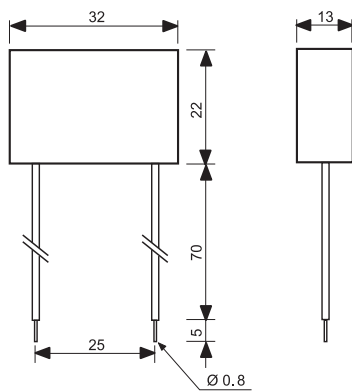

**Type 026.00**  
Sealed construction, 7.5 cm insulated flexible wire termination.

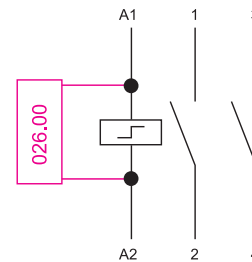

**Example of wiring diagram of type 026.00**  
This module is necessary when using between 1 and a maximum of 15 illuminated push buttons in the coil circuit (Each 1.5 mA max, 230 V AC). It must be connected in parallel to the coil of the relay.



020.01

**Adaptor for panel mounting, 17.5 mm wide**

020.01



020.24

**Sheet of marker tags, plastic, 24 tags, 9x17 mm**

020.24

