

### RY/RM Series Miniature Relays

**RY2 (3A), RY4 (5A), RM2 (5A)**  
**Bifurcated contacts are also available**

The RY/RM series are general purpose miniature relays with a 3A or 5A contact capacity. A wide variety of terminal styles and coil voltages meet a wide range of applications. All 4PDT types have arc barriers.



#### Part Number Selection

Contact	Model	Part Number		Coil Voltage Code
		Plug-in Terminal	PC Board Terminal	
DPDT (Slim) 3A 	Basic	RY2S-U	RY2V-U	AC6V, AC12V, AC24V, AC110V, AC120V, AC220V, AC240V DC6V, DC12V, D24V, DC48V, DC110V
	With Indicator	RY2S-UL	RY2V-UL	
	With Check Button	RY2S-UC		
	With Indicator and Check Button	RY2S-ULC		
	Top Bracket Mounting	RY2S-UT		
	With Diode (DC coil only)	RY2S-UD	RY2V-UD	
DPDT (Wide) 5A 	Basic	RM2S-U	RM2V-U	AC6V, AC12V, AC24V, AC110-120V, AC220-240V DC6V, DC12V, DC24V, DC48V, DC100-110V
	With Indicator	RM2S-UL	RM2V-UL	
	With Check Button	RM2S-UC		
	With Indicator and Check Button	RM2S-ULC		
	Top Bracket Mounting	RM2S-UT		
	With Diode (DC coil only)	RM2S-UD		
4PDT 5A 	Basic	RY4S-U	RY4V-U	AC6V, AC12V, AC24V, AC110-120V, AC220-240V DC6V, DC12V, DC24V, DC48V, DC100-110V
	With Indicator	RY4S-UL	RY4V-UL	
	With Check Button	RY4S-UC		
	With Indicator and Check Button	RY4S-ULC		
	Top Bracket Mounting	RY4S-UT		
	With Diode (DC coil only)	RY4S-UD	—	
DPDT (Slim) 1A Bifurcated 	Basic	RY22S-U	RY22V-U	AC6V, AC12V, AC24V, AC110V, AC120V, AC220V, AC240V DC6V, DC12V, D24V, DC48V, DC110V
	With Indicator	RY22S-UL	RY22V-UL	
	Top Bracket Mounting	RY22S-UT		
	With Diode (DC coil only)	RY22S-UD	RY22V-UD	
4PDT 1A Bifurcated 	Basic	RY42S-U	RY42V-U	AC6V, AC12V, AC24V, AC110-120V, AC220-240V DC6V, DC12V, DC24V, DC48V, DC100-110V
	With Indicator	RY42S-UL	RY42V-UL	
	Top Bracket Mounting	RY42S-UT		

**Ordering Information**

When ordering, specify the Part No. and coil voltage code:

(example) **RY4S-U** **AC110-120V**  
 Part No.                      Coil Voltage Code

Switches & Pilot Lights

Display Lights

Relays & Sockets





Timers

Terminal Blocks



Circuit Breakers

**Sockets**

Relays	Standard DIN Rail Mount	Finger-safe DIN Rail Mount	Through Panel Mount	PCB Mount
RY2S RY22S	SY2S-05	SY2S-05C	SY2S-51	SY2S-61
RM2	SM2S-05	SM2S-05C	SM2S-51	SY4S-61 SY4S-62
RY4S RY42S	SY4S-05	SY4S-05C	SY4S-51	









**Hold Down Springs & Clips**

Appearance	Description	Relay	For DIN Mount Socket	For Through Panel & PCB Mount Socket	Min Order Qty
	Pullover Wire Spring	RY2S	SY2S-02F1	SY4S-51F1	10
		RY22S			
		RM2	SY4S-51F1	SY4S-51F1	
		RY4S			
		RY42S			
	Leaf Spring* (side latch)	RY2S, RY22S	SFA-202	SFA-302	20
		RM2, RY4S, RY42S			
	Leaf Spring* (top latch)	RY2S, RY22S	SFA-101	SFA-301	
		RM2			
		RY4S, RY42S			

 \*Not available for PCB mount socket SY4S-62.

**Accessories**

Description	Appearance	Use with	Part No.	Remarks
Aluminum DIN Rail (1 meter length)		All DIN rail sockets	BNDN1000	IDEC offers a low-profile DIN rail (BNDN1000). The BNDN1000 is designed to accommodate DIN mount sockets. Made of durable extruded aluminum, the BNDN1000 measures 0.413 (10.5mm) in height and 1.37 (35mm) in width (DIN standard). Standard length is 39" (1,000mm).
DIN Rail End Stop		DIN rail	BNL5	9.1 mm wide.
Replacement Hold-Down Spring Anchor		Horseshoe clip for all DIN rail sockets	Y778-011	For use on DIN rail mount socket when using pullover wire hold down spring. 2 pieces included with each socket.

Specifications

Contact Model	Standard Contact			Bifurcated Contact
	RY2 - DPDT Slim	RM2 - DPDT Wide	RY4 - 4PDT	RY22 - DPDT / RY42 - 4PDT
Contact Material	Gold-plated silver	Silver	Gold-plated silver	Silver-palladium alloy
Contact Resistance <sup>1</sup>	50 mΩ maximum	30 mΩ maximum	50 mΩ maximum	100 mΩ minimum
Minimum Applicable Load	24V DC, 5 mA; 5V DC, 10 mA (reference value)	24V DC, 10 mA; 5V DC, 20 mA (reference value)	24V DC, 5 mA; 5V DC, 10 mA (reference value)	1V DC, 100 μA (reference value)
Operate Time <sup>2</sup>	20 ms maximum			
Release Time <sup>2</sup>	20 ms maximum			
Power Consumption (approx.)	AC: 1.1 VA (50 Hz), 1 VA (60 Hz) DC: 0.8W	AC: 1.4 VA (50 Hz), 1.2 VA (60 Hz) DC: 0.9W	AC: 1.4 VA (50 Hz), 1.2 VA (60 Hz) DC: 0.9W	AC: 1.1 VA (50 Hz), 1 VA (60 Hz) DC: 0.8W
Insulation Resistance	100 MΩ minimum (500V DC megger)			
Dielectric Strength <sup>3</sup>	Between live and dead parts:			
	1500V AC, 1 minute	2000V AC, 1 minute	2000V AC, 1 minute	1500V AC, 1 minute <sup>3</sup>
	Between contact and coil:			
	1500V AC, 1 minute	2000V AC, 1 minute	2000V AC, 1 minute	1500V AC, 1 minute
	Between contacts of different poles:			
	1500V AC, 1 minute	2000V AC, 1 minute	2000V AC, 1 minute	1500V AC, 1 minute
Operating Frequency	Electrical: 1800 operations/h maximum			
	Mechanical: 18,000 operations/h maximum			
Vibration Resistance	Damage limits: 10 to 55 Hz, amplitude 0.5 mm			
	Operating extremes: 10 to 55 Hz, amplitude 0.5 mm			
Shock Resistance	Damage limits: 1000 m/s <sup>2</sup>			
	Operating extremes: 100 m/s <sup>2</sup> (DPDT Slim), 200 m/s <sup>2</sup> (4PDT, DPDT Wide)			
Mechanical Life	50,000,000 operations			
Electrical Life	200,000 operations (220V AC, 3A)	500,000 operations (220V AC, 5A)	100,000 operations (220V AC, 5A) 200,000 operations (220V AC, 3A)	200,000 operations (110V AC, 1A)
Operating Temperature <sup>4</sup>	-25 to +55°C (no freezing)	-25 to +45°C (no freezing)	-25 to +55°C (no freezing) <sup>5</sup>	-25 to +55°C (no freezing)
Operating Humidity	45 to 85% RH (no condensation)			
Weight (approx.)	23g	35g	34g	RY22: 23g / RY42: 34g



Note: Above values are initial values.

1. Measured using 5V DC, 1A voltage drop method
2. Measured at the rated voltage (at 20°C), excluding contact bouncing  
Release time of relays with diode: 40 ms maximum

3. Relays with indicator or diode: 1000V AC, 1 minute

4. For use under different temperature conditions, refer to Continuous Load Current vs. Operating Temperature Curve.  
The operating temperature range of relays with indicator or diode is -25 to +40°C.

5. When the total current of 4 contacts is less than 15A, the operating temperature range is -25 to +70°C.

Switches & Pilot Lights

Display Lights

Relays & Sockets

Timers

Terminal Blocks

Circuit Breakers

**AC Coil Ratings**

Voltage (V)	Rated Current (mA) ±15% at 20°C				Coil Resistance (Ω) ±10% at 20°C		Operation Characteristics (against rated values at 20°C)		
	AC 50Hz		AC 60Hz		DPDT Slim	DPDT Wide & 4PDT	Max. Continuous Applied Voltage	Pickup Voltage	Dropout Voltage
	DPDT Slim	DPDT Wide & 4PDT	DPDT Slim	DPDT Wide & 4PDT					
6	170	240	150	200	18.8	9.4			
12	86	121	75	100	76.8	39.3			
24	42	60.5	37	50	300	153			
110	9.6	—	8.4	—	6,950	—			
110-120	—	9.4-10.8	—	8.0-9.2	—	4,290			
120	8.6	—	7.5	—	8,100	—			
220	4.7	—	4.1	—	25,892	—			
220-240	—	4.7-5.4	—	4.0-4.6	—	18,820			
240	4.9	—	4.3	—	26,710	—			

**DC Coil Ratings**

Voltage (V)	Rated Current (mA) ±15% at 20°C		Coil Resistance (Ω) ±10% at 20°C		Operation Characteristics (against rated values at 20°C)		
	DPDT Slim	DPDT Wide & 4PDT	DPDT Slim	DPDT Wide & 4PDT	Max. Continuous Applied Voltage	Pickup Voltage	Dropout Voltage
6	128	150	47	40	110%	80% maximum	10% minimum
12	64	75	188	160			
24	32	36.9	750	650			
48	18	18.5	2,660	2,600			
100-110	—	8.2-9.0	—	12,250			
110	8	—	13,800	—			

**Contact Ratings**

Contact	Continuous Current	Maximum Contact Capacity				
		Allowable Contact Power		Rated Load		
		Resistive Load	Inductive Load	Voltage (V)	Res. Load	Ind. Load
DPDT Slim (RY2)	3A	660 VA AC 90W DC	176 VA AC 45W DC	110V AC	3A	1.5A
				220V AC	3A	0.8A
				30V DC	3A	1.5A
DPDT Wide (RM2)	5A	1100VA AC 150W DC	440VA AC 75W DC	110V AC	5A	2.5A
				220V AC	5A	2A
				30V DC	5A	2.5A
4PDT (RY4)	5A	1200 VA AC 150W DC	288 VA AC 60W DC	240V AC	5A	1.2A
				30V DC	5A	2A
Bifurcated Contact (RY22/RY42)	1A	176 VA AC 30W DC	88 VA AC 15W DC	110V AC	1A	0.5A
				220V AC	0.8A	0.4A
				30V DC	1A	0.5A

Note: Inductive load for the rated load —  $\cos \phi = 0.3$ ,  $L/R = 7$  ms

**TÜV Ratings (Standard Contact)**

Voltage	DPDT Slim	DPDT Wide	4PDT
240V AC	3A	5A	5A
30V DC	3A	5A	5A

AC:  $\cos \phi = 1.0$ , DC:  $L/R = 0$  ms

**UL Ratings (Bifurcated Contact)**

Voltage	Resistive	General use
240V AC	0.8A	0.4A
120V AC	1A	0.5A
30V DC	1A	0.5A

**UL Ratings (Standard Contact)**

Voltage	Resistive			General use		
	DPDT Slim	DPDT Wide	4PDT	DPDT Slim	DPDT Wide	4PDT
240V AC	3A	5A	5A	0.8A	2A	5A
120V AC	—	—	—	1.5A	2.5A	—
100V DC	0.2A	0.4A	0.2A	0.2A	—	0.2A
30V DC	3A	5A	5A	3A	—	5A

**CSA Ratings (Standard Contact)**

Voltage	Resistive			General use		
	DPDT Slim	DPDT Wide	4PDT	DPDT Slim	DPDT Wide	4PDT
240V AC	3A	5A	5A	0.8A	2A	5A
120V AC	3A	5A	—	1.5A	2.5A	—
100V DC	—	—	—	0.2A	0.4A	0.2A
30V DC	3A	5A	5A	1.5A	2.5A	1.5A

**CSA Ratings (Bifurcated Contact)**

Voltage	Resistive	General use
240V AC	0.8A	0.4A
120V AC	1A	0.5A
30V DC	1A	—

Switches &amp; Pilot Lights

Display Lights

Relays &amp; Sockets

Timers

Terminal Blocks

Circuit Breakers

Socket Specifications

	Sockets	Terminal	Electrical Rating	Wire Size	Torque
DIN Rail Mount Sockets	SY2S-05	M3 screws with captive wire clamp	300V, 7A	Maximum up to 2-#14AWG	5.5 - 9 in•lbs
	SM2S-05	M3 screw with captive wire clamp	300V, 10A	Maximum up to 2-#14AWG	5.5 - 9 in•lbs
	SY4S-05	M3 screw with captive wire clamp	300V, 7A*	Maximum up to 2-#14AWG	5.5 - 9 in•lbs
Finger-safe DIN Rail Mount	SY2S-05C	M3 screws with captive wire clamp, fingersafe	300V, 7A	Maximum up to 2-#14AWG	5.5 - 9 in•lbs
	SM2S-05C	M3 screw with captive wire clamp, fingersafe	300V, 10A	Maximum up to 2-#14AWG	5.5 - 9 in•lbs
	SY4S-05C	M3 screw with captive wire clamp, fingersafe	300V, 7A*	Maximum up to 2-#14AWG	5.5 - 9 in•lbs
Through Panel Mount Socket	SY2S-51	Solder	250V, 7A	—	—
	SM2S-51	Solder	250V, 10A	—	—
	SY4S-51	Solder	250V, 7A*	—	—
PCB Mount Socket	SY2S-61	PCB Mount	300V, 7A	—	—
	SY4S-61	PCB Mount	300V, 7A	—	—
	SY4S-62	PCB Mount	250V, 7A	—	—



\* When using only 2 poles of the 4-poles, the UL recognized current is 10A.

Characteristics (Reference Data)

Electrical Life Curves

AC Load

(RY2)

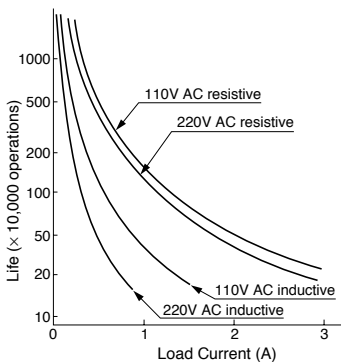

(RY4)

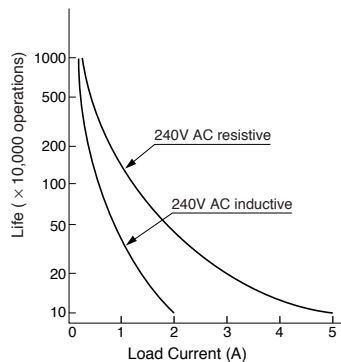

(RY42/  
RY22)

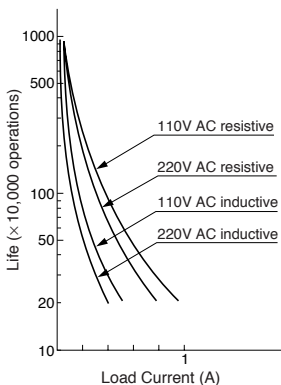

(RM2)

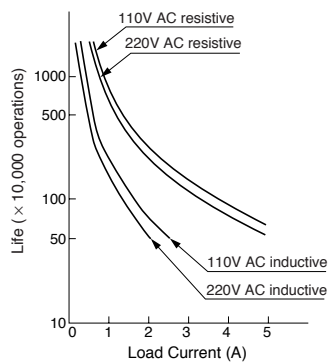

DC Load

(RY2)

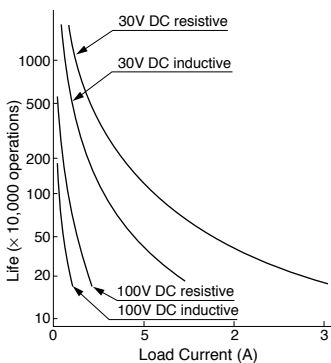

(RY4)

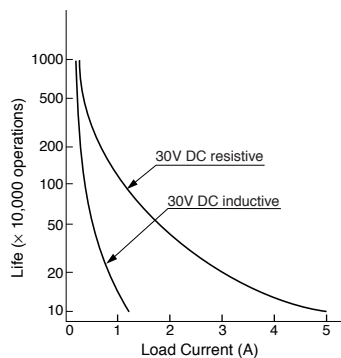

(RY42/  
RY22)

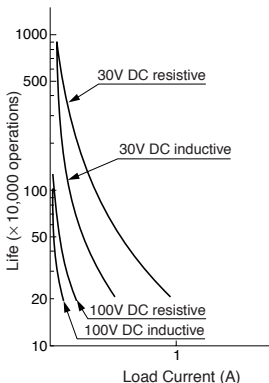

(RM2)

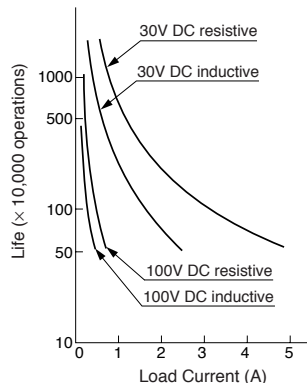

Switches & Pilot Lights

Display Lights

Relays & Sockets

Timers

Terminal Blocks

Circuit Breakers

Maximum Switching Capacity

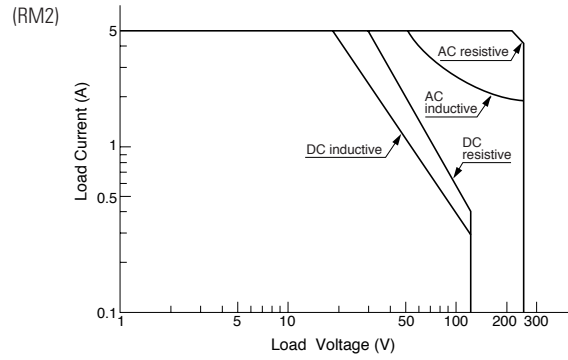
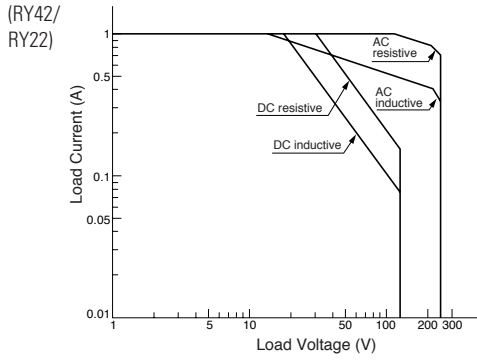
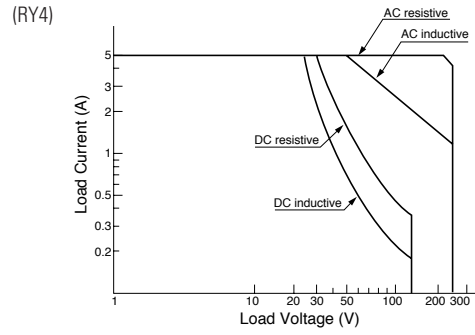
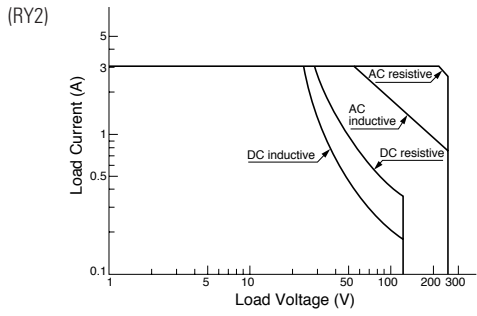

Continuous Load Current vs. Operating Temperature Curve (Basic Type, With Check Button, and Top Bracket Mounting Type)

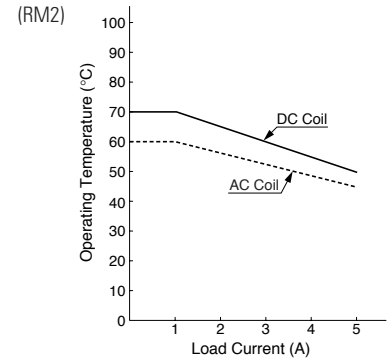
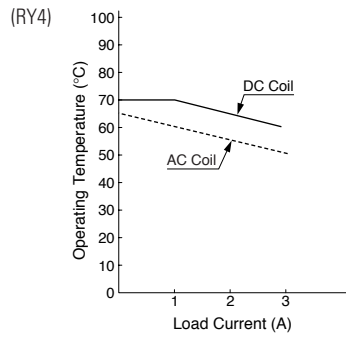
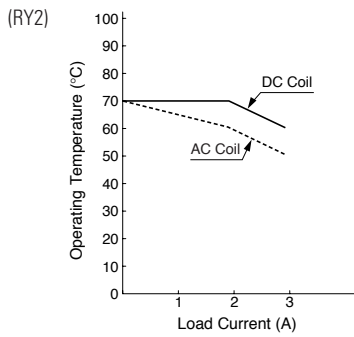

Internal Connection (View from Bottom)

Basic Type

DPDT Slim (RY2/RM22)

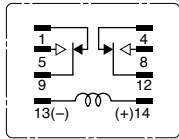

DPDT Wide (RM2)

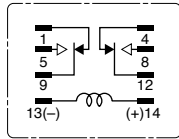

4PDT (RY4/RM42)

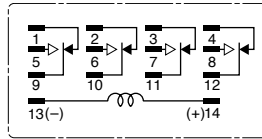

With Check Button

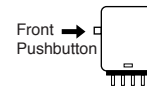

Contacts can be operated by pressing the check button.

With Indicator (-L type)

DPDT Slim (RY2/RM22)

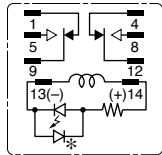

DPDT Wide (RM2)

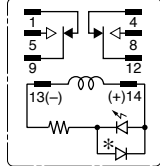

4PDT (RY4/RM42)

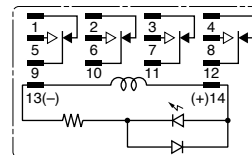

Coil Below  
100V  
AC/DC

Coil Below  
24V  
AC/DC

When the relay is energized, the indicator goes on.

- The LED protection diode is not contained in DPDT relays for coils below 100V DC.
- If coil polarity is reversed LED will not light.

Coil  
100V  
AC/DC  
and over

Coil 24V  
AC/DC  
and over

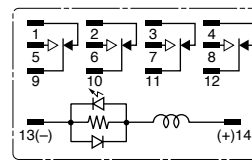
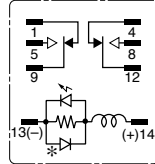

With Diode (-D type)

DPDT Slim (RY2/RM22)

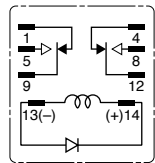

DPDT Wide (RM2)

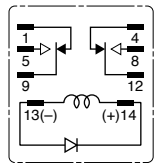

4PDT (RY4)

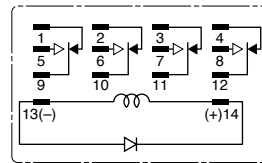

Contains a diode to absorb the back emf generated when the coil is de-energized. The release time is slightly longer.

- Diode Characteristics  
Reverse withstand voltage: 1,000V  
Forward current: 1A

With Indicator and Diode (-LD type)

DPDT Wide (RM2)

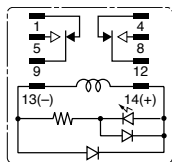

4PDT (RY4)

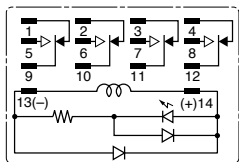

Coil 24V  
DC and  
over

DPDT Wide (RM2)

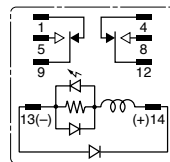

4PDT (RY4)

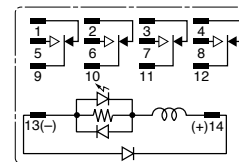

Contains LED indicator and a surge absorber.

Switches & Pilot Lights

Display Lights

Relays & Sockets

Timers

Terminal Blocks

Circuit Breakers



Dimensions (mm)

RY2S/RY22S

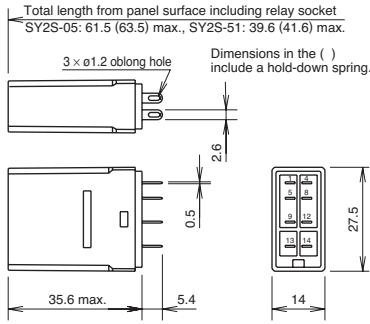

RY4S/RY42S

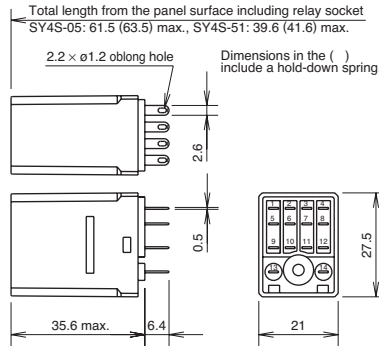

RM2S

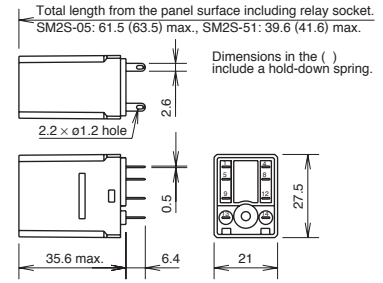

RY2V/RY22V

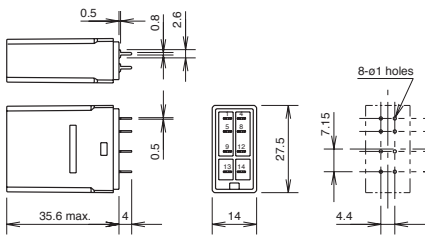

RY4V/RY42V

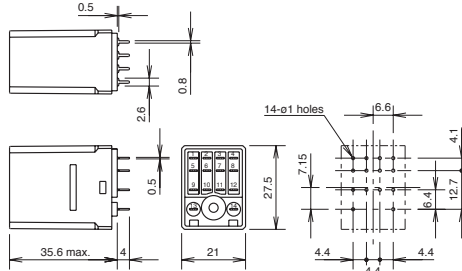

RM2V

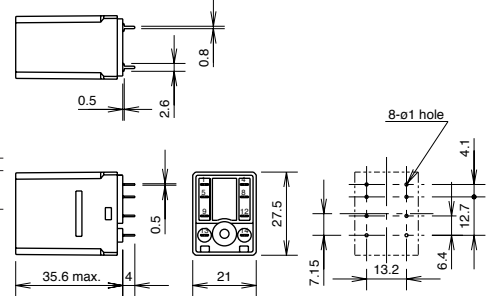

RY2S-UT/RY22S-UT

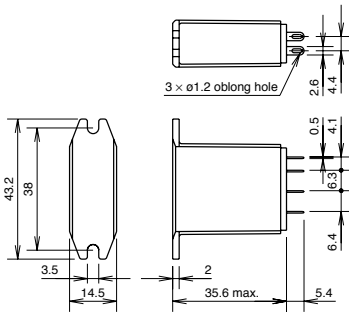

RY4S-UT/RY42S-UT

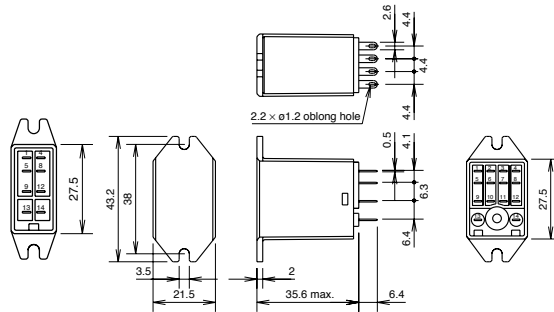

RM2S-UT

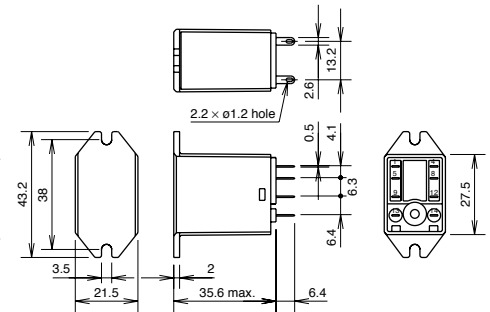

Dimensions

Standard DIN Rail Mount Sockets

SY2S-05

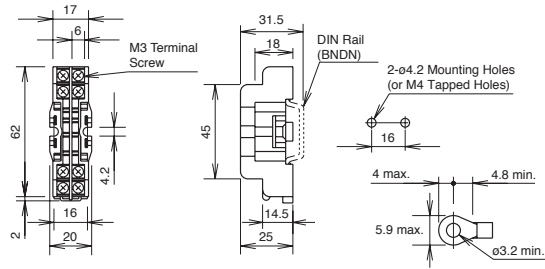

Terminal Arrangement

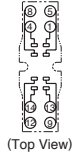

SM2S-05

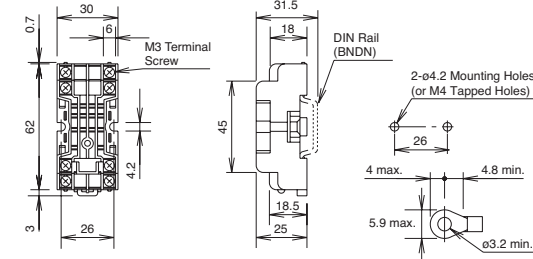

Terminal Arrangement

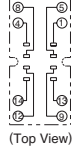

SY4S-05

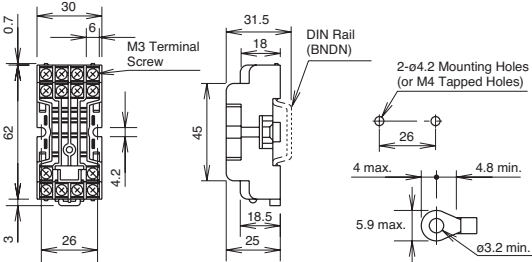

Terminal Arrangement

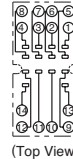

Finger-safe DIN Rail Mount Sockets

SY2S-05C

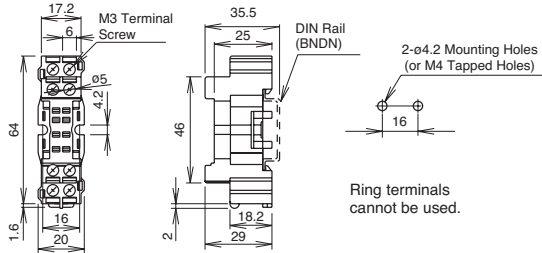

Terminal Arrangement

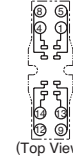

SM2S-05C

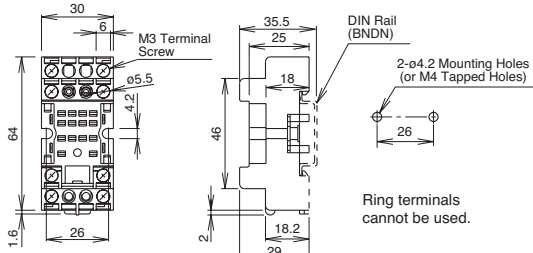

Terminal Arrangement



SY4S-05C

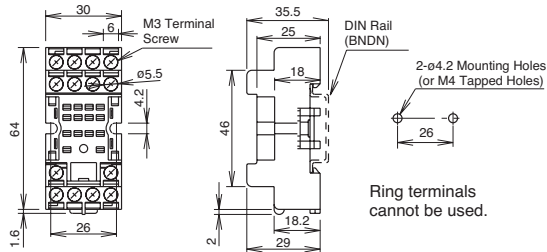

Terminal Arrangement

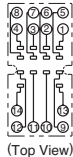

Switches & Pilot Lights

Display Lights

Relays & Sockets

Timers

Terminal Blocks

Circuit Breakers

Through Panel Mount Socket

**SY2S-51**

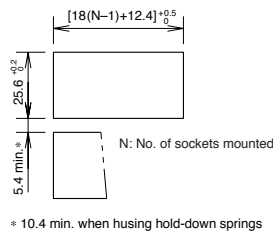
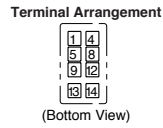
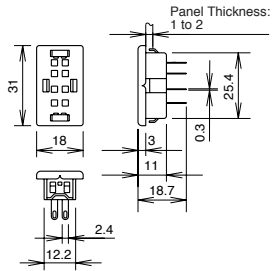

**SM2S-51**

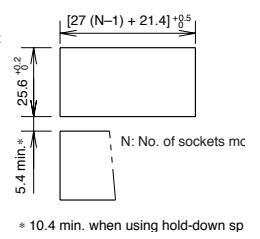
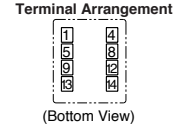
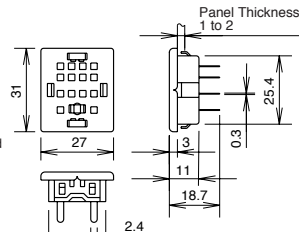

**SY4S-51**

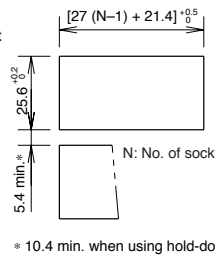
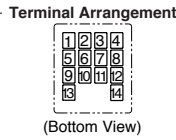
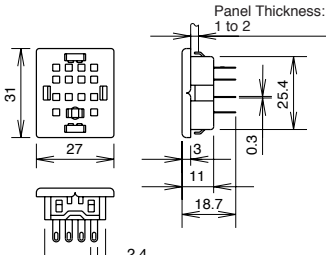

PCB Mount Sockets

**SY2S-61**

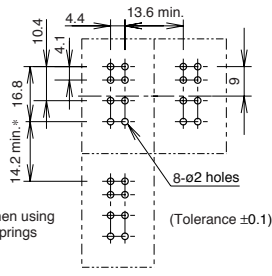
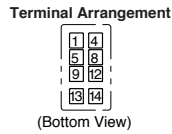
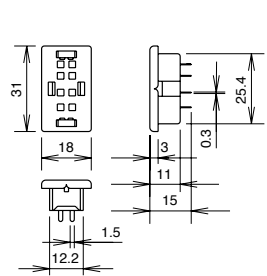

**SY4S-61**

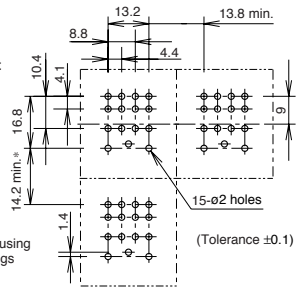
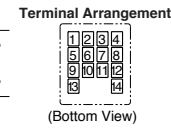
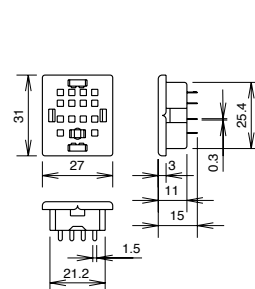

**SY4S-62**

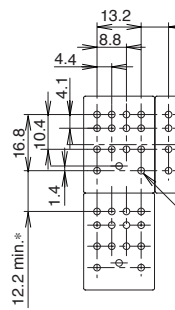
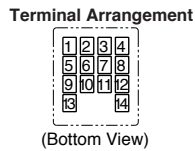
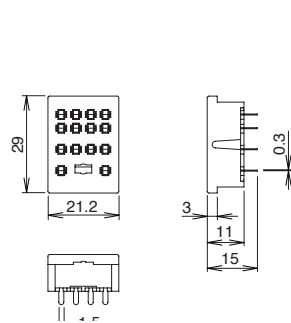

Operating Instructions

Driving Circuit for Relays

- To ensure correct relay operation, apply rated voltage to the relay coil.
- Input voltage for the DC coil:  
A complete DC voltage is best for the coil power to make sure of stable relay operation. When using a power supply containing a ripple voltage, suppress the ripple factor within 5%. When power is supplied through a rectification circuit, the relay operating characteristics, such as pickup voltage and dropout voltage, depend on the ripple factor. Connect a smoothing capacitor for better operating characteristics as shown below.

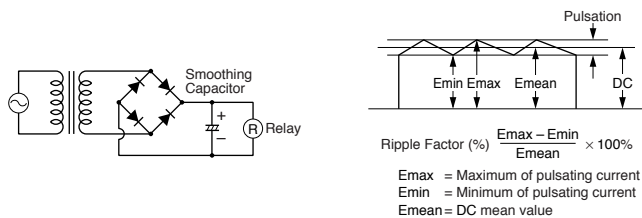

- Leakage current while relay is off:  
When driving an element at the same time as the relay operation, special consideration is needed for the circuit design. As shown in the incorrect circuit below, leakage current ( $I_0$ ) flows through the relay coil while the relay is off. Leakage current causes coil release failure or adversely affects the vibration resistance and shock resistance. Design a circuit as shown in the correct example.

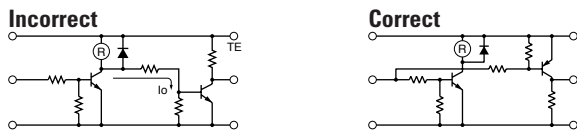

- Surge suppression for transistor driving circuits:  
When the relay coil is turned off, a high-voltage pulse is generated, causing a transistor to deteriorate and sometimes to break. Be sure to connect a diode to suppress the back electromotive force. Then, the coil release time becomes slightly longer. To shorten the coil release time, connect a Zener diode between the collector and emitter of the transistor. Select a Zener voltage slightly higher than the power voltage.

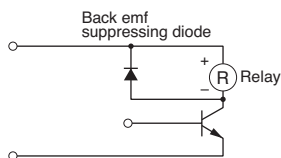

Protection for Relay Contacts

- The contact ratings show maximum values. Make sure that these values are not exceeded. When an inrush current flows through the load, the contact may become welded. If this is the case, connect a contact protection circuit, such as a current limiting resistor.
- Contact protection circuit:  
When switching an inductive load, arcing causes carbides to form on the contacts, resulting in increased contact resistance. In consideration of contact reliability, contact life, and noise suppression, use of a surge absorbing circuit is recommended. Note that the release time of the load becomes slightly longer. Check the operation using the actual load. Incorrect use of a contact protection circuit will adversely affect switching characteristics. Four typical examples of contact protection circuits are shown in the following table:

<b>RC</b>		<p>This protection circuit can be used when the load impedance is smaller than the RC impedance in an AC load power circuit.</p> <ul style="list-style-type: none"> <li>R: Resistor of approximately the same resistance value as the load</li> <li>C: 0.1 to 1 <math>\mu</math>F</li> </ul>
<b>Diode</b>		<p>This protection circuit can be used for DC load power circuits. Use a diode with the following ratings.</p> <p>Reverse withstand voltage: Power voltage of the load circuit x 10</p> <p>Forward current: More than the load current</p>
<b>Varistor</b>		<p>This protection circuit can be used for both AC and DC load power circuits.</p> <p>For a best result, when using a power voltage of 24 to 48V AC/DC, connect a varistor across the load.</p> <p>When using a power voltage of 100 to 240V AC/DC, connect a varistor across the contacts.</p>

- Do not use a contact protection circuit as shown below:

	<p>This protection circuit is very effective in arc suppression when opening the contacts. But, the capacitor is charged while the contacts are opened. When the contacts are closed, the capacitor is discharged through the contacts, increasing the possibility of contact welding.</p>
	<p>This protection circuit is very effective in arc suppression when opening the contacts. But, when the contacts are closed, a current flows to charge the capacitor, causing contact welding.</p>

Generally, switching a DC inductive load is more difficult than switching a DC resistive load. Using an appropriate arc suppressor, however, will improve the switching characteristics of a DC inductive load.

Soldering

- When soldering the relay terminals, use a soldering iron of 30 to 60W, and quickly complete soldering (within approximately 3 seconds).
- Use a non-corrosive rosin flux.

Switches & Pilot Lights

Display Lights

Relays & Sockets

Timers

Terminal Blocks

Circuit Breakers

## Operating Instructions con't

## Other Precautions

1. General notice:
  - To maintain the initial characteristics, do not drop or shock the relay.
  - The relay cover cannot be removed from the base during normal operation. To maintain the initial characteristics, do not remove the relay cover.
  - Use the relay in environments free from condensation, dust, sulfur dioxide (SO<sub>2</sub>), and hydrogen sulfide (H<sub>2</sub>S).
  - Make sure that the coil voltage does not exceed applicable coil voltage range.
2. UL and CSA ratings may differ from product rated values determined by IDEC.
3. Do not use relays in the vicinity of strong magnetic field, as this may affect relay operation.

## Safety Precautions

- Turn off the power to the relay before starting installation, removal, wiring, maintenance, and inspection of the relays. Failure to turn power off may cause electrical shock or fire hazard.
- Observe specifications and rated values, otherwise electrical shock or fire hazard may be caused.
- Use wires of the proper size to meet voltage and current requirements. Tighten the terminal screws on the relay socket to the proper tightening torque.
- Surge absorbing elements on AC relays with RC or DC relays with diode are provided to absorb the back electromotive force generated by the coil. When the relay is subject to an excessive external surge voltage, the surge absorbing element may be damaged. Add another surge absorbing provision to the relay to prevent damage.

## Precautions for the RU Relays

- Before operating the latching lever of the RU relay, turn off the power to the RU relay. After checking the circuit, return the latching lever to the original position.
- Do not use the latching lever as a switch. The durability of the latching lever is a minimum of 100 operations.
- When using DC loads on 4PDT relays, apply a positive voltage to terminals of neighboring poles and a negative voltage to the other terminals of neighboring poles to prevent the possibility of short circuits.
- DC relays with a diode have a polarity in the coil terminals. Apply the DC voltage to the correct terminals.