

General-purpose Latching Relay MYK

Magnetic Latching Relay Ideal for Memory and Data Transmission Circuits

- Double-winding latch system that holds residual magnetism.
- Changes due to aging are negligible because of use of special magnetic materials, thus ensuring long continuous holding time.
- Little change in characteristics such as contact follow, contact pressure, etc., throughout its long life.
- Excellent vibration/shock resistance.
- Easy monitoring of ON/OFF operation thanks to the built-in operation indicator mechanism.
- Same outline dimensions as the MY Miniature Power Relay.

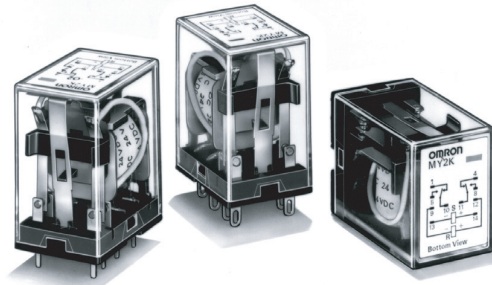

Ordering Information

List of Models

Contact form	Plug-in/solder terminal model	PCB terminal model
DPDT	MY2K	MY2K-02

Accessories (Order Separately)

Connecting Sockets

	Front-connecting Socket	Back-connecting Socket		
	Screw terminals	Solder terminals	Wire-wrap terminals	PCB terminals
Without Relay Hold-down Clip	PYF14A-E PYF14A PYF14-N	PY14	PY14QN	PY14-02
With Hold-down Clip	---	PY14-Y1	PY14QN-Y1	---

Note: Refer to the MY Datasheet for detail information on the Relay Hold-down Clips and Relay-mounting Sockets.

Specifications

■ Coil Ratings

Rated voltage		Set coil			Reset coil			Must-set voltage	Must-reset voltage	Max. voltage	Power consumption (Approx.)		
		Rated current		Resistance	Rated current		Resistance				% of rated voltage	Set coil	Reset coil
		50 Hz	60 Hz		50 Hz	60 Hz							
AC	12 V	57 mA	56 mA	72 Ω	39 mA	38.2 mA	130 Ω	80% max.	80% max.	110%	0.6 to 0.9 (60 Hz)	0.2 to 0.5 (60 Hz)	
	24 V	27.5 mA	26.4 mA	320 Ω	18.6 mA	18.1 mA	550 Ω						
	50 V	14.0 mA	13.4 mA	1,400 Ω	3.5 mA	3.4 mA	3,000 Ω						
	100 V	7.1 mA	6.9 mA	5,400 Ω	3.5 mA	3.4 mA	3,000 Ω						
DC	12 V	110 mA		110 Ω	50 mA		235 Ω				1.3 W	0.6 W	
	24 V	52 mA		470 Ω	25 mA		940 Ω						

- Note:**
- For AC models, the rated current values are half-wave rectified current values measured with a DC ammeter.
 - The rated current and coil resistance are measured at a coil temperature of 23°C with tolerances of +15%/-20% for AC rated current and ±15% for DC rated current, and +15% for DC coil resistance.
 - The AC coil resistance values are for reference only.
 - Performance characteristic data are measured at a coil temperature of 5°C to 35°C.

■ Contact Ratings

Item	Resistive load (cosφ = 1)	Inductive load (cosφ = 0.4) (L/R = 7 ms)
Rated load	3 A at 220 VAC, 3 A at 24 VDC	0.8 A at 220 VAC, 1.5 A at 24 VDC
Rated carry current	3 A	
Max. switching voltage	250 VAC, 125 VDC	
Max. switching current	3 A	
Max. switching power	660 VA, 72 W	176 VA, 36 W
Failure rate* (reference value)	1 mA at 1 VDC	

*Note: P level: $\lambda_{60} = 0.1 \times 10^{-6}/\text{operation}$

■ Characteristics

Contact resistance	50 mΩ max.
Set time	Time: AC: 30 ms max.; DC: 15 ms max.
	Min. pulse width: AC: 60 ms.; DC: 15 ms.
Reset time	Time: AC: 30 ms max.; DC: 15 ms max.
	Min. pulse width: AC: 60 ms.; DC: 15 ms.
Max. operating frequency	Mechanical: 18,000 operations/hr Electrical: 1,800 operations/hr (under rated load)
Insulation resistance	100 MΩ min. (at 500 VDC)
Dielectric strength	1,500 VAC, 50/60 Hz for 1 min (1,000 VAC between contacts of same polarity and between set and reset coils)
Vibration resistance	Destruction: 10 to 55 to 10 Hz, 0.5 mm single amplitude (1.0 mm double amplitude) Malfunction: 10 to 55 to 10 Hz, 0.5 mm single amplitude (1.0 mm double amplitude)
Shock resistance	Destruction: 1,000 m/s ² Malfunction: 200 m/s ²
Endurance	Mechanical: 100,000,000 operations min. (at 18,000 operations/hr) Electrical: 200,000 operations min. (at 1,800 operations/hr)
Ambient temperature	Operating: -55°C to 60°C (with no icing)
Ambient humidity	Operating: 5% to 85%
Weight	Approx. 30 g

Note: The data shown above are initial values.

Engineering Data

Maximum Switched Power

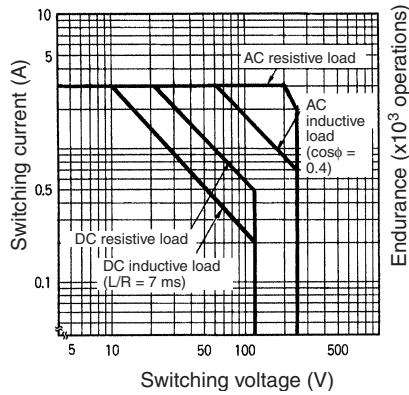

Endurance

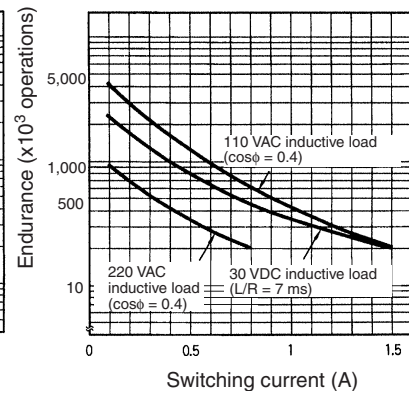
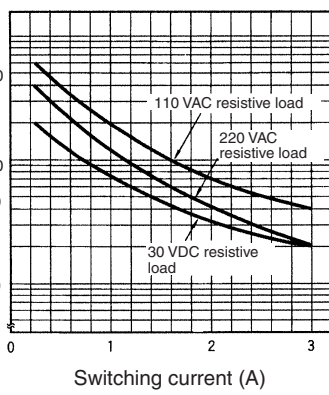

Dimensions

MY2K

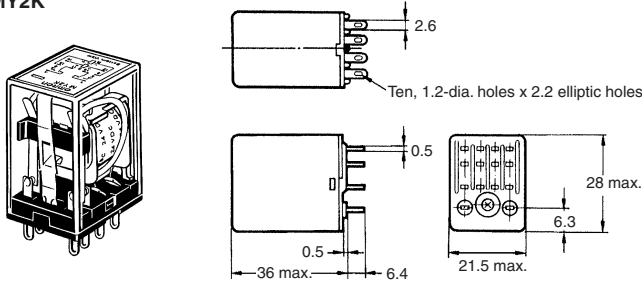

MY2K-02

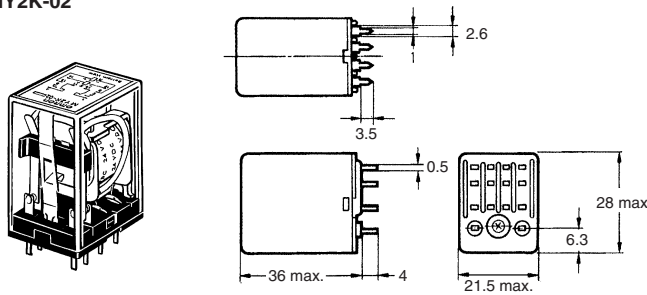

Mounting Holes (Bottom View)

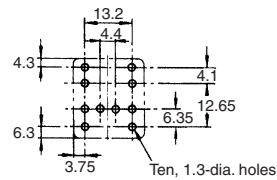

Note: Dimensional tolerances are ± 0.1 mm.

Terminal Arrangement/Internal Connections (Bottom View)

AC Model

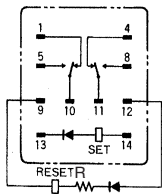

DC Model

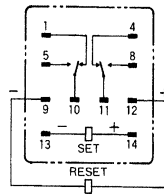

Use at 220 VAC

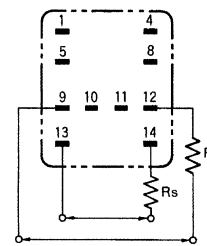

Rs: 7.3 kΩ 3 W
Rr: 14.3 kΩ 1 W

- Note:**
1. Resistor is for ampere-turn compensation and is incorporated in the Relay rated at 50 VAC or above.
 2. Pay attention to the polarity of the set and reset coils, as incorrect connection of positive and negative terminal will result in the Relay malfunctioning.

When using the Relay rated at 110 VAC at a supply voltage of 220 VAC, be sure to connect external resistors Rs and Rr to the Relay.

If the supply voltage is applied to the set and reset coils at the same time, the Relay will be put in the set state.

Cat. No. J013-E1-02

In the interest of product improvement, specifications are subject to change without notice.

OMRON EUROPE B.V.

Wegalaan 67-69,
NL-2132 JD, Hoofddorp,
The Netherlands
Phone: +31 23 568 13 00
Fax: +31 23 568 13 88
www.eu.omron.com