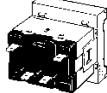
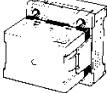

■ Accessories (Order Separately)

Terminals	Contact form	Model	P99-07 E-brackets 	P7LF-D DIN Track Mounting Adapter 	P7LF-06 Front Connecting Socket 
Quick-connect terminals	SPST-NO	G7L-1A-T	Yes	Yes	Yes
		G7L-1A-TJ	Yes	Yes	Yes
	DPST-NO	G7L-2A-T	Yes	Yes	Yes
		G7L-2A-TJ	Yes	Yes	Yes
Screw terminals	SPST-NO	G7L-1A-B	Yes	Yes	No
		G7L-1A-BJ	Yes	Yes	No
	DPST-NO	G7L-2A-B	Yes	Yes	No
		G7L-2A-BJ	Yes	Yes	No

Applicable Relay	Name	Model
G7L-1A-T/G7L-1A-TJ/G7L-1A-B/G7L-1A-BJ G7L-2A-T/G7L-2A-TJ/G7L-2A-B/G7L-2A-BJ	E-bracket	R99-07
	Adapter	P7LF-D
G7L-1A-T/G7L-1A-TJ/G7L-2A-T/G7L-2A-TJ	Front-connecting Socket	P7LF-06
G7L-1A-B/G7L-1A-BJ/G7L-1A-BUB/G7L-1A-BUBJ G7L-2A-B/G7L-2A-BJ/G7L-2A-BUB/G7L-2A-BUBJ	Cover	P7LF-C

Model Number Legend

G7L - -

1 2 3 4 , 5

1. Contact Form

1A: SPST-NO
2A: DPST-NO

2. Terminal Shape

T: Quick-connect terminals
P: PCB terminals
B: Screw terminals

3. Mounting Construction

Blank: E-bracket
UB: Upper bracket
4. Special Functions
Blank: Standard mode
J: With test button

5. Rated Coil Voltage

AC: 12, 24, 50, 100 to 120, 200 to 240
DC: 6, 12, 24, 48, 100

Application Examples

- Compressors for air conditioners and heater switching controllers.
- Switching controllers for power tools or motors.
- Power controllers for water heaters.
- Power controllers for dryers.
- Lamp controls, motor drivers, and power supply switching in copy machines, facsimile machines, and other office equipment.
- Lighting controllers.
- Power controllers for packers or food processing equipment.
- Magnetron control in microwaves.

Specifications

■ Coil Ratings

Rated Voltage		Rated current	Coil resistance	Must operate voltage	Must release voltage	Max. voltage	Power consumption (approx.)
AC (~)	12 V	142 mA	–	75% max. of rated voltage	15% min. of rated voltage	110% of rated voltage	1.7 to 2.5 VA (60 Hz)
	24 V	71 mA	–				
	50 V	34 mA	–				
	100 to 120 V	7.0 to 20.4 mA	–	75 V	18 V	132 V	
	200 to 240 V	8.5 to 10.2 mA	–	150 V	36 V	264 V	
DC (=)	6 V	317 mA	18.9 Ω	75% max. of rated voltage	15% min. of rated voltage	110% of rated voltage	1.9 W
	12 V	158 mA	75 Ω				
	24 V	79 mA	303 Ω				
	48 V	40 mA	1220 Ω				
	100 V	19 mA	5260				

Note: 1. The rated current and coil resistance are measured at a coil temperature of 23°C with tolerances of +15%/–20% for AC rated current and ±15% for DC coil resistance.

2. Performance characteristic data are measured at a coil temperature of 23°C.

3. ~ indicates AC and = indicates DC (IEC417 publications).

■ Contact Ratings

Model	G7L-1A-T@/G7L-1A-B@		G7L-2A-T@/G7L-2A-B@		G7L-1A-P/G7L-2A-P	
	Resistive load (cosφ = 1)	Inductive load (cosφ = 0.4)	Resistive load (cosφ = 1)	Inductive load (cosφ = 0.4)	Resistive load (cosφ = 1)	Inductive load (cosφ = 0.4)
Rated Load	30 A, 220 VAC (~)	25 A, 220 VAC (~)	25 A, 220 VAC (~)		25 A, 220 VAC (~)	
Carry Current	30 A		25 A		20 A	
Max. switching voltage	250 VAC (~)		250 VAC (~)		250 VAC (~)	
Max. switching current	30 A		25 A		20 A	
Max. switching power	6,600 VAC (~)	5,500 VAC (~)	5,500 VAC (~)		4,400 VAC (~)	
Failure rate* (reference value)	100 mA, 5 VDC (~)		100 mA, 5 VDC (~)		100 mA, 5 VDC (~)	

*Note: P level: $\lambda_{60} = 0.1 \times 10^{-6}$ /operation

■ Characteristics

Contact resistance	50 mΩ max.
Operate time	30 ms max.
Release time	30 ms max.
Max. operating frequency	Mechanical: 1,800 operations/hr Electrical: 1,800 operations/hr (under rated load)
Insulation resistance	1,000 MΩ min. (at 500 VDC)
Dielectric strength	4,000 VAC min., 50/60 Hz for 1 min between coil and contacts 2,000 VAC, 50/60 Hz for 1 min between contacts of same polarity 2,000 VAC, 50/60 Hz for 1 min between contacts of different polarity (DPST-NO model)
Impulse withstand voltage	10,000 V between coil and contact (with 1.2 x 50 μs impulse wave)
Vibration resistance	Destruction: 10 to 55 to, 0.75 mm single amplitude (1.5 mm double amplitude) Malfunction: 10 to 55 to, 0.75 mm single amplitude (1.5 mm double amplitude)
Shock resistance	Destruction: 1,000 m/s ² Malfunction: 100 m/s ²
Endurance	Mechanical: 1,000,000 operations min. (at 1,800 operations/hr) Electrical: 100,000 operations min. (at 1,800 operations/hr under rated load)
Ambient temperature	Operating: -25°C to 60°C (with no icing)
Ambient humidity	Operating: 5% to 85%
Weight	Quick-connect terminal models: approx. 90 g PCB terminal models: approx. 100 g Screw terminal models: approx. 120 g

Note: The values given above are initial values

■ **Approved by Standards**
UL 508, 1950 Recognitions (File No. E41643)
CSA 22.2 No.14 Listings (File No.LR35535)

Model	Contact Form	Coil ratings	Contact ratings	Operations
G7L-1A-T@ G7L-1A-B@	SPST-NO	12 to 240 VAC 5 to 220 VDC	30 A, 277 VAC (RES) 25 A, 277 VAC (GEN) 30 A, 120 VAC (GEN)	100 x 10 ³
			1.5 kW, 120 VAC (T) 1.5 HP, 120 VAC	6 x 10 ³
			3 HP, 277 VAC	100 x 10 ³ (CSA; 6 x 10 ³)
			20 FLA/120 LRA, 120 VAC 17 FLA/102 LRA, 265 VAC	30 x 10 ³
G7L-2A-T@ G7L-2A-B@	DPST-NO		TV-10, 120 VAC	25 x 10 ³
			25 A, 277 VAC (RES) 25 A, 277 VAC (GEN) 25 A, 120 VAC (GEN)	100 x 10 ³
			1.3 kW, 120 VAC (T) 1 HP, 120 VAC	6 x 10 ³
			2 HP, 277 VAC	100 x 10 ³ (CSA; 6 x 10 ³)
G7L-1A-P	SPST-NO		20 FLA/120 LRA, 120 VAC 17 FLA/102 LRA, 265 VAC	30 x 10 ³
			TV-8, 120 VAC	25 x 10 ³
			20 A, 277 VAC (RES) 20 A, 277 VAC (GEN) 20 A, 120 VAC (GEN)	100 x 10 ³
			1.5 kW, 120 VAC (T) 1.5 HP, 120 VAC	6 x 10 ³
G7L-2A-P	DPST-NO		3 HP, 277 VAC	100 x 10 ³ (CSA; 6 x 10 ³)
			20 FLA/120 LRA, 120 VAC 17 FLA/102 LRA, 265 VAC	30 x 10 ³
			TV-10, 120 VAC	25 x 10 ³
			20 A, 277 VAC (RES) 20 A, 277 VAC (GEN) 20 A, 120 VAC (GEN)	100 x 10 ³
			1.3 kW, 120 VAC (T) 1 HP, 120 VAC	6 x 10 ³
			2 HP, 277 VAC 20 FLA/120 LRA, 120 VAC 17 FLA/102 LRA, 265 VAC	100 x 10 ³ 30 x 10 ³
			TV-8, 120 VAC	25 x 10 ³

General Purpose Relays

TÜV: File No. R9051158 (VDE 0435, IEC 255, IEC 950, EN60950)

Model	Contact Form	Coil ratings	Contact ratings	Operations
G7L-1A-B@	SPST-NO	6, 12, 24, 48, 100, 110, 200, 220 VDC 12, 24, 50, 100 to 120, 200 to 240 VAC	30 A, 240 VAC ($\cos\phi = 1.0$) 25 A, 240 VAC ($\cos\phi = 0.4$) 30 A, 120 VAC ($\cos\phi = 0.4$)	100 x 10 ³
G7L-2A-B@	DPST-NO		25 A, 240 VAC ($\cos\phi = 1.0$) 25 A, 240 VAC ($\cos\phi = 0.4$)	
G7L-1A-T@	SPST-NO		25 A, 240 VAC ($\cos\phi = 1.0$) 25 A, 240 VAC ($\cos\phi = 0.4$)	
G7L-2A-T@	DPST-NO		25 A, 240 VAC ($\cos\phi = 1.0$) 25 A, 240 VAC ($\cos\phi = 0.4$)	
G7L-1A-P	SPST-NO		20 A, 240 VAC ($\cos\phi = 1.0$) 20 A, 240 VAC ($\cos\phi = 0.4$)	
G7L-2A-P	DPST-NO		20 A, 240 VAC ($\cos\phi = 1.0$) 20 A, 240 VAC ($\cos\phi = 0.4$)	

Engineering Data

G7L-1A-T/G7L-1A-B

Maximum Switching Power

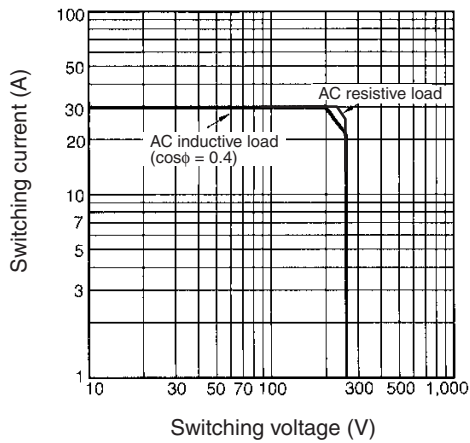

Endurance

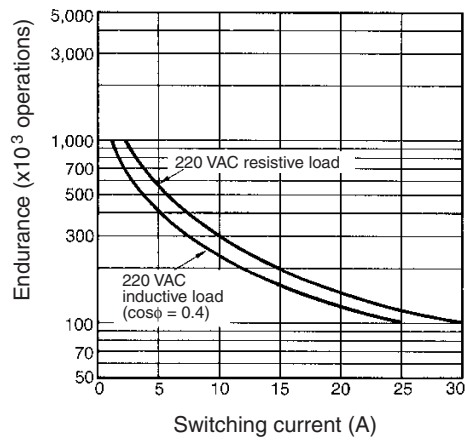

G7L-2A-T/G7L-2A-B

Maximum Switching Power

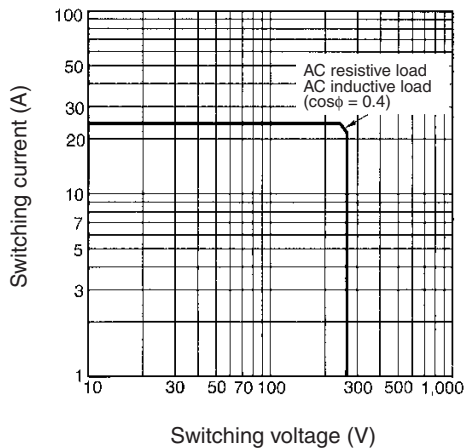

Endurance

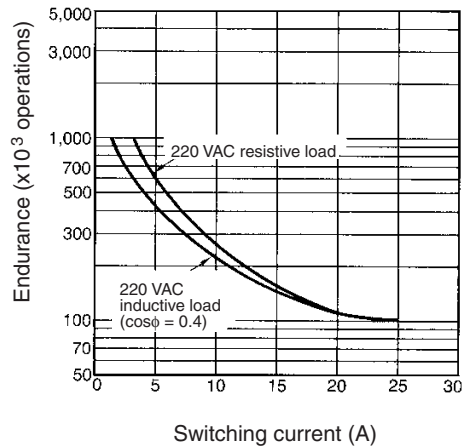

Engineering Data

G7L-1A-P/G7L-2A-P

Maximum Switching Power

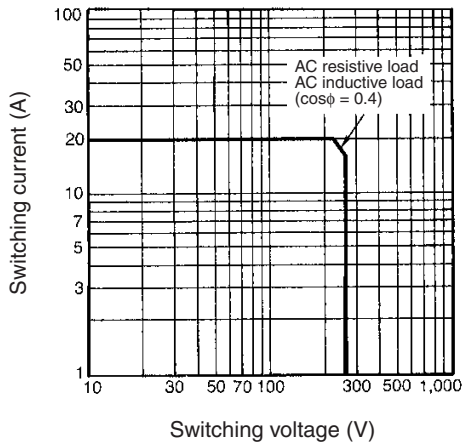

Endurance

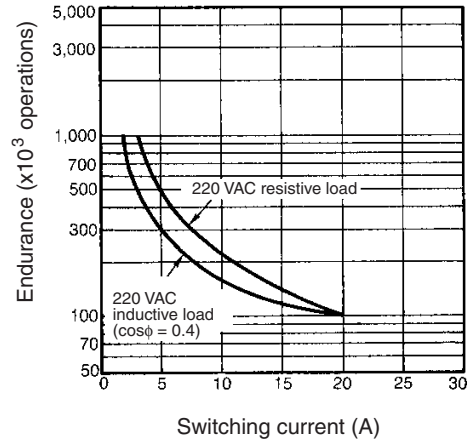

Dimensions

- Note: 1. All units are in millimetres unless otherwise indicated.
- 2. E-brackets are sold separately.

■ Quick-connect Terminals with E-bracket

G7L-1A-T

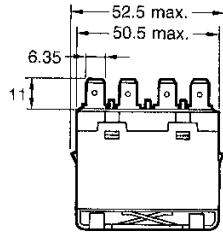
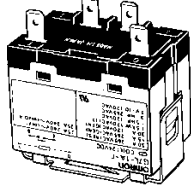

Terminal Arrangement/
Internal Connections
(Top View)

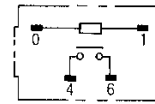

Mounting Holes

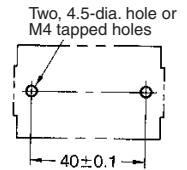

G7L-2A-T

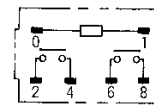
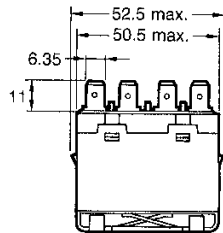
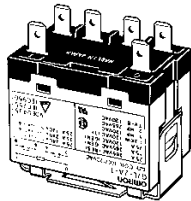

G7L-1A-TJ
with Test Button

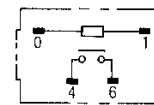
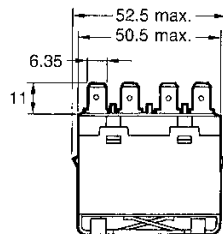
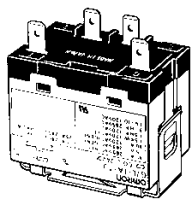

■ Quick-connect Terminals with E-bracket (contd)

G7L-2A-TJ with Test Button

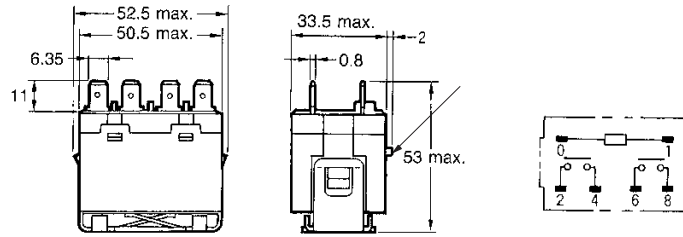
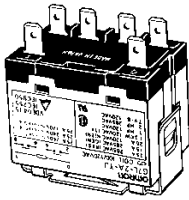

■ Quick-connect Terminals with DIN Track Mounting Adapter

Note: 1. The DIN Track Mounting Adapter and DIN tracks are sold separately.

2. The DIN Track Mounting Adapter can be track-mounted or screw-mounted.

G7L-1A-T

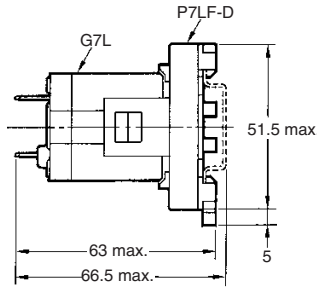
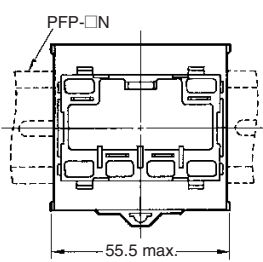
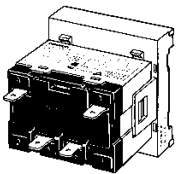

Terminal Arrangement/
Internal Connections
(Top View)

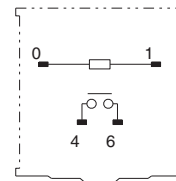

Mounting Holes

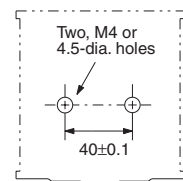

G7L-2A-T

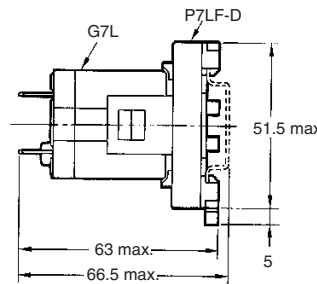
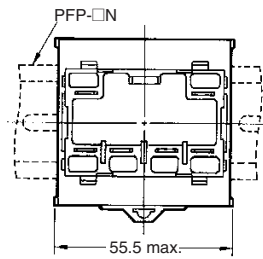
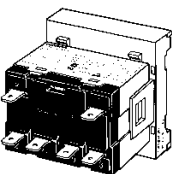

Terminal Arrangement/
Internal Connections
(Top View)

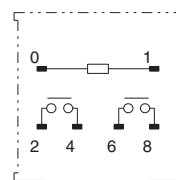

Mounting Holes

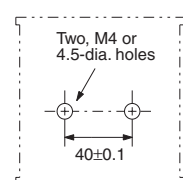

G7L-1A-TJ with Test Button

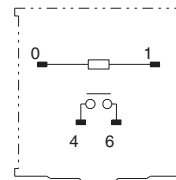
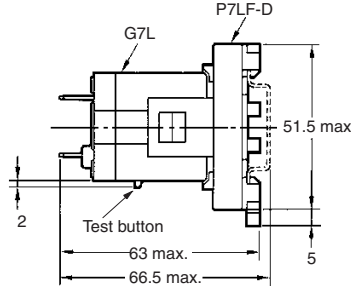
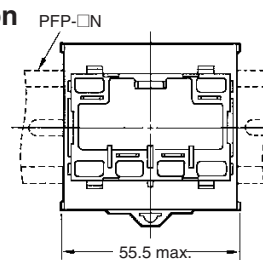
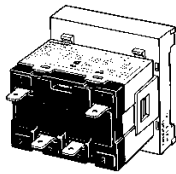

G7L-2A-TJ with Test Button

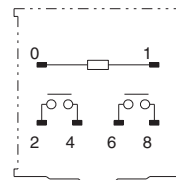
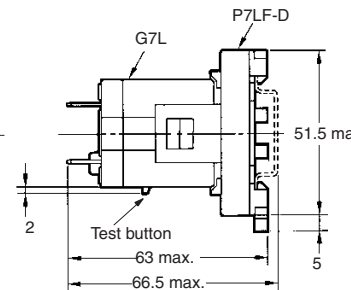
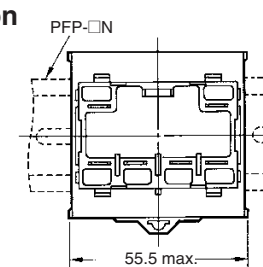
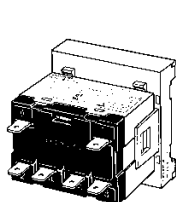

■ Quick-connect Terminals with Front-connecting Socket

- Note:** 1. The Front-connecting Socket and DIN tracks are sold separately.
 2. The Front-connecting Socket can be track-mounted or screw-mounted.

G7L-1A-T

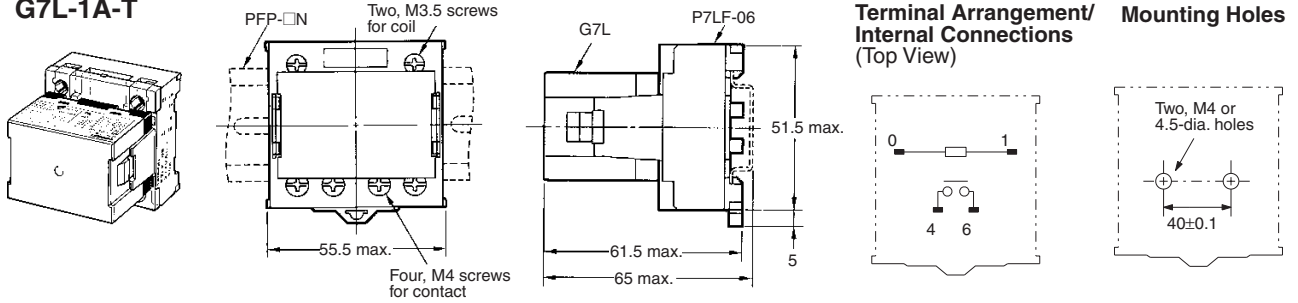

G7L-2A-T

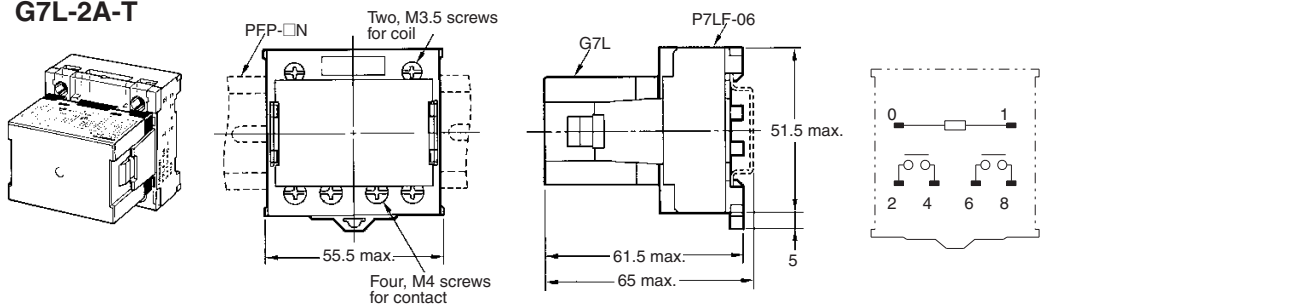

G7L-1A-TJ with Test Button

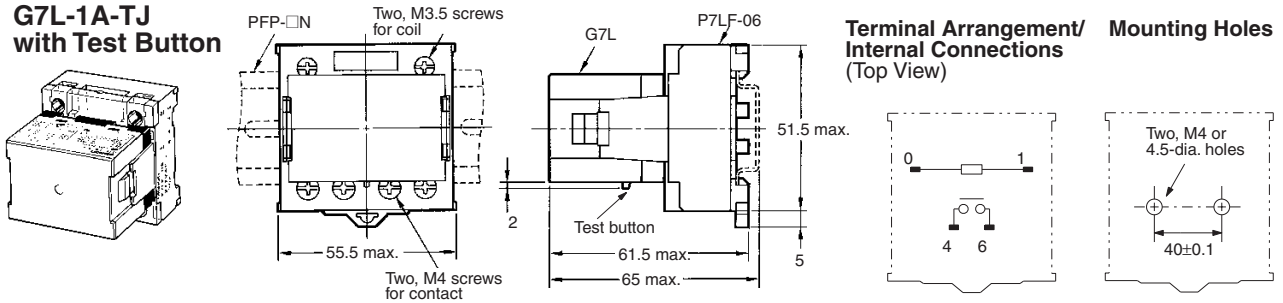

G7L-2A-TJ with Test Button

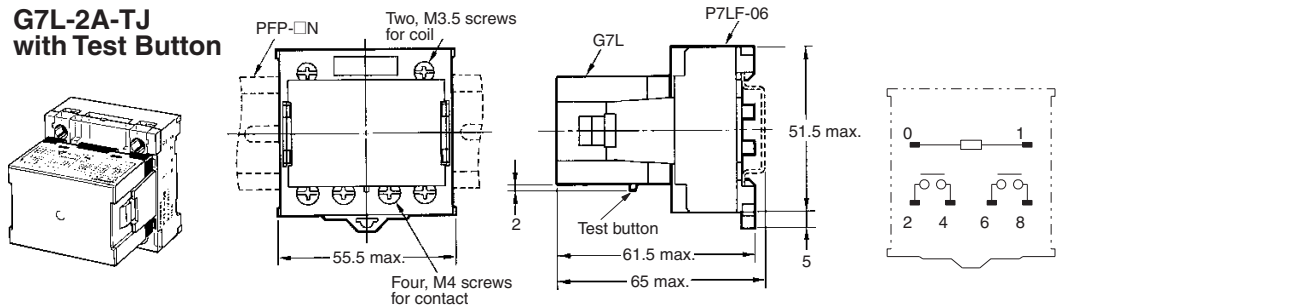

■ Quick-connect Terminals with Upper Bracket

G7L-1A-TUB

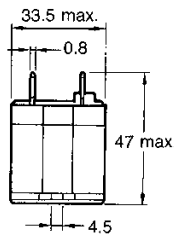
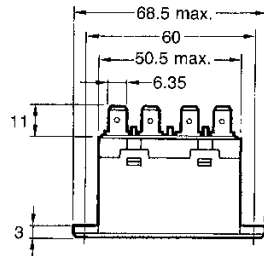
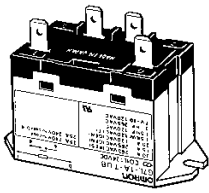

Terminal Arrangement/
Internal Connections
(Top View)

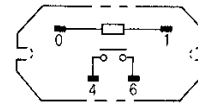

Mounting Holes

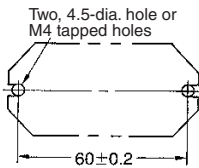

G7L-2A-TUB

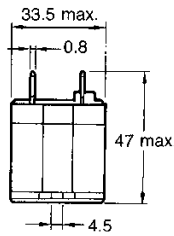
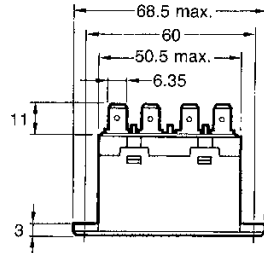
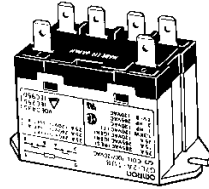

Terminal Arrangement/
Internal Connections
(Top View)

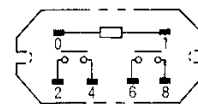

G7L-1A-TUBJ
with Test Button

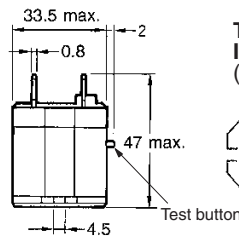
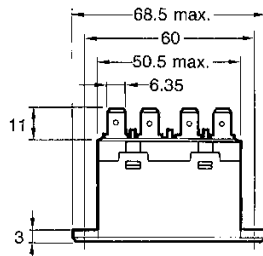
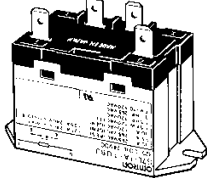

Terminal Arrangement/
Internal Connections
(Top View)

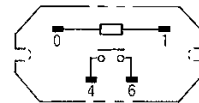

G7L-2A-TUBJ
with Test Button

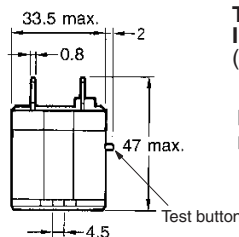
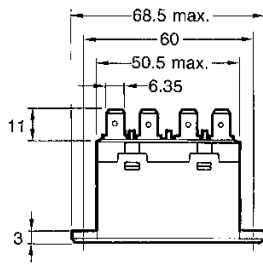
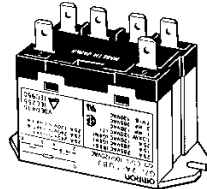

Terminal Arrangement/
Internal Connections
(Top View)

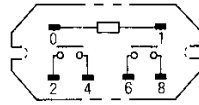

Mounting Holes

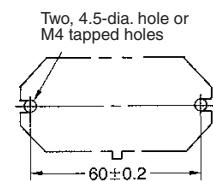

■ Screw Terminals with E-bracket

Note: E-brackets are sold separately.

G7L-1A-B

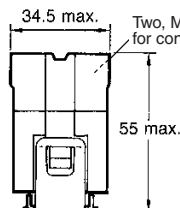
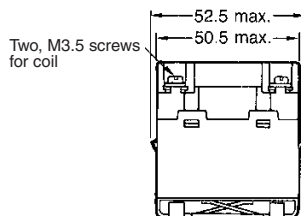
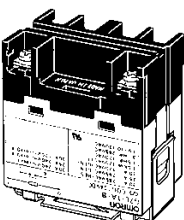

Terminal Arrangement/
Internal Connections
(Top View)

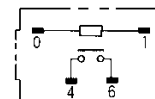

Mounting Holes

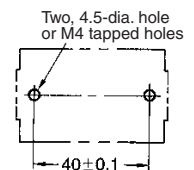

■ Screw Terminals with E-bracket (contd)

E-brackets are sold separately.

G7L-2A-B

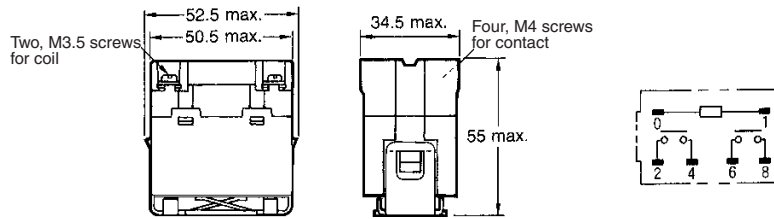
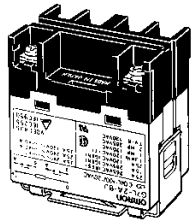

G7L-1A-BJ with Test Button

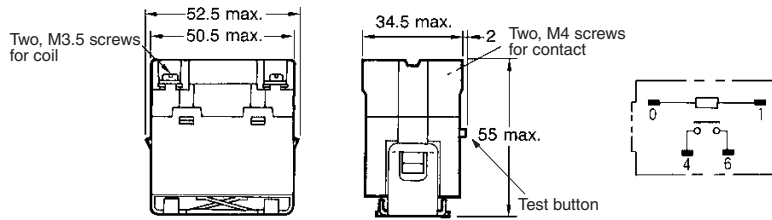
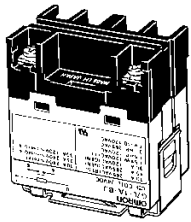

G7L-2A-BJ with Test Button

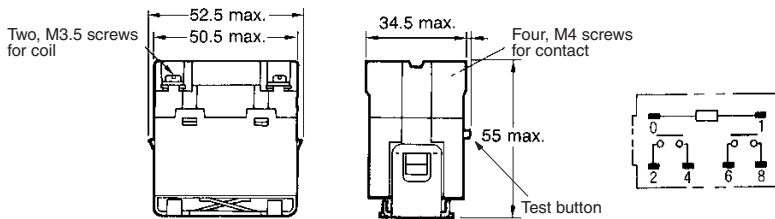
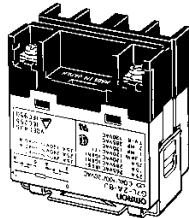

■ Screw Terminals with DIN Track Mounting Adapter

Note: 1. The DIN Track Mounting Adapter and DIN tracks are sold separately.

2. The DIN Track Mounting Adapter can be track-mounted or screw-mounted.

G7L-1A-B

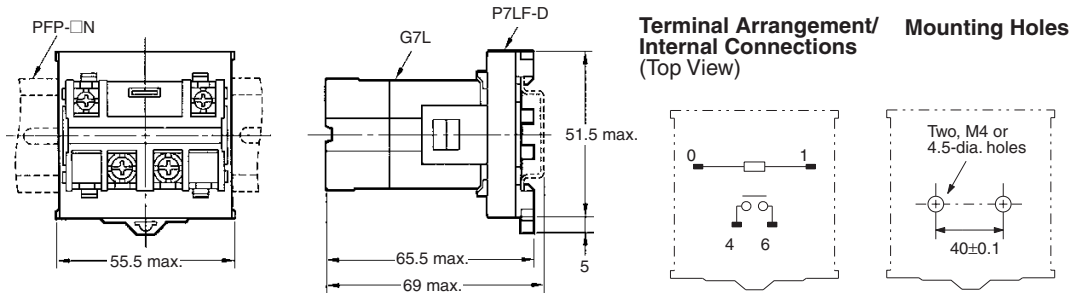
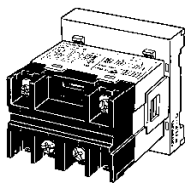

G7L-2A-B

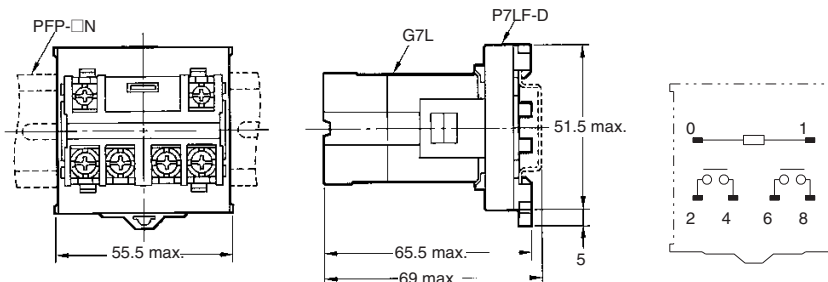
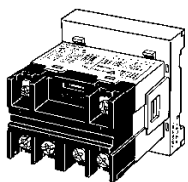

■ Screw Terminals with DIN Track Mounting Adapter (contd)

Note: 1. The DIN Track Mounting Adapter and DIN tracks are sold separately.

2. The DIN Track Mounting Adapter can be track-mounted or screw-mounted.

G7L-1A-BJ with Test Button

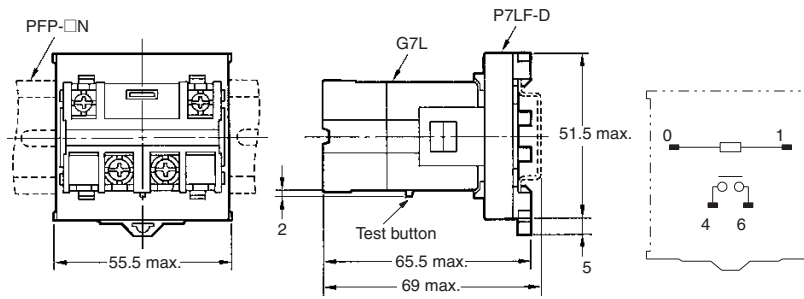
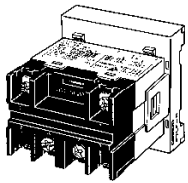

G7L-2A-BJ with Test Button

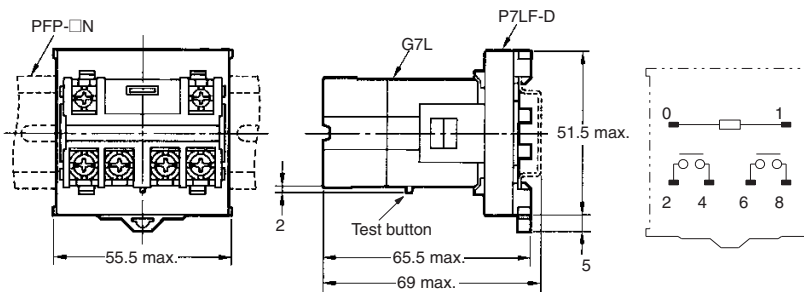
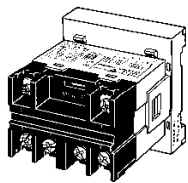

■ Screw Terminals with Upper Bracket

G7L-1A-BUB

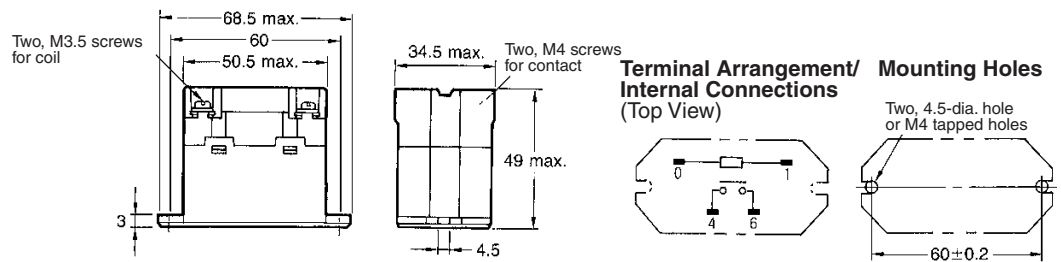
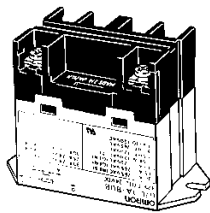

G7L-2A-BUB

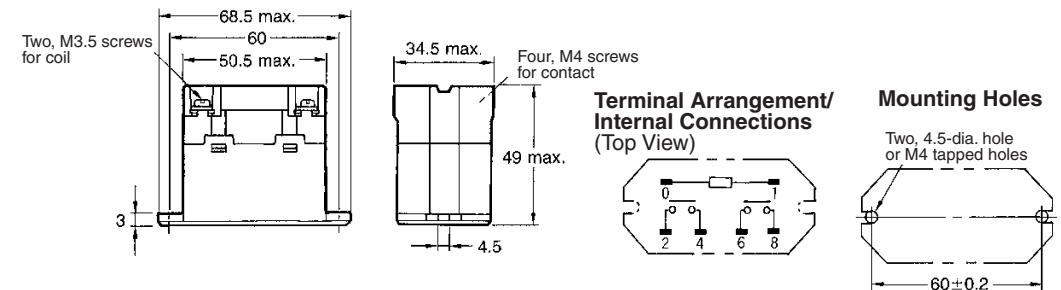
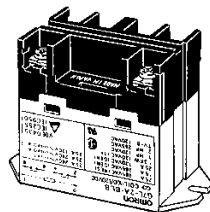

G7L-1A-BUBJ with Test Button

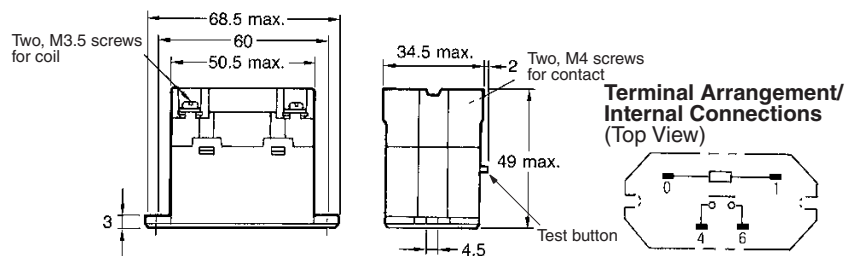
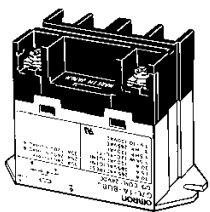

■ Screw Terminals with Upper Bracket (contd)

G7L-2A-BUBJ with Test Button

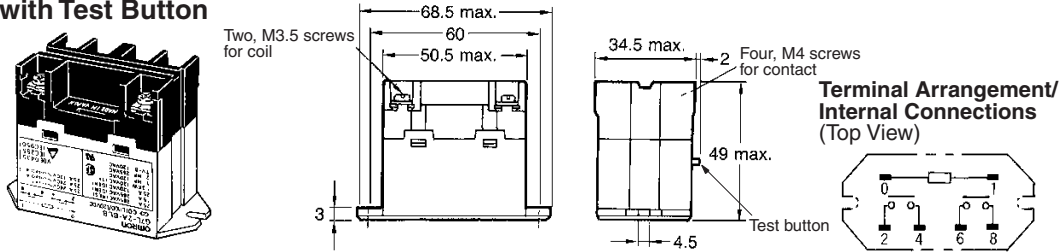

■ PCB Terminals with PCB Mounting

G7L-1A-P

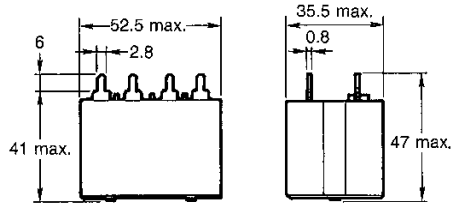
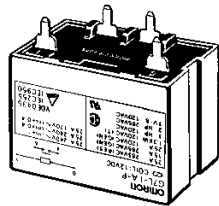

Terminal Arrangement/ Internal Connections (Top View)

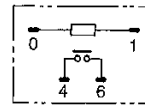

Mounting Holes (Bottom View)

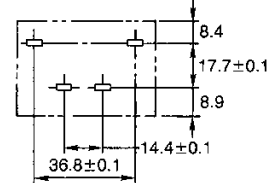

G7L-2A-P

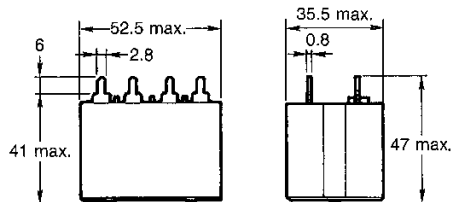
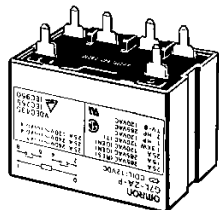

Terminal Arrangement/ Internal Connections (Top View)

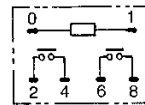

Mounting Holes (Bottom View)

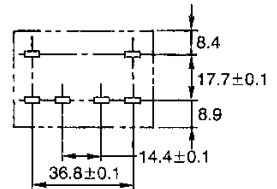

R99-07G5D E-bracket

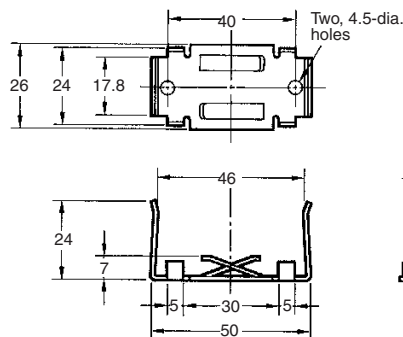
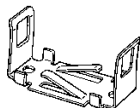

Mounting Holes (Bottom View)

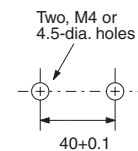

P7LF-D Adapter

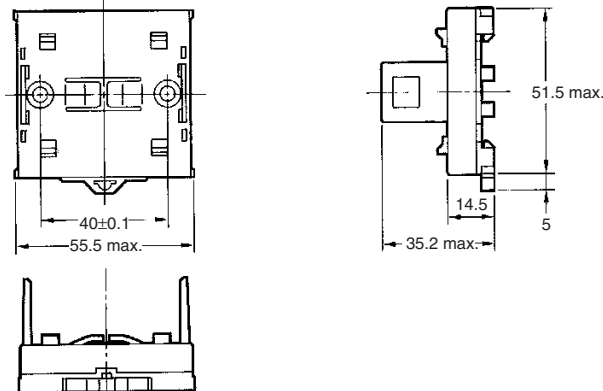
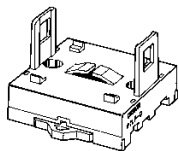

Mounting Holes (Bottom View)

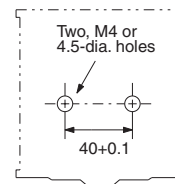

■ PCB Terminals with PCB Mounting (contd)

**P7LF-06
Front-connecting
Socket**

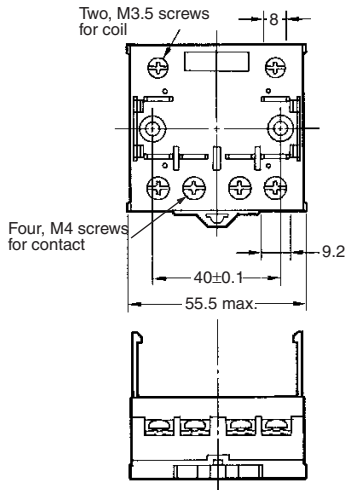
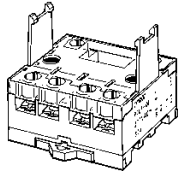

**Mounting Holes
(Bottom View)**

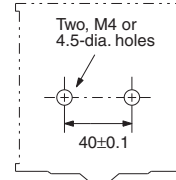

P7LF-C Cover

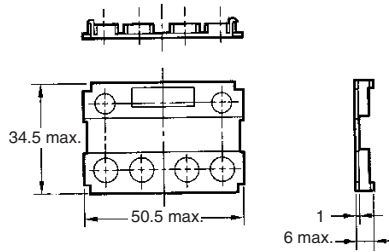
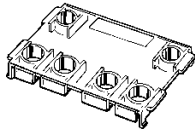

Put the P7LF-C cover onto the terminals in order to protect the user from electric shock.

■ Internal Coil Circuit

DC Operating Coil

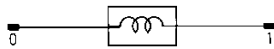

AC Operating Coil

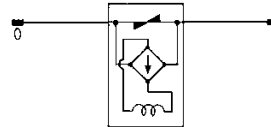

Precautions

HANDLING

- To preserve performance, do not drop or otherwise subject the Power Relay to shock.
- The case is not designed to be removed during normal handling and operation. Doing so may affect performance.
- Use the Power Relay in a dry environment free from excessive dust, SO₂, H₂S, or organic gas.
- Do not allow a voltage greater than the maximum allowable coil voltage to be applied continuously.
- Do not use the Power Relay outside of specified voltages and currents.
- Do not allow the ambient operating temperature to exceed the specified limit.

INSTALLATION

- Although there are not specific limits on the installation site, it should be as dry and dust-free as possible.
- PCB Terminal-equipped Relays weigh approximately 100 g. Be sure that the PCB is strong enough to support them. We recommend dual-side through-hole PCBs to reduce solder cracking from heat stress.
- Quick-connect terminals can be connected to Faston receptacle #250 and positive-lock connectors.
- Allow suitable slack on leads when wiring, and do not subject the terminals to excessive force.
- G7L Relays with test buttons must be mounted facing down.
- Be careful not to touch the test button accidentally. Doing so may turn ON the contact.
- Use the test button only to check the electrical conductivity. Do not switch the load directly by pushing the test button.

CLEANING PCB TERMINALS

- PCB terminals have flux-tight construction which prevents flux from penetrating into the Relay base housing, e.g., due to capillary action up the terminals when Relay is soldered onto the PCB. This type of Relay cannot be immersed for cleaning.

CONNECTING

- Refer to the following table when connecting a wire with a crimp-style terminal to the G7L.

Terminals	Screw terminals	Front-connecting Socket
Coil		
Contact		

RATED CURRENT FLOW

- When using B-series (screw) products, the rated current from the screw terminals (M4) should be 20 A or less according to jet standard (electrical appliance and material control law of Japan).

OPERATING COIL

- As a rule, either a DC battery or a DC power supply with a maximum of 5% ripple must be used for the operating voltage for DC Relays. Before using a rectified AC supply, confirm that the ripple is not greater than 5%. Ripple greater than this can lead to variations in the operating and reset voltages.

As excessive ripple can generate pulses, the insertion of a smoothing capacitor is recommended as shown below.

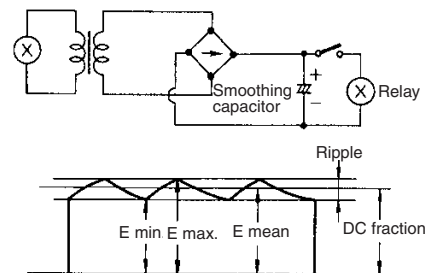

$$\% \text{ of ripple} = \frac{E \text{ max.} - E \text{ min.}}{E \text{ mean}} \times 100$$

E max.: Max. ripple
E min.: Min. ripple
E mean: Mean DC value

- When driving a transistor, check the leakage current and connect a bleeder resistor if necessary.

DIN TRACK MOUNTING ADAPTER AND FRONT-CONNECTING SOCKET

DIN Track Mounting

- Use a DIN-conforming 50-cm track or 1-m track (both are sold separately) for mounting a number of G7L Relays.
- Cut and shorten the track to an appropriate length if the required track length is less than 50 cm.
- The DIN Track Mounting Adapter and Front-connecting Socket can be mounted on the G7L with just one hand and dismantled with ease by using a screwdriver.
- To support the G7L mounted on a DIN Track Mounting Adapter or Front-connecting Socket, use the PFP-M End Plate. Put the End Plate onto the DIN Track Mounting Adapter or Front-connecting Socket so that the surface mark of the End Plate faces upwards. Then tighten the screw of the End Plate securely with a screwdriver.

Screw Mounting

- Screw-mount the DIN Track Mounting Adapter or Front-connecting Socket securely after opening screw mounting holes on them.
- When cutting or opening holes on the panel after the Front-connecting Socket is mounted, take proper measures so that the cutting chips will not fall onto the Relay terminals. When cutting or opening holes on the upper part of the panel, mask the Front-connecting Socket properly with a cover.