

OMRON

New G2RS Series

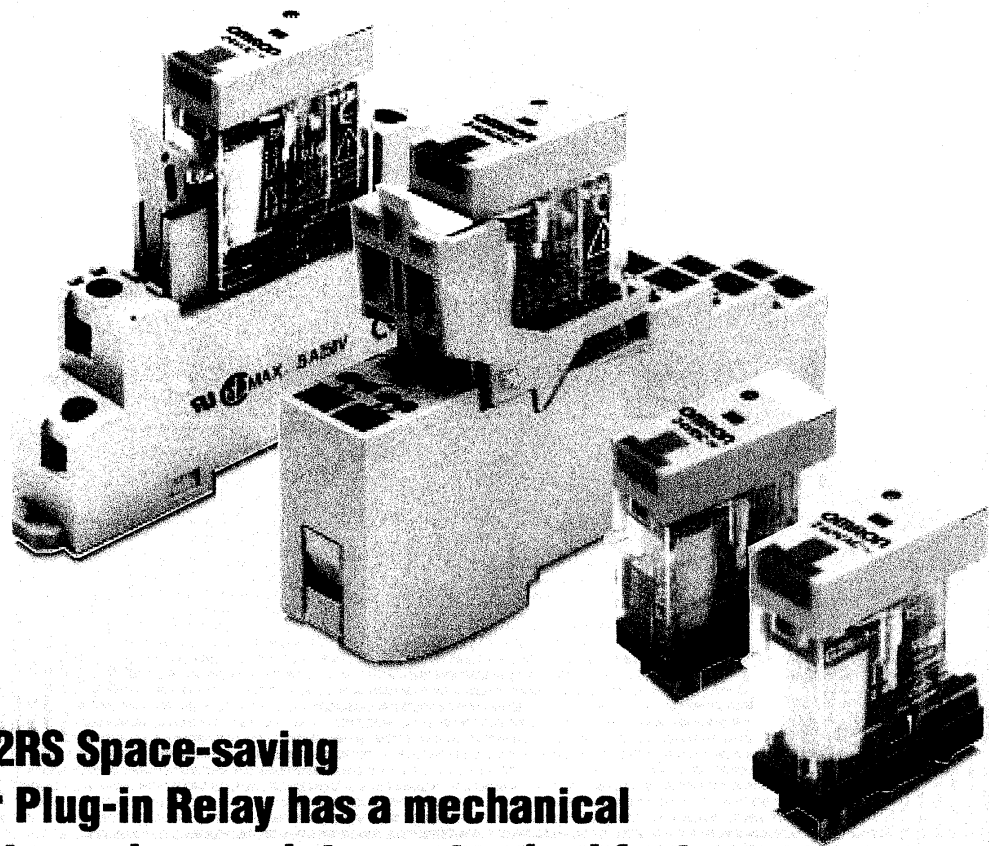

**The G2RS Space-saving
Power Plug-in Relay has a mechanical
indicator and nameplate as standard features.
A relay with a lockable test button is also available.**

Details on the New G2RS

Overview

Nameplate

LED indicator

Mechanical indicator

Test button

DC: Blue
AC: Red

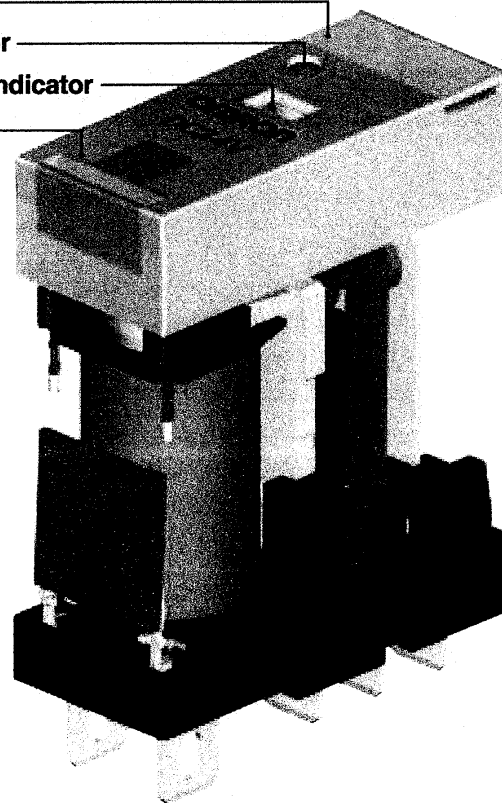

New Features

- Nameplate and mechanical indicator provided as a standard.
- Models with two-way-action test button available.
- Environment-friendly construction.

Two-way-action test button

Relay
in
operation



For
momentary
testing



Pull down the test button to the first stop position, then press the yellow button with an insulated tool to operate the contact.

For
lock
testing



Pull down the test button to the second stop position. (The contact is now in the locked position.)

General-purpose Relay G2RS New Model

Slim and Space-saving Power Plug-in Relay

- Lockable test button models now available.
- Built-in mechanical operation indicator.
- Provided with nameplate.
- AC type is equipped with a coil-disconnection self-diagnostic function (LED type).
- High switching power (1-pole: 10 A).
- Environment-friendly (Cd, Pb free).
- Wide range of Sockets also available.

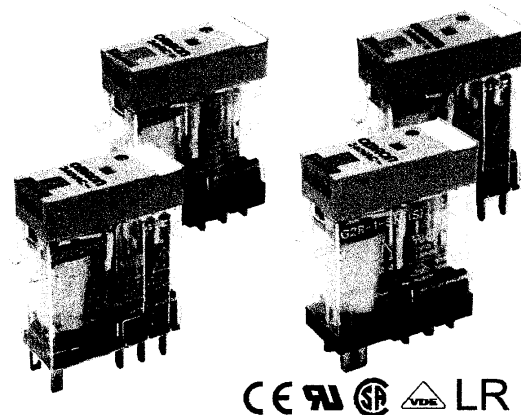

Model Number Structure

Model Number Legend

G2R \square_1 - \square_2 \square_3 \square_4 - \square_5 \square_6 - \square_7

1. Relay Function

Blank: General-purpose

2. Number of Poles

- 1: 1 pole
- 2: 2 poles

3. Contact Form

Blank: SPDT

4. Contact Type

Blank: Single

5. Terminals

S: Plug-in

6. Classification

Blank: General-purpose

N: LED indicator

D: Diode

ND: LED indicator and diode

NI: LED indicator with test button

NDI: LED indicator and diode with test button

7. Rated Coil Voltage

Ordering Information

List of Models

	Classification	Enclosure rating	Coil ratings	Contact form	
				SPDT	DPDT
Plug-in terminal	General-purpose	Unsealed	AC/DC	G2R-1-S	G2R-2-S
	LED indicator			G2R-1-SN	G2R-2-SN
	LED indicator with test button			G2R-1-SNI	G2R-2-SNI
	Diode		DC	G2R-1-SD	G2R-2-SD
	LED indicator and diode			G2R-1-SND	G2R-2-SND
	LED indicator and diode with test button			G2R-1-SNDI	G2R-2-SNDI

Note: When ordering, add the rated coil voltage and "(S)" to the model number. Rated coil voltages are given in the coil ratings table.

Example: G2R-1-S 12 VDC (S) New model
 Rated coil voltage

■ Accessories (Order Separately)

Connecting Sockets

Applicable Relay model	Track/surface-mounting Socket		Back-mounting Socket	
	Screwless clamp terminal	Screw terminal	Terminals	Model
1 pole G2R-1-S(N)(D)(ND)(NI)(NDI)	• P2RF-05S (See note.) + (P2CM-S (option))	• P2RF-05-E • P2RF-05	PCB terminals	P2R-05P, P2R-057P
			Solder terminals	P2R-05A
2 poles G2R-2-S(N)(D)(ND)(NI)(NDI)	• P2RF-08S (See note.) + (P2CM-S (option))	• P2RF-08-E • P2RF-08	PCB terminals	P2R-08P, P2R-087P
			Solder terminals	P2R-08A

Note: Use of the P2CM Clip & Release Lever is recommended to ensure stable mounting.

Accessories for Screwless Clamp Terminal Socket (Option)

Name	Model
Clip & Release Lever	P2CM-S
Nameplate	R99-11 Nameplate for MY
Socket Bridge	P2RM-SR (for AC), P2RM-SB (for DC)

Mounting Tracks

Applicable Socket	Description	Model
Track-connecting Socket	Mounting track	50 cm (ℓ) x 7.3 mm (t): PFP-50N 1 m (ℓ) x 7.3 mm (t): PFP-100N 1 m (ℓ) x 16 mm (t): PFP-100N2
	End plate	PFP-M
	Spacer	PFP-S
Back-connecting Socket	Mounting plate	P2R-P*

*Used to mount several P2R-05A and P2R-08A Connecting Sockets side by side.

Specifications

■ Coil Ratings

Rated voltage	Rated current*		Coil resistance*	Coil inductance (H) (ref. value)		Must operate voltage	Must release voltage	Max. voltage	Power consumption (approx.)	
	50 Hz	60 Hz		Armature OFF	Armature ON					
AC	24 V	43.5 mA	37.4 mA	253 Ω	0.81	1.55	80% max.	30% max.	110%	0.9 VA at 60 Hz
	110 V	9.5 mA	8.2 mA	5,566 Ω	13.33	26.83				
	120 V	8.6 mA	7.5 mA	7,286 Ω	16.13	32.46				
	230 V	4.4 mA	3.8 mA	27,172 Ω	72.68	143.90				
	240 V	3.7 mA	3.2 mA	30,360 Ω	90.58	182.34				

Rated voltage	Rated current*		Coil resistance*	Coil inductance (H) (ref. value)		Must operate voltage	Must release voltage	Max. voltage	Power consumption (approx.)
	50 Hz	60 Hz		Armature OFF	Armature ON				
DC	6 V	87.0 mA	69 Ω	0.25	0.48	70% max.	15% min.	110%	0.53 W
	12 V	43.2 mA	278 Ω	0.98	2.35				
	24 V	21.6 mA	1,113 Ω	3.60	8.25				
	48 V	11.4 mA	4,220 Ω	15.2	29.82				

* The rated current and coil resistance are measured at a coil temperature of 23°C with tolerances of ±10%.

■ Contact Ratings

Number of poles	1 pole		2 poles	
Load	Resistive load ($\cos\phi = 1$)	Inductive load ($\cos\phi = 0.4$; L/R = 7 ms)	Resistive load ($\cos\phi = 1$)	Inductive load ($\cos\phi = 0.4$; L/R = 7 ms)
Rated load	10 A at 250 VAC; 10 A at 30 VDC	7.5 A at 250 VAC; 5 A at 30 VDC	5 A at 250 VAC; 5 A at 30 VDC	2 A at 250 VAC; 3 A at 30 VDC
Rated carry current	10 A		5 A	
Max. switching voltage	440 VAC, 125 VDC		380 VAC, 125 VDC	
Max. switching current	10 A		5 A	
Max. switching power	2,500 VA, 300 W	1,875 VA, 150 W	1,250 VA, 150 W	500 VA, 90 W
Failure rate (reference value)	100 mA at 5 VDC		10 mA at 5 VDC	

Note: P level: $\lambda_{60} = 0.1 \times 10^{-6}$ /operation

■ Characteristics

Item	1 pole	2 poles
Contact resistance	100 mΩ max.	
Operate (set) time	15 ms max.	
Release (reset) time	AC: 10 ms max.; DC: 5 ms max. (w/built-in diode: 20 ms max.)	AC: 15 ms max.; DC: 10 ms max. (w/built-in diode: 20 ms max.)
Max. operating frequency	Mechanical: 18,000 operations/hr Electrical: 1,800 operations/hr (under rated load)	
Insulation resistance	1,000 MΩ min. (at 500 VDC)	
Dielectric strength	5,000 VAC, 50/60 Hz for 1 min between coil and contacts*; 1,000 VAC, 50/60 Hz for 1 min between contacts of same polarity	5,000 VAC, 50/60 Hz for 1 min between coil and contacts*; 3,000 VAC, 50/60 Hz for 1 min between contacts of different polarity 1,000 VAC, 50/60 Hz for 1 min between contacts of same polarity
Vibration resistance	Destruction: 10 to 55 to 10 Hz, 0.75 mm single amplitude (1.5 mm double amplitude) Malfunction: 10 to 55 to 10 Hz, 0.75 mm single amplitude (1.5 mm double amplitude)	
Shock resistance	Destruction: 1,000 m/s ² Malfunction: 200 m/s ² when energized; 100 m/s ² when not energized	
Endurance	Mechanical: AC coil: 10,000,000 operations min.; DC coil: 20,000,000 operations min. (at 18,000 operations/hr) Electrical: 100,000 operations min. (at 1,800 operations/hr under rated load) (DC coil type)	
Ambient temperature	Operating: -40°C to 70°C (with no icing or condensation)	
Ambient humidity	Operating: 5% to 85%	
Weight	Approx. 21 g	

Note: Values in the above table are the initial values.

*4,000 VAC, 50/60 Hz for 1 minute when the P2R-05A or P2R-08A Socket is mounted.

■ Approved Standards

UL 508 (File No. E41643)

Model	Contact form	Coil ratings	Contact ratings	Operations
G2R-1-S	SPDT	5 to 110 VDC 5 to 240 VAC	10 A, 30 VDC (resistive) 10 A, 250 VAC (general use) TV-3 (NO contact only)	6 x 10 ³
G2R-2-S	DPDT		5 A, 30 VDC (resistive) 5 A, 250 VAC (general use) TV-3 (NO contact only)	6 x 10 ³

CSA 22.2 No.0, No.14

(File No. LR31928)

Model	Contact form	Coil ratings	Contact ratings	Operations
G2R-1-S	SPDT	5 to 110 VDC 5 to 240 VAC	10 A, 30 VDC (resistive) 10 A, 250 VAC (general use) TV-3 (NO contact only)	6 x 10 ³
G2R-2-S	DPDT		5 A, 30 VDC (resistive) 5 A, 250 VAC (general use) TV-3 (NO contact only)	6 x 10 ³

IEC/VDE (EN61810)

Contact form	Coil ratings	Contact ratings	Operations
1 pole	6, 12, 24, 48 VDC 24, 110, 120, 230, 240 VAC	5 A, 440 VAC ($\cos\phi = 1.0$) 10 A, 250 VAC ($\cos\phi = 1.0$) 10 A, 30 VDC (0 ms)	100 x 10 ³
2 poles	6, 12, 24, 48 VDC 24, 110, 120, 230, 240 VAC	5 A, 250 VAC ($\cos\phi = 1.0$) 5 A, 30 VDC (0 ms)	100 x 10 ³

LR

Number of poles	Coil ratings	Contact ratings	Operations
1 pole	5 to 110 VDC 5 to 240 VDC	10 A, 250 VAC (general use) 7.5 A, 250 VAC (PF0.4) 10 A, 30 VDC (resistive) 5A, 30VDC (L/R=7ms)	100 x 10 ³
2 poles	5 to 110 VDC 5 to 240 VDC	5 A, 250 VAC (general use) 2 A, 250 VAC (PF0.4) 5 A, 30 VDC (resistive) 3A, 30VDC (L/R=7ms)	100 x 10 ³

Engineering Data

Maximum Switching Power

Plug-in Relays

G2R-1-S

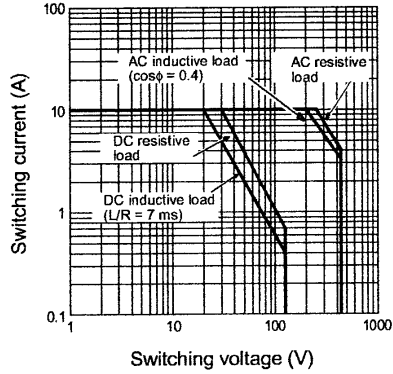

G2R-2-S

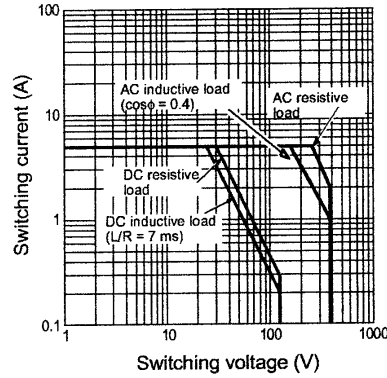

Endurance

Plug-in Relays

G2R-1-S

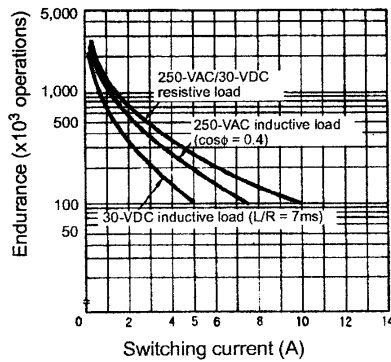

G2R-2-S

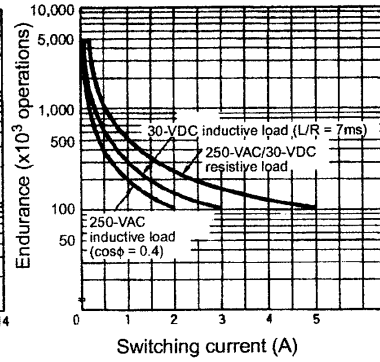

Ambient Temperature vs Maximum Coil Voltage

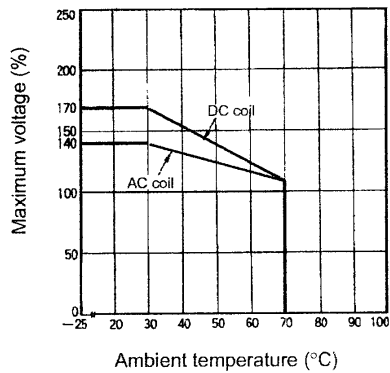

Note: The maximum voltage refers to the maximum value in a varying range of operating power voltage, not a continuous voltage.

Dimensions

Note: All units are in millimeters unless otherwise indicated.

Relays with Plug-in Terminals

SPDT Relays

G2R-1-S, G2R-1-SN, G2R-1-SNI
G2R-1-SD, G2R-1-SND, G2R-1-SNDI

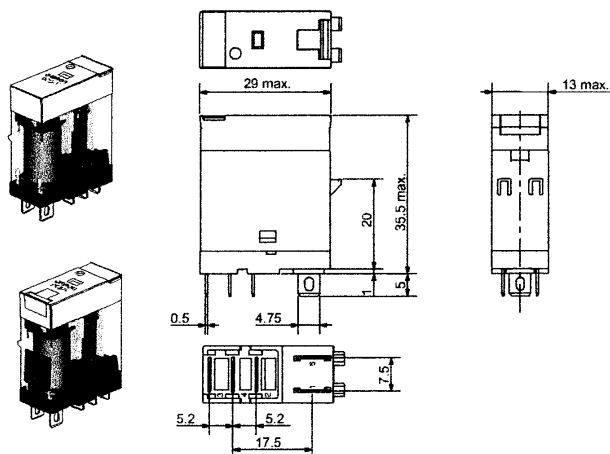

Terminal Arrangement/Internal Connections (Bottom View)

G2R-1-S

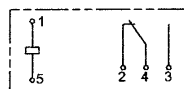

G2R-1-SD (DC)

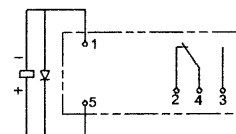

G2R-1-SN, G2R-1-SNI (AC)

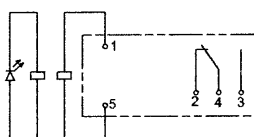

G2R-1-SN, G2R-1-SNI (DC)

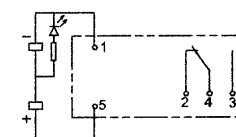

G2R-1-SND, G2R-1-SNDI (DC)

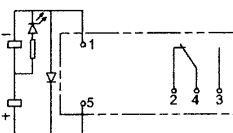

DPDT Relays

G2R-2-S, G2R-2-SN, G2R-2-SNI
G2R-2-SD, G2R-2-SND, G2R-2-SNDI

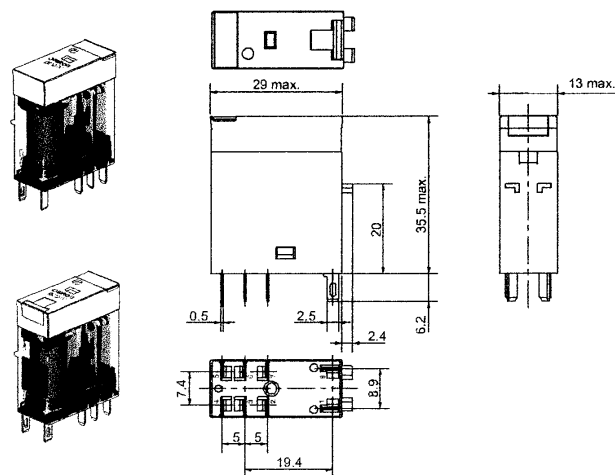

Terminal Arrangement/Internal Connections (Bottom View)

G2R-2-S

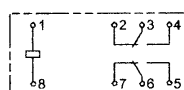

G2R-2-SD (DC)

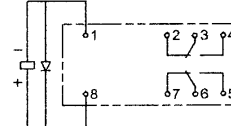

G2R-2-SN, G2R-2-SNI (AC)

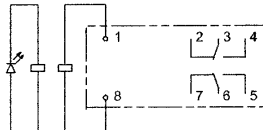

G2R-2-SN, G2R-2-SNI (DC)

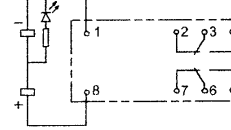

G2R-2-SND, G2R-2-SNDI (DC)

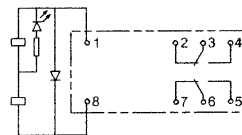

Track/Surface Mounting Sockets

P2RF-05-S

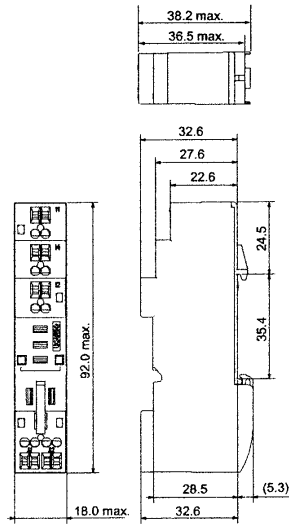
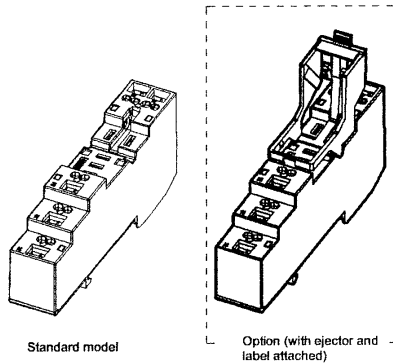

Terminal Arrangement (Top View)



P2RF-08-S

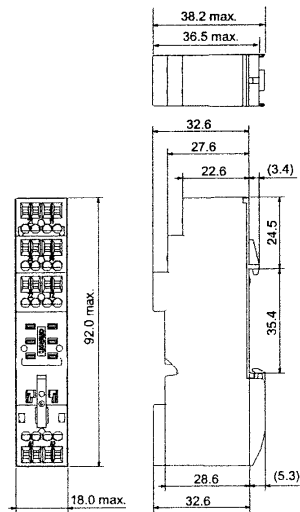
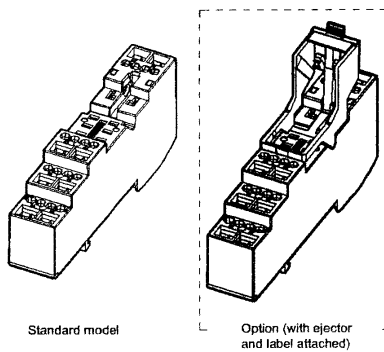

Terminal Arrangement (Top View)

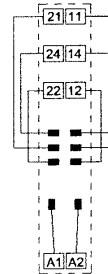

Accessories for P2RF-□-S

Socket Bridge

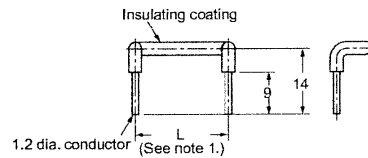

Clip and Release Lever

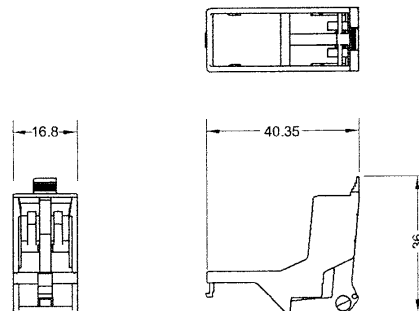

P2RF-05-E

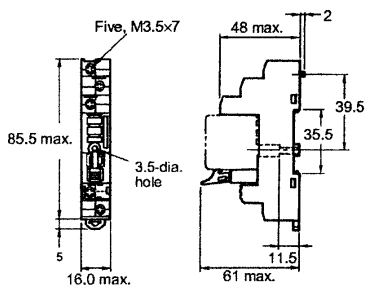
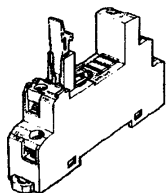

Terminal Arrangement (Top View)

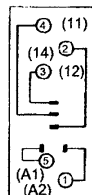

Mounting Holes (for Surface Mounting)

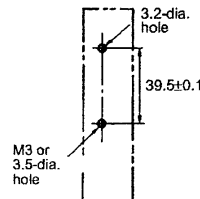

Note: Pin numbers in parentheses apply to DIN standard.

P2RF-08-E

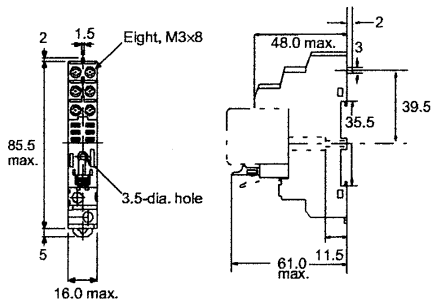
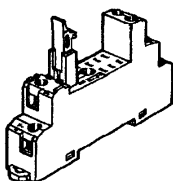

Terminal Arrangement (Top View)

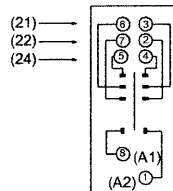

Mounting Holes (for Surface Mounting)

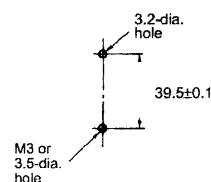

P2RF-05

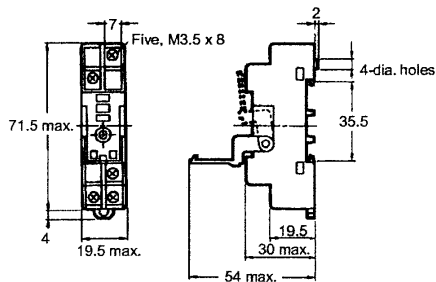

Terminal Arrangement (Top View)

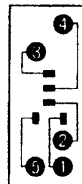

Mounting Holes (for Surface Mounting)

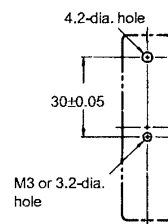

P2RF-08

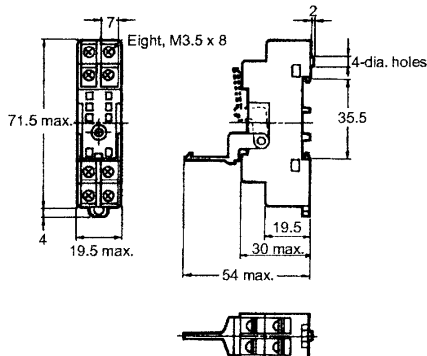
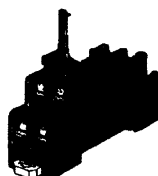

Terminal Arrangement (Top View)

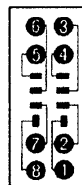

Mounting Holes (for Surface Mounting)

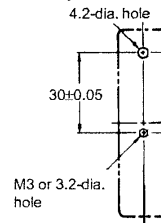

Mounting Height of Relay with Track/Surface Mounting Sockets

P2RF-□

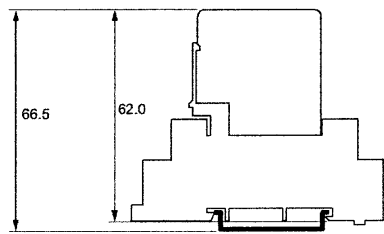

P2RF-□-E

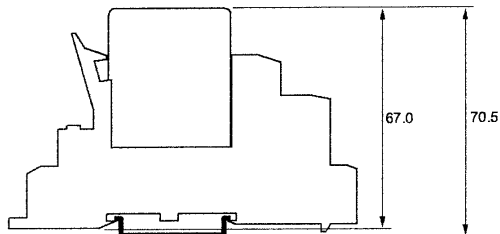

P2RF-□-S

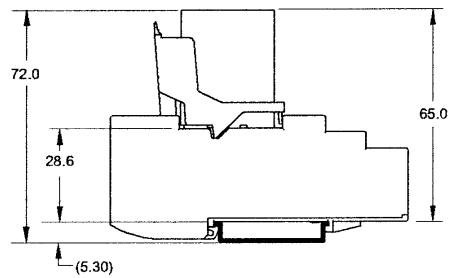

Back-connecting Sockets

P2R-05P (1-pole)

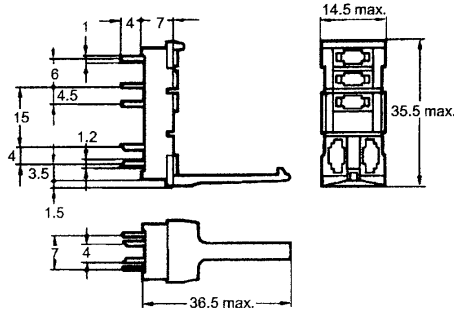
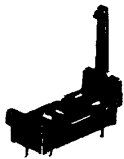

Terminal Arrangement (Bottom View)

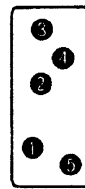

Mounting Holes

Tolerance: ± 0.1

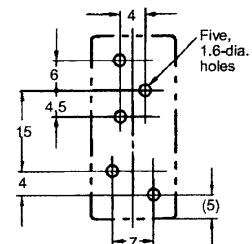

P2R-08P (2-pole)

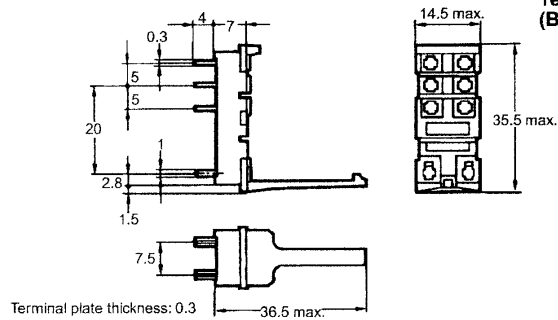
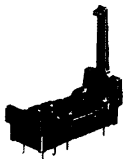

Terminal Arrangement (Bottom View)

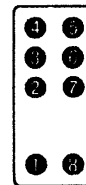

Mounting Holes

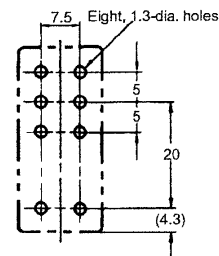

P2R-05A (1-pole)

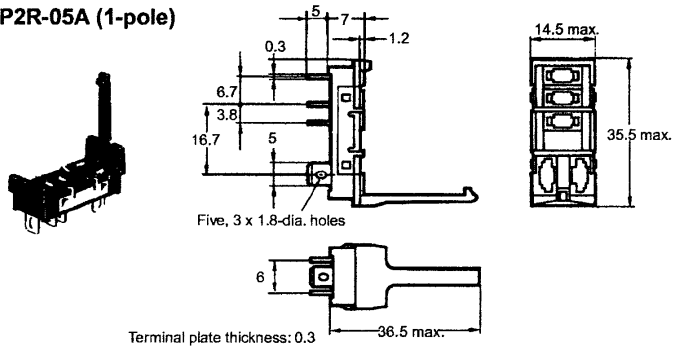

Terminal Arrangement (Bottom View)

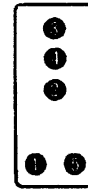

Panel Cutout

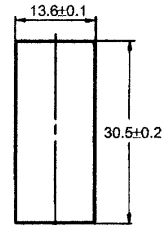

Recommended thickness of the panel is 1.6 to 2.0 mm

P2R-08A (2-pole)

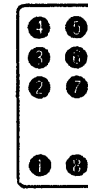
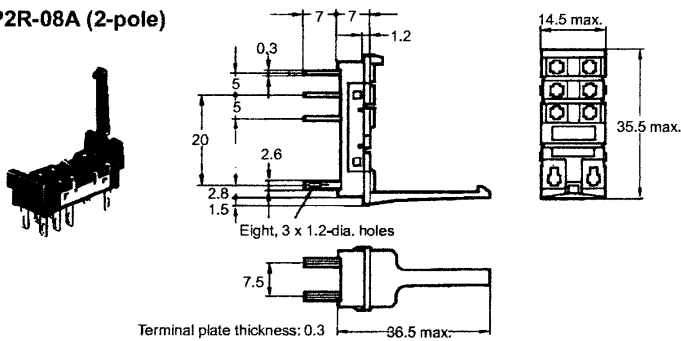

P2R-057P

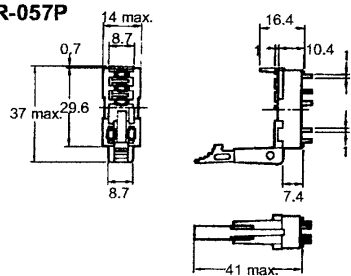

Terminal Arrangement (Bottom View)

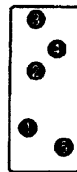

Mounting Holes

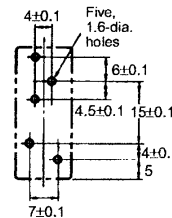

P2R-087P

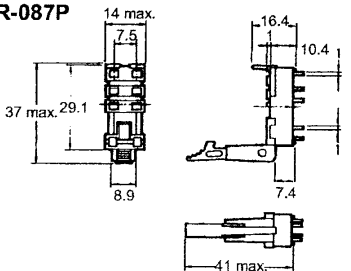

Terminal Arrangement (Bottom View)

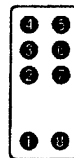

Mounting Holes

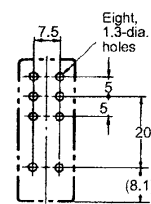

Mounting Height of Relay with Back-connecting Sockets

G2R-□P

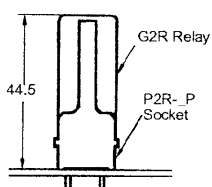

G2R-□A

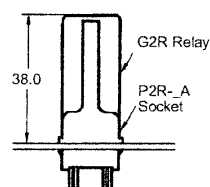

G2R-□7P

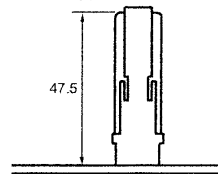

Mounting Tracks

PPF-100N, PPF-50N

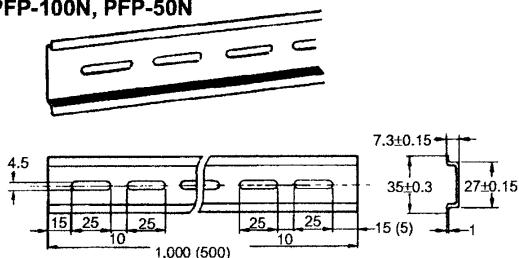

PPF-100N2

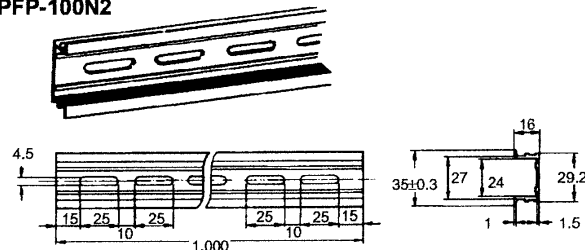

It is recommended to use a panel 1.6 to 2.0 mm thick.

End Plate

PPF-M

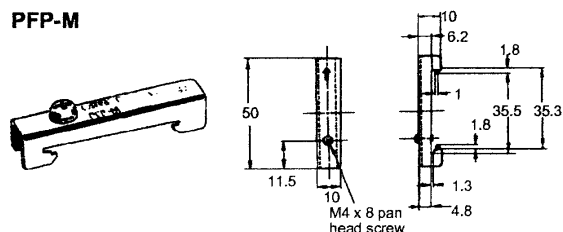

Spacer

PPF-S

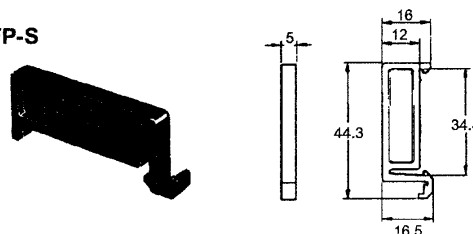

Precautions

- Caution**

Do not use the test button for any purpose other than testing. Be sure not to touch the test button accidentally as this will turn the contacts ON. Before using the test button, confirm that circuits, the load, and any other connected item will operate safely.
- Caution**

Check that the test button is released before turning ON relay circuits.
- Caution**

If the test button is pulled out too forcefully, it may bypass the momentary testing position and go straight into the locked position.
- Caution**

Use an insulated tool when you operate the test button.

Precautions for P2RF-□-S Connection

- Do not move the screwdriver up, down, or from side to side while it is inserted in the hole. Doing so may cause damage to internal components (e.g., deformation of the clamp spring or cracks in the housing) or cause deterioration of insulation.
- Do not insert the screwdriver at an angle. Doing so may break the side of the socket and result in a short-circuit.

ALL DIMENSIONS SHOWN ARE IN MILLIMETERS.
 To convert millimeters into inches, multiply by 0.03937. To convert grams into ounces, multiply by 0.03527.

Cat. No. J140-E1-01 In the interest of product improvement, specifications are subject to change without notice.

OMRON RELAY & DEVICES Corporation

GENERAL PURPOSE RELAY DIVISION
 1110, SUGI, YAMAGA-CITY KUMAMOTO-PREF., 861-0596 JAPAN
 Tel: (81)968-44-4149/Fax: (81)968-44-4107

Printed in Japan