







# Zelio Control measurement and control relays

## Selection guide

★ Available 2nd Quarter 2001

3

Applications	Current measurement $\overline{\text{---}}$ and $\sim$		Voltage measurement $\overline{\text{---}}$ and $\sim$		Control of single-phase supplies	Control of 3-phase supplies
	Overcurrent	Undercurrent or overcurrent	Overvoltage	Undervoltage or overvoltage	Undervoltage and overvoltage (2 controlled thresholds)	
						
Measurement or control	Adjustable threshold 0.003...1 A	Adjustable thresholds 0.003...1 A or 0.3...15 A depending on model	Adjustable thresholds 0.05...5 V or 1...100 V or 30...500 V depending on model		Adjustable thresholds undervoltage: 80...120 V or 160...220 V overvoltage: 160...220 V or 220...330 V depending model	Control: rotational direction and presence of phases 200...500 V
Supply voltage	$\sim$ 24 V $\sim$ 110...130 V $\sim$ 220...240 V	$\approx$ 24...240 V $\sim$ 110...130 V $\sim$ 220...240 V $\sim$ 380...415 V	$\sim$ 24 V $\sim$ 110...130 V $\sim$ 220...240 V	$\approx$ 24...240 V $\sim$ 110...130 V $\sim$ 220...240 V $\sim$ 380...415 V	Self-powered relays	
Number of output relay contacts	1 C/O	2 C/O	1 C/O	2 C/O		
Output relay state	Energised when threshold is exceeded				Energised during fault free operation. De-energised on detection of a fault.	
Built-in time delay	None	Adjustable 0.05 to 30 s	None	Adjustable 0.05 to 30 s		None
Type	RM4-JA0	RM4-JA3	RM4-UA0	RM4-UA3	RM4-UB3	RM4-TG20
Pages	3/35	3/35	3/41	3/41	3/52	3/48

★ Available 2nd Quarter 2001

Control of 3-phase supplies

Liquid level control



3

Control: rotational direction and presence of phases, undervoltage 200...500 V, adjustable threshold

Control: rotational direction and presence of phases, undervoltage, overvoltage 200...500 V, adjustable or fixed thresholds

Control: rotational direction and presence, of phases, asymmetry of phases 200...500 V.

Measurement of liquid resistance by submersible probes

Self-powered relays

~24V  
~110...130V  
~220...240V  
~380...415V

≈24...240V  
~110...130V  
~220...240V  
~380...415V

2 C/O

1 C/O

2 C/O

1 C/O

2 C/O

Energised during fault free operation. De-energised on detection of a fault.

Empty function:  
Energised: high electrode immersed.  
De-energised: low electrode not immersed.  
Fill function:  
Energised: low electrode not immersed.  
De-energised: high electrode immersed.

None

Adjustable  
0.1 to 10 s

Fixed 0.5 s

Adjustable  
0.1 to 10 s

None  
0.1 to 10 s

Adjustable

RM4-TU

RM4-TR

RM4-TA0

RM4-TA3

RM4-LG01

RM4-LA32

3/48

3/48

3/48

3/48

3/56

3/56

# Zelio Control - measurement and control relays

Current and voltage measurement relays :  
pages 3/32 to 3/43  
3-phase supply control relays :  
pages 3/44 to 3/49  
Single-phase supply control relays :  
pages 3/50 to 3/53  
Liquid level control relays :  
pages 3/54 to 3/57

## General characteristics

### Environment

<b>Conforming to standards</b>			IEC 60255-6, EN 60255-6
<b>Product approvals</b>			CSA, GL, UL, pending
<b>CE marking</b>			Zelio Control measurement relays conform to European regulations relating to CE marking
<b>Ambient air temperature around the device</b>	Storage	°C	- 40...+ 85
	Operation	°C	- 20...+ 65
<b>Permissible relative humidity range</b>	Conforming to IEC 60721-3-3		15...85 % Environmental class 3K3
<b>Vibration resistance</b>	Conforming to IEC 6068-2-6, 10 to 55 Hz		a = 0.35 ms
<b>Shock resistance</b>	Conforming to IEC 6068-2-27		15 gn - 11 ms
<b>Degree of protection</b>	Casing		IP 50
	Terminals		IP 20
<b>Degree of pollution</b>	Conforming to IEC 60664-1		3
<b>Overvoltage category</b>	Conforming to IEC 60664-1		III
<b>Rated insulation voltage</b>	Conforming to IEC	V	500
	Conforming to CSA	V	(1)
<b>Test voltage for insulation tests</b>	Dielectric test	kV	2.5
	Shock wave	kV	4.8
<b>Voltage limits</b>	Power supply circuit		0.85...1.1 U <sub>c</sub> (2)
<b>Frequency limits</b>	Power supply circuit		50/60 ± 5 %
<b>Disconnection value</b>	Power supply circuit		> 0.1 U <sub>c</sub> (2)
<b>Mounting position without derating</b>	In relation to normal vertical mounting plane		Any position
<b>Connection</b> Maximum c.s.a.	Flexible cable without cable end	mm <sup>2</sup>	2 x 2.5
	Flexible cable with cable end	mm <sup>2</sup>	2 x 1.5
<b>Tightening torque</b>		N.m	0.6...1.1

### Immunity to electromagnetic interference (EMC) (Application class 2 conforming to EN 61812-1)

<b>Electrostatic discharge</b>	Conforming to IEC 61000-4-2		Level 3 (6 kV contact, 8 kV air)
<b>Electromagnetic fields</b>	Conforming to IEC 61000-4-3		Level 3 (10 V/m)
<b>Fast transients</b>	Conforming to IEC 61000-4-4		Level 3 (2 kV)
<b>Shock waves</b>	Conforming to IEC 61000-4-5		Level 3 (2 kV)
<b>Radiated and conducted emissions</b>	CISPR11		Group 1 class A
	CISPR22		Class A

(1) Value not communicated.

(2) Except RM4-T, see page 3/47.

# Zelio Control - measurement and control relays

Current and voltage measurement relays :  
 pages 3/32 to 3/43  
 3-phase supply control relays :  
 pages 3/44 to 3/49  
 Single-phase supply control relays :  
 pages 3/50 to 3/53  
 Liquid level control relays :  
 pages 3/54 to 3/57

## General characteristics (continued)

### Output circuit characteristics

<b>Mechanical durability</b>	In millions of operating cycles		30		
<b>Current limit Ith</b>		<b>A</b>	8		
<b>Rated operational limits at 70 °C</b> Conforming to IEC 60947-5-1/1991 and VDE 0660	AC-15	<b>A</b>	24 V	115 V	250 V
	DC-13	<b>A</b>	3	3	3
<b>Minimum switching capacity</b>			2	0.3	0.1
<b>Switching voltage</b>	Rated	<b>V</b>	~ 250		
	Max	<b>V</b>	~ 440		
<b>Contact material</b>			Nickel Silver 90/10		

3

#### a.c. load

##### Curve 1

Electrical durability of the contacts on a resistive load in millions of operating cycles

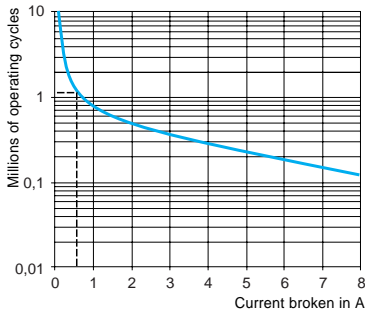

##### Curve 2

Reduction factor k for inductive loads (applies to values taken from the durability curve opposite)

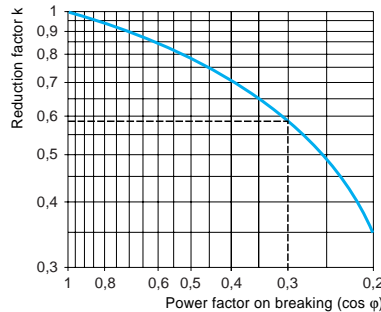

#### d.c. load

##### Load limit curve

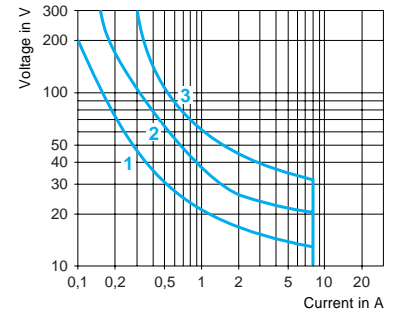

#### Example:

An LC1-F185 contactor supplied with 115 V/50 Hz for a consumption of 55 VA or a current consumption equal to 0.1 A and  $\cos \varphi = 0.3$

For 0.1 A, curve 1 indicates durability of approximately 1.5 million operating cycles.

As the load is inductive, it is necessary to apply a reduction coefficient k to this number of cycles, as indicated by curve 2.

For  $\cos \varphi = 0.3$  :  $k = 0.6$

The electrical durability therefore becomes:

$1.5 \cdot 10^6 \text{ operating cycles} \times 0.6 = 900\,000 \text{ operating cycles}$

- 1 L/R = 20 ms
- 2 L/R with load protection diode
- 3 Resistive load

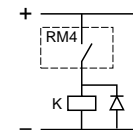

# Zelio Control - measurement and control relays

Characteristics :  
page 3/34  
References :  
page 3/35  
Dimensions, schemes :  
page 3/36  
Setting-up :  
page 3/37

## Current measurement relays RM4-JA

### Presentation



RM4-JA01



RM4-JA32

### Functions

These devices are designed to detect when a preset current threshold is exceeded, on a.c. or d.c. supply. They have a transparent, hinged flap on their front face to prevent any accidental alteration of the settings. This flap can be directly sealed.

Type of relay	Overcurrent control	Overcurrent or undercurrent control (1)	Measuring range
<b>RM4-JA01</b>	Yes	No	3 mA...1 A
<b>RM4-JA31</b>	Yes	Yes	3 mA...1 A
<b>RM4-JA32</b>	Yes	Yes	0.3 A...15 A

#### Applications:

- excitation control of d.c. machines,
- control of load state of motors and generators,
- control of current drawn by a 3-phase motor,
- monitoring of heating or lighting circuits,
- control of pump draining (undercurrent),
- control of overtorque (crushers).
- monitoring of electromagnetic brakes or clutches.

### Description

**RM4-JA01**  
Width 22.5 mm

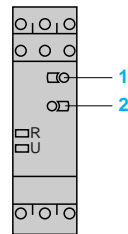

**RM4-JA31**  
Width 22.5 mm

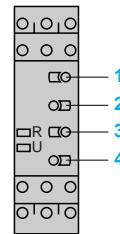

**RM4-JA32**  
Width 45 mm

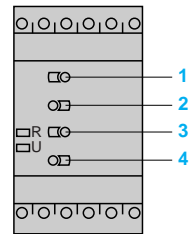

- 1 Adjustment of current threshold as % of setting range max. value.
- 2 Hysteresis adjustment from 5 to 30 % (2).
- 3 Fine adjustment of time delay as % of setting range max. value.
- 4 10-position switch combining:
  - selection of the timing range: 1 s, 3 s, 10 s, 30 s, no time delay.
  - selection of overcurrent (>) or undercurrent (<) detection.
 See table below.

**R** Yellow LED: indicates relay state.

**U** Green LED: indicates that supply to the RM4 is on.

#### Table showing details for switch 4

Switch position	Function	Time delay (t)
< 0	Undercurrent detection	No time delay
< 1	Undercurrent detection	0.05 to 1 s
< 3	Undercurrent detection	0.15 to 3 s
< 10	Undercurrent detection	0.5 to 10 s
< 30	Undercurrent detection	1.5 to 30 s
> 0	Overcurrent detection	No time delay
> 1	Overcurrent detection	0.05 to 1 s
> 3	Overcurrent detection	0.15 to 3 s
> 10	Overcurrent detection	0.5 to 10 s
> 30	Overcurrent detection	1.5 to 30 s

(1) Selection by switch on front face.

(2) Value of current difference between energisation and de-energisation of the output relay (% of the current threshold to be measured).

# Zelio Control - measurement and control relays

## Current measurement relays RM4-JA

References :  
page 3/35  
Dimensions, schemes :  
page 3/36  
Setting-up :  
page 3/37

### Presentation (continued)

### Operating principle

The supply voltage is connected to terminals A1-A2.  
The current to be monitored is connected to terminals B1, B2, B3 and C. See diagram below.

Hysteresis is adjustable between 5 and 30 %: for **overcurrent**  $h = (IS1 - IS2) / IS1$ , for **undercurrent**  $h = (IS2 - IS1) / IS1$ .  
A measuring cycle lasts only 80 ms, which allows rapid detection of changes in current.

#### Relay set for overcurrent detection (RM4-JA01 or selector on ">" for model RM4-JA3●).

If the current is greater than the setting threshold  $IS1$ , the output relay is energised with or without a time delay, depending on the model. When the current returns to a value  $IS2$  below the threshold, depending on the hysteresis setting, the relay is instantaneously de-energised.

#### Relay set for undercurrent detection (selector on "<," model RM4-JA3● only).

If the current is less than the threshold setting  $IS1$ , the output relay is energised with or without a time delay, depending on the model. When the current returns to a value  $IS2$  above the threshold, depending on the hysteresis setting, the relay is instantaneously de-energised.

#### Function diagrams:

##### Overcurrent detection

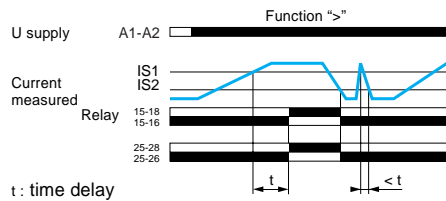

##### Undercurrent detection

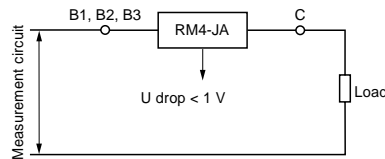
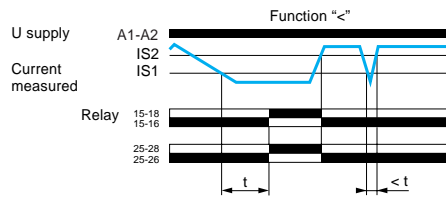

**Note:** The measurement ranges can be extended by means of a current transformer, the secondary of which is connected to the terminals of the corresponding RM4, or by means of a resistor connected in parallel with the measuring input (see example page 3/37 "Setting-up").

# Zelio Control - measurement and control relays

## Current measurement relays RM4-JA

### Characteristics

References :  
[page 3/35](#)  
 Dimensions, schemes :  
[page 3/36](#)  
 Setting-up :  
[page 3/37](#)

#### Power supply circuit characteristics

Type of relay			RM4-JA01			RM4-JA31 and RM4-JA32			
Rated supply voltage (Un)	~ 50/60 Hz	V	24	110...130	220...240	24...240	110...130	220...240	380...415
	≡	V	–	–	–	24...240	–	–	–
Average consumption at Un	~	VA	2	1.9...3.3	2.7...3.5	1.5...3.3	1.9...3.3	2.7...3.4	2.7...3
	≡	W	–	–	–	1.2	–	–	–

#### Output relay and operating characteristics

Type of relay		RM4-JA01	RM4-JA31 and RM4-JA32
Number of C/O contacts		1	2
Output relay state		Energised when: current measured > threshold setting	Energised when: current measured > threshold setting (" $>$ " function) current measured < threshold setting (" $<$ " function)
Setting accuracy of the switching threshold		As % of the full scale value: $\pm 5\%$	
Switching threshold drift	%	$\leq 0.06$ per degree centigrade, depending on the permissible ambient temperature	
	%	$\leq 0.5$ , within the supply voltage range (0.85...1.1 Un)	
Hysteresis (adjustable)	%	5...30 of the current threshold setting	
Setting accuracy of the time delay		As % of the full scale value: $\pm 10\%$	
Time delay drift	%	–	$\leq 0.07$ per degree centigrade, depending on temperature
			$\leq 0.5$ , within the supply voltage range (0.85...1.1 Un)
Measuring cycle	ms	$\leq 80$	

#### Measuring input characteristics

##### Internal input resistance and permissible overload depending on the current measurement ranges

Type of relay		RM4-JA01 and RM4-JA31			RM4-JA32		
Measurement range ~ 50-60 Hz and ≡		3...30 mA	10...100 mA	0.1...1 A	0.3...1.5 A	1...5 A	3...15 A
Internal input resistance Ri	$\Omega$	33	10	1	0.06	0.02	0.006
Permissible continuous overload	A	0.05	0.15	1.5	2	7	20
Permissible non repetitive overload for $t \leq 3$ s	A	0.2	0.5	5	10	15	100

# Zelio Control - measurement and control relays

## Current measurement relays RM4-JA

Presentation :  
pages 3/32 and 3/33  
Characteristics :  
page 3/34  
Setting-up :  
page 3/37

### References

★ Available 2nd  
Quarter 2001

### Current measurement relays: overcurrent detection

Time delay	Current to be measured depending on connection ~ or ≡	Width mm	Output relay	Basic reference. Complete with code indicating the voltage code (1)	Weight kg
None	3...30 mA 10...100 mA 0.1...1 A	22.5	1 C/O	<b>RM4-JA01●</b>	0.172



RM4-JA01

### Current measurement relays: overcurrent or undercurrent detection

Adjustable time delay s	Current to be measured depending on connection ~ or ≡	Width mm	Output relay	Basic reference. Complete with code indicating the voltage code (1)	Weight kg
0.05...30	3...30 mA 10...100 mA 0.1...1 A	22.5	2 C/O	<b>RM4-JA31●●</b>	0.172
	0.3...1.5 A 1...5 A 3...15 A	45	2 C/O	<b>RM4-JA32●●</b>	0.204



RM4-JA32

(1) Standard supply voltages

<b>RM4-JA01</b>	Volts	<b>24</b>	<b>110...130</b>	<b>220...240</b>	
	~ 50/60 Hz	B	F	M	
<b>RM4-JA31</b>	Volts	<b>24...240</b>	<b>110...130</b>	<b>220...240</b>	<b>380...415</b>
and <b>RM4-JA32</b>	~ 50/60 Hz	MW	F	M	Q
	≡	MW	-	-	-



# Zelio Control - measurement and control relays

## Current measurement relays RM4-JA

### Dimensions, schemes

Presentation :  
pages 3/32 and 3/33  
Characteristics :  
page 3/34  
Setting-up :  
page 3/37

### Dimensions

#### Dimensions

RM4-JA (common side view)

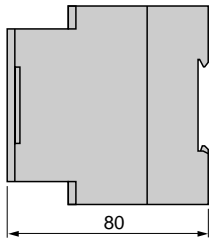

RM4-JA01

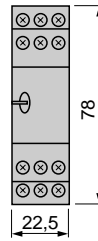

RM4-JA32

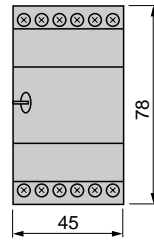

#### Rail mounting

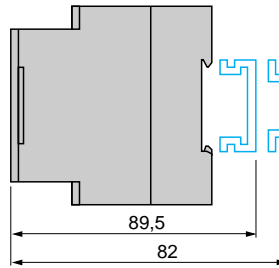

#### Screw fixing

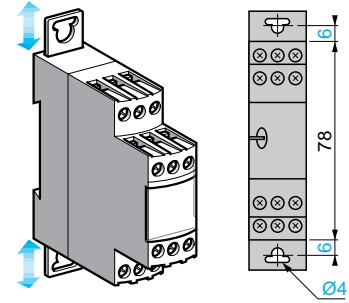

3

### Schemes, connection

#### Terminal blocks

RM4-JA01

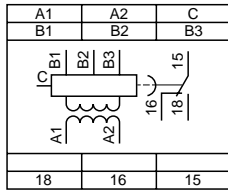

RM4-JA31

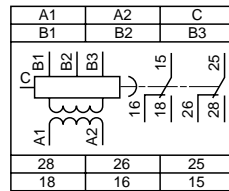

RM4-JA32

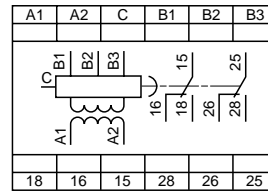

**A1-A2** Supply voltage

**B1, B2, B3, C** Currents to be measured (see table opposite)

Connection and current values to be measured, depending on type of **RM4-JA**

RM4-JA01 and RM4-JA31	B1-C	3...30 mA	RM4-JA32	B1-C	0.3...1.5 A
	B2-C	10...100 mA		B2-C	1...5 A
	B3-C	0.1...1 A		B3-C	3...15 A

#### Application schemes

Example: detection of blockage on a crusher (overcurrent function)  
Current measured  $\leq 15$  A

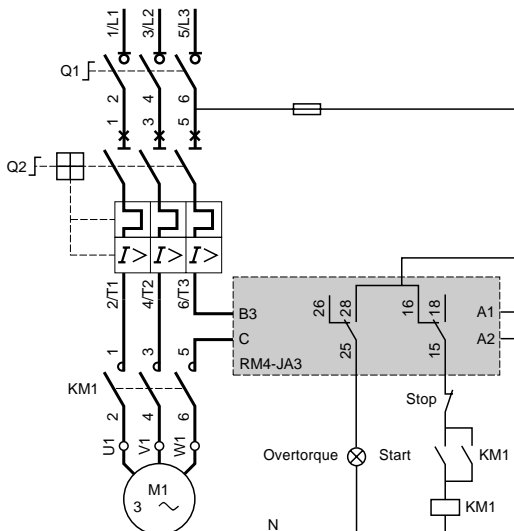

Current measured  $> 15$  A

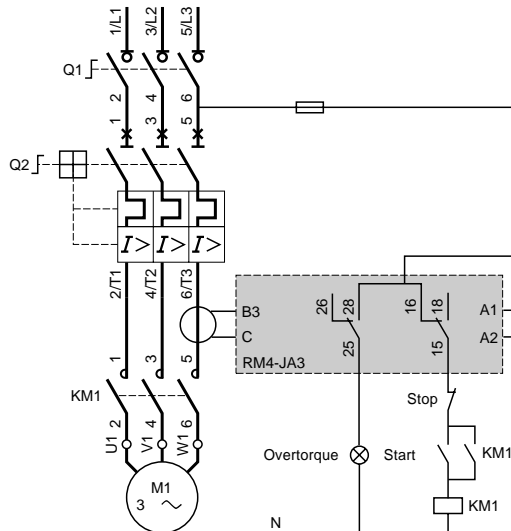

# Zelio Control - measurement and control relays

Presentation :  
pages 3/32 and 3/33  
Characteristics :  
page 3/34  
References :  
page 3/35  
Dimensions, schemes :  
page 3/36

## Current measurement relays RM4-JA

### Setting-up

#### Example of overcurrent to be measured

Overcurrent threshold at: 13 A.  
Output relay time delay: 5 s.  
Reset current threshold: 11 A.  
Supply voltage: 127 V  $\overline{\text{---}}$ .

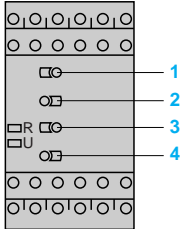

- Product selected **RM4-JA32MW**  
Connection of current to be measured B3-C (3 to 15 A)

3

#### Adjustments:

- Adjustment of function and timing range, switch **4** :
  - determine whether overcurrent or undercurrent detection is required; in this example, overcurrent.
  - determine the timing range, immediately greater than the time required; in this example, 10 s.
  - position switch **4** according to the above 2 criteria; in this example, switch **4** on **> 10**.
- Fine adjustment of time delay:  
Depending on the max. range setting displayed at **4** (in this example: 10 s) use potentiometer **3** to set the required time delay as a % of value **4**.  
In this example, the required time = 5 s therefore :

$$\frac{t \times 100}{4} = \frac{5 \times 100}{10} = 50\% \quad \text{Set the time delay potentiometer } 3 \text{ to } 50.$$

- Set the current threshold setting potentiometer **1** as a percentage of the maximum value of the measuring range selected when wiring.  
In this example: wiring B3-C, max. value of measuring range = 15 A, therefore:

$$\text{Setting } 1 = \frac{13 \times 100}{15} = 87\% \quad \text{Set the current threshold setting potentiometer } 1 \text{ to } 87.$$

- Set the hysteresis **2** as a % of the threshold value; in this example:

$$\text{Setting } 2 = \frac{13 - 11}{13} = 15.4\% \quad \text{Set the hysteresis } 2 \text{ to } 15 \text{ (} 13 - 11 = 2 \text{ i.e. } 15.4\% \text{ of the current to be measured).}$$

#### Extension of the measuring range

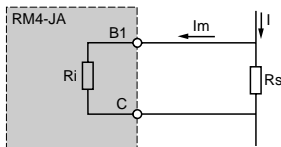

#### d.c. or a.c. supply

Simply connect a resistor "Rs" to terminals B1-C (or B2, B3-C) on the measuring input.  
The relay energisation threshold will be towards the middle of the setting potentiometer range if the value of Rs is in the region of:

$$R_s = \frac{R_i}{(2I/Im) - 1} \quad \text{where : } \begin{array}{l} R_i \text{ Internal resistance of input B1-C.} \\ I \text{ Maximum value of threshold setting range.} \\ I \text{ Current threshold to be measured.} \end{array}$$

$$\text{Power dissipated by } R_s: P = R_s (I - Im/2)^2$$

#### Application:

Use of relay **RM4-JA31** (10 to 100 mA).  
Connection B2-C to measure a threshold of 1 A, knowing that Ri = 10  $\Omega$  for this rating and that Im = 100 mA

$$\text{The value of } R_s \text{ will be: } \frac{10}{(2 \times 1/0.1) - 1} = 0.526 \Omega$$

$$P = (1 - \frac{0.1}{2})^2 \times 0.526 \text{ i.e. } 0.47 \text{ W}$$

Select a resistor Rs capable of dissipating at least twice the calculated value, i.e. 1 W for this example, in order to limit temperature rise.

On an a.c. supply, it is also possible to use a current transformer.

# Zelio Control - measurement and control relays

Characteristics:  
page 3/40  
References:  
page 3/41  
Dimensions, schemes:  
page 3/42  
Setting-up:  
page 3/43

## Voltage measurement relays RM4-UA

### Presentation



RM4-UA01

3

### Functions

These devices are designed to detect when a preset voltage threshold is exceeded, on a.c. or d.c. supply. They have a transparent, hinged flap on their front face to prevent any accidental alteration of the settings. This flap can be directly sealed.

Type of relay	Overvoltage control	Overvoltage or undervoltage control (1)	Measuring range
<b>RM4-UA0●</b>	Yes	No	50 mV...500 V
<b>RM4-UA3●</b>	Yes	Yes	50 mV...500 V

### Applications:

- d.c. motor overspeed control,
- battery monitoring,
- monitoring of a.c. or d.c. supplies,
- speed monitoring (with tacho-generator).

### Presentation

**RM4-UA0●**  
Width 22.5 mm

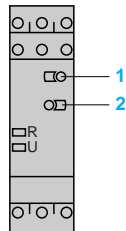

**RM4-UA3●**  
Width 22.5 mm

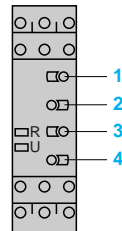

- 1 Adjustment of voltage threshold as % of setting range max. value.
- 2 Hysteresis adjustment from 5 to 30 % (2).
- 3 Adjustment of time delay as % of setting range max. value.
- 4 Switch combining:
  - selection of the timing range: 1s, 3s, 10s, 30s, no time delay,
  - selection of overvoltage (>) or undervoltage (<) detection.
 See table below.

R Yellow LED: indicates relay state.

U Green LED: indicates that supply to the RM4 is on.

Table showing details for switch 4

Switch position	Function	Time delay (t)
< 0	Undervoltage detection	No time delay
< 1	Undervoltage detection	0.05 to 1 s
< 3	Undervoltage detection	0.15 to 3 s
< 10	Undervoltage detection	0.5 to 10 s
< 30	Undervoltage detection	1.5 to 30 s
> 0	Overvoltage detection	No time delay
> 1	Overvoltage detection	0.05 to 1 s
> 3	Overvoltage detection	0.15 to 3 s
> 10	Overvoltage detection	0.5 to 10 s
> 30	Overvoltage detection	1.5 to 30 s

(1) Selection by switch on front face.

(2) Value of voltage difference between energisation and de-energisation of the output relay (% of the voltage threshold to be measured).

# Zelio Control - measurement and control relays

Characteristics:  
page 3/40  
References:  
page 3/41  
Dimensions, schemes:  
page 3/42  
Setting-up:  
page 3/43

## Voltage measurement relays RM4-UA

### Presentation (continued)

### Operating principle

The supply voltage is connected to terminals A1-A2.  
The voltage to be monitored is connected to terminals B1, B2 or B3 and C.

Hysteresis is adjustable between 5 and 30 %:  
**for overvoltage**  $h = (US1 - US2) / US1$ , **for undervoltage**  $h = (US2 - US1) / US1$ .  
A measurement cycle lasts only 80 ms, which allows rapid detection of changes in voltage.

**Relays set for overvoltage detection** (RM4-UA0● or selector on ">" for model RM4-UA3●):  
If the voltage is greater than the threshold setting US1, the output relay is energised, with or without a time delay. When the voltage returns to a value US2 below the threshold, depending on the hysteresis setting, the relay is instantaneously de-energised.

**Relays set for undervoltage detection** (selector on "<", model RM4-UA3● only):  
If the voltage is less than the threshold setting US1, the output relay is energised, with or without a time delay. When the voltage returns to a value US2 above the threshold, depending on the hysteresis setting, the relay is de-energised.

3

### Function diagrams

#### Overvoltage control

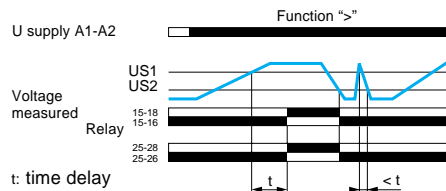

#### Undervoltage control

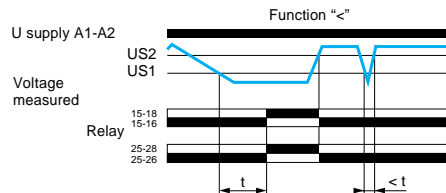

**Note:** the measurement ranges can be extended above 500 V by adding a resistor, see page 3/43.  
The measurement range on  $\sim$  supply can be extended by means of a voltage transformer, the secondary of which is connected to the measuring terminals of the corresponding RM4 .

# Zelio Control - measurement and control relays

Presentation:  
pages 3/38 and 3/39  
References:  
page 3/41  
Dimensions, schemes:  
page 3/42  
Setting-up:  
page 3/43

## Voltage measurement relays RM4-UA

### Characteristics

#### Power supply circuit characteristics

Type of relay			RM4-UA0●			RM4-UA3●			
Rated supply voltage (Un)	~ 50/60 Hz	V	24	110...130	220...240	24...240	110...130	220...240	380...415
	≡	V	–	–	–	24...240	–	–	–
Average consumption at Un	~	VA	2	1.9...3.3	2.7...3.5	1.5...3.3	1.9...3.3	2.7...3.4	2.7...3
	≡	W	–	–	–	1.2	–	–	–

#### Output relay and operating characteristics

Type of relay		RM4-UA0●	RM4-UA3●
Number of C/O contacts		1	2
Output relay state		Energised when: voltage measured > threshold setting	Energised when: voltage measured > threshold setting (">" function ) voltage measured < threshold setting ("<" function)
Setting accuracy of the switching threshold		As % of the full scale value: ± 5 %	
Switching threshold drift	%	≤ 0.06 per degree centigrade, depending on the permissible ambient temperature	
	%	≤ 0.5, within the supply voltage range (0.85...1.1 Un)	
Hysteresis (adjustable)	%	5...30 of the voltage threshold setting	
Setting accuracy of the time delay		As % of the full scale value: ± 10 %	
Time delay drift	%	–	≤ 0.5, within the supply voltage range (0.85...1.1 Un)
			≤ 0.07 per degree centigrade, depending on the rated operating temperature
Measuring cycle	ms	≤ 80	

#### Measuring input characteristics

##### Internal input resistance and permissible overload depending on the current measurement ranges

Type of relay		RM4-UA●1			RM4-UA●2			RM4-UA●3	
Measurement range ~ 50-60 Hz and ≡	V	0.05...0.5	0.3...3	0.5...5	1...10	5...50	10...100	30...300	50...500
Internal input resistance Ri	kΩ	6.6	43	71	23	112	225	668	1111
Permissible continuous overload	V	20	60	80	90	150	300	400	550
Permissible non repetitive overload for t ≤ 1 s	V	25	80	100	100	200	400	500	550

# Zelio Control - measurement and control relays

Presentation:  
pages 3/38 and 3/39  
Characteristics:  
page 3/40  
Dimensions, schemes:  
page 3/42  
Setting-up:  
page 3/43

## Voltage measurement relays RM4-UA

### References

★ Available 2nd  
Quarter 2001



RM4-UA01

### Voltage measurement relays: overvoltage detection

Time delay	Voltage to be measured depending on connection ~ or --- <b>V</b>	Width <b>mm</b>	Output relay	Basic reference. Complete with code indicating the voltage code (1)	Weight <b>kg</b>
None	0.05...0.5 0.3...3 0.5...5	22.5	1 C/O	<b>RM4-UA01●</b>	0.168
	1...10 5...50 10...100	22.5	1 C/O	<b>RM4-UA02●</b>	0.168
	30...300 50...500	22.5	1 C/O	<b>RM4-UA03●</b>	0.168

### Voltage measurement relays: overvoltage or undervoltage detection

Adjustable time delay <b>s</b>	Voltage to be measured depending on connection ~ or --- <b>V</b>	Width <b>mm</b>	Output relay	Basic reference. Complete with code indicating the voltage code (1)	Weight <b>kg</b>
0.05...30	0.05...0.5 0.3...3 0.5...5	22.5	2 C/O	<b>RM4-UA31●●</b>	0.168
	1...10 5...50 10...100	22.5	2 C/O	<b>RM4-UA32●●</b>	0.168
	30...300 50...500	22.5	2 C/O	<b>RM4-UA33●●</b>	0.168

(1) Standard supply voltages

<b>RM4-UA0●</b>	Volts	<b>24</b>	<b>110...130</b>	<b>220...240</b>	
	~ 50/60 Hz	B	F	M	
<b>RM4-JA3●</b>	Volts	<b>24...240</b>	<b>110...130</b>	<b>220...240</b>	<b>380...415</b>
	~ 50/60 Hz	MW	F	M	Q
	---	MW	-	-	-

# Zelio Control - measurement and control relays

Presentation:  
pages 3/38 and 3/39  
Characteristics:  
page 3/40  
References:  
page 3/41  
Setting-up:  
page 3/43

Voltage measurement relays RM4-UA

Dimensions, schemes

## Dimensions

Dimensions  
RM4-UA

Rail mounting

Screw fixing

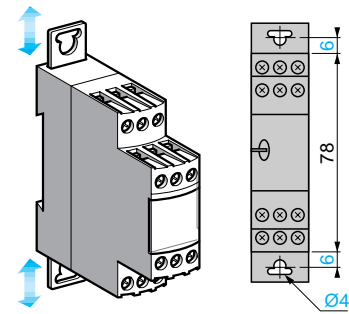
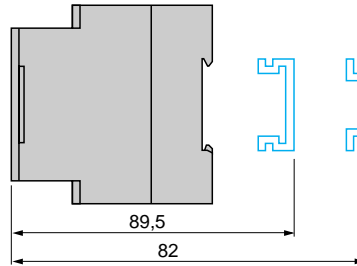
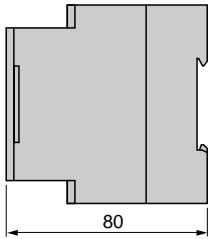

3

## Schemes, connection

Terminal blocks  
RM4-UA01, UA02

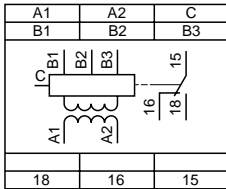

RM4-UA03

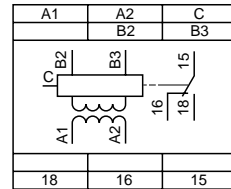

RM4-UA31, UA32

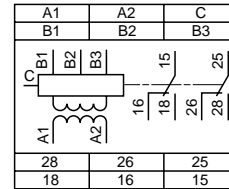

RM4-UA33

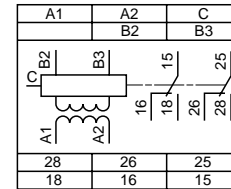

A1-A2 Supply voltage

B1, B2. Voltages to be measured  
B3, C (see table opposite)

Connection and voltage values to be measured, depending on type of RM4-UA

RM4-UA●1	B1-C	0.05...0.5 V
	B2-C	0.3...3 V
	B3-C	0.5...5 V

RM4-UA●2	B1-C	1...10 V
	B2-C	5...50 V
	B3-C	10...100 V

RM4-UA●3	B2-C	30...300 V
	B3-C	50...500 V

## Application scheme

Example: overspeed monitoring (undervoltage function)

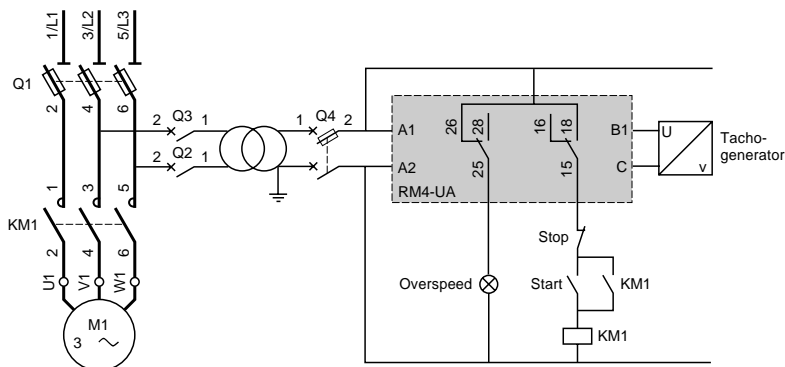

# Zelio Control - measurement and control relays

Presentation:  
pages 3/38 and 3/39  
Characteristics:  
page 3/40  
References:  
page 3/41  
Dimensions, schemes:  
page 3/42

## Voltage measurement relays RM4-UA

### Setting-up

#### Example of undervoltage to be measured

Undervoltage threshold to be measured: 12 V ---  
Time delay of the output relay: 20 s.  
Reset voltage threshold: 13.2 V.  
Supply voltage: 230 V ~ 60 Hz.

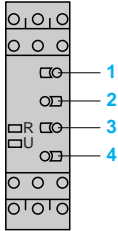

- Product selected **RM4-UA32M**  
Connection of voltage to be measured B2-C (5 to 50 V)

#### Adjustments:

- Adjustment of function and timing range, switch **4**:
  - determine the timing range, immediately greater than the time required, in this example 30 s.
  - determine whether overvoltage or undervoltage detection is required, in this example undervoltage.
  - position switch **4** according to the above 2 criteria, in this example, switch **4** on **< 30**.
- Fine adjustment of time delay:  
Depending on the max. range setting displayed at **4** (in this example: 30 s) use potentiometer **3** to set the required time delay as a % of value **4**.  
In this example, the required time = 20 s therefore:

$$t \times 100 = \frac{20 \times 100}{30} = 66 \% \quad \text{Set the time delay potentiometer } \mathbf{3} \text{ to } \mathbf{66}.$$

- Set the voltage threshold setting potentiometer **1** as a percentage of the maximum value of the measuring range selected when wiring.  
In this example: wiring B2-C, max. value of measuring range = 50 V, therefore:

$$\text{Setting } \mathbf{1} = \frac{12 \times 100}{50} = 24 \% \quad \text{Set the voltage threshold setting potentiometer } \mathbf{1} \text{ to } \mathbf{24}.$$

- Set the hysteresis **2** as a % of the threshold value; in this example:

$$\text{Setting } \mathbf{2} = \frac{13.2 - 12}{12} = 10 \% \quad \text{Set the hysteresis } \mathbf{2} \text{ to } \mathbf{10}.$$

#### Extension of the measuring range

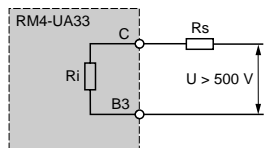

#### d.c. or a.c. supply

Simply connect an additional resistor (Rs) in series with the measuring input B3 or C.  
If the value of Rs is in the region of:

$$R_s = R_i \left( \frac{U}{U_m} - 1 \right) \text{ where: } \begin{array}{l} R_i \text{ Internal resistance of input B3-C.} \\ U_m \text{ Maximum value of threshold setting range.} \\ U \text{ Voltage threshold to be measured.} \end{array}$$

The tripping threshold of the relay will be towards the maximum graduation on the threshold setting potentiometer.  
In general, the power consumed by the resistor does not exceed 0.5 W.

For a.c. voltages, it is also possible to use a voltage transformer.

#### Supply by the measured voltage

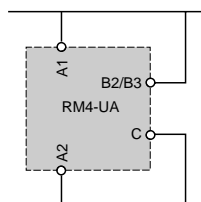

For monitoring mains and power supplies, the RM4-UA can be supplied by the voltage to be controlled, provided that:

- the measurement threshold is within the operating range of the product's power supply (0.85...1.1 Uc).
- variations of the voltage to be measured are compatible with the supply and measurement voltage ranges.



# Zelio Control - measurement and control relays

## 3-phase supply control relays RM4-T

Characteristics :  
page 3/47  
References :  
page 3/48  
Dimensions, schemes :  
page 3/49

### Presentation



RM4-T

3

### Functions

These devices are designed to monitor 3-phase supplies and to protect motors and other loads against the faults listed in the table below. They have a transparent, hinged flap on their front face to prevent any accidental alteration of the settings. This flap can be directly sealed.

	RM4-TG	RM4-TU	RM4-TR	RM4-TA
Monitoring of rotational direction of phases				
Detection of complete failure of one or more of the phases				
Undervoltage detection				
Overvoltage and undervoltage detection (2 thresholds)				
Detection of phase asymmetry (imbalance)				

■ Function performed  
■ Function not performed

### Applications

- Control for connection of moving equipment (site equipment, agricultural equipment, refrigerated trucks).
- Control for protection of persons and equipment against the consequences of reverse running (lifting, handling, elevators, escalators, etc.).
- Control of sensitive 3-phase supplies.
- Protection against the risk of a driving load (phase failure).
- Normal/emergency power supply switching.

### Presentation

#### RM4-TG

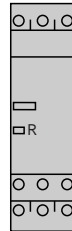

R Yellow LED: indicates relay output state.

#### RM4-TU

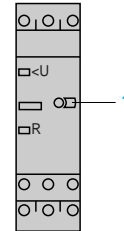

R Yellow LED: indicates relay output state.  
< U Red LED: undervoltage fault.  
1 Undervoltage setting potentiometer.

#### RM4-TR31. RM4-TR32



#### RM4-TR33. RM4-TR34

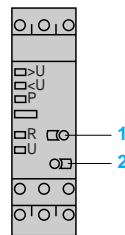

- 1 Time delay function selector:  
 Fault detection delayed.  
 Fault detection extended.
- 2 Potentiometer for setting time delay in seconds.
- 3 Potentiometer for setting overvoltage as a direct value.
- 4 Potentiometer for setting undervoltage as a direct value.
- R Yellow LED: indicates relay state.  
 U Green LED: indicates that supply to the RM4 is on.  
 > U Red LED: overvoltage fault  
 < U Red LED: undervoltage fault  
 P Red LED: phase failure or incorrect rotational direction of phases.

#### RM4-TA3

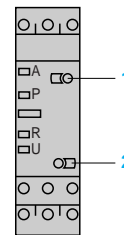

#### RM4-TA0

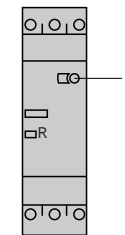

- 1 Asymmetry threshold setting potentiometer, from 5 to 15 %
- 2 Potentiometer for setting time delay, 0.1 to 10 s.
- R Yellow LED: indicates relay state.  
 U Green LED: indicates that supply to the RM4 is on.  
 A Red LED: phase asymmetry.  
 P Red LED: phase failure or incorrect rotational direction of phases.

# Zelio Control - measurement and control relays

## 3-phase supply control relays RM4-T



Characteristics :  
 page 3/47  
 References :  
 page 3/48  
 Dimensions, schemes :  
 page 3/49

### Presentation (continued)

### Operating principle

The supply voltage to be monitored is connected to terminals L1, L2, L3 of the product.

There is no need to provide a separate power supply for RM4-T relays; they are self-powered by terminals L1, L2, L3.

- Monitoring rotational direction of phases and detection of complete failure of one or more of the phases (RM4-T all models)**  
 When terminals L1, L2, L3 are energised, the relay is energised and the yellow LED comes on if the rotational direction of phases is correct and if all 3 phases are present.  
 If one or more of the phases have failed or if the rotational direction is incorrect, the relay is not energised at switch-on. In normal operation (no fault) the relay is energised; it de-energises instantaneously in the event of failure of one or more of the phases (any time delay set is not active on these faults).  
 In the event of failure or absence of a single phase, a voltage greater than the detection threshold ( $\approx 130$  V on RM4-TG, undervoltage threshold setting on RM4-TU and RM4-TR) can be generated back through the control circuit, thus preventing detection of the phase failure. In this case, we recommend the use of RM4-TA relays.  
 The absence of a phase is signalled, on RM4-TR and RM4-TA, by illumination of led "P".
- Oversvoltage and undervoltage detection (RM4-TR):**  
 In normal operation, the relay is energised and LEDs "U" and "R" are illuminated.  
 If the average of the 3 voltages between phases goes outside the range to be monitored, the output relay is de-energised:
  - **oversvoltage:** the Red LED "> U" illuminates.
  - **undervoltage:** the Red LED "< U" illuminates.
 When the supply returns towards its rated value, the relay is re-energised according to the hysteresis value (5%) and the corresponding red LED goes out.  
 A selector switch allows selection of an adjustable time delay from 0.1 s to 10 s. With function  transient "over" or "under" voltages are not taken into account. With function  all variations above or below are taken into account and re-energisation of the relay is delayed.  
 In all cases, in order to be detected, the duration of the oversvoltage or undervoltage must be greater than the measuring cycle time (80 ms).

3

#### Function diagram (RM4-TR31, RM4-TR32)

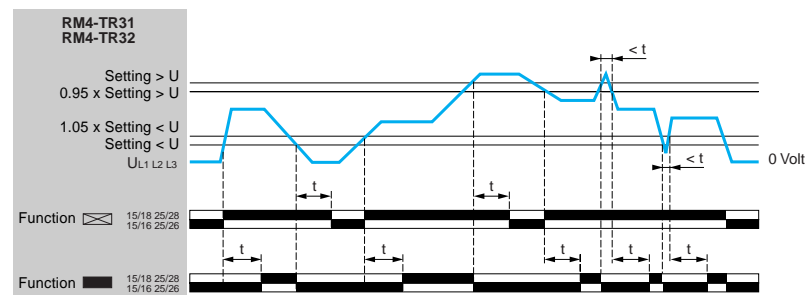

#### Function diagram (RM4-TR33, RM4-TR34)

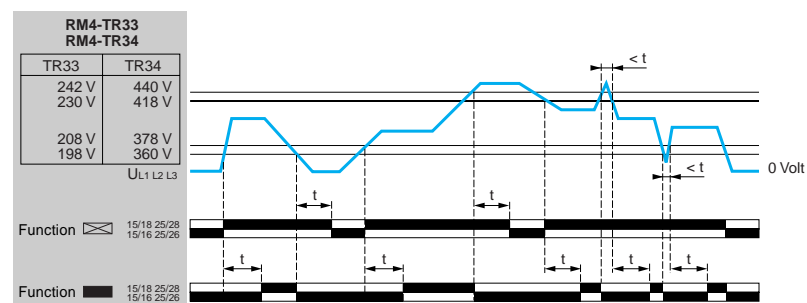

# Zelio Control - measurement and control relays

## 3-phase supply control relays RM4-T

Characteristics :  
page 3/47  
References :  
page 3/48  
Dimensions, schemes :  
page 3/49

### Presentation (continued)

### Operating principle (continued)

#### ● Undervoltage detection only (RM4-TU)

In normal operation, the output relay is energised and the yellow LED is illuminated.  
If the average of the 3 voltages between phases is less than the undervoltage threshold setting, the relay is de-energised after 550 ms and the red LED "< U" illuminates.

#### Function diagram

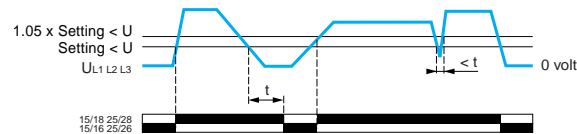

t: fixed time delay = 550 ms

#### ● Detection of phase asymmetry (RM4-TA)

In normal operation, the output relay is energised and the yellow and green LEDs are illuminated.  
In the event of an asymmetry fault, after a time delay set between 0.1 s and 10 s (on RM4-TA3 only), the output relay is de-energised, the yellow LED goes out and red LED "A" illuminates (RM4-TA3 only).  
The relay re-energises when the asymmetry value measured is less than half of the asymmetry value setting (hysteresis).

#### Function diagram

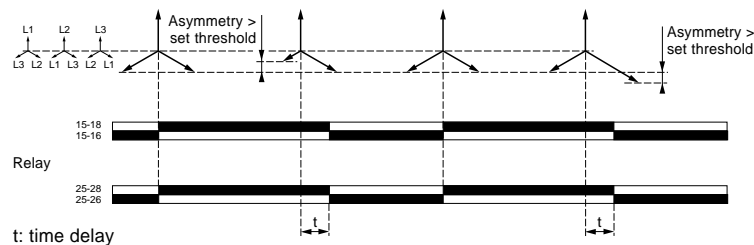

**Example:** asymmetry set at 10 %, mains supply voltage 400 V

- relay de-energisation threshold:  $400 - 10 \% = 360 \text{ V}$ .

- relay re-energisation threshold:  $400 \text{ V} - \frac{10 \%}{2} = 380 \text{ V}$ .

# Zelio Control - measurement and control relays

## 3-phase supply control relays RM4-T

Presentation :  
pages 3/44 to 3/46  
References :  
page 3/48  
Dimensions, schemes :  
page 3/49

### Characteristics

Type of relay			RM4-TG	RM4-TU	RM4-TR	RM4-TA
<b>Output relay and operating characteristics</b>						
Number of C/O contacts			2	2	2	<b>RM4-TA3</b> : 2 <b>RM4-TA0</b> : 1
Output relay state			Energised during fault free operation. De-energised or unable to energise on detection of rotational direction fault or failure of one or more phases	Energised during fault free operation. De-energised on detection of undervoltage or rotational direction fault or failure of one or more phases	Energised during fault free operation. De-energised on detection of overvoltage, undervoltage or rotational direction fault or phase failure	Energised during fault free operation. De-energised on detection of asymmetry fault, phase failure or rotational direction fault
Accuracy of switching threshold setting	As % of the set value		–	± 3 %	± 3 %	± 3 %
Switching threshold drift	Depending on the permissible ambient temperature		–	≤ 0.06 % per degree centigrade	≤ 0.06 % per degree centigrade	≤ 0.06 % per degree centigrade
	Within the measuring range		–	≤ 0.5 %	≤ 0.5 %	≤ 0.5 %
Accuracy of time delay setting	As % of the full scale value		–	± 10 %	± 10 %	± 10 %
Time delay drift	Within the measuring range		–	≤ 0.5 %	≤ 0.5 %	≤ 0.5 %
	Depending on the rated operational temperature		–	≤ 0.07 % per degree centigrade	≤ 0.07 % per degree centigrade	≤ 0.07 % per degree centigrade
Hysteresis	Fixed		–	About 5 % of the de-energisation threshold	About 5 % of the de-energisation threshold	About 50 % of the asymmetry percentage
Measuring cycle		ms	≤ 80	≤ 80	≤ 80	≤ 80

### Measuring input characteristics

Minimum operational voltage (1)	L1 L2 or L2 L3 or L1 L3	V	140	RM4-TU01: 160 RM4-TU02: 290	RM4-TR31, RM4-TR33: 160 RM4-TR32, RM4-TR34: 290	RM4-TA01, RM4-TA31: 160 RM4-TA02, RM4-TA32: 290
Maximum permissible voltage between phases	L1 L2 L3	V	580	RM4-TU01: 300 RM4-TU02: 580	RM4-TR31, RM4-TR33: 300 RM4-TR32, RM4-TR34: 580	RM4-TA01, RM4-TA31: 300 RM4-TA02, RM4-TA32: 580

(1) Minimum voltage required for operation of indicators and of the time delay.

# Zelio Control - measurement and control relays

## 3-phase supply control relays RM4-T

Presentation :  
pages 3/44 to 3/46  
Characteristics :  
page 3/47  
Dimensions, schemes :  
page 3/49

### References



RM4-TG20

### Control relays: rotational direction and presence of phases

Time delay	Rated mains supply voltage (1)	Width	Output relay	Reference	Weight
s	V	mm			kg
None	200...500 50/60 Hz	22.5	2 C/O	<b>RM4-TG20</b>	0.110

### Control relays: rotational direction and presence of phases + undervoltage

Time delay	Rated mains supply voltage (1)	Control threshold	Width	Output relay	Reference	Weight
s	V	V	mm			kg
None	200...240 50/60 Hz	Undervoltage 160...220	22.5	2 C/O	<b>RM4-TU01</b>	0.110
		Undervoltage 300...430			<b>RM4-TU02</b>	0.110

### Control relays: rotational direction and presence of phases + overvoltage and undervoltage

#### Relays with fixed voltage thresholds

Adjustable time delay	Rated mains supply voltage (1)	Control threshold	Width	Output relay	Reference	Weight
s	V	V	mm			kg
0.1...10	220 50/60 Hz	Undervoltage 198 Overvoltage 242	22.5	2 C/O	<b>RM4-TR33</b>	0.110
		Undervoltage 360 Overvoltage 440			<b>RM4-TR34</b>	0.110

#### Relays with adjustable voltage thresholds

Adjustable time delay	Rated mains supply voltage (1)	Control threshold	Width	Output relay	Reference	Weight
s	V	V	mm			kg
0.1...10	200...240 50/60 Hz	Undervoltage 160...220 Overvoltage 220...300	22.5	2 C/O	<b>RM4-TR31</b>	0.110
		Undervoltage 300...430 Overvoltage 420...580			<b>RM4-TR32</b>	0.110

### Control relays: rotational direction and presence of phases + asymmetry

Time delay on de-energisation	Rated mains supply voltage (1)	Control threshold	Width	Output relay	Reference	Weight
s	V	%	mm			kg
<b>Fixed</b> 0.5	200...240 50/60 Hz	Asymmetry 5...15	22.5	1 C/O	<b>RM4-TA01</b>	0.110
		Asymmetry 5...15			<b>RM4-TA02</b>	0.110
<b>Adjustable</b> 0.1...10	200...240 50/60 Hz	Asymmetry 5...15	22.5	2 C/O	<b>RM4-TA31</b>	0.110
		Asymmetry 5...15			<b>RM4-TA32</b>	0.110



RM4-TA01

(1) Can be used on other supply voltages provided that the minimum operational voltages, maximum voltage between phases and compatibility with the control threshold ranges are complied with, see page 3/47.

# Zelio Control - measurement and control relays

## 3-phase supply control relays RM4-T

Presentation :  
pages 3/44 to 3/46  
Characteristics :  
page 3/47  
References :  
page 3/48

### Dimensions, schemes

#### Dimensions RM4-T

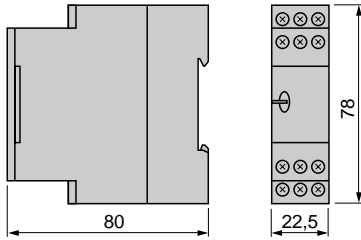

#### Rail mounting

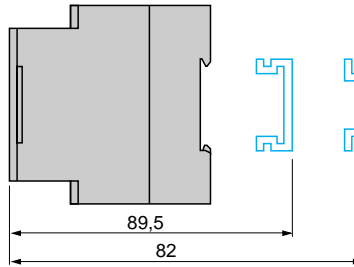

#### Screw fixing

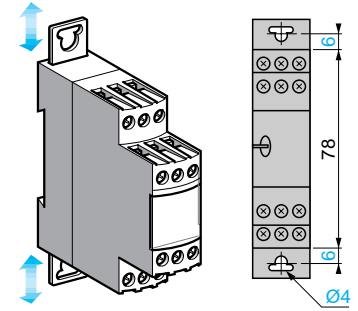

3

#### Schemes, connection

##### Terminal blocks

##### RM4-TG20, TU0●

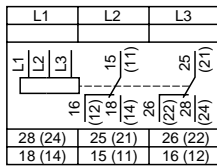

**L1, L2, L3** Supply to be monitored

**15(11)-18(14)** 1<sup>st</sup> C/O contact of the output relay

**25(21)-28(24)** 2<sup>nd</sup> C/O contact of the output relay

##### RM4-TR3●, TA3●

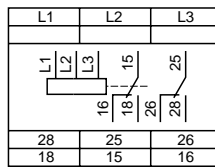

**L1, L2, L3** Supply to be monitored

**15-18** 1<sup>st</sup> C/O contact of the output relay

**25-28** 2<sup>nd</sup> C/O contact of the output relay

##### RM4-TA0●

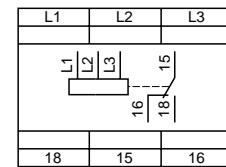

**L1, L2, L3** Supply to be monitored

**15-18** 1<sup>st</sup> C/O contact of the output relay

**15-16** 2<sup>nd</sup> C/O contact of the output relay

#### Application scheme

Example

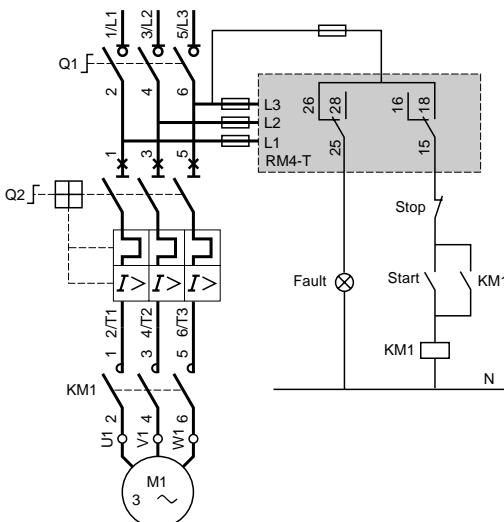

# Zelio Control - measurement and control relays

## Single-phase supply control relays RM4-UB

Characteristics :  
page 3/51  
References :  
page 3/52  
Dimensions, schemes :  
page 3/53



RM4-UB

3

### Presentation

### Functions

These devices are designed for monitoring single-phase mains and power supplies. They have a transparent, hinged flap on their front face to prevent any accidental alteration of the settings. The flap can be directly sealed.

### Applications

- Protection of electronic or electromechanical devices against overvoltage and undervoltage.
- Normal/emergency power supply switching.

### Presentation

#### RM4-UB



- 1 Overvoltage setting potentiometer.
  - 2 Undervoltage setting potentiometer.
  - 3 Time delay function selector:
    - ☒ Fault detection delayed.
    - Fault detection extended.
  - 4 Potentiometer for setting time delay in seconds.
- R Yellow LED: indicates relay state.  
U Green LED: indicates that supply to the RM4 is on.  
> U Red LED: overvoltage fault  
< U Red LED: undervoltage fault

### Operating principle

The supply voltage to be monitored is connected to terminals L1, L3 of the product.

There is no need to provide a separate power supply for RM4-UB relays; they are self-powered by terminals L1, L2, L3.

If the voltage goes outside the range to be monitored, the output relay is de-energised:

- **overvoltage**: red LED "> U" illuminates.
- **undervoltage**: red LED "< U" illuminates.

When the supply returns towards its rated value, the relay is re-energised according to the hysteresis value (5%) and the corresponding red LED goes out.

A selector switch allows selection of an adjustable time delay from 0.1 s to 10 s. With function ☒, transient "over" or "under" voltages are not taken into account. With function ■, all variations above or below are taken into account and re-energisation of the relay is delayed.

In all cases, in order to be detected, the duration of the overvoltage or undervoltage must be greater than the measuring cycle time (80 ms).

#### Function diagram

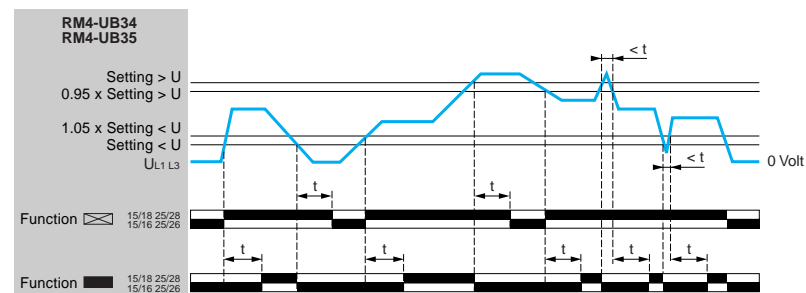

t: time delay

# Zelio Control - measurement and control relays

## Single-phase supply control relays RM4-UB

Presentation :  
page 3/50  
References :  
page 3/52  
Dimensions, schemes :  
page 3/53

### Characteristics

#### Output relay and operational characteristics

<b>Number of C/O contacts</b>			2
<b>Output relay state</b>			Energised during fault free operation. De-energised on detection of an overvoltage or undervoltage fault.
<b>Setting accuracy of switching threshold</b>	As % of the setting value		± 3 %
<b>Switching threshold drift</b>	Depending on the permissible ambient temperature		≤ 0.06 % per degree centigrade
	Within the measuring range		≤ 0.5 %
<b>Accuracy of time delay setting</b>	As % of the full scale value		± 10 %
<b>Time delay drift</b>	Within the measuring range		≤ 0.5 %
	Depending on the rated operational temperature		≤ 0.07 % per degree centigrade
<b>Hysteresis</b>	Fixed		About 5 % of the de-energisation threshold
<b>Measuring cycle</b>		<b>ms</b>	≤ 80

#### Measuring input characteristics

<b>Minimum operational voltage</b>		<b>V</b>	<b>RM4-UB34:</b> 60 <b>RM4-UB35:</b> 160
<b>Maximum permissible voltage between L1 and L3</b>		<b>V</b>	<b>RM4-UB34:</b> 300 <b>RM4-UB35:</b> 300



# Zelio Control - measurement and control relays

Single-phase supply control relays RM4-UB

★ Available 2nd Quarter 2001

Presentation :  
page 3/50  
Characteristics :  
page 3/50  
Dimensions, schemes :  
page 3/53

References



RM4-UB

3

## Relays with adjustable thresholds

Adjustable time delay	Rated mains supply voltage (1)	Control threshold	Width	Output relay	Reference	Weight
s	V	V	mm			kg
0.1...10	100...200 50/60 Hz	Undervoltage 80...120 Overvoltage 160...220	22.5	2 C/O	<b>RM4-UB34</b>	0.110
	180...270 50/60 Hz	Undervoltage 160...220 Overvoltage 220...300	22.5	2 C/O	<b>RM4-UB35</b>	0.110

(1) Can be used on other supply voltages provided that the minimum operational voltages, maximum voltage between phases and compatibility with the control threshold ranges are complied with, see page 3/51.

# Zelio Control - measurement and control relays

## Single-phase supply control relays RM4-UB

Presentation :  
page 3/50  
Characteristics :  
page 3/51  
References :  
page 3/52

### Dimensions, schemes

#### Dimensions RM4-UB

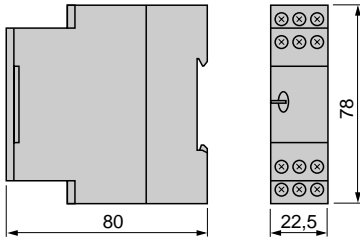

#### Rail mounting

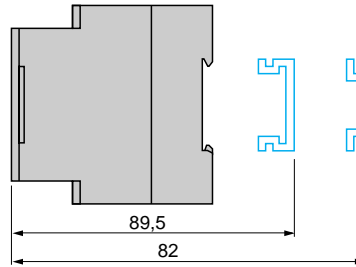

#### Screw fixing

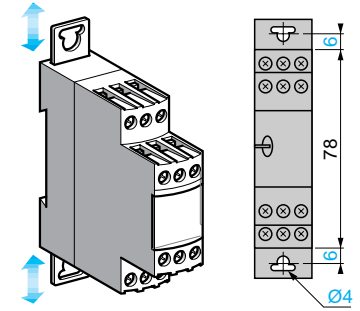

3

#### Scheme, connection Terminal block RM4-UB

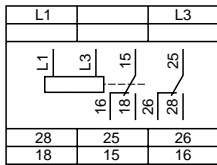

**L1, L3** Supply to be monitored

**15-18** 1<sup>st</sup> C/O contact  
of the output relay

**25-28** 2<sup>nd</sup> C/O contact  
of the output relay

#### Application scheme Example

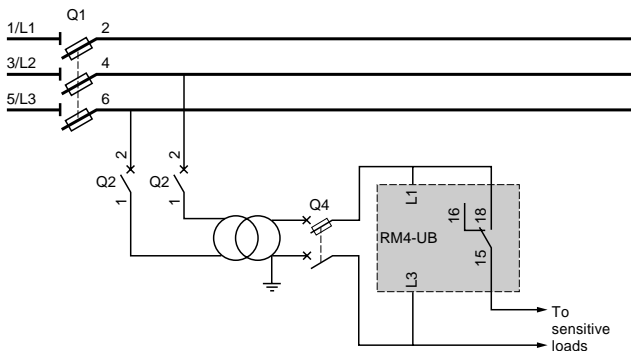

# Zelio Control - measurement and control relays

Characteristics :  
 page 3/56  
 References :  
 page 3/56  
 Dimensions :  
 page 3/57  
 Setting-up :  
 page 3/57

## Liquid level control relays

### Presentation

### Functions



RM4-LG01

These devices monitor the levels of conductive liquids.

They control the actuation of pumps or valves to regulate levels, and are also suitable for protecting submersible pumps against running empty, or protecting tanks from "overflow". They can also be used to control dosing of liquids in mixing processes and to protect heating elements in the event of non immersion.

They have a transparent, hinged flap on their front face to prevent any accidental alternation of the settings. This flap can be directly sealed.

- **Compatible liquids:**
  - spring, town, industrial and sea water,
  - metallic, acid or basic salt solutions,
  - liquid fertilizers,
  - non concentrated alcohol (< 40 %),
  - liquids in the food processing industry: milk, beer, coffee, etc.
- **Non-compatible liquids:**
  - chemically pure water,
  - fuels, liquid gasses (inflammable),
  - oil, concentrated alcohol (> 40 %),
  - ethylene, glycol, paraffin, varnish and paints.

### Description



RM4-LA32

**RM4-LG01**  
 Width 22.5 mm

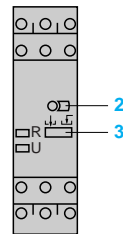

**RM4-LA32**  
 Width 22.5 mm

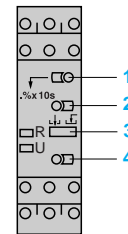

- 1 Fine adjustment of time delay (as % of maximum value of setting range).
- 2 Fine adjustment of response sensitivity (as % of maximum value of setting range).
- 3 Function selector switch:
  - empty or fill .
- 4 Switch combining:
  - selection of the response sensitivity range,
  - selection of time delay on energisation or on de-energisation of the relay.

**R** Yellow LED: indicates relay state.

**U** Green LED: indicates that supply to the RM4 is on

Table showing details for switch 3

Switch position	Time delay	Sensitivity
500	On-delay	High = 500 kΩ range
500	Off-delay	High = 500 kΩ range
50	On-delay	Medium = 50 kΩ range
50	Off-delay	Medium = 50 kΩ range
5	On-delay	Low = 5 kΩ range
5	Off-delay	Low = 5 kΩ range

# Zelio Control - measurement and control relays

Characteristics :  
 page 3/56  
 References :  
 page 3/56  
 Dimensions :  
 pages 3/57  
 Setting-up :  
 page 3/57

## Liquid level control relays

### Presentation (continued)

### Operating principle

The operating principle is based on a change in the resistance measured between immersed or non immersed electrodes. Low resistance between electrodes: liquid present. High resistance between electrodes: no liquid present. The electrodes may be replaced by other sensors or probes which transmit values representing variations in resistance. The a.c. measuring voltage, which is < 30 V and galvanically insulated from the supply and contact circuits, ensures safe use and the absence of any electrolysis phenomena.

RM4-L relays may be used:

- For detection of a liquid level, operating with 2 electrodes, one reference electrode and one high level electrode, or an LA9-RM201 probe. Example: prevention of tank overflow.
- For regulating a liquid level between a minimum and a maximum level, operating with 3 electrodes, or an LA9-RM201 probe. Example: water tower.

The state of the output relay can be configured:

- Empty function  $\downarrow$ : the output relay is energised when high level electrode B2 is immersed and is de-energised when low level electrode B3 is "dry" (1).
- Fill function  $\uparrow$ : the output relay is energised when the low level electrode is "dry" and is de-energised when the high level electrode is immersed (1).

On model RM4-LA32, a time delay can be set on energisation or de-energisation of the output relay in order to raise the maximum level (function  $\boxtimes$ ) or to lower the minimum level (function  $\blacksquare$ ).

This function also makes it possible to avoid pulsing of the output relay (wave effect) when operating with 2 electrodes.



#### Empty function, maximum level detection (2 electrodes or 1 probe LA9-RM201)

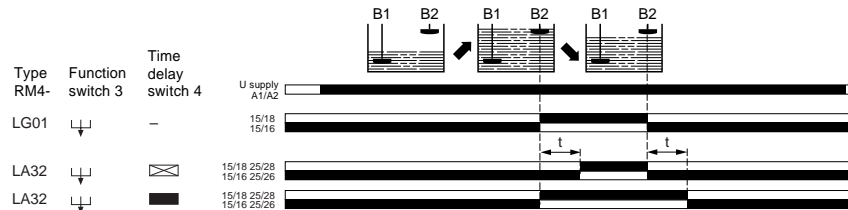

#### Empty function, regulation between a maximum and a minimum level (3 electrodes or 2 probes LA9-RM201)

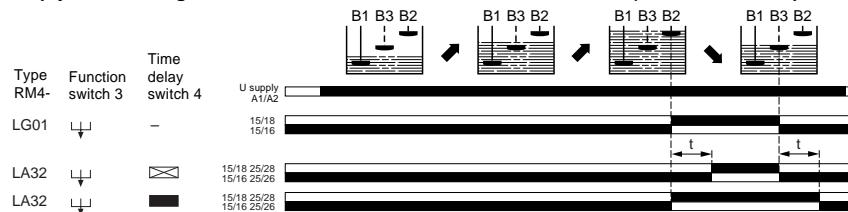

#### Fill function, maximum level detection (2 electrodes or 1 probe LA9-RM201)

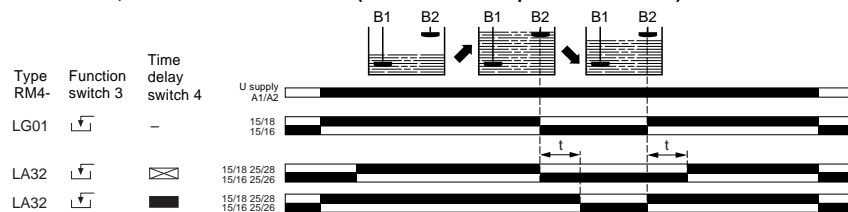

#### Empty function, regulation between a maximum and a minimum level (3 electrodes or 2 probes LA9-RM201)

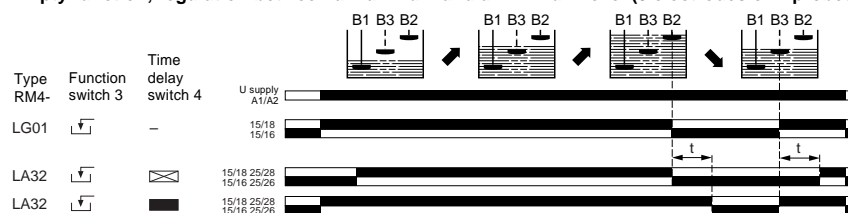

B1: reference electrode                      B2: high level electrode                      B3: low level electrode  
 (1) When operating with 2 electrodes, the high level electrode performs both high and low level functions.

# Zelio Control - measurement and control relays

Liquid level control relays

Characteristics, references

★ Available 2nd Quarter 2001

Presentation :  
pages 3/54 and 3/55  
Dimensions :  
page 3/57  
Setting-up :  
page 3/57

Type of relay		RM4-LG01	RM4-LA32
---------------	--	----------	----------

## Power supply circuit characteristics

Rated supply voltage (Un)	~ 50/60 Hz	V	24	110...130	220...240	380...415	24...240	24	110...130	220...240	380...415
	≡	V	-	-	-	-	24...240	-	-	-	-
Average consumption at Un	~	VA	1.9	2.6	2.4	2.9	2.7	3.1	2.7	2.6	3.4
	≡	W	-	-	-	-	2.4	-	-	-	-

## Output relay and operating characteristics

Number of C/O contacts		1	2
Output relay state	Can be configured by switch: empty $\downarrow$ / fill $\uparrow$		

3

## Electrode circuit characteristics (1)

Sensitivity scale	kΩ	5...100 (adjustable)	0.25...5	2.5...50	25...500
Maximum a.c. electrode voltage (peak to peak)	V	24	24		
Maximum current in the electrodes	mA	1	1	1	1
Maximum cable capacity	nF	10	200	25	4
Maximum cable length	m	100	1000	100	20

## References



RM4-LG01



RM4-LA32



LA9-RM201

### Liquid level control relays

Time delay	Sensitivity scale	Width	Output relay	Basic reference. Complete with code indicating the voltage (2)	Weight
	kΩ	mm			kg
None	5...100	22.5	1 C/O	<b>RM4-LG01●</b>	0.165
Adjustable 0.1...10 s	0.25 ...5 2.5 ...50 25 ...500	22.5	2 C/O	<b>RM4-LA32●●</b>	0.165

### Liquid level control probe

Type of installation	Maximum operating temperature °C	Reference	Weight
			kg
Suspended by cable	100	<b>LA9-RM201</b>	0.100

(1) The electrodes may also be incorporated in the probes. The probes are normally designed for fixing to a tank by means of a bracket with a seal (closed tanks) or suspended by their own electrical connecting cable (boreholes, etc.). See page 3/57 "Setting-up" Probe LA9-RM201.

(2) Standard supply voltages

RM4-LG01	Volts		24	110...130	220...240	380...415
	~ 50/60 Hz		B	F	M	Q
RM4-LA32	Volts	24...240	24	110...130	220...240	380...415
	~ 50/60 Hz	MW	B	F	M	Q
	≡	MW	-	-	-	-

# Zelio control - measurement and control relays

## Liquid level control relays

### Dimensions, schemes, setting-up

Presentation :  
pages 3/54 and 3/55  
Characteristics :  
page 3/56  
References :  
page 3/56

#### Dimensions RM4-LG01, LA32

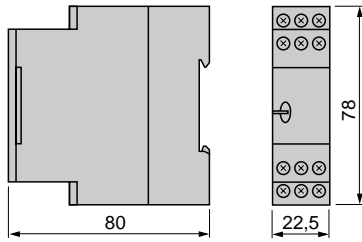

#### Rail mounting

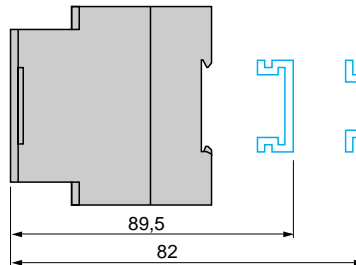

#### Screw fixing

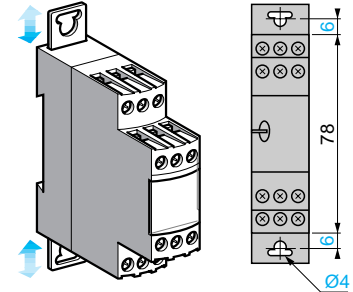

#### Probe LA9-RM201

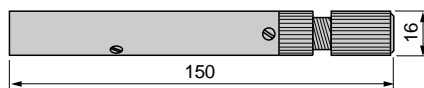

#### Schemes, connection

##### RM4-LG01

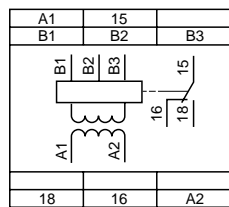

##### RM4-LA32

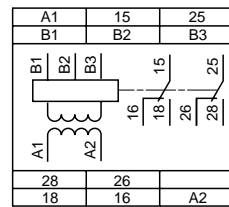

**A1-A2** Supply voltage  
**B1, B2, B3** Electrodes  
(see table opposite)  
**15-18** 1st C/O contact of the output relay  
**25-28** 2nd C/O contact of the output relay

#### Electrodes and level controlled

**B1** Reference or tank earth electrode  
**B2** High level  
**B3** Low level

#### Setting-up

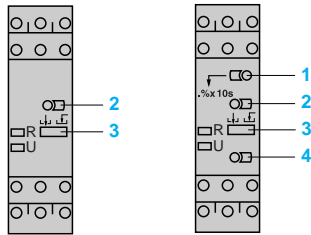

##### RM4-LG01

##### RM4-LA32

- Select the empty  $\downarrow$  /fill  $\uparrow$  function according to the sequence to be performed.
  - If necessary, set potentiometer 1 to minimum (time delay).
  - Set potentiometer 2 to minimum; on RM4-LA select the lowest sensitivity range using potentiometer 4 (5  $\boxtimes$  or 5  $\blacksquare$ ).
  - With all the electrodes immersed, turn the sensitivity potentiometer towards maximum until the relay is energised ( $\downarrow$  function) or de-energised ( $\uparrow$  function), then exceed the threshold by about 10 % to compensate for variation in the supply voltage.  
If the relay is not able to energise, a higher sensitivity scale must be used (selector 4 on RM4-LA32) or relay RM4-LG must be replaced by an RM4-LA32 relay and the adjustment procedure must be started again.
  - Then check that the relay de-energises ( $\uparrow$  function) or energises ( $\downarrow$  function) as soon as electrodes B3 and B2 are out of the liquid. If the relay does not de-energise, select a lower sensitivity scale.
  - The electrode connection point must be protected against corrosion by sticking or sealing. In areas where thunderstorms are likely to occur, measures must also be taken to protect the electrode lines.
- Note:** the high level can be raised by means of the adjustable time delay from 0.1 to 10 seconds with function  $\boxtimes$ . The low level can be lowered by means of this same time delay with function  $\blacksquare$ .

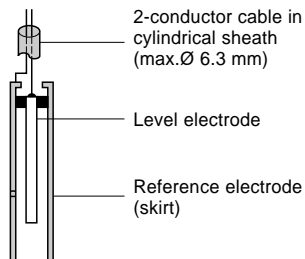

##### LA9-RM201

#### Probe LA9-RM201

This probe is of the "suspended" type. It is coaxial, i.e. in addition to the normal (central) electrode, the stainless steel skirt can also act as earth (reference) electrode, which means that there is no need to install a separate reference probe. In this way, for controlling one level, only one probe is required instead of 2; for controlling 2 levels, only 2 probes are required instead of 3.

The connecting cable must be of the "2-conductor" type, with common cylindrical PVC sheath, having a maximum diameter of 6.3 mm. The skirt also acts as a "calming chamber", so avoiding inaccuracy due to an agitated surface of the liquid (waves).

Maximum operating temperature: 100 °C.

Probe LA9-RM201 can also be fixed on various containers (cisterns, tanks,...) by means of a bracket or other suitable fixing device.

#### Connection examples Control by electrodes

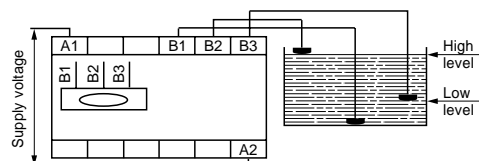

#### Control by probes

