

MGA · MGAD · MGADD · MGAT

.100 GRID HIGH-PERFORMANCE RELAYS

MGA

**STANDARD .100 GRID
HIGH-PERFORMANCE RELAY**

**QUALIFIED TO
MIL-R-39016/17**

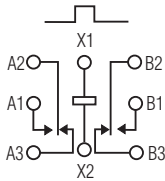

TERMINAL VIEW

FEATURES

- Hermetically sealed
- High shock & vibration ratings
- Mounting pads
- Excellent RF switching

MGAD

**STANDARD .100 GRID
DIODE SUPPRESSED
HIGH-PERFORMANCE RELAY**

**QUALIFIED TO
MIL-R-39016/18**

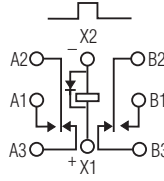

TERMINAL VIEW

FEATURES

- Suppression diode
- Hermetically sealed
- High shock & vibration ratings
- Mounting pads
- Excellent RF switching

MGADD

**STANDARD .100 GRID DIODE
SUPPRESSED/PROTECTED
HIGH-PERFORMANCE RELAY**

**QUALIFIED TO
MIL-R-39016/19**

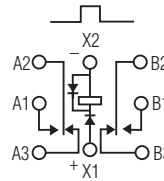

TERMINAL VIEW

FEATURES

- Suppression & protection diodes
- Hermetically sealed
- High shock & vibration ratings
- Mounting pads
- Excellent RF switching

MGAT

**STANDARD .100 GRID DIODE
SUPPRESSED/MOSFET DRIVEN
HIGH-PERFORMANCE RELAY**

**QUALIFIED TO
MIL-R-28776/6**

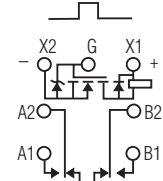

TERMINAL VIEW

FEATURES

- MOSFET driver, zener & suppression diodes
- Hermetically sealed
- High shock & vibration ratings
- Mounting pads
- Excellent RF switching

ELECTRICAL CHARACTERISTICS

CONTACT ARRANGEMENT
2 Form C (DPDT)

CONTACT MATERIAL
Stationary:
Gold/platinum/palladium/silver
(gold plated)
Moveable:
Gold/platinum/palladium/silver
(gold plated)

CONTACT RESISTANCE
Before Life: 100 milliohms max.
(measured @ 10 mA @ 6 Vdc)
After Life: 200 milliohms max.
(measured @ 1 A @ 28 Vdc)

MECHANICAL LIFE EXPECTANCY
1 million operations

COIL VOLTAGE
5 to 26.5 Vdc

COIL POWER
660 mW max. @ 25°C

DUTY CYCLE
Continuous

PICK-UP VOLTAGE
Approximately 50% of
nominal coil voltage

PICK-UP SENSITIVITY
130 mW max. @ 25°C

CONTACT RATINGS

CONTACT LOAD	TYPE	OPERATIONS MIN.
1.0 A @ 28 Vdc	Resistive	100,000
250 mA @ 115 Vac, 60 Hz & 400 Hz	Resistive (case not grounded)	100,000
100 mA @ 115 Vac, 60 Hz & 400 Hz	Resistive	100,000
0.2 A @ 28 Vdc	Inductive (0.32 Henry)	100,000
0.1 A @ 28 Vdc	Lamp	100,000
30 µA @ 50 mVdc	Low Level	1,000,000
0.1 A @ 28 Vdc	Intermediate Current	50,000

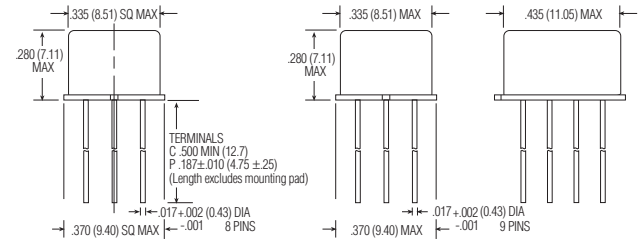

MGA/MGAD/MGADD ENCLOSURE

MGAT ENCLOSURE



MGA



MGAT

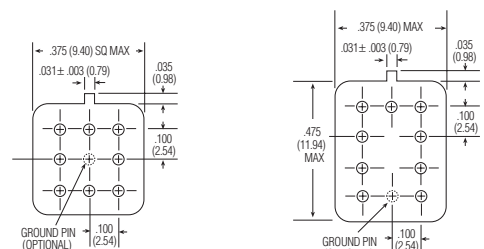

MGA/MGAD/MGADD HEADER

MGAT HEADER

OPERATING CHARACTERISTICS

TIMING

Operate Time:
2.0 ms max.

Release Time:
MGA: 1.5 ms max.
MGAD/MGADD: 4.0 ms max.
(suppression diode, protection/sup-
pression diodes)
MGAT: 4.0 ms max.
(suppression/zener diodes)

CONTACT BOUNCE

1.5 ms max.

DIELECTRIC WITHSTANDING VOLTAGE

Between Open Contacts:
500 Vrms 60 Hz

Between Adjacent Contacts:
500 Vrms 60 Hz

Between Contacts & Coil:
500 Vrms 60 Hz

INSULATION RESISTANCE

10,000 megohms min. @ 500 Vdc
1,000 megohms @ 500 Vdc
(coil to case @ +125°C)

ENVIRONMENTAL CHARACTERISTICS

TEMPERATURE RANGE

-65°C to +125°C

WEIGHT

0.09 oz. (2.55 gms)
0.129 oz. (3.45 gms) w/ mounting
pad attached

VIBRATION RESISTANCE

30 G's, 10 to 3,000 Hz

SHOCK RESISTANCE

75 G's, 6 ± 1 ms max.

QPL APPROVAL

MIL-R-39016/17 (JMGA)
MIL-R-39016/18 (JMGAD)
MIL-R-39016/19 (JMGADD)
MIL-R-28776/6 (JMGAT)

SEMICONDUCTOR CHARACTERISTICS

DIODE

100 Vdc peak inverse voltage (PIV)
1.0 Vdc max. transient voltage

ZENER DIODE

20 Vdc ±3 Vdc over temperature
range

MOSFET

0.5 Vdc min. gate turn-off voltage
4.3 Vdc max. gate turn-on voltage

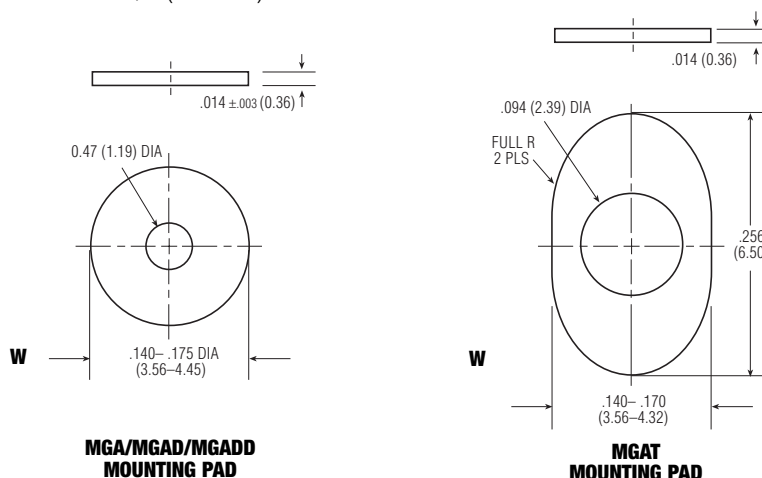

COIL DATA

NOM. COIL VOLTAGE (Vdc)	COIL RESISTANCE IN OHMS ±10% @ 25°C (Note)	COIL CIRCUIT CURRENT mA (MAX.) (Note)	COIL CIRCUIT CURRENT mA (MIN.) (Note)	PICKUP VOLTAGE Vdc (MAX.) @ 25°C	PICKUP VOLTAGE Vdc (MAX.) @ 125°C	DROP-OUT VOLTAGE Vdc (MIN.) @ 25°C	DROP-OUT VOLTAGE Vdc (MIN.) @ -65°C	NOM. COIL POWER (mW) @ 25°C	MAX. COIL VOLTAGE	COIL DESIG.
MGA/MGAD										
5.0	50	n/a	n/a	2.7	3.5	0.22	0.14	500	5.8	5
6.0	98	n/a	n/a	3.5	4.5	0.28	0.18	367	8.0	6
9.0	220	n/a	n/a	5.3	6.8	0.54	0.35	368	12.0	9
12.0	390	n/a	n/a	7.0	9.0	0.63	0.41	369	16.0	12
18.0	880	n/a	n/a	10.5	13.5	0.91	0.59	368	24.0	18
26.5	1,560	n/a	n/a	14.2	18.0	1.37	0.89	450	32.0	26
MGADD										
5.0	39	128.2	93.2	3.2	4.0	0.6	0.6	641	5.8	5
6.0	78	78.3	58.3	4.0	5.0	0.7	0.7	462	8.0	6
9.0	220	42.9	33.0	6.3	7.8	0.9	0.8	368	12.0	9
12.0	390	32.8	25.6	8.0	10.0	1.1	0.9	369	16.0	12
18.0	880	22.1	17.5	11.5	14.5	1.4	1.1	368	24.0	18
26.5	1,560	18.5	14.8	15.2	19.0	1.8	1.4	450	32.0	26
MGAT										
5.0	39	132.3	96.5	2.9	3.5	0.23	0.13	641	5.8	5
6.0	78	83.9	60.3	3.5	4.5	0.32	0.18	462	8.0	6
9.0	220	47.1	33.1	5.3	6.8	0.48	0.27	368	12.0	9
12.0	390	36.1	24.9	7.1	9.0	0.65	0.36	369	16.0	12
18.0	880	24.1	16.1	10.6	13.5	0.97	0.54	368	24.0	18
26.5	1,560	19.9	12.9	14.2	18.0	1.30	0.72	450	32.0	26

Note: Coil resistance not directly measurable. Coil current should be within limits shown when tested at nominal voltage at 25°C for 5 seconds max.

SPECIFYING A PART NUMBER EXAMPLE: TYPE MGA TERMINALS C DIODES TRANSISTOR D GROUND PINS G COILS -26 MOUNTING PADS W

