

mm inch

### FEATURES

• Excellent high frequency characteristics (Impedance 75Ω)

• Surface-mount terminal (type) also available

Frequency	900MHz	2.6GHz
V.S.W.R. (Max.)	1.2	1.5
Insertion loss (dB, Max.)	0.2	0.5
Isolation (dB, Min.)	60	30

### SPECIFICATIONS

#### Contact

Arrangement	1 Form C	
Contact material	Gold	
Initial contact resistance	Max. 100mΩ	
Rating	Contact rating	1W (at 2.6 GHz, Impedance 75 Ω, V.S.W.R. Max.1.5) 10mA 24V DC (resistive load)
	Contact carrying power	10W (at 2.6GHz, Impedance 75 Ω, V.S.W.R. Max.1.5)
	Max. switching voltage	30 V DC
	Max. switching current	0.5 A DC
High frequency characteristics (Impedance 75Ω)	V.S.W.R.	Max. 1.2 (to 900MHz) Max. 1.5 (to 2.6GHz)
	Insertion loss	Max. 0.2 (to 900MHz) Max. 0.5 (to 2.6GHz)
	Isolation	Min. 60dB (to 900MHz) Min. 30dB (to 2.6GHz)
Expected life (min. operations)	Mechanical (at 180 cpm)	10 <sup>6</sup>
	Electrical	1W, 2.6GHz, Impedance 75Ω, V.S.W.R. & 1.5
		10mA 24V DC (resistive load) (at 20cpm)

#### Coil (at 20°C, 68°F)

Nominal operating power	200 mW
-------------------------	--------

#### Characteristics

Initial insulation resistance*1		Min. 100 MΩ (at 500 V DC)
Initial breakdown voltage*2	Between open contacts	500 Vrms
	Between contact and coil	1,000 Vrms
	Between contact and ground terminal	500 Vrms
Operate time*3 (at 20°C)		Max. 10ms
Release time (without diode)*3 (at 20°C)		Max. 5ms
Temperature rise (at 20°C)*4		Max. 60°C
Shock resistance	Functional*5	Min. 500 m/s <sup>2</sup> {50 G}
	Destructive*6	Min. 1,000 m/s <sup>2</sup> {100 G}
Vibration resistance	Functional*7	10 to 55 Hz at double amplitude of 3 mm
	Destructive	10 to 55 Hz at double amplitude of 5 mm
Conditions for operation, transport and storage*8 (Not freezing and condensing at low temperature)	Ambient temp.	-40°C to 60°C -40°F to 140°F
	Humidity	5 to 85% R.H.
Unit weight		Approx. 5 g .18 oz

#### Remarks

- \* Specifications will vary with foreign standards certification ratings.
- \*1 Measurement at same location as "Initial breakdown voltage" section.
- \*2 Detection current: 10mA
- \*3 Nominal operating voltage applied to the coil, excluding contact bounce time.
- \*4 By resistive method, nominal voltage applied to the coil: Contact carrying power: 10W, at 2.6GHz, Impedance 75Ω, V.S.W.R. & 1.5
- \*5 Half-wave pulse of sine wave: 11ms, detection time: 10μs.
- \*6 Half-wave pulse of sine wave: 6ms
- \*7 Detection time: 10μs
- \*8 Refer to 5. Conditions for operation, transport and storage mentioned in NOTES

### TYPICAL APPLICATIONS

#### Broadcasting market

- Set Top Box (CS/BS tuner, CATV tuner)
- Multi-function TV
- Measuring instruments for broadcasting

### ORDERING INFORMATION

Contact arrangement	Operating function	Terminal shape	Coil voltage (DC)	Packing style
1: 1 Form C	3: Single side stable type	Nil: Standard PC board terminal A: Surface-mount terminal	03: 3 V 4H: 4.5 V 06: 6 V 09: 9 V 12: 12 V 24: 24 V	Nil: Tube packing (Standard PC board terminal only) Z: Tape and reel packing (picked from 1/7 pin side)

Note: Tape and reel packing symbol "Z" is not marked on the relay.  
"X" type tape and reel packing (picked from 8/9/10/11/12/13/14-pin side) is also available.  
Suffix "X" instead of "Z".

**TYPES AND COIL DATA (at 20°C 68°F)**

- Packing of standard PC board terminal: 50 pcs. in an inner package (tube); 500 pcs. in an outer package.
- Packing of surface-mount terminal: 400 pcs. in an inner package (tape and reel); 800 pcs. in an outer package.

Standard PC board terminal	Surface-mount terminal	Nominal voltage, V DC	Pick-up voltage, V DC (max.) (initial)	Drop-out voltage, V DC (min.)(initial)	Coil resistance, Ω (±10%)	Nominal operating current, mA (±10%)	Nominal operating power, mW	Max. allowable voltage, V DC
ARE1303	ARE13A03	3	2.25	0.3	45	66.7	200	3.3
ARE134H	ARE13A4H	4.5	3.375	0.45	101	44.4	200	4.95
ARE1306	ARE13A06	6	4.5	0.6	180	33.3	200	6.6
ARE1309	ARE13A09	9	6.75	0.9	405	22.2	200	9.9
ARE1312	ARE13A12	12	9	1.2	720	16.7	200	13.2
ARE1324	ARE13A24	24	18	2.4	2,880	8.3	200	26.4

**DIMENSIONS**

mm inch

**1. Standard PC board terminal**

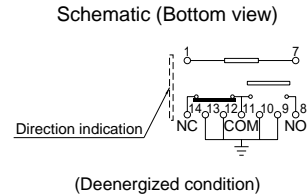
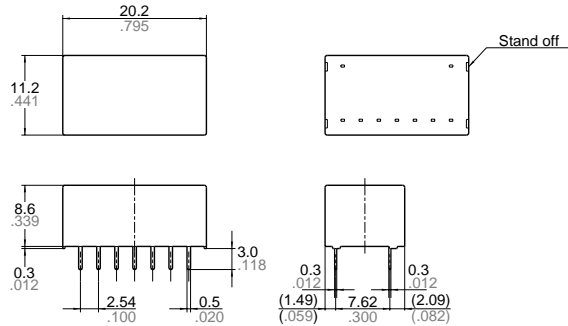

General tolerance: ±0.3 ±.012

**2. Surface mount terminal**

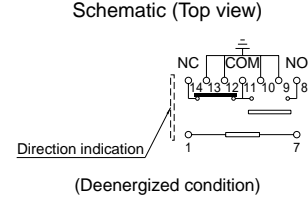
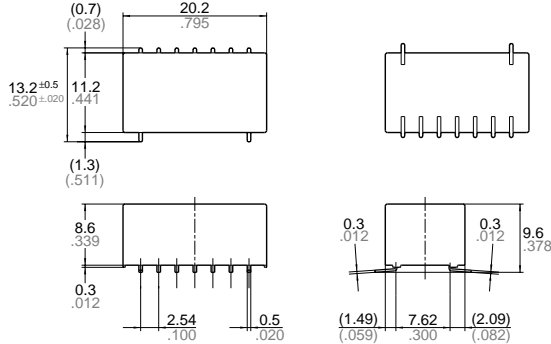

General tolerance: ±0.3 ±.012

**REFERENCE DATA**

**1. High frequency characteristics (Standard PC board terminal)**

- V.S.W.R. characteristics

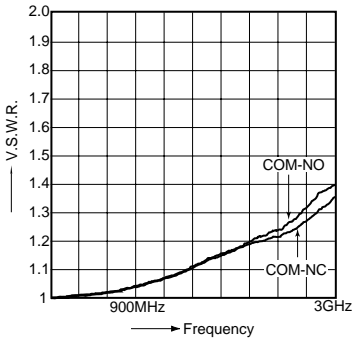

- Insertion loss characteristics

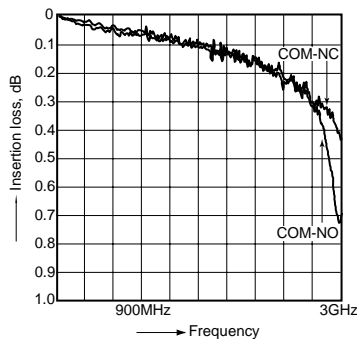

- Isolation characteristics

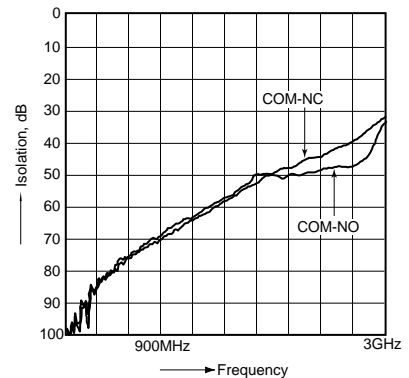

**NOTES**

**1. Coil operating power**

Pure DC current should be applied to the coil. The wave form should be rectangular. If it includes ripple, the ripple factor should be less than 5%.

However, check it with the actual circuit since the characteristics may be slightly different.

**2. Cleaning**

For automatic cleaning, the boiling method is recommended. Avoid ultrasonic cleaning which subjects the relays to high frequency vibrations, which may cause the contacts to stick.

It is recommended that alcoholic solvents be used.

**3. Soldering**

1) The soldering shall be performed under following condition.

Max. 260°C 500°F 10s

Max. 350°C 662°F 3s

The affect of the PCB on the relay will differ depending on the type of PCB used.

Please verify the type of PCB to be used.

Soldering time: within 5s

2) In case of automatic soldering, the following conditions should be observed (Surface-mount terminal)

(1) Position of measuring temperature

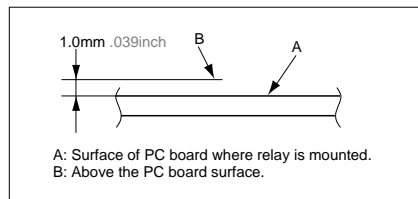

**(2) IR (infrared reflow) soldering method**

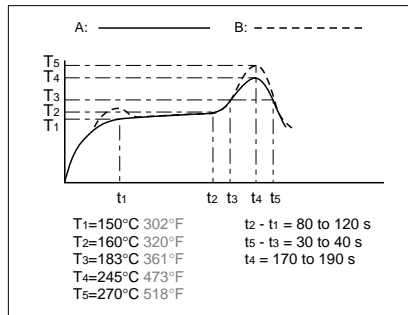

Temperature rise of relay itself may vary according to the mounting level or the heating method of reflow equipment.

Therefore, please set the temperature of soldering portion of relay terminal and the top surface of the relay case not to exceed the above mentioned soldering condition. It is recommended to check the temperature rise of each portion under actual mounting condition before use.

**4. Packing style**

**1) Tape dimensions**

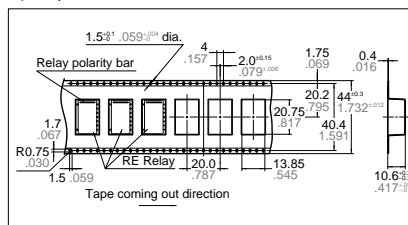

**2) Dimensions of plastic reel**

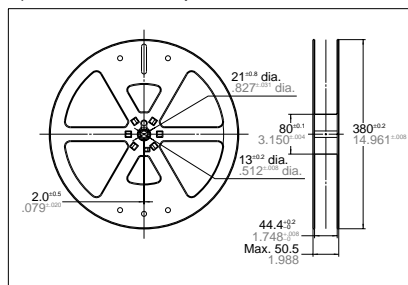

**5. Conditions for operation, transport and storage**

1) Ambient temperature, humidity, and atmospheric pressure during usage, transport, and storage of the relay:

(1) Temperature:

-40 to +60°C -40 to +140°F

(2) Humidity: 5 to 85% RH

(Avoid freezing and condensation.)

The humidity range varies with the temperature. Use within the range indicated in the graph below.

(3) Atmospheric pressure: 86 to 106 kPa  
Temperature and humidity range for usage, transport, and storage:

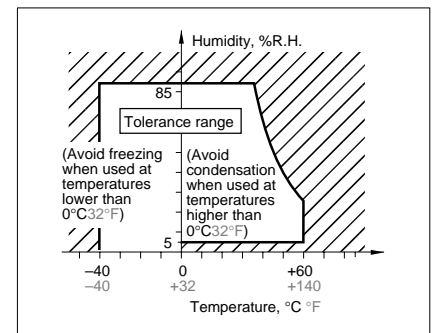

**2) Condensation**

Condensation forms when there is a sudden change in temperature under high temperature and high humidity conditions. Condensation will cause deterioration of the relay insulation.

**3) Freezing**

Condensation or other moisture may freeze on the relay when the temperature is lower than 0°C 32°F. This causes problems such as sticking of movable parts or operational time lags.

**4) Low temperature, low humidity environments**

The plastic becomes brittle if the relay is exposed to a low temperature, low humidity environment for long periods of time.