

MA · MAD · MADD · MAT

MA

**STANDARD TO-5
HIGH-PERFORMANCE RELAY**

**QUALIFIED TO
MIL-R-39016/9**

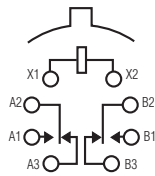

TERMINAL VIEW

FEATURES

- Hermetically sealed
- High shock & vibration ratings
- Spreader pads
- Excellent RF switching

MAD

**STANDARD TO-5
DIODE SUPPRESSED
HIGH-PERFORMANCE RELAY**

**QUALIFIED TO
MIL-R-39016/15**

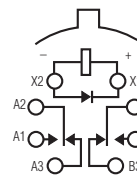

TERMINAL VIEW

FEATURES

- Suppression diode
- Hermetically sealed
- High shock & vibration ratings
- Spreader pads
- Excellent RF switching

MADD

**STANDARD TO-5 DIODE
SUPPRESSED/PROTECTED
HIGH-PERFORMANCE RELAY**

**QUALIFIED TO
MIL-R-39016/20**

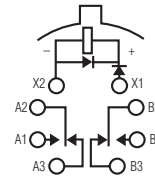

TERMINAL VIEW

FEATURES

- Suppression & protection diodes
- Hermetically sealed
- High shock & vibration ratings
- Spreader pads
- Excellent RF switching

MAT

**STANDARD TO-5 DIODE
SUPPRESSED/TRANSISTOR DRIVEN
HIGH-PERFORMANCE
RELAY**

**QUALIFIED TO
MIL-R-28776/1**

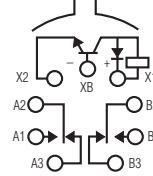

TERMINAL VIEW

FEATURES

- Transistor driver & suppression diode
- Hermetically sealed
- High shock & vibration ratings
- Spreader pads
- Excellent RF switching

ELECTRICAL CHARACTERISTICS

CONTACT ARRANGEMENT
2 Form C (DPDT)

CONTACT MATERIAL
Stationary:
Gold/platinum/palladium/silver alloy (gold plated)
Moveable:
Gold/platinum/palladium/silver alloy (gold plated)

CONTACT RESISTANCE
Before Life: 100 milliohms max. (measured @ 10 mA @ 6 Vdc)
After Life: 200 milliohms max. (measured @ 1 A @ 28 Vdc)

MECHANICAL LIFE EXPECTANCY
1 million operations

COIL VOLTAGE
5 to 30 Vdc

COIL POWER
675 mW max. @ 25°C

DUTY CYCLE
Continuous

PICK-UP VOLTAGE
Approximately 50% of nominal coil voltage

PICK-UP SENSITIVITY
130 mW max. @ 25°C

CONTACT RATINGS

CONTACT LOAD	TYPE	OPERATIONS MIN.
1.0 A @ 28 Vdc	Resistive	100,000
250 mA @ 115 Vac, 60 Hz & 400 Hz	Resistive (case not grounded)	100,000
100 mA @ 115 Vac, 60 Hz & 400 Hz	Resistive	100,000
0.2 A @ 28 Vdc	Inductive (0.32 Henry)	100,000
0.1 A @ 28 Vdc	Lamp	100,000
30 µA @ 50 mVdc	Low Level	1,000,000
0.1 A @ 28 Vdc	Intermediate Current	50,000

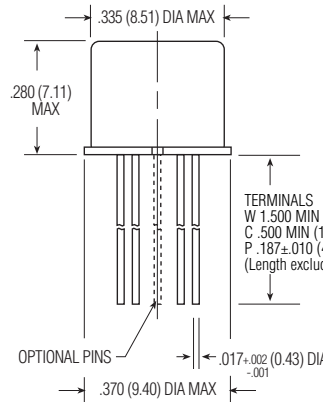

ENCLOSURE

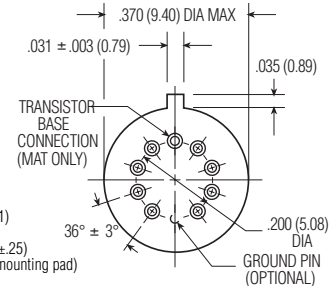

HEADER

TO-5 HIGH-PERFORMANCE RELAYS



OPERATING CHARACTERISTICS

TIMING

Operate Time:
2.0 ms max.

Release Time:
MA: 1.5 ms max.
MAD/MADD: 4.0 ms max.
(suppression diode,
suppression/steering diodes)
MAT: 7.5 ms max.
(transistor driven)

CONTACT BOUNCE

1.5 ms max

DIELECTRIC WITHSTANDING VOLTAGE

Between Open Contacts:
500 Vrms 60 Hz

Between Adjacent Contacts:
500 Vrms 60 Hz

Between Contacts & Coil:
500 Vrms 60 Hz

INSULATION RESISTANCE

10,000 megohms min. @ 500 Vdc
1,000 megohms @ 500 Vdc
(coil to case @ +125°C)

ENVIRONMENTAL CHARACTERISTICS

TEMPERATURE RANGE

-65°C to +125°C

WEIGHT

0.09 oz. (2.55 gms)
0.10 oz. (2.80 gms) with spreader
pad attached

VIBRATION RESISTANCE

30 G's, 10 to 3,000 Hz

SHOCK RESISTANCE

75 G's, 6 ±1 ms max.

QPL APPROVAL

MIL-R-39016/9 (JMA)
MIL-R-39016/15 (JMAD)
MIL-R-39016/20 (JMADD)
MIL-R-28776/1 (JMAT)

SEMICONDUCTOR CHARACTERISTICS

DIODE

100 Vdc peak inverse voltage (PIV)
1.0 Vdc max. transient voltage

TRANSISTOR

0.3 Vdc min. base turn off voltage
6.0 Vdc min. emitter-base
breakdown voltage (BV_{EBO}) @ 25°C
80.0 Vdc min. collector-base
breakdown voltage (BV_{CBO}) @ 25°C
& I_C=100 µA

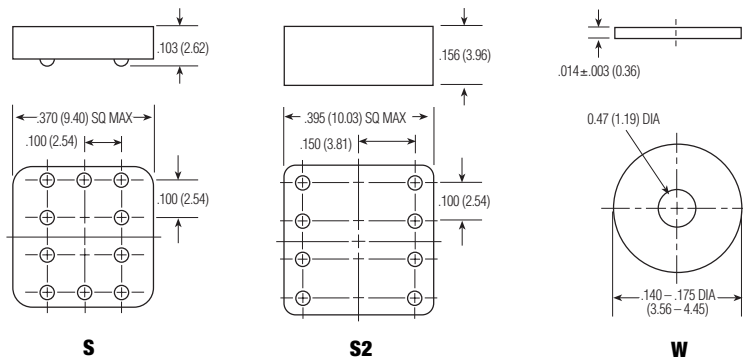

SPREADER & MOUNTING PADS

COIL DATA

NOM. COIL VOLTAGE (Vdc)	COIL RESISTANCE IN OHMS ±10% @ 25°C (Note 1)	COIL CIRCUIT CURRENT mA (MAX.) (Note 1&2)	COIL CIRCUIT CURRENT mA (MIN.) (Note 1&2)	PICKUP VOLTAGE Vdc (MAX.) @ 25°C (Note 2)	BASE TURN ON CURRENT mA (MAX.) @ 25°C	PICKUP VOLTAGE Vdc (MAX.) @ 125°C (Note 2)	BASE TURN ON CURRENT mA (MAX.) @ 125°C	DROP-OUT VOLTAGE Vdc (MIN.) (Note 2)	DROP-OUT VOLTAGE Vdc (MIN.) @ -65°C (Note 2)	NOM. COIL POWER (mW) @ 25°C	MAX. COIL VOLTAGE	COIL DESIG.
MA/MAD												
5.0	50	n/a	n/a	2.7	n/a	3.5	n/a	0.22	0.14	500	5.8	5
6.0	98	n/a	n/a	3.5	n/a	4.5	n/a	0.28	0.18	367	8.0	6
9.0	220	n/a	n/a	5.3	n/a	6.8	n/a	0.54	0.35	368	12.0	9
12.0	390	n/a	n/a	7.0	n/a	9.0	n/a	0.63	0.41	369	16.0	12
18.0	880	n/a	n/a	10.5	n/a	13.5	n/a	0.91	0.59	368	24.0	18
26.5	1,560	n/a	n/a	14.2	n/a	18.0	n/a	1.37	0.89	450	32.0	26
30.0	2,500	n/a	n/a	17.7	n/a	22.0	n/a	1.50	1.00	360	36.0	30
MADD												
5.0	39	128.2	93.2	3.2	n/a	4.0	n/a	0.6	0.6	641	5.8	5
6.0	78	78.3	58.3	4.0	n/a	5.0	n/a	0.7	0.7	462	8.0	6
9.0	220	42.9	33.0	6.3	n/a	7.8	n/a	0.9	0.8	368	12.0	9
12.0	390	32.8	25.6	8.0	n/a	10.0	n/a	1.1	0.9	369	16.0	12
18.0	880	22.1	17.5	11.5	n/a	14.5	n/a	1.4	1.1	368	24.0	18
26.5	1,560	18.5	14.8	15.2	n/a	19.0	n/a	1.8	1.4	450	32.0	26
MAT												
5.0	50	112.1	82.2	2.7	0.75	3.5	3.00	0.22	0.14	500	5.8	5
6.0	98	69.9	52.9	3.5	0.55	4.5	2.04	0.28	0.18	367	8.0	6
9.0	220	47.4	35.3	5.3	0.36	6.8	1.36	0.54	0.35	368	12.0	9
12.0	390	35.8	26.6	7.0	0.27	9.0	1.03	0.63	0.41	369	16.0	12
18.0	880	24.0	17.9	10.5	0.16	13.5	0.68	0.91	0.59	368	24.0	18
26.5	1,560	19.8	14.7	14.2	0.13	18.0	0.50	1.37	0.89	450	32.0	26

Note 1: Coil resistance not directly measurable. Coil current should be within limits shown when tested at nominal voltage at 25°C for 5 seconds max.

Note 2: Set base current at 3 mA to 15 mA during measurements.

SPECIFYING A PART NUMBER EXAMPLE:	TYPE	TERMINALS	DIODES	GROUND PINS	COILS	SPREADER/MOUNTING PADS
	MA	C	D	G	-26	S

