

Lighting Contactors

Class 8903

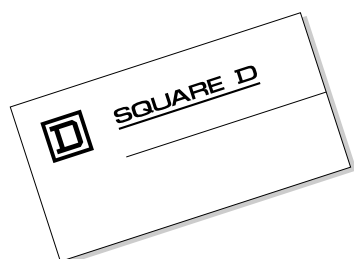
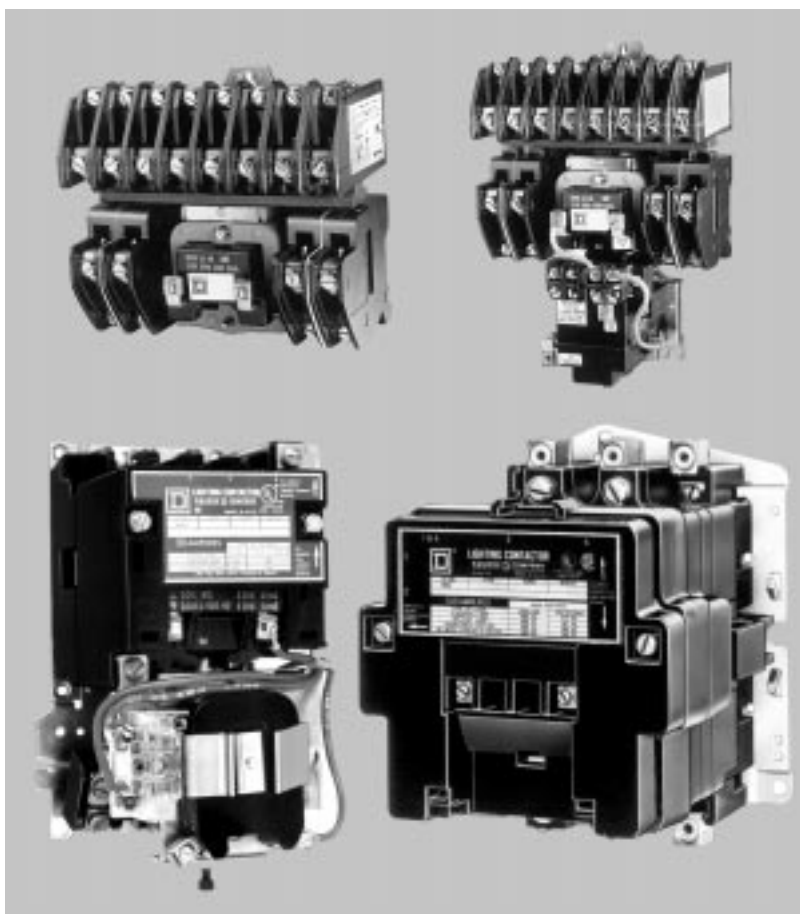

CONTENTS

Description	Page
Product Descriptions	2
modifications (Forms)	8
Application Data	11
Specifications	13
Approximate Dimensions	14



SQUARE D
GROUPE SCHNEIDER

Lighting Control

Class 8903 – Multipole Lighting Contactors, Type L & LX



Type L



Type LX

Features

- 30 Amp ballast lighting rating, 20 Amp tungsten lighting rating
- Electrically and mechanically held
- 2 thru 12 pole versions
- Field-convertible contacts with N.O. and N.C. indicators (8 N.C. contacts maximum▼)
- Silver-Cadmium-Oxide double break contacts



File E78427
CCN NRNT



File LR60905 (Open Devices Only)
Class 3211 07

Multipole Lighting Contactors (50-60 Hz)

Contact Ampere Ratings	No. of Poles	NEMA Type 1 General Purpose Enclosure	NEMA Type 1 Flush Mounting General Purpose Enclosure with Plaster Adjustment	NEMA Type 3R Rainproof Enclosure	NEMA Type 4 & 4X Watertight, Dusttight and Corrosion-Resistant Glass-Polyester Enclosure	▲NEMA Type 4 & 4X Watertight, Dusttight Brushed Stainless Steel Enclosure	NEMA Type 12‡ Dusttight and Driptight Industrial Use Enclosure	Open Type●
		Type	Type	Type	Type	Type	Type	Type
Electrically Held■								
30▼	2	LG20*	LF20*	LH20*	LWW20*	LW20*	LA20*	LO20*
	3	LG30*	LF30*	LH30*	LWW30*	LW30*	LA30*	LO30*
	4	LG40*	LF40*	LH40*	LWW40*	LW40*	LA40*	LO40*
	6	LG60*	LF60*	LH60*	LWW60*	LW60*	LA60*	LO60*
	8	LG80*	LF80*	LH80*	LWW80*	LW80*	LA80*	LO80*
10	LG1000*	LF1000*	LH1000*	LWW1000*	LW1000*	LA1000*	LO1000*	
12	LG1200*	LF1200*	LH1200*	LWW1200*	LW1200*	LA1200*	LO1200*	
Mechanically Held■								
30▼	2	LXG20*	LXF20*	LXWW20*	LXW20*	LXA20*	LXO20*
	3	LXG30*	LXF30*	LXWW30*	LXW30*	LXA30*	LXO30*
	4	LXG40*	LXF40*	LXWW40*	LXW40*	LXA40*	LXO40*
	6	LXG60*	LXF60*	LXWW60*	LXW60*	LXA60*	LXO60*
	8	LXG80*	LXF80*	LXWW80*	LXW80*	LXA80*	LXO80*
10	LXG1000*	LXF1000*	LXWW1000*	LXW1000*	LXA1000*	LXO1000*	
12	LXG1200*	LXF1200*	LXWW1200*	LXW1200*	LXA1200*	LXO1200*	

‡ NEMA Type 12 enclosures may be field modified for outdoor applications. For details, see the Class 9991 section in Catalog 9999CT9701.
 ● Separate enclosures are available for these devices. It may be possible to improve delivery by ordering an open type contactor and separate Class 9991 enclosure.
 ▲ For electropolished finish, specify Form G16.
 * Coil voltage code must be specified to order this product. Refer to standard voltage codes listed below.
 ▼ Factory conversion of N.O. contacts to N.C., order by description. There is a maximum of eight N.C. poles for Type L and a maximum of six N.C. poles for Type LX contactors (field conversion only). Versions are available with up to 12 N.C. poles (factory only).
 ■ All lighting contactors are provided with separate control as standard.

Power Poles for Type L or LX

The kits below are used to add 30 Ampere power poles to existing Type L contactors when additional circuits are required. Type L lighting contactors are supplied with mounting brackets, so that adder poles may be mounted from the front by a single captive screw. Adder poles are supplied standard with N.O. contacts which are convertible to N.C.

Power Pole Adder Kit	Can Only Be Added to Contactor Type	Power Pole Adder Kit	Can Only Be Added to Contactor Type
Class 8903 Type		Class 8903 Type	
Single Pole		Double Pole	
L1L	LO60 LO80 LXO60 LXO80	L3L	LO80 LO1000★ LXO80 LXO1000★
L1R		L3R	

★ Single-pole power pole must be removed before double-pole power pole can be installed.

Coil Voltage Codes

Voltage		Code
60 Hz	50 Hz	
24	...	V01
120	110	V02
208	...	V08
240	220	V03
277	...	V04
480	440	V06
Specify	Specify	V99

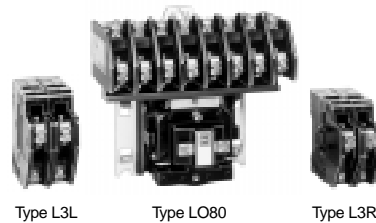

Type L3L Type LO80 Type L3R

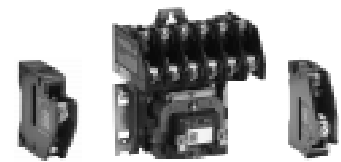

Type L1L Type LO60 Type L1R



Lighting Control

Multipole Lighting Contactors, Type S – Class 8903

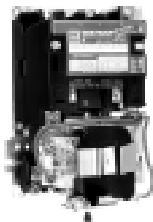

Features

- Electrically and mechanically held
- 30 - 800 Amp lighting ratings
- 2 thru 5 pole versions (5 poles thru 200 Amps)
- UL Listed short-circuit rating up to 100,000 Amperes
- Mixed load ratings (lighting and motor)
- Factory wired controls and clearly marked termination points
- Quick ship on most items in 5-7 days

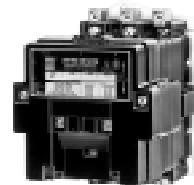

Multipole Lighting Contactors – Type S (50-60 Hz)

Contact Ampere Ratings	No. of Poles	NEMA Type 1 General Purpose Enclosure	NEMA Type 1 Flush Mounting General Purpose Enclosure with Plaster Adjustment	NEMA Type 3R Rainproof Enclosure	NEMA Type 4 & 4X Watertight, Dusttight and Corrosion-Resistant Glass-Polyester Enclosure	NEMA Type 4 & 4X▲ Watertight and Dusttight Enclosure	NEMA Type 12‡ Dusttight and Driptight Industrial Use Enclosure	Open Type
		Type	Type	Rainproof Enclosure Type	Type	Type	Type	Type
Electrically Held▼								
30	2	SMG1*	SMF1*	SMH1*	SMW21*	SMW1*	SMA1*	SMO1*●
	3	SMG2*	SMF2*	SMH2*	SMW22*	SMW2*	SMA2*	SMO2*●
	4	SMG3*	SMF3*	SMH3*	SMW23*	SMW3*	SMA3*	SMO3*●
60	2	SPG1*	SPF1*	SPH1*	SPW21*	SPW1*	SPA1*	SPO1*●
	3	SPG2*	SPF2*	SPH2*	SPW22*	SPW2*	SPA2*	SPO2*●
	4	SPG3*	SPF3*	SPH3*	SPW23*	SPW3*	SPA3*	SPO3*●
100	2	SQG1*	SQF1*	SQH1*	SQW21*	SQW1*	SQA1*	SQO1*●
	3	SQG2*	SQF2*	SQH2*	SQW22*	SQW2*	SQA2*	SQO2*●
	4	SQG3*	SQH3*	SQW3*	SQA3*	SQO3*●
200	2	SVG1*	SVH1*	SVW1*	SVA1*	SVO1*
	3	SVG2*	SVH2*	SVW2*	SVA2*	SVO2*
	4	SVG3*	SVW3*	SVA3*	SVO3*
300	2	SXG1*	SXW1*	SXA1*	SXO1*
	3	SXG2*	SXW2*	SXA2*	SXO2*
	4	SYG1*	SYW1*	SYA1*	SYO1*
400■	2	SYG2*	SYW2*	SYA2*	SYO2*
	3	SZG1*	SZW1*	SZA1*	SZO1*
	4	SZG2*	SZW2*	SZA2*	SZO2*
600■	2	SJG1*	SJW1*	SJA1*	SJO1*
	3	SJG2*	SJW2*	SJA2*	SJO2*
	4
800■	2
	3
	4
Mechanically Held▼								
30	2	SMG10*	SMF10*	SMW31*	SMW10*	SMA10*	SMO10*●
	3	SMG11*	SMF11*	SMW32*	SMW11*	SMA11*	SMO11*●
	4	SMG12*	SMF12*	SMW33*	SMW12*	SMA12*	SMO12*●
60	2	SPG10*	SPF10*	SPW31*	SPW10*	SPA10*	SPO10*●
	3	SPG11*	SPF11*	SPW32*	SPW11*	SPA11*	SPO11*●
	4	SPG12*	SPF12*	SPW33*	SPW12*	SPA12*	SPO12*●
100	2	SQG10*	SQF10*	SQW31*	SQW10*	SQA10*	SQO10*●
	3	SQG11*	SQF11*	SQW32*	SQW11*	SQA11*	SQO11*●
	4	SQG12*	SQW12*	SQA12*	SQO12*●
200	2	SVG10*	SVW10*	SVA10*	SVO10*
	3	SVG11*	SVW11*	SVA11*	SVO11*
	4	SVG12*	SVW12*	SVA12*	SVO12*
300	2	SXG13*	SXW13*	SXA13*	SXO13*
	3	SXG14*	SXW14*	SXA14*	SXO14*
	4	SYG16*	SYW16*	SYA16*	SYO16*
400	2	SYG17*	SYW17*	SYA17*	SYO17*
	3	SZG18*	SZW18*	SZA18*	SZO18*
	4	SZG19*	SZW19*	SZA19*	SZO19*
600	2	SJG10*	SJW10*	SJA10*	SJO10*
	3	SJG11*	SJW11*	SJA11*	SJO11*
	4
800	2
	3
	4

- ‡ NEMA Type 12 enclosures may be field modified for outdoor applications or NEMA Type 3R separate enclosures can be ordered. See the Class 9991 Section in Catalog 9999CT9701.
- Separate enclosures are available for these devices. It may be possible to improve delivery by ordering an open type contactor and separate Class 9991 enclosure.
- ▲ NEMA Type 4 & 4X enclosures are brush finished stainless steel for contactors sized 30 Amp thru 300 Amp. Sizes 400 Amp thru 800 Amp are painted sheet steel. For electropolished finish, specify Form G16.
- Form F4T is provided as standard; include line voltage when ordering. Control voltage is 120-60.
- * Voltage code must be specified to order this product. Refer to standard voltage codes below.
- ▼ All lighting contactors are provided with separate control as standard.

Coil Voltage Codes

Voltage		Code
60 Hz	50 Hz	
24♦	...	V01
120	110	V02
208	...	V08
240	220	V03
277	...	V04
480	440	V06
Specify	Specify	V99

♦ 24 volt coils are not available for 200 Amp thru 800 Amp devices. Contact local Square D Field Sales Office for additional information.

Poles for Type S Only

A single-pole or double-pole kit can be added to any 2 or 3 pole 30 or 60 Ampere Type S lighting contactor to make a 4 or 5 pole device. Factory assembled 4 and 5 pole contactors utilize the basic 3 pole device with a single or double-pole kit installed. Only one power pole can be added per contactor. Sufficient room is provided in all enclosure styles for the addition of a power pole kit.

Ampere Rating	Description	Class 9999 Type
30	One N.O.	SB6
	One N.C.	SB7
	One N.O. and One N.C.	SB8
	Two N.O.	SB9
	Two N.C.	SB10
60	One N.O.	SB21
	One N.C.	SB22*
	One N.O. and One N.C.	SB23*
	Two N.O.	SB24*
	Two N.C.	SB25*

* When power pole is added to 60 A contactor, a 4-pole coil is also required. Order from Coil Table in Catalog 9999CT9701. 60 A power poles are suitable for use with copper or aluminum wire.



Lighting Control

Class 8903 – Combination Lighting Contactors, Type S

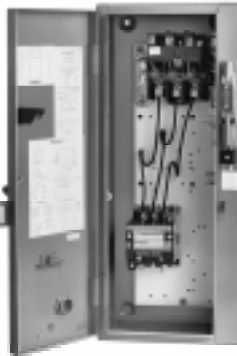

It is desirable to install the branch-circuit protective device and lighting contactor, combining switching and over-current protection, in one enclosure. Combination lighting contactors are well suited for industrial, highway and area lighting applications, or where a lighting circuit may have to be disconnected for periodic maintenance. They may also be used for resistance heating loads.

Features

The features include: disconnect switch and circuit breaker versions; rugged flange-mounted handle; easy installation; occupation of less space; increased operator protection; room to spare for modifications; Class R fuse clips standard; electrically and mechanically held; 30–600 Amperes.

Fusible or Non-Fusible Disconnect Switch (3-Pole, 50-60 Hz)

Contactor Ampere Rating	Fuse Clip Size (Amps)	Fuse Clip Spacing (Volts)	NEMA Type 1 General Purpose Enclosure	NEMA Type 4 & 4X ▲ Watertight and Dusttight Enclosure Stainless Steel	NEMA Type 12‡ Dusttight, Oiltight, Driptight, Industrial Use Enclosure
			Type	Type	Type
Electrically Held■					
30	None	SMG60*	SMW60*	SMA60*
	30	600	SMG61*	SMW61*	SMA61*
	30	250	SMG62*	SMW62*	SMA62*
60	None	SPG60*	SPW60*	SPA60*
	60	600	SPG61*	SPW61*	SPA61*
	60	250	SPG62*	SPW62*	SPA62*
100	None	SQG60*	SQW60*	SQA60*
	100	600	SQG61*	SQW61*	SQA61*
	100	250	SQG62*	SQW62*	SQA62*
200	None	SVG60*	SVW60*	SVA60*
	200	600	SVG61*	SVW61*	SVA61*
	200	250	SVG62*	SVW62*	SVA62*
300	None	SXG60*	SXW60*	SXA60*
	400	600	SXG61*	SXW61*	SXA61*
	400	250	SXG62*	SXW62*	SXA62*
Mechanically Held■					
30	None	SMG70*	SMW70*	SMA70*
	30	600	SMG71*	SMW71*	SMA71*
	30	250	SMG72*	SMW72*	SMA72*
60	None	SPG70*	SPW70*	SPA70*
	60	600	SPG71*	SPW71*	SPA71*
	60	250	SPG72*	SPW72*	SPA72*
100	None	SQG70*	SQW70*	SQA70*
	100	600	SQG71*	SQW71*	SQA71*
	100	250	SQG72*	SQW72*	SQA72*
200	None	SVG70*	SVW70*	SVA70*
	200	600	SVG71*	SVW71*	SVA71*
	200	250	SVG72*	SVW72*	SVA72*
300	None	SXG70*	SXW70*	SXA70*
	400	600	SXG71*	SXW71*	SXA71*
	400	250	SXG72*	SXW72*	SXA72*

Circuit Breaker (3-Pole, 50-60 Hz)

Contactor Ampere Rating	Circuit Breaker		NEMA Type 1 General Purpose Enclosure	NEMA Type 4 & 4X▲ Watertight and Dusttight Enclosure Stainless Steel (30-300 Amp)	NEMA Type 12‡ Dusttight, Oiltight, Driptight, Industrial Use Enclosure
	Ampere Rating	Maximum Volts	Type	Type	Type
Electrically Held■					
30	30	600	SMG81*	SMW81*	SMA81*
	30	240	SMG82*	SMW82*	SMA82*
60	60	600	SPG81*	SPW81*	SPA81*
	60	240	SPG82*	SPW82*	SPA82*
100	100	600	SQG81*	SQW81*	SQA81*
200	200	600	SVG81*	SVW81*	SVA81*
300	300	600	SXG81*	SXW81*	SXA81*
400♦	400	600	SYG81*	SYW81*	SYA81*
600♦	600	600	SZG81*	SZW81*	SZA81*
Mechanically Held■					
30	30	600	SMG91*	SMW91*	SMA91*
	30	240	SMG92*	SMW92*	SMA92*
60	60	600	SPG91*	SPW91*	SPA91*
	60	240	SPG92*	SPW92*	SPA92*
100	100	600	SQG91*	SQW91*	SQA91*
200	200	600	SVG91*	SVW91*	SVA91*
300	300	600	SXG91*	SXW91*	SXA91*
400	400	600	SYG91*	SYW91*	SYA91*
600	600	600	SZG91*	SZW91*	SZA91*

♦ Form F4T is standard; Include line voltage when ordering. Control voltage is 120V/60 Hz.

▲ For NEMA Type 4 & 4X Watertight, Dusttight and Corrosion-Resistant Glass-Polyester enclosure pricing, multiply stainless steel enclosed price by 1.25 and add Form G18 (limited to 100 Amp max.). 400 & 600 Amp enclosures are painted sheet steel (NEMA Type 4 & 4X).

‡ NEMA Type 12 enclosures may be field modified for outdoor applications. See the Class 9991 section in Catalog 9999CT9701.

■ All lighting contactors are provided with separate control as standard.

* Coil voltage codes must be specified to order this product. Refer to standard voltage codes shown to the left.



File E16151
CCN NRNT

and

Coil Voltage Codes

Voltage		Code
60 Hz	50 Hz	
24♦	...	V01
120	110	V02
208	...	V08
240	220	V03
277	...	V04
480	440	V06
Specify	Specify	V99

♦ 24 volt coils are not available for 200 Amp devices. Contact local Square D Field Sales Office for additional information.



NIGHT-MASTER™ Combination Lighting Contactors – Class 8903

NIGHT-MASTER Outdoor Combination Lighting Contactors offer disconnecting means, overcurrent protection and a lighting contactor in one NEMA Type 3R Rainproof enclosure. These combination units satisfy requirements of the National Electrical Code and UL 508 for service entrance equipment.



Long Version

Features:

- Solid neutral standard
- Grounding lug standard
- Padlocking provisions
- Short and long versions available
- Electrically held Type S lighting contactor
- Eliminates the need for separate time clocks and safety switches



Disconnect Switch Type▼ (3-Pole)

Contactor Ampere Rating	Fuse Clip Size (Amperes)	Fuse Clip Spacing (Volts)	Short Version	Long Version
			Class 8903 Type	Class 8903 Type
30	30	600	SMC61*	SMC63*
	30	250	SMC62*	SMC64*
60	60	600	SPC61*	SPC63*
	60	250	SPC62*	SPC64*
100	100	600	SQC61*	SQC63*
	100	250	SQC62*	SQC64*
200	200	600	SVC61*	SVC63*
	200	250	SVC62*	SVC64*



Short Version

Circuit Breaker Type▼ (3-Pole)

Contactor Ampere Rating	Circuit Breaker		Short Version	Long Version
	Ampere Rating	Maximum Volts	Class 8903 Type	Class 8903 Type
30	30	600	SMC81*	SMC83*
60	60	600	SPC81*	SPC83*
100	100	600	SQC81*	SQC83*
200	200	600	SVC81*	SVC83*

▼ All lighting contactors are provided with separate control as standard.

* Coil Voltage codes must be specified to order this product. Refer to standard voltage codes listed below.

UL Approved for Service Entrance

NIGHT-MASTER Combination Lighting Contactors

The Class 8903 NIGHT-MASTER Outdoor Combination Lighting Contactor is the only product on the market that is UL Listed for Service Entrance. This allows the contactor to be pole mounted when used to control lighting in remote locations such as parks, monuments, group sports facilities, and streets and highways.

Factory modifications such as photocells, time switches, key operated selector switches, and the combination of photocells and time switches (photocell on, time switch off) allow the NIGHT-MASTER to be located in applications where manual operation of lights is not practical.

NIGHT-MASTER comes in long and short versions in sizes 30 through 200 Amperes. Most common modifications can be provided from the factory, or added in the field to pre-drilled and pre-tapped panels.



File E16151
CCN NRNT

and



Coil Voltage Codes

Voltage		Code
60 Hz	50 Hz	
24▲	...	V01
120	110	V02
208	...	V08
240	220	V03
277	...	V04
480	440	V06
Specify	Specify	V99

▲ 24 volt coils are not available for 200 Amp devices. Contact local Square D Field Sales Office for additional information.



Lighting Control

Class 8903 – Panelboard Lighting Contactors, Type PB



General Information

Panelboard Lighting Contactors, sometimes called remote control switches, are designed for use with lighting panelboards and motor control centers where either panel or bus mounting is desirable. Type PB lighting contactors can be used in a retrofit or new project without increasing the panelboard depth. They can be used to directly replace many inoperative existing switches.

The features include: mechanically held; compatible with Square D panelboards; short-circuit ratings to 100 KA; compact arc suppression; bus or panel mounted; fits in standard-depth lighting panelboards; easy manual operation; standard coil clearing contacts; and the ability to operate in any position.

Class 8903 Type PB Lighting Contactors

Description		Bus Mount	Panel Mount
Amp Size	Poles	Type	Type
30	2	PBM 10B*	PBM 10*
	3	PBM 11B*	PBM 11*
60	2	PBP 10B*	PBP 10*
	3	PBP 11B*	PBP 11*
75	2	PBN 10B*	PBN 10*
	3	PBN 11B*	PBN 11*
100	2	PBQ 10B*	PBQ 10*
	3	PBQ 11B*	PBQ 11*
150	2	PBR 10B*	PBR 10*
	3	PBR 11B*	PBR 11*
200	2	PBV 10B*	PBV 10*
	3	PBV 11B*	PBV 11*
225	2	PBW 10B*	PBW 10*
	3	PBW 11B*	PBW 11*

* Voltage code must be specified to order this product. Refer to standard voltage codes listed below.



File E78427
CCN NRNT



LR 60905
Class 3231 01

AC Coil Voltage Codes

60 Hz	Voltage Code
120/208	V38
240/277	V39
480	V28

Maximum Wire Size

Current Range	Power Wire (CU/AL)	Control Wire (CU Only)
30-100 Amps	1/0 Max.	#18 - #10
150-225 Amps	350 MCM Max.	#18 - #10

Factory Modifications

Form	Description
X11	(1) Auxiliary Contacts SPDT
X22	(2) Auxiliary Contacts SPDT

Wire Gauge AWG	Distance (feet)				
	120V	208V	240V	277V	480V
#14	550	1650	2200	2925	8800
#12	900	2700	3600	4700	14400
#10	1425	4275	5700	7550	22800

Short-Circuit Ratings

RMS Sym. Current (Amp)	Max. Volts	Short Circuit Protection Device Recommended
100,000	600	Class J Fuses
22,000	600	Circuit Breaker - Square D - Type LHL
65,000	240	Circuit Breaker - Square D - Type LHL

Dimensions (Panel Mount)

Amps	Dimensions Inches (mm)						
	H	W	D	A	B	C	E
30-100	11.75 (298)	7.50 (191)	3.88 (98)	2.25 (57)	7.38 (187)	2.25 (57)	9.25 (234)
150-225	14.50 (368)	7.50 (191)	3.88 (98)	2.88 (73)	8.50 (216)	3.00 (76)	10.50 (266)

Dimensions (Bus Mount)

Amps	Dimensions Inches (mm)				
	H	W	D	A	B
30-100	8.31 (211)	7.50 (191)	3.38 (86)	2.25 (57)	7.38 (187)
150-225	9.50 (241)	7.50 (191)	3.38 (86)	2.88 (73)★	8.50 (216)

★ Slotted mounting holes suitable for 2.88 to 3.19 in. (73 to 81 mm) mounting centers.

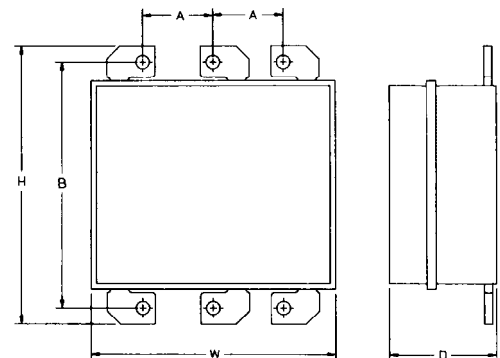
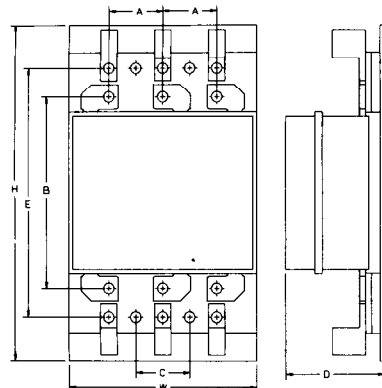

Lighting Control

Lighting Transfer Switches, Type REQ – Class 8903



REQ 2815-G2

Electrically Held ♦

Amperes	Poles	Open Type Catalog Number	NEMA Type 1 † Enclosed Catalog Number
30	2 pole / 2 pole	8903REQ2814-G1	8903REQ2814-G7
	3 pole / 3 pole	8903REQ2814-G2	8903REQ2814-G8
	4 pole / 4 pole	8903REQ2814-G3	8903REQ2814-G9
60	2 pole / 2 pole	8903REQ2815-G1	8903REQ2815-G7
	3 pole / 3 pole	8903REQ2815-G2	8903REQ2815-G8
	4 pole / 4 pole	8903REQ2815-G3	8903REQ2815-G9
100	2 pole / 2 pole	8903REQ2816-G1	8903REQ2816-G7
	3 pole / 3 pole	8903REQ2816-G2	8903REQ2816-G8
	4 pole / 4 pole	8903REQ2816-G3	8903REQ2816-G9
150	2 pole / 2 pole	8903REQ2817-G1	8903REQ2817-G7
	3 pole / 3 pole	8903REQ2817-G2	8903REQ2817-G8
	4 pole / 4 pole	8903REQ2817-G3	8903REQ2817-G9

♦ UL Recognized as "Components – Automatic Transfer Switches For Use In Option Stand – By Systems" only.
 † NEMA Type 1 devices are not UL1008 Recognized.

Open Type Only

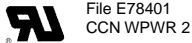

File E78401
CCN WPWR 2

Mechanically Held ▲

Amperes	Poles	Open Type Catalog Number	NEMA Type 1 † Enclosed Catalog Number
30	2 pole / 2 pole	8903REQ2814-G4	8903REQ2814-G10
	3 pole / 3 pole	8903REQ2814-G5	8903REQ2814-G11
	4 pole / 4 pole	8903REQ2814-G6	8903REQ2814-G12
60	2 pole / 2 pole	8903REQ2815-G4	8903REQ2815-G10
	3 pole / 3 pole	8903REQ2815-G5	8903REQ2815-G11
	4 pole / 4 pole	8903REQ2815-G6	8903REQ2815-G12
100	2 pole / 2 pole	8903REQ2816-G4	8903REQ2816-G10
	3 pole / 3 pole	8903REQ2816-G5	8903REQ2816-G11
	4 pole / 4 pole	8903REQ2816-G6	8903REQ2816-G12
150	2 pole / 2 pole	8903REQ2817-G4	8903REQ2817-G10
	3 pole / 3 pole	8903REQ2817-G5	8903REQ2817-G11
	4 pole / 4 pole	8903REQ2817-G6	8903REQ2817-G12
225	2 pole / 2 pole	8903REQ2818-G1	8903REQ2818-G3
	3 pole / 3 pole	8903REQ2818-G2	8903REQ2818-G4
260	2 pole / 2 pole	8903REQ2819-G1	8903REQ2819-G3
	3 pole / 3 pole	8903REQ2819-G2	8903REQ2819-G4
400	2 pole / 2 pole	8903REQ2820-G1	8903REQ2820-G3
	3 pole / 3 pole	8903REQ2820-G2	8903REQ2820-G4
600	2 pole / 2 pole	8903REQ2821-G1	8903REQ2821-G3
	3 pole / 3 pole	8903REQ2821-G2	8903REQ2821-G4
800	2 pole / 2 pole	8903REQ2822-G1	8903REQ2822-G3
	3 pole / 3 pole	8903REQ2822-G2	8903REQ2822-G4

▲ UL Recognized as "Components – Automatic Transfer Switches For Use In Option Stand – By Systems".
 † NEMA Type 1 devices are not UL1008 Recognized.



Lighting Control

Class 8903 – Modifications (Forms)

Description	Form Letter	NEMA Enclosure Type	Used On				NIGHT-MASTER® ①
			Std.		Combo		
			Elec. Held	Mech. Held	Elec. Held	Mech. Held	
"On-off" (momentary contact) push button	A3	1		*		*	
	A3	3R, 4, 12		*		*	
"On-off" push button (with holding circuit interlock)	A12	Any	*		*		*
"HAND-OFF-AUTO" selector switch. For key operator, add Form C33, i.e. CC33	C	1	*	*	*	*	
	C	3R, 4, 12	*	*	*	*	*
"On-off" selector switch. For key operator, add Form C33, i.e. C6C33	C6	1	*	*	*	*	
	C6	3R, 4, 12	*	*	*	*	*
Control circuit fuse (1 fuse)	F	Any	*	*	*	*	*
Control circuit fuses (2 fuses)	F4	Any	*	*	*	*	*
Control circuit transformer standard capacity 50/60 Hz	F4T	Any	*	*	*	*	*
Primary (Fuses) Secondary							
2 100 Cap. 0 ③, ④ for 300 A	FF4T	Any	*	*	*	*	*
2 100 VA Add. Cap. 1 ④ for 200 and 300 A	FF4T11	Any	*	*	*	*	*
2 200 VA Add. Cap. 1 ④ for 100, 200 and 300 A	FF4T12	Any	*	*	*	*	*
2 300 VA Add. Cap. 1 ④ for 30 to 300 A	FF4T13	Any	*	*	*	*	*
Noise reduced enclosure and shock mounted panel	G4	Any		*		*	
Addition of photoelectric receptacle	G10	1, 3R, 12	*		*		*
Addition of photoelectric receptacle with photo-cell	G101	1, 3R, 12	*		*		*
Addition of photoelectric receptacle and relay (R6)	G10R6	1, 12		*		*	
With photo-cell installed	G101R6	1, 12		*		*	
Addition of terminal blocks (other than standard). "xx" Represents the number of terminals needed.	G50xx	Any					
(PER TERMINAL PRICE) WIRED			*	*	*	*	*
(PER TERMINAL PRICE) UNWIRED			*	*	*	*	*
Bracketing for internally mounted pilot device	G53	Any	*	*	*	*	*
Addition of 24 hour time clock (120-277v only)	K14	1, 4, 12	*	*	*	*	*
Addition of 24 hour time clock w/day omission (120-277v)	K141	1, 4, 12	*	*	*	*	*
Addition of 7 day time clock (120-277v)	K142	1, 4, 12	*	*	*	*	*
Addition of 8865 TC12 lighting controller to lighting contactors of any size. REQUIRES A 24V 60 Hz CONTROL CIRCUIT.	K143	1, 4, 12	*	*			
Addition of 24 hour time clock (120-277v only)	K14	3R					*
Addition of 24 hr time clock w/skip day (120-277v)	K141	3R					*
Addition of 7 day time clock (120-277v)	K142	3R					*
Addition of solid neutral terminal block	N	1, 4, 12	*	*	*	*	Std.
Red Pilot Light	P1	Any	*	*	*	*	*
Two or more lights ⑥ (each)	P	Any	*	*	*	*	*
Red Push To Test Pilot Light	P21	Any	*	*	*	*	*
Interlock necessary for pilot light one needed for each additional pilot light	②, ⑦	Any	*	*	*	*	*
Two Wire Interface for Mechanically held	R6	Any		*		*	
Three wire control for long distance applications.	R62	Any		*		*	
Auxiliary contacts (specify number of N.O. + N.C.)	X ⑦	Any	*	*	*	*	*
Addition of DC coil to Type L (7 poles max)	Y48	Any	*				
Auxiliary electrical interlock installed on disconnect switch or circuit breaker operating mechanism	Y74	Any			*	*	*
Coil Transient suppressor (120Vac Only)	Y145	Any	*		*		*
Coil Transient suppressor (120Vac Only)	Y145	Any		*		*	*
Addition of lightning arrester	Y1532	3R, 4, 12	*	*	*	*	*
Substitute copper only lugs for standard	Y157	Any	*	*	*	*	*
Substitute Anderson VC crimp style lugs for standard – per lug adder – specify lug	Y1574	Any	*	*	*	*	*
Addition of under and overvoltage relay	Y449	Any	*	*	*	*	*
Multiple contactors in common enclosure "xx" = number of contactors needed ⑤	Y10XX	1, 4, 12	*	*			

* Available.

① NIGHT-MASTER maximum 200 Amps, minimum 30 Amps.

② DO NOT use Form X for any interlock which is wired in series with pilot light, but DO specify how pilot light and interlock are to be wired into the circuit.

③ Not required on 400 A through 800 A electrically held versions only, which have a control circuit requiring a 120V secondary; therefore, a transformer is supplied. The transformer comes wired to L1 and L2 unless Form "S" is called for. It is supplied with two primary and one secondary fuse.

④ Single primary voltage must be specified using the codes shown below:

Voltage 60 Hz	Code
120-24	V89
208-120	V84
240-24	V82
240-120	V80
277-120	V85
480-24	V83
480-120	V81
480-240	V87
600-120	V86

⑤ Limited to 16 contactors thru 60 Amps, 4 contactors thru 200 Amps.

⑥ For electrically-held enclosed devices, the first pilot is wired in parallel with the coil. Operating interlocks are required for all additional pilot lights. Mechanically held devices require operating interlocks for all pilot lights.

⑦ Electrically held 20 Amp multipole contactors cannot add interlocks. Additional poles can be used for the same function, however. Mechanically held (Type LX) provide one double throw auxiliary (or status) contact as standard.

Order Example

You have previously selected a Class 8903SMG2V02. V02 means that you need a coil voltage of 120-60/110-50 wired for separate control. You would like to add form FF4T with the transformer voltages being 480 volt primary, 120 volt secondary.

The new and complete Class, Type, Voltage Code and Form number:

Class 8903 Type SMG2 VoltageCode V81 Form♦ FF4T

♦ Form numbers should always be shown in alphabetical order.



Lighting Control Field Modifications – Class 8903

Description	Types L & LX		Type S					Form No.
	30 Amp	30 Amp	60 Amp	100 Amp	200 Amp	300 Amp	400, 600, 800 Amp	
	Kit	Kit	Kit	Kit	Kit	Kit	Kit	
AUXILIARY CONTACTS								
1 N.O. LH or RH Mounting	9999 SX6	9999 SX6	9999 SX6	9999 SX6	9999 SX6	9999 SX6	X
1 N.C. LH or RH Mounting	9999 SX7	9999 SX7	9999 SX7	9999 SX7	9999 SX7	9999 SX7	
1 N.C. & 1 N.O. Isolated LH or RH	9999 SX8	9999 SX8	9999 SX8	9999 SX8	9999 SX8	9999 SX8	
1 N.O. Overlapping LH or RH	9999 SX9	9999 SX9	9999 SX9	9999 SX9	9999 SX9	9999 SX9	
1 N.C. Overlapping LH or RH	9999 SX10	9999 SX10	9999 SX10	9999 SX10	9999 SX10	9999 SX10	
CONTROL CIRCUIT FUSE HOLDER								
Single Fuse Unit	9999 LLX and 9999 SFR3	9999 SFR3	9999 SFR3	9999 SFR3	9999 SFR3	9999 SFR3	9999 SFR3	F
Two Fuse Unit	9999 LLX and 9999 SFR4	9999 SFR4	9999 SFR4	9999 SFR4	9999 SFR4	9999 SFR4	9999 SFR4	F4
TRANSFORMERS (For Prices See Class 9070 Section)	9070 T50	9070 T100	9070 T100	9070 T300	9070 T300	9070 T500	9070 T750	T
OVERSIZED ENCLOSURES (Non-Combo)								
NEMA 1	9991 SDG3	9991 SDG3	9991 SDG3
NEMA 4	9991 SDW3	9991 SDW3	9991 SDW3
NEMA 12	9991 SDA3	9991 SDA3	9991 SDA3
STANDARD ENCLOSURES								
NEMA 1 – Surface Mount	9991 LXG1	9991 SCG7①	9991 SDG7①	9991 SFG8	9991 SGG8
NEMA 3R	9991 SDH1	9991 SCH2	9991 SDH1	9991 SEH1	9991 SFH1
NEMA 4 – Standard	9991 SDW1	9991 SCW1	9991 SDW1
NEMA 4 – With 2 Cover Mtd. Closing Plates	9991 SDW11	9991 SCW11	9991 SDW11	9991 SEW11
NEMA 4X – Glass Polyester	9991 SDW20	9991 SCW20	9991 SDW20
NEMA 12	9991 SDA11	9991 SCA11	9991 SDA11	9991 SEA11
NEMA 1 – Flushmount – Complete	9991 SEF11
NEMA 1 – Flush Mount Parts
FLUSH PARTS								
Standard – Elec. held	9991 SDF13	9991 SCF11	9991 SDF11
– Mech. held	9991 SDF13	9991 SCF13	9991 SDF13
Mounting Strap	9991 SDF2	9991 SCF2	9991 SDF2
Pull Box	9991 SDF1	9991 SCF1	9991 SDF1
Internal Operator Mounting Bracket	30102-159-01	30102-159-01	30102-159-01	30102-159-01	30102-159-01	30102-159-01	30102-159-01	G53
Solid Neutral	9999 SN1	9999 SN1	9999 SN1	9999 SN1	9999 SN2	9999 SN2	9999 SN3③	N
(Combination Lighting Contactor Disconnect Interlock Kit)								
Breaker Type								Y74
1 Pole	9999 R26	9999 R26	9999 R26	9999 R26	9999 R26	9999 R26	
2 Pole	9999 R27	9999 R27	9999 R27	9999 R27	9999 R27	9999 R27	
Disconnect Type								
1 Pole	9999 R45	9999 R43	9999 R41	9999 R8	9999 R35	9999 R26	
2 Pole	9999 R46	9999 R44	9999 R42	9999 R9	9999 R36	9999 R27	
Lightning Arrestor 175Vac to Ground Max 2 or 3 wire Grounded	J9200-10	J9200-10	J9200-10	J9200-10	J9200-10	J9200-10	J9200-10	
650Vac to Ground Max 3 or 4 wire Grounded	J9200-9A	J9200-9A	J9200-9A	J9200-9A	J9200-9A	J9200-9A	J9200-9A	
Hardware 2 Pole	Not Needed	9999 AL 13	9999 AL 11	9999 AL 12	
3 Pole		9999 AL 14	9999 AL 11	9999 AL 12	
4 Pole		9999 AL 15	
Versa Crimp Lugs	
Range #8-1/0 AL/CU	VCEL02114S1	Y1532
#1-2/0 AL/CU	VCEL022516H1	
2/0-4/0 AL/CU	VCEL024516H1	
4-300 MCM AL/CU	VCEL030516H1	
2/0-500 MCM AL/CU	VCEL05012H1	
400-600 MCM AL	VCEL06012H1	
400-500 MCM CU	VCEL06012H1	
500-750 MCM AL	VCEL07512H1	
500 MCM CU	VCEL07512H1	
400-600 MCM AL	VCEL06012H2	
400-500 MCM CU	VCEL06012H2	
500-750 MCM AL	VCEL07512H2	
500 MCM CU	VCEL07512H2	
	VCEL07512H2	
	VCEL07512H2	
Relay Under and Over Voltage	8430 DWU	8430 DWU	8430 DWU	8430 DWU	8430 DWU	8430 DWU	8430 DWU	Y449

① For electrically held only.
 ② One or two lugs may be mounted on each terminal. Limited to 400 and 600 Amp versions. 800 Amp is factory modification only.
 ③ Limited to 400 and 600 Amp versions. 800 Amp is a factory modification only.



Lighting Control

Class 8903 – Field Modifications

Description	TYPE L & LX	TYPE S						Form No.	
	30 Amp	30 Amp	60 Amp	100 Amp	200 Amp	300 Amp	400, 600, 800 Amp		
	Kit	Kit	Kit	Kit	Kit	Kit	Kit		
Mechanically-Held	PUSH BUTTON (ON-OFF) NEMA Type 1 Enclosure	9999BLX & 9999LXPB	*	9001KA2 & 9999SA3▲	9001KA2 & 9999SA3▲	9001KA2 & 9999SA3▲	9001KA2 & 9999SA3▲	9001KA2 & 9999SA3▲	A3
	NEMA Type 3R, 4 or 12 Enclosure	9001KA2 & 9999SA3▲	9001KA2 & 9999SA3▲	9001KA2 & 9999SA3▲	9001KA2 & 9999SA3▲	9001KA2 & 9999SA3▲	9001KA2 & 9999SA3▲	9001KA2 & 9999SA3▲	
	SELECTOR SWITCH (2 POSITION) NEMA Type 1 Enclosure	9999BLX & 9999LXS	9001KN244 & 9001KS11BH1	9001KN244 & 9001KS11BH1	9001KN244 & 9001KS11BH1	9001KN244 & 9001KS11BH1	9001KN244 & 9001KS11BH1	9001KN244 & 9001KS11BH1	C6
	NEMA Type 3R, 4 or 12 Enclosure	9001KN244 & 9001KS11BH1	9001KN244 & 9001KS11BH1	9001KN244 & 9001KS11BH1	9001KN244 & 9001KS11BH1	9001KN244 & 9001KS11BH1	9001KN244 & 9001KS11BH1	9001KN244 & 9001KS11BH1	
	SELECTOR SWITCH (3 POSITION) NEMA 1 Enclosure (MUST INCLUDE TWO WIRE CONTROL RELAY (Form R6))	9999BLX & 9999SC2	-	-	-	-	-	-	C
	NEMA Type 3R, 4 or 12 Enclosure	9001KN260 & 9001KS46BH2	9001KN260 & 9001KS46BH2	9001KN260 & 9001KS46BH2	9001KN260 & 9001KS46BH2	9001KN260 & 9001KS46BH2	9001KN260 & 9001KS46BH2	9001KN260 & 9001KS46BH2	
TWO WIRE CONTROL RELAY (Form R6)	9999RLX CA2SK11_	8501X011	8501X011	8501X011	8501X011	8501X011	8501X011	R6	
Electrically-Held	PILOT LIGHTS (RED) NEMA Type 1 Enclosure NEMA Type 3R, 4 or 12 Enclosure	9999SP28R	9999SP2R 9999SP28R	9999SP3R 9999SP28R	◆ 9999SP14R 9999SP28R	★ 9999SP28R 9999SP28R	★ 9999SP28R 9999SP28R	9999SP28R 9999SP28R	P1
	PUSH BUTTONS● NEMA Type 1 Enclosure	9999BLX & 9999SA10	9999SA10	9999SA10	9999SA3	9999SA3	9999SA3	9999SA3	A12
	NEMA Type 3R, 4 or 12 Enclosure	9999SA3	9999SA3	9999SA3	9999SA3	9999SA3	9999SA3	9999SA3	
	SELECTOR SWITCH (2 POSITION) NEMA Type 1 Enclosure	9999BLX & 9999SC22	9999SC22	9999SC22	9999SC22	9001KN244 & 9001KS11BH1	9001KN244 & 9001KS11BH1	9001KN244 & 9001KS11BH1	C6
	NEMA Type 3R, 4 or 12 Enclosure	9001KN244 & 9001KS11BH1	9001KN244 & 9001KS11BH1	9001KN244 & 9001KS11BH1	9001KN244 & 9001KS11BH1	9001KN244 & 9001KS11BH1	9001KN244 & 9001KS11BH1	9001KN244 & 9001KS11BH1	
	SELECTOR SWITCH (3 POSITION) NEMA Type 1 Enclosure	9999BLX & 9999SC2	9999SC2	9999SC2	9999SC2	9999SC8	9999SC8	9999SC8	C
NEMA Type 3R, 4 or 12 Enclosure	9999SC8	9999SC8	9999SC8	9999SC8	9999SC8	9999SC8	9999SC8		

- * No field installed kit available.
- ▲ Mechanically-held contactors need two distinct signals to operate. If is necessary to add a N.O. contact block to the Class 9999 Type SA3 push button kit.
- ◆ Selection for 2 or 3 pole only; for 4 or 5 pole use Class 9999 SP15R.
- ★ The coil voltage must be the same as the pilot light rating. Kit contains one (1) Class 9001, Type KP1R6 120V/60Hz red pilot light control unit. For other voltages, refer to the Class 9001, Type KP Control Section.
- Requires holding circuit interlock or additional power pole on 20 Amp size.



Application of Lighting Contactors

Lighting contactors have evolved from the need for more than just simple on-off manual control of lights. Today's requirements call for the development of new and varied types of control. Often the application will call for remote control of lighting from some distant location. This control may or may not be in addition to a master control station at a central location. Certain applications include the use of automatic control by time clocks or photoelectric cells. Whatever the need may be, applications are increasing, and lighting contactors are designed to meet the ever-changing requirements.

Square D lighting contactors offer a time-proven design for better electrical and mechanical performance. They are used wherever reliable, convenient and economical control of indoor and outdoor lighting is required. Typical installations include:

- parking lots
- industrial plants
- office buildings
- theaters and auditoriums
- hospitals and institutions
- shopping centers
- stadiums
- airports

Tungsten Lamp Loads

Tungsten lamps have a positive resistance characteristic (resistance to the flow of electric current increases as its operating temperature increases), thus exhibiting an increase in resistance when the lamp is energized. Therefore, these lamps have a high inrush current of up to 18 times normal current resulting from the low cold resistance of the tungsten. Examples of tungsten lamps include incandescent lamps, iodine lamps, quartz-iodine lamps and infrared lamps.

Ballast Lighting Loads

A ballast lighting load consists of electric discharge (vapor) lamps. All types of vapor lamps possess a negative resistance characteristic. The resistance within the lamp decreases with an increase in current and vice-versa. Without some form of current limiting device in the electric circuit, the current would rise quickly until lamp failure occurred. This current limiting element is known as the ballast. A ballast is an impedance used to stabilize the current in a vapor lamp. It has the property of increasing in resistance as current through it increases and decreasing in resistance as current decreases. Thus it tends to maintain a constant current through it. Types of ballast lighting include high intensity discharge (HID) lamps – mercury vapor, metal halide and high pressure sodium – and fluorescent lamps.

Resistance Loads

Square D lighting contactors are fully rated for resistance loads up to 600 volts. They can be used on resistance-type boilers, electric furnaces, electric water heaters and snow melting cables and panels.

Motor Loads

These loads consist of motors having an inrush current, or locked-rotor current, of approximately six times the full-load current. Square D Type S lighting contactors are fully rated for motor loads and have a horsepower rating equal to the equivalent NEMA-Size motor contactor.

Lighting Contactors for Energy Management

Lighting contactors should be an integral part of any Energy Management System. They help conserve energy consumption and reduce utility bills by providing three types of control.

Lighting contactors offer both centralized and remote control of lighting. Circuits can be turned on and off from a number of remote locations in addition to a master control station.

They also offer selective switching of lights. Selective switching is the control of one or more individual lighting circuits, independent of the other circuits. This design allows the potential for turning on only the amount of lighting that is actually needed.

Lighting contactors can provide automatic control to insure that lights will be turned off when not needed. There are a number of devices that, when used with lighting contactors, offer a convenient and reliable method of automatically controlling lighting loads: program time clock, photoelectric cell, programmable controller and demand controller.

Installation of Lighting Contactors

For new installations, lighting contactors can either be installed right in the lighting panelboard, or in their own enclosure next to or remote from the panelboard.

In existing applications where the lighting control system is being updated, lighting contactors can be installed in their own enclosure next to a lighting panelboard.

Compression Lugs

Square D Versa-Crimp® compression lugs for Type S lighting contactors, 100–800 amperes, are available factory installed (Form Y157-4) or as a field modification kit (see table on page 9). They are suitable for both copper and aluminum wire.

One VCEL lug (one or two on the 400 and 600 amperes devices) is required for each line or load terminal. Each Class 9999 Type AL hardware kit includes mounting hardware for 3 terminals, line or load side.

EXAMPLE: To install compression lugs on a 300 ampere 3 pole device, line and load sides, order six (6) VCEL-060-12H1 lugs and two (2) Class 9999 Type AL11 hardware kits.

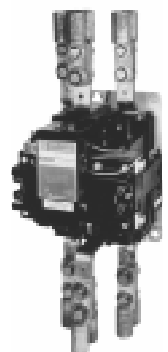

Lighting Control

Class 8903 – Application Data

Maximum Voltage Rating

When selecting lighting contactors, the maximum voltage rating of the device must be considered in addition to its current rating. The table below lists the maximum ac voltage ratings of the Types L and S lighting contactors for ballast, tungsten and resistance loads. Lighting contactors also have dc ratings which are shown below.

AC Voltage Ratings

Type of Load	Types L & LX 30 Amperes		Type SM 30 Amperes		Types SP, SQ, SV & SX 60-300 Amperes		Types SY, SZ & SJ 400-800 Amperes	
	When Connected 1 Pole to Load	When Connected 2 Poles to Load on 1PH and 3 Poles to Load on 3PH	When Connected 1 Pole to Load	When Connected 2 Poles to Load on 1PH and 3 Poles to Load on 3PH	When Connected 1 Pole to Load	When Connected 2 Poles to Load on 1PH and 3 Poles to Load on 3PH	When Connected 1 Pole to Load	When Connected 2 Poles to Load on 1PH and 3 Poles to Load on 3PH
Tungsten	20 Amp 277 Vac	480 Vac	277 Vac	480 Vac	277 Vac	480 Vac
Ballast	277 Vac▲	480 Vac▲	347 Vac	600 Vac	347 Vac	600 Vac	347 Vac	600 Vac
Resistance	600 Vac	600 Vac	600 Vac	600 Vac	600 Vac	600 Vac	600 Vac	600 Vac
Control Circuit (Coil) Voltage	Type L 12-600 Vac; 24, 32, 48, 115/125, 230/250 Vdc Type LX 24-600 Vac		6-600 Vac		6-600 Vac Type SP 24-600 Vac Types SQ & SV 120-600 Vac Type SX		120-600 Vac	

▲ Types L and LX contactors also have a ballast lamp rating of 15 Amperes 347 Vac when connected 1 Pole to Load and 600Vac when connected 2 Poles to Load on 1PH and 3 Poles to Load on 3PH.
NOTE: 600 Ampere devices are derated to 540 Amperes for resistance heating loads when aluminum wire is used.

DC Voltage Ratings for Tungsten Lamp or Resistance Loads Only

Type of Load	Types L & LX 20 Amperes	Type SM 30 Amperes	Types SP, SQ, SV & SX 60-300 Amperes	Types SY, SZ, & SJ 400-800 Amperes
DC with 2 Poles in Series	125 Vdc	125 Vdc	250 Vdc
DC with 3 Poles in Series	250 Vdc	250 Vdc	250 Vdc

UL Listed Short-Circuit Rating

Contactors Protected by Fusible Disconnect Switches

Contactors Continuous Rating Amps	Maximum Class RK5 Fuse Rating	Maximum Voltage	Available Amperes (RMS Sym.)
20, 30	30	600	100,000
60	60	600	100,000
100	100	600	100,000
200	200	480	100,000
300	400	600	100,000
400	400	600	100,000

Contactors Protected by Circuit Breakers

Contactors Continuous Rating Amps	Maximum Circuit Breaker Rating Amps	Recommended Square D Circuit Breaker Types	Maximum Voltage	Available Amperes (RMS Sym.)
20	25	EH-EHB, FH-FHL	240	22,000
20	25	EH-EHB, FA-FAL, FH-FHL	480	14,000
30	40	FA-FAL, FH-FHL	600	10,000
30	40	IF-IFL	480	100,000
60	80	FH-FHL	600	18,000
60	90	IF-IFL	480	100,000
100	125	KA-KAL, KH-KHL	600	10,000
100	125	IK-IKL	480	100,000
200	250	LA-LAL, LH-LHL	600	14,000
200	225	IK-IKL	480	100,000
300	400	LA-LAL, LH-LHL	600	22,000
400	800	MA-MAL, MH-MHL	600	22,000
600	800	MA-MAL, MH-MHL	600	22,000

Table 1 — Kilowatt Ratings*

Voltage	Lighting Contactor Size							
	30 Amp	60 Amp	100 Amp	200 Amp	300 Amp	400 Amp	600 Amp	800 Amp
200 Vac	10.3	20.7	34.6	69.2	103.9	138.5	207.8	277.1
230 Vac	11.9	23.9	39.8	79.6	119.5	159.3	239.0	318.7
380 Vac	19.7	39.4	65.8	131.6	197.4	263.2	394.9	526.5
460 Vac	23.9	47.8	79.6	159.3	239.0	318.6	478.0	637.4
575 Vac	30.0	60.0	99.0	199.0	299.0	398.4	597.6	796.7

* Resistance heating only (three phase system).

Current Ratings

All Class 8903 lighting contactors are fully rated for tungsten, ballast and resistance loads. This means that a contactor can be used to control a load up to its full nameplate rating. Derating of the contactor is not necessary, as is the standard practice with circuit breakers and fuses.

Table 2 — Motor Load Ratings

Lighting Contactor Size	Has Same HP Ratings As Equivalent NEMA Size Contactor
30 Amperes	NEMA Size 1
60 Amperes	NEMA Size 2
100 Amperes	NEMA Size 3
200 Amperes	NEMA Size 4
300 Amperes	NEMA Size 5
400 Amperes	—
600 Amperes	NEMA Size 6
800 Amperes	NEMA Size 7

Table 3 — Mixed Load Ratings

Motor Voltage and PH	Contactor Ampere Rating	Percent Lighting (and/or Resistive) Load							
		0%		25%		50%		75%	
		Max. Non-Motor Amp	Max. Motor HP	Max. Non-Motor Amp	Max. Motor HP	Max. Non-Motor Amp	Max. Motor HP	Max. Non-Motor Amp	Max. Motor HP
200 V 3PH	30	0	7 1/2	7.5	5	15	3	22.5	1 1/2
	60	0	10	15	10	30	7 1/2	45	3
	100	0	25	25	20	50	15	75	5
	200	0	40	50	40	100	30	150	15
	300	0	75	75	75	150	50	225	20
	400	0	125	100	100	200	60	300	30
	600	0	150	150	150	300	100	450	50
	800	0	250	200	200	400	125	600	60
230 V 3PH	30	0	7 1/2	7.5	7 1/2	15	3	22.5	2
	60	0	15	15	10	30	10	45	3
	100	0	30	25	25	50	15	75	7 1/2
	200	0	50	50	50	100	30	150	15
	300	0	100	75	75	150	50	225	25
	400	0	150	100	100	200	75	300	30
	600	0	200	150	150	300	100	450	50
	800	0	300	200	200	400	150	600	75
380 V 3PH	30	0	10	7.5	7 1/2	15	7 1/2	22.5	3
	60	0	25	15	20	30	15	45	7 1/2
	100	0	50	25	40	50	30	75	10
	200	0	75	50	75	100	60	150	30
	300	0	150	75	150	150	100	225	40
	400	0	250	100	200	200	125	300	60
	600	0	300	150	250	300	150	450	75
	800	0	400	200	350	400	250	600	125
460-575 V 3PH	30	0	10	7.5	7 1/2	15	7 1/2	22.5	3
	60	0	25	15	20	30	20	45	10
	100	0	50	25	40	50	30	75	15
	200	0	100	50	100	100	75	150	30
	300	0	200	75	150	150	100	225	50
	400	0	300	100	200	200	150	300	75
	600	0	400	150	350	300	200	450	100
	800	0	600	200	500	400	300	600	150
115 V Single PH	30	0	2	7.5	1 1/2	15	3/4	22.5	1/2
	60	0	3	15	3	30	2	45	3/4
	100	0	7 1/2	25	5	50	3	75	2
230 V Single PH	30	0	3	7.5	2	15	2	22.5	3/4
	60	0	7 1/2	15	5	30	5	45	2
	100	0	15	25	15	50	10	75	3

▼ Select lighting contactor on basis of rated motor voltage, whether non-motor load is connected line-to-line or line-to-neutral.



Lighting Control

Lighting Transfer Switch Specifications – Class 8903

Coil Information (120 Volts, 60 Hertz)

Amperes	Poles	Ohms	Inrush			Sealed		
			Henries	VA	Power Factor	Henries	VA	Power Factor
30 to 60	3	17.80	0.110	311	0.46 ▼	1.000	37	0.28 ▼
100	3	8.48	0.048	700	0.46 ▼	0.764	46	0.33 ▼
200	3	3.57	0.032	1185	0.37	0.490	85	0.23
300	3	0.95	0.013	2970	0.23	0.187	212	0.13

▼ Worst case; all others are mean values.

Maximum Voltage Ratings

30 - 300 Amperes

Type of Load	When connected 1φ pole to load	When connected 2φ poles to load on 1φ and 3φ poles to load on 3φ
Tungsten	277 Vac	480 Vac
Ballast	277 Vac	480 Vac

400 - 800 Amperes

Type of Load	When connected 1φ pole to load	When connected 2φ poles to load on 1φ and 3φ poles to load on 3φ
Tungsten	277 Vac	480 Vac
Ballast	277 Vac	480 Vac

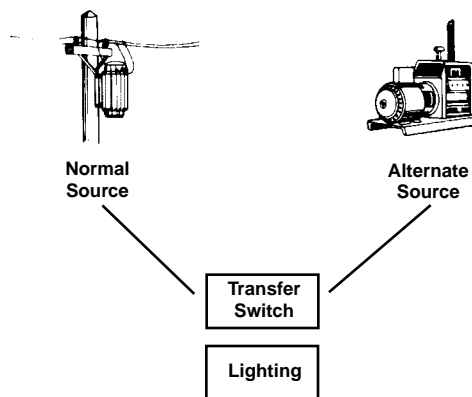

The automatic transfer switch, as part of the emergency lighting system, provides the important function of switching an essential electrical load from the normal source of lighting supply to an alternate source of supply.

Wiring Terminals

Ampere Rating	Power Terminals On Contactor		Control Terminals On All Contactors	
	Type of Lug	Wire Size Min. - Max.	Type of Lug	Wire Size Min. - Max.
30	Screw Lug	#14 - #8 copper or aluminum	Clamp	#16 - #12 copper
60		#14 - #2 copper or aluminum		#16 - #12 copper
100		#14 - #2/0 copper or aluminum		#16 - #12 copper
200		#6 -350KCMIL copper or aluminum		#16 - #12 copper
300		one #4 - 600 KCMIL or Two #0 - 250 KCMIL or aluminum		#16 - #12 copper
400		One or two #6 - 250 KCMIL copper or aluminum		Elec. Held: #16 - #14 copper Mech. held: #16 - #12 copper
600		One or two #6 - 600 KCMIL copper or aluminum		Elec. Held: #16 - #14 copper Mech. held: #16 - #12 copper
800		One, two or three #3/0 - 750 KCMIL copper or aluminum		Elec. Held: #16 - #14 copper Mech. held: #16 - #12 copper



Lighting Control

Class 8903 – Approximate Dimensions

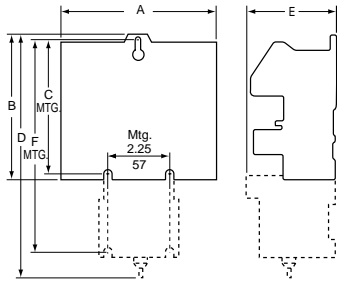

Open Type L & LX

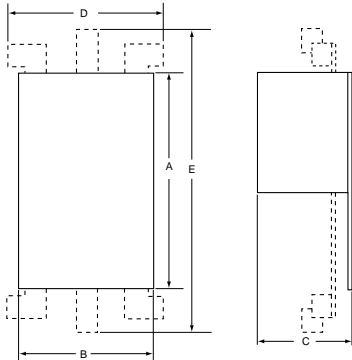

Open Type S

Open Type

Ampere Rating	Type	Number of Poles	Electrically Held					Mechanically Held						
			Dimensions▼					Dimensions▼						
			A	B	C	D	E	Type	A	B	C	D	E	F
30	LO	2-4	2.88 (73)	5 (127)	4.62 (117)	3.12 (79)	LXO	2.88 (73)	8.81 (224)	3.25 (83)	7.70 (196)
		6	4.25 (108)	5 (127)	4.62 (117)	3.12 (79)		4.25 (108)	8.81 (224)	3.25 (83)	7.70 (196)
		8-12	5.63 (143)	5 (127)	4.62 (117)	3.12 (79)		5.63 (143)	8.81 (224)	3.25 (83)	7.70 (196)
30	SMO	2-3	4.34 (110)	3.22 (82)	4.22 (107)	7.15 (182)	3.79 (96)	4.68 (119)	
		4-5	4.34 (110)	4.25 (108)	4.22 (107)	7.15 (182)	4.54 (116)	4.68 (119)	
60	SPO	2-3	5.33 (135)	4.31 (110)	4.94 (125)	8.25 (210)	4.61 (117)	5.23 (133)	
		4-5	6.22 (158)	5.61 (143)	4.94 (125)	8.70 (221)	5.90 (150)	5.23 (133)	
100	SQO	2-3	7.09 (180)	5.45 (139)	6.50 (165)	10.13 (257)	5.94 (151)	6.72 (171)	
		4-5	7.82 (199)	9.75 (248)	6.50 (165)	10.56 (268)	9.75 (248)	6.72 (171)	
200	SVO	2-3	9.14 (232)	6.00 (152)	6.50 (165)	SVO	11.35 (293)	6.00 (152)	6.72 (171)	
		4 & 5■	9.14 (232)	9.75 (248)	6.50 (165)	SVO	11.55 (293)	9.75 (248)	6.72 (171)	
300	SXO	2-3	12.31 (313)	8.66 (220)	8.74 (222)	SXO	12.31 (313)	8.66 (220)	10.50 (267)	
400	SYO	2-3	12.33 (313)	9.00 (229)	27.78 (706)	SYO	8.66 (220)	10.50 (267)	21.00 (533)	
600	SZO													
800	SJO	2-3	12.33 (313)	11.94 (303)	42.70 (1085)	SJO	8.66 (220)	11.94 (303)	35.35 (898)	

■ 5 pole, electrically-held only.
▼ Dimensions are in inches (millimeters).

NEMA Type 1 Flush Mounted

Ampere Rating	Type	Form(s)	Dimensions in inches (millimeters)						
			A	B	C	D	E	F	G
30	LF LXF	Standard, F, Y48, R6	15.19 (386)	8.94 (227)	7.63 (194)	12.88 (327)	5.44 (138)	10.94 (278)	5.13 (130)
		A3, A12, C, C6, T, P	24.00 (610)	17.50 (445)	15.00 (381)	19.25 (489)	7.12 (181)
30	SMF	Electrically Held Std., A12, C, C6, P, X	13.44 (341)	7.19 (183)	5.88 (149)	11.13 (283)	4.75 (121)	9.19 (233)	4.50 (114)
		Mechanically Held Std., X
		Electrically Held T, N	24.00 (610)	17.50 (445)	15.00 (381)	19.25 (489)	5.75 (146)
		Mechanically Held A3, C, C6, T, N, P, R6
60	SPF	Electrically Held Std., A12, C, C6, P, X	15.19 (386)	8.94 (227)	7.63 (194)	12.88 (327)	5.44 (138)	10.94 (278)	5.13 (130)
		Mechanically Held Std., X
		Electrically Held T, N	24.00 (610)	17.50 (445)	15.00 (381)	19.25 (489)	5.75 (146)
		Mechanically Held A3, C, C6, T, N, P, R6
100	SQF	With or without any forms	31.00 (787)	16.75 (425)	14.25 (362)	26.25 (667)	8.00 (203)

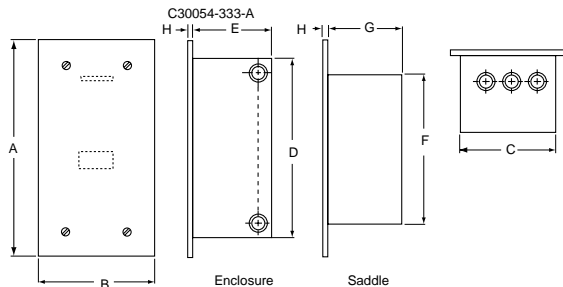

NEMA Type 1 Enclosure (Non-Combination) Electrically and Mechanically Held

Ampere Rating	Type	Number of Poles	Form(s)	Dimensions▼		
				Width	Height	Depth
30	LG, LXG	Any	Standard, A3, A12, C, C6, F, R6, Y48	7.81 (198)	12.69 (322)	6.03 (153)
			P, T	11.88 (302)	11.88 (302)	7.44 (189)
30			K14, K141, K142	16.00 (406)	22.00 (559)	7.13 (181)
30	SMG	2-5	Electrically Held Std., A12, C, C6, P, X	6.00 (152)	10.00 (254)	5.28 (134)
			Mechanically Held Std., X
		Electrically Held T	6.34 (161)	15.88 (403)	5.19 (132)	
		Mechanically Held N T, N, R6	14.88 (378)	14.12 (359)	7.56 (192)	
60	SPG	2-5	Electrically Held Std., A12, C, C6, P, X	7.81 (198)	12.69 (322)	6.03 (153)
		2-5	Electrically Held & Mechanically Held T, N, R6	14.88 (378)	14.12 (359)	7.56 (192)
		2-5	Mechanically Held Std., A3, C, C6, P, X	8.12 (206)	14.12 (359)	9.73 (247)
100	SQG	2 & 3	Electrically Held Std., A12, C, C6, F, P, X, T	11.25 (286)	25.15 (639)	8.99 (228)
			Mechanically Held Std., F, X, T
			Electrically Held N, R6, T, T10-T13,*	18.15 (461)	29.15 (740)	9.24 (234)
		4 & 5	Mechanically Held A3, C, C6, N, R6, T, T10-T13,*
			Electrically Held Std., A12, C, C6, F, P, X	11.25 (286)	25.15 (639)	8.99 (228)
			Mechanically Held Std., F, X
200	SVG	All	Electrically Held *	18.15 (461)	29.15 (740)	9.24 (234)
		All	Mechanically Held A3, C, C6, *
300	SXG	All	Electrically Held N, R6, T, T10-T13	22.15 (563)	39.15 (994)	10.24 (260)
		All	Mechanically Held N, R6, T, T10-T13
400 and 600	SYG & SZG	All	Electrically and Mechanically Held Standard and All Forms	17.21 (437)	44.21 (1123)	12.83 (325)
		All	Electrically and Mechanically Held Standard and All Forms	20.21 (513)	65.75 (1670)	13.10 (333)
800	SJG	2-3	With or without any forms	34.50 (876)	93.00 (2362)	23.50 (597)

* All "Type K" Forms.
▼ Dimensions are in inches (millimeters).



Lighting Control

Approximate Dimensions – Class 8903

NEMA Type 3R

Amps	Type	Number of Poles	A	B	C	D1	D2	E	F	G1	G2	H1	H2	J	K	L	M	N	P	K.O. X	K.O. Y
30	SMH	All	8.83 (224)	12.30 (312)	7.12 (181)	1.39 (35)	1.44 (37)	6.00 (152)	7.50 (191)	2.64 (67)	2.16 (55)	2.08 (53)	2.62 (66)	14.28 (363)	1.37 (35)	1.37 (35)	1.88 (48)	4.38 (111)	1.83 (46)	1 1/2 3/4 1	1 1/2 3/4 1
30 60	LH SPH	All	9.83 (250)	16.30 (414)	8.62 (219)	1.39 (35)	1.44 (37)	7.00 (178)	11.50 (292)	2.64 (67)	2.16 (55)	2.08 (53)	2.62 (66)	16.78 (426)	1.31 (33)	1.75 (44)	2.13 (54)	4.88 (124)	1.83 (46)	1 1/4 1 1/2 1 1/2	1 1/2 3/4 3/4
100	SQH	All	12.83 (326)	25.30 (643)	8.62 (219)	1.39 (35)	1.44 (37)	10.00 (254)	20.50 (521)	2.64 (67)	2.16 (55)	2.08 (53)	2.62 (66)	19.78 (502)	1.31 (33)	1.94 (49)	2.44 (62)	6.38 (162)	1.83 (46)	1 1/4 2 2 1/2	1 1/2 3/4 3/4
200	SVH	All	12.83 (326)	40.30 (1024)	9.12 (232)	1.39 (35)	1.44 (37)	10.00 (254)	35.50 (902)	2.64 (67)	2.16 (55)	2.08 (53)	2.62 (66)	20.28 (515)	1.31 (33)	2.31 (59)	2.69 (68)	6.38 (162)	1.83 (46)	1 1/4 2 2 1/2	1 1/2 3/4 3/4

NEMA Type 4 and 4X

Ampere Rating	Type	Number of Poles	Form(s)	Dimensions in inches (millimeters)												Bottom Hub Only W	Top & Bottom Hub X						
				A	B	C	D	E	F	G	H	I	J	K	L								
30	LW LXW	Any	Standard, F, R6, Y48	8.13 (206)	7.88 (200)	16.19 (411)	1.56 (40)	5.00 (127)	15.00 (381)	0.60 (15)	1.94 (49)	14.75 (375)	2.00 (51)	2.63 (67)	0.31 (8)	3/4 in.	1 1/2 in.						
			A3, A12, C, C6, P, T	12.62 (321)	7.81 (198)	14.69 (373)	2.56 (65)	7.50 (191)	13.50 (343)	0.63 (16)	3.38 (86)	18.44 (468)	1.69 (43)	2.31 (59)	0.31 (8)	3/4 in.	1 in.						
30	SMW	2-5	Electrically Held Std., A12, C, C6, P, X	6.38 (162)	7.13 (181)	13.19 (351)	1.56 (40)	3.25 (83)	12.00 (305)	0.63 (16)	1.91 (49)	11.81 (300)	1.63 (41)	2.31 (59)	0.31 (8)	3/4 in.	1 in.						
			Mechanically Held Std., F, X	12.63 (321)	7.11 (181)	14.69 (373)	2.56 (65)	7.50 (191)	13.50 (343)	0.63 (16)	3.19 (81)	18.50 (470)	1.64 (42)	2.31 (59)	0.31 (8)	3/4 in.	1 in.						
			Electrically Held T	14.88 (378)	7.25 (184)	16.31 (414)	2.56 (65)	9.75 (248)	15.00 (381)	0.63 (16)	3.19 (81)	20.88 (530)	2.06 (52)	2.63 (67)	0.31 (8)	3/4 in.	1 1/2 in.						
			Mechanically Held N, R6	8.13 (206)	7.88 (200)	16.19 (411)	1.56 (40)	5.00 (127)	15.00 (381)	0.60 (15)	1.94 (49)	14.75 (375)	2.00 (51)	2.63 (67)	0.31 (8)	3/4 in.	1 1/2 in.						
60	SPW	2-5	Electrically Held Std., A12, C, C6, P, X	6.38 (162)	7.13 (181)	13.19 (351)	1.56 (40)	3.25 (83)	12.00 (305)	0.63 (16)	1.91 (49)	11.81 (300)	1.63 (41)	2.31 (59)	0.31 (8)	3/4 in.	1 in.						
			Mechanically Held Std., A3, C, C6, P, X	12.63 (321)	7.11 (181)	14.69 (373)	2.56 (65)	7.50 (191)	13.50 (343)	0.63 (16)	3.19 (81)	18.50 (470)	1.64 (42)	2.31 (59)	0.31 (8)	3/4 in.	1 in.						
			Electrically Held T, N, R6	14.88 (378)	7.25 (184)	16.31 (414)	2.56 (65)	9.75 (248)	15.00 (381)	0.63 (16)	3.19 (81)	20.88 (530)	2.06 (52)	2.63 (67)	0.31 (8)	3/4 in.	1 1/2 in.						
			Mechanically Held A3, C, C6, T, N, P, R6	8.13 (206)	7.88 (200)	16.19 (411)	1.56 (40)	5.00 (127)	15.00 (381)	0.60 (15)	1.94 (49)	14.75 (375)	2.00 (51)	2.63 (67)	0.31 (8)	3/4 in.	1 1/2 in.						
100	SQW	2 & 3	Electrically Held Std., A12, C, C6, F, N, R6, P, T, T10-13, X	18.15 (461)	8.77 (223)	32.21 (818)	3.08 (78)	12.00 (305)	30.50 (775)	0.61 (15)	3.67 (93)	26.71 (678)	2.58 (66)	3.19 (81)	0.44 (11)	3/4 in.	2 1/2 in.						
			Mechanically Held Std., A3, C, C6, F, N, P, R6, T, T10-13, X	22.15 (563)	9.77 (248)	42.21 (1072)	3.08 (78)	16.00 (406)	40.50 (1029)	0.61 (15)	3.67 (93)	31.71 (805)	2.33 (59)	2.88 (73)	0.44 (11)	3/4 in.	2 1/2 in.						
		4 & 5	Electrically Held N, R6, T, T10-13	22.15 (563)	9.77 (248)	42.21 (1072)	3.08 (78)	16.00 (406)	40.50 (1029)	0.61 (15)	3.67 (93)	31.71 (805)	2.33 (59)	2.88 (73)	0.44 (11)	3/4 in.	2 1/2 in.						
			Mechanically Held N, R6, T, T10-13	22.15 (563)	9.77 (248)	42.21 (1072)	3.08 (78)	16.00 (406)	40.50 (1029)	0.61 (15)	3.67 (93)	31.71 (805)	2.33 (59)	2.88 (73)	0.44 (11)	3/4 in.	2 1/2 in.						
		200	SVW	All	Electrically and Mechanically Held	Standard and All Forms	22.15 (563)	9.77 (248)	42.21 (1072)	3.08 (78)	16.00 (406)	40.50 (1029)	0.61 (15)	3.67 (93)	31.71 (805)	2.33 (59)	2.88 (73)	0.44 (11)	3/4 in.	2 1/2 in.			
		300	SXW	All	Electrically and Mechanically Held	Standard and All Forms	17.21 (437)	12.63 (321)	47.21 (1199)	4.11 (104)	9.00 (229)	46.00 (1168)	0.61 (15)	4.59 (117)	28.32 (719)	3.11 (79)	5.75 (146)	0.56 (14)	3/4 in.	3 1/2 in.			
400 & 600	SYW & SZW	All	Electrically and Mechanically Held	Standard and All Forms	20.21 (513)	12.13 (308)	65.21 (1656)	4.11 (104)	12.00 (305)	64.00 (1626)	0.61 (15)	4.59 (117)	30.82 (783)	2.67 (68)	4.50 (114)	0.56 (14)	3/4 in.	Two 3 in. ■					
800	SJW	2-3	With or without any forms						34.50 (876)	23.50 (597)	101.00 (2565)	Floor Mounting											

■ X hub is 1/4 in. left of center. W hub shown is another X hub. K dimension is distance between two X hubs. Actual W hub is located 3 3/16 in. to the right of X hub shown.
 ★ All "K" forms.

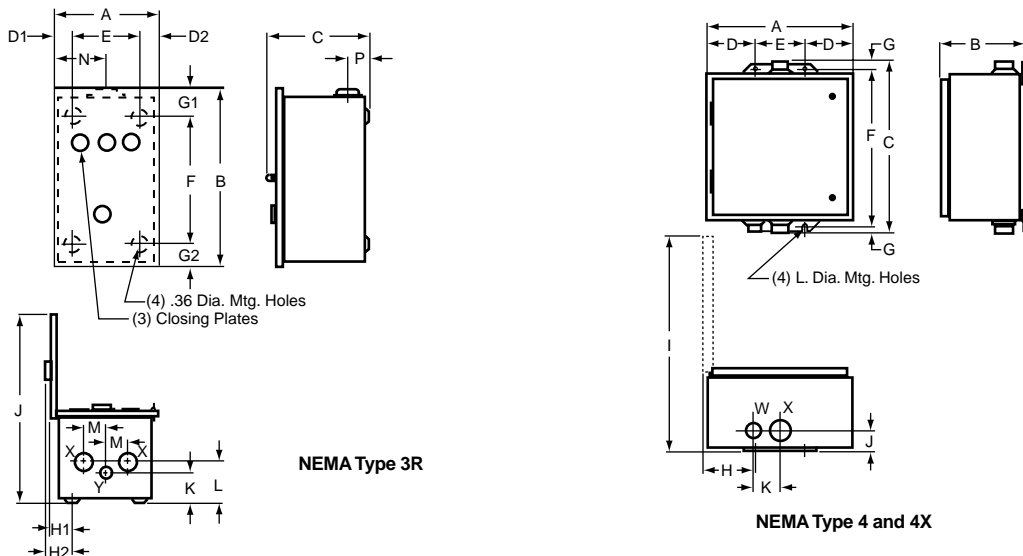

Lighting Control

Class 8903 – Approximate Dimensions

NEMA Type 12

Ampere Rating	Type	Number of Poles	Form(s)	Dimensions in inches (millimeters) ▼										
				A	B	C	D	E	F	G	H	I	J	
30	LA LXA	Any	Standard, F, R6, Y48	8.13 (206)	8.50 (216)	15.75 (400)	1.56 (40)	5.00 (127)	15.00 (381)	0.31 (8)	2.13 (54)	14.75 (375)	0.31 (8)	
			A3, A12, C, C6, P, T	11.88 (302)	7.75 (197)	13.50 (343)	3.81 (97)	4.25 (108)	12.75 (324)	0.38 (10)	4.94 (125)	18.12 (460)	0.31 (8)	
30	SMA	2-5	Electrically Held	Std., A12, C, C6, P, X	6.38 (162)	8.53 (217)	12.75 (324)	1.56 (40)	3.25 (83)	12.00 (305)	0.38 (10)	3.56 (90)	12.50 (318)	0.31 (8)
			Mechanically Held	Std., F, P, X										
			Electrically Held	T	11.88 (302)	7.75 (197)	13.50 (343)	2.56 (65)	6.75 (171)	12.75 (324)	0.38 (10)	3.66 (93)	18.12 (460)	0.31 (8)
			Electrically Held	N, R6	14.88 (378)	7.88 (200)	16.00 (406)	2.56 (65)	9.75 (248)	15.00 (381)	0.50 (13)	3.66 (93)	21.25 (540)	0.31 (8)
			Mechanically Held	A3, C, C6, T, N, P, R6										
			60	SPA	2-5	Electrically Held	Std., A12, C, C6, P, X	8.13 (206)	9.28 (236)	16.00 (406)	1.56 (40)	5.00 (127)	15.00 (381)	0.50 (13)
Mechanically Held	Std., A3, C, C6, P, X													
Electrically Held	T, N, R6	14.88 (378)				7.88 (200)	15.75 (400)	2.56 (65)	9.75 (248)	15.00 (381)	0.38 (10)	3.66 (93)	21.25 (540)	0.31 (8)
Mechanically Held	A3, C, C6, T, N, P, R6													
100	SQA	2 & 3	Electrically Held	Std., A12, C, C6, F, N, R6, P, T, T10-13, X	18.15 (461)	9.24 (234)	31.50 (800)	3.08 (78)	12.00 (305)	30.50 (775)	0.50 (13)	3.67 (93)	26.71 (678)	0.44 (11)
			Mechanically Held	Std., A3, C, C6, F, N, P, R6, T, T10-13, X										
		4 & 5	Electrically Held	Std., A12, C, C6, F, N, P, ★	22.15 (563)	10.24 (260)	41.50 (1054)	3.08 (78)	16.00 (406)	40.50 (1029)	0.50 (13)	3.67 (93)	31.71 (805)	0.44 (11)
			Mechanically Held	Std., A3, C, C6, P, ★										
			Electrically Held	N, R6, T, T10-13, ★	22.15 (563)	10.24 (260)	41.50 (1054)	3.08 (78)	16.00 (406)	40.50 (1029)	0.50 (13)	3.67 (93)	31.71 (805)	0.44 (11)
			Mechanically Held	N, R6, T, T10-13, ★										
200	SVA	All	Electrically and Mechanically Held	Standard and All Forms	22.15 (563)	10.24 (260)	41.50 (1054)	3.08 (78)	16.00 (406)	40.50 (1029)	0.50 (15)	3.67 (93)	31.71 (805)	0.44 (11)
300	SXA	All	Electrically and Mechanically Held	Standard and All Forms	17.21 (437)	13.33 (339)	47.00 (1193)	4.11 (104)	9.00 (229)	46.00 (1168)	0.50 (13)	4.59 (117)	28.32 (719)	0.56 (14)
400 & 600	SYA & SZA	All	Electrically and Mechanically Held	Standard and All Forms	20.21 (513)	13.00 (330)	65.00 (1651)	4.11 (104)	12.00 (305)	64.00 (1625)	0.50 (13)	5.31 (135)	30.87 (784)	0.69 (18)
800	SJA	2-3	With or without any forms		93.00 (2362)	34.50 (876)	23.50 (597)	Floor Mounting						

▼ See Figure 1 for all dimensions except 800A; for 800A dimensions, see Figure 2.

★ All Type "K" Forms using Class 9001 Type K Control Units.

NIGHT-MASTER Outdoor Lighting Contactors (Short Version) – NEMA Type 3R

Ampere Rating	Description	Type Number	A	B	C	D	E	F	G	H	Cond. J	K	L	M	Knockouts		
															N	P	Q
30	Disconnect Switch & Circuit Breaker Types	SMC61, 62 & 81	23.50 (597)	15.00 (381)	8.42 (214)	10.50 (267)	19.00 (483)	22.38 (568)	7.00 (178)	2.18 (55)	1.50 (38)	2.13 (54)	2.13 (54)	2.13 (54)	0.50-0.75	1-1.25-1.50	0.50-0.75
60	Disconnect Switch & Circuit Breaker Types	SPC61, 62 & 81															
100	Disconnect Switch & Circuit Breaker Types	SQC61, 62 & 81	34.53 (877)	20.00 (508)	8.42 (214)	10.50 (267)	30.04 (763)	33.41 (849)	7.00 (178)	2.18 (55)	2.0 (2.50)	2.68 (68)	2.68 (68)	3.44 (87)	0.50-0.75	1-1.25-2.2-2.50	1-1.25-1.5-2.0
200	Disconnect Switch Type Circuit Breaker Type	SVC61 & 62 SVC81	48.37 (1229)	19.00 (483)	9.12 (232)	10.53 (267)	44.00 (1118)	47.25 (1200)	7.00 (178)	2.18 (55)	2.50 (64)	2.68 (68)	2.68 (68)	3.44 (87)	0.50-0.75	1-1.25-2-2.50	1-1.25-1.5-2.0

NIGHT-MASTER Outdoor Lighting Contactors (Long Version) – NEMA Type 3R

Ampere Rating	Description	Type Number	A	B	C	D	E	F	G	H	Cond. J	K	L	M	Knockouts		
															N	P	Q
30	Disconnect Switch & Circuit Breaker Types	SMC63, 64 & 83	38.88 (987)	15.00 (381)	8.42 (214)	10.42 (265)	34.38 (873)	37.76 (959)	7.00 (178)	2.18 (55)	1.50 (38)	2.13 (54)	2.13 (54)	2.13 (54)	0.50-0.75	1-1.25-1.50	0.50-0.75
60	Disconnect Switch & Circuit Breaker Types	SPC63, 64 & 83															
100	Disconnect Switch & Circuit Breaker Types	SQC63, 64 & 83	42.53 (1080)	20.00 (508)	8.42 (214)	10.42 (265)	38.04 (966)	41.41 (1052)	7.00 (178)	2.18 (55)	2.0 (2.50)	2.68 (68)	2.68 (68)	3.44 (87)	0.50-0.75	1-1.25-2.2-2.50	1-1.25-1.5-2.0
200	Disconnect Switch Type Circuit Breaker Type	SVC63 & 64 SVC83	56.37 (1432)	19.00 (483)	9.12 (232)	10.53 (267)	52.00 (1321)	55.25 (1403)	7.00 (178)	2.18 (55)	2.50 (64)	2.68 (68)	2.69 (68)	3.44 (87)	0.50-0.75	1-1.25-2-2.50	1-1.25-1.5-2.0

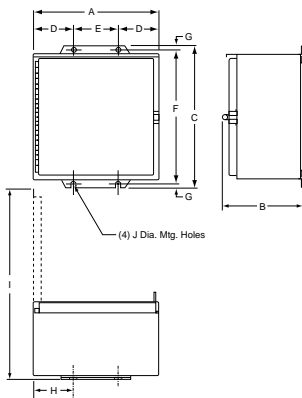

Figure 1: NEMA Type 12 (30-600A)

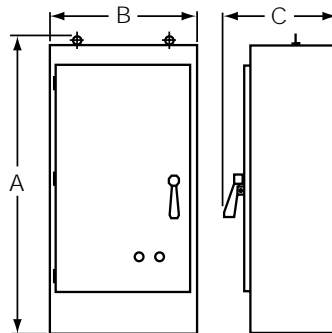

Figure 2: NEMA Type 12 (800A)

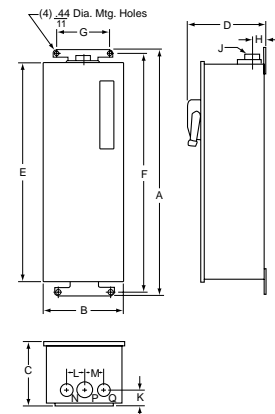

Figure 3: NIGHT-MASTER



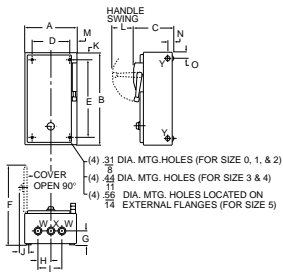

Figure 1
NEMA Type 1 Enclosure

Combination Lighting Contactors – NEMA Type 1 Enclosure

Ampere Rating	Type	Dimensions in inches (millimeters) * (see Figure 1)															Top & Bot.			Sides
		A	B	C	D	E	F	G	H	I	J	K	L	M	N	O	W	X	Y	
30	SMG6- & 8-	9.50 (241)	22.50 (572)	8.37 (213)	6.38 (162)	20.50 (521)	14.68 (373)	1.81 (46)	1.69 (43)	3.37 (86)	3.38 (86)	1.06 (27)	3.25 (83)	2.18 (55)	1.25 (32)	0.87 (22)	0.50-0.75	0.50-0.75	.50	
	SMG7- & 9-	13.75 (349)	23.00 (584)	8.36 (212)	10.63 (270)	21.00 (533)	20.07 (510)	1.87 (47)	1.88 (48)	3.76 (96)	2.06 (52)	1.06 (27)	3.25 (83)	2.18 (55)	1.25 (32)	0.87 (22)	0.50-0.75-1.0	0.50-0.75-1.0	.50	
60	SPG6- & 8-	10.50 (267)	26.00 (660)	9.62 (244)	7.37 (187)	24.00 (610)	17.00 (432)	2.12 (54)	2.00 (51)	4.00 (102)	2.06 (52)	1.06 (27)	3.25 (83)	2.18 (55)	1.25 (32)	0.87 (22)	1.0-1.25	0.50-0.75	.50	
	SPG7- & 9-	15.00 (381)	28.75 (730)	9.62 (244)	11.62 (295)	26.25 (667)	21.50 (546)	2.18 (55)	2.00 (51)	4.00 (102)	2.56 (65)	1.31 (33)	3.25 (83)	2.18 (55)	1.25 (32)	0.87 (22)	1.0-1.25	0.50-0.75	.50	

NEMA Type 1 Enclosure

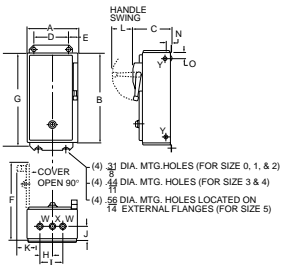

Figure 2
NEMA Type 1 Enclosure

Ampere Rating	Type	Dimensions in inches (millimeters) * (see Figure 2)															Top & Bot.			Sides
		A	B	C	D	E	F	G	H	I	J	K	L	M	N	O	W	X	Y	
100	SQG6- & 7- SQG81 & 91	15.25 (387)	39.50 (1003)	10.60 (269)	9.25 (235)	3.00 (76)	22.68 (576)	41.00 (1041)	2.69 (68)	5.38 (137)	2.83 (72)	3.74 (95)	5.00 (127)	...	1.21 (31)	0.90 (23)	1.1-1.25	0.50-0.75	.50	
200	SVG6- & 7- SVG81 & 91	16.00 (406)	50.00 (1270)	10.68 (271)	10.00 (254)	3.00 (76)	23.68 (601)	51.50 (1308)	2.69 (68)	5.38 (137)	2.83 (72)	3.74 (95)	5.00 (127)	...	1.21 (31)	0.90 (23)	2.50	0.50-0.75	.50	
200	SXG6- & 7-	20.00 (508)	75.00 (1905)	14.37 (365)	12.00 (305)	4.00 (102)	29.43 (748)	77.00 (1956)	3.19 (81)	...	3.52 (89)	7.00 (178)	9.25 (235)	0.50-0.75	3.00	...	
	SXG81 & 91	20.00 (508)	63.00 (1600)	14.37 (365)	12.00 (305)	4.00 (102)	27.43 (697)	65.00 (1651)	3.19 (81)	...	3.52 (89)	7.00 (178)	5.00 (127)	0.50-0.75	3.00	...	
400	SYG81 & 91	36.00 (914)	90.00 (2286)	17.00 (432)	Floor Mounting Enclosure												
600	SZG81 & 91	Floor Mounting Enclosure															

NEMA Type 4 & 4X Enclosure

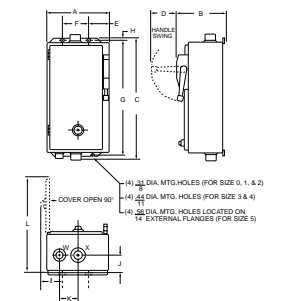

Figure 3
NEMA Type 4 Enclosure

Ampere Rating	Type	Dimensions in inches (millimeters) *														Top & Bot.	
		A	B	C	D	E	F	G	H	I	J	K	L	M	N	W	X
30	SMW6- & 8-	9.50 (241)	8.36 (212)	24.76 (629)	3.25 (83)	2.50 (64)	4.50 (114)	23.50 (597)	0.63 (16)	3.00 (76)	1.62 (41)	2.31 (59)	14.31 (363)	0.75 Hub	1.0 Hub		
	SMW7- & 9-	13.75 (349)	8.36 (212)	25.26 (642)	3.25 (83)	4.75 (121)	4.25 (108)	24.00 (610)	0.63 (16)	5.25 (133)	1.62 (41)	2.31 (59)	20.14 (512)	0.75 Hub	1.0 Hub		
60	SPW6- & 8-	10.50 (267)	9.61 (244)	28.26 (718)	3.25 (83)	2.50 (64)	5.50 (140)	27.00 (686)	0.63 (16)	3.00 (76)	2.00 (51)	2.63 (67)	16.56 (421)	0.75 Hub	1.50 Hub		
	SPW7- & 9-	15.00 (381)	9.61 (244)	31.01 (788)	3.25 (83)	5.38 (137)	4.25 (108)	29.75 (756)	0.63 (16)	5.88 (149)	2.00 (51)	2.63 (67)	21.06 (535)	0.75 Hub	1.50 Hub		
100	SQW6- & 7- SQW81 & 91	15.25 (387)	10.60 (269)	41.76 (1061)	5.00 (127)	2.50 (64)	10.25 (260)	40.50 (1028)	0.63 (16)	3.24 (82)	2.61 (66)	3.19 (81)	22.18 (563)	0.75 Hub	2.50 Hub		
200	SVW6- & 7- SVW81 & 91	16.00 (406)	10.56 (268)	52.26 (1327)	5.00 (127)	2.50 (64)	11.00 (279)	51.00 (1295)	0.63 (16)	3.24 (82)	2.61 (66)	3.19 (81)	23.00 (584)	0.75 Hub	2.50 Hub		
300	SXW6- & 7-	20.00 (508)	14.21 (361)	78.12 (1984)	9.25 (235)	4.00 (102)	12.00 (305)	77.00 (1956)	0.56 (14)	4.77 (121)	2.96 (75)	3.50 (89)	29.43 (748)	0.75 Hub	3.50 Hub		
	SXW81 & 91	20.00 (508)	14.21 (361)	66.12 (1679)	5.00 (127)	4.00 (102)	12.00 (305)	65.00 (1651)	0.56 (14)	4.77 (121)	2.96 (75)	3.50 (89)	27.43 (697)	0.75 Hub	3.50 Hub		
400	SYW81 & 91	36.00 (914)	17.71 (450)	98.00 (2489)	Floor Mounting Enclosure										
600	SZW81 & 91	Floor Mounting Enclosure													

* Dimensions are the same for Form F4T (standard control transformer), Form F4T11 (100 VA extra capacity) and Form F4T12 (200 VA extra capacity).

NEMA Type 12 Enclosure

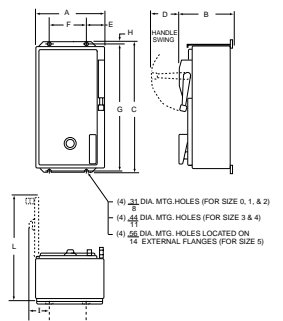

Figure 4
NEMA Type 12 Enclosure

Ampere Rating	Type	Dimensions in inches (millimeters) *											
		A	B	C	D	E	F	G	H	I	J		
30	SMA6- & 8-	9.50 (241)	8.36 (212)	24.26 (616)	3.25 (83)	2.50 (64)	4.50 (114)	23.50 (597)	0.38 (10)	3.25 (83)	14.31 (363)		
	SMA7- & 9-	13.75 (349)	10.10 (257)	24.76 (629)	3.25 (83)	4.75 (121)	4.25 (108)	24.00 (610)	0.38 (10)	5.50 (140)	22.00 (559)		
60	SPA6- & 8-	10.50 (267)	9.61 (244)	27.76 (705)	3.25 (83)	2.50 (64)	5.50 (140)	27.00 (686)	0.38 (10)	3.25 (83)	16.56 (421)		
	SPA7- & 9-	15.00 (381)	10.98 (279)	30.51 (775)	3.25 (83)	5.38 (137)	4.25 (108)	29.75 (756)	0.38 (10)	6.13 (156)	23.43 (595)		
100	SQA6- & 7- SQA81 & 91	15.25 (387)	10.59 (269)	42.00 (1067)	5.00 (127)	3.00 (76)	9.25 (235)	41.00 (1041)	0.50 (13)	3.75 (95)	22.31 (567)		
200	SVA6- & 7- SVA81 & 91	16.00 (406)	10.52 (267)	52.50 (1334)	5.00 (127)	3.00 (76)	10.00 (254)	51.50 (1308)	0.50 (13)	3.75 (95)	23.00 (584)		
300	SXA6- & 7-	20.00 (508)	14.21 (361)	78.00 (1981)	9.25 (235)	4.00 (102)	12.00 (305)	77.00 (1956)	0.50 (13)	7.75 (197)	29.43 (748)		
	SXA81 & 91	20.00 (508)	14.21 (361)	66.00 (1676)	5.00 (127)	4.00 (102)	12.00 (305)	65.00 (1651)	0.50 (13)	7.75 (197)	27.43 (697)		
400	SYA81 & 91	36.00 (914)	17.71 (450)	90.00 (2286)	Floor Mounting Enclosure						
600	SZA81 & 91	Floor Mounting Enclosure									

* Dimensions are the same for Form F4T (standard control transformer), Form F4T11 (100 VA extra capacity) and Form F4T12 (200 VA extra capacity).



Lighting Control

Class 8903 – Approximate Dimensions

Class 8903 REQ Open Type Electrically Held

Figure	Device	Poles	Mounting	A	B	C	D	E	F	G	H	I	J
1	30 A	2P – 2P	(4) #10	12.13 (308)	6.75 (171)	6.03 (153)	11.63 (295)	6.25 (159)	–	–	0.50 (13)	0.25 (6)	0.25 (6)
		3P – 3P	(4) #10	12.13 (308)	6.75 (171)	6.03 (153)	11.63 (295)	6.25 (159)	–	–	0.50 (13)	0.25 (6)	0.25 (6)
		4P – 4P	(4) #10	13.27 (337)	6.75 (171)	6.03 (153)	11.63 (295)	6.25 (159)	–	–	0.50 (13)	0.25 (6)	0.25 (6)
	60 A	2P – 2P	(4) #10	12.13 (308)	6.75 (171)	6.03 (153)	11.63 (295)	6.25 (159)	–	–	0.50 (13)	0.25 (6)	0.25 (6)
		3P – 3P	(4) #10	12.13 (308)	6.75 (171)	6.03 (153)	11.63 (295)	6.25 (159)	–	–	0.50 (13)	0.25 (6)	0.25 (6)
		4P – 4P	(4) #10	13.27 (337)	6.75 (171)	6.03 (153)	11.63 (295)	6.25 (159)	–	–	0.50 (13)	0.25 (6)	0.25 (6)
	100 A	2P – 2P	(4) 5/16	12.72 (323)	7.97 (202)	7.00 (178)	11.75 (299)	7.00 (178)	–	–	0.48 (122)	0.48 (122)	0.49 (12.5)
		3P – 3P	(4) 5/16	12.72 (323)	7.97 (202)	7.00 (178)	11.75 (299)	7.00 (178)	–	–	0.48 (122)	0.48 (122)	0.49 (12.5)
		4P – 4P	(4) 5/16	21.71 (551)	8.96 (228)	7.00 (178)	20.75 (527)	8.00 (203)	–	–	0.48 (122)	0.48 (122)	0.48 (122)
	150 A	2P – 2P	(4) 5/16	14.21 (361)	8.96 (228)	7.00 (178)	13.25 (337)	8.00 (203)	–	–	0.48 (122)	0.48 (122)	0.49 (12.5)
		3P – 3P	(4) 5/16	14.21 (361)	8.96 (228)	7.00 (178)	13.25 (337)	8.00 (203)	–	–	0.48 (122)	0.48 (122)	0.49 (12.5)
		4P – 4P	(4) 5/16	21.71 (551)	8.96 (228)	7.00 (178)	20.75 (527)	8.00 (203)	–	–	0.48 (122)	0.48 (122)	0.48 (122)

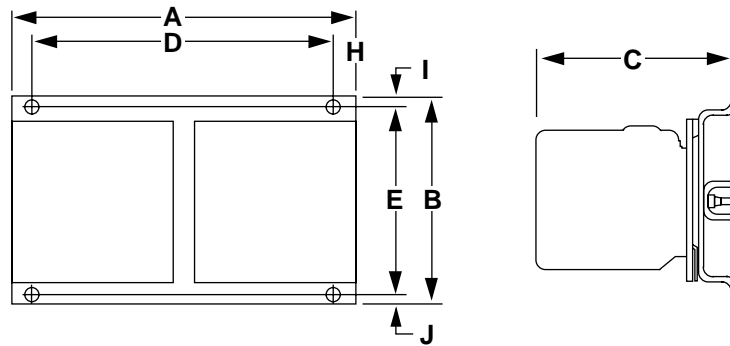

Figure 1

**Class 8903 REQ Open Type
Mechanically Held**

Figure	Device	Poles	Mounting	A	B	C	D	E	F	G	H	I	J
2	30 A	2P – 2P	(4) #10	12.13 (308)	8.53 (217)	6.31 (160)	11.63 (295)	6.25 (159)	8.13 (207)	9.31 (237)	0.50 (13)	0.25 (6)	2.03 (51.6)
		3P – 3P	(4) #10	12.13 (308)	8.53 (217)	6.31 (160)	11.63 (295)	6.25 (159)	8.13 (207)	9.31 (237)	0.50 (13)	0.25 (6)	2.03 (51.6)
		4P – 4P	(4) #10	13.27 (337)	8.53 (217)	6.31 (160)	11.63 (295)	6.25 (159)	8.13 (207)	9.31 (237)	0.50 (13)	0.25 (6)	2.03 (51.6)
	60 A	2P – 2P	(4) #10	12.13 (308)	8.53 (217)	6.31 (160)	11.63 (295)	6.25 (159)	8.13 (207)	9.31 (237)	0.50 (13)	0.25 (6)	2.03 (51.6)
		3P – 3P	(4) #10	12.13 (308)	8.53 (217)	6.31 (160)	11.63 (295)	6.25 (159)	8.13 (207)	9.31 (237)	0.50 (13)	0.25 (6)	2.03 (51.6)
		4P – 4P	(4) #10	13.27 (337)	8.53 (217)	6.31 (160)	11.63 (295)	6.25 (159)	8.13 (207)	9.31 (237)	0.50 (13)	0.25 (6)	2.03 (51.6)
3	100 A	2P – 2P	(4) 5/16	12.98 (330)	10.50 (267)	7.22 (183)	11.75 (299)	7.00 (178)	–	–	0.48 (122)	0.48 (122)	3.02 (76.7)
		3P – 3P	(4) 5/16	12.98 (330)	10.50 (267)	7.22 (183)	11.75 (299)	7.00 (178)	–	–	0.48 (122)	0.48 (122)	3.02 (76.7)
		4P – 4P	(4) 5/16	21.71 (551)	10.93 (278)	7.22 (183)	20.75 (527)	8.00 (203)	–	–	0.48 (122)	0.48 (122)	2.45 (62.2)
	150 A	2P – 2P	(4) 5/16	14.21 (361)	10.93 (278)	7.22 (183)	13.25 (337)	8.00 (203)	–	–	0.48 (122)	0.48 (122)	2.45 (62.2)
		3P – 3P	(4) 5/16	14.21 (361)	10.93 (278)	7.22 (183)	13.25 (337)	8.00 (203)	–	–	0.48 (122)	0.48 (122)	2.45 (62.2)
		4P – 4P	(4) 5/16	21.71 (551)	10.93 (278)	7.22 (183)	20.75 (527)	8.00 (203)	–	–	0.48 (122)	0.48 (122)	2.45 (62.2)

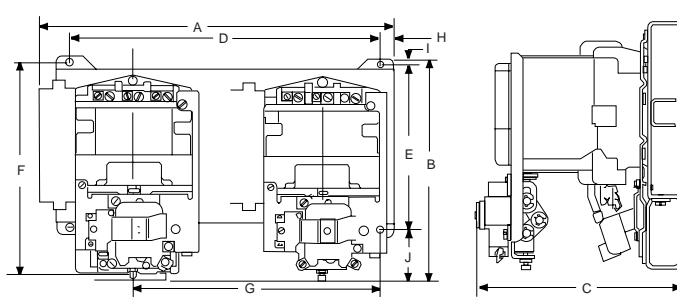

Figure 2

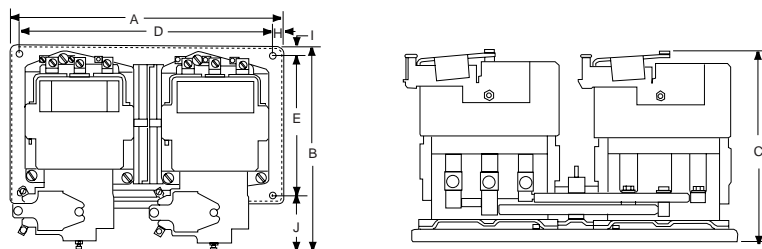





Figure 3



Square D Company
8001 Hwy 64 East
Knightdale, NC 27545
(919) 266-3671

Square D and  are registered trademarks of Square D Company.

 is a registered trademark of Underwriter's Laboratories, Inc.

 is a registered trademark of Canadian Standard Association.

VERSA-CRIMP is a registered trademark of Hubbell Incorporated.

NIGHT-MASTER is a trademark of Square D Company

Catalog No. 8903CT9701 January 1998 © 1998 Square D All Rights Reserved.