

Contents

3 Pole Contactors.....	2-2
4 Pole Contactors.....	2-20
Mini Contactors.....	2-37
Manual Motor Starters	2-42
Field Bus Plugs.....	2-49
Softstarters.....	2-54
Pilot Devices.....	2-58
Switching Power Supplies (CP Range)	2-72

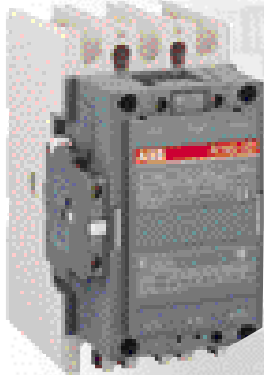

A..., AF..., 3-pole Contactors



a.c. Circuit Switching

Switching of 3-phase Cage Motors

AC-3 utilization category

When making, the motor current is about $6 \times I_N$.
Breaking while the motor is running at I_N motor F.L.C.

AC-3 Power rating	$\leq 55^\circ\text{C}, 400\text{ V}$
AC-3 Rated operational current	$\leq 55^\circ\text{C}, 400\text{ V}$ $\leq 55^\circ\text{C}, 415\text{ V}$ $\leq 55^\circ\text{C}, 690\text{ V}$

	A9	A12	A16	A26	A30	A40
kW	4	5.5	7.5	11	15	18.5
A	9	12	17	26	32	37
A	9	12	17	26	32	37
A	7	9	10	17	21	25

Switching of Resistive Circuits

AC-1 utilization category

When making, the switched-on current is equal to the I_N load rated current with $\cos = 0.95$.

AC-1 Rated operational current	$\leq 40^\circ\text{C}$ $\leq 55^\circ\text{C}$ $\leq 70^\circ\text{C}$
With conductor cross-sectional area	mm ²
Rated operational voltage	V

A	25	27	30	45	55	60
A	22	25	27	40	55	60
A	18	20	23	32	39	42
mm ²	2.5	4	4	6	10	16
V	690					

3-pole contactors

Selection & Ordering

- Select contactor type.
- Select contactor coil voltage on cover folding page 0/1, according to control circuit supply. (Please quote coil voltage in plain text).

a.c. Control circuit supply	Types	A9-30-10 A12-30-10 A16-30-10	A26-30-10 A30-30-10 A40-30-10
a.c. & d.c. Control circuit supply (Electronic coil interface)	Types	-	-
d.c. Control circuit supply	Types	AE9-30-00 AE12-30-00 AE16-30-00	AE26-30-00 AE30-30-00 AE40-30-00

Contactor Main Accessories

Selection & Ordering

- Select accessory type and quote required data in plain text.

Auxiliary contacts	CA 5-..., 1-pole CAL 5-..., 2-pole	Types	CA 5-10 1-pole, front mounting CA 5-01 1-pole, front
Timers	TP..., Pneumatic TE..., Electronic Supply voltages: 24 V a.c./d.c., 110 ... 120; 220 ... 240; 380 ... 440 V a.c.	Types	TP 40 DA, TP 180 DA Direct timing - Front mounting TP 40 TE5S Direct timing - Inde
Interlocks	VE 5-..., Mechanical / Electrical VM..., Mechanical mounting between 2 contactors	Types	VE 5-1 VM 5-1
Surge suppressors	RV..., (Varistor) a.c./d.c. RC..., (Capacitor) a.c.	Types	RV 5 RC 5-1

Protection of 3-phase motors

Selection & Ordering

- Select O/L relay type and setting range according to motor F.L.C.

O/L relays	TA..DU..., Thermal O/L relay E..DU..., Electronic O/L relay Standard starting time 2 ... 10 s tripping class 10 A	Types & setting range in Amps	<table border="1"> <thead> <tr> <th>TA 25 DU</th> <th>TA 42 DU</th> </tr> </thead> <tbody> <tr> <td>0.10...0.16¹</td> <td>1.0...1.4¹</td> </tr> <tr> <td>0.16...0.25</td> <td>1.3...1.8</td> </tr> <tr> <td>0.25...0.40</td> <td>1.7...2.4</td> </tr> <tr> <td>0.40...0.63</td> <td>2.2...3.1</td> </tr> <tr> <td>0.63...1.0</td> <td>2.8...4.0</td> </tr> <tr> <td></td> <td>3.5...5.0¹</td> </tr> <tr> <td></td> <td>4.5...6.5</td> </tr> <tr> <td></td> <td>6.0...8.5</td> </tr> <tr> <td></td> <td>7.5...11</td> </tr> <tr> <td></td> <td>10...14</td> </tr> <tr> <td></td> <td>13...19¹</td> </tr> <tr> <td></td> <td>18...25</td> </tr> <tr> <td></td> <td>24...32</td> </tr> <tr> <td></td> <td>22...32¹</td> </tr> <tr> <td></td> <td>29...42</td> </tr> </tbody> </table> <p>Please consult us for electronic solution</p>	TA 25 DU	TA 42 DU	0.10...0.16 ¹	1.0...1.4 ¹	0.16...0.25	1.3...1.8	0.25...0.40	1.7...2.4	0.40...0.63	2.2...3.1	0.63...1.0	2.8...4.0		3.5...5.0 ¹		4.5...6.5		6.0...8.5		7.5...11		10...14		13...19 ¹		18...25		24...32		22...32 ¹		29...42
TA 25 DU	TA 42 DU																																		
0.10...0.16 ¹	1.0...1.4 ¹																																		
0.16...0.25	1.3...1.8																																		
0.25...0.40	1.7...2.4																																		
0.40...0.63	2.2...3.1																																		
0.63...1.0	2.8...4.0																																		
	3.5...5.0 ¹																																		
	4.5...6.5																																		
	6.0...8.5																																		
	7.5...11																																		
	10...14																																		
	13...19 ¹																																		
	18...25																																		
	24...32																																		
	22...32 ¹																																		
	29...42																																		

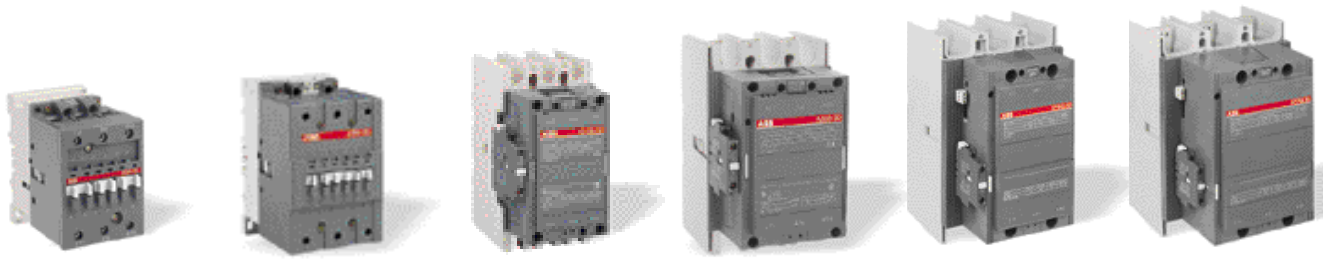

A50 A63 A75	A95 A110	A145 A185	A210 A260 A300	AF400 AF460	AF580 AF750
--------------------	-----------------	------------------	-----------------------	--------------------	--------------------

22 30 37	45 55	75 90	110 140 160	200 250	315 400
50 65 75	96 110	145 185	210 260 305	400 460	580 750
50 65 75	96 110	145 185	210 260 300	400 460	580 750
35 43 46	65 82	120 170	210 220 280	350 400	500 650
100 115 125	145 160	250 275	350 400 500	600 700	800 1050
85 95 105	135 145	230 250	300 350 400	500 600	700 800
70 80 85	115 130	180 180	240 290 325	400 480	580 720
35 50 50	50 70	120 150	185 240 300	2 x 185 2 x 240	2 x 240 <small>bar / mm</small> 2 x 80 x 5
1000			690		

A50-30-00 A63-30-00 A75-30-00	A95-30-00 A110-30-00	A145-30-11 A185-30-11	A210-30-11 A260-30-11 A300-30-11	AF400-30-11 AF460-30-11	AF580-30-11 AF750-30-11
AF50-30-00 AF63-30-00 AF75-30-00	AF95-30-00 AF110-30-00	AF145-30-11 AF185-30-11	AF210-30-11 AF260-30-11 AF300-30-11		

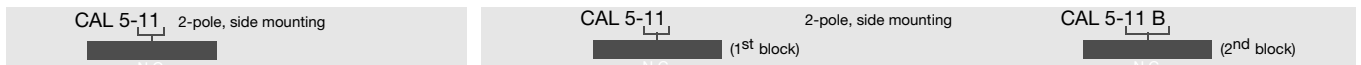

Inverse timing - Front mounting	TE5S Independent mounting	TE5S Direct timing - Independent mounting
---------------------------------	---------------------------	---

VE 5-2	VM 300H	VM 750H
--------	---------	---------

RV 5 RC 5-2	RC 5-2	The built-in coil interface eliminates the need of extra surge suppressors on these sizes
----------------	--------	---

TA 75 DU... 29...42 36...52 45...63 60...80	TA 80 DU... 60...80 TA 110 DU... 65...90 80...110	TA 200 DU... 130...175 150...200 E 200 DU 60...200	TA 450 DU... 165...235 220...310 E 320 DU 100...320	Please consult us for thermal solution	E 500 DU 150...500	E 800 DU 250...800
---	---	--	---	--	-----------------------	-----------------------

A 9 ... A 110 3-pole Contactors

a.c. Operated



Application

A 9 ... A 110 contactors are mainly used for controlling 3-phase motors and generally for controlling power circuits up to 690 V a.c. / 1000 V a.c. or 220 V d.c. / 440 V d.c. The contactors can also be used for many other applications such as isolation, capacitor switching, lighting.

Description

The A... series 3-pole contactors are of the block type design.

- Main poles and auxiliary contact blocks
 - A 9 ... A 40 1-stack contactors:**
 - 3 main poles,
 - 1 built-in auxiliary contact,
 - front and side mounted add-on auxiliary contact blocks.
 - A 50 ... A 110 contactors:**
 - 3 main poles,
 - front and side mounted add-on auxiliary contact blocks.
- Control circuit: a.c. operated with laminated magnet circuit
- Accessories: a wide range of accessories is available

Variants

- 4-pole: A 9 ... A 75 contactors (with 4 N.O. or 2 N.O. + 2 N.C. main poles).
- a.c./d.c. operated controlled supply: AF 50 ... AF 110 contactors.
- d.c. operated: AE 9 ... AE 40 contactors.
- d.c. operated with large coil voltage range: TAE 50 ... TAE 110 contactors (on application).
- contactors for capacitor switching (UA..., UA..-R types),

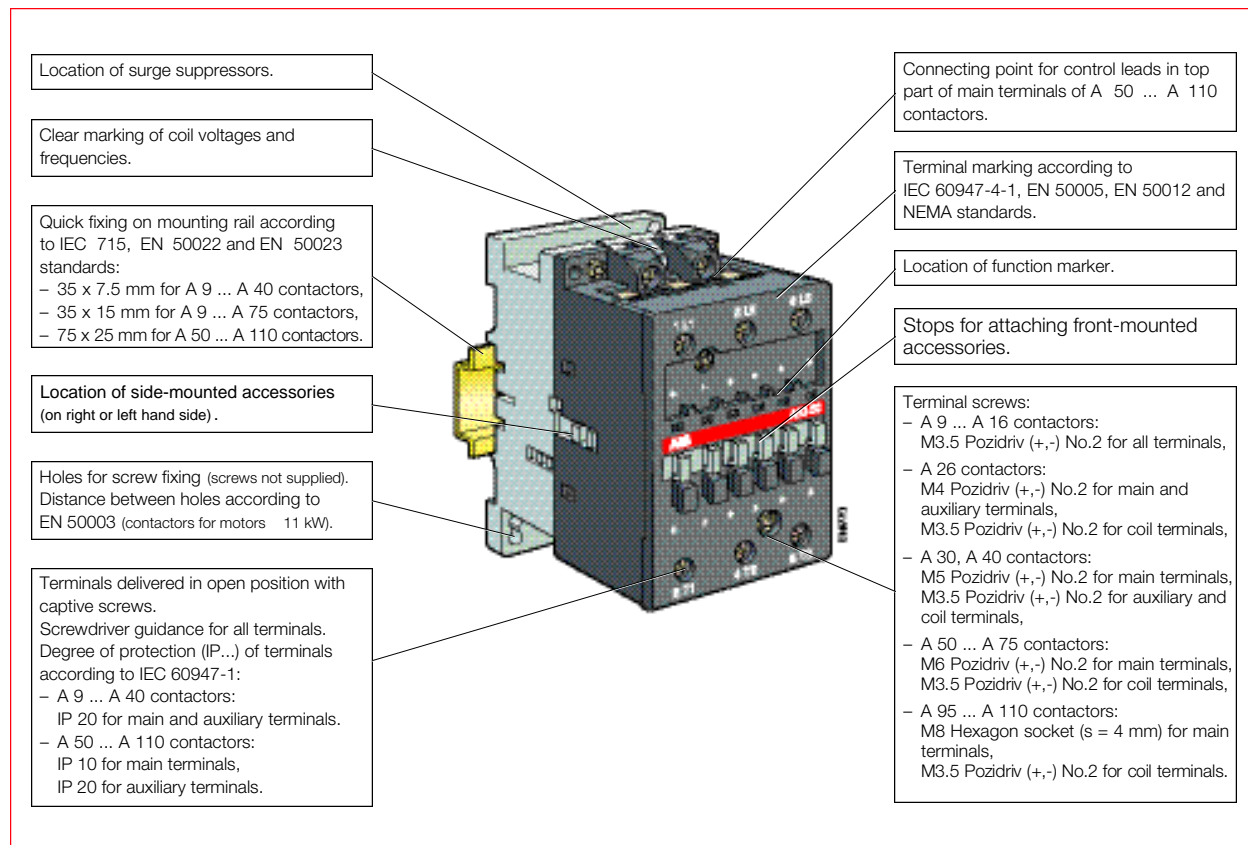

A 9 ... A 110 3-pole Contactors



a.c. Operated



Rated operational current		AC-1 40 °C KW	Auxiliary contacts fitted		Weight kg	Footprint			Order Code
AC-3 400 V A	AC-1 40 °C A		1st stack			H	W	D	
9	25	4	1	-	0.34	74	44	74	state coil voltage (see table below)
			-	1	0.34				A9.30.10 A9.30.01
12	27	5.5	1	-	0.34	74	44	74	A12.30.10 A12.30.01
			-	1	0.34				A16.30.10 A16.30.01
17	30	7.5	1	-	0.34	74	44	74	A26.30.10 A26.30.01
			-	1	0.60				A26.30.10 A26.30.01
26	45	11	1	-	0.60	90	54	94	A30.30.10 A30.30.01
			-	1	0.71				A40.30.10 A40.30.01
32	55	15	1	-	0.71	90	54	108	A50.30.11
			-	1	0.71				A63.30.11
37	60	18.5	1	-	0.71	90	54	108	A75.30.11
			-	1	2.04				A95.30.11
50	100	22	1	1	1.20	110	82	108	A110.30.11
			1	1	1.20				
65	115	37	1	1	1.20	110	82	108	
			1	1	1.20				
75	125	40	1	1	1.20	110	82	108	
			1	1	2.04				
96	145	45	1	1	2.04	148	102	124	
			1	1	2.04				
110	160	55	1	1	2.04	148	102	124	
			1	1	2.04				

Coil voltages

Voltage	Voltage
V - 50Hz	V - 60Hz
24	24
48	48
110	110 ... 120
220 ... 230	230 ... 240
230 ... 240	240 ... 260
380 ... 400	400 ... 415
400 ... 415	415 ... 440

Other voltages on application

A 9 ... A 110 3-pole Contactors

Main Accessories



Auxiliary Contact Blocks

Mounting on contactors	Positioning	Contacts	Weight kg	Order code
A 9 ... A 110	Front face	1 –	0.014	CA 5-10
		– 1	0.014	CA 5-01
A 9 ... A 40	Front face	3 1	0.060	CA 5-31 M
		2 2	0.060	CA 5-22 M
A 9 ... A 110	Side	1 1	0.050	CAL 5-11

Pneumatic Timers

Mounting on contactors	Timing range	Contacts	Weight kg	Order code
A 9 ... A 75	Direct 0.1 ... 40 s	1 1	0.070	TP 40 DA
	Direct 10 ... 180 s	1 1	0.070	TP 180 DA
	Inverse 0.1 ... 40 s	1 1	0.070	TP 40 IA
	Inverse 10 ... 180 s	1 1	0.070	TP 180 IA

Electronic Timers for star-delta starters (dwelling time 50 ms)

Mounting	Timing range	Supply voltage V	Weight kg	Order code
Independent	Direct	24 a.c. / d.c.	0.080	TE5S-24
		110 ... 120 a.c.	0.080	TE5S-120
	or	220 ... 240 a.c.	0.080	TE5S-240
		6 ... 60 s	380 ... 440 a.c.	0.080

Interlocks

Mounting on contactors	Feature	Contacts	Weight kg	Order code
A 9 ... A 40	Mech. / electrical	– 2	0.076	VE 5-1
A 50 ... A 110		– 2	0.146	VE 5-2
A 9 ... A 40	Mechanical	– –	0.066	VM 5-1

Note: Use type VE 5-2 for mechanical and electrical interlocking between A 40 and A 50 contactors.

Surge Suppressors

Mounting on contactors	Feature	Voltage range	Weight kg	Order code
A 9 ... A 110	Varistor	24 ... 50 V a.c./d.c.	0.015	RV 5/50
		50 ... 133 V a.c./d.c.	0.015	RV 5/133
		110 ... 250 V a.c./d.c.	0.015	RV 5/250
		250 ... 440 V a.c./d.c.	0.015	RV 5/440
A 9 ... A 40	RC	24 ... 50 V a.c.	0.012	RC 5-1/50
		50 ... 133 V a.c.	0.012	RC 5-1/133
		110 ... 250 V a.c.	0.012	RC 5-1/250
		250 ... 440 V a.c.	0.012	RC 5-1/440
A 50 ... A 110	RC	24 ... 50 V a.c.	0.015	RC 5-2/50
		50 ... 133 V a.c.	0.015	RC 5-2/133
		110 ... 250 V a.c.	0.015	RC 5-2/250
		250 ... 440 V a.c.	0.015	RC 5-2/440

Other Accessories

A wide range of accessories are available:

- various auxiliary contact blocks for specific controls and use,
- interface relays,
- connecting auxiliaries: strips, connectors, additional pieces, etc.
- impulse contact blocks, lamp holder and fuse holder blocks,
- function marker.

A 9 ... A 110 3-pole Contactors

Thermal O/L Relays

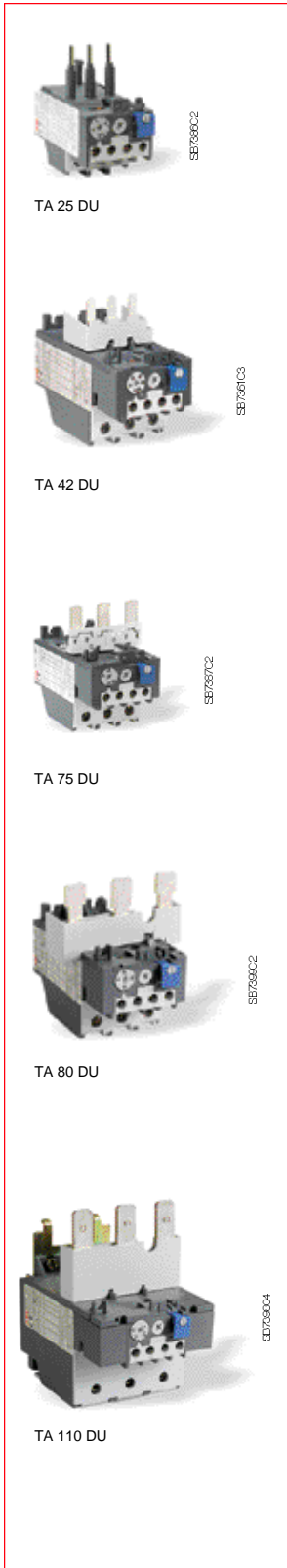

Thermal O/L Relays, Class 10A

For contactors:	Setting range	Weight kg	Order code
A 9 ... A 30	0.10 ... 0.16	0.150	TA 25 DU 0.16
	0.16 ... 0.25	0.150	TA 25 DU 0.25
	0.25 ... 0.40	0.150	TA 25 DU 0.4
	0.40 ... 0.63	0.150	TA 25 DU 0.63
	0.63 ... 1.00	0.150	TA 25 DU 1.0
	1.0 ... 1.4	0.150	TA 25 DU 1.4
	1.3 ... 1.8	0.150	TA 25 DU 1.8
	1.7 ... 2.4	0.150	TA 25 DU 2.4
	2.2 ... 3.1	0.150	TA 25 DU 3.1
	2.8 ... 4.0	0.150	TA 25 DU 4.0
A 30 ... A 40	3.5 ... 5.0	0.150	TA 25 DU 5.0
	4.5 ... 6.5	0.150	TA 25 DU 6.5
	6.0 ... 8.5	0.150	TA 25 DU 8.5
	7.5 ... 11	0.150	TA 25 DU 11
	10 ... 14	0.150	TA 25 DU 14
A 50 ... A 75	13 ... 19	0.150	TA 25 DU 19
	18 ... 25	0.150	TA 25 DU 25
	24 ... 32	0.170	TA 25 DU 32
	18 ... 25	0.330	TA 42 DU 25
A 95 ... A 110	22 ... 32	0.330	TA 42 DU 32
	29 ... 42	0.330	TA 42 DU 42
	18 ... 25	0.330	TA 75 DU 25
	22 ... 32	0.330	TA 75 DU 32
	29 ... 42	0.330	TA 75 DU 42
A 30 ... A 40	36 ... 52	0.330	TA 75 DU 52
	45 ... 63	0.330	TA 75 DU 63
	60 ... 80	0.330	TA 75 DU 80
	29 ... 42	0.360	TA 80 DU 42
	36 ... 52	0.360	TA 80 DU 52
	45 ... 63	0.360	TA 80 DU 63
	60 ... 80	0.360	TA 80 DU 80
A 50 ... A 75	65 ... 90	0.750	TA 110 DU 90
	80 ... 110	0.750	TA 110 DU 110

Separate Mounting Kit

For O/L relays:	Weight kg	Order code
TA 25 DU 25	0.050	DB 25/25 A
TA 25 DU 32	0.075	DB 25/32 A
TA 42 DU, TA 75 DU, TA 80 DU	0.170	DB 80
TA 110 DU	0.230	DB 200

A 145 ... AF 750 3-pole Contactors

a.c. Operated - A 145 ... A 300 Contactors

a.c. / d.c. Operated - AF 400 ... AF 750 Contactors

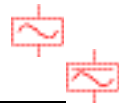

Application

A 145 ... AF 750 contactors are mainly used for controlling 3-phase motors and generally for controlling power circuits up to 690 V a.c. or 220 V d.c. / 600 V d.c. The contactors can also be used for many other applications such as isolation, bypass, capacitor switching, lighting...

Description

The **A 145 ... AF 750** 3-pole contactors are of the block type design.

- Main poles and auxiliary contact blocks
 - 3 main poles,
 - 1 N.O. and 1 N.C. auxiliary contact block (fitted on the left side).

A maximum of 4 auxiliary contact blocks can be fitted on each contactor.
- Control circuit:
 - A 145 ... A 300** contactors: a.c. operated with laminated magnet circuit,
 - AF 400 ... AF 750** contactors: a.c. operated, large voltage range, with electronic coil interface, with laminated magnet circuit.

Contactors AF 400 ... AF 750 are fitted as standard with an electronic coil interface which accepts a wide control voltage range for a.c. 50/60 Hz supply or d.c. supply.

- Accessories: a wide range of accessories is available.

Variants ⇨ next pages in this section

- a.c./d.c. operated, large voltage range, with electronic coil interface: AF 145 ... AF 300 contactors.

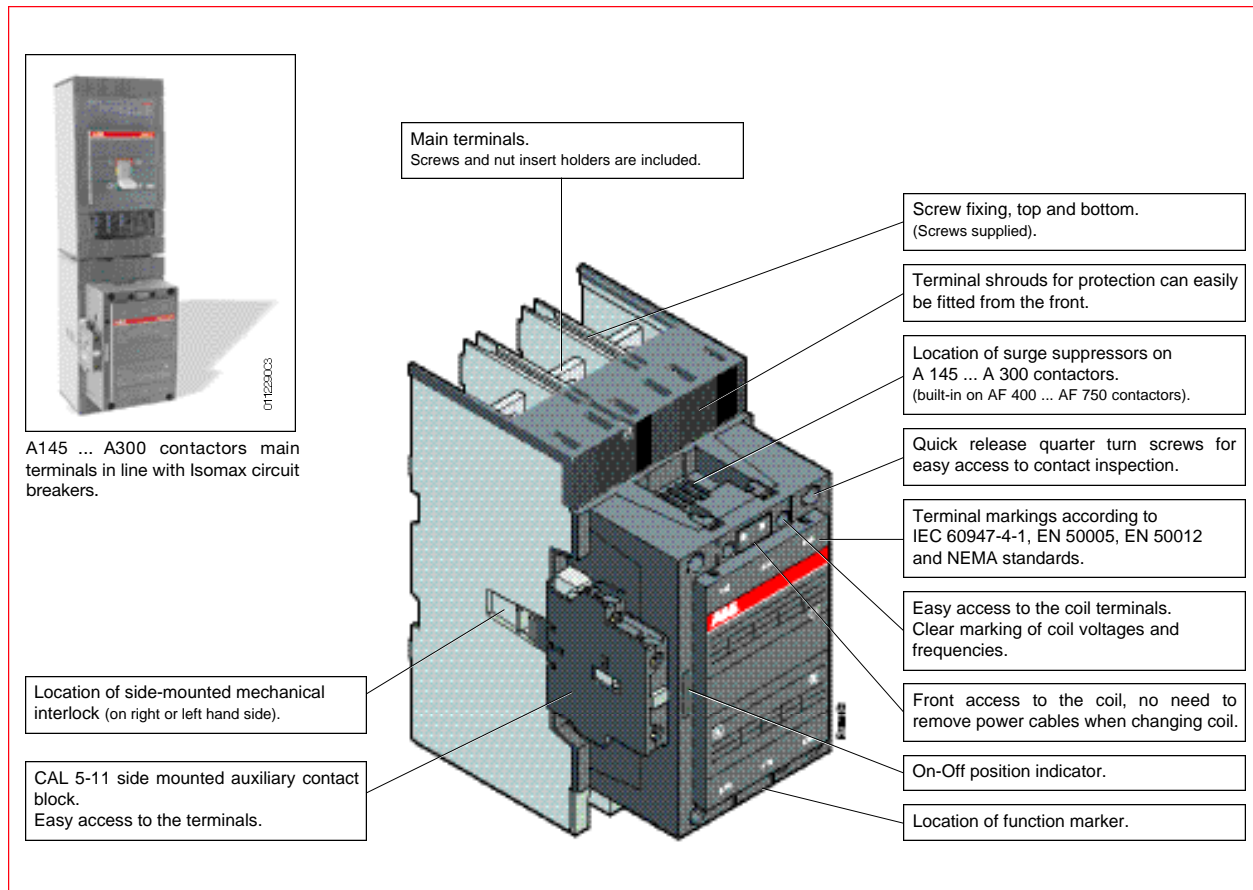

A 145 ... AF 750 3-pole Contactors

a.c. Operated - A 145 ... A 300 Contactors

a.c. / d.c. Operated - AF 400 ... AF 750 Contactors

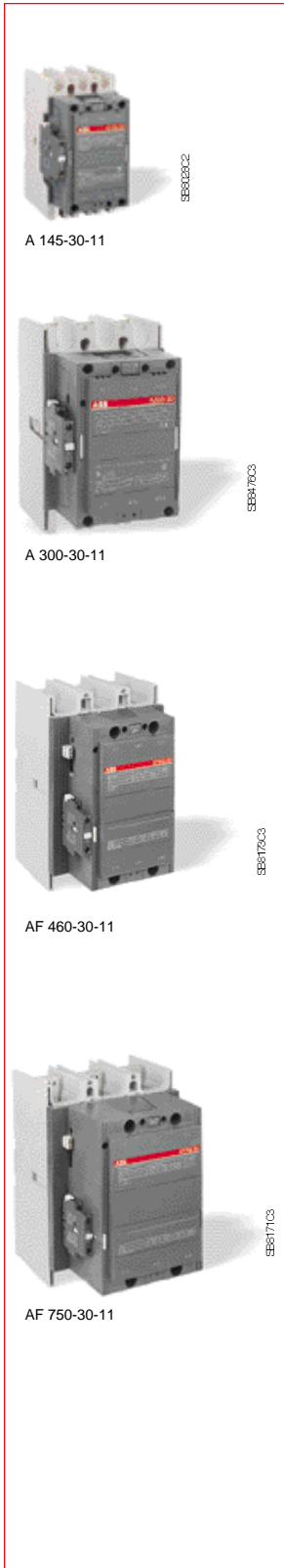
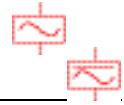

Rated operational current		Auxiliary contacts fitted		Footprint			Weight kg	Order code state coil voltage (see table below)
AC-3 400 V A	AC-1 40 °C A			H	W	D		
145	250	1	1	196	112	160	3.500	A 145-30-11
185	275	1	1	196	112	160	3.500	A 185-30-11
210	350	1	1	227	140	181	6.100	A 210-30-11
260	400	1	1	227	140	181	6.100	A 260-30-11
305	500	1	1	227	140	181	6.100	A 300-30-11
400	600	1	1	278	186	216	12.00	AF 400-30-11
460	700	1	1	278	186	216	12.00	AF 460-30-11
580	800	1	1	283	210	242	15.00	AF 580-30-11
750	1050	1	1	283	210	242	15.00	AF 750-30-11

Coil voltages

Voltage V - 50Hz	Voltage V - 60Hz
24	24
48	48
110	110 ... 120
220 ... 230	230 ... 240
230 ... 240	240 ... 260
380 ... 400	400 ... 415
400 ... 415	415 ... 440

Other voltages on application

Coil voltages: AF 400 ... AF 750

Voltage V - 50/60Hz	Voltage V d.c.
-	24 ... 60
48 ... 130	48 ... 130
100 ... 250	100 ... 250

⁽¹⁾ The connection polarities indicated close to the coil terminals must be respected: A1 for the positive pole and A2 for the negative pole. AF... contactors with electronic coil interface: electromagnetic compatibility and A or B environment definitions + page ????

A 145 ... AF 750 3-pole Contactors

Main accessories



CAL 5-11

5B7376C2



TE5S-240

5B7556C2

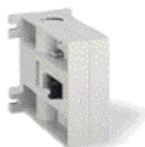

VM 300H

5B8041C1



RC...

5B8050C2



LT...-AC

1SFT1801009-018C3

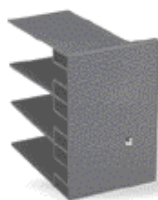

LT...-AL

1SFT1801009-125

Auxiliary Contact Blocks

Mounting on contactors	Positioning	Contacts	Weight kg	Order Code
A 145 to	Side	1 1	0.050	CAL 5-11
AF 750		1 1	0.050	CAL 5-11B

Electronic Timers for star-delta starters (dwelling time 50 ms) - (Prohibited with AF... contactors)

Mounting	Timing range	Supply voltage V	Weight kg	Order Code
Independent	Direct	24 a.c. / d.c.	0.080	TE5S-24
		110 ... 120 a.c.	0.080	TE5S-120
	or	220 ... 240 a.c.	0.080	TE5S-240
		380 ... 440 a.c.	0.080	TE5S-440
	6 ... 60 s			

Interlocks for two horizontal mounted contactors

Left contactor	Right contactor	Feature	Weight kg	Order Code
A 95 ... 300	A 145 ... 300	Mechanical	0.150	VM 300H
A 210 ... 300	AF 400 ... 460	Mechanical	0.150	VM 300/460H
AF 400 ... 750	AF 400 ... 460	Mechanical	0.200	VM 750H

Surge Suppressors

Mounting on contactors	Feature	Voltage range	Weight kg	Order Code
A 145 ... 300	RC	24 ... 50 V a.c.	0.015	RC 5-2/50
		50 ... 133 V a.c.	0.015	RC 5-2/133
		110 ... 250 V a.c.	0.015	RC 5-2/250
		250 ... 440 V a.c.	0.015	RC 5-2/440

Note: The built-in coil interface eliminates the need of extra surge suppressors on the AF 400 to AF 750 contactors.

Shrouds (terminal protection acc. to VDE 0106, part 100) (pack of 2)

Mounting on contactors	Suitable for contactor with	Weight kg 1 piece	Order Code
A 145, A 185	Cable connectors	0.100	LT 185-AC
A 145, A 185	Cable lugs	0.100	LT 185-AL
A 210 ... A 300	Cable connectors	0.100	LT 300-AC
A 210 ... A 300	Cable lugs	0.100	LT 300-AL
AF 400, AF 460	Cable connectors	0.150	LT 460-AC
AF 400, AF 460	Cable lugs	0.800	LT 460-AL
AF 580, AF 750	Cable connectors	0.150	LT 750-AC
AF 580, AF 750	Cable lugs	0.850	LT 750-AL

Other Accessories

A wide range of accessories are available:

- LZ... connectors,
- LW... enlargement pieces for terminals,
- connecting auxiliaries: shorting bars, connection bars, additional pieces, etc.
- shrouds for shorting bars,
- interlocks for two vertical contactors,
- adapter plates.

A 145 ... AF 750 3-pole Contactors

Thermal & Electronic O/L Relays

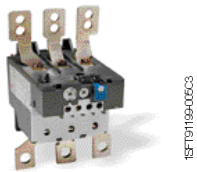

TA 200 DU

13FT10199400C3



TA 450 DU

5B8048C3



E 320 DU

5B8175C3

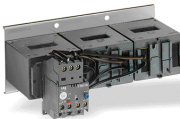

E 800 DU

5B8178C4



A 185 contactor with
E 200 DU electronic O/L relay and
LT 200 E terminal shroud

01628201111C3

Thermal O/L Relays, Class 10A

For contactors:	Setting range A	Weight kg	Order code
A 145, A 185	66 ... 90	0.750	TA 200 DU 90
	80 ... 110	0.750	TA 200 DU 110
	100 ... 135	0.750	TA 200 DU 135
	110 ... 150	0.750	TA 200 DU 150
	130 ... 175	0.750	TA 200 DU 175
	150 ... 200	0.750	TA 200 DU 200
A 210 ... A 300	130 ... 185	1.500	TA 450 DU 185
	165 ... 235	1.500	TA 450 DU 235
	220 ... 310	1.500	TA 450 DU 310
AF400...AF750	Please consult us for thermal solution		

Electronic O/L Relays, Adjustable Class 10, 20 and 30

For contactors:	Setting range A	Weight kg	Order code
A 145, A 185	60 ... 200	1.120	E 200 DU
A 210 ... A 300	100 ... 320	1.260	E 320 DU
AF 400, AF 460	150 ... 500	1.210	E 500 DU
AF 580, AF 750	250 ... 800	4.240	E 800 DU

Kit for Mounting on the Contactors

For contactors:	For O/L relays:	Weight kg	Order code
A 145, A 185	TA 450 DU/SU	0.500	DT 450/A 185
A 210 ... A 300		0.750	DT 450/A 300
AF 400, AF 460	E 500 DU	0.720	DT 500/AF 460 S
AF 580, AF 750	E 800 DU	1.400	DT 800/AF 750 S

Separate Mounting Kit

For O/L relay:	Weight kg	Order code
TA 200 DU	0.230	DB 200

Terminal Shrouds for TA 200 DU Thermal O/L Relay

Fitting	Weight kg	Order code
Load side	0.070	LT 200/A
Between TA 200 DU and A 145, A 185	0.050	LT 185-AY

Terminal Shrouds for Electronic O/L Relay

For electronic O/L relay	Weight kg	Order code
E 200 DU	0.120	LT 200 E
E 320 DU	0.120	LT 320 E
E 500 DU	0.240	LT 500 E
E 800 DU	0.240	LT 800 E

AF 50 ... AF 750 3-pole Contactors

a.c. / d.c. Operated - Large Voltage Range

Electronic Coil Interface



Application

AF 50 ... AF 750 contactors are mainly used for controlling 3-phase motors and generally for controlling power circuits up to 690 V a.c. or 220 V d.c. / 600 V d.c. The contactors can also be used for many other applications such as bypass, capacitor switching, lighting, d.c. power circuits...

The AF... contactors are fitted with an electronic coil interface which accepts a wide control voltage range, on a.c. 50/60 Hz or d.c. supplies. The same contactor can accept various supply voltages according to different countries where the final machine will be used or some fluctuation in the control voltage due to the local supply or network.

The AF... contactors are also fully suitable for operation in a.c. or d.c. control circuit liable to voltage interruptions or voltage dip risks.

Description

The AF 50 ... AF 750 3-pole contactors are of the block type design.

- Main poles and auxiliary contact blocks
 - 3 main poles,
 - AF50 ... AF110 front and side mounted add on auxiliary contact blocks
 - AF145 ... AF750 1 N.O. and 1 N.C. auxiliary contact block (fitted on the left side).
- A maximum of 4 auxiliary contact blocks can be fitted on each contactor.

• Electronic control:

The contactors are fitted with an electronic interface that very precisely controls the voltage to the coil. The electronic control circuit always works using d.c. current through the coil and in a.c. operation the current is rectified before being applied to the coil. To achieve the levels of the currents required for making and holding respectively, the voltage is pulsed across the coil with the aid of a transistor. The pulsing also implies that the current in the coil can be optimally regulated all the time relatively independently of the voltage level. The function is controlled by a specific integrated circuit developed by ABB.

• Advantages

- Wide voltage range, e.g. 100 ... 250 V a.c. and d.c.,
- Can manage large voltage variations,
- Reduced power consumption,
- Very distinct closing and opening,
- Noise free,
- Can withstand voltage interruptions or voltage dips in the control supply (< 20 ms).

• Control inputs

The large sizes AF 400 ... AF 750 are as standard equipped with low voltage inputs for control, for example by a PLC (+ see drawing below).

- Accessories: a wide range of accessories is available.

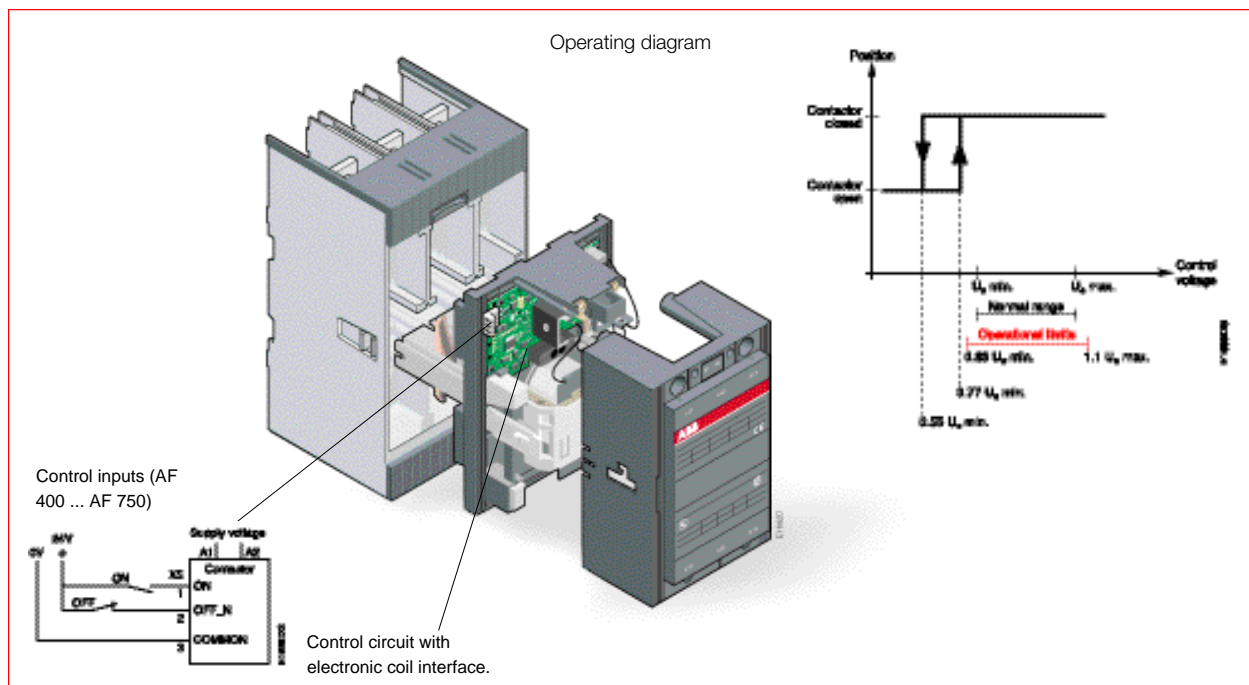

AF 50 ... AF 750 3-pole Contactors



a.c. / d.c. Operated - Large Voltage Range

Electronic Coil Interface

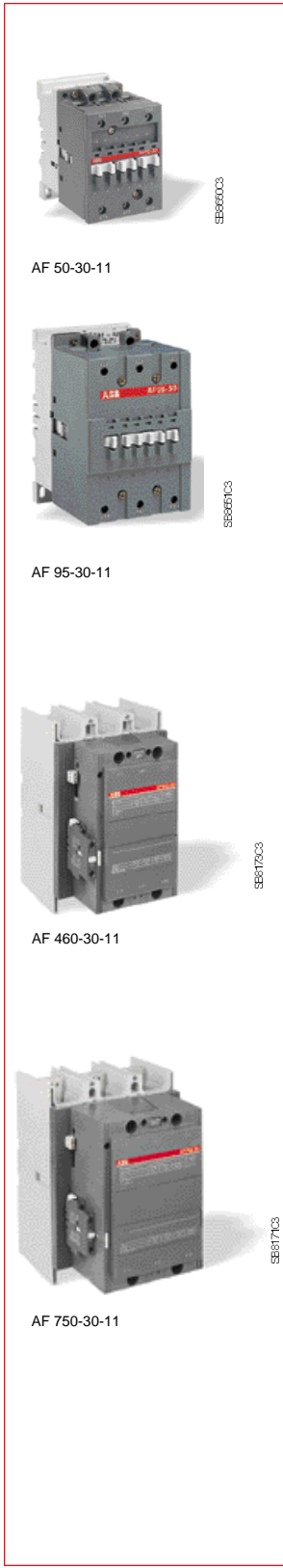

Rated operational current	AC-3 400 V A	AC-1 40 °C A	Auxiliary contacts fitted	Footprint			Weight kg	Order Code
				H	W	D		
								state coil voltage
50	100		1 1	110	82	108	1.220	AF 50-30-11
65	115		1 1	110	82	108	1.220	AF 63-30-11
75	125		1 1	110	82	108	1.220	AF 75-30-11
96	145		1 1	148	102	124	2.070	AF 95-30-11
110	160		1 1	148	102	124	2.070	AF 110-30-11
145	250		1 1	196	112	160	3.600	AF 145-30-11
185	275		1 1	196	112	160	3.600	AF 185-30-11
210	350		1 1	227	140	181	6.200	AF 210-30-11
260	400		1 1	227	140	181	6.200	AF 260-30-11
305	500		1 1	227	140	181	6.200	AF 300-30-11
400	600		1 1	278	186	216	12.00	AF 400-30-11
460	700		1 1	278	186	216	12.00	AF 460-30-11
580	800		1 1	283	210	242	15.00	AF 580-30-11
750	1050		1 1	283	210	242	15.00	AF 750-30-11

Coil voltages: AF 50 ... AF 300

Voltage	Voltage
V - 50/60Hz	V d.c.
—	20 ... 60
48 ... 130	48 ... 130
100 ... 250	100 ... 250

(1) The connection polarities indicated close to the coil terminals must be respected: A1 for the positive pole and A2 for the negative pole.

Coil voltages: AF 400 ... AF 750

Voltage	Voltage
V - 50Hz	V d.c.
—	24 ... 60
48 ... 130	48 ... 130
100 ... 250	100 ... 250

(1) The connection polarities indicated close to the coil terminals must be respected: A1 for the positive pole and A2 for the negative pole.

Electromagnetic compatibility:

AF... contactors comply with international standards IEC 60947-1 (2000-10-Ed.3.1), 60947-4-1 (2000-11-Ed.2) and European standards EN 60947-1, 60947-4-1.

Notice: This product has been designed for environment A. Use of this product in environment B may cause unwanted electromagnetic disturbances in which case the user may be required to take adequate mitigation measures.

Definitions:

Environment A: "Mainly relates to low-voltage non public or industrial networks/locations/installations (+ EN 50082-2 article 4) including highly disturbing sources".

Environment B: "Mainly relates to low-voltage public networks (+ EN 50082-1 article 5) such as residential, commercial and light industrial locations/installations. Highly disturbing sources such as arc welders are not covered by this environment".

AE 3-pole Contactors

d.c. Operated with Double - Winding coil



5E800803

Application

AE9 ... AE 40 contactors are mainly used for controlling 3-phase motors and generally for controlling power circuits up to 690 V a.c. or 220 V d.c. / 440 V d.c.

Description

The AE... series 3-pole contactors are d.c. operated contactors.

- Main poles and auxiliary contact blocks
 - 3 main poles,
 - front and side mounted add-on auxiliary contact blocks.

auxiliary contacts for safety circuits page x/xx
- Control circuit: laminated magnet circuit and double-winding coil fed from d.c. supply via an insertion contact mounted on the device
 - AE9 ... AE40: built-in lagging contact for insertion of the second winding
- Accessories: a wide range of accessories are available

AE... contactors specific design

- AE 9 ... AE 40: Built-in lagging contact for insertion of the "holding" winding

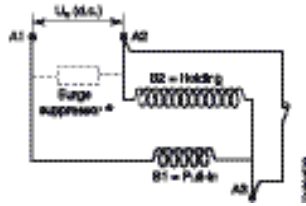

* Addition of RT 5 or RV 5 surge suppressor, if required. Please order separately

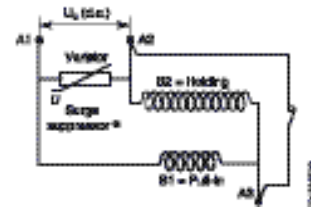

* RV 5 surge suppressor fitted as standard (RT 5 type on request).

Coil voltages:
AE...

Voltage - U_C

V d.c.

12

24

42

48

50

60

75

110

125

220

240

250

Rated operational current	Auxiliary contacts fitted	Footprint			Order Code
		H	W	D	
AC-3 400 V A	AC-1 40 °C A				state coil voltage
9	25	-	-	74 44 74	AE 9-30-00
12	27	-	-	74 44 74	AE 12-30-00
16	30	-	-	74 44 74	AE 16-30-00
26	45	-	-	90 54 94	AE 26-30-00
32	55	-	-	90 54 108	AE 30-30-00
37	60	-	-	90 54 108	AE 40-30-00

For d.c. operation with solid magnetic circuit please consult us.

For accessories see main accessories A9 - A110 page x/xx

Connection Sets

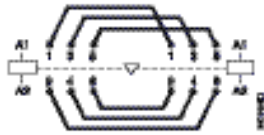

BEM... connections



BEM 75-30



BEM 300-30



BES... for 3-pole connections

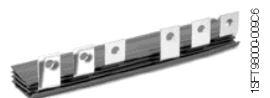

BES...

Connections for Reversing Contactors

Application

Connections between the main poles of two 3-pole contactors mounted side by side so that they operate as reversing contactors.

Description

The sets are made up of three upstream connections and three downstream connections.

- BEM 16-30 – Insulated, solid, rigid copper wires
- BEM 26-30, BEM 40-30 – Insulated, stranded, rigid copper wires
- BEM 75-30 ... BEM 750-30 – Insulated, solid copper bars
- BSM 16-30, BSM 25-30 BC and BSM 30-30 BC – Insulated, solid, rigid copper wires

On the A... contactors, the power supply by bars or cables equipped with lugs is directly connected to the terminal pads of the main poles. For flange connectors (+ page ????), LX... terminal extension pieces should be used (+ page ????).

Mounting on 3-pole contactors	Weight kg 1 set	Order code
A 9 ... A 16	0.025	BEM 16-30
A 26	0.056	BEM 26-30
A 30, A 40	0.096	BEM 40-30
A 50 ... A 75	0.243	BEM 75-30
A 95, A 110	0.450	BEM 110-30
A145, A 185	0.900	BEM 185-30
A 210 ... A 300	1.100	BEM 300-30
AF 400, AF 460	4.400	BEM 460-30
AF 580, AF 750	7.300	BEM 750-30
BC 9, BC 16	0.015	BSM 16-30
BC 25	0.020	BSM 25-30 BC
BC 30	0.025	BSM 30-30 BC

Note: The connections provided for the A... contactors can be used for the AF, AE and TAE types.
The connections provided for the BC... contactors can be used for the TBC types.

3-pole Connections Phase to Phase

Application

Connections between the main poles of two 3-pole contactors horizontal mounted.

Description

This set is made up of three downstream or upstream connections.

Mounting on 3-pole contactors	Weight kg 1 set	Order code
A 50 ... A 75	0.130	BES 75-30
A 95, A 110	0.250	BES 110
A 145, A 185	0.500	BES 185
A 210 ... A 300	1.000	BES 300
AF 400, AF 460	2.200	BES 460
AF 580, AF 750	3.700	BES 750

Note: The connections provided for the A... contactors can be used for the AF, AE and TAE types.

BED... Connection Sets

Connections for Star-Delta Starters

Application

Connections between the main poles of a star-delta starter.

Description

These sets are made up of:

- Three line contactor / delta contactor connections - Upstream side.
- Three connections for star and delta contactors mounting joined side by side - Downstream side.
- The necessary elements to create the star point upstream of the star contactor.

- BED 16, BED 26 – Insulated, solid copper wires.
- BED 40 – Insulated, stranded solid copper wires.
- BED 50, BED 75 – Solid copper bars and insulated stranded copper wires.
- BED 95 ... BED 750 – Insulated, solid copper bars.

BED kits are designed to accommodate mechanical interlock

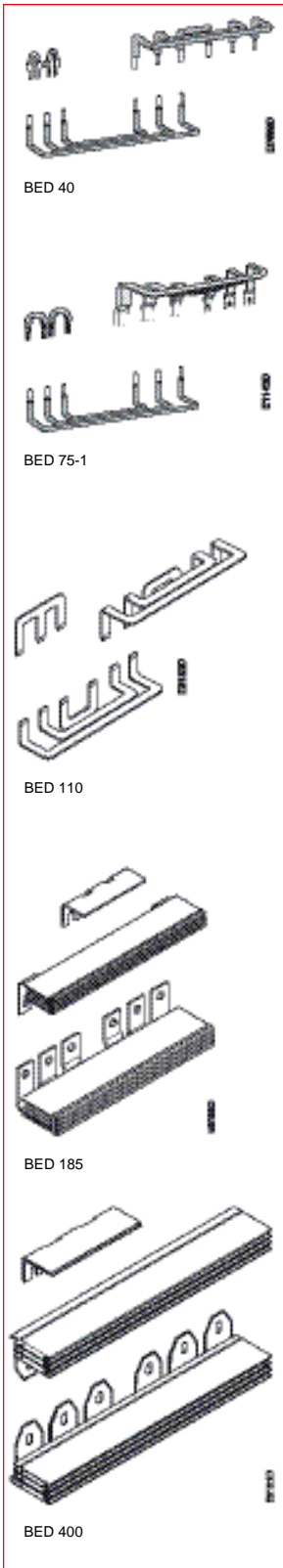

For contactors Line and Delta	Star	Weight kg	Order code
A 9	A 9		
A 12	A 9	0.040	BED 16
A 16	A 12		
A 26	A 16	0.045	BED 26
A 30	A 26		
A 40	A 26	0.070	BED 40
A 50	A 30		
A 63	A 40	0.180	BED 50
A 75	A 50	0.180	BED 75
A 95	A 75	0.400	BED 95
A 110	A 95	0.500	BED 110
A 145	A 110	1.300	BED 145 A
A 185	A 145	1.100	BED 185
A 210	A 185	1.500	BED 210
A 260, A 300	A 210, A 260	2.100	BED 300
AF 400 / AF 460	A 260 / A 300	3.500	BED 400
AF 460	AF 400	4.700	BED 460
AF 580	AF 460 / AF 400	6.300	BED 580
AF 750	AF 580	7.700	BED 750

Note: The connections provided for A... contactors can be used for the AF, AE, and TAE types.

Star-Delta Starting of Three-Phase Asynchronous Motors

Controlgear Selection Guide

Ambient temperature = 55 °C.

Please consult us for type 1&2 coordinates combinations

Motor power, kW						Max. starting time from cold (3) seconds	Contactors			O/L Relay (1)	Timer	Set of power connections	
220-230 V	240 V	380-400 V	415 V	500 V	660-690 V		KM1 Main	KM3 Delta	KM2 Star				
4	4	7.5	7.5	5.5	5.5	15	A 9	A 9	A 9	TA 25 DU	TE5S	BED 16 (4)	
5.5	5.5	11	11	7.5	7.5	15	A 12	A 12	A 9	TA 25 DU	TE5S	BED 16 (4)	
9	11	15	15	15	11	15	A 16	A 16	A 12	TA 25 DU	TE5S	BED 16 (4)	
12.5	12.5	22	22	22	15	15	A 26	A 26	A 16	TA 25 DU	TE5S	BED 26 (4)	
15	15	25	25	25	18.5	15	A 30	A 30	A 26	TA 25 DU	TE5S	BED 40 (4)	
18.5	22	37	37	37	37	30	A 40	A 40	A 26	TA 42 DU	TE5S	BED 40 (4)	
25	25	45	45	45	45	30	A 50	A 50	A 30	TA 75 DU	TE5S	BED 50 (4)	
30	33	55	55	63	59	30	A 63	A 63	A 40	TA 75 DU	TE5S	BED 50 (4)	
37	40	63	70	75	63	30	A 75	A 75	A 50	TA 75 DU	TE5S	BED 75 (4)	
45	45	75	75	90	90	20	A 95	A 95	A 75	TA 110 DU	TE5S	BED 95 (5)	
55	59	90	100	110	132	20	A 110	A 110	A 95	TA 110 DU	TE5S	BED 110 (5)	
75	75	132	132	160	160	20	A 145	A 145	A 110	TA 200 DU	TE5S	BED 145 (5)	
90	90	160	160	200	250	20	A 185	A 185	A 145	TA 200 DU	TE5S	BED 185 (5)	
110	110	200	200	250	315	20	A 210	A 210	A 185	TA 450 DU	TE5S	BED 210 (5)	
140	140	220	250	295	355	20	A 260	A 260	A 210	TA 450 DU	TE5S	BED 300 (5)	
160	160	250	250	355	450	20	A 300	A 300	A 260	TA 450 DU	TE5S	BED 300 (5)	
180	200	355	355	450	560	20	AF 400	AF 400	A 260	E 500 DU	(2)	BED 400 (5)	
250	250	450	475	560	670	20	AF 460	AF 460	A 300	E 500 DU	(2)	BED 400 (5)	
315	315	560	600	700	750	20	AF 580	AF 580	AF 400	E 800 DU	(2)	BED 580 (5)	
400	400	670	670	750	900	20	AF 750	AF 750	AF 460	E 800 DU	(2)	BED 580 (5)	

(1) The setting current value is: nominal motor current x 0.58.

(2) Contactor Relay type N + TP timer can be used as the AF contactors have a slight delay in closing.

(3) Usual time value = 6 ... 10 s.

(4) Version without space for mechanical interlock.

(5) Version with space for mechanical interlock.

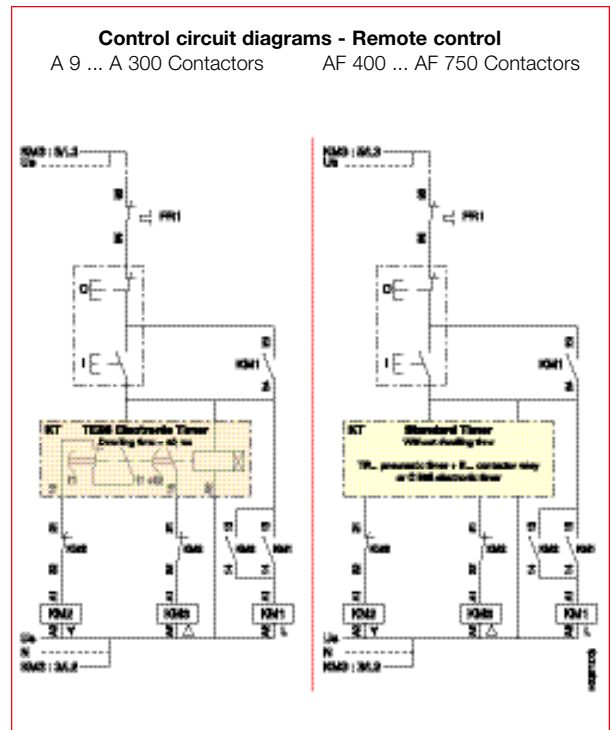
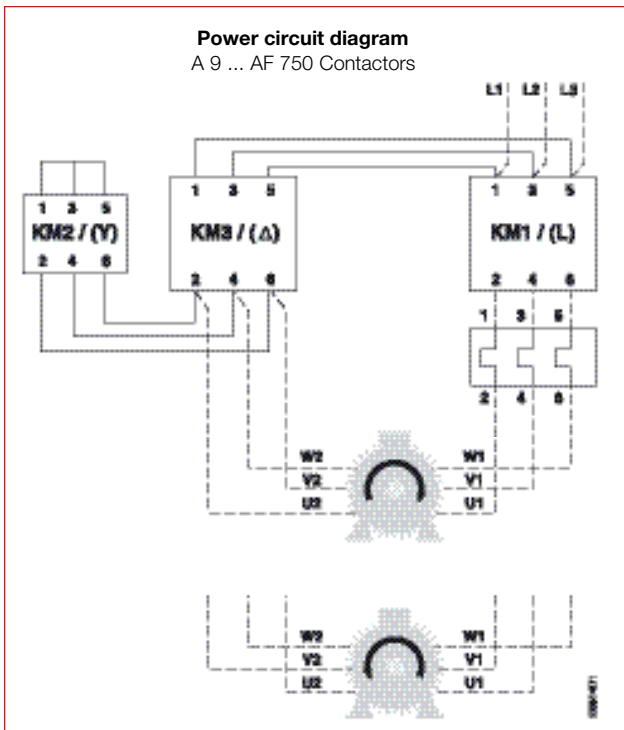

Star-Delta Starting of Three-Phase Asynchronous Motors

General

When starting, the motor has to overcome the load torque and inertia of the driven machine. During this phase, current must remain within the limits acceptable by the mains.

Inertia, load torque and mains are commonly fixed data.

Although the type of starting reduces the inrush current as required, it also reduces the torque supplied by the motor. The result is a starting time that varies according to the starting process used.

Star-delta starting

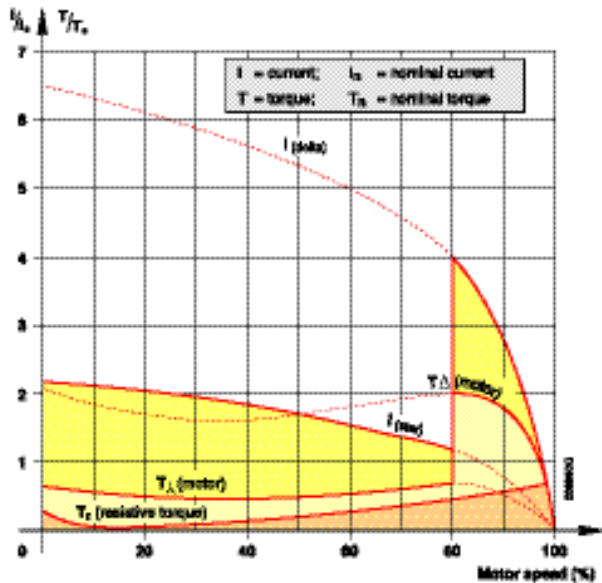

Technical Data

When starting:

- inrush current is reduced to a third of direct starting current,
- motor torque is reduced to a third or even less of direct starting torque.

Transient currents are commonly read during star-delta switching.

Utilization

During the initial starting phase ("star" connection), the resistive torque of the driven machine must remain, irrespective of speed, less than the "star" motor torque until "star-delta" switching occurs.

This starting mode is therefore ideal for machines with no-load starting:

- machine-tools,
- centrifugal compressors,
- wood working machines, etc.

In order to prevent a high current peak, at least 80 - 85 % of nominal speed must be reached before switching from star to delta.

Precautions

Motor nominal voltage in delta connection must be equal to that of the mains.

Example:

A motor for 400 V star-delta starting must be designed for 400 V in "delta" connection. Its usual designation is "400 V / 690 V motor". The motor must be constructed with 6 terminal windings.

Sequence

Starting is a three-stage process:

1st stage - "Star" connection

Press the "On" button on the control circuit to close the KM2 "star" contactor. The KM1 "line" contactor then closes and the motor starts. Countdown of programmed starting time (normally 6 to 10 s) then begins.

2nd stage - "Star" to "Delta" switching

When the programmed starting time is over, the KM2 "star" contactor opens.

3rd stage - "Delta" connection

A transition time (or dwelling time) of 50 ms is fixed between opening of the "star" contactor and closing of the "delta" contactor by the use of TE5S timer. This prevents short circuit between "star" and "delta".

Note: When AF... contactor types are used as delta and star contactors or an A... contactor as star contactor with an AF... contactor as delta contactor, the use of a timer including a dwelling time (or transition time) e.g. TE5S or similar is not necessary. A timer set for the starting duration in star connection is enough. An electrical interlock between star and delta is mandatory such as VE 5 or through auxiliary contacts.

Furthermore, in open transition, the current interruption may reach up to 95 ms: it shall be checked that this duration is compatible with the application i.e. mainly if the decreasing in rotation speed is acceptable during the starting phase.

Connection Bars for Contactor and MCCB

Connection Bars for Contactor and Switch fuse



Application

Connections between contactors/starters and moulded case circuit breakers or switch fuses.

Description

These connection sets are solid copper bars either isolated or protected by shrouds.

Connection bars between contactor and MCCB

Vertical assembly

Contactors	MCCB	Weight kg	Order code
A 145, A 185	T 3	0.150	BEA 185/T3
A 145, A 185	S 3, S 4	0.150	BEA 185/S3/S4
A 210	S 4	0.160	BEA 210/S4
A 210 ... A 300	S 5	0.200	BEA 300/S5
AF 400, AF 460	S 5	0.250	BEA 400/S5
AF 400 ... AF 750	S 6	0.410	BEA 750/S6

Vertical assembly with control wire terminals (Also suitable when using busbar kits for starter combinations)

A 145, A 185	T 3	0.175	BEA 185 D/T3
A 145 ... A 185	S 3, S 4	0.200	BEA 185D/S3/S4
A 210	S 4	0.270	BEA 210D/S4
A 210 ... A 300	S 5	0.320	BEA 300D/S5
AF 400, AF 460	S 5	0.480	BEA 400D/S5
AF 400 ... AF 750	S 6	0.720	BEA 750D/S6

Horizontal assembly (Also suitable when using busbar kits for starter combinations)

A 145, A 185	S 3, S 4	0.520	BEA 185H/S4
A 210	S 4	0.620	BEA 210H/S4
A 210, A 300	S 5	1.280	BEA 300H/S5
AF 400, AF 460	S 5	1.310	BEA 400H/S5
AF 400, AF 460	S 6	2.450	BEA 460H/S6
AF 580, AF 750	S 6	4.010	BEA 750H/S6

Note: The BEA... connection bars provided for the A 145 ... A 300 contactors can be used for the AF 145 ... AF 300 contactors.

Connection bars between contactor and switch fuse

Vertical assembly

Contactors	Switch fuse	Weight kg 1 piece	Order code
A 185	OESA 250	0.260	
A210 ... A 300	OESA 250 to	0.330	BEF 185/OESA250
	OESA 400		BEF 300/OESA400
AF 400 ... AF 460	OESA 400	0.340	
AF 460 ... AF 750	OESA 630 to	0.740	BEF 460/OESA400
	OESA 800		BEF 750/OESA800

Horizontal assembly

A 145	OS 160..LR	0.170	OSZA 15
A 145, A 185	OESA 250..LR	0.550	BEF 185H/OESA250
A 210 ... A 300	OESA 250..LR to		BEF 300H/OESA400
	OESA 400..LR		
AF 400, AF 460	OESA 400..LR	1.250	BEF 460H/OESA400

Note: The BEF... connection bars provided for the A 145 ... A 300 contactors can be used for the AF 145 ... AF 300 contactors.

A..., AF..., 4-pole Contactors

a.c. Circuit Switching



Switching of Resistive Circuits

AC-1 utilization category
When making, the switched-on current is equal to the I_n load rated current with $\cos \phi = 0.95$.

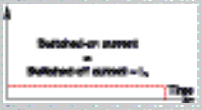

AC-1	Rated	$\leq 40^\circ\text{C}$
	operational	$\leq 55^\circ\text{C}$
	current	$\leq 70^\circ\text{C}$

- With conductor cross-sectional area mm^2
- Rated operational voltage

	A 9	A 16	A 26
A	25	30	45
A	22	27	40
A	18	23	32
mm^2	2.5	4	6
V	690		

4-pole contactors

Selection & Ordering

- ▶ Select 4 N.O. or 2 N.O. + 2 N.C. main poles
- ▶ Select contactor type.
- ▶ Select contactor coil voltage on cover folding page 0/1; according to control circuit supply. (Please quote coil voltage in plain text).

4 N.O. main poles



a.c. Control circuit supply

Types

A 9-40-00 **A 16-40-00** **A 26-40-00**



d.c. Control circuit supply

Types

—

—

2 N.O. + 2 N.C. main poles



a.c. Control circuit supply

Types

A 9-22-00 **A 16-22-00** **A 26-22-00**

Contactors Main Accessories

Selection & Ordering

- ▶ Select accessory type and quote required data in plain text.

Auxiliary contacts



CA 5-..., 1-pole
CAL ...-..., 2-pole

Types

CA 5-10 1-pole, front mounting CA 5-01 1-pole, front m

Timers



TP..., Pneumatic
TE..., Electronic
Supply voltages: 24 V a.c./d.c.,
110 ... 120; 220 ... 240; 380 ... 440 V a.c.

Types

TP 40 DA, TP 180 DA Direct timing - Front n
TE5S Direct timing - Inde

Interlocks



VE 5-..., Mechanical / Electrical
VM..., VH... Mechanical
mounting between 2 contactors

Types

VE 5-1
VM 5-1

Surge suppressors



RV..., (Varistor) a.c./d.c.
RC..., (Capacitor) a.c.

Types

RV 5
RC 5-1

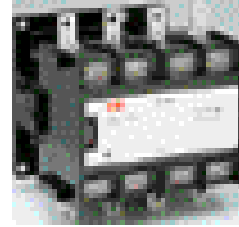

A 45	A 50	A 75	EK110	EK150	EK175	EK210	EK370	EK550	EK1000
70	100	125	200	250	300	350	550	800	1000
60	85	105	180	230	270	310	470	650	800
50	70	85	155	200	215	250	400	575	720
25	35	50	95	150	185	240	2 x 185	2 x 240	2 x 300
690			1000				690		

A 45-40-00	A 50-40-00	A 75-40-00	EK110-40-11	EK150-40-11	EK175-40-11	EK210-40-11	EK370-40-11	EK550-40-11	EK1000-40-11
AF45-40-00	AF50-40-00	AF75-40-00	EK110-40-21	EK150-40-21	EK175-40-21	EK210-40-21	EK370-40-21	EK550-40-21	EK1000-40-21

A 45-22-00	—	A 75-22-00	—	—	—	—	—	—	—
------------	---	------------	---	---	---	---	---	---	---

CAL 5-11 2-pole, side mounting	CAL 16-11 2-pole, side mounting
--------------------------------	---------------------------------

IA, TP 180 IA Inverse timing - Front mounting	—	TE5S Direct timing - Independent mounting (interpose an N.. contactor relay for EK 370 ... EK 1000)
---	---	---

VE 5-2	VH 145 (Mechanical / Electrical)	—	VH 800
RV 5 RC 5-2	—	RC-EH 300	RC-EH 800 (Varistor + RC)

A 9 ... A 75 4-pole Contactors



a.c. Operated

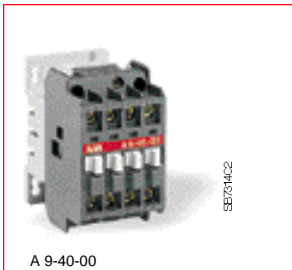

A 9-40-00

SE7614C2



A 45-40-00

SE8087C3

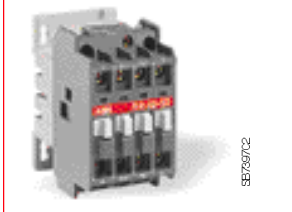

A 9-22-00

SE7697C2

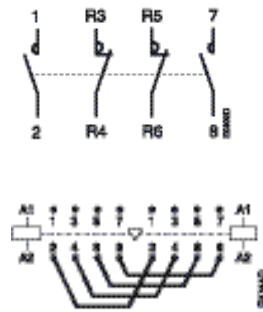

BES... for 4-pole connections

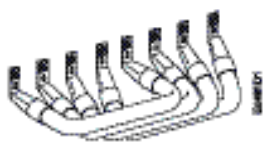

Rated operational current AC-1 40 °C A	Auxiliary contacts fitted	Footprint			Weight kg	Order code state coil voltage
		H	W	D		
4 N.O. main poles						
25	- -	74	44	74	0.340	A 9-40-00
30	- -	74	44	74	0.340	A 16-40-00
45	- -	90	54	94	0.610	A 26-40-00
70	- -	110	92	120	1.390	A 45-40-00
100	- -	110	92	120	1.390	A 50-40-00
125	- -	110	92	120	1.390	A 75-40-00
2 N.O. + 2 N.C. main poles						
25	- -	74	44	74	0.340	A 9-22-00
30	- -	74	44	74	0.340	A 16-22-00
45	- -	90	54	94	0.610	A 26-22-00
70	- -	110	92	120	1.400	A 45-22-00
125	- -	110	92	120	1.400	A 75-22-00
Coil voltages						
Voltage		Voltage				
V - 50Hz		V - 60Hz				
24		24				
48		48				
110		110 ... 120				
220 ... 230		230 ... 240				
230 ... 240		240 ... 260				
380 ... 400		400 ... 415				
400 ... 415		415 ... 440				

Other voltages on application

Remark for A 9 ... A 75 4-pole contactors fitted with 2 N.O. + 2 N.C. main poles

These contactors are suitable for controlling 2 separate circuits, i.e. 2 loads with 2 separate supplies, or 1 circuit comprising 2 separate loads with a single supply (see diagrams below). When the contactor operates there is no mechanical overlapping between the N.O. poles and the N.C. poles: BREAK before MAKE.

These contactors are not suitable for a reversing starter or star-delta starter or for controlling a single load from 2 separate supplies.

Block diagrams

- Single supply and 2 separate loads
- 2 separate supplies and 2 separate loads

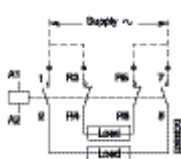

Connections for 4-pole Changeover Contactors

Application

Connection between the main poles of two 4-pole contactors mounted side by side so that they operate as source reversing contactors.

Description

These sets are made up of four downstream connections, with insulated, stranded, rigid copper cables.

Mounting on 4-pole contactors	Weight kg	Order code
A 45, A 50, A 75	1 set 0.400	BES 75-40

Note: The connections provided for the A... contactors can be used for the AF, AE and TAE types.

A 9 ... A 75 4-pole Contactors

Main Accessories

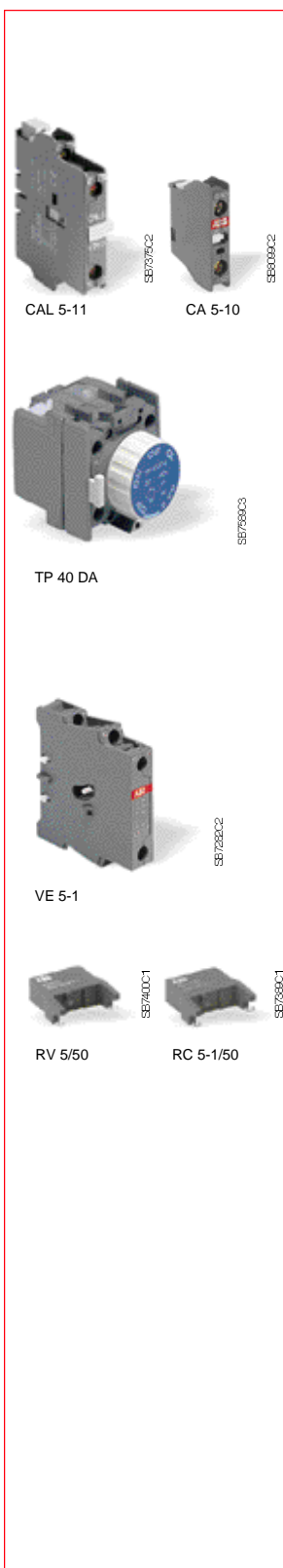

Auxiliary Contact Blocks

Mounting on contactors	Positioning	Contacts	Weight kg	Order code
A 9 ... A 75	Front face	1 -	0.014	CA 5-10
		- 1	0.014	CA 5-01
		4 -	0.060	CA 5-40 E
		2 2	0.060	CA 5-22 E
A 9 ... A 75	Side	1 1	0.050	CAL 5-11

Pneumatic Timers

Mounting on contactors	Timing range	Contacts	Weight kg	Order code
A 9 ... A 75	Direct 0.1 ... 40 s	1 1	0.070	TP 40 DA
	Direct 10 ... 180 s	1 1	0.070	TP 180 DA
	Inverse 0.1 ... 40 s	1 1	0.070	TP 40 IA
	Inverse 10 ... 180 s	1 1	0.070	TP 180 IA

Interlocks

Mounting on contactors	Feature	Contacts	Weight kg	Order code
A 9 ... A 26	Mech. / electrical	- 2	0.076	VE 5-1
A 45 ... A 75		- 2	0.146	VE 5-2
A 9 ... A 26	Mechanical	- -	0.066	VM 5-1

Surge Suppressors

Mounting on contactors	Feature	Voltage range	Weight kg	Order code
A 9 ... A 75	Varistor	24 ... 50 V a.c./d.c.	0.015	RV 5/50
		50 ... 133 V a.c./d.c.	0.015	RV 5/133
		110 ... 250 V a.c./d.c.	0.015	RV 5/250
		250 ... 440 V a.c./d.c.	0.015	RV 5/440
A 9 ... A 26	RC	24 ... 50 V a.c.	0.012	RC 5-1/50
		50 ... 133 V a.c.	0.012	RC 5-1/133
		110 ... 250 V a.c.	0.012	RC 5-1/250
		250 ... 440 V a.c.	0.012	RC 5-1/440
A 45 ... A 75	RC	24 ... 50 V a.c.	0.015	RC 5-2/50
		50 ... 133 V a.c.	0.015	RC 5-2/133
		110 ... 250 V a.c.	0.015	RC 5-2/250
		250 ... 440 V a.c.	0.015	RC 5-2/440

Other Accessories

A wide range of accessories are available.

- various auxiliary contact blocks for specific controls and use,
- interface relays,
- connecting auxiliaries: strips, connectors, additional pieces, etc.
- impulse contact blocks, lamp holder and fuse holder blocks,
- function marker.

EK 110 ... EK 1000 4-pole Contactors



a.c. Operated



SE7941C2

EK 175-40-11

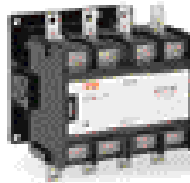

SE7943C2

EK 370-40-11

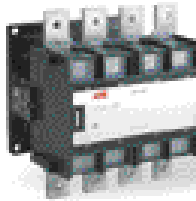

SE7989C2

EK 1000-40-11

Rated operationa current	Auxiliary contacts fitted	Footprint			Weight kg	Order code state coil voltage
		H	W	D		
AC-1 q 40 °C A						
200	1 1	156	165	155	4.300	EK 110-40-11
250	1 1	172	165	155	4.350	EK 150-40-11
300	1 1	198	201	172	6.600	EK 175-40-11
350	1 1	198	201	172	6.600	EK 210-40-11
550	1 1	272	270	226	17.20	EK 370-40-11
800	1 1	272	270	226	17.20	EK 550-40-11
1000	1 1	299	270	226	17.50	EK 1000-40-11

- E □ = 40 ... 400 Hz coil with built-in rectifier.

Coil voltages and codes: EK 110 ... EK 1000

Voltage □ V - 50Hz	Voltage □ V - 60Hz	Code		
48	-	A	D	
-	110	A	E	
110	120	A	F	
220 ... 230	*	A	L	*Read 240V 60Hz for EK 370 ... EK 1000.
230 ... 240	-	A	M	
-	380	A	N	
380 ... 400	440	A	P	
400 ... 415	-	A	R	

+ Other voltages: page 0/1.

Multi-frequency coils: EK 110 ... EK 210

Voltage □ V - 40 ... 400Hz	Code	
110 ... 120	E	F
115 ... 127	E	G
220 ... 230	E	L
230 ... 240	E	M
380 ... 400	E	P
400 ... 415	E	R

Dual frequency coils (1): EK 370 ... EK 1000

Voltage □ V - 50Hz	Voltage □ V - 60Hz	Code	
110	110 ... 120	E	F
110 ... 115	115 ... 127	E	G
220	220 ... 240	E	L
220 ... 230	230 ... 255	E	M
380	380 ... 415	E	P
380 ... 400	400 ... 440	E	R

(1) Two auxiliary contact blocks maximum per contactor, ambient temperature < 55 °C and mounting positions 2 and 6 excluded.

EK 110 ... EK 1000 4-pole Contactors

Main Accessories

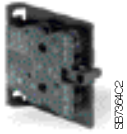

CAL 16-11 B



VH 145



RC-EH 300/48

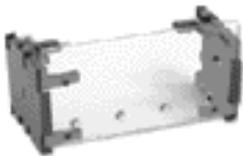

LT 210-EK

Auxiliary Contact Blocks

Mounting on contactors	Positioning	Contacts	Weight kg	Order code
EK 110 ... EK 1000	Side	1 1	0.050	CAL 16-11 B
		1 1	0.050	CAL 16-11 C
		1 1	0.050	CAL 16-11 D

Interlocks for two horizontal mounted contactors

Mounting on contactors	Feature	Contacts	Weight kg	Order code
EK 110, EK 150	Mech. / elec.	– 2	0.130	VH 145
EK 175, EK 210		– 2	0.130	VH 300
EK 370, EK 550	Mechanical	– –	6.000	VH 800
EK 1000		– –		

Note: For interlocking between two contactors of a different size: + section 4.

Surge Suppressors

Mounting on contactors	Feature	Voltage range	Weight kg	Order code
EK 110 ... EK 210	RC	24 ... 48 V a.c.	0.015	RC-EH 300/48
		110 ... 415 V a.c.	0.015	RC-EH 300/415
EK 370 ... EK 1000	RC	48 ... 110 V a.c.	0.015	RC-EH 800/110
		220 ... 600 V a.c.	0.015	RC-EH 800/600

Shrouds (terminal protection VDE 106, part 100)

Mounting on contactors	Suitable for contactor with	Weight kg	Order code
EK 110, EK 150	cable lugs	0.139	LT 150-EK
EK 175, EK 210	or	0.152	LT 210-EK
EK 370, EK 550	cable clamps	0.190	LT 550-EK
EK 1000		0.200	LT 1000-EK

Other Accessories

A wide range of accessories are available:

- auxiliary contact blocks for specific controls and use,
- connecting auxiliaries: connectors for main poles, connections sets,
- plates for changeover contactors, etc.

AF 45 ... AF 75 4-pole Contactors



a.c. / d.c. Operated - Large Voltage Range

Electronic Coil Interface



AF 75-40-00

SBE27M3

Rated operational current AC-1 40 °C A	Auxiliary contacts fitted	Footprint			Weight kg	Order code
		H	W	D		state coil voltage
4 N.O. main poles						
70	- -	110	92	120	1.420	AF 45-40-00
100	- -	110	92	120	1.420	AF 50-40-00
125	- -	110	92	120	1.420	AF 75-40-00
2 N.O. + 2 N.C. main poles						
70	- -	110	92	120	1.420	AF 45-22-00
125	- -	110	92	120	1.420	AF 75-22-00

Coil voltages

Voltage	Voltage
V - 50/60Hz	V d.c.
-	20 ... 60
48 ... 130	48 ... 130
100 ... 250	100 ... 250

(1) The connection polarities indicated close to the coil terminals must be respected: A1 for the positive pole and A2 for the negative pole.

Remark for AF 45 ... AF 75 4-pole contactors built with 2 N.O. + 2 N.C. main poles

These contactors are suitable for controlling 2 separate circuits, i.e. 2 loads with 2 separate supplies, or 1 circuit comprising 2 separate loads with a single supply (+ diagrams below). When the contactor operates there is no mechanical overlapping between the N.O. poles and the N.C. poles: BREAK before MAKE.



These contactors are not suitable for a reversing starter or star-delta starter or for controlling a single load from 2 separate supplies.

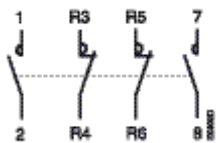

Block Diagrams

- Single supply and 2 separate loads
- 2 separate supplies and 2 separate loads

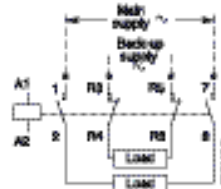
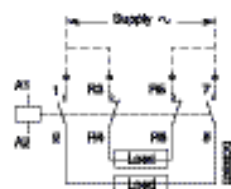

Electromagnetic compatibility:

AF... contactors comply with international standards IEC 60947-1 (2000-10-Ed.3.1), 60947-4-1 (2000-11-Ed.2) and European standards EN 60947-1, 60947-4-1.

Notice: This product has been designed for environment A. Use of this product in environment B may cause unwanted electromagnetic disturbances in which case the user may be required to take adequate mitigation measures.

Definitions:

Environment A: "Mainly relates to low-voltage non public or industrial networks/locations/installations (+ EN 50082-2 article 4) including highly disturbing sources".

Environment B: "Mainly relates to low-voltage public networks (+ EN 50082-1 article 5) such as residential, commercial and light industrial locations/installations. Highly disturbing sources such as arc welders are not covered by this environment".

EK 110 ... EK 1000 4-pole Contactors



d.c. Operated

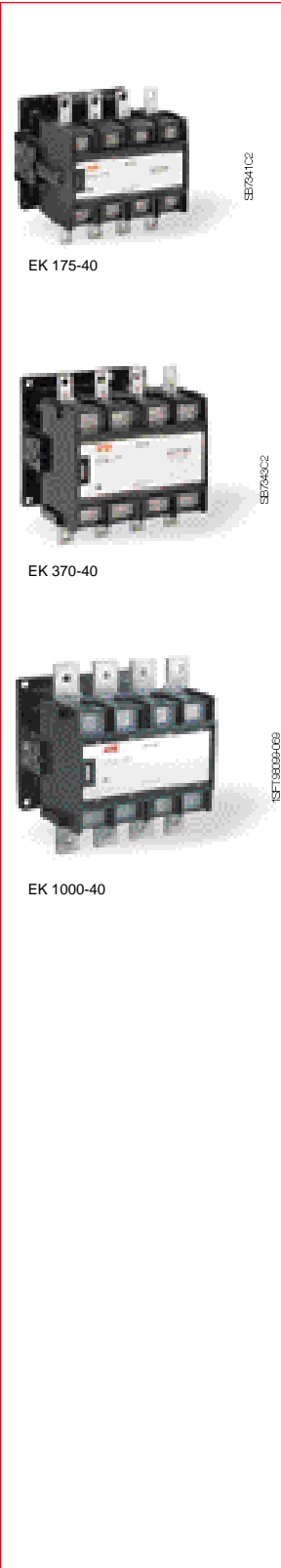

Rated operational current AC-1 40 °C A	Auxiliary contacts fitted	Footprint			Weight kg	Order code state coil voltage
		H	W	D		
200	2 1	156	136	155	4.350	EK 110-40-21
250	2 1	172	136	155	4.400	EK 150-40-21
300	2 1	198	176	172	6.650	EK 175-40-21
350	2 1	198	176	172	6.650	EK 210-40-21
550	2 1	272	296	226	17.20	EK 370-40-21
800	2 1	272	296	226	17.20	EK 550-40-21
1000	2 1	299	296	226	17.50	EK 1000-40-21

Coil voltages and codes

Voltage V d.c.	Code	
12 (1)	<input type="checkbox"/>	<input type="checkbox"/>
24	D	A
36	D	B
48	D	C
60	D	D
75	D	T
110	D	G
125	D	E
220	D	U
	D	F

(1) Not for EK 370 ... EK 1000 contactors.

For Accessories see page ??

Contactors for Capacitor Switching

AC-6b Utilization Category according to IEC 60947-4-1

Capacitor Transient Conditions

In Low Voltage industrial installations, capacitors are mainly used for reactive energy correction (raising the power factor). When these capacitors are energized, overcurrents of high amplitude and high frequencies (3 to 15 kHz) occur during the transient period (1 to 2 ms). The amplitude of these current peaks, also known as "inrush current peaks", depends on the following factors:

- The network inductances.
- The transformer power and short-circuit voltage.
- The type of power factor correction.

There are 2 types of power factor correction: fixed or automatic.

Fixed power factor correction consists of inserting, in parallel on the network, a capacitor bank whose total power is provided by the assembly of capacitors of identical or different ratings.

The bank is energized by a contactor that simultaneously supplies all the capacitors (a single step).

The inrush current peak, in the case of fixed correction, can reach 30 times the nominal current of the capacitor bank.



Fixed power factor correction

An automatic power factor correction system, on the other hand, consists of several capacitor banks of identical or different ratings (several steps), energized separately according to the value of the power factor to be corrected.

An electronic device automatically determines the power of the steps to be energized and activates the relevant contactors.

The inrush current peak, in the case of automatic correction, depends on the power of the steps already on duty, and can reach 100 times the nominal current of the step to be energized.

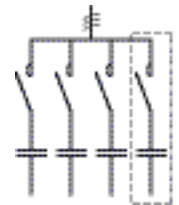

Automatic power factor correction

Steady State Condition Data

The presence of harmonics and the network's voltage tolerance lead to a current, estimated to be 1.3 times the nominal current I_n of the capacitor, permanently circulating in the circuit.

Taking into account the manufacturing tolerances, the exact power of a capacitor can reach 1.15 times its nominal power.

Standard IEC 831-1 Edition 04/97 specifies that the capacitor must therefore have a maximum thermal current I_T of:

$$I_T = 1.3 \times 1.15 \times I_n = 1.5 \times I_n$$

Consequences for the Contactors

To avoid malfunctions (welding of main poles, abnormal temperature rise, etc.), contactors for capacitor bank switching must be sized to withstand:

- **A permanent current that can reach 1.5 times the nominal current of the capacitor bank.**
- **The short but high peak current on pole closing (maximum permissible peak current \hat{I}).**

ABB offers 3 contactor versions according to the value of the inrush current peak and the power of the capacitor bank

A... and AF... standard contactors (A 12... A 300 and AF 400 ... AF 750)

UA... Contactors for capacitor switching (UA 16 ... UA 110)

UA...-R Contactors for capacitor switching (UA 16-R ... UA 75-R) with insertion of damping resistors

A... Standard 3-pole Contactors for Capacitor Switching

Peak Current $\hat{I} < 30$ Times the rms Current



Application

The **A...** and **AF...** contactors are suited for capacitor bank switching for the peak current and power values in the table below. The kvar ratings acc. to the table below are applicable to "star" connected capacitors (less current, cable savings). The capacitors must be discharged (maximum residual voltage at terminals ≤ 50 V) before being re-energized when the contactors are making. In these conditions, electrical durability of contactors is equal to 100 000 operating cycles.

Description

- A 12 ... A 110 3-pole contactors
- A 145 ... AF 750 3-pole contactors

Selection Table

Type	Powers in kvar 50/60 Hz (AC - 6b)															Max. peak current \hat{I} (kA)
	220/240 V			380/400 V			415/440 V			500/550V			660/690 V			
	40 °C	55 °C	70 °C	40 °C	55 °C	70 °C	40 °C	55 °C	70 °C	40 °C	55 °C	70 °C	40 °C	55 °C	70 °C	
A 9	-	-	-	-	-	-	-	-	-	-	-	-	-	-	-	-
A 12	7	7	6	11	11	9.5	12	12	10.5	14	14	12	19	19	16.5	0.7
A 16	7.5	7.5	6	12.5	12.5	10	14	14	10.5	15.5	15.5	12	21.5	21.5	16.5	1
A 26	11.5	11.5	9	19	19	15	20	20	16.5	23	23	19	32	32	26	1.6
A 30	13	13	11	22	22	18.5	24	24	20.5	28	28	23	38	38	32	1.9
A 40	15	15	12	26	26	20	29	29	22	35	35	25	46	46	34.5	2.1
A 50	22	22	20	38	38	34	42	42	37	48	48	42	65	65	58.5	2.3
A 63	25	25	23	43	43	39	47	47	42.5	54	54	48.5	74	74	67	2.5
A 75	28	28	24.5	48	48	41	52	52	45	60	60	51	82	82	70	2.6
A 95	35	35	33	60	60	53	63	63	58	75	75	70	80	80	75	4
A 110	40	40	35	70	70	60	75	75	65	83	83	78	90	90	85	4
A 145	50	50	42	90	90	74	93	93	80	110	110	96	110	110	110	4
A 185	60	60	45	105	105	78	115	115	85	135	135	102	135	135	135	5
A 210	75	75	57	125	125	100	135	135	110	160	160	130	160	160	160	6.5
A 260	85	85	70	140	140	130	155	155	140	180	180	165	200	200	200	8
A 300	100	100	85	160	160	150	180	180	163	210	210	196	240	240	240	8
AF 400	120	120	105	200	200	185	220	220	200	260	260	241	300	300	300	10
AF 460	140	140	120	230	230	215	260	260	230	325	325	300	325	325	325	10
AF 580	170	170	160	270	270	260	300	300	290	350	350	340	440	440	440	12
AF 750	220	220	190	390	370	332	410	410	380	490	480	435	600	600	600	12

If, in an application, the current peak is greater than the maximum peak current \hat{I} specified in the last column in the table, select a higher rating, refer to the **UA...** contactors (+ page 2/38) or add inductances (+ Application Guide "Contactors for Capacitor Switching").

The capacitor bank will be protected by gG type fuses whose rating is equal to 1.5 ... 1.8 times nominal current.

UA... 3-pole Contactors for Capacitor Switching



Peak Current $\hat{I} < 100$ Times the rms Current

Application

The UA.. contactors have been specially developed for the switching of capacitor banks whose inrush current peaks are less than or equal to 100 times nominal rms current. The table below gives the permissible powers according to operational voltage and temperature close to the contactor. It also specifies the maximum peak current \hat{I} values accepted by the contactor.

The kvar ratings acc. to the table below are applicable to "star" connected capacitors (less current, cable savings).

The capacitors must be discharged (maximum residual voltage at terminals < 50 V) before being re-energized when the contactors are making.

In these conditions, electrical durability of contactors is equal to 100 000 operating cycles.

Selection Table

Type	Powers in kvar 50/60 Hz (AC - 6b)															Max. permissible peak current \hat{I} (kA)	
	230/240 V			400/415 V			440 V			500/550 V			660/690 V			U _e	U _e
	40 °C	55 °C	70 °C	40 °C	55 °C	70 °C	40 °C	55 °C	70 °C	40 °C	55 °C	70 °C	40 °C	55 °C	70 °C	≤ 500 V	> 500 V
UA 16	7.5	6.7	6	12.5	11.7	10	13.7	13	11	15.5	14.7	12.5	21.5	20	17	1.8	1.6
UA 26	12	11	8.5	20	18.5	14.5	22	20	16	22	22	19.5	30	30	25	3	2.7
UA 30	16	16	11	27.5	27.5	19	30	30	20	34	34	23.5	45	45	32	3.5	3.1
UA 50	20	20	19	33	33	32	36	36	35	40	40	40	55	55	52	5	4.5
UA 63	25	25	21	45	43	37	50	48	41	50	50	45	70	70	60	6.5	5.8
UA 75	30	30	22	50	50	39	55	53	43	62	62	47.5	75	75	65	7.5	6.75
UA 95	35	35	29	60/65*	60/65*	50/55*	65	65	55	70	70	60	86	86	70	9.3	8
UA 110	40	39	34	74	70/75*	65	75	75	67	80	80	75	90	90	85	10.5	9

(*) Use these values for U_e = 415 V

For **220 V** and **380 V**, multiply by **0.9** the rated values at 230 V and 400 V respectively.

Example: 50 kvar/400 V corresponding to 0.9 x 50 = **45 kvar/380 V**.

If, in an application, the current peak is greater than the maximum peak current \hat{I} specified in the table above, select a higher rating, refer to the **UA...-R** contactors (+ page 2/40) or add inductances (+ Application Guide "Contactors for Capacitor Switching").

The capacitor bank will be protected by gG type fuses whose rating is equal to 1.5 ... 1.8 times nominal current.

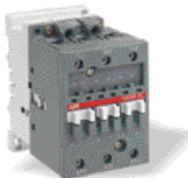

Power 400 V 40 °C kvar	Max. peak current U _e 500V kA	Auxiliary contacts fitted	Footprint			Weight kg	Order code
			H	W	D		
12.5	1.8	1 -	74	44	74	0.340	UA 16-30-10
20	3	1 -	90	54	94	0.600	UA 26-30-10
27.5	3.5	1 -	90	54	109	0.710	UA 30-30-10
33	5	1 1	110	82	108	1.200	UA 50-30-11
45	6.5	1 1	110	82	108	1.200	UA 63-30-11
50	7.5	1 1	110	82	108	1.200	UA 75-30-11
60	9.3	1 1	148	102	124	2.040	UA 95-30-11
74	10.5	1 1	148	102	124	2.040	UA 110-30-11

Coil voltages

Voltage	Voltage
U ₁₁₁₁ V - 50Hz	U ₁₁₁₁ V - 60Hz
24	24
48	48
110	110...120
220...230	230...240
230...240	240...260
380...400	400...415
400...415	415...440

(1) Not for EK 370 ... EK 1000 contactors.

UA...-R 3-pole Contactors for Capacitor Switching



Peak Current \hat{I} 100 Times the rms Current

Application

The UA ...-R contactors can be used in installations in which peak current far exceeds 100 times nominal rms current. The contactors are delivered complete with their damping resistors and must be used without additional inductances (+ table below).

The kvar ratings acc. to the table below are applicable to "star" connected capacitors (less current, cable savings).

The capacitors must be discharged (maximum residual voltage at terminals < 50 V) before being re-energized when the contactors are making.

Their electrical durability is 250 000 operating cycles for $U_e < 500$ V and 100 000 operating cycles for $U_e = 500$ V.

Selection Table

Type	Powers in kvar - 50/60 Hz (AC-6b)															Max. permissible peak current \hat{I}	gG type fuses max. (*)
	220/240 V			380/400/415 V			440 V			500/550 V			660/690 V				
	40 °C	55 °C	70 °C	40 °C	55 °C	70 °C	40 °C	55 °C	70 °C	40 °C	55 °C	70 °C	40 °C	55 °C	70 °C		
UA 16-30-10-R	8	7.5	6	12.5	12.5	10	15	13	11	18	16	12.5	22	21	17	80	
UA 26-30-10-R	12.5	11.5	9	22	20	15.5	24	20	17	30	25	20	35	31	26	125	
UA 30-30-10-R	16	16	11	30	27.5	19.5	32	30	20.5	34	34	25	45	45	32	200	
UA 50-30-00-R	25	24	20	40	40	35	50	43	37	55	50	46	72	65	60	200	
UA 63-30-00-R	30	27	23	50	45	39	55	48	42.5	65	60	50	80	75	65	200	
UA 75-30-00-R	35	30	25	60	50	41	65	53	45	75	65	55	100	80	70	200	

(*) The fuse ratings given in this column represent the maximum ratings ensuring type 1 co-ordination according to the definition of standard IEC 60947-4-1.



Power 400 V 40 °C kvar	Auxiliary contacts fitted		Footprint			Weight kg	Order code state coil voltage
	1	2	H	W	D		
12.5	1	-	140	44	106	0.460	UA 16-30-10-R
22	1	-	140	54	125	0.710	UA 26-30-10-R
30	1	-	140	54	140	0.810	UA 30-30-10-R
40	-	-	160	70	139	1.350	UA 50-30-00-R
50	-	-	160	70	139	1.350	UA 63-30-00-R
60	-	-	160	70	139	1.350	UA 75-30-00-R

Coil voltages	
Voltage	Voltage
--- V - 50Hz	--- V - 60Hz
24	24
48	48
110	110...120
220...230	230...240
230...240	240...260
380...400	400...415
400...415	415...440

please contact us for other voltages

N... Contactor Relays

a.c. Operated



Application

N... contactor relays are used for switching auxiliary circuits and control circuits.

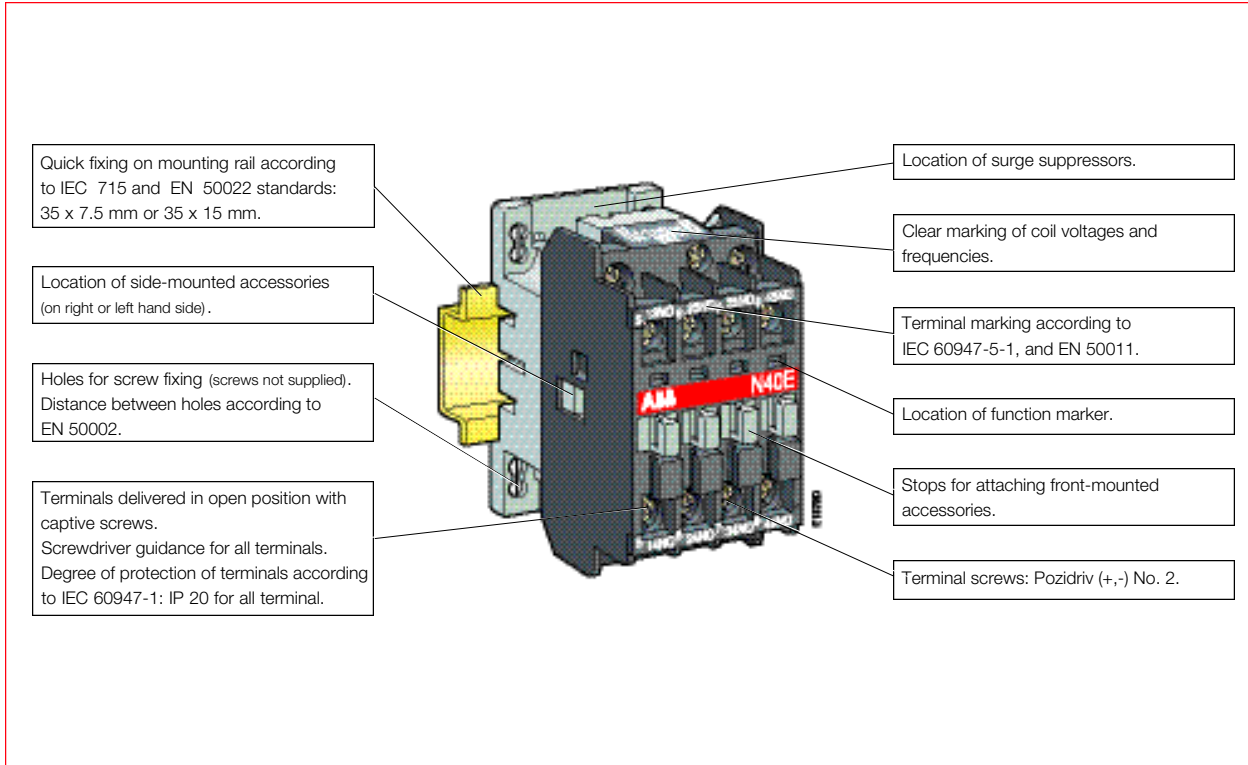

Number of contacts 	Footprint			Weight kg	Order code state coil voltage
	H	W	D		
4-pole, 1-stack					
2 2	74	44	74	0.340	N 22 E
3 1	74	44	74	0.340	N 31 E
4 -	74	44	74	0.34	N 40 E

Coil voltages

Voltage V - 50Hz	Voltage V - 60Hz
24	24
48	48
110	110 ... 120
220 ... 230	230 ... 240
230 ... 240	240 ... 260
380 ... 400	400 ... 415
400 ... 415	415 ... 440

N/KC... Contactor Relays

Main Accessories

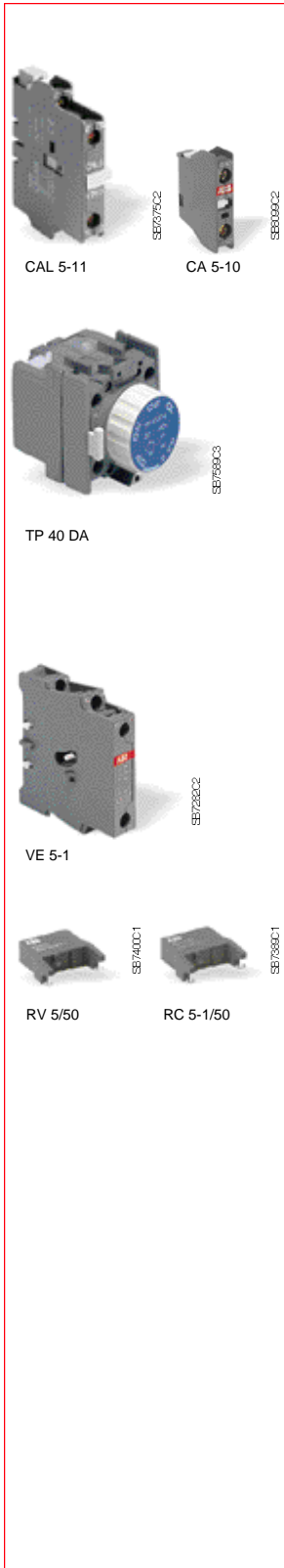

Auxiliary Contact Blocks

Mounting on contactor relays	Positioning	Contacts	Weight	Order Code
N/KC...	Front face	1 -	0.014	CA 5-10
		- 1	0.014	CA 5-01
		4 -	0.060	CA 5-40 N
		2 2	0.060	CA 5-22 N
		- 4	0.060	CA 5-04 N
N	Side	1 1	0.050	CAL 5-11

Pneumatic Timers

Mounting on contactor relays	Timing range	Contacts	Weight	Order Code
N/KC...	Direct 0.1 ... 40 s	1 1	0.070	TP 40 DA
	Direct 10 ... 180 s	1 1	0.070	TP 180 DA
	Inverse 0.1 ... 40 s	1 1	0.070	TP 40 IA
	Inverse 10 ... 180 s	1 1	0.070	TP 180 IA

Interlocks

Mounting on contactor relays	Feature	Contacts	Weight	Order Code
N...	Mech. / electrical	- 2	0.076	VE 5-1
	Mechanical	- -	0.066	VM 5-1
KC	Mechanical	- -	0.015	VBC30

Surge Suppressors

Mounting on contactor relays	Feature	Voltage range	Weight	Order Code
N...	Varistor	24 ... 50 V a.c./d.c.	0.015	RV 5/50
		50 ... 133 V a.c./d.c.	0.015	RV 5/133
		110 ... 250 V a.c./d.c.	0.015	RV 5/250
		250 ... 440 V a.c./d.c.	0.015	RV 5/440
	RC		24 ... 50 V a.c.	0.012
50 ... 133 V a.c.			0.012	RC 5-1/133
110 ... 250 V a.c.			0.012	RC 5-1/250
250 ... 440 V a.c.			0.012	RC 5-1/440

Other accessories

A wide range of accessories are available:

- various auxiliary contact blocks for specific controls and use,
- interface relays,
- fuse holder blocks,
- function marker.

KC... Contactor Relays

d.c. Operated with Solid Magnetic Coil



Application

KC... contactor relays are used for switching auxiliary circuits and control circuits.

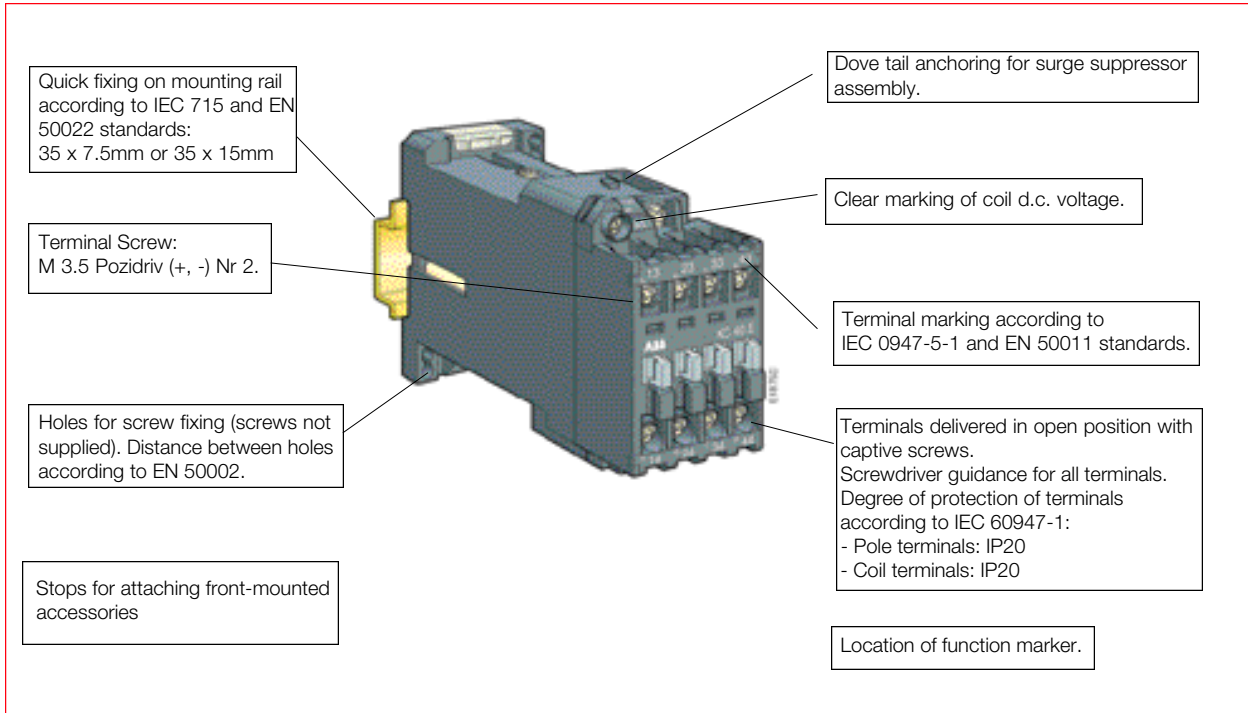

Number of contacts 	Footprint			Weight kg	Order code state coil voltage	
	H	W	D			
4-pole, 1-stack						
2	2	81	44	114	0.540	KC 22 E
3	1	81	44	114	0.540	KC 31 E
4	-	81	44	114	0.540	KC 40 E

Coil voltages

Voltage - U_c

V d.c.

- 12
- 24
- 42
- 48
- 50
- 60
- 75
- 110
- 125
- 220
- 240
- 250

Please consult us:
For contactor relays with wide range coils
For accessories (see pagex/xx)

Contactor Spares

a.c. Operated coils for A9...A300 contactors and N contactor relays



For contactors	Weight (kg)	Order Code
A9...A16 : UA16 : UA16..-R : N	0.093	ZA16
A26...A40 : UA26, UA30, UA26..-R, UA30..-R	0.148	ZA40
A45...A75 : UA50...UA75, UA50...-R to UA75..-R; GA75	0.166	ZA75
A95...A110 ; UA95...UA110	0.170	ZA110
A145...A185	0.180	ZA185
A210...A300	0.400	ZA300

a.c./d.c. Operated coils c/w electronic interface for AF 45...AF750 contactors



For contactors	Weight (kg)	Order Code
AF45...AF75	0.170	ZAF75
AF95, AF110	0.200	ZAF110
AF145...AF185	0.225	ZAF185
AF210...AF300	0.450	ZAF300
AF400...AF460	0.525	ZAF460
AF580...AF750	1.335	ZAF750

d.c. Operated coils for AE9...AE110 contactors

For contactors	Weight (kg)	Order Code
AE9...AE16	0.093	ZAE16
AE26...AE40	0.148	ZAE40

a.c. or d.c. coils only



For contactors	Weight (kg)	Order Code
EK110, EK150	0.360	KH210
EK175, EK210	0.440	KH300
EK370, EK550, EK1000	0.950	KH800

Sets including a d.c. coil, an economy resistor and an insertion contact

For contactors	Weight (kg)	Order Code
EK110, 150	0.450	KP210
EK175, 210	0.550	KP300
EK370, EK550, EK1000	1.060	KP800

Contactors Spares

Main contact sets for 3-pole Contactors

The contact sets for 3-pole contactors consist of six fixed contacts, three moving contacts, springs and the necessary screws.

For contactors	Weight (kg)	Order Code
A/AF/AE/TAE 50-30	0.115	ZL50
A/AF/AE/TAE 63-30	0.130	ZL63
A/AF/AE/TAE 75-30	0.145	ZL75
A/AF/AE/TAE 95-30	0.190	ZL95
A/AF/AE/TAE 110-30	0.190	ZL110
A/AF 145	0.380	ZL145
A/AF 185	0.380	ZL185
A/AF 210	0.670	ZL210
A/AF 260	0.670	ZL260
A/AF 300	0.670	ZL300
AF 400	1.320	ZL400
AF 460	1.320	ZL460
AF 580	1.840	ZL580
AF 750	1.840	ZL750
UA 50, UA 50-R	0.115	ZLU50
UA 63, UA 63-R	0.145	ZLU63
UA 75, UA 75-R	0.145	ZLU75
UA 95	0.190	ZLU95
UA 110	0.190	ZLU110

Main contact sets for 4-pole Contactors

The contact sets for 4-pole contactors consist of eight fixed contacts, four moving contacts, springs and the necessary screws.

For contactors	Weight (kg)	Order Code
A/AF 45-40	0.150	ZLT45
A/AF 50-40	0.150	ZLT50
A/AF 75-40	0.160	ZLT75

The contact sets for 4-pole contactors consist of eight fixed contacts, four moving contacts, springs and the necessary screws. In addition, the sets include four moving arcing contacts for EK370...EK1000 contactors.

For contactors	Weight (kg)	Order Code
EK 110	0.450	KZK110
EK 150	0.450	KZK150
EK 175	0.700	KZK175
EK 210	0.700	KZK210
EK 370	2.400	KZK370
EK 550	2.400	KZK550
EK 1000	3.000	KZK1000

Mini contactors B6...B7, BC6...BC7

Ordering details



B6-30-10



B6-30-10F



B6-30-10P



B7-30-10



B7-40-10



B7-40-10 + CAF6-11

Rated current AC-3 415 V A	fitted AC-1 < 40°C A	Aux. contacts Kw	Footprint			Weight kg	Order code		
			H	W	D				
Screw 3 & 4 pole AC operation									
8.5	20	4	1	-	58	53	47	0.18	B6.30.10*
			-	1	58	53	47	0.18	B6.30.01*
			-	-	58	53	47	0.18	B6.40.00*
11.5	20	5.5	1	-	58	53	47	0.18	B7.30.10*
			-	1	58	53	47	0.18	B7.30.01*
			-	-	58	53	47	0.18	B7.40.00*
Flat pin 3 & 4 pole AC operation									
8.5	20	4	1	-	58	53	47	0.17	B6.30.10F*
			-	1	58	53	47	0.17	B6.30.01F*
			-	-	58	53	47	0.17	B6.40.00F*
11.5	20	5.5	1	-	58	53	47	0.17	B7.30.10F*
			-	1	58	53	47	0.17	B7.30.01F*
			-	-	58	53	47	0.17	B7.40.00F*
Soldering pin 3 pole AC operation									
8.5	20	4	1	-	45	48	48	0.17	B6.30.10P*
			-	1	45	48	48	0.17	B6.30.01P*
11.5	20	5.5	1	-	45	48	48	0.17	B7.30.10P*
			-	1	45	48	48	0.17	B7.30.01P*
Screw 3 & 4 pole DC operation									
8.5	20	4	1	-	58	53	47	0.18	BC6.30.10*
			-	1	58	53	47	0.18	BC6.30.01*
			-	-	58	53	47	0.18	BC6.40.00*
11.5	20	5.5	1	-	58	53	47	0.18	BC7.30.10*
			-	1	58	53	47	0.18	BC7.30.01*
			-	-	58	53	47	0.18	BC7.40.00*
Flat pin 3 & 4 pole DC operation									
8.5	20	4	1	-	58	53	47	0.17	BC6.30.10F*
			-	1	58	53	47	0.17	BC6.30.01F*
			-	-	58	53	47	0.17	BC6.40.00F*
11.5	20	5.5	1	-	58	53	47	0.17	BC7.30.10F*
			-	1	58	53	47	0.17	BC7.30.01F*
			-	-	58	53	47	0.17	BC7.40.00F*
Soldering pin 3 pole DC operation									
8.5	20	4	1	-	45	48	48	0.17	BC6.30.10P*
			-	1	45	48	48	0.17	BC6.30.01P*
11.5	20	5.5	1	-	45	48	48	0.17	BC7.30.10P*
			-	1	45	48	48	0.17	BC7.30.01P*

*Please state coil voltage/frequency when ordering

Mini contactors VB6...VB7, VBC6...VBC7

Reversing Pairs



VB 7-30-01

Rated current AC-3 415 V A	fitted AC-1 < 40°C A	Aux. contacts Kw	Footprint			Weight kg	Order code	
			H	W	D			
Screw 3 pole AC operation								
8.5	20	4	1 -	58	97	47	0.34	VB6.30.10*
			- 1	58	97	47	0.34	VB6.30.01*
11.5	20	5.5	1 -	58	97	47	0.34	VB7.30.10*
			- 1	58	97	47	0.34	VB7.30.01*
Flat pin 3 pole AC operation								
8.5	20	4	1 -	58	97	47	0.34	VB6.30.10F*
			- 1	58	97	47	0.34	VB6.30.01F*
11.5	20	5.5	1 -	58	97	47	0.34	VB7.30.10F*
			- 1	58	97	47	0.34	VB7.30.01F*
Soldering pin 3 pole AC operation								
8.5	20	4	1 -	58	97	47	0.34	VB6.30.10P*
			- 1	58	97	47	0.34	VB6.30.01P*
11.5	20	5.5	1 -	58	97	47	0.34	VB7.30.10P*
			- 1	58	97	47	0.34	VB7.30.01P*
Screw 3 pole DC operation								
8.5	20	4	1 -	58	97	47	0.34	VBC6.30.10*
			- 1	58	97	47	0.34	VBC6.30.01*
11.5	20	5.5	1 -	58	97	47	0.34	VBC7.30.10*
			- 1	58	97	47	0.34	VBC7.30.01*
Flat pin 3 pole DC operation								
8.5	20	4	1 -	58	97	47	0.34	VBC6.30.10F*
			- 1	58	97	47	0.34	VBC6.30.01F*
11.5	20	5.5	1 -	58	97	47	0.34	VBC7.30.10F*
			- 1	58	97	47	0.34	VBC7.30.01F*
Soldering pin 3 pole DC operation								
8.5	20	4	1 -	58	97	47	0.34	VBC6.30.10P*
			- 1	58	97	47	0.34	VBC6.30.01P*
11.5	20	5.5	1 -	58	97	47	0.34	VBC7.30.10P*
			- 1	58	97	47	0.34	VBC7.30.01P*

* Please state coil voltage/frequency when ordering

Mini Contactors 3 Pole BC6

Interface Contactors



Rated current	fitted	Aux. contacts	Footprint			Weight	Order code		
AC-3	AC-1		H	W	D	kg			
415 V	< 40°C								
A	A	Kw							
Screw			3 pole			DC 24v - 1.4w			
8.5	20	4	1	-	58	53	47	0.17	BC6.30.10.1.4*
			-	1	58	53	47	0.17	BC6.30.01.1.4*
Flat pin			3 pole			DC 24v - 1.4w			
8.5	20	4	1	-	58	53	47	0.17	BC6.30.10.F1.4*
			-	1	58	53	47	0.17	BC6.30.01.F1.4*
Soldering pin			3 pole			DC 24v - 1.4w			
8.5	20	4	1	-	45	48	48	0.17	BC6.30.10.P1.4*
			-	1	45	48	48	0.17	BC6.30.01.P1.4*

Rated current	fitted	Aux. contacts	Footprint			Weight	Order code		
AC-3	AC-1		H	W	D	kg			
415 V	< 40°C								
A	A	Kw							
Screw			3 pole			DC 17 ... 32v - 2.4w			
8.5	20	4	1	-	58	53	47	0.18	BC6.30.10.2.4*
			-	1	58	53	47	0.18	BC6.30.01.2.4*
Flat pin			3 pole			DC 17 ... 32v - 2.4w			
8.5	20	4	1	-	58	53	47	0.18	BC6.30.10.F2.4*
			-	1	58	53	47	0.18	BC6.30.01.F2.4*
Soldering pin			3 pole			DC 17 ... 32v - 2.4w			
8.5	20	4	1	-	45	48	48	0.18	BC6.30.10.P2.4*
			-	1	45	48	48	0.18	BC6.30.01.P2.4*

Please consult us for 5.5kw version

Mini Relays 4 Pole K6/KC6

Ordering details



KC6-40E-P

AC Operation

Screw connection

4 pole

Relay

Rated current fitted AC-1 < 40°C A	Contact Configuration		Footprint			Weight kg	Order code
			H	W	D		
20	4	-	58	53	47	0.18	K6.40E*
	3	1	58	53	47	0.18	K6.31Z*
	2	2	58	53	47	0.18	K6.22Z*

Flat pin connection

4 pole

Relay

20	4	-	58	53	47	0.17	K6.40E-F*
	3	1	58	53	47	0.17	K6.31Z-F*
	2	2	58	53	47	0.17	K6.22Z-F*

Soldering pin connection

4 pole

Relay

20	4	-	45	48	48	0.18	K6.40E-P*
	3	1	45	48	48	0.18	K6.31Z-P*
	2	2	45	48	48	0.18	K6.22Z-P*

DC Operation

Screw connection

4 pole

Relay

Rated current fitted AC-1 < 40°C A	Contact configuration		Footprint			Weight kg	Order code
			H	W	D		
20	4	-	58	53	47	0.18	KC6.40E*
	3	1	58	53	47	0.18	KC6.31Z*
	2	2	58	53	47	0.18	KC6.22Z*

Flat pin connection

4 pole

Relay

20	4	-	58	53	47	0.17	KC6.40E-F*
	3	1	58	53	47	0.17	KC6.31Z-F*
	2	2	58	53	47	0.17	KC6.22Z-F*

Soldering pin

4 pole

Relay

20	4	-	45	48	48	0.17	KC6.40E-P*
	3	1	45	48	48	0.17	KC6.31Z-P*
	2	2	45	48	48	0.17	KC6.22Z-P*



Accessories for mini contactors

Ordering details



B, BC, K, KC Auxiliary contacts

Mounting on	Position	Weight	Order code
B6.30.10 B7.30.10 1 1	side	0.030	CA6.11M
B6.30.01 B7.30.01 1 1	side	0.030	CA6.11N
B6.40.00 B7.40.00 1 1	side	0.030	CA6.11E
B6.30.10 B7.30.10 1 1	front face	0.035	CAF6.11M
B6.30.10 B7.30.10 2 -	front face	0.035	CAF6.20M
B6.30.10 B7.30.10 - 2	front face	0.035	CAF6.02M
B6.30.01 B7.30.01 1 1	front face	0.035	CAF6.11N
B6.30.01 B7.30.01 2 -	front face	0.035	CAF6.20N
B6.30.01 B7.30.00 - 2	front face	0.035	CAF6.02N
B6.40.00 B7.40.00 1 1	front face	0.035	CAF6.11E
B6.40.00 B7.40.00 2 -	front face	0.035	CAF6.20E
B6.40.00 B7.40.00 - 2	front face	0.035	CAF6.02E
K, KC 1 1	side	0.030	CA6.11K
K, KC 1 1	front face	0.035	CAF6.11K
K, KC 2 -	front face	0.035	CAF6.20K
K, KC - 2	front face	0.035	CAF6.02K

Note: Side or front mounted auxiliaries can be fitted, but not together.

B, BC, K, KC Accessories

Description	Mounting on	Weight kg	Order code
with soldering pins	B, BC, K, KC	0.014	LB6
with soldering pins	CA6.11	0.006	LB6.CA
identification marker	front face	0.017	BA-50
protective cover IP20	B, BC, K, KC	0.001	LT6-B
plunger (manual opp)	B, BC, K, KC	0.060	BN6
reversing links	VB, VBC	0.010	BSM6.30
parallel links	B, BC	0.001	LP6

T7 Thermal overloads

Setting range A	Footprint			Weight kg	Order code
	H	W	D		
0.10 ... 0.16	55	45	56	0.070	T7DU0.16
0.16 ... 0.24	55	45	56	0.070	T7DU0.24
0.24 ... 0.40	55	45	56	0.070	T7DU0.4
0.40 ... 0.60	55	45	56	0.070	T7DU0.6
0.60 ... 1.0	55	45	56	0.070	T7DU1.0
1.0 ... 1.6	55	45	56	0.070	T7DU1.6
1.6 ... 2.4	55	45	56	0.070	T7DU2.4
2.4 ... 4.0	55	45	56	0.070	T7DU4.0
4.0 ... 6.0	55	45	56	0.070	T7DU6.0
6.0 ... 9.0	55	45	56	0.070	T7DU9.0
9.0 ... 12.0	55	45	56	0.070	T7DU12.0

Note:

1 n/o + 1 n/c auxiliary contact fitted as standard to the overload
Dimension (H) is from the bottom of the contactor to the bottom of the overload

Manual Motor Starters

Type series MS

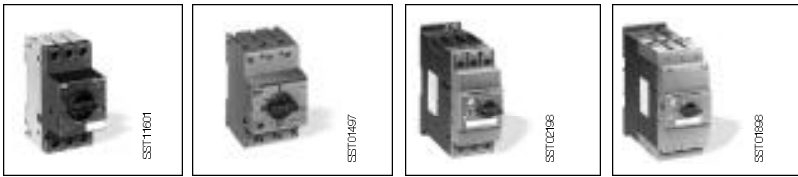

Manual motor starter	Type	MS 116	MS 325	MS 450	MS 495
----------------------	------	--------	--------	--------	--------

General technical data

Standards: The devices comply with the major international, European and national regulations IEC 60.../EN 60..		947-1 947-2 947-4-1 947-5-1	947-1 947-2 947-4-1 947-5-1	947-1 947-2 947-4-1 947-5-1	947-1 947-2 947-4-1 947-5-1
Disconnecter characteristics (to IEC/EN 60947-1)		yes	– yes	yes yes	yes yes yes
Mechanical service life in operations		100.000	100.000	50.000	
Permissible ambient temperature					
- open	°C	– 20... + 55/70 ¹⁾	– 25 ... + 55 ¹⁾	– 20 ... + 60/70 ¹⁾	
- encapsulated (in protective housing)	°C	on request	– 25 ... + 40	– 20 ... + 35	
- Storage temperature	°C	– 50 ... + 80	– 50 ... + 80	– 50 ... + 80	
Temperature compensation		with			
Mounting position		as illustrated ⁶⁾	any		
Permissible altitude	m	3000	3000	2000	
Permissible resistance to vibrations ²⁾ (IEC 68-2-6)		10-150 Hz Amplitude 5 g	10-150 Hz Amplitude 5 g	on request	on request
Permissible resistance to shocks sinusoidal shock (IEC 68-2-27)		25 g (11 ms)	15 g (11 ms)	on request	on request
Mounting (mounting hardware not included in scope of delivery)					
Screw fixing		see accessories	see accessories	2 x M5	2 x M5
Quick fastening to EN 50022		35 mm	35 mm	35 mm	35 mm,
on top-hat rail to EN 50023		–	–	(15 mm high)	75 mm
Electrical connection of the main conductors (main circuits)					
Type		Screw terminal	Box terminal	Box terminal + bus	Box terminal
Screw		Pozidrive size 2	Pozidrive size 2	Pozidrive size 2 4 mm	Internal hexagon
	Single-core	1 ... 4	1 ... 10	0.75 ... 35	2.5 ... 70
	2 x mm2	1 ... 4	1 ... 4	0.75 ... 25	2.5 ... 50
	Stranded	1 ... 4	1 ... 10	0.75 ... 35	2.5 ... 70
	2 x mm2	1 ... 4	–	0.75 ... 25	2.5 ... 50
	Flexible	0.75 ... 2.5	1 ... 6	0.75 ... 25	2.5 ... 50
	2 x mm2	0.75 ... 2.5	–	0.75 ... 16	2.5 ... 35
of the auxiliary conductors (auxiliary circuits)					
Type		Screw terminal	Screw terminal ⁴⁾		Screw terminal
Screw		Pozidrive size 2	Pozidrive size 1		Pozidrive size 2
	Single-core	1 ... 2.5	0.5 ... 2.5		0.5 ... 2.5
	2 x mm2	1 ... 2.5 ⁵⁾	0.5 ... 2.5		0.5 ... 2.5
	Flexible	0.75 ... 2.5	0.5 ... 2.5		0.5 ... 1.5
	2 x mm2	0.75 ... 2.5	0.5 ... 2.5		0.5 ... 1.5

1) Operating conditions up to 70° C on request



3) Also applies to auxiliary switches HKF1 and undervoltage release UA1

5) Applies to auxiliary switches HK1 and SK1

2) G-values refer to the mounting position subject to the highest shock sensitivity

4) For auxiliary switch HKF.. Pozidrive 2

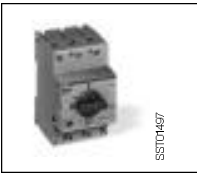
6) Other mounting positions on request

					
Manual motor starter	Type	MS 116	MS 325	MS 450	MS 495

General electrical data					
Rated insulation voltage U_i					
to EN 60947	V AC	690	690	690	690
to CSA / UL / NEMA	V AC	600	600	600	600
Rated operating voltage U_e up to	V	690 AC/440 DC	690 AC/440 DC	690 AC/440 DC	690 AC/440 DC
Rated impulse strength U_{imp}	kV	6	- / 6	6	6
Rated continuous thermal current I_{th}	A	16	25	50	100
Rated operating current I_e / AC 3 max.					
Rated frequency ¹⁾	Hz	50/60			
Rated current ranges I_e (number of ranges)	A		0.1 ... 25 (14)	11 ... 50 (7)	28 ... 100 (6)
Rated service short-circuit breaking capacity I_{cs} and max. permissible back-up fuses on request					
DC rated operating voltage					
in the case of series connection					
of 3 main circuits					
(wiring diagram on request)					
DC 1, 60 V A		on request	25	50	100
DC 3, 60 V A		on request	25	50	100
DC 5, 60 V A		on request	25	50	100
Short circuit capacity for DC-rating				on request	

Auxiliary circuits					
Rated operating current I_e	at AC 15 to 24 V AC A	6	2.5	-	
	230 V AC A	4	2	3 / 0.5 / 6	
	400 V AC A	3	1	1.5 / - / 3	
	at DC 13 to 24 V DC A	2	2.5	- / - / - ^{1) 2)}	
	60 V DC A	-	2.5	- / 0.15 / -	
	110 V DC A	0.5	0.6	0.22 / - / 0.5	
	220 V DC A	0.25	0.25	0.1 / - / 0.25	
	440 V DC A	0.1	-	- / - / 0.1	
Short-circuit protection back-up fuse	gL A	on request	10	gL / gG 10 A	
	aM A		6	-	

1) Correction factors for other frequencies on request

2) On front side 1 changeover contact/on front side 1 NO + 1 NC / at side 1 NO + 1 NC, 2 NO, 2 NC

3) Other data on request

Manual Motor Starter

MS 116



MS 116

SST11601



HKF 1-11

STC03014



MS 116 with mini contactor B6

MS116m3b



MS 116 with A-contactor

MS116m4b

Open design, enclosure IP 20, resistant to changeable climates. Quick fastening on mounting rails DIN EN 50 022, 35 mm without auxiliary switch.

Setting range A...A	Weight kg	Order code
MS 116 with thermal and electromagnetic trips, short-circuit-proof up to 50 kA		
0.10...0.16	0.268	MS 116 - 0.16
0.16...0.25	0.268	MS 116 - 0.25
0.25...0.40	0.268	MS 116 - 0.4
0.40...0.63	0.268	MS 116 - 0.63
0.63...1.00	0.268	MS 116 - 1.0
1.00...1.60	0.268	MS 116 - 1.6
1.60...2.50	0.268	MS 116 - 2.5
2.50...4.00	0.268	MS 116 - 4
4.00...6.30	0.268	MS 116 - 6.3
6.30...10.00	0.268	MS 116 - 10.0
10.00...16.00	0.268	MS 116 - 16.0

Accessories

	Order code
Auxiliary switches, for front-panel installation	
1 NO + 1 NC	HKF1-11
Auxiliary switches, lateral attachment at right	
1 NO + 1 NC	HK1-11
2 NO	HK1-20
2 NC	HK1-02
Signal kontakt for general "tripped" signal, lateral attachment at right	
1 NO + 1 NC	SK1-11
2 NO	SK1-20
2 NC	SK1-02
Undervoltage release, lateral attachment at left	
24 V, 50 Hz	UA1-24
48 V, 50 Hz	UA1-48
60 V, 50 Hz	UA1-60
110/120 V, 50/60 Hz	UA1-110
208 V, 60 Hz	UA1-208
230 V, 50 Hz	UA1-230
400 V, 50 Hz	UA1-400
415 V, 50 Hz	UA1-415

Manual Motor Starter

MS116



Accessories

Description	Order code
Phase buses for cross wiring MS 116, 63 A, 690 V	
for 2 devices without auxiliary switches	PS1-2-0
for 3 devices without auxiliary switches	PS1-3-0
for 4 devices without auxiliary switches	PS1-4-0
for 5 devices without auxiliary switches	PS1-5-0
for 2 devices with 1 auxiliary switch	PS1-2-1
for 3 devices with 1 auxiliary switch	PS1-3-1
for 4 devices with 1 auxiliary switch	PS1-4-1
for 5 devices with 1 auxiliary switch	PS1-5-1
for 2 devices with 2 auxiliary switches	PS1-2-2
for 3 devices with 2 auxiliary switches	PS1-3-2
for 4 devices with 2 auxiliary switches	PS1-4-2
for 5 devices with 2 auxiliary switches	PS1-5-2
Busbar cover	BSI-3
Power infeed blocks, 63 A, 690 V, stranded 25 mm², flexible 16 mm²	
flat	S1-M1
high	S1-M2
Mounted enclosure IP 65, triple lockable in Off position, with N- und PE-terminal, metric cable gland	
Grey enclosure with black handle	IB 116-G
Yellow enclosure with red handle	IB 116-Y
Switch cubicle mounting kit IP 65, with axial extension triple lockable in Off position, locked in On position	
Twist knob black	OHB2AJM
Twist knob red/yellow	OHY2AJM
axis 85 mm	OXS5X85
axis 105 mm	OXS5X105
axis 130 mm	OXS5X130
axis 180 mm	OXS5X180
driver ¹⁾	MSMN
driver spindle 32 mm ²⁾	MSOX
Locking device	
lock adapter	SA1
locking device assy =(adaptor sai + padlock + 3 keys)	SA3

For connecting links between MMS + contactor (see page x/xx)

1) For accommodating spindle and attachment to manual motor starter
2) Is screwed directly onto the manual motor starter

Manual Motor Starter

MS 325



Selection

Open design, enclosure IP 20, resistant to changeable climates. Quick fastening on mounting rails DIN EN 50 022, 35.

Setting range A...A	Weight kg	Order code
MS 325 with thermal and electromagnetic trips, short-circuit-proof up to 100 kA, resp.50 kA ¹⁾²⁾		
0.10....0.16	0.347	MS 325 – 0.16
0.16....0.25	0.347	MS 325 – 0.25
0.25....0.40	0.347	MS 325 – 0.4
0.40....0.63	0.347	MS 325 – 0.63
0.63....1.00	0.347	MS 325 – 1
1.00....1.60	0.347	MS 325 – 1.6
1.60....2.50	0.347	MS 325 – 2.5
2.50....4.00	0.347	MS 325 – 4
4.00....6.30	0.347	MS 325 – 6.3
6.30....9.00	0.347	MS 325 – 9
9.0012.50	0.347	MS 325 – 12.5
12.50....16.00	0.347	MS 325 – 16
16.00....20.00	0.347	MS 325 – 20
20.00....25.00	0.347	MS 325 – 25

Magnetic only versions on application

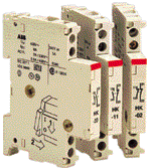

Accessories

Setting range	Weight kg	Order code
Auxiliary switches, lateral attachment at left, max. 2 pieces attachable		
1 NO + 1 NC	0.031	HK-11
2 NO	0.031	HK-20
2 NC	0.031	HK-02



Signal contact for general "tripped" signal, lateral attachment at the left max. 1 piece attachable

1 NO + 1 NC	0.031	SK-11
-------------	-------	-------

Locking device

lock adapter	0.004	SA1
locking device assy. (Adapter SA1 + padlock + 3 keys)	0.050	SA3



For other accessories please consult us.
For connecting links between MMS and contactor see page ??

Manual Motor Starters

MS 4xx



Open design, enclosure IP 20, resistant to changeable climates. Quick fastening on mounting rails DIN EN 50 022, 35 mm without auxiliary switch

Setting range A . . . A	Weight kg	Order code
MS 450 with thermal and electromagnetic trips, tripping class 10, short-circuit-proof up to 50 kA		
11....16	0.96	MS 450 – 16
14....20	0.96	MS 450 – 20
18....25	0.96	MS 450 – 25
22....32	0.96	MS 450 – 32
28....40	0.96	MS 450 – 40
36....45	0.96	MS 450 – 45
40....50	0.96	MS 450 – 50

MS 495 with thermal and electromagnetic trips, tripping class 10, short-circuit-proof up to 50 kA		
28....40	2.1	MS 495 – 40
36....50	2.1	MS 495 – 50
45....63	2.1	MS 495 – 63
57....75	2.1	MS 495 – 75
70....90	2.1	MS 495 – 90
80....100 ²⁾	2.1	MS 495 – 100

Magnetic only and heavy duty starting versions on application

Retrofittable accessories

These parts may be procured in addition to the MS 4xx. They must be mounted by the user.

Type	Weight kg	Order code
Auxiliary switches, for front panel installation		
1 NO + 1NC	0.02	HK4-11
1 Changeover	0.02	HK4-W

Auxiliary switches, for lateral attachment at left, max. 1 mountable		
1 NO + 1 NC	0.03	HKS4-11
2 NO	0.03	HKS4-20
2 NC	0.03	HKS4-02

Pilot switch, for separate signalling of short-circuit and general tripping, lateral attachment at left, max. 1 mountable, also together with auxiliary switch		
for any signal 1 NO + 1 NC	0.07	SK4-11

For other accessories please consult us.
For connecting links between MMS and contactor see page ??

BEA 7 ... BEA 110

Connecting Links for Contactors and Manual Motor Starters



BEA 16/116

5B826703

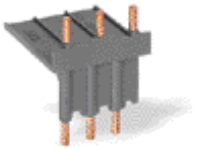

BEA 40/450

5B826703



A 9-30-10 + BEA 16/116 + MS 116
DOL Starter Combination

5B826405

Application



The BEA... connecting link is used for direct linking between a contactor and the associated manual motor starter which are used together as DOL Starter Combination in type 1 or type 2 co-ordination, complying with IEC 60947-4-1 and EN 60947-4-1.

Database of co-ordination tables on the ABB Website:
www.abb.com/lowvoltage + left menu: "Low Voltage On-Line" + select: "Support Tools".

Description

The BEA... insulated 3-pole connecting link (touch safe) ensures the electrical linking between the contactor and the corresponding manual motor starter.

The BEA... connecting links can be used with the A... series contactors (including AF..., AE... versions) and the MS... manual motor starter as indicated in the table below.

For contactors & fixing	Screws not supplied	For MMS & fixing	Screws / rail not supplied	I _e max. AC-3 400 V A	Weight kg	Order code
B6, VB6A	-	MS116	 15 x 35 mm	8	0.013	BEA7/116
B7, VB7A	-	MS116		11	0.013	BEA7/116
B6, VB6A	-	MS325		8	0.021	BEA7/325
B7, VB7A	-	MS325		11	0.021	BEA7/325
A 9	-	MS 116	 15 x 35 mm	9	0.020	BEA 16/116
A 12	-	MS 116		12	0.020	BEA 16/116
A 16	-	MS 116		16	0.020	BEA 16/116
A 26	2 x M4	MS 116		25	0.024	BEA 26/116
A 9	-	MS 325	 15 x 35 mm	9	0.031	BEA 16/325
A 12	-	MS 325		12	0.031	BEA 16/325
A 16	-	MS 325		16	0.031	BEA 16/325
A 26	2 x M4	MS 325		25	0.031	BEA 26/325
A 30	2 x M4	MS 450	2 x M5	32	0.061	BEA 40/450
A 40	2 x M4	MS 450	2 x M5	37	0.061	BEA 40/450
A 50	2 x M4	MS 450	2 x M5	50	0.062	BEA 50/450
A 50	2 x M6	MS 495	2 x M5	50	0.120	BEA 75/495
A 63	2 x M6	MS 495	2 x M5	63	0.120	BEA 75/495
A 75	2 x M6	MS 495	2 x M5	75	0.120	BEA 75/495
A 90	2 x M6	MS 495	2 x M5	90	0.124	BEA 110/495
A 110	2 x M6	MS 495	2 x M5	100	0.124	BEA 110/495

FBP FieldBusPlug

Communicative Motor Starters - Compact Devices



MSD11-FBP

MSR22-FBP

Motorstarter Direct MSD11-FBP

Motor Branch circuit for 1 motor, 1 direction of rotation, IP20.

- Motor protection with thermal and electromagnetic trip
- Compact device with fieldbus-independent interface for connection to FBP fieldbus connector
- 400 V AC, max. 12 A, incl. motor connector, $I_{es} = 10...50$ kA

Designation	Setting Range	Order Code
0.16 A	0.1 - 0.16 A	MSD11-FBP.0.16
0.25 A	0.16 - 0.25 A	MSD11-FBP.0.25
0.40 A	0.25 - 0.40 A	MSD11-FBP.0.4
0.63 A	0.40 - 0.63 A	MSD11-FBP.0.63
1.0 A	0.63 - 1.0 A	MSD11-FBP.1
1.6 A	1.0 - 1.6 A	MSD11-FBP.1.6
2.5 A	1.6 - 2.5 A	MSD11-FBP.2.5
4.0 A	2.5 - 4.0 A	MSD11-FBP.4.0
6.3 A	4.0 - 6.3 A	MSD11-FBP.6.3
10.0 A	6.3 - 10 A	MSD11-FBP.10
12.0 A	8 - 12.0 A	MSD11-FBP.12

Motorstarter Direct MSR22-FBP

Motor Branch circuit for 1 motor, 2 directions of rotation, IP20.

- Motor protection with thermal and electromagnetic trip
- Compact device with fieldbus-independent interface for connection to FBP fieldbus connector
- 400 V AC, max. 12 A, incl. motor connector, $I_{es} = 10...50$ kA

Designation	Setting Range	Order Code
0.16 A	0.1 - 0.16 A	MSR22-FBP.0.16
0.25 A	0.16 - 0.25 A	MSR22-FBP.0.25
0.40 A	0.25 - 0.40 A	MSR22-FBP.0.4
0.63 A	0.40 - 0.63 A	MSR22-FBP.0.63
1.0 A	0.63 - 1.0 A	MSR22-FBP.1
1.6 A	1.0 - 1.6 A	MSR22-FBP.1.6
2.5 A	1.6 - 2.5 A	MSR22-FBP.2.5
4.0 A	2.5 - 4.0 A	MSR22-FBP.4.0
6.3 A	4.0 - 6.3 A	MSR22-FBP.6.3
10.0 A	6.3 - 10 A	MSR22-FBP.10
12.0 A	8 - 12.0 A	MSR22-FBP.12

Accessories for Motor Starters MSD11-FBP and MSR22-FBP

Busbar blocks for MSD11-FBP and MSR22-FBP for cross wiring.

Feeder block for busbar blocks MSD11-FBP and MSR22-FBP.

- Current-carrying capacity max.63 A, connection cross-section 25/16mm² multipole/fine-wire

Designation	Order Code
Busbar block for 2 devices	PS1-2-0
Busbar block for 3 devices	PS1-3-0
Busbar block for 4 devices	PS1-4-0
Busbar block for 5 devices	PS1-5-0
Feeder block, flat design	S1-M1
Feeder block, high	S1-M2

FBP FieldBusPlug

Communicative Motor Starters with Control Function



MFI 21

Motorstarter Fieldbus Interface MFI21-FBP

Fieldbus interface, IP20, for coupling to manual motor starter MS 325.

- Integrated motor control functions - direct, reverse-start, star-delta starting, diagnostic functions
- Integrated potentiometer, 3 digital inputs, 3 relay outputs, 1 direct-coupled digital input for detection of switch position of the MS 325
- Fieldbus-independent interface for connection to FBP fieldbus connector

Designation	Order Code
Motorstarter Fieldbus Interface	MFI21-FBP.0

*) Manual motor starter MS325 and accessories for MS 325, refer to main switch and technology catalogue



UMC 22

Universal Motor Controller UMC22-FBP

Universal motor controller with thermal overload protection 0.2-63A in a single device type.

- Bushing-type current transformer, cable cross-section 25mm²
- Integrated motor control functions - direct, reverse-start, star-delta starting, servo-drive functions
- Diagnostic functions - overload, phase failure, trip - trip categories 10,20,30
- Integrated storage of parameters and motor data
- 6 digital inputs, 3 relay outputs
- Fieldbus-independent interface for connection to FBP fieldbus connector

Designation	Rated motor current		Order Code
Universal Motor Controller	0.2 - 63	A	UMC22-FBP.0

Accessories for Universal Motor Controller UMC22-FBP

Busbar blocks for MSD11-FBP and MSR22-FBP for cross wiring.

Feeder block for busbar blocks MSD11-FBP and MSR22-FBP.

- Current-carrying capacity max.63 A, connection cross-section 25/16mm² multipole/fine-wire



Display - UMC 22

Designation	Order Code
Control Panel	ACS100-PAN

FBP FieldBusPlug

Communicative Motor Starters - Compact Devices

(Please consult us for availability of other protocol's)



AS-i FieldBusPlug Direct

Ready-made AS-i Slave fieldbus interface with various cable lengths.

- Applicable on the MSD11-FBP and on devices with max. 2 input signals and 1 output signal
- Degree of protection IP65, diagnostic LED

Designation FieldBusPlug	Cable Length		Order Code
AS-i Direct	0.25	m	ASD11-FBP.025
AS-i Direct	0.50	m	ASD11-FBP.050
AS-i Direct	1.00	m	ASD11-FBP.100
AS-i Direct	5.00	m	ASD11-FBP.500

AS-i FieldBusPlug Performance

Ready-made AS-i Slave fieldbus interface with various cable lengths.

- Applicable on all FBP motor starters and devices with max. 4 input signals and 3 output signals
- Degree of protection IP65, diagnostic LED

Designation	Cable Length		Order Code
AS-i Performance	0.25	m	ASP22-FBP.025
AS-i Performance	0.50	m	ASP22-FBP.050
AS-i Performance	1.00	m	ASP22-FBP.100
AS-i Performance	5.00	m	ASP22-FBP.500

Accessories for AS-i Bus Connection

AS-i round cable for bus junctions

Ready-made bus cable with an M12 connector and an open cable end.

- Application on bus junctions such e.g. AS-i couplers or devices with an integrated AS-i interface

Designation	Cable Length		Order Code
AS-i Round Cable with female connector	0.30	m	ASF11-FBP.030
AS-i Round Cable with male connector	0.30	m	ASM11-FBP.030

AS-i round cable for bus extension

Ready-made bus cable with M12 male and female connectors

Designation	Cable Length		Order Code
AS-i Extension Cable	1.00	m	ASX11-FBP.100
AS-i Extension Cable	3.00	m	ASX11-FBP.300
AS-i Extension Cable	5.00	m	ASX11-FBP.500

AS-i round cable and accessories for bus extension

Bus cable and coupling accessories

Designation	Cable Length		Order Code
AS-i Extension Cable	100	m	ASC11-FBP.999
AS-i Round Cable, male conn.			ASM11-FBP.0
AS-i Round Cable, female conn.			ASF11-FBP.0
AS-i Flat-Cable Branch Circuit with M12 socket			AST11-FBP.0

AS-i addressing device, power unit, miscellaneous accessories

Designation	Order Code
AS-i Addr. Device, incl. plug-in power unit	ASA21-FBP.0
Power Unit PS 24V/5A, adjustable	Systron PS24/5
Address Signs for FieldBusPlug	CAL11-FBP.0

FBP FieldBusPlug

DeviceNet Fieldbus Connectors and Accessories

(Please consult us for availability of other protocol's)

DeviceNet FieldBusPlug

Ready-made DeviceNet fieldbus interface with various cable lengths.

- Applicable on all FBP motor starters and other devices
- Degree of protection IP65, diagnostic LED

Designation FieldBusPlug	Cable Length		Order Code
DeviceNet	0.25	m	DNP21-FBP.025
DeviceNet	0.50	m	DNP21-FBP.050
DeviceNet	1.00	m	DNP21-FBP.100
DeviceNet	5.00	m	DNP21-FBP.500

B10



Accessories for the DeviceNet Bus Connector

DeviceNet round cable for bus junctions

Ready-made bus cable with an M12 connector and an open cable end.

- Application on bus junctions such e.g. DeviceNet couplers or devices with an integrated DeviceNet interface

Designation	Cable Length		Order Code
DeviceNet Round Cable with female connector	0.50	m	DNF11-FBP.050
DeviceNet Round Cable with male connector	0.50	m	DNM11-FBP.050

ST05301



ST05201



DeviceNet round cable for bus extension

Ready-made bus cable with M12 male and female connectors

Designation	Cable Length		Order Code
DeviceNet Extension Cable	1.00	m	DNX11-FBP.100
DeviceNet Extension Cable	3.00	m	DNX11-FBP.300
DeviceNet Extension Cable	5.00	m	DNX11-FBP.500

ST04801



DeviceNet round cable and accessories for bus extension

Bus cable and coupling accessories

Designation	Cable Length		Order Code
DeviceNet Extension Cable	100	m	DNC11-FBP.999
DeviceNet Round Cable, male conn.			DNM11-FBP.0
DeviceNet Round Cable, female conn.			DNF11-FBP.0

ST05501



ST05701



ST05401



Termination Resistor, Power Unit, Miscellaneous Accessories

Designation	Extra Information	Order Code
DeviceNet Termination Resistor	120 Ohm	DNR11-FBP.120
Power Unit PS 24V/5A, adjustable		Systron PS24/5

Notes

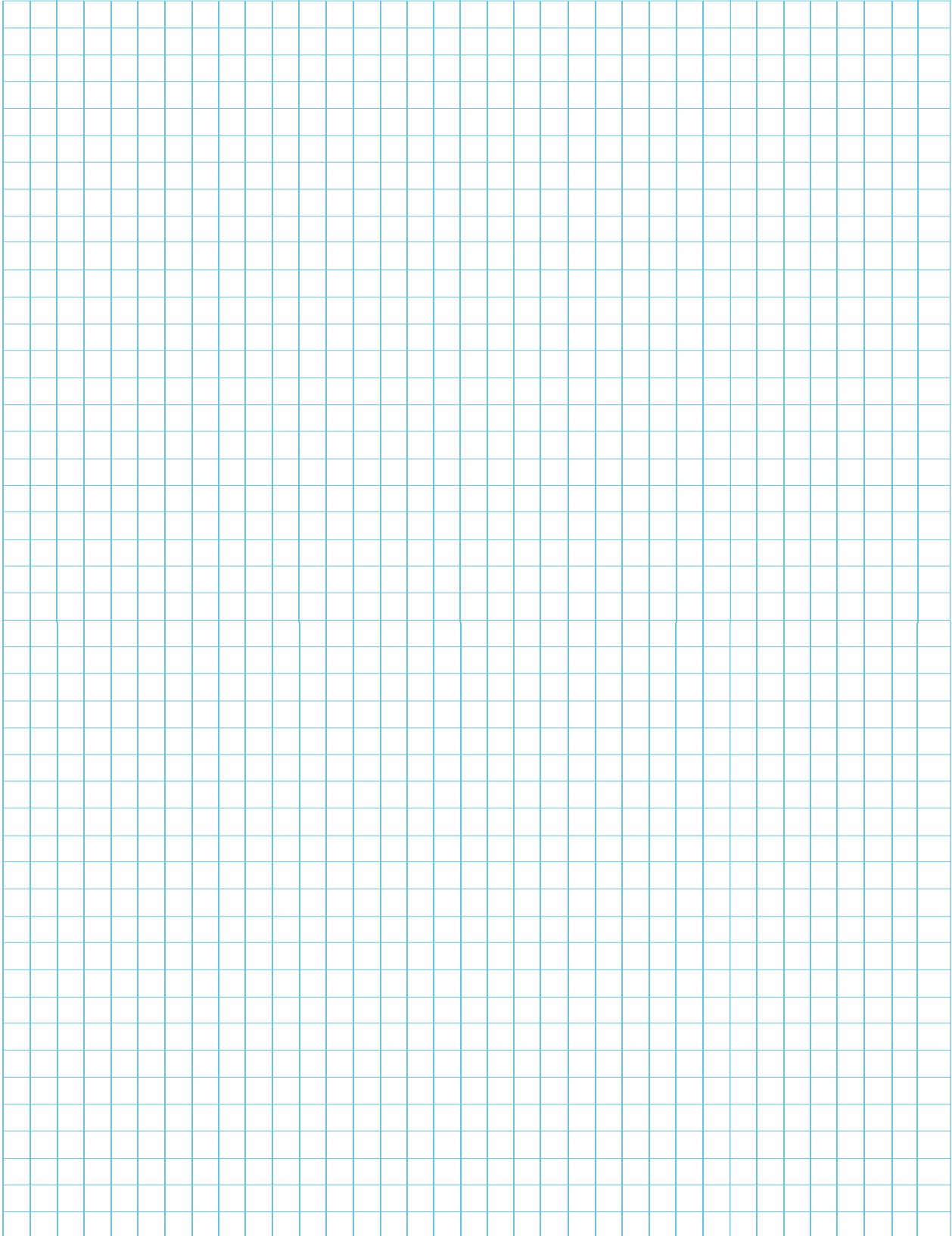

Softstarters

Description

Softstarters type PS S

ABB's solid state starter range is used when it is important to have a smooth start-up of various types of motor drives. Instead of switching directly to full voltage the softstarter ensures a gradual voltage increase.

PS S 03...PS S 25 is a compact solution for small motors. Mounting is on 35 mm DIN-rail. This small softstarter has a built-in bypass contact.

PS S 18/30...PS S 300/515 for normal duty applications and connection both "In Line" and "Inside Delta" (compare the connection with a standard Y/D starter). The result of "Inside Delta" connection is a 42 % reduction of the current exposed to the softstarter. It will then be possible, for example, to start and run a 100 A motor using a 58 A softstarter.

An optional "Current limit" function is available. Two signal relays are built in as standard. This softstarter has a service factor of 1.15, which means that the maximum operational current is I_o (rated current) x 1.15.

Example: the PS S 18/30 connected in-line has an I_o of 18 A. The maximum operational current is then $1.15 \times 18 \text{ A} = 20.7 \text{ A}$.



PS S 03...12

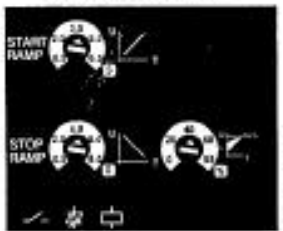

10PT 88000-030

PS S 25



10PT 88000-042

PS S 18/30...300/515

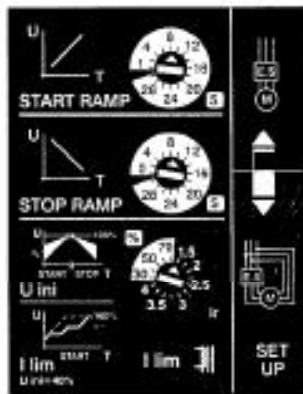

10PT 88000-031

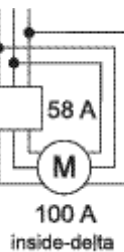
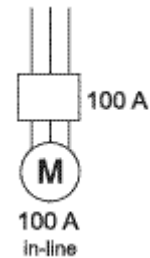

In-line and inside-delta connection of PS S 18/30...300/515

The operator panels for PS S, PS D and PS DH have LED's, potentiometers and switches for indication and settings.

Softstarters

General Technical Data

PS S 03...PS S 25 and PS S 18/30...PS S 300/515

		PS S03...PS S 12	PS S 25	PS S 18/30...PS S 300/515
Rated insulation voltage Ui	V	630	630	690
Rated operational voltage Ue	V	220 - 230 400 - 415 480 - 500 600	220 - 230 400 - 415 480 - 500 600	200 - 690 - - -
Starting Capacity at max. Rated current Ie		5 x Ie for 5 sec	5 x Ie for 5 sec	4 x Ie for 10 sec
Number of starts per hour		62 ²⁾	6 ²⁾	30 ³⁾
Overload capability Overload class	A	10	10	10
Service factor	%	100	100	115 (PS S 18/30...250/430) 110 (PS S 300/515)
Ambient temperature				
During operation	°C	-20 – +50	-20 – +50	-25 – +60 ¹⁾
During Storage	°C	-40 – +70	-40 – +70	-40 – +70
Degree of protection				
Main circuit		IP20	IP20	IP20 (PS S 18/30-500...44/76-500) IP10 (PSS 50/85-500...72/124-500) IP10 (PS S 18/30-690...75/124-690) IP00 (PS S 85/147...300/515)
Supply and control circuit		IP20	IP20	IP20
Settings				
Ramp time during start	s	0.5 – 6.5 +-15%	0.5 – 10 +-10%	1 – 30
Ramp time during stop	s	0.5 – 8 +-25%	0.5 – 20 +-10%	0 – 30
Initial voltage during start	%	0 – 85 +-15%	0.5 – 50 +-5%	30 – 70
Current limit voltage	xIe	No	No	1.5 – 4 ³⁾
Switch for				
Inside delta connection ON/OFF		No	No	Yes
Signal relay				
By-pass signal		No ⁴⁾	No ⁴⁾	Yes
Fault signal		No	No	Yes
Rated operational voltage Ue	V	-	-	250
Rated thermal current Ith	A	-	-	5
Rated operational current at AC-15 (Ue=250)	A	-	-	1.5
Signal indication LED				
Ready to start/stand by	On	Green	Green	Green
Ramping up/down		Yellow	Yellow (flashing)	No
Completed start ramp	T.O.R.	Yellow	Yellow	Green
General fault	F1	-	Red	Red
External fault	F2	-	-	Red

1) Above 40°C, up to max 60°C, reduce the rated current with 0.8% per °C.

2) When more than 6 starts per hour are required, contact your sales office.

3) Only if current transformer is connected (accessory).

4) The unit has built in by-pass contacts (AC-53b).

5) Valid for 50% on time and 50% off time. 3.5 x Ie for 7 sec., if other data is required, contact your sales office

Soft starters

Soft starter PS S 03...25, PS S18/30...300/515

PS S 03...25 For normal starts

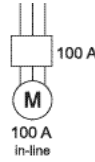

Motor Rating	230 V	400 V	Motor Rating	230 V	400 V	Current
Pe	Pe	Pe	Pe	Pe	Pe	le
kW	kW	kW	kW	kW	kW	A
-	1.1	-	-	-	-	3
-	5.5	-	-	-	-	12
-	11.0	-	-	-	-	25

Order code
PS S 03-400B
PS S 12-400B
PS S 25-400B

Control Voltage 40-110V AC/DC, 110-440 VAC.

PS S 18/30...142/245 For normal starts

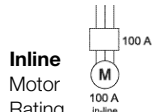

In-line						Inside Delta						Order code
Motor Rating	230 V	400 V	500 V	690 V	Current	Motor Rating	230 V	400V	500V	690V	Current	
Pe	Pe	Pe	Pe	Pe	le	Pe	Pe	Pe	Pe	Pe	le	
kW	kW	kW	kW	kW	A	kW	kW	kW	kW	kW	A	
4	7.5	11	-	18	7.5	15	18.5	-	30	PS S 18/30-500	○●	
7.5	15	18.5	-	30	12.5	25	30	-	52	PS S 30/52-500	○●	
9	18.5	22	-	37	15	30	37	-	64	PS S 37/64-500	○●	
11	22	25	-	44	22	37	45	-	76	PS S 44/76-500	○●	
12.5	25	30	-	50	25	45	55	-	85	PS S 50/85-500	○●	
15	30	37	-	60	30	55	75	-	105	PS S 60/105-500	○●	
18.5	37	45	-	72	37	59	80	-	124	PS S 72/124-500	○●	
22	45	55	-	85	40	75	90	-	147	PS S 85/147-500	○●	
30	55	75	-	105	55	90	110	-	181	PS S 105/181-500	○●	
37	75	90	-	142	75	132	160	-	245	PS S 142/245-500	○●	
45	90	110	-	175	90	160	200	-	300	PS S 175/300-500	○●	
75	132	160	-	250	132	220	295	-	430	PS S 250/430-500	○●	
90	160	200	-	300	160	257	355	-	515	PS S 300/515-500	○●	

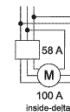

Code letter for supply voltage ○ is F = 110-120V, 50/60Hz; L = 220-240V 50/60Hz
Code letter for fault signal relay ● is Blank = NO; C = NC

Note: For heavy duty starting and 690V applications. Please Consult Us.

Soft starters Accessories

PS S 18/3...300/515

Current transformer for current limit function

To be connected to terminals 11 and 12 on the soft starter.

The setting range (1.5 – 4) corresponds to a multiple of the transformer ratio.

Technical data below shows transformer ratio and number of turns for the primary winding.

Current Transformer	For softstarter	Weight kg	Order Code
60/1 – 2 turns	PS S 18/30	0.30	PS CT-60
40/1 – 1 turn	PS S 30/52	0.30	PS CT-40
50/1 – 1 turn	PS S 37/64	0.30	PS CT-50
60/1 – 1 turn	PS S 44/76	0.30	PS CT-60
75/1 – 1 turn	PS S 50/85	0.30	PS CT-75
75/1 – 1 turn	PS S 60/105	0.30	PS CT-75
100/1 – 1 turn	PS S 72/124	0.25	PS CT-100
125/1 – 1 turn	PS S 85/147	0.25	PS CT-125
150/1 – 1 turn	PS S 105/181	0.25	PS CT-150
200/1 – 1 turn	PS S 142/245	0.25	PS CT-200
250/1 – 1 turn	PS S 175/300	0.25	PS CT-250
400/1 – 1 turn	PS S 250/430	0.25	PS CT-400
400/1 – 1 turn	PS S 300/515	0.25	PS CT-400

Cable connectors for Cu cables (set of 3)

Wire range	Tightening torque max. Nm	For softstarter	Weight kg	Order Code
6-185 mm ²	16	PS S 85/147...142/245	0.2	1SDA023354R1
2x(50-1210) mm ²	16	PS S 85/147...142/245	0.3	LZ 185-2C/120
16-240 mm ²	25	PS S 175/300...300/515	0.4	1SDA023368R1

Cable connectors for Al and Cu cables (set of 3)

Wire range	Tightening torque	For softstarter	Weight kg	Order Code
35-95 mm ²	13.35	PS S 85/147...142/245	0.1	1SDA023356R1
25-150 mm ²	31	PS S 85/147...142/245	0.1	1SDA023357R1
120-240 mm ²	43	PS S 175/300...300/515	0.1	1SDA023379R1

Terminal shrouds (set of 2)

	For softstarter	Weight kg	Order Code
For cable connectors	PS S 85/147...142/245	0.1	LT 185-AC
For compression lugs	PS S 85/147...142/245	0.1	LT 185-AL
For cable connectors	PS S 175/300...300/515	0.2	LT 300-AC
For compression lugs	PS S 175/300...300/515	0.2	LT 300-AL

Terminal nut washer (set of 2)

For softstarter	Weight kg	Order Code
PS S 85/147...142/245	0.2	LE 185
PS S 175/300...300/515	0.3	LE 300

Terminal shrouds (set of 2)

For softstarter	Weight kg	Order Code
PS S 18/30...44/76	0.1	PS LW-44
PS S 50/85...72/124	0.15	PS LW-72
PS S 85/147...142/245	0.25	LW 185
PS S 175/300...300/515	0.4	LW-300

Pilot Devices, Compact Range

non-illuminated

The compact range is a new competitive choice for OEM customers and Panel Builders with high requirements of cost efficient, easy to use and reliable products.

Features

- Reliable performance
- Less stock-keeping
- "All-in-one function"
One Order Code = one complete function
- Robust design
- Easy mounting



Part of the ABB Family

The compact range can easily be combined with our modular Pilot Devices as they have the same front design.

Worldwide availability

ABB is represented in over 130 countries. Our pilot devices meet all major international and national standards.

Technical advantages

- High degree of protection
- One or two built-in electrically separated contacts (1NO, 1NC, 2NO, 2NC or 1NC + 1NO)
- Contacts with wiping action
- Low built-in depth



Same front design for both the modular and the compact range. Robust actuators in clear colors with large text and push area.







Samples of accessories

Pilot Devices

Compact Range

Pushbuttons, Non-Illuminated



Contacts Included					
No	NC	Momentary Flush button	*Maintained Flush button	Momentary Extended button	*Maintained Extended button
1	-	CP1-10□-10	CP2-10□-10	CP3-10□-10	CP4-10□-10
2	-	CP1-10□-20	CP2-10□-20	CP3-10□-20	CP4-10□-20
-	1	CP1-10□-01	CP2-10□-01	CP3-10□-01	CP4-10□-01
-	2	CP1-10□-02	CP2-10□-02	CP3-10□-02	CP4-10□-02
1	1	CP1-10□-11	CP2-10□-11	CP3-10□-11	CP4-10□-11

chrome bezel available on request



Colour	Code Letter □
Red	R
Green	G
Yellow	Y
Blue	L
White	W
Black	B
Grey	U

Ordering Example

Requested: A compact pushbutton, momentary, with red extended button and one NO contact.

Order: 1 piece of CP3-10R-10



Contacts Included				
		Momentary Flush button, white		*Maintained Extended button, black
		With black I	with black II	with white 0
1	-	CP1-110W-10	CP1-210W-10	-
-	1	-	-	CP3-310B-01

Chrome Bezel available on request

*Maintained available Sept 2003 onwards

Pilot Devices, Compact Range

Selector switches, non-Illuminated



Two Position

Contacts Included
No NC

Contacts Included	No	NC	Maintained
1 -	-	-	C2SS1-10□-10
2 -	-	-	C2SS1-10□-20
- 1	1	-	C2SS1-10□-01
- 2	2	-	C2SS1-10□-02
1 1	1	1	C2SS1-10□-11



Maintained



Maintained



Momentary

Contacts Included	No	NC	Momentary
1 -	-	-	C2SS2-10□-10
2 -	-	-	C2SS2-10□-20
- 1	1	-	C2SS2-10□-01
- 2	2	-	C2SS2-10□-02
1 1	1	1	C2SS2-10□-11

Contacts Included	No	NC	Momentary
1 -	-	-	C2SS3-10□-10
2 -	-	-	C2SS3-10□-20
- 1	1	-	C2SS3-10□-01
- 2	2	-	C2SS3-10□-02
1 1	1	1	C2SS3-10□-11

chrome bezel available on request

Colour	Code Letter	□
Red	R	
Black	B	
Grey	U	

Three Position

Contacts Included
NO NC

Contacts Included	NO	NC	Maintained
2 -	-	-	C3SS1-10□-20
- 2	2	-	C3SS1-10□-02
1 1	1	1	C3SS1-10□-11



Maintained



Momentary

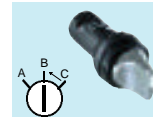

Momentary

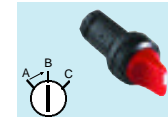

Momentary

Contacts Included	NO	NC	Momentary
2 -	-	-	C3SS2-10□-20
- 2	2	-	C3SS2-10□-02
1 1	1	1	C3SS2-10□-11

Contacts Included	NO	NC	Momentary
2 -	-	-	C3SS3-10□-20
- 2	2	-	C3SS3-10□-02
1 1	1	1	C3SS3-10□-11

Contacts Included	NO	NC	Momentary
2 -	-	-	C3SS7-10□-20
- 2	2	-	C3SS7-10□-02
1 1	1	1	C3SS7-10□-11

Ordering Example

Requested: A red compact selector switch with three positions, Momentary, spring return from A to B and maintained position in C. With 2 NC contacts.

Order: 1 piece of C3SS7-10R-02



Pilot Lights (max. 250V 3W)

Pilot light BA 9s base

Colour	Order Code
Red	CL-100R
Green	CL-100G
Yellow	CL-100Y
Blue	CL-100L
White	CL-100W
Clear	CL-100C

Direct supply. Max. 250V 3W. Use filament bulb for best light. A light diffusing lens is recommended for use with LED and neon bulbs.

Pilot Devices, Compact Range

Technical data

Technical Data

Standards

IEC 73, 529, 947-5-1, 947-5-5
 EN 50 013, 60 947-5-1
 UL 508
 CSA C22.2 No. 14

Degree of protection

Operators

Compact pushbutton	IP66
Compact pilot lights	IP66
Compact selector switch	IP66

Electrical functions

Terminals	IP20
-----------	------

Mechanical life

Pushbuttons	0.5 million operations
Selector switches	0.5 million operations

Temperature

Ambient temperature during operation	-25 to +70 °C
Storage temperature	-30 to +85 °C

Terminals

Plus-minus Pozidrive Size 2	
Connectable area	min. 1 x 0.5mm ² max. 2 x 1.5mm ² / 2 x AWG14

Contacts

Ratings as per UL, CSA, NEMA C300, R300

Rated insulation voltage	250 V
Rated thermal current	2.5 A
Rated operational current at	120 V 1.5 A
	240 V 0.75 A

Ratings as per IEC 947-5-1

Rated insulation voltage	300 V
Rated thermal current, I _{th}	5 A
Rated operational current I _e	
Utilization category AC 15, at	120 V 1.5 A
	240 V 1 A
Utilization category DC 13, at	24 V 0.3 A
	125 V 0.2 A

Short circuit protection

Max. fuse at 1 kA	16 A ordinary 10 A delayed
Pilot light	max. 3W, 240 V

Drilling Plan - for pushbuttons, switches and pilot lights

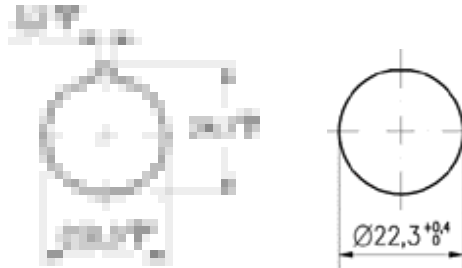

Dimensions - Compact Pushbutton

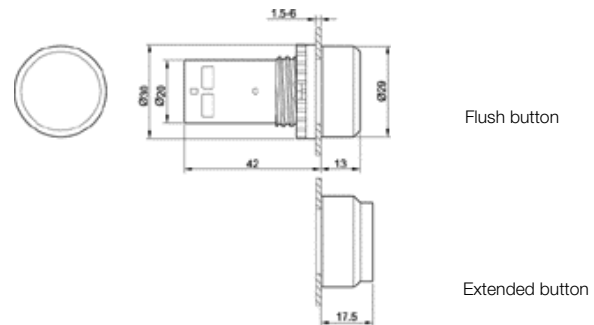

Compact Selector Switch

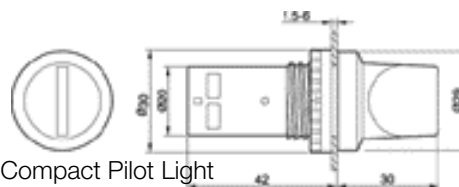

Compact Pilot Light

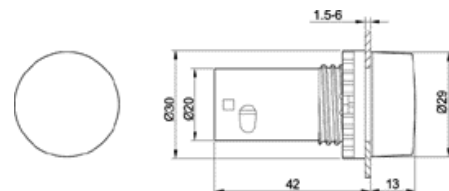

Pushbutton & pilot devices

CBK 22mm

Momentary



Flush

Maintained (push on push off)



Extended

Momentary



Maintained (push on push off)



Momentary (LED)



Maintained (LED) (push on push off)



Standard & Illuminated Pushbuttons

Description	Bezel Type	Order Code
Flush button momentary	chrome plastic	CBK-CP*
Non-illuminated	chrome	CBK-MP*
Extended button momentary	chrome plastic	CBK-CPE*
Non-illuminated	chrome	CBK-MPE*
Flush button maintained	chrome plastic	CBK-CP*
Non-illuminated	chrome	CBK-MPP*
Extended button maintained	chrome plastic	CBK-CPPE*
Non-illuminated	chrome	CBK-MPPE*
Full voltage -extended momentary illuminated pushbutton c/w lamp block & lamp	chrome plastic	CBK-CPIF □*
	chrome	CBK-MPIF □*
Resistor -extended momentary illuminated pushbutton c/w lamp block & lamp	chrome plastic	CBK-CPIR □*
	chrome	CBK-MPIR □*
Transformer -extended momentary illuminated pushbutton	chrome plastic	CBK-CPIT □*
	chrome	CBK-MPIT □*
Full voltage -extended maintained illuminated pushbutton (push-push)	chrome plastic	CBK-CPPIF □*
	chrome	CBK-MPIF □*
Resistor - extended maintained illuminated pushbutton (push-push)	chrome plastic	CBK-CPPIR □*
	chrome	CBK-MPIR □*
Transformer-extended maintained illuminated pushbutton (push-push)	chrome plastic	CBKCPPIT □*
	chrome	CBK-MPPIT □*
Full voltage -extended momentary illuminated pushbutton	chrome plastic	CBK-CPIFL8 *
	chrome	CBK-MPIFL8 *
Resistor-extended momentary illuminated pushbutton	chrome plastic	CBK-CPIRL1 *
	chrome	CBK-MPIRL1 *
Transformer-extended momentary illuminated pushbutton	chrome plastic	CBK-CPITL □*
	chrome	CBK-MPITL □*
Full voltage -extended maintained illuminated pushbutton (push-push)	chrome plastic	CBK-CPPIFL8 *
	chrome	CBK-MPIFL8 *
Resistor-extended maintained illuminated pushbutton (push-push)	chrome plastic	CBK-CPPIRL1 *
	chrome	CBK-MPIRL1 *
Transformer-extended maintained illuminated pushbutton (push-push)	chrome plastic	CBK-CPPIFL8 □*
	chrome	CBK-MPIFL8 □*

Note: Black plastic bezels available on request

Colour Code

R = Red
G = Green
Y = Yellow
L = Blue
B = Black ¹⁾
W = White ²⁾
C = Clear ²⁾

¹⁾ Only available for non-illuminated pushbuttons
²⁾ Not available for LED lamps

Voltages □ see page xx

Colour Code - Replace * with colour

Contact Blocks see page xx

ORDER EXAMPLE: **CBK-CPIF 6R**

(illuminated pushbutton c/w lamp block & lamp - 6v Direct -Red)

Pushbutton & pilot devices

CBK 22mm

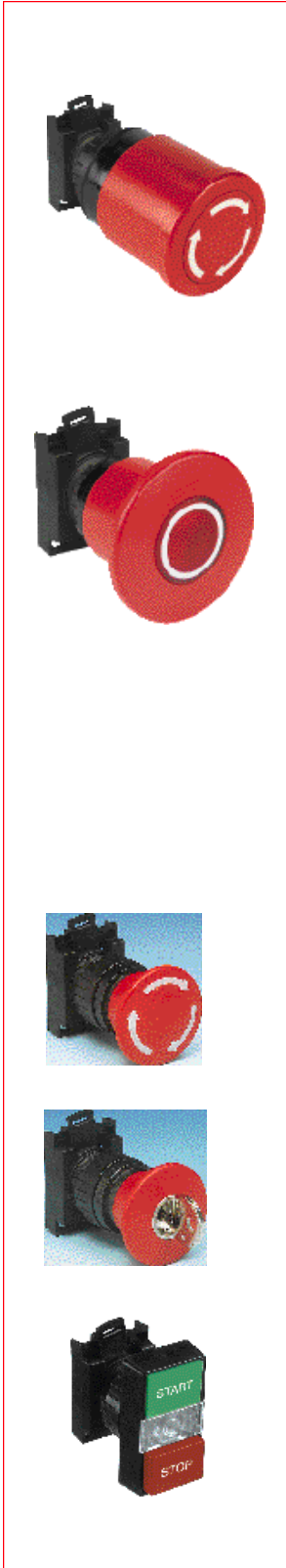

Emergency Stop (complies with EN 60947-55)

Description	Order Code
40mm Emergency Stop	
twist to release	KPMT3-20R
pull to release	KPMP3-20R
momentary	KPM1-20R
60mm Emergency Stop	
twist to release	KPMT4-20R
pull to release	KPMP4-20R
momentary	KPM2-20
40mm illuminated Emergency Stop	
twist to release	KPMT3-21R
pull to release	KPMP3-21R
momentary	KPM1-21R
60mm illuminated Emergency Stop	
twist to release	KPMT4-21R
pull to release	KPMP4-21R
momentary	KPM2-21R

Mushroom and Doubleheaded Pushbuttons.

30mm Mushroom pushbutton	
twist to release	CBK-PMT3R *
push pull	CBK-PMP3R *
momentary	CBK-PM3R *

Mushroom lockable pushbutton	
40mm maintained (red only)	CBK-PMK40R
45mm maintained (red only)	CBK-PMKR

Double pushbutton	
momentary (start stop)	CBK-2P1C
momentary (blank)	CBK-2P4C

*Standard actuator colour is RED
if BLACK is required replace R with B

Eg. CBK-PM3B = 30mm mushroom in black

Contact Blocks see page xx

Lamp Blocks see page xx

Pushbutton & pilot devices

CBK 22mm

2 Position



3 Position



Selector switches non-illuminated

Description	Bezel Type	Order Code
Non-illuminated 2 pos. short selector switches maintained (B&C)	chrome plastic chrome	CBK-C2BMK * CBK-M2BMK *
Non-illuminated 2 pos. short selector switches spring return (C to B)	chrome plastic chrome	CBK-C2BSK * CBK-M2BSK *
Non-illuminated 2 pos. short selector switches maintained (A&C)	chrome plastic chrome	CBK-C2AMK * CBK-M2AMK *
Non-illuminated 2 pos. long selector switches maintained (B&C)	chrome plastic chrome	CBK-C2BML * CBK-M2BML *
Non-illuminated 2 pos. long selector switches spring return (C to B)	chrome plastic chrome	CBK-C2BSL * CBK-M2BSL *
Non-illuminated 2 pos. long selector switches maintained (A&C)	chrome plastic chrome	CBK-C2AML * CBK-M2AML *
Non-illuminated 3 pos. short selector switches maintained (A,B&C)	chrome plastic chrome	CBK-C3MK * CBK-M3MK *
Non-illuminated 3 pos. short selector switches spring return (A&C to B)	chrome plastic chrome	CBK-C3SK * CBK-M3SK *
Non-illuminated 3 pos. short selector switches spring return (C to B) maintained (A)	chrome plastic chrome	CBK-C3SRK * CBK-M3SRK *
Non-illuminated 3 pos. long selector switches maintained (A,B&C)	chrome plastic chrome	CBK-C3ML * CBK-M3ML *
Non-illuminated 3 pos. long selector switches spring return (A&C to B)	chrome plastic chrome	CBK-C3SL * CBK-M3SL *
Non-illuminated 3 pos. long selector switches spring return (C to B) maintained (A)	chrome plastic chrome	CBK-C3SRL * CBK-M3SRL *

Note: Black plastic bezels available on request

Standard actuator colour is BLACK
if other colours are required replace *

R = RED G = GREY

Eg. CBK-C2BMKR = 2 pos switch in red

Contact Blocks see page xx

Pushbutton & pilot devices

CBK 22mm

Selector switches illuminatec (translucent actuator)

2 Position

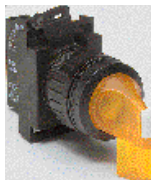

3 Position



Description	Bezel Type	Order Code
Illuminated 2 pos. short selector switches maintained (B&C)	chrome plastic	CBK-C2BMKI *
	chrome	CBK-M2BMKI *
Illuminated 2 pos. short selector switches spring return (C to B)	chrome plastic	CBK-C2BSKI *
	chrome	CBK-M2BSKI *
Illuminated 2 pos. short selector switches maintained (A&C)	chrome plastic	CBK-C2AMKI *
	chrome	CBK-M2AMKI *
Illuminated 2 pos. long selector switches maintained (B&C)	chrome plastic	CBK-C2BMLI *
	chrome	CBK-M2BMLI *
Illuminated 2 pos. long selector switches spring return (C to B)	chrome plastic	CBK-C2BSLI *
	chrome	CBK-M2BSLI *
Illuminated 2 pos. long selector switches maintained (A&C)	chrome plastic	CBK-C2AML I *
	chrome	CBK-M2AML I *
Illuminated 3 pos. short selector switches fixed (A,B&C)	chrome plastic	CBK-C3MKI *
	chrome	CBK-M3MKI *
Illuminated 3 pos. short selector switches spring return (A&C to B)	chrome plastic	CBK-C3SK I *
	chrome	CBK-M3SK I *
Illuminated 3 pos. short selector switches spring return (C to B) maintained (A)	chrome plastic	CBK-C3SRKI *
	chrome	CBK-M3SRKI *
Illuminated 3 pos. long selector switches maintained (A,B&C)	chrome plastic	CBK-C3MLI *
	chrome	CBK-M3MLI *
Illuminated 3 pos. long selector switches spring return (A&C to B)	chrome plastic	CBK-C3SLI *
	chrome	CBK-M3SLI *
Illuminated 3 pos. long selector switches spring return (C to B) maintained (A)	chrome plastic	CBK-C3SRLI *
	chrome	CBK-M3SRLI *

Contact Blocks see page xx
Lamp Blocks see page xx

Colour Code - Replace * with colour
 R = Red
 G = Green
 Y = Yellow
 L = Blue

Pushbutton & pilot devices

CBK 22mm

2 Position



3 Position



Key operated selector switches

Description	Bezel Type	Order Code
Key operated 2 pos. selector switches maintained, key removable all pos.	chrome	CBK-S2KM4
Maintained, key removable (B)	chrome	CBK-S2KM1
Momentary, key removable (B)	chrome	CBK-S2KS1
Key operated 3 pos. selector switches maintained, key removable all pos.	chrome	CBK-S3KM4
Momentary, key removable all pos. spring ret. from (A & C to B)	chrome	CBK-S3KS4
Maintained, key removable (B)	chrome	CBK-S3KM2
Momentary, key removable (B) spring ret. from (A&C to B)	chrome	CBK-S3KS2
Momentary, key removable (A) spring ret. from (C to B)	chrome	CBK-S3KSR1
Key operated maintained pushbutton, locks when depressed release via key. Key removable both positions.	chrome	CBK-PKM1

Contact Blocks see page 2/69

N.B. Different keys are available for the selector switches on request

The standard unit has key Type 71.

For key Type 72 add a "2" at the end of the reference or for key Type 73 add a "3".

Eg. CBK-S2KM1 Key 71.
 CBK-S2KM12 Key 72.
 CBK-S2KM13 Key 73.

Pushbutton & pilot devices

CBK 22mm

Lamp Holder



Lamp Holder+ Resistor



Lamp Holder + Transformer



Filament



Neon



LED



Pilot Lights

Voltage	Description	Order Code
6V	lamp & lamp block	CBK-KLF6 *
12V	lamp & lamp block	CBK-KLF7 *
24V	lamp & lamp block	CBK-KLF8 *
48V	lamp & lamp block	CBK-KLF9 *
120V	lamp & lamp block	CBK-KLF1 *
110/60V	lamp, lamp block & resistor	CBK-KLR1 *
240/120V	lamp, lamp block & resistor	CBK-KLR2 *
110/6V	lamp, lamp block & transformer	CBK-KLT1 *
240/6V	lamp, lamp block & transformer	CBK-KLT2 *
415/6V	lamp, lamp block & transformer	CBK-KLT3 *
480/6V	lamp, lamp block & transformer	CBK-KLT4 *
24V LED	lamp & lamp block	CBK-KLFL8 *
110/24V LED	lamp, lamp block & resistor	CBK-KLRL1 *
110/24V LED	lamp, lamp block & transformer	CBK-KLTL1 *
240/24V LED	lamp, lamp block & transformer	CBK-KLTL2 *
415/24V LED	lamp, lamp block & transformer	CBK-KLTL3 *
480/24V LED	lamp, lamp block & transformer	CBK-KLTL4 *

Colour Code

Replace * with colour code

R = Red
G = Green
Y = Yellow
L = Blue
W = White ¹⁾
C = Clear ¹⁾

¹⁾ Not available for LED lamps

Lamps

Description	Order Code
6V filament	CBK-LB6
12V filament	CBK-LB12
24V filament	CBK-LB24
30V filament	CBK-LB30
48V filament	CBK-LB48
60V filament	CBK-LB60
130V filament	CBK-LB1
220V neon (AC only)	CBK-LBN2
24V Red LED	CBK-LBD8R
24V Green LED	CBK-LBD8G
24V Yellow LED	CBK-LBD8Y
24V Blue LED	CBK-LBD8L
24V Red Flashing LED	CBK-LBDRF
24V Green Flashing LED	CBK-LBDGF
24V Yellow Flashing LED	CBK-LBDYF

Other voltages on request

Pushbutton & pilot devices

CBK 22mm

Resistor



Lamp Holder + Transformer



Transformer

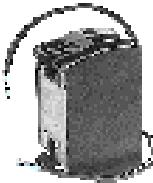

Diode Block



Resistor Type



Pilot light front mounted accessories

Description	Order Code
Full Voltage (maximum 240v)	CBK-LMF
110V/60V resistor type	CBK-LMR1
240V/120V resistor type	CBK-LMR2
24V ¹⁾ resistor type	CBK-LMR24
110V/24V ²⁾ resistor type	CBK-LMLED
110/6V lamp holder + transformer	CBK-LMT1
240/6V lamp holder + transformer	CBK-LMT2
415/6V lamp holder + transformer	CBK-LMT3
480/6V lamp holder + transformer	CBK-LMT4
110/24V ²⁾ lamp holder + transformer	CBK-LMT124
240/24V ²⁾ lamp holder + transformer	CBK-LMT224
415/24V ²⁾ lamp holder + transformer	CBK-LMT324
480/24V ²⁾ lamp holder + transformer	CBK-LMT424
110/6V transformer	CBK-LT1
240/6V transformer	CBK-LT2
415/6V transformer	CBK-LT3
480/6V transformer	CBK-LT4
110/24V ²⁾ transformer	CBK-LT124
240/24V ²⁾ transformer	CBK-LT224
415/24V ²⁾ transformer	CBK-LT324
480/24V ²⁾ transformer	CBK-LT424
250V . 1A for use with lamps connected to a common lamp test pushbutton	CBK-CBD

Lamp blocks base mounted accessories

Description	Order Code
Full Voltage (maximum 240v)	CBK-LMFB
110V/60V resistor type	CBK-LMRB1
240V/120V resistor type	CBK-LMRB2
24V ¹⁾ resistor type	CBK-LMRB24
120V/24V ²⁾ resistor type	CBK-LMRLED

¹⁾ Designed for electronic circuits ²⁾ Designed for LED 24V lamps

Pilot Heads

Colour	Order Code
Red	CBK-KAL R
Green	CBK-KAL G
Yellow	CBK-KAL Y
Blue	CBK-KAL L
White	CBK-KAL W
Clear	CBK-KAL C

Pushbutton & pilot devices

CBK 22mm

Actuator Mounted Blocks



Base Mounted Blocks

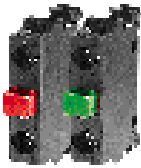

Rear Mounted Blocks



Contact Block Holders

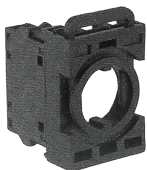

Contact blocks

Description	Type	Contact	Order Code
Contact blocks are colour coded to easily identify the contact configuration. GREEN = N/O RED = N/C	Standard	1 N/O 1 N/C	CBK-CB10 CBK-CB01
Contact blocks are colour coded to easily identify the contact configuration. GREEN = N/O RED = N/C	Gold Plated Low Energy Contacts	1 N/O 1 N/C	CBK-CB10G CBK-CB01G
Double contact block for use with 5 block holder (i.e. outer positions) and 3 block holder for selector switches when centre position is required		2 N/O 2 N/C 1 N/O + 1 N/C	CBK-CB20 CBK-CB02 CBK-CB11

Contact Block (rear mounted)

Contact blocks are colour coded to easily identify the contact configuration. GREEN = N/O RED = N/C	Standard	1 N/O 1 N/C	CBK-CBR10 CBK-CBR01
Contact blocks are colour coded to easily identify the contact configuration. GREEN = N/O RED = N/C	Gold Plated Low Energy Contacts	1 N/O 1 N/C	CBK-CBR10G CBK-CBR01G
Double contact block for use when 5 contacts are required (i.e. outer positions) and selector switches when centre position is required		2 N/O 2 N/C 1 N/O + 1 N/C	CBK-CB20B CBK-CB02B CBK-CB11B

3 contact block holder	CBK-CH
5 contact block holder	CBK-H5

Safety holder for Emergency Stop

(3 contact block holder)	KCBHS-00
--------------------------	----------

The safety holder can only be used on Emergency Stop Pushbuttons

Pushbutton & pilot devices

Accessories

Accessories

Protective Membrane

Of transparent, heat and cold resistant rubber.

Does not harden at low temperature. Gives IP 67 degrees of protection. When membrane is used, remove the gasket.

For operator with	Weight (kg)	Order Code
Flush button	0.002	CBK-KXB
Extended button	0.002	CBK-KXBE
Double Pushbutton	0.004	CBK-XB2

Mounting Tool

Used for tightening the nut of the attachment device.	0.100	1SFA616920R8015
---	-------	-----------------

30mm Adapters

For use when fitting the 22mm pilot devices in 30mm mounting holes. (1.5mm - 4mm panels)

For use with 22mm Compact Pilot Light

Black Plastic	0.010	1SFA616920R8029
Metal	0.035	1SFA616920R8030

Lamp changing tool

Designed for two different lamp diameters. The larger diameter fits filament bulbs and LEDS and the smaller diameter fits neon bulbs.

Lamp changing tool	0.002	KA1-8072
--------------------	-------	----------

Legend Plates

Engraved fixed plates with symbol/text

Symbol / text

For Push button	Legend plate material	Weight	Order Code
Off	Silver-grey aluminium	0.002	CBK-NPE10
On	Silver-grey aluminium	0.002	CBK-NPE11
Start	Silver-grey aluminium	0.002	CBK-NPE19
Stop	Silver-grey aluminium	0.002	CBK-NPE20

Symbol / text for two-position selector switch

Centre	Right	Legend plate material	Weight	Order Code
Hand	Auto	Silver-grey aluminium	0.002	CBK-NPE22
Off	On	Silver-grey aluminium	0.002	CBK-NPE24
Stop	Start	Silver-grey aluminium	0.002	CBK-NPE25

Symbol / text for three-position selector switch

Left	Centre	Right	Legend plate material	Weight	Order Code
Hand	O	Auto	Silver-grey aluminium	0.002	CBK-NPE26
Slow	Off	Fast	Silver-grey aluminium	0.002	CBK-NPE27

Blank - Aluminium (1-2 line)	CBK-NPE28
Blank - Aluminium (2-3 line)	CBK-NPE29
Blank - Plastic (1-2 line)	CBK-NPE28P
Blank - Plastic (2-3 line)	CBK-NPE29P
Emergency Stop (70mm)	CBK-NPE30



Pushbutton & pilot devices

Accessories

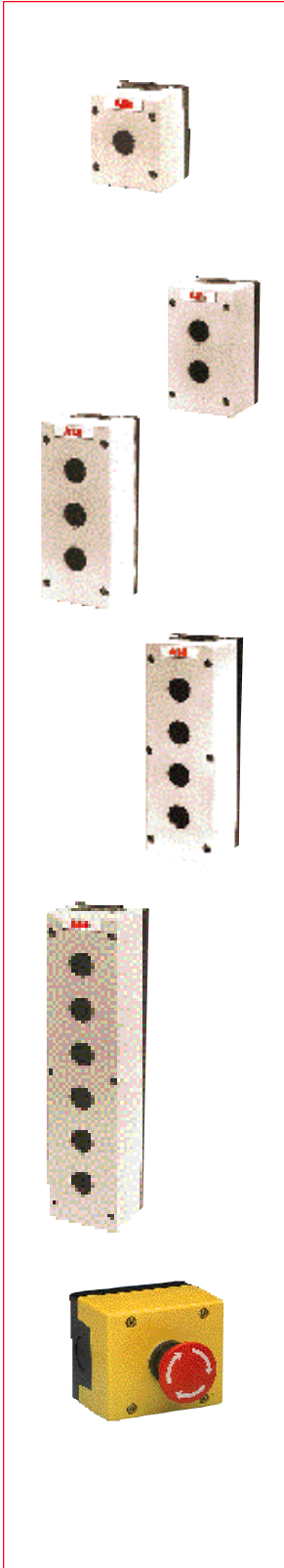

Pushbutton stations non-metallic IP 54/65

Description	Order Code
1 Element enclosure IP65	CBK-EP1
2 Element enclosure IP65	CBK-EP2
3 Element enclosure IP65	CBK-EP3
4 Element enclosure IP65	CBK-EP4
6 Element enclosure IP65	CBK-EP6
1 Element yellow enclosure (only) IP65	CBK-EPY
1 Element complete emergency stop station IP54 c/w twist to release mushroom headed button with 2 n/c contacts	CBK-EP1ES40R

Metallic enclosures available on request

Voltage Selection Chart

Voltage V	Filament / Neon			LED		
	Full Voltage	Resistor	Transformer	Full Voltage	Resistor	Transformer
6	6					
12	7					
24	8			8	1	
48	9					
110	1					
110/60		1				
240/110		2				
110/6			1			
240/6			2			
415/6			3			
480/6			4			
110/24						1
240/24						2
415/24						3
480/24						4

Switching power supplies

CP Range



CP-5/3.0

The switching power supplies CP offer many advantages in comparison to conventional supplies:

- DIN-rail mount compact modules
- Low weight
- High efficiency
- Low Heating
- Wide range of supply voltage
- Constant output voltage with good regulation
- cULus listet, UL 1604 class I, Div 2
- EN 50178 (VDE 0160)
- Short-circuit and overload proof
- Fused input

Type	Supply Voltage	Output Voltage	Weight	Order Code
CP-5/3.0	90 - 260V AC/ 105 - 260V DC	5VDC/3A	0.220	1SVR423418R3000

Frequency, AC input: 47 - 400Hz
 Output load hold time: 10ms at 100% load
 Input current at nominal load: 0.4A(90V AC) / 0.2A (260V AC)

Inrush current 25°C (2ms): 7.5A
 Internal input fuse: 3.0A(T)
 Output voltage: 5V DC ± 3%
 Output current: 3A

Type	Supply Voltage	Output Voltage	Weight	Order Code
CP-6/3.0	90-260VAC/ 105-260VDC	6VDC/3A	0.220	1SVR423418R4000

Frequency, AC input: 47 - 400Hz
 Output load hold time: 10ms at 100% load
 Input current at nominal load: 0.5A(90V AC) / 0.25A (260V AC)

Inrush current 25°C (2ms): 7.5A
 Internal input fuse: 3.0A(T)
 Output voltage: 6V DC ± 3%
 Output current: 3A

Type	Supply Voltage	Output Voltage	Weight	Order Code
CP-12/2.0	90-260VAC/ 105-260VDC	12VDC/2A	0.220	1SVR423418R1000

Frequency, AC input: 47 - 400Hz
 Output load hold time: 10ms at 100% load
 Input current at nominal load: 0.6A (90V AC) / 0.27A (260V AC)

Inrush current 25°C (2ms): 7.5A
 Internal input fuse: 3.0A(T)
 Output voltage: 12V DC ± 3%
 Output current: 2A

Adjustable output voltage

Type	Supply Voltage	Output Voltage	Weight	Order Code
CP-12/2.0 adj	90-260VAC/ 105-260V DC	12VDC/2A	0.220	1SVR423418R1100

Frequency, AC input: 47 - 400Hz
 Output load hold time: 10ms at 100% load
 Input current at nominal load: 0.7A(90V AC) / 0.3A (260V AC)

Inrush current 25°C (2ms): 33A
 Internal input fuse: 3.0A(T)
 Output voltage: 12V DC ± 3%
 Output current: 2A / 48W

Type	Supply Voltage	Output Voltage	Weight	Order Code
CP-24/0.3 adj	90-260VAC/ 105-260V DC	12VDC/2A	0.220	1SVR423418R1100

Frequency, AC input: 47 - 400Hz
 Output load hold time: 10ms at 100% load
 Input current at nominal load: 0.2A(90V AC) / 0.1A (260V AC)

Inrush current 25°C (2ms): 7.5A
 Internal input fuse: 3.0A(T)
 Output voltage: 24V DC ± 3%
 Output current: 0.3A



CP-24/0.3

Switching power supplies

CP Range



CP-24/0.5

Type	Supply Voltage	Output Voltage	Weight	Order Code
CP-24/0.5	90 - 260V AC/ 105 - 260V DC	24V DC/0.5A	0.220	1SVR423414R0000

Frequency, AC input: 47 - 440Hz
 Output load hold time: 10ms at 100% load
 Input current at nominal load: 0.3A (90V AC) / 0.15A (230VAC)
 Inrush current 25°C (2ms): 33A
 Internal input fuse: 3.0A(T)
 Output voltage: 24V DC \pm 3%
 Output current: 0.5A / 7.2W

Type	Supply Voltage	Output Voltage	Weight	Order Code
CP-24/1.0	90 - 260V AC/ 105 - 260V DC	24V DC/1A	0.220	1SVR423418R0000

Frequency, AC input: 47 - 440Hz
 Output load hold time: 10ms at 100% load
 Input current at nominal load: max. 0.58A (90V AC)
 typ. 0.45A (115VAC) typ. 0.27A (230VAC)
 Inrush current 25°C (2ms): 7.5A (260V)
 Internal input fuse: 3.0A(T)
 Output voltage: 24V DC \pm 3%
 Output current: 1A

Adjustable output voltage

Type	Supply Voltage	Output Voltage	Weight	Order Code
CP-24/1.5adj	90 - 260V AC/ 105 - 260V DC	24V DC/1.5A	0.220	1SVR423418R5000

Frequency, AC input: 47 - 440Hz
 Output load hold time: 20ms at 100% load
 Input current at nominal load: max. 0.8A (90VAC)
 typ. 0.7A (117VAC) typ. 0.39A (230VAC)
 Inrush current 25°C (2ms): 33A
 Internal input fuse: 3.0A(T)
 Output voltage: 24V DC \pm 3%
 Output current: 1.5A / 36W

Type	Supply Voltage	Output Voltage	Weight	Order Code
CP-24/2.0	90 - 140V AC	24VDC/2A	0.300	1SVR423417R0000
CP-24/2.0	140V - 260V AC/ 160 - 260V DC	24VDC/2A	0.300	1SVR423417R1000

Frequency, AC input: 47 - 63Hz (90 - 140VAC)
 47 - 440Hz (140-260VAC / 160-260VAC)
 Output load hold time: 10ms at 100% load
 Input current at nominal load: max 1.0A (90V AC) / max. 0.8A (140VAC)
 typ. 0.9A (230VAC) typ. 0.45A (230VAC)
 Inrush current 25°C (2ms): 23A (140VAC / 9A (260VAC)
 Internal input fuse: 3.0A(T)
 Output voltage: 24V DC \pm 3%
 Output current: 2A / 48W

Switching power supplies

CP Range



CP-24/2.0 adj

Adjustable output voltage

Type	Supply Voltage	Output Voltage	Weight	Order Code
CP-24/2.0adj	140 - 260V AC/ 160 - 260V DC	24V DC/2A	0.280	1SVR423417R1100

Frequency, AC input: 47 - 440Hz
 Output load hold time: 10ms at 100% load
 Input current at nominal load: max. 1.5A (90V AC)
 typ. 1.1A (115V AC) typ. 0.52A(230VAC)
 Inrush current 25°C (2ms): 40A (260V)
 Internal input fuse: 2.0A(T)
 Output voltage: 24V DC ± 3%
 Output current: 2A / 48W



CP-24/4.2

Type	Supply Voltage	Output Voltage	Weight	Order Code
CP-24/4.2	90 - 260V AC/ 127 - 260V DC	24V DC/4.2A	0.580	1SVR423416R1000

Frequency, AC input: 47 - 63Hz
 Output load hold time: 20ms at 100% load
 Input current at nominal load: max. 1.5A (90V AC)
 typ. 1.1A (115VAC) typ. 0.52A (230VAC)
 Inrush current 25°C (2ms): 40A (260V)
 Internal input fuse: 2.0A(T)
 Output voltage: 24V DC ± 3%
 Output current at T = 55°C: V_n 90-260VAC - 4.2A / V_n 127-260VAC - 4.2A

Type	Supply Voltage	Output Voltage	Weight	Order Code
CP-24/5.0	90 - 260V AC/ 127 - 260V DC	24VDC/5.0A	0.580	1SVR423416R0000

Frequency, AC input: 47 - 63Hz
 Output load hold time: 10ms at 100% load
 Input current at nominal load: max. 1.8A (90VAC)
 typ. 1.3A (115VAC) typ. 0.63A (230VAC)
 Inrush current 25°C (2ms): 40A (260V)
 Internal input fuse: 2.0A(T)
 Output voltage: 24V DC ± 3%
 Output current: T = 40°C T > 40°C T = 55°C
 V_n > 45°C 5A - 0.054A/°C 4.2A
 V_n < 90VDC or < 140VAC 5A - 0.054A/°C 4.2A



CP-24/5.0 adj

Adjustable output voltage

Type	Supply Voltage	Output Voltage	Weight	Order Code
CP-24/5.0 adj	90V - 260V AC/ 127 - 260V DC	24VDC/5A	0.580	1SVR423416R0100

Frequency, AC input: 47 - 63Hz
 Output load hold time: 10ms at 100% load
 Input current at nominal load: max 1.8A (90V AC)
 typ. 1.3A (115VAC) typ. 0.63A (230VAC)
 Inrush current 25°C (2ms): 40A (260V)
 Internal input fuse: 2.0A(T)
 Output voltage: 24VDC ± 3% (23-28VDC adjustable with poti., max. 120W)
 Output current: T = 40°C T > 40°C T = 55°C
 V_n > 45°C 5A/120W - 1.33W/°C 4.2A/100W
 V_n < 90VDC or < 140VAC 5A/120W - 1.33W/°C 4.2A/100W

Switching power supplies

CP Range



CP-24/10 adj

Adjustable output voltage

Type	Supply Voltage	Output Voltage	Weight	Order Code
CP-24/10 adj	93 - 132VAC/ 187 - 264V DC	24V DC/10A	1.050	1SVR432415R0000

Frequency, AC input:	47 - 63Hz
Output load hold time:	20ms at 100% load max. 4.3A (93VAC)
Input current at nominal load:	typ. 3.5A (115VAC) typ. 1.7A (230VAC) max. 69A (230V)
Inrush current 25°C (1ms):	4.0A(T)
Internal input fuse:	24V DC ± 1% (24 - 28VDC adjustable with a screwdriver)
Output voltage:	
Output current:	T 60°C T > 60°C T = 70°C
V _n 93 - 132VAC	10A - 2%/°C 8A
V _n 187 - 264VDC	10A - 2%/°C 8A

Redundant module

Type	Input current	Output current	Weight	Order Code
CP-RUD	5A max.	5A max.	0.150	1SVR423418R9000

Monitors two CP range power supplies up to 5A current each. If one power supply fails the CP-RUD automatically switches to the alternative supply without interruption of the load current. Max. voltage 40V.

Adjustable output voltage

Type	Supply Voltage	Output Voltage	Weight	Order Code
CP-24/20 adj	93 - 123VAC/ 187 - 264VAC	24V DC/20A	2.200	1SVR423415R1000



CP-24/20 adj

Frequency, AC input:	47 - 63Hz
Output load hold time:	15ms at 100% load max. 8.9A (93VAC)
Input current at nominal load:	typ. 7.2A (115VAC) typ. 3.5A (230VAC) max. 65A (230V)
Inrush current 25°C (2ms):	10A(T)
Internal input fuse:	24VDC ± 1% (28 - 24VDC adjustable with screwdriver)
Output voltage:	
Output current:	T 60°C T 60°C T = 70°C
V _n 93 - 132VAC	20A - 2%/°C 16A
V _n 187 - 264VDC	20A - 2%/°C 16A

Type	Supply Voltage	Output Voltage	Weight	Order Code
CP-48/.07	90 - 260V AC/ 105 - 260V DC	48V DC/0.7A	0.300	1SVR423418R6000



CP-48/.07

Frequency, AC input:	47 - 440Hz
Output load hold time:	10ms at 100% load max 0.8A (90V AC)
Input current at nominal load:	typ. 0.7A (115VAC) typ. 0.35A (230VAC) 33A (260V)
Inrush current 25°C (2ms):	3.0A(T)
Internal input fuse:	48V DC ± 3%
Output voltage:	
Output current:	0.7A
T _v > 45°C	- 10mA/°C
V _n < 105VAC/120VDC	- 6.667mA/V

Linear power supplies

CP-L Range



CP-L

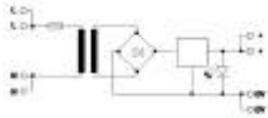

5VDC, 12VDC
15VDC, 24VDC

All power supplies are DINrail mountable and available with 230V or 115VAC input voltage, and deliver a stable and regulated DC output voltage with a low residual ripple of $\pm 1\%$.

- The output is short-circuit and overload protected
- A LED provides status operation

Type	Supply Voltage	Output Voltage	Weight	Order Code
CP-L5/1.0	115VAC	5VDC/1A	0.820	1SVR419500R3000
	230VAC	5VDC/1A	0.820	1SVR419500R3100

Frequency, AC input:	47 - 63Hz
Mains buffering:	min. 5 ms with 100% load
Input current at nominal load:	typ. 0.16A, 115V / typ. 0.08A, 230V
Internal input fuse:	0.2A (T) 115V / 0.125A (T) 230V

Type	Supply Voltage	Output Voltage	Weight	Order Code
CP-L12/0.5	115VAC	12VDC/0.5A	0.820	1SVR419501R1000
	230VAC	12VDC/0.5A	0.820	1SVR419501R1100
CP-L12/1.0	115VAC	12VDC/1A	0.780	1SVR419501R3000
	230VAC	12VDC/1A	0.780	1SVR419501R3100

Frequency, AC input:	47 - 63Hz	
Mains buffering:	min. 5 ms with 100% load	
Input current at nominal load:	0.5A: typ. 0.14A / typ. 0.07A	1A: 0.32A / 0.16 (T)
Internal input fuse:	0.5A: 0.2A(T) / 0.125A (T)	1A: 0.4A (T) / 0.2A (T)

Type	Supply Voltage	Output Voltage	Weight	Order Code
CP-L15/0.5	115VAC	15VDC/0.5A	0.820	1SVR419502R1000
	230VAC	15VDC/0.5A	0.820	1SVR419502R1100
CP-L15/1.0	115VAC	15VDC/1A	0.780	1SVR419502R3000
	230VAC	15VDC/1A	0.780	1SVR419502R3100

Frequency, AC input:	47 - 63Hz	
Mains buffering:	min. 5 ms with 100% load	
Input current at nominal load:	0.5A: typ. 0.14A / typ. 0.07A	1A: 0.35A / 0.175 (T)
Internal input fuse:	0.5A: 0.2A(T) / 0.125A (T)	1A: 0.4A (T) / 0.2A (T)

Linear power supplies

CP-L Range



Type	Supply Voltage	Output Voltage	Weight	Order Code
CP-L24/0.25	115VAC	24VDC/0.25A	0.820	1SVR419503R0000
	230VAC	24VDC/0.25A	0.820	1SVR419503R0100
CP-L24/0.75	115VAC	24VDC/0.75A	1.050	1SVR419503R2000
	230VAC	24VDC/0.75A	1.050	1SVR419503R2100

Frequency, AC input: 47 - 63Hz
 Mains buffering: min. 5 ms with 100% load
 Input current at nominal load: 0.25A: typ. 0.14A / typ. 0.07A 0.75A: 0.35A / 0.175 (T)
 Internal input fuse: 0.25A: 0.2A(T) / 0.125A (T) 0.75A: 0.4A (T) / 0.2A (T)

Type	Supply Voltage	Output Voltage	Weight	Order Code
CP-L±12/0.5	115VAC	± 12VDC/0.5A	1.070	1SVR419511R1000
	230VAC	± 12VDC/0.5A	1.070	1SVR419511R1100

Frequency, AC input: 47 - 63Hz
 Mains buffering: min. 5 ms with 100% load
 Input current at nominal load: typ. 0.35A, 115V / typ. 0.16A, 230V
 Internal input fuse: 0.4A (T) 115V / 0.2A (T) 230V

Type	Supply Voltage	Output Voltage	Weight	Order Code
CP-L±15/0.5	115VAC	± 15VDC/0.5A	1.070	1SVR419512R1000
	230VAC	± 15VDC/0.5A	1.070	1SVR419512R1100

Frequency, AC input: 47 - 63Hz
 Mains buffering: min. 5 ms with 100% load
 Input current at nominal load: typ. 0.35A, 115V / typ. 0.175A, 230V
 Internal input fuse: 0.4A (T) 115V / 0.2A (T) 230V

Power supplies CP range

Technical Data

Description	CP-5/3.0	CP-6/3.0	CP-12/2.0	CP-12/2.0 adj	CP-24/0.3
Residual ripple / noise	max.50mVpp		Max.300mVss	max.200mVss	max.100mVss
Deviation of output with input change	max. ±0.5%		max. ±0.1%	max. ±0.5%	
Deviation of output with static load change			max. ±0.5%		
Dev. of output with static load change 10 - 90%			max. 5%		
Short circuit protection	overcurrent switch off with automatic restart				
Overload protection	overtemperature and overcurrent switch off				
Reset after thermal overload	Disconnection of AC power input min. 30 s				
Standards, Tests					
Electrical safety standards	EN 50178 (VDE 0160) / UL 508 / CSA 22.2				
Galvanic isolation	reliable isolation acc. to IEC 644-1, DIN VDE 0106-101				
Voltage withstand input <-> output	2.5kVAC, 3 kVAC type test				
Clearance and creepage distances	overvoltage category 2, pollution degree 2				
Electromagnetic compatibility (EMC-tests) acc. to EN 50082-2	ESD: RF field: Burst: Surge: Conducted RF:		EN 61000-4-2 level 3 EN 61000-4-4 level 3 EN 61000-4-5 level 4 EN 61000-4-5 level 3 EN 61000-4-6 level 3	6/8kV 10V/m 4kV 3kV 10V	
Electromagn. compatibility (EMC) acc. to EN 50081-2, Radiated noise EN 55011	class B	class B	class B	class B	class B
Input current harmonics	no limitation				
Degree of protection terminals	IP20	IP20	IP20	IP20	IP20
Degree of protection enclosure	IP50	IP30	IP50	IP30	IP50
Protection class	1	1	1	1	1
General Data					
Efficiency	approx. 84%	approx. 82-84% (90-260VAC)	approx. 83-86% (102-260VAC)	approx. 82-86% (90-260VAC)	approx. 83-86% (140-260VAC)
Status indication	green LED, power OK				
Operating temperature	0° – +55°C				
Storage temperature	-25°C – +75°C				
Terminals	screw terminals, 2 x 14 AWG (2 x 2.5mm ²)				
Weight	approx. 0.22kg (0.49 lb)				
Dimensions (W x H x D), mm	45 x 78 x 100				

Description	CP-24/0.5	CP-24/1.0	CP-24/1.5	CP-24/2.0	CP-24/2.0 adj
Residual ripple / noise	max.100mVss		max.300mVss		max.100mVss
Deviation of output with input change	max. ±0.5%	max. ±0.1%	max. ±0.5%	max. ±0.2%	max. ±0.5%
Deviation of output with static load change			max. ±0.5%		
Dev. of output with static load change 10 - 90%			max. 5%		
Short circuit protection	overcurrent switch off with automatic restart				
Overload protection	overtemperature and overcurrent switch off				
Reset after thermal overload	disconnection of AC power input min. 30s				
Standards, Tests					
Electrical safety standards	EN 50178 (VDE 0160) / UL508 / CSA 22.2				
Galvanic isolation	reliable isolation acc. to IEC 664-1, DIN VDE 0106-101				
Voltage withstand input <-> output	2.5kVAC, 3kVAC type test				
Clearance and creepage distances	overvoltage category 2, pollution degree 2				
Electromagnetic compatibility (EMC-tests) acc. to EN 50082-2	ESD: RF field: Burst: Surge: Conducted RF:		EN 61000-4-2 level 3 EN 61000-4-4 level 3 EN 61000-4-5 level 4 EN 61000-4-5 level 3 EN 61000-4-6 level 3	6/8kV 10V/m 4kV 3kV 10V	
Electromagn. compatibility (EMC) acc. to EN 50081-2, Radiated noise EN 55011	class B	class B	class B	class B	class B
Input current harmonics	no limitation				
Degree of protection terminals	IP20	IP20	IP20	IP20	IP20
Degree of protection enclosure	IP50	IP50	IP30	IP20	IP30
Protection class	1	1	1	1	1
General Data					
Efficiency	approx. 84%	approx. 82-84% (90-260VAC)	approx. 83-86% (102-260VAC)	approx. 82-86% (90-260VAC)	approx. 83-86% (140-260VAC)
Status indication	green LED, power OK				
Operating temperature	0° – +55°C				
Storage temperature	-25°C – +75°C				
Terminals	screw terminals, 2 x 14AWG (2.5mm ²)				
Dimensions (W x H x D), mm	22.5 x 78 x 100	45 x 78 x 100	45 x 78 x 100	45 x 78 x 120	45 x 78 x 120

Power supplies CP range

Technical Data

Description	CP-24/4.2	CP-24/5.0	CP-24/5.0 adj	CP-48/0.7	CP-24/10 adj	CP-24/20 adj
Residual ripple / noise		max.200mVss		max.300mVss	max.50mVss	max.100mVss
Deviation of output with input change		max.±0.05%		max.±0.5%		max.±0.2%
Deviation of output with static load change			max.5%			max.±1.3 (±1.5% parallel operation)
Short circuit protection		overcurrent switch off with automatic restart				
Overload protection		overtemperature and overcurrent switch off			overcurrent limiting	
Reset after thermal overload		disconnection of ACpower input min. 30s				
Overvoltage protection					triggerpoint at typ. 140% nom. output voltage	
Parallel operation (option)					up to 5 modules (must be enabled by internal jumper)	
Standards, Tests						
Electrical safety standards		EN 50178 (VDE 0160) UL 508 / CSA 22.2			EN 50178 (VDE 0160) / EN 9060 / UL 508 / CSA 22.2	
Galvanic isolation reliable isolation acc. to		EN 60950 DIN/VDE 0106-101		IEC 664-1 DIN/ VDE 0106-101	EN 60950 DIN/ VDE 0106-101	EN 60950
Voltage withstand input->output		1.5kVAC, 3kVACtype test		2.5kVAC, 3kVAC type test	3kVACtype test	
Clearance and creepage distances		overvoltage category 3, pollution degree 2			overvoltage category 2, pollution degree 2	
Electromagn. comp. (EMC tests) to EN 50082-2						
ESD:		EN 61000-4-2 level 3	6/8kV		EN 61000-4-2 level 3	6/8kV
RF Field:		EN 61000-4-3 level 3	10V/m		EN 61000-4-3 level 3	10V/m
Burst:		EN 61000-4-4 level 3	2kV (CP-48/0.7 4kV)		EN 61000-4-4 level 3	4kV
Surge:		EN 61000-4-5	2kV (CP-48/0.7 3kV)		EN 61000-4-5 level 4	2/4kV
Conducted RF:		EN 61000-4-6 level 3	10V		EN 61000-4-6 level 3	10V
Input current harmonics				no limitation		
Degree of protection terminals	IP20	IP20	IP20	IP20	IP20	IP20
Degree of protection enclosure	IP20	IP20	IP20	IP30	IP20	IP20
Protection class	1	1	1	1	1	1
General Data						
Efficiency	approx. 77-85% (90-260VAC)	approx. 77-85% (90-260VAC)	approx. 77-85% (90-260VAC)	approx. 83-85% (90-260VAC)	typ.90% (230VAC)	typ. 88% (230VAC)
Status indication	green LED, power OK					
Operating temperature	0°C – +55°C			-25°C – +70°C		
Storage temperature	-25°C – +75°C			-25°C – +85°C		
Screw terminals	2x14 AWG (2 x 2.5mm ²)			14AWG (2.5mm ²)		
Dimensions (W x H x D), mm	90 x 78 x 120			45 x 78 x 100	100 x 125 x 125	220 x 125 x 125
Mounting hints	Normal position: horizontal onto DIN-rail					
Spacing to other modules	left 1cm, vertical distances 5 cm			both sides min. 5cm, vertical distances min. 8 cm		

Power supplies CP range

Technical Data

Description	CP-L5/1.0	CP-L12/0.5 CP-L12/1.0	CP-L15/0.5 CP-L15/1.0	CP-L24/0.25 CP-L24/0.75	CP-L±12/0.5 CP-L±15/0.5
Residual ripple / noise					± 1%
Short circuit protection					overcurrent switch off with automatic restart
Overload protection					overtemperature and overcurrent switch off
Reset after thermal overload					automatic after cooling
Standards, Tests					
Electrical safety standards					EN 50178 (VDE 0160)
Galvanic isolation					reliable isolation EN 60950
Voltage withstand input<->output					4kVAC, 4VAC test
Clearance and creepage distances					overvoltage category III pollution degree 2
Electromagn. compatibility (EMC-test)					
ESD:					EN61000-4-2 level 3 (6/8kV)
RF fields					EN61000-4-3 level 3 (10V/m)
Burst:					EN61000-4-4 level 3 (2kV)
Surge:					EN61000-4-5 level 3 (2kV)
Conducted RF:					EN61000-4-6 level 3 (10V)
Input current harmonics					no limiting
Degree of protection					
Terminals:					IP20
Enclosures:					IP20
Protection class:					2 with external product protection
General Data					
Status indication					green LED
Operating temperature					-20 – +50°C
Storage temperature					-40 – +80°C
Terminals					screw terminals 14AWG (2.5mm ²)
Dimensions (W x H x D) 0.25A					100 x 104 x 79mm
Dimensions (W x H x D) 0.25A					100 x 104 x 79mm 135 x 104 x 79mm
Dimensions (W x H x D) 0.25A					135 x 104 x 79mm
Dimensions (W x H x D) 0.25A					100 x 104 x 79mm
Mounting hints					Normal position: horizontal onto DIN rail, Spacing to other modules upper 100mm, lower 50mm, sides 20mm