

LM4030

SOT-23 Ultra-High Precision Shunt Voltage Reference

General Description

The LM4030 is an ultra-high precision shunt voltage reference, having exceptionally high initial accuracy (0.05%) and temperature stability (10ppm/°C). The LM4030 is available with fixed voltage options of 2.5V and 4.096V. Despite the tiny SOT23 package, the LM4030 exhibits excellent thermal hysteresis (75ppm) and long-term stability (40ppm) as well as immunity to board stress effects.

The LM4030 is designed to operate without an external capacitor, but any capacitor up to 10µF may be used. The LM4030 can be powered off as little as 120µA (max) but is capable of shunting up to 30mA continuously. As with any shunt reference, the LM4030 can be powered off of virtually any supply and is a simple way to generate a highly accurate system reference.

The LM4030 is available in three grades (A, B, and C). The best grade devices (A) have an initial accuracy of 0.05% with guaranteed temperature coefficient of 10 ppm/°C or less, while the lowest grade parts (C) have an initial accuracy of 0.15% and a temperature coefficient of 30 ppm/°C.

Features

- High output voltage accuracy 0.05%
- Low temperature coefficient 10 ppm/°C
- Extended temperature operation -40-125°C
- Excellent thermal hysteresis, 75ppm
- Excellent long-term stability, 40ppm
- High immunity to board stress effects
- Capable of handling 50 mA transients
- Voltage options 2.5V, 4.096V
- SOT23-5 Package

Applications

- Data Acquisition/Signal path
- Test and Measurement
- Automotive & Industrial
- Communications
- Instrumentation
- Power Management

Typical Application Circuit

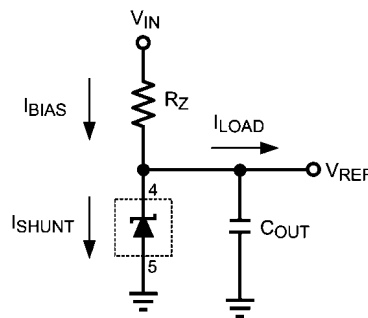

30046301

Connection Diagram

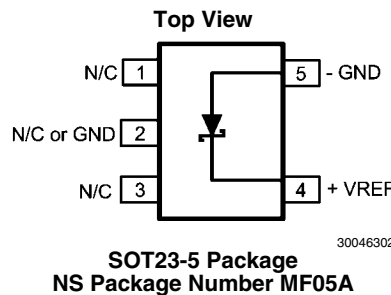

30046302

Ordering Information

Input Output Voltage Accuracy at 25°C And Temperature Coefficient	LM4030 Supplied as 1000 units, Tape and Reel	LM4030 Supplied as 3000 units, Tape and Reel	Part Marking
0.05%, 10 ppm/°C max (A grade)	LM4030AMF-2.5	LM4030AMFX-2.5	R5JA
	LM4030AMF-4.096	LM4030AMFX4.096	R5KA
0.10%, 20 ppm/°C max (B grade)	LM4030BMF-2.5	LM4030BMFX-2.5	R5JB
	LM4030BMF-4.096	LM4030BMFX4.096	R5KB
0.15%, 30 ppm/°C max (C grade)	LM4030CMF-2.5	LM4030CMFX-2.5	R5JC
	LM4030CMF-4.096	LM4030CMFX4.096	R5KC

Pin Descriptions

Pin #	Name	Function
1	N/C	No connect pin, leave floating
2	GND, N/C	Ground or no connect
3	N/C	No connect pin, leave floating
4	VREF	Reference voltsge
5	GND	Ground

Absolute Maximum Ratings (Note 1)

If Military/Aerospace specified devices are required, please contact the National Semiconductor Sales Office/Distributors for availability and specifications.

Maximum Voltage on any input	-0.3 to 6V
Power Dissipation ($T_A = 25^\circ\text{C}$) (Note 2)	350mW
Storage Temperature Range	-65°C to 150°C
Lead Temperature (soldering, 10sec)	260°C
Vapor Phase (60 sec)	215°C

Infrared (15sec)	220°C
ESD Susceptibility (Note 3)	
Human Body Model	2kV

Operating Ratings

Maximum Continuous Shunt Current	30mA
Maximum Shunt Current (<1s)	50mA
Junction Temperature Range (T_J)	-40°C to $+125^\circ\text{C}$

Electrical Characteristics

LM4030-2.5 ($V_{\text{OUT}} = 2.5\text{V}$) Limits in standard type are for $T_J = 25^\circ\text{C}$ only, and limits in boldface type apply over the junction temperature (T_J) range of -40°C to $+125^\circ\text{C}$. Minimum and Maximum limits are guaranteed through test, design, or statistical correlation. Typical values represent the most likely parametric norm at $T_J = 25^\circ\text{C}$, and are provided for reference purposes only.

Symbol	Parameter	Conditions	Min (Note 4)	Typ (Note 5)	Max (Note 4)	Unit
V_{REF}	Reverse Breakdown Voltage	$I_{\text{SHUNT}} = 120\mu\text{A}$		2.5		V
	Reverse Breakdown Voltage Tolerance ($I_{\text{SHUNT}} = 120\mu\text{A}$)					
	LM4030A-2.5	(A Grade - 0.05%)	-0.05		0.05	%
	LM4030B-2.5	(B Grade - 0.10%)	-0.10		0.10	%
	LM4030C-2.5	(C Grade - 0.15%)	-0.15		0.15	%
I_{RMIN}	Minimum Operating Current				120	μA
TC	Temperature Coefficient (Note 6)					
	LM4030A-2.5	$0^\circ\text{C} \leq T_J \leq +85^\circ\text{C}$			10	ppm / $^\circ\text{C}$
		$-40^\circ\text{C} \leq T_J \leq +125^\circ\text{C}$			20	ppm / $^\circ\text{C}$
	LM4030B-2.5	$-40^\circ\text{C} \leq T_J \leq +125^\circ\text{C}$			20	ppm / $^\circ\text{C}$
	LM4030C-2.5	$-40^\circ\text{C} \leq T_J \leq +125^\circ\text{C}$			30	ppm / $^\circ\text{C}$
$\Delta V_{\text{REF}}/\Delta I_{\text{SHUNT}}$	Reverse Breakdown Voltage Change with Current	$160\mu\text{A} \leq I_{\text{SHUNT}} \leq 30\text{mA}$		25	110	ppm / mA
ΔV_{REF}	Long Term Stability (Note 7)	1000 Hrs, $T_A = 30^\circ\text{C}$		40		ppm
V_{HYST}	Thermal Hysteresis (Note 8)	$-40^\circ\text{C} \leq T_J \leq +125^\circ\text{C}$		75		ppm
V_{N}	Output Noise Voltage (Note 9)	0.1 Hz to 10 Hz		105		μV_{PP}

Electrical Characteristics

LM4030-4.096 ($V_{OUT} = 4.096V$) Limits in standard type are for $T_J = 25^\circ C$ only, and limits in boldface type apply over the junction temperature (T_J) range of $-40^\circ C$ to $+125^\circ C$. Minimum and Maximum limits are guaranteed through test, design, or statistical correlation. Typical values represent the most likely parametric norm at $T_J = 25^\circ C$, and are provided for reference purposes only.

Symbol	Parameter	Conditions	Min (Note 4)	Typ (Note 5)	Max (Note 4)	Unit
V_{REF}	Reverse Breakdown Voltage	$I_{SHUNT} = 130\mu A$		4.096		V
	Reverse Breakdown Voltage Tolerance ($I_{SHUNT} = 130\mu A$)					
	LM4030A-4.096	(A Grade - 0.05%)	-0.05		0.05	%
	LM4030B-4.096	(B Grade - 0.10%)	-0.10		0.10	%
	LM4030C-4.096	(C Grade - 0.15%)	-0.15		0.15	%
I_{RMIN}	Minimum Operating Current				130	μA
TC	Temperature Coefficient (Note 6)					
	LM4030A-4.096	$0^\circ C \leq T_J \leq +85^\circ C$			10	ppm / $^\circ C$
		$-40^\circ C \leq T_J \leq +125^\circ C$			20	ppm / $^\circ C$
	LM4030B-4.096	$-40^\circ C \leq T_J \leq +125^\circ C$			20	ppm / $^\circ C$
	LM4030C-4.096	$-40^\circ C \leq T_J \leq +125^\circ C$			30	ppm / $^\circ C$
$\Delta V_{REF}/\Delta I_{LOAD}$	Reverse Breakdown Voltage Change with Current	$160\mu A \leq I_{SHUNT} \leq 30mA$		15	95	ppm / mA
ΔV_{REF}	Long Term Stability (Note 7)	1000 Hrs, $T_A = 30^\circ C$		40		ppm
V_{HYST}	Thermal Hysteresis (Note 8)	$-40^\circ C \leq T_J \leq +125^\circ C$		75		ppm
V_N	Output Noise Voltage (Note 9)	0.1 Hz to 10 Hz		165		μV_{PP}

Note 1: Absolute Maximum Ratings indicate limits beyond which damage may occur to the device. Operating Ratings indicate conditions for which the device is intended to be functional, but do not guarantee specific performance limits. For guaranteed specifications, see Electrical Characteristics.

Note 2: Without PCB copper enhancements. The maximum power dissipation must be de-rated at elevated temperatures and is limited by T_{JMAX} (maximum junction temperature), θ_{JA} (junction to ambient thermal resistance) and T_A (ambient temperature). The maximum power dissipation at any temperature is: $P_{DissMAX} = (T_{JMAX} - T_A) / \theta_{JA}$ up to the value listed in the Absolute Maximum Ratings. θ_{JA} for SOT23-5 package is $220^\circ C/W$, $T_{JMAX} = 125^\circ C$.

Note 3: The human body model is a 100 pF capacitor discharged through a 1.5 k Ω resistor into each pin.

Note 4: Limits are 100% production tested at $25^\circ C$. Limits over the operating temperature range are guaranteed through correlation using Statistical Quality Control.

Note 5: Typical numbers are at $25^\circ C$ and represent the most likely parametric norm.

Note 6: Temperature coefficient is measured by the "Box" method; i.e., the maximum ΔV_{REF} is divided by the maximum ΔT .

Note 7: Long term stability is V_{REF} @ $25^\circ C$ measured during 1000 hrs. This measurement is taken for $I_R = 500 \mu A$.

Note 8: Thermal hysteresis is defined as the change in $+25^\circ C$ output voltage before and after cycling the device from $(-40^\circ C$ to $125^\circ C)$ eight times.

Note 9: Low frequency peak-to-peak noise measured using first-order 0.1 Hz HPF and second-order 10 Hz LPF.

Typical Performance Characteristics for 2.5V

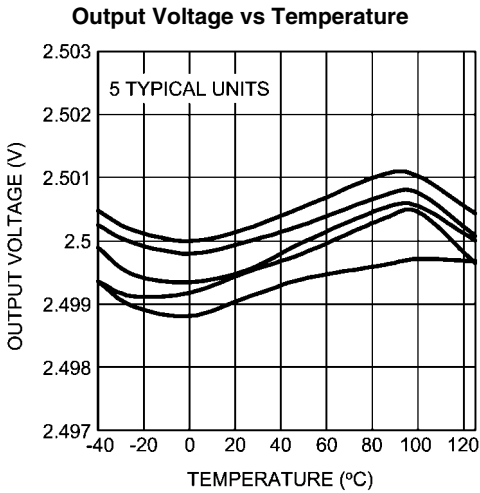

30046332

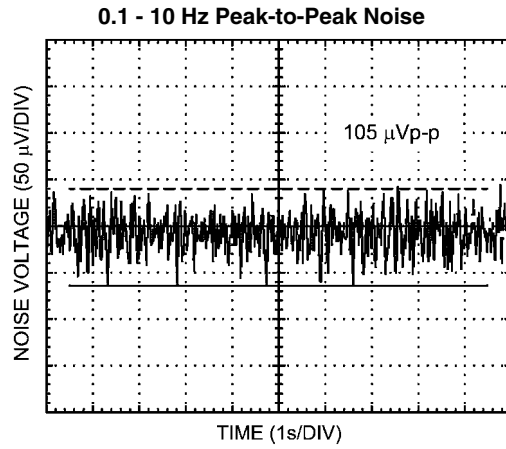

30046303

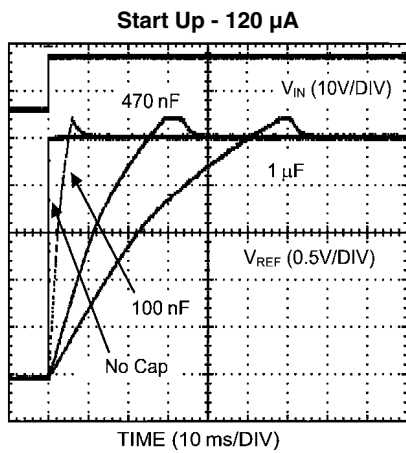

30046304

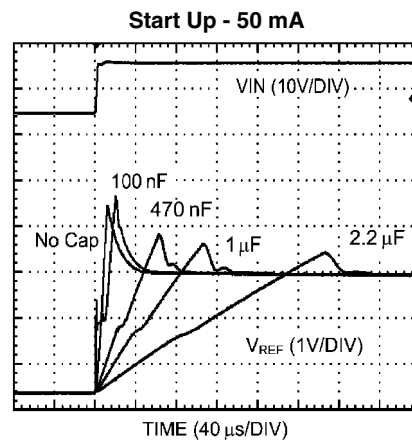

30046305

Reverse Breakdown Voltage Change with Current

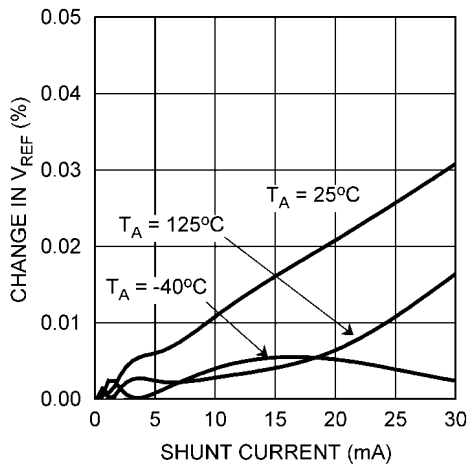

30046314

Reverse Dynamic Impedance vs Frequency

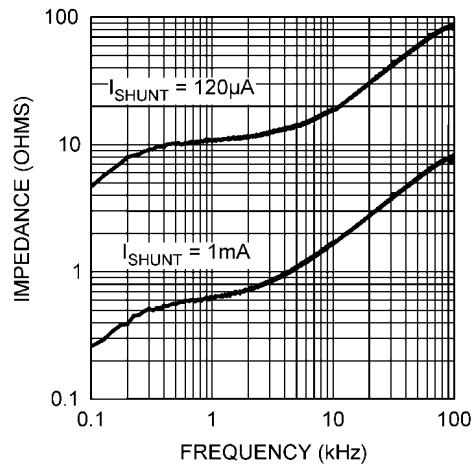

30046340

Typical Performance Characteristics for 4.096V

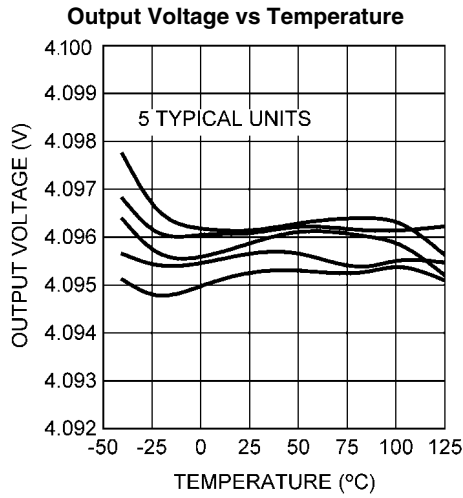

30046349

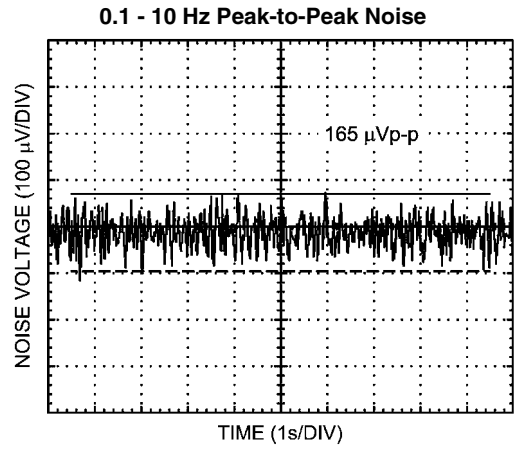

30046306

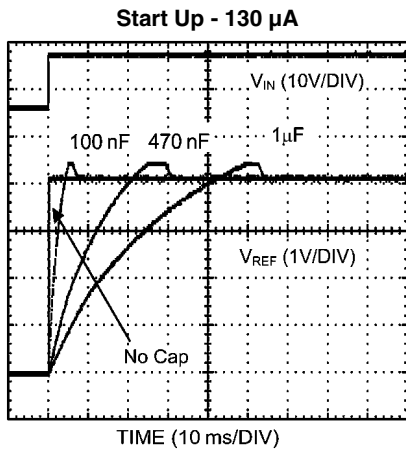

30046307

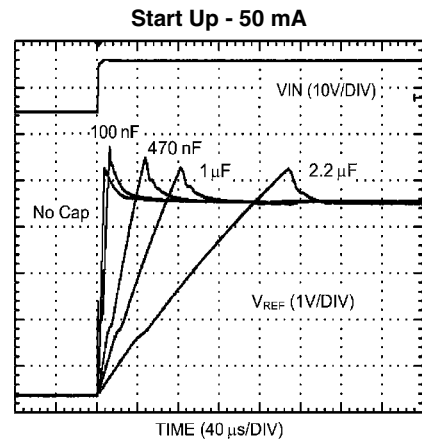

30046308

Reverse Breakdown Voltage Change with Current

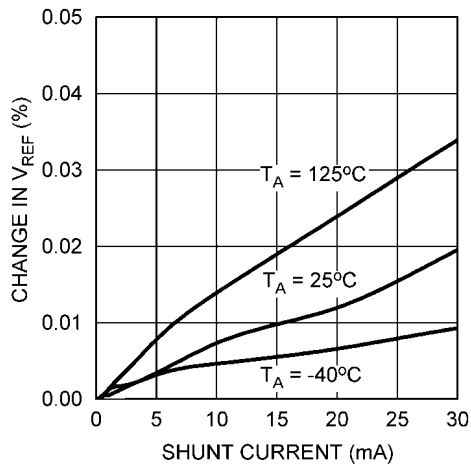

30046312

Reverse Dynamic Impedance vs Frequency

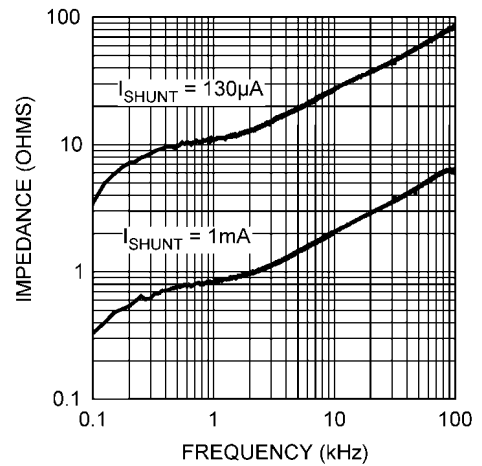

30046341

Typical Performance Characteristics

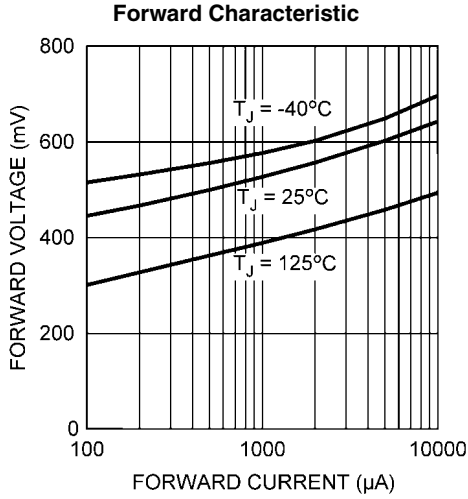

30046311

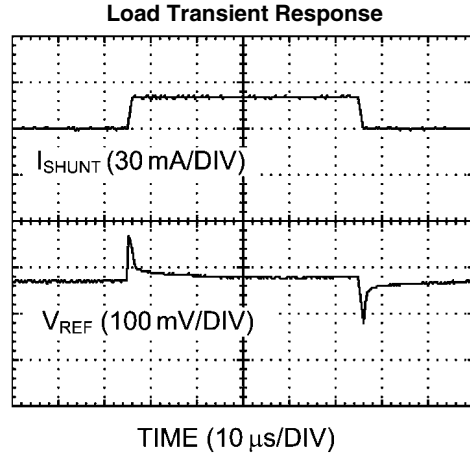

30046313

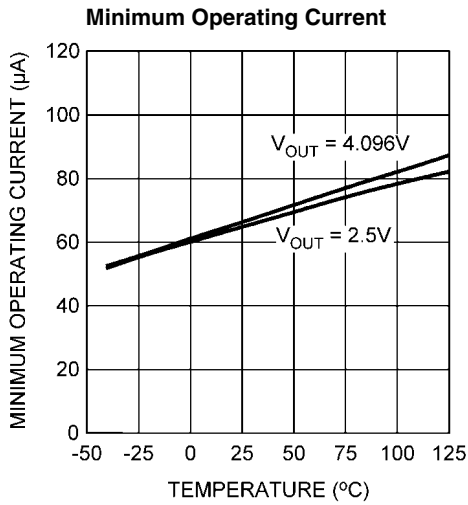

30046316

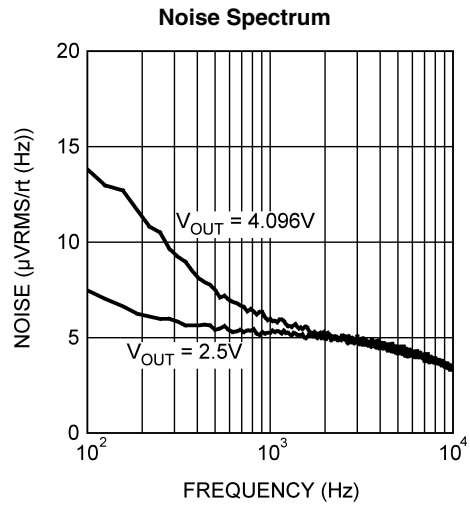

30046317

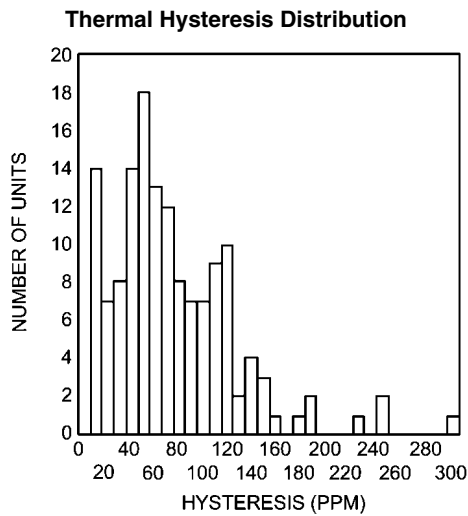

30046330

Output Voltage vs Thermal Cycle (-40°C to 125°C)

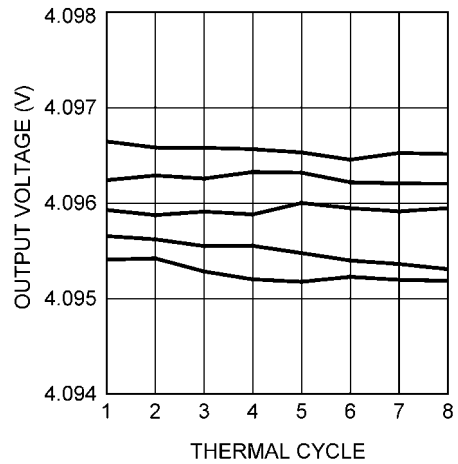

30046351

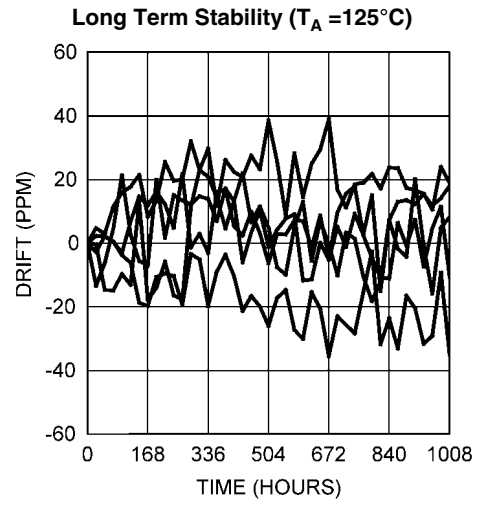
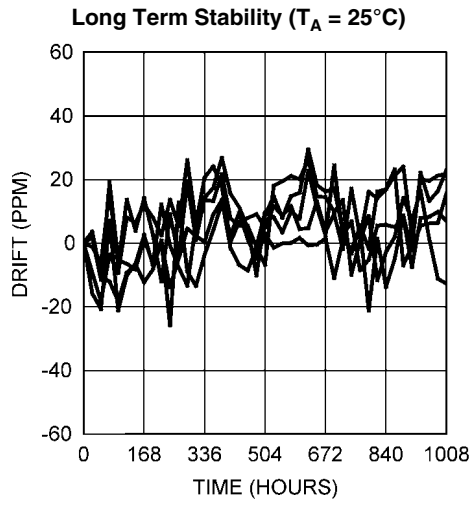

Application Information

THEORY OF OPERATION

The LM4030 is an ultra-high precision shunt voltage reference, having exceptionally high initial accuracy (0.05%) and temperature stability (10ppm/°C). The LM4030 is available with fixed voltage options of 2.5V and 4.096V. Despite the tiny SOT23 package, the LM4030 exhibits excellent thermal hysteresis (75ppm) and long-term stability (25ppm). The LM4030 is designed to operate without an external capacitor, but any capacitor up to 10 μ F may be used. The LM4030 can be powered off as little as 120 μ A (max) but is capable of shunting up to 30 mA continuously. The typical application circuit for the LM4030 is shown in *Figure 1*.

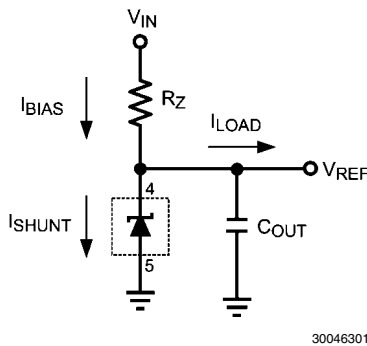

FIGURE 1. Typical Application Circuit

COMPONENT SELECTION

A resistor must be chosen to set the maximum operating current for the LM4030 (R_Z in *Figure 1*). The value of the resistor can be calculated using the following equation:

$$R_Z = (V_{IN} - V_{REF}) / (I_{MIN_OPERATING} + I_{LOAD_MAX})$$

R_Z is chosen such that the total current flowing through R_Z is greater than the maximum load current plus the minimum operating current of the reference itself. This ensures that the reference is never starved for current. Running the LM4030 at higher currents is advantageous for reducing noise. The reverse dynamic impedance of the V_{REF} node scales inversely with the shunted current (see *Figure 2*) leading to higher rejection of noise emanating from the input supply and from EMI (electro-magnetic interference).

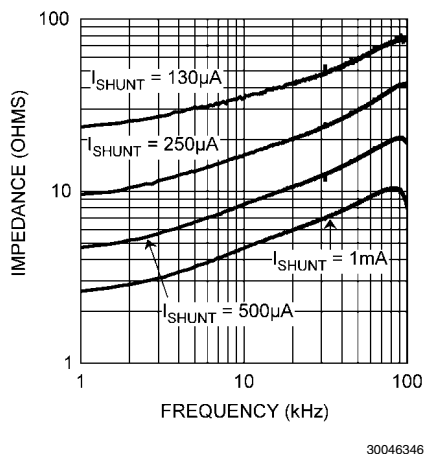

FIGURE 2. Reverse Dynamic Impedance vs I_{OUT}

The LM4030 is designed to operate with or without a bypass capacitor (C_{OUT} in *Figure 1*) and is stable with capacitors of up to 10 μ F. The use of a bypass capacitor can improve transient response and reduce broadband noise. Additionally, a bypass capacitor will counter the rising reverse dynamic impedance at higher frequencies improving noise immunity (see *Figure 3*).

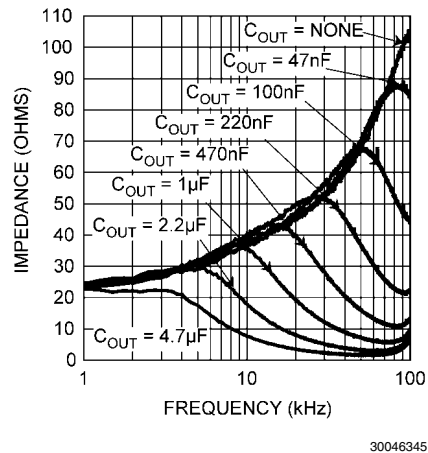

FIGURE 3. Reverse Dynamic Impedance vs C_{OUT}

As with other regulators, an external capacitor reduces the amplitude of the V_{REF} transient when a sudden change in loading takes place. The capacitor should be placed as close to the part as possible to reduce the effects of unwanted board parasitics.

THERMAL HYSTERESIS

Thermal hysteresis is defined as the change in output voltage at 25°C after some deviation from 25°C. This is to say that thermal hysteresis is the difference in output voltage between two points in a given temperature profile. An illustrative temperature profile is shown in *Figure 4*.

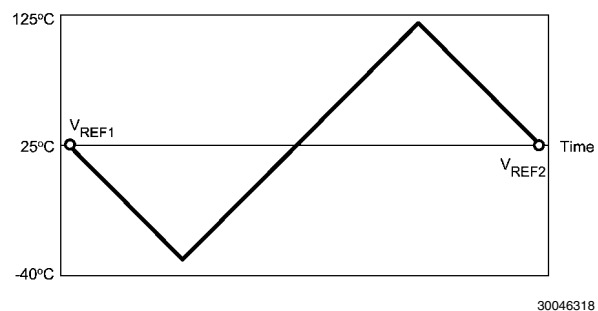

FIGURE 4. Illustrative Temperature Profile

This may be expressed analytically as the following:

$$V_{HYS} = \frac{V_{REF1} - V_{REF2}}{V_{REF}} \times 10^6 \text{ ppm}$$

Where

V_{HYS} = Thermal hysteresis expressed in ppm

V_{REF} = Nominal preset output voltage

V_{REF1} = V_{REF} before temperature fluctuation

$V_{REF2} = V_{REF}$ after temperature fluctuation.

The LM4030 features a low thermal hysteresis of 75 ppm (typical) from -40°C to 125°C after 8 temperature cycles.

TEMPERATURE COEFFICIENT

Temperature drift is defined as the maximum deviation in output voltage over the temperature range. This deviation over temperature may be illustrated as shown in *Figure 5*.

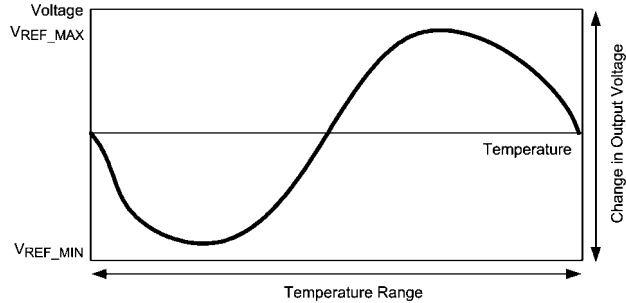

30046320

FIGURE 5. Illustrative V_{REF} vs Temperature Profile

Temperature coefficient may be expressed analytically as the following:

$$T_D = \frac{(V_{REF_MAX} - V_{REF_MIN})}{V_{REF} \times \Delta T} \times 10^6 \text{ ppm}$$

T_D = Temperature drift

V_{REF} = Nominal preset output voltage

V_{REF_MIN} = Minimum output voltage over operating temperature range

V_{REF_MAX} = Maximum output voltage over operating temperature range

ΔT = Operating temperature range.

The LM4030 features a low temperature drift of 10ppm (max) to 30ppm (max), depending on the grade.

DYNAMIC OFFSET CANCELLATION AND LONG TERM STABILITY

Aside from initial accuracy and drift performance, other specifications such as thermal hysteresis and long-term stability can affect the accuracy of a voltage reference, especially over the lifetime of the application. The reference voltage can also shift due to board stress once the part is mounted onto the PCB and during subsequent thermal cycles. Generally, these

shifts in V_{REF} arise due to offsets between matched devices within the regulation loop. Both passive and active devices naturally experience drift over time and stress and temperature gradients across the silicon die also generate offset. The LM4030 incorporates a dynamic offset cancellation scheme which compensates for offsets developing within the regulation loop. This gives the LM4030 excellent long-term stability (40 ppm typical) and thermal hysteresis performance (75ppm typical), as well as substantial immunity to PCB stress effects, despite being packaged in a tiny SOT23.

EXPRESSION OF ELECTRICAL CHARACTERISTICS

Electrical characteristics are typically expressed in mV, ppm, or a percentage of the nominal value. Depending on the application, one expression may be more useful than the other. To convert one quantity to the other one may apply the following:

ppm to mV error in output voltage:

$$\frac{V_{REF} \times \text{ppm}_{ERROR}}{10^3} = V_{ERROR}$$

Where:

V_{REF} is in volts (V) and V_{ERROR} is in milli-volts (mV).

Bit error (1 bit) to voltage error (mV):

$$\frac{V_{REF}}{2^n} \times 10^3 = V_{ERROR}$$

V_{REF} is in volts (V), V_{ERROR} is in milli-volts (mV), and n is the number of bits.

mV to ppm error in output voltage:

$$\frac{V_{ERROR}}{V_{REF}} \times 10^3 = \text{ppm}_{ERROR}$$

Where:

V_{REF} is in volts (V) and V_{ERROR} is in milli-volts (mV).

Voltage error (mV) to percentage error (percent):

$$\frac{V_{ERROR}}{V_{REF}} \times 0.1 = \text{Percent_Error}$$

Where:

V_{REF} is in volts (V) and V_{ERROR} is in milli-volts (mV).

**PRINTED CIRCUIT BOARD and LAYOUT
CONSIDERATIONS**

The LM4030 has a very small change in reverse voltage with current (25ppm/mA typical) so large variations in load current (up to 50mA) should not appreciably shift VREF. Parasitic resistance between the LM4030 and the load introduces a

voltage drop proportional to load current and should be minimized. The LM4030 should be placed as close to the load it is driving as the layout will allow. The location of R_Z is not important, but C_{OUT} should be as close to the LM4030 as possible so added ESR does not degrade the transient performance.

Physical Dimensions inches (millimeters) unless otherwise noted

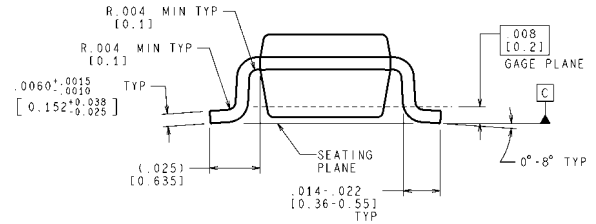
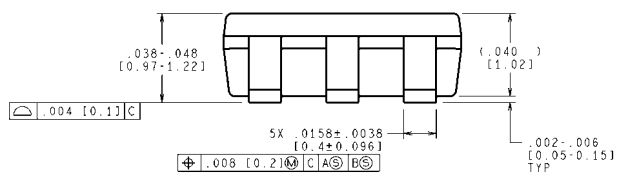
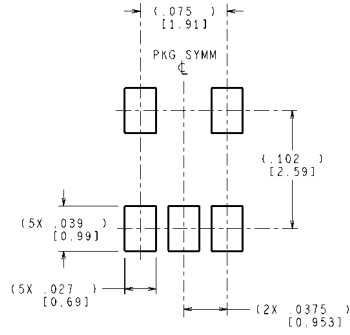
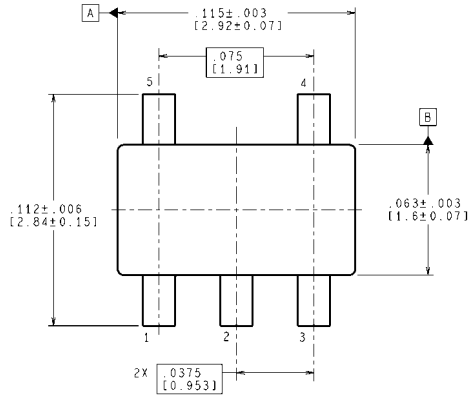

CONTROLLING DIMENSION IS INCH
 VALUES IN [] ARE MILLIMETERS
 DIMENSIONS IN () FOR REFERENCE ONLY

SOT23-5 Package
NS Package Number MF05A

MF05A (Rev C)

Notes

LM4030

Notes

For more National Semiconductor product information and proven design tools, visit the following Web sites at:

Products		Design Support	
Amplifiers	www.national.com/amplifiers	WEBENCH	www.national.com/webench
Audio	www.national.com/audio	Analog University	www.national.com/AU
Clock Conditioners	www.national.com/timing	App Notes	www.national.com/appnotes
Data Converters	www.national.com/adc	Distributors	www.national.com/contacts
Displays	www.national.com/displays	Green Compliance	www.national.com/quality/green
Ethernet	www.national.com/ethernet	Packaging	www.national.com/packaging
Interface	www.national.com/interface	Quality and Reliability	www.national.com/quality
LVDS	www.national.com/lvds	Reference Designs	www.national.com/refdesigns
Power Management	www.national.com/power	Feedback	www.national.com/feedback
Switching Regulators	www.national.com/switchers		
LDOs	www.national.com/lido		
LED Lighting	www.national.com/led		
PowerWise	www.national.com/powerwise		
Serial Digital Interface (SDI)	www.national.com/sdi		
Temperature Sensors	www.national.com/tempsensors		
Wireless (PLL/VCO)	www.national.com/wireless		

THE CONTENTS OF THIS DOCUMENT ARE PROVIDED IN CONNECTION WITH NATIONAL SEMICONDUCTOR CORPORATION ("NATIONAL") PRODUCTS. NATIONAL MAKES NO REPRESENTATIONS OR WARRANTIES WITH RESPECT TO THE ACCURACY OR COMPLETENESS OF THE CONTENTS OF THIS PUBLICATION AND RESERVES THE RIGHT TO MAKE CHANGES TO SPECIFICATIONS AND PRODUCT DESCRIPTIONS AT ANY TIME WITHOUT NOTICE. NO LICENSE, WHETHER EXPRESS, IMPLIED, ARISING BY ESTOPPEL OR OTHERWISE, TO ANY INTELLECTUAL PROPERTY RIGHTS IS GRANTED BY THIS DOCUMENT.

TESTING AND OTHER QUALITY CONTROLS ARE USED TO THE EXTENT NATIONAL DEEMS NECESSARY TO SUPPORT NATIONAL'S PRODUCT WARRANTY. EXCEPT WHERE MANDATED BY GOVERNMENT REQUIREMENTS, TESTING OF ALL PARAMETERS OF EACH PRODUCT IS NOT NECESSARILY PERFORMED. NATIONAL ASSUMES NO LIABILITY FOR APPLICATIONS ASSISTANCE OR BUYER PRODUCT DESIGN. BUYERS ARE RESPONSIBLE FOR THEIR PRODUCTS AND APPLICATIONS USING NATIONAL COMPONENTS. PRIOR TO USING OR DISTRIBUTING ANY PRODUCTS THAT INCLUDE NATIONAL COMPONENTS, BUYERS SHOULD PROVIDE ADEQUATE DESIGN, TESTING AND OPERATING SAFEGUARDS.

EXCEPT AS PROVIDED IN NATIONAL'S TERMS AND CONDITIONS OF SALE FOR SUCH PRODUCTS, NATIONAL ASSUMES NO LIABILITY WHATSOEVER, AND NATIONAL DISCLAIMS ANY EXPRESS OR IMPLIED WARRANTY RELATING TO THE SALE AND/OR USE OF NATIONAL PRODUCTS INCLUDING LIABILITY OR WARRANTIES RELATING TO FITNESS FOR A PARTICULAR PURPOSE, MERCHANTABILITY, OR INFRINGEMENT OF ANY PATENT, COPYRIGHT OR OTHER INTELLECTUAL PROPERTY RIGHT.

LIFE SUPPORT POLICY

NATIONAL'S PRODUCTS ARE NOT AUTHORIZED FOR USE AS CRITICAL COMPONENTS IN LIFE SUPPORT DEVICES OR SYSTEMS WITHOUT THE EXPRESS PRIOR WRITTEN APPROVAL OF THE CHIEF EXECUTIVE OFFICER AND GENERAL COUNSEL OF NATIONAL SEMICONDUCTOR CORPORATION. As used herein:

Life support devices or systems are devices which (a) are intended for surgical implant into the body, or (b) support or sustain life and whose failure to perform when properly used in accordance with instructions for use provided in the labeling can be reasonably expected to result in a significant injury to the user. A critical component is any component in a life support device or system whose failure to perform can be reasonably expected to cause the failure of the life support device or system or to affect its safety or effectiveness.

National Semiconductor and the National Semiconductor logo are registered trademarks of National Semiconductor Corporation. All other brand or product names may be trademarks or registered trademarks of their respective holders.

Copyright© 2008 National Semiconductor Corporation

For the most current product information visit us at www.national.com



National Semiconductor Americas Technical Support Center
Email: support@nsc.com
Tel: 1-800-272-9959

National Semiconductor Europe Technical Support Center
Email: europe.support@nsc.com
German Tel: +49 (0) 180 5010 771
English Tel: +44 (0) 870 850 4288

National Semiconductor Asia Pacific Technical Support Center
Email: ap.support@nsc.com

National Semiconductor Japan Technical Support Center
Email: jpn.feedback@nsc.com