

# Micropower, 400mV Reference with Rail-to-Rail Buffer Amplifier in SOT-23

## FEATURES

- Low Quiescent Current 5.6 $\mu$ A (typical)
- Wide Supply Range: 1.4V to 18V
- 400mV Reference  $\pm$ 1% Maximum Accuracy Over Temperature at 5V
- Rail-to-Rail Buffer Amplifier
- 0.5% 400mV Maximum Initial Accuracy at 5V
- Shunt Configurable
- Sinks and Sources Current
- Wide Operational Range  $-40^{\circ}\text{C}$  to  $125^{\circ}\text{C}$
- Externally Adjustable Output Voltage
- Low Profile 1mm 5-lead SOT-23 (ThinSOT™) Package

## APPLICATIONS

- Battery-Operated Systems
- Handheld Instruments
- Industrial Control Systems
- Data Acquisition Systems
- Negative Voltage References

## DESCRIPTION

The LT<sup>®</sup>6650 is a micropower, low voltage 400mV reference. Operating with supplies from 1.4V up to 18V, the device draws only 5.6 $\mu$ A typical, making it ideal for low voltage systems as well as handheld instruments and industrial control systems. With only two resistors the internal buffer amplifier can scale the 400mV reference to any desired value up to the supply voltage.

The reference is postpackage-trimmed to increase the output accuracy. The output can sink and source 200 $\mu$ A over temperature. Quiescent power dissipation is 28 $\mu$ W. Stability is ensured with any output capacitor of 1 $\mu$ F or higher.

The LT6650 is the lowest voltage series reference available in the 5-lead SOT-23 package.

LT, LTC and LT are registered trademarks of Linear Technology Corporation. ThinSOT is a trademark of Linear Technology Corporation. All other trademarks are the property of their respective owners.

## TYPICAL APPLICATION

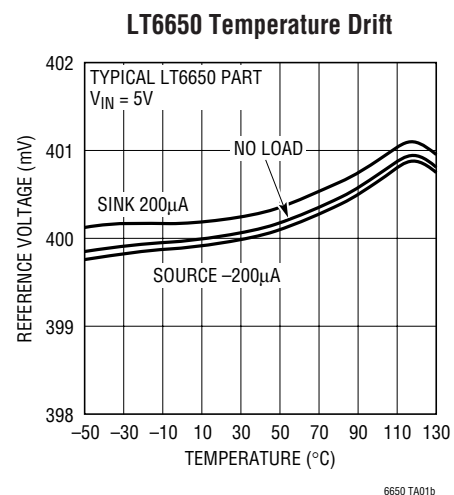
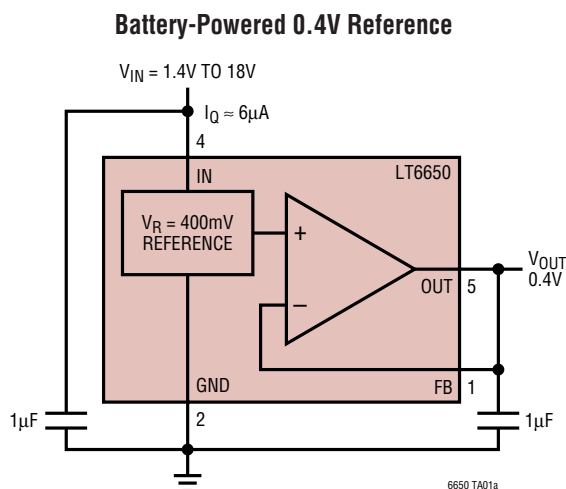

## ABSOLUTE MAXIMUM RATINGS

(Note 1)

Total Supply Voltage ( $V_{IN}$ to GND) .....	20V
FB Voltage (Note 2) .....	20V to (GND – 0.3V)
Output Voltage (OUT) .....	20V to (GND – 0.3V)
Output Short-Circuit Duration .....	Indefinite
FB Input Current .....	10mA
Operating Temperature Range .....	–40°C to 125°C
Specified Temperature Range	
LT6650CS5 .....	0°C to 70°C
LT6650IS5 .....	–40°C to 85°C
LT6650HS5 (Note 3) .....	–40°C to 125°C
Maximum Junction Temperature .....	150°C
Storage Temperature Range (Note 4) ....	–65°C to 150°C
Lead Temperature (Soldering, 10 sec) .....	300°C

## PACKAGE/ORDER INFORMATION

TOP VIEW

S5 PACKAGE  
5-LEAD PLASTIC TSOT-23  
 $T_{JMAX} = 150^{\circ}\text{C}$ ,  $\theta_{JA} = 230^{\circ}\text{C/W}$

\*Do Not Connect

ORDER PART NUMBER	S5 PART MARKING
LT6650CS5	LBDV
LT6650IS5	LBDV
LT6650HS5	LBDV

**Order Options** Tape and Reel: Add #TR  
Lead Free: Add #PBF Lead Free Tape and Reel: Add #TRPBF  
Lead Free Part Marking: <http://www.linear.com/leadfree/>

The temperature grades are identified by a label on the shipping container. Consult LTC Marketing for parts specified with wider operating temperature ranges.

## ELECTRICAL CHARACTERISTICS

The ● denotes the specifications which apply over the full operating temperature range, otherwise specifications are at  $T_A = 25^{\circ}\text{C}$ .  $V_{IN} = 5\text{V}$ ,  $C_{IN} = 1\mu\text{F}$ ,  $\text{FB} = \text{OUT}$ , no DC load,  $C_L = 1\mu\text{F}$ , unless otherwise noted.

SYMBOL	PARAMETER	CONDITIONS	MIN	TYP	MAX	UNITS
$V_{OUT}$	Output Voltage (Notes 4, 5)	LT6650	398 –0.5	400	402 0.5	mV %
		LT6650CS5	● ●	397 –0.75	400 0.75	mV %
		LT6650IS5	● ●	396 –1	400 1	mV %
		LT6650HS5	● ●	394 –1.5	400 1.5	mV %
$V_{IN}$	Operating Input Voltage		1.4		18	V
$\Delta V_{OUT}/\Delta V_{IN}$	Line Regulation	$1.4\text{V} \leq V_{IN} \leq 18\text{V}$		1 150	6 900	mV ppm/V
		LT6650CS5, LT6650IS5	● ●		7.5 1130	mV ppm/V
		LT6650HS5	● ●		8.5 1280	mV ppm/V
$\Delta V_{OUT}/\Delta I_{OUT}$	Load Regulation (Note 6)	Sourcing from $0\mu\text{A}$ to $-200\mu\text{A}$		–0.04 500	–0.2 2500	mV ppm/mA
		Sinking from $0\mu\text{A}$ to $200\mu\text{A}$	● ●		–0.4 5000	mV ppm/mA
				0.24 3000	1 12500	mV ppm/mA
					2 20000	mV ppm/mA

**ELECTRICAL CHARACTERISTICS** The ● denotes the specifications which apply over the full operating temperature range, otherwise specifications are at  $T_A = 25^\circ\text{C}$ .  $V_{IN} = 5\text{V}$ ,  $C_{IN} = 1\mu\text{F}$ ,  $\text{FB} = \text{OUT}$ , no DC load,  $C_L = 1\mu\text{F}$ , unless otherwise noted.

SYMBOL	PARAMETER	CONDITIONS	MIN	TYP	MAX	UNITS
$T_C$	Output Voltage Temperature Coefficient (Note 10)		●	30		ppm/ $^\circ\text{C}$
$\Delta V_{DO}$	Dropout Voltage (Note 7)	Referred to $V_{IN} = 1.8\text{V}$ , $V_{OUT} = 1.4\text{V}$ ( $R_F = 100\text{k}$ , $R_G = 39.2\text{k}$ ) $\Delta V_{OUT} = -0.1\%$ , $I_{OUT} = 0\mu\text{A}$	●	75	100 150	mV mV
		$\Delta V_{OUT} = -0.1\%$ , $I_{OUT} = -200\mu\text{A}$ Sourcing	●	165	250 350	mV mV
		$\Delta V_{OUT} = -0.1\%$ , $I_{OUT} = 200\mu\text{A}$ Sinking (Note 11)	●	-300	-150 0	mV mV
$I_{SC}$	Short-Circuit Output Current	$V_{OUT}$ Shorted to GND		5		mA
		$V_{OUT}$ Shorted to $V_{IN}$		9		mA
$I_{IN}$	Supply Current		●	5.6	11 14	$\mu\text{A}$ $\mu\text{A}$
		$V_{IN} = 18\text{V}$	●	5.9	12 15	$\mu\text{A}$ $\mu\text{A}$
$I_{FB}$	FB Pin Input Current	$V_{FB} = V_{OUT} = 400\text{mV}$		1.2	10	nA
		LT6650CS5, LT6650IS5	●		15	nA
		LT6650HS5	●		30	nA
$T_{ON}$	Turn-On Time	$C_{LOAD} = 1\mu\text{F}$		0.5		ms
$e_n$	Output Noise (Note 8)	$0.1\text{Hz} \leq f \leq 10\text{Hz}$		20		$\mu\text{V}_{P-P}$
		$10\text{Hz} \leq f \leq 1\text{kHz}$ , $I_{OUT} = -200\mu\text{A}$ Sourcing		23		$\mu\text{V}_{RMS}$
$V_{HYS}$	Hysteresis (Note 9)	$\Delta T = 0^\circ\text{C}$ to $70^\circ\text{C}$	●	0.1		mV
			●	250		ppm
		$\Delta T = -40^\circ\text{C}$ to $85^\circ\text{C}$	●	0.24		mV
			●	600		ppm

**Note 1:** Absolute Maximum Ratings are those values beyond which the life of a device may be impaired.

**Note 2:** The FB pin is protected by an ESD diode to the ground. If the FB input voltage exceeds  $-0.3\text{V}$  below ground, the FB input current should be limited to less than  $10\text{mA}$ . If the FB input voltage is greater than  $5\text{V}$ , the FB input current is expected to meet specified performance from Typical Performance Characteristics but is not tested or QA sampled at this voltage.

**Note 3:** If the part is operating at temperatures above  $85^\circ\text{C}$ , it is recommended to enhance the stability margin by using an output capacitor greater than  $10\mu\text{F}$  or a series RC combination having a  $100\mu\text{s}$  equivalent time constant. See Application section for details.

**Note 4:** If the part is stored outside of the specified temperature range, the output voltage may shift due to hysteresis.

**Note 5:** ESD (Electrostatic Discharge) sensitive devices. Extensive use of ESD protection devices are used internal to the LT6650; however, high electrostatic discharge can damage or degrade the device. Use proper ESD handling precautions.

**Note 6:** Load regulation is measured on a pulse basis from no load to the specified load current. Output changes due to die temperature change must be taken into account separately.

**Note 7:** Dropout Voltage is  $(V_{IN} - V_{OUT})$  when  $V_{OUT}$  falls to  $0.1\%$  below its nominal value at  $V_{IN} = 1.8\text{V}$ .

**Note 8:** Peak-to-Peak noise is measured with a single pole highpass filter at  $0.1\text{Hz}$  and a 2-pole lowpass filter at  $10\text{Hz}$ . The unit is enclosed in a still air environment to eliminate thermocouple effects on the leads. The test time is 10 seconds.

**Note 9:** Hysteresis in the output voltage is created by package stress that differs depending on whether the IC was previously at a higher or lower temperature. Output voltage is always measured at  $25^\circ\text{C}$ , but the IC is cycled to  $85^\circ\text{C}$  or  $-40^\circ\text{C}$  before a successive measurement. Hysteresis is roughly proportional to the square of the temperature change.

**Note 10:** Temperature coefficient is measured by dividing the change in output voltage by the specified temperature range.

**Note 11:** This feature guarantees the shunt mode operation of the device.

**TYPICAL PERFORMANCE CHARACTERISTICS** (See Applications, Figure 1)

**Output Voltage Temperature Drift**

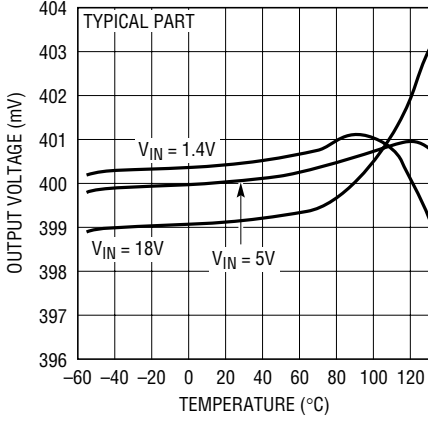

6650 G01

**Output Voltage Temperature Drift**

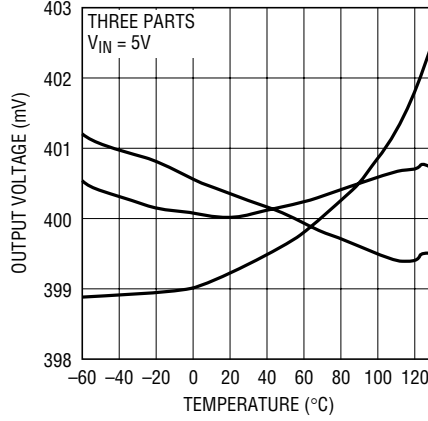

6650 G02

**Supply Current vs Input Voltage**

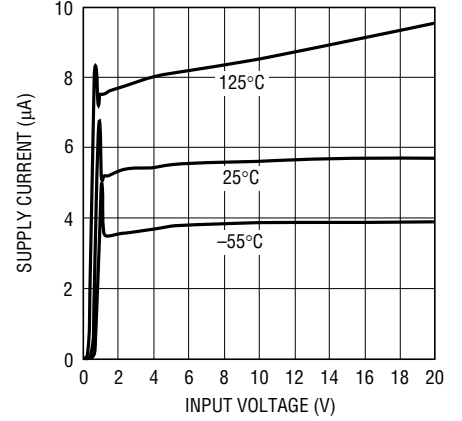

6650 G03

**Supply Current vs Input Voltage**

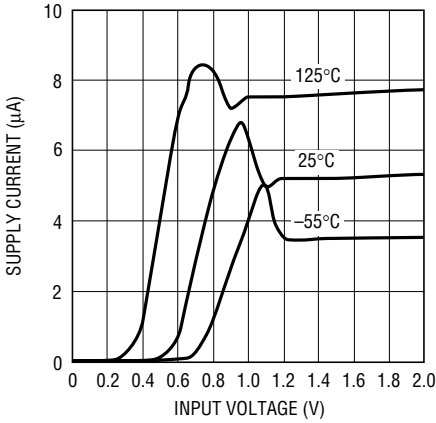

6650 G04

**Line Regulation**

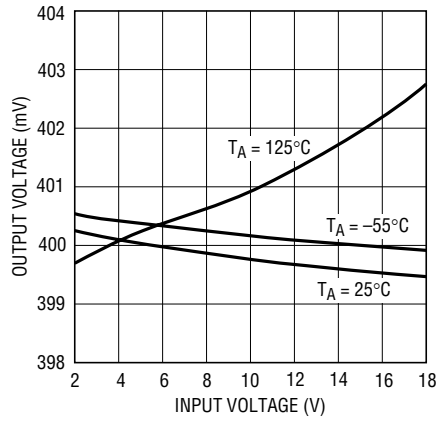

6650 G05

**Line Regulation**

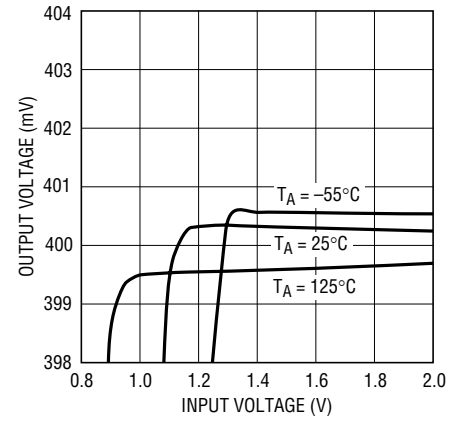

6650 G06

**Load Regulation (Sourcing)**

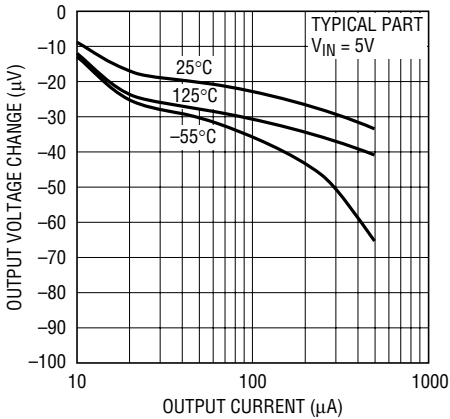

6650 G07

**Load Regulation (Sinking)**

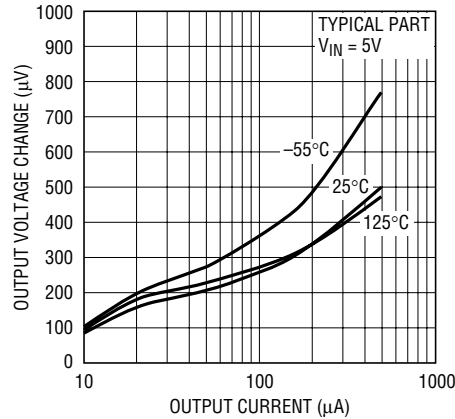

6650 G08

**Minimum Input-Output Voltage Differential (Sourcing)**

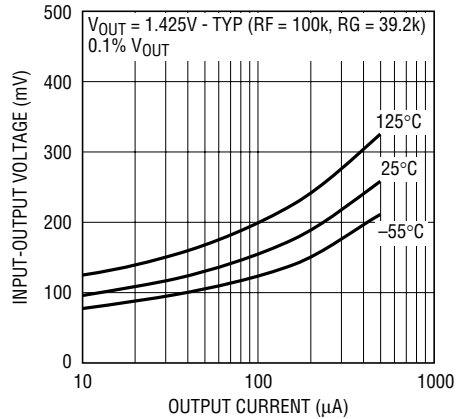

6650 G09

# TYPICAL PERFORMANCE CHARACTERISTICS (See Applications, Figure 1)

**Minimum Input-Output Voltage Differential (Sinking)**

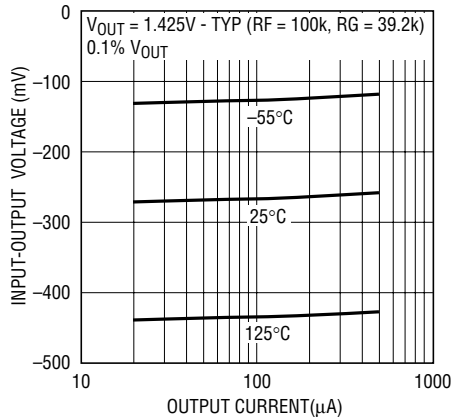

6650 G10

**Output Short-Circuit Current vs Input Voltage**

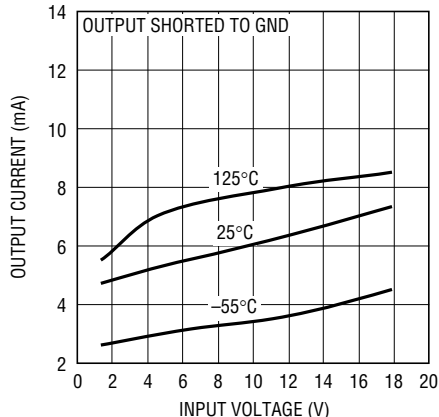

6650 G11

**Output Short-Circuit Current vs Input Voltage**

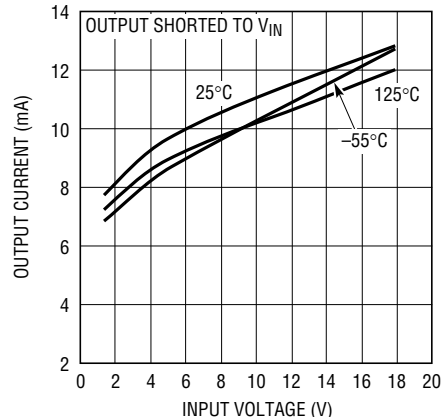

6650 G12

**FB Pin Current vs FB Pin Voltage**

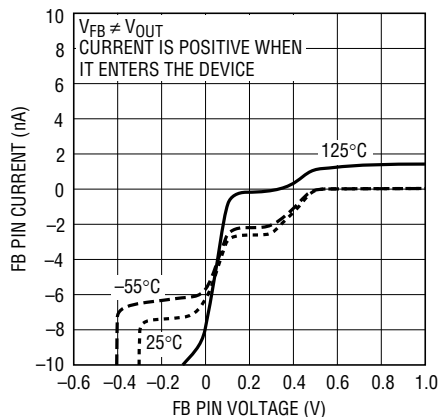

6650 G13

**FB Pin Current vs FB Pin Voltage**

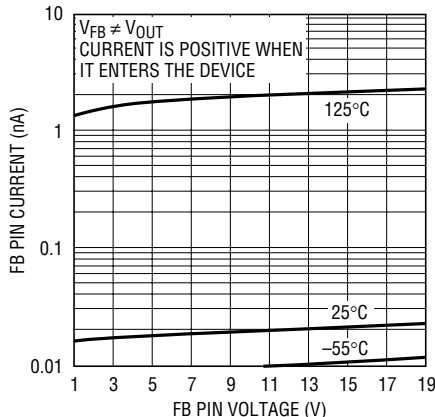

6650 G14

**Gain and Phase vs Frequency**

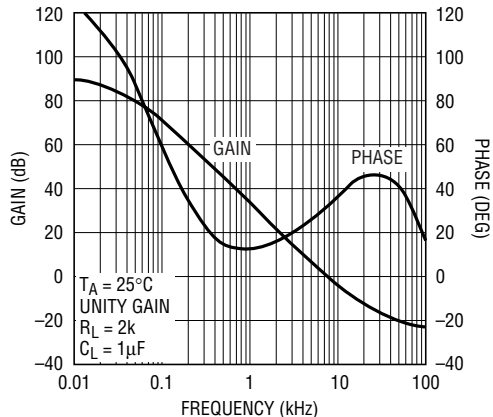

6650 G15

**Output Noise 0.1Hz to 10Hz**

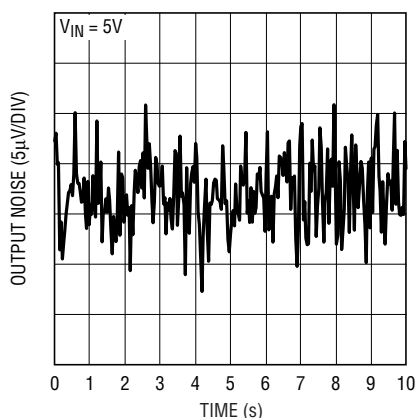

6650 G16

**Output Voltage Noise Spectrum**

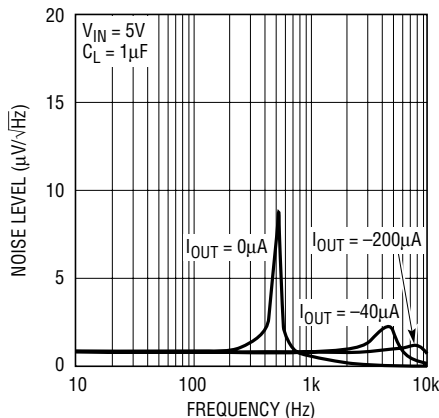

6650 G17

**Integrated Noise 10Hz to 1kHz**

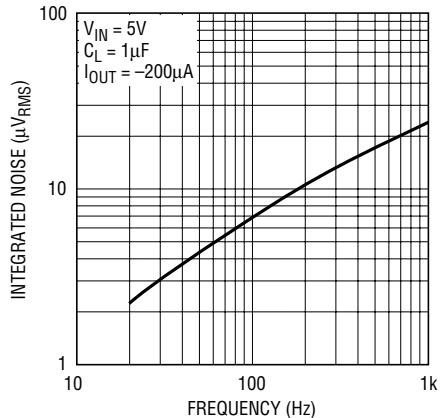

6650 G18

**TYPICAL PERFORMANCE CHARACTERISTICS** (See Applications, Figure 1)

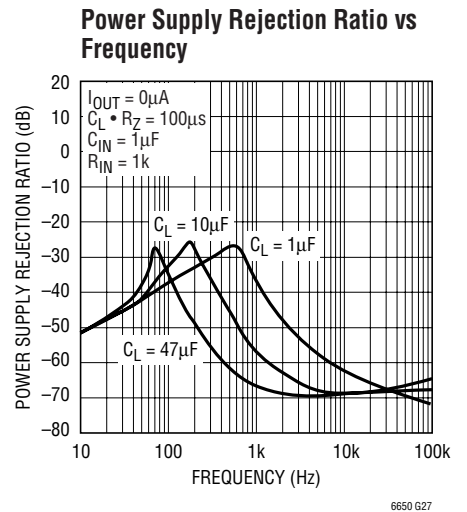
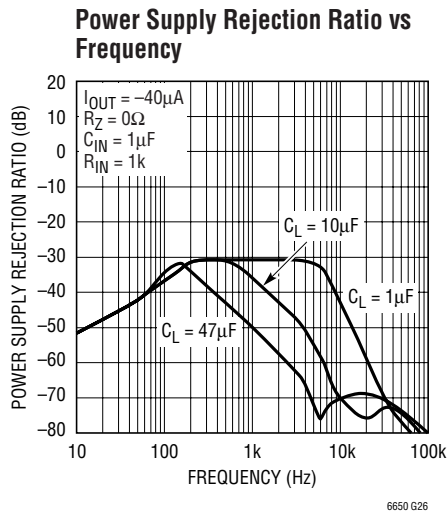
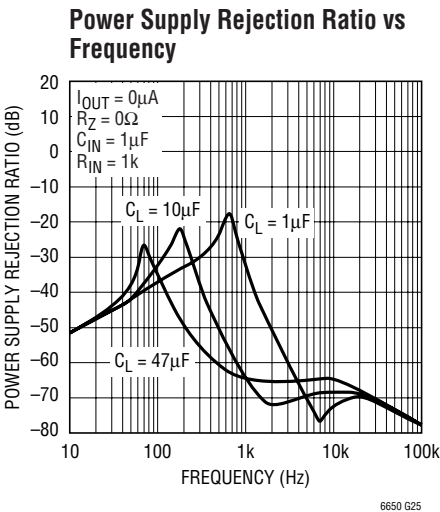
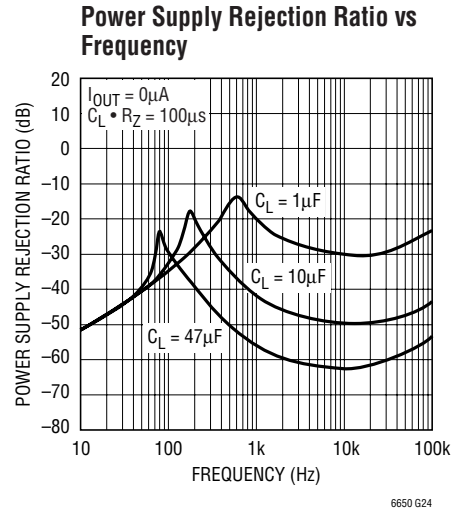
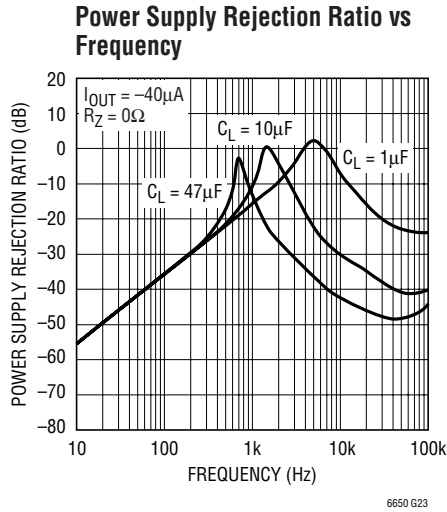
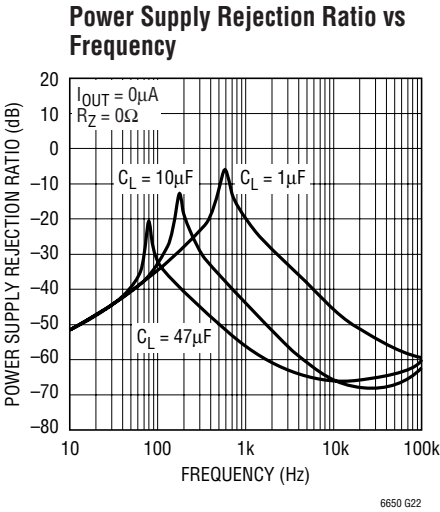
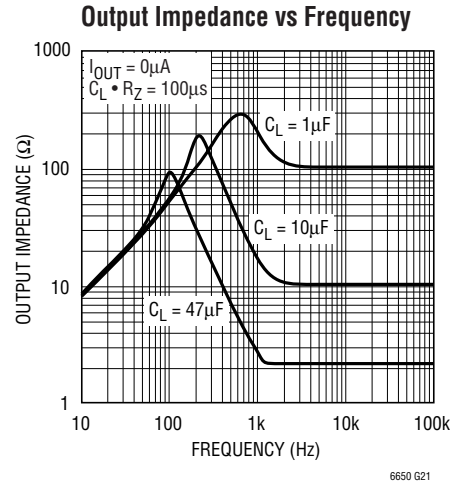
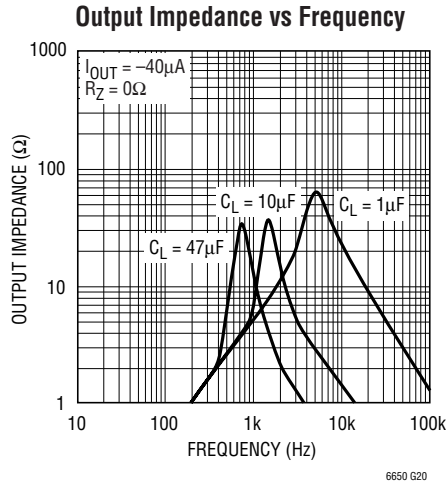
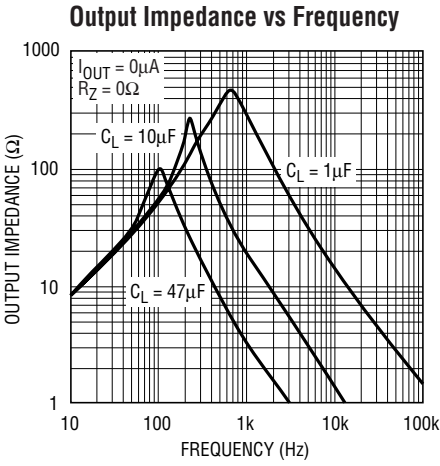

## PIN FUNCTIONS

**FB (Pin 1):** Resistor Divider Feedback Pin. Connect a resistor divider from OUT to GND and the center tap to FB. This pin sets the output potential.

**GND (Pin 2):** Ground Connection.

**DNC (Pin 3):** Do not connect. Connected internally for post package trim. This pin must be left unconnected.

**IN (Pin 4):** Positive Supply. Bypassing with a  $1\mu\text{F}$  capacitor is recommended if the output loading changes.

**OUT (Pin 5):** Reference Output. The output sources and sinks current. It is stable with any load capacitor with a total capacitance of  $1\mu\text{F}$  or more. Higher load capacitance improves load transient response.

## BLOCK DIAGRAM

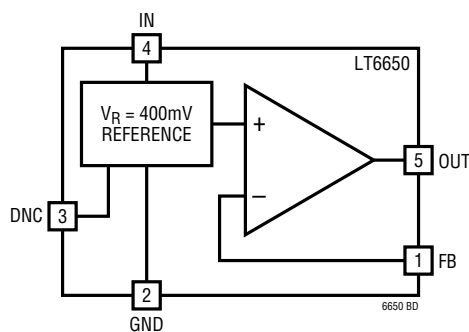

## APPLICATIONS INFORMATION

### Long Battery Life

The LT6650 is a micropower, adjustable reference which operates from supply voltages ranging from 1.4V to 18V. The series regulated output may be configured with external resistors to any voltage from 400mV to nearly the supply potential. Under no-load conditions, the LT6650 dissipates only  $8\mu\text{W}$  when operating on a 1.4V supply. Other operating configurations allow the LT6650 to be used as a micropower positive or negative adjustable shunt reference from 1.4V to 18V.

### Bypass and Load Capacitor

The LT6650 voltage reference requires a  $1\mu\text{F}$  or greater output capacitance for proper operation. This capacitance may be provided by either a single capacitor connected between OUT and GND or formed by the aggregate of several capacitors that may be serving other decoupling

functions. Output impedance can be reduced by DC loading of the output by  $40\mu\text{A}$  to  $200\mu\text{A}$ , and/or adding an  $R_Z$  to the output capacitor for a  $100\mu\text{s}$  time constant as shown in Figure 1 and the Typical Performance Characteristics graphs.

The LT6650 Voltage reference should have an input bypass capacitor of  $0.1\mu\text{F}$  or larger. When the circuit is

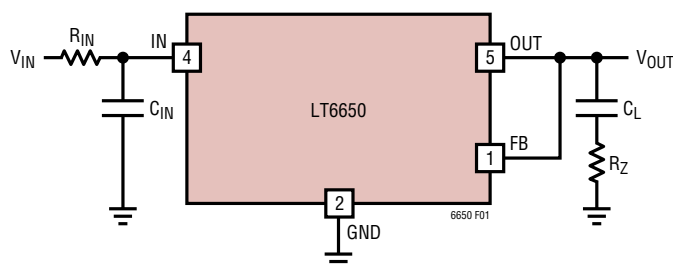

Figure 1. LT6650 Input-Output Configuration

## APPLICATIONS INFORMATION

operated from a small battery or other relatively high impedance source, a minimum  $1\mu\text{F}$  capacitor is recommended. PSRR can be significantly enhanced by adding a low-pass RC filter on the input, with a time-constant of 1ms or higher, as shown in Figure 1. The Typical Performance Characteristics graphs show performance as a function of several combinations of input and output capacitance.

An input RC of 100ms or more is recommended (such as 5k and  $22\mu\text{F}$ ) when output transients must be minimized in the face of high supply noise, such as in automotive applications. Figure 2 shows an input filter structure that effectively eliminates supply transients from affecting the output. With this extra input decoupling and the LT6650 operating normally from a 12V bus, 50V transients induce less than  $<0.5\%$   $V_{\text{OUT}}$  perturbations.

Figure 3 shows the turn-on response time for the circuit in Figure 1. The input voltage steps from 0V to 3V, and the output is configured to produce 400mV. Input bypass and output load capacitance are  $1\mu\text{F}$ ,  $R_{\text{IN}} = 0\Omega$ ,  $R_{\text{Z}} = 0\Omega$ , and the output settles in approximately 0.5ms. Figure 4 shows

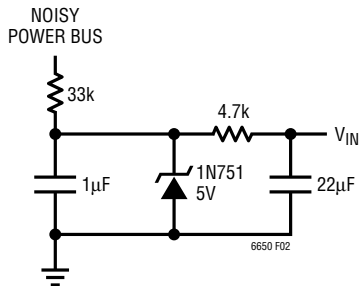

Figure 2. High Noise-Immunity Input Network

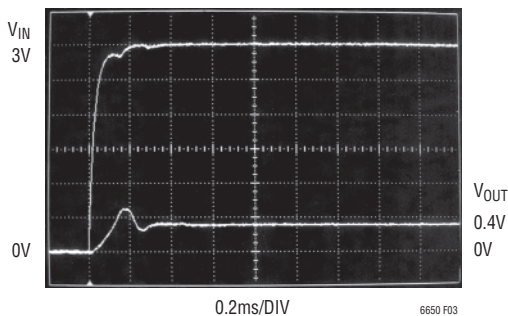

Figure 3. LT6650 Turn-On Characteristic

the same circuit responding to input transients of 0.5V, settling in about 0.3ms. Figures 5 through 7 show the same circuit responding to various load steps: changes between  $\pm 100\mu\text{A}$  in Figure 5; sourcing current step between  $-100\mu\text{A}$  and  $-200\mu\text{A}$  in Figure 6; and sinking current

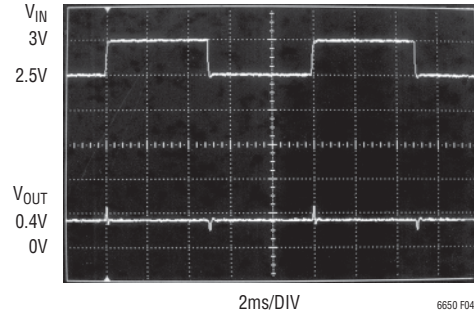

Figure 4. Output Response to  $\pm 0.5\text{V}$  Input Step

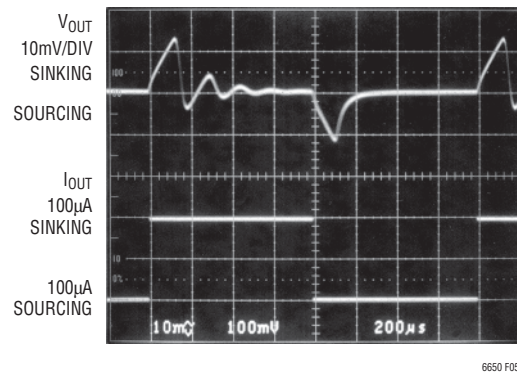

Figure 5. Output Response to Bidirectional Load Step ( $100\mu\text{A}$  to  $-100\mu\text{A}$ )

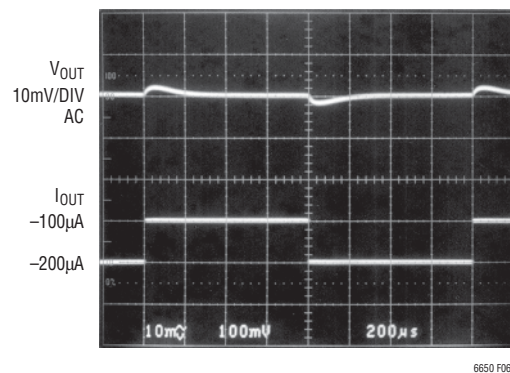

Figure 6. Output Response to Current-Sourcing Load Step ( $-100\mu\text{A}$  to  $-200\mu\text{A}$ )



## APPLICATIONS INFORMATION

step between 100µA and 200µA in Figure 7. Load step settling occurs in about 0.5ms or less (to ±0.2%).

### Output Adjustment

If the LT6650 is to be used as a 400mV reference, then the output and feedback pins may be tied together without any scale-setting components as shown in the front-page application circuit. Setting the output to any higher voltage is a simple matter of selecting two feedback resistors to configure the non-inverting gain of the internal operational amplifier, as shown in Figure 8. A feedback resistor  $R_F$  is connected between the OUT pin and the FB pin, and a gain resistor  $R_G$  is connected from the FB pin to GND. The resistor values are related to the output voltage by the following relationship:

$$R_F = R_G \cdot (V_{OUT} - 0.4) / (0.4 - I_{FB} \cdot R_G)$$

The  $I_{FB}$  term represents the FB pin bias current, and can generally be neglected when  $R_G$  is 100k or less. For  $R_G \leq 20k$ , even worst-case  $I_{FB}$  can be neglected (error

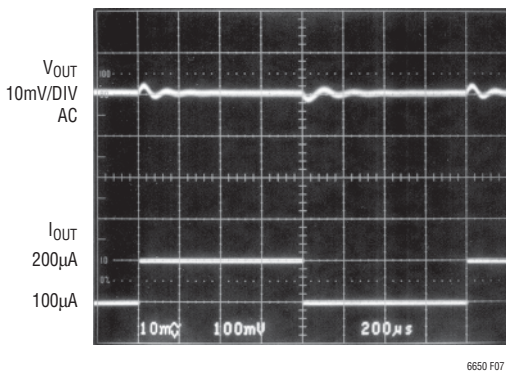

Figure 7. Output Response to Current-Sinking Load Step (100µA to 200µA)

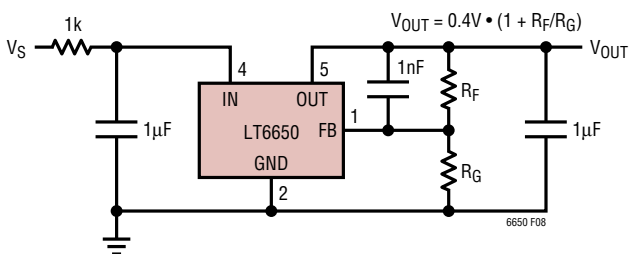

Figure 8. Typical Configuration for Output Voltages Greater than 0.4V

contribution <0.15%). Since the  $V_{OUT}$  error distribution increases at twice the resistor tolerance, high accuracy resistors or resistor networks are recommended. The output voltage may be set to any level from 400mV up to 350mV below the supply voltage with source or sink capability.

### Noise Reduction Capacitor

In applications involving the use of resistive feedback for reference scaling, the intrinsic reference noise is amplified along with the DC level. To minimize noise amplification, the use of a 1nF feedback capacitor is recommended, as shown in Figure 8 and other circuits with scaling resistors.

### Shunt Reference Operation

The circuits shown in Figure 9 and Figure 10 form adjustable shunt references. Along with the external bias resistor  $R_B$ , the LT6650 provides positive or negative reference operation for outputs between 1.4V and 18V (positive or negative). Just like a Zener diode, a supply  $V_S$  is required, somewhat higher in magnitude than the desired reference

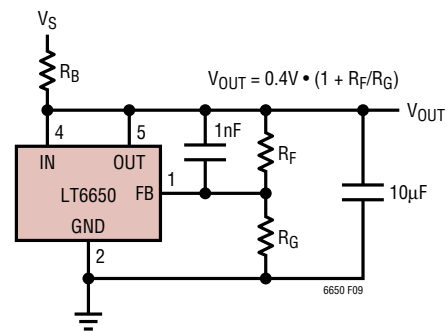

Figure 9. Typical Configuration of LT6650 as Adjustable Positive Shunt Reference

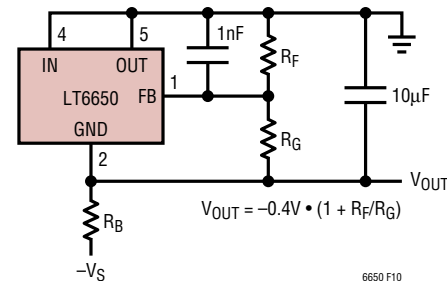

Figure 10. Typical Configuration of LT6650 as Adjustable Negative Shunt Reference

## APPLICATIONS INFORMATION

$V_{OUT}$ .  $R_B$  must be within the following range for proper operation (the optimal value depends greatly on the direction and magnitude of the load current):

$$R_B > |V_S - V_{OUT}| / (200\mu A + 0.4/R_G)$$

$$R_B < |V_S - V_{OUT}| / (15\mu A + 0.4/R_G)$$

### Hysteresis

Due to various mechanical stress mechanisms inherent to integrated-circuit packaging, internal offsets may not precisely recover from variations that occur over temperature, and this effect is referred to as hysteresis. Proprietary manufacturing steps minimize this hysteresis, though some small residual error can occur. Hysteresis measurements for the LT6650 can be seen in Figures 11 and 12. Figure 11 presents the worst-case data taken on parts subjected to thermal cycling between 0°C to 70°C, while Figure 12 shows data for -40°C to 85°C cycling. Units were cycled several times over these temperature ranges and the largest changes are shown. As would be expected,

the parts cycled over the higher temperature extremes exhibit a broader hysteresis distribution. The worst hysteresis measurements indicate voltage shifts of less than 1000ppm (0.1%) from their initial value.

### Limits of Operation

The LT6650 is a robust bipolar technology part. ESD clamp diodes are integrated into the design and are depicted in the Simplified Schematic for reference. Diodes are included between the GND pin and the IN, OUT, and FB pins to prevent reverse voltage stress on the device. Unusual modes of operation that forward-bias any these diodes should limit current to 10mA to avoid permanent damage to the device. The LT6650 is fabricated using a relatively high-voltage process, allowing any pin to independently operate at up to 20V with respect to GND. The part does not include any over voltage protection mechanisms; therefore caution should be exercised to avoid inadvertent application of higher voltages in circuits involving high potentials.

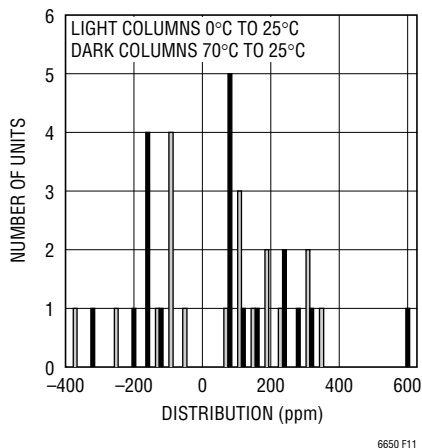

Figure 11. Worst-Case 0°C to 70°C Hysteresis

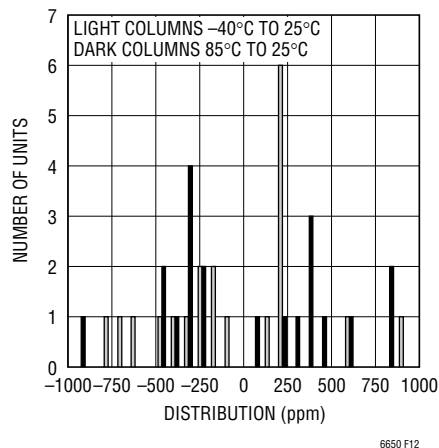
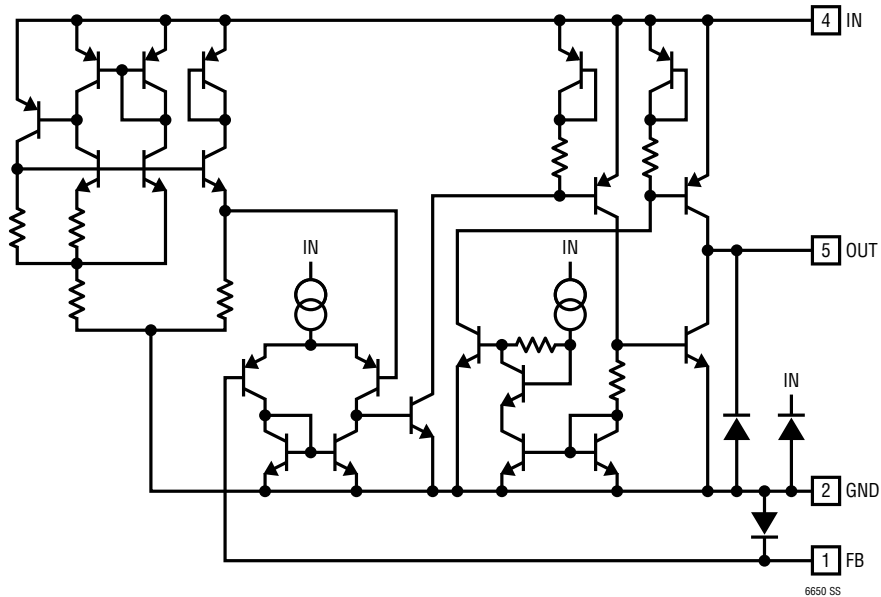

Figure 12. Worst-Case -40°C to 85°C Hysteresis

# SIMPLIFIED SCHEMATIC



# PACKAGE DESCRIPTION

**S5 Package**  
**5-Lead Plastic TSOT-23**  
 (Reference LTC DWG # 05-08-1635 Rev B)

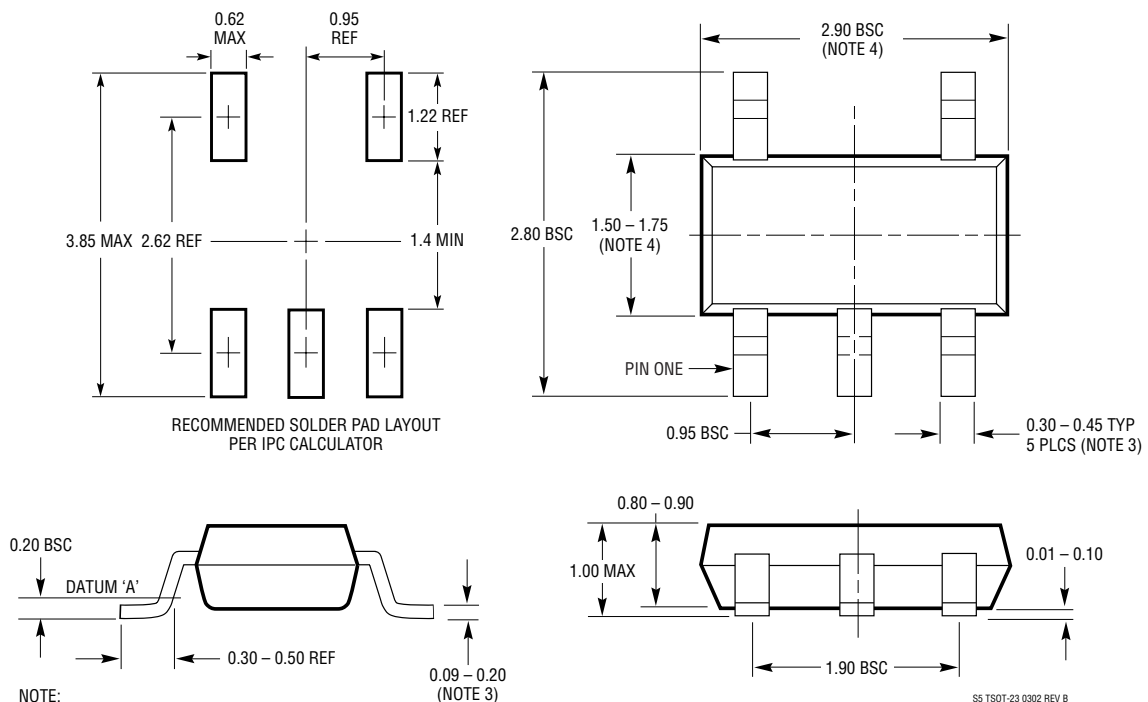

- NOTE:
1. DIMENSIONS ARE IN MILLIMETERS
  2. DRAWING NOT TO SCALE
  3. DIMENSIONS ARE INCLUSIVE OF PLATING
  4. DIMENSIONS ARE EXCLUSIVE OF MOLD FLASH AND METAL BURR
  5. MOLD FLASH SHALL NOT EXCEED 0.254mm
  6. JEDEC PACKAGE REFERENCE IS MO-193

**TYPICAL APPLICATION**

Adjustable Micropower “Zener” 2-Terminal Reference

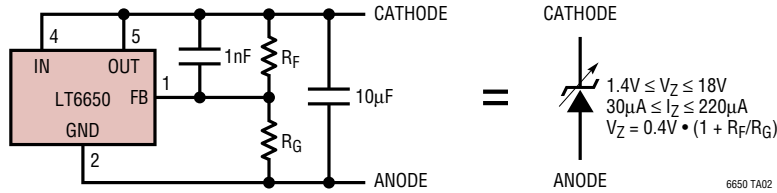

**RELATED PARTS**

PART NUMBER	DESCRIPTION	COMMENTS
LT1790	Micropower LDO Precision Reference	0.05% Max Sources/Sinks-Current Available in SOT-23
LT1460	Micropower Precision Reference	0.075% Max 10ppm/°C Available in SOT-23
LT1461	Micropower LDO Low TC Precision Reference	0.04% Max 3ppm/°C 35µA Supply Current
LT1494/LT1495/ LT1496	Single/Dual/Quad Micropower Op Amps	1.5µA, $V_{OS} < 375\mu V$ , $I_B < 1000pA$
LTC1540	Nanopower Comparator with Reference	300nA, Available in 3mm × 3mm DFN Package
LTC1798	Micropower LDO Reference	0.15% Max 6.5µA Supply Current
LT6700	Micropower Dual Comparator with Reference	6.5µA, Choice of Polarities Available in SOT-23