Chopper-Stabilized Omnipolar Hall-Effect Switches

Not for New Design

These parts are in production but have been determined to be NOT FOR NEW DESIGN. This classification indicates that sale of this device is currently restricted to existing customer applications. The device should not be purchased for new design applications because obsolescence in the near future is probable. Samples are no longer available.

Date of status change: January 31, 2011

Recommended Substitutions:

For existing customer transition, and for new customers or new applications, contact Allegro Sales.

NOTE: For detailed information on purchasing options, contact your local Allegro field applications engineer or sales representative.

Allegro MicroSystems, Inc. reserves the right to make, from time to time, revisions to the anticipated product life cycle plan for a product to accommodate changes in production capabilities, alternative product availabilities, or market demand. The information included herein is believed to be accurate and reliable. However, Allegro MicroSystems, Inc. assumes no responsibility for its use; nor for any infringements of patents or other rights of third parties which may result from its use.

Chopper-Stabilized Omnipolar Hall-Effect Switches

Features and Benefits

- Omnipolar operation
- Chopper stabilization
 - Superior temperature stability
 - Extremely low switchpoint drift
 - Insensitive to physical stress
- Reverse battery protection
- Output short circuit protection
- Solid state reliability
- Small size
- Robust EMC capability
- High ESD ratings (HBM)

Packages: 3 pin SOT23W (suffix LH)

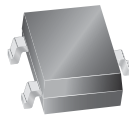

Not to scale

Description

The A3245 integrated circuit is an omnipolar, ultrasensitive Hall-effect switch with a digital output. This device has an integrated regulator permitting operation to 24 V, making it the first omnipolar switch available for operation to 24 V. This device is especially suited for operation over extended temperature ranges, up to +150°C. Superior high-temperature performance is made possible through an Allegro® patented dynamic offset cancellation, which reduces the residual offset voltage normally caused by device overmolding, temperature excursions, and thermal stress.

The A3245 Hall-effect switch includes the following on a single silicon chip: voltage regulator, Hall-voltage generator, small-signal amplifier, chopper stabilization, Schmitt trigger, and a short circuit protected open-drain output. Advanced BiCMOS wafer fabrication processing is used to take advantage of low-voltage requirements, component matching, very low input-offset errors, and small component geometries.

The omnipolar operation of the A3245 allows activation with either a north *or* a south polarity field of sufficient strength. In the absence of a magnetic field, the output is off. This

Continued on the next page...

Functional Block Diagram

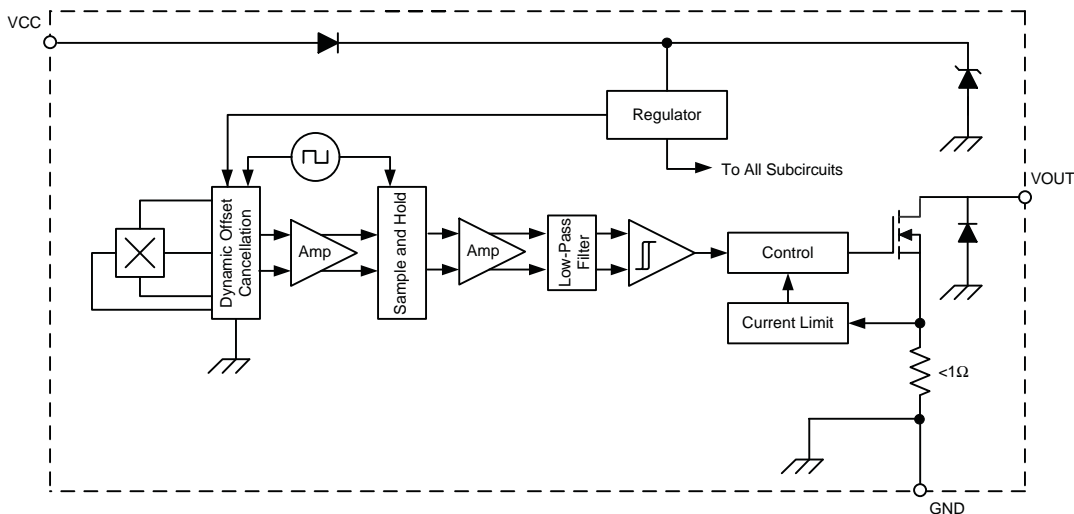

Description (continued)

patented magnetic-polarity-independence feature makes this device an excellent replacement for reed switches, with improved ease of manufacturing, because the A3245 does not require manufacturers to orient their magnets. These devices allow simple on/off switching in industrial, consumer, and automotive applications.

The A3245 is rated for operation between the ambient temperatures

–40°C and 85°C for the E temperature range, and –40°C to 150°C for the L temperature range. The small geometries of the BiCMOS process allow these devices to be provided in ultrasmall packages. Package LH is an SOT23W, a miniature low-profile surface-mount package. It is lead (Pb) free, with 100% matte tin plated leadframe.

Selection Guide

Part Number	Packing*	Mounting	Ambient, T_A (°C)
A3245ELHLT-T	7-in. reel, 3000 pieces/reel	3-pin SOT23W surface mount	–40 to 85
A3245LLHLT-T	7-in. reel, 3000 pieces/reel	3-pin SOT23W surface mount	–40 to 150

*Contact Allegro for additional packing options.

**Absolute Maximum Ratings**

Characteristic	Symbol	Notes	Rating	Units
Supply Voltage	V_{CC}		28	V
Reverse-Supply Voltage	V_{RCC}		–18	V
Reverse-Supply Current	I_{RCC}		–2	mA
Output Off Voltage	V_{OUT}		28	V
Output Current	$I_{OUTSINK}$		Internally Limited	–
Magnetic Flux Density	B		Unlimited	G
Operating Ambient Temperature	T_A	Range E	–40 to 85	°C
		Range L	–40 to 150	°C
Maximum Junction Temperature	$T_J(max)$		165	°C
Storage Temperature	T_{stg}		–65 to 170	°C

OPERATING CHARACTERISTICS valid over full operating voltage and ambient temperature ranges, unless otherwise noted

Characteristic	Symbol	Test Conditions	Min.	Typ.	Max.	Units
Electrical Characteristics						
Supply Voltage ¹	V_{CC}	Operating, $T_J < 165^\circ\text{C}$	3.6	–	24	V
Output Leakage Current	I_{OUTOFF}	$V_{OUT} = 24\text{ V}$, $B < B_{RP}$	–	–	10	μA
Output On Voltage	$V_{OUT(SAT)}$	$I_{OUT} = 20\text{ mA}$, $B > B_{OP}$	–	–	500	mV
Output Current Limit	I_{OM}	$B > B_{OP}$	30	–	60	mA
Power-On Time	t_{PO}	$V_{CC} > V_{CC(MIN)}$	–	–	50	μs
Chopping Frequency	f_c		–	200	–	kHz
Output Rise Time ²	t_r	$R_{LOAD} = 820\ \Omega$, $C_S = 20\ \text{pF}$	–	–	1	μs
Output Fall Time ²	t_f	$R_{LOAD} = 820\ \Omega$, $C_S = 20\ \text{pF}$	–	–	1	μs
Supply Current	I_{CCON}	$B > B_{OP}$	–	1.5	3.5	mA
	I_{CCOFF}	$B < B_{RP}$	–	1.5	3.5	mA
Reverse Battery Current	I_{RCC}	$V_{RCC} = -18\text{ V}$	–	–	-2	mA
Supply Zener Clamp Voltage	$V_{ZSupply}$	$I_{CC} = 6.5\text{ mA}$; $T_A = 25^\circ\text{C}$	28	–	–	V
Supply Zener Current ³	$I_{ZSupply}$	$V_S = 28\text{ V}$	–	–	6.5	mA
Magnetic Characteristics⁴						
Operate Point	B_{OPS}	South pole adjacent to branded face of device	15	38	55	G
	B_{OPN}	North pole adjacent to branded face of device	-55	-38	-15	G
Release Point	B_{RPS}	South pole adjacent to branded face of device	5	20	50	G
	B_{RPN}	North pole adjacent to branded face of device	-50	-20	-5	G
Hysteresis	B_{HYS}	$ B_{OPX} - B_{RPX} $	5	18	30	G

¹ Maximum voltage must be adjusted for power dissipation and junction temperature, see *Power Derating* section.

² C_S = oscilloscope probe capacitance.

³ Maximum current limit is equal to the maximum $I_{CC(MAX)}$ + 3 mA.

⁴ Magnetic flux density, B, is indicated as a negative value for north-polarity magnetic fields, and as a positive value for south-polarity magnetic fields. This so-called algebraic convention supports arithmetic comparison of north and south polarity values, where the relative strength of the field is indicated by the absolute value of B, and the sign indicates the polarity of the field (for example, a -100 G field and a 100 G field have equivalent strength, but opposite polarity).

DEVICE QUALIFICATION PROGRAM

Contact Allegro for information.

EMC (Electromagnetic Compatibility) REQUIREMENTS

Contact Allegro for information.



Electrical Characteristic Data

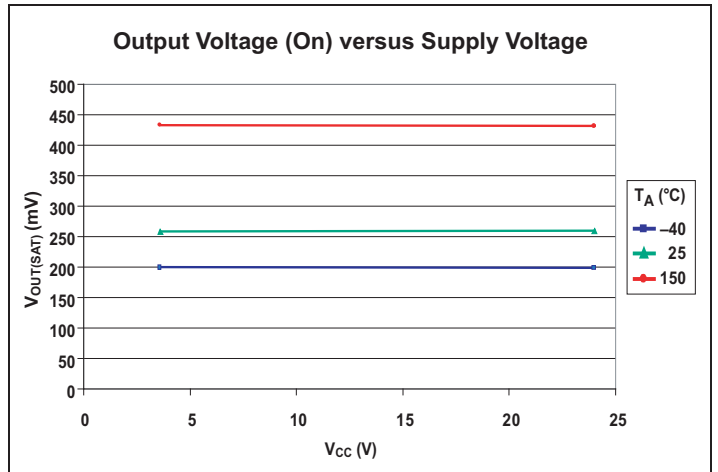
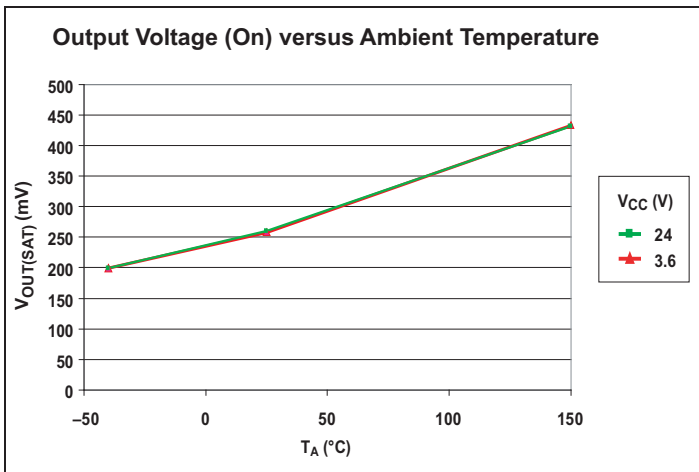
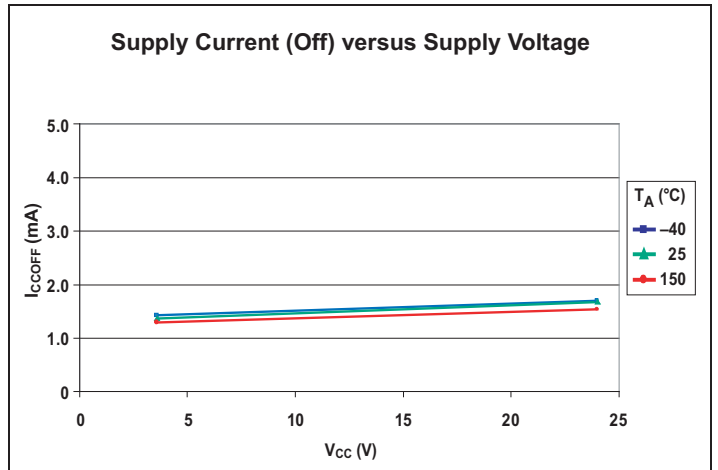
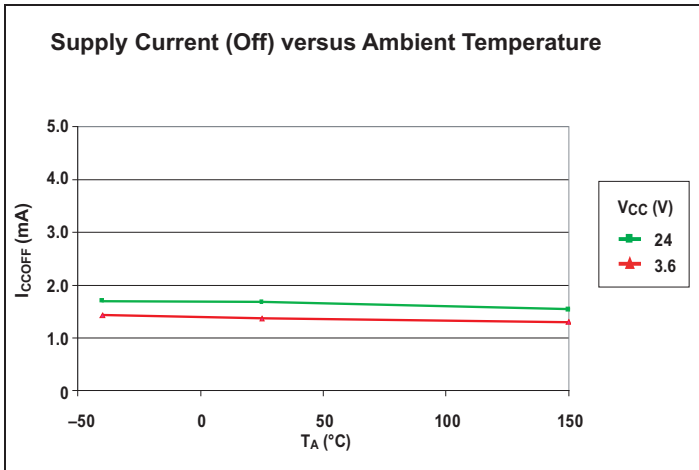
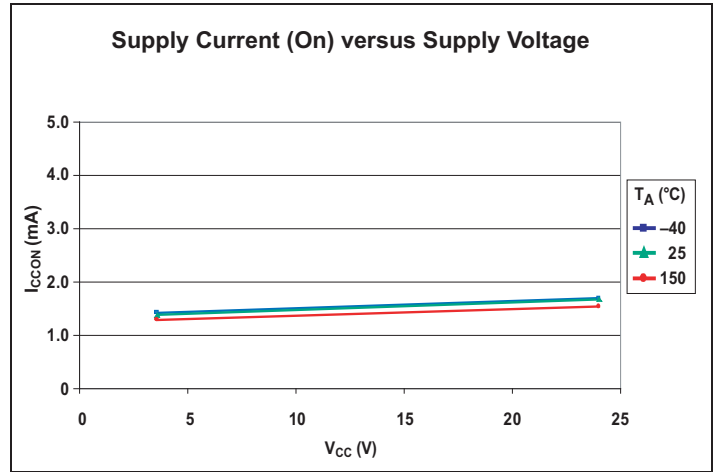
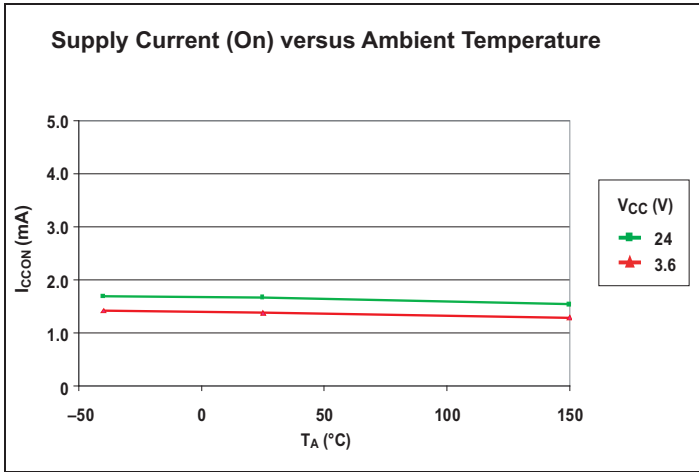

Magnetic Characteristic Data

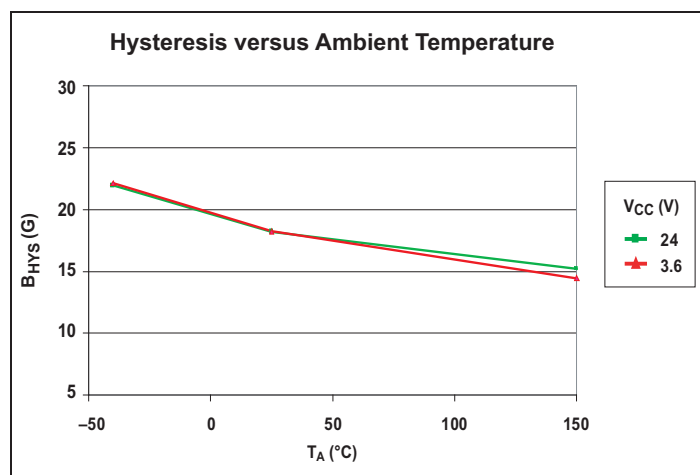
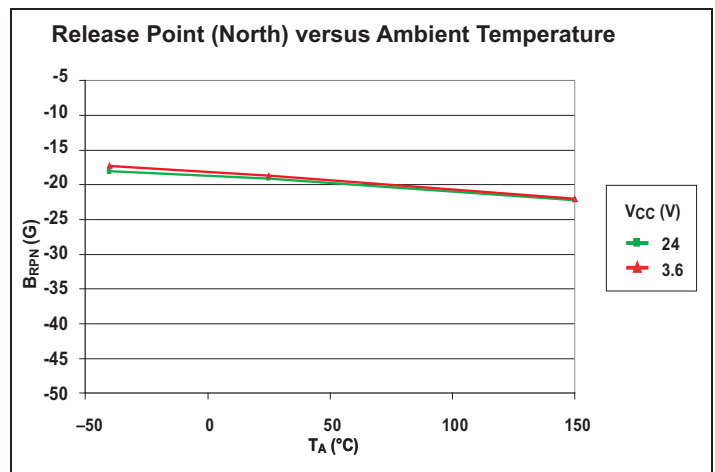
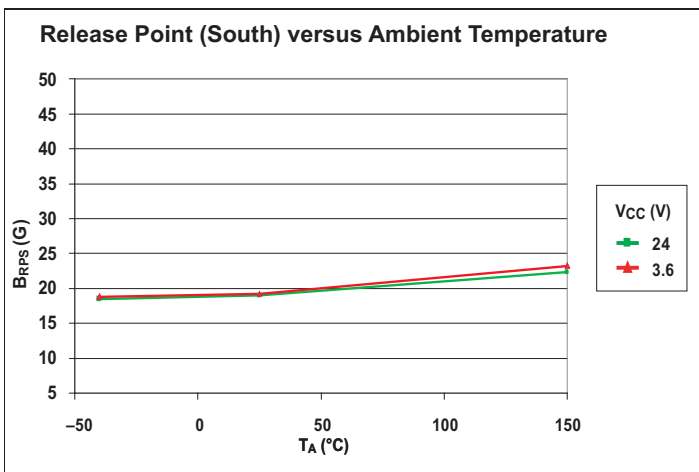
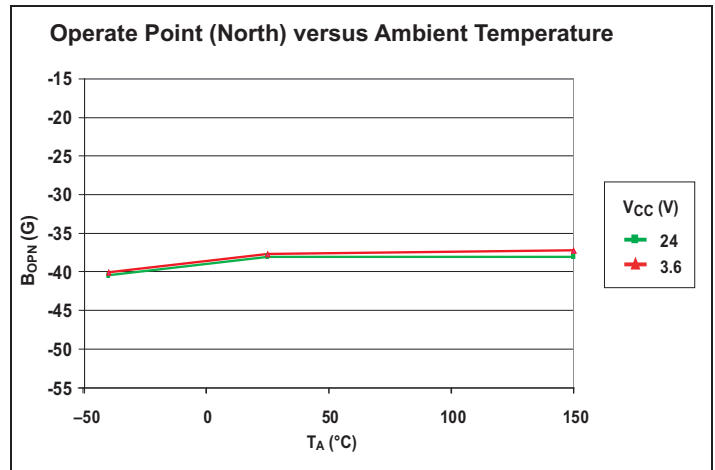
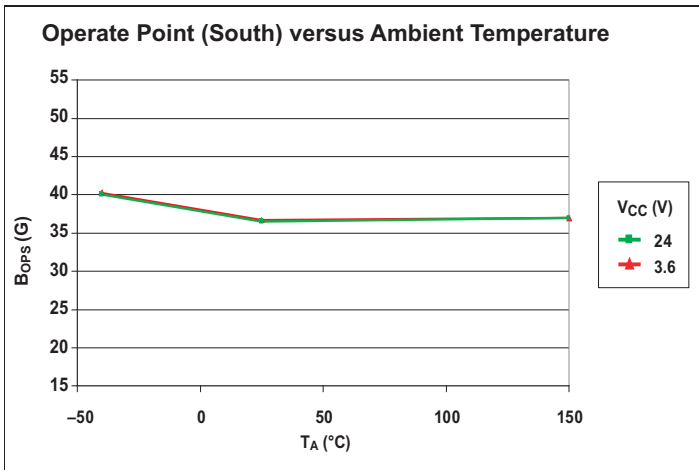

Continued on the next page...

Magnetic Characteristic Data (Continued)

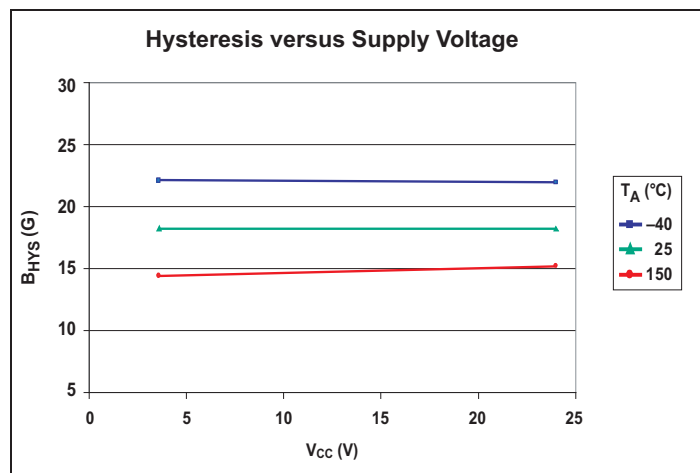
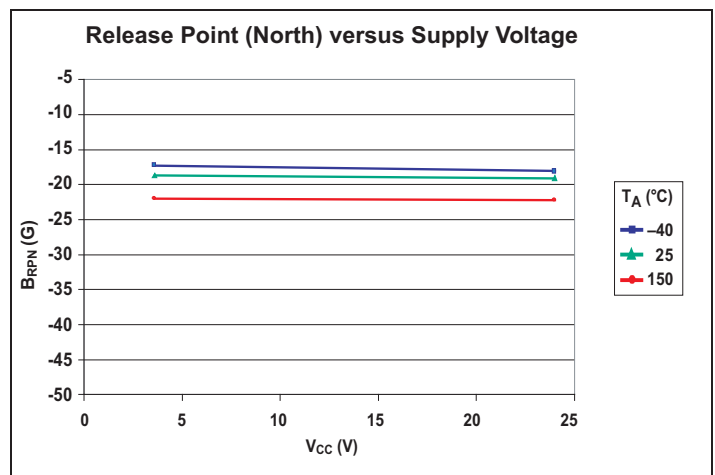
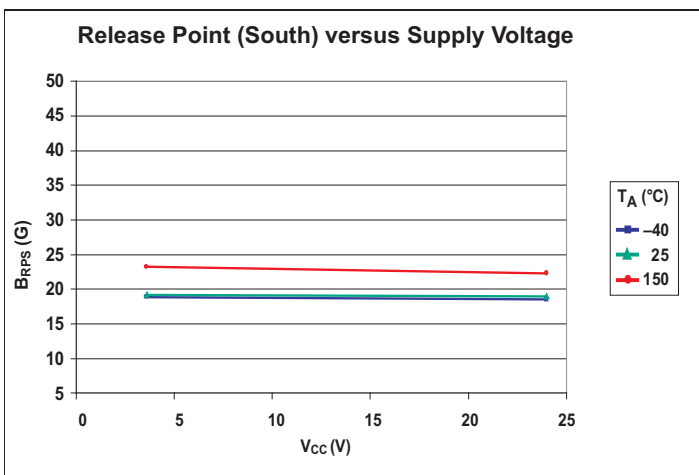
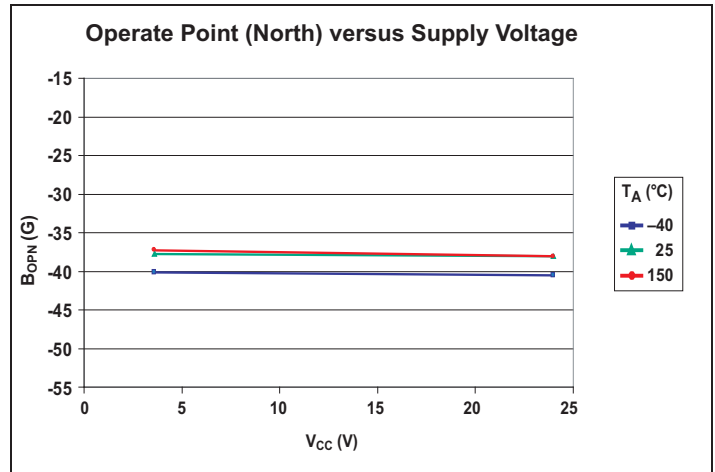
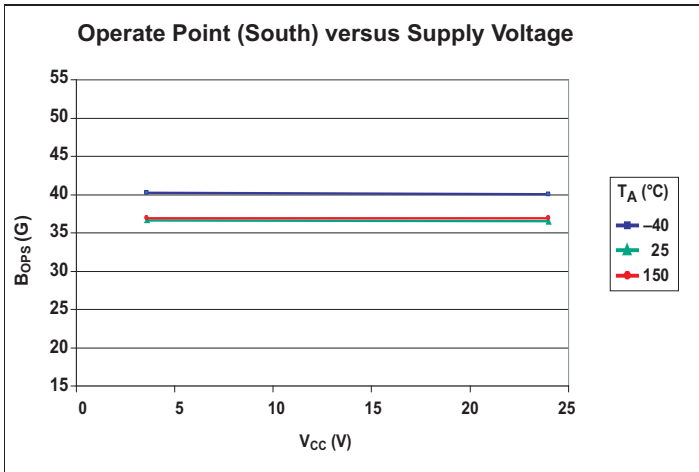

THERMAL CHARACTERISTICS may require derating at maximum conditions, see application information

Characteristic	Symbol	Test Conditions	Value	Units
Package Thermal Resistance	$R_{\theta JA}$	Package LH-3, 1-layer PCB with copper limited to solder pads	110	$^{\circ}\text{C}/\text{W}$
		Package LH-3, 2-layer PCB with 0.926 in ² on each side, connected by thermal vias	228	$^{\circ}\text{C}/\text{W}$

Power Derating Curve

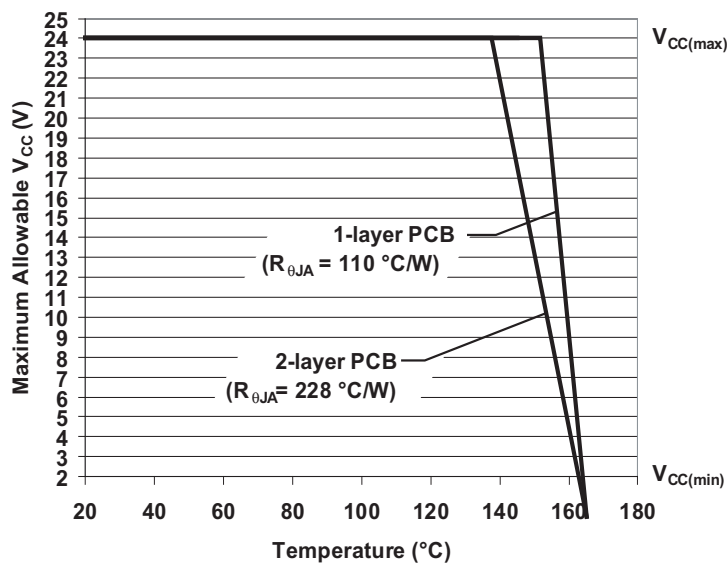

Power Dissipation versus Ambient Temperature

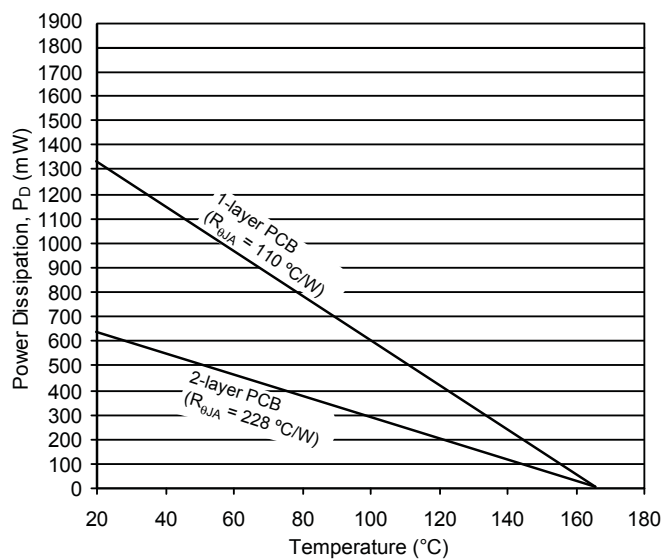

Functional Description

Operation

The output of this device switches low (turns on) when a magnetic field perpendicular to the Hall element exceeds the operate point, B_{OPS} (or is less than B_{OPN}). After turn-on, the output voltage is $V_{OUT(SAT)}$. The output transistor is capable of sinking current up to the short circuit current limit, I_{OM} , which is a minimum of 30 mA. When the magnetic field is reduced below the release point, B_{RPS} (or increased above B_{RPN}), the device output switches high (turns off). The difference in the magnetic operate and release points is the hysteresis, B_{HYS} , of the device. This built-in hysteresis allows clean switching of the output even in the presence of external mechanical vibration and electrical noise.

Powering-on the device in a hysteresis region, between B_{OPX} and B_{RPX} , allows an indeterminate output state. The correct state is attained after the first excursion beyond B_{OPX} or B_{RPX} .

Applications

It is strongly recommended that an external bypass capacitor be connected (in close proximity to the Hall element) between the

supply and ground of the device to reduce both external noise and noise generated by the chopper stabilization technique. As is shown in Panel B of figure 1, a $0.1\mu\text{F}$ capacitor is typical.

Omnipolar switches allow operation with either a north pole or south pole magnet orientation, enhancing product manufacturability with the device.

Extensive applications information on magnets and Hall-effect devices is available in:

- *Hall-Effect IC Applications Guide*, AN27701,
- *Hall-Effect Devices: Gluing, Potting, Encapsulating, Lead Welding and Lead Forming*, AN27703.1
- *Soldering Methods for Allegro's Products – SMT and Through-Hole*, AN26009

All are provided in *Allegro Electronic Data Book*, AMS-702 and the Allegro Web site: www.allegromicro.com

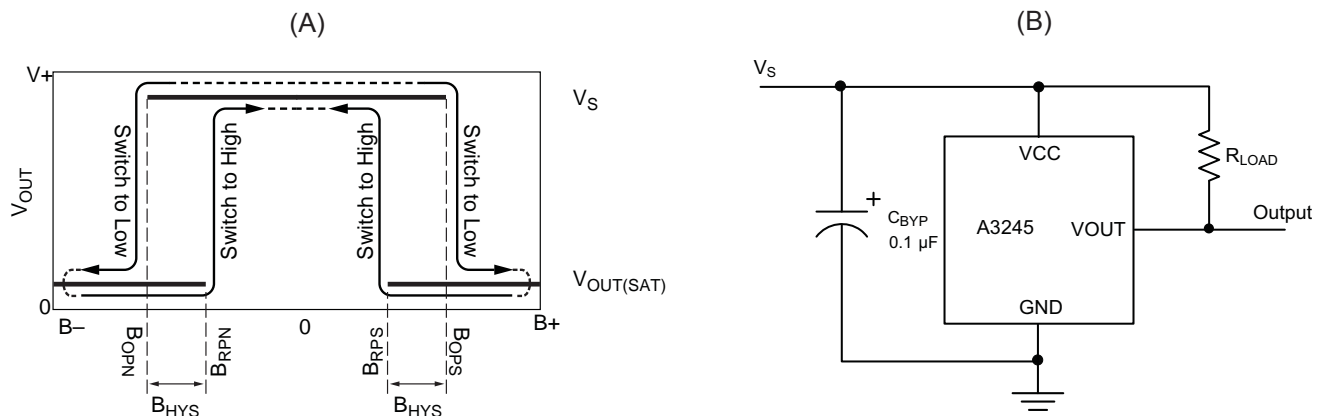

Figure 1: Switching Behavior of Omnipolar Switches. In Panel A, on the horizontal axis, the B+ direction indicates increasing south polarity magnetic field strength, and the B- direction indicates decreasing south polarity field strength (including the case of increasing north polarity). This behavior can be exhibited when using a circuit such as that shown in panel B.

Chopper Stabilization Technique

When using Hall-effect technology, a limiting factor for switchpoint accuracy is the small signal voltage developed across the Hall element. This voltage is disproportionately small relative to the offset that can be produced at the output of the Hall element. This makes it difficult to process the signal while maintaining an accurate, reliable output over the specified operating temperature and voltage ranges.

Chopper stabilization is a unique approach used to minimize Hall offset on the chip. The patented Allegro technique, namely Dynamic Quadrature Offset Cancellation, removes key sources of the output drift induced by thermal and mechanical stresses. This offset reduction technique is based on a signal modulation-demodulation process. The undesired offset signal is separated from the magnetic-field-induced signal in the frequency domain, through modulation. The subsequent demodulation acts as a modulation process for the offset, causing the magnetic-field-induced signal to recover its original spectrum at baseband, while the dc offset becomes a high-frequency signal. The magnetic-field-induced signal then can pass through a low-pass filter, while the modulated dc offset is suppressed. This configuration is illustrated in figure 2.

The chopper stabilization technique uses a 200 kHz high-frequency clock. For demodulation process, a sample and hold technique is used, where the sampling is performed at twice the chopper frequency (400 kHz). This high-frequency operation allows a greater sampling rate, which results in higher accuracy and faster signal-processing capability. This approach desensitizes the chip to the effects of thermal and mechanical stresses, and produces devices that have extremely stable quiescent Hall output voltages and precise recoverability after temperature cycling. This technique is made possible through the use of a BiCMOS process, which allows the use of low-offset, low-noise amplifiers in combination with high-density logic integration and sample-and-hold circuits.

The repeatability of magnetic-field-induced switching is affected slightly by a chopper technique. However, the Allegro high-frequency chopping approach minimizes the affect of jitter and makes it imperceptible in most applications. Applications that are more likely to be sensitive to such degradation are those requiring precise sensing of alternating magnetic fields; for example, speed sensing of ring-magnet targets. For such applications, Allegro recommends its digital device families with lower sensitivity to jitter. For more information on those devices, contact your Allegro sales representative.

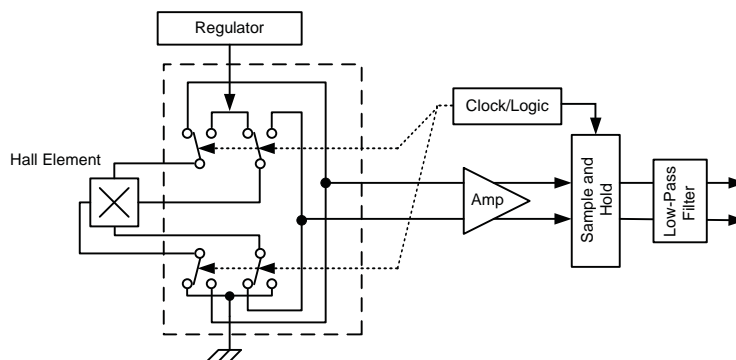

Figure 2. Chopper Stabilization Circuit (Dynamic Quadrature Offset Cancellation)

Power Derating

The device must be operated below the maximum junction temperature of the device, $T_{J(\max)}$. Under certain combinations of peak conditions, reliable operation may require derating supplied power or improving the heat dissipation properties of the application. This section presents a procedure for correlating factors affecting operating T_J . (Thermal data is also available on the Allegro MicroSystems Web site.)

The Package Thermal Resistance, $R_{\theta JA}$, is a figure of merit summarizing the ability of the application and the device to dissipate heat from the junction (die), through all paths to the ambient air. Its primary component is the Effective Thermal Conductivity, K , of the printed circuit board, including adjacent devices and traces. Radiation from the die through the device case, $R_{\theta JC}$, is relatively small component of $R_{\theta JA}$. Ambient air temperature, T_A , and air motion are significant external factors, damped by overmolding.

The effect of varying power levels (Power Dissipation, P_D), can be estimated. The following formulas represent the fundamental relationships used to estimate T_J , at P_D .

$$P_D = V_{IN} \times I_{IN} \quad (1)$$

$$\Delta T = P_D \times R_{\theta JA} \quad (2)$$

$$T_J = T_A + \Delta T \quad (3)$$

For example, given common conditions such as: $T_A = 25^\circ\text{C}$, $V_{CC} = 12\text{ V}$, $I_{CC} = 1.5\text{ mA}$, and $R_{\theta JA} = 165\text{ }^\circ\text{C/W}$, then:

$$P_D = V_{CC} \times I_{CC} = 12\text{ V} \times 1.5\text{ mA} = 18\text{ mW}$$

$$\Delta T = P_D \times R_{\theta JA} = 18\text{ mW} \times 165\text{ }^\circ\text{C/W} = 3^\circ\text{C}$$

$$T_J = T_A + \Delta T = 25^\circ\text{C} + 3^\circ\text{C} = 28^\circ\text{C}$$

A worst-case estimate, $P_{D(\max)}$, represents the maximum allowable power level ($V_{CC(\max)}$, $I_{CC(\max)}$), without exceeding $T_{J(\max)}$, at a selected $R_{\theta JA}$ and T_A .

Example: Reliability for V_{CC} at $T_A = 150^\circ\text{C}$, package LH, using a low-K PCB.

Observe the worst-case ratings for the device, specifically: $R_{\theta JA} = 228\text{ }^\circ\text{C/W}$, $T_{J(\max)} = 165^\circ\text{C}$, $V_{CC(\max)} = 24\text{ V}$, and $I_{CC(\max)} = 5\text{ mA}$.

Calculate the maximum allowable power level, $P_{D(\max)}$. First, invert equation 3:

$$\Delta T_{\max} = T_{J(\max)} - T_A = 165^\circ\text{C} - 150^\circ\text{C} = 15^\circ\text{C}$$

This provides the allowable increase to T_J resulting from internal power dissipation. Then, invert equation 2:

$$P_{D(\max)} = \Delta T_{\max} \div R_{\theta JA} = 15^\circ\text{C} \div 228\text{ }^\circ\text{C/W} = 65.8\text{ mW}$$

Finally, invert equation 1 with respect to voltage:

$$V_{CC(\text{est})} = P_{D(\max)} \div I_{CC(\max)} = 65.8\text{ mW} \div 5\text{ mA} = 13.2\text{ V}$$

The result indicates that, at T_A , the application and device can dissipate adequate amounts of heat at voltages $\leq V_{CC(\text{est})}$.

Compare $V_{CC(\text{est})}$ to $V_{CC(\max)}$. If $V_{CC(\text{est})} \leq V_{CC(\max)}$, then reliable operation between $V_{CC(\text{est})}$ and $V_{CC(\max)}$ requires enhanced $R_{\theta JA}$. If $V_{CC(\text{est})} \geq V_{CC(\max)}$, then operation between $V_{CC(\text{est})}$ and $V_{CC(\max)}$ is reliable under these conditions.

Package LH, 3-Pin (SOT-23W)

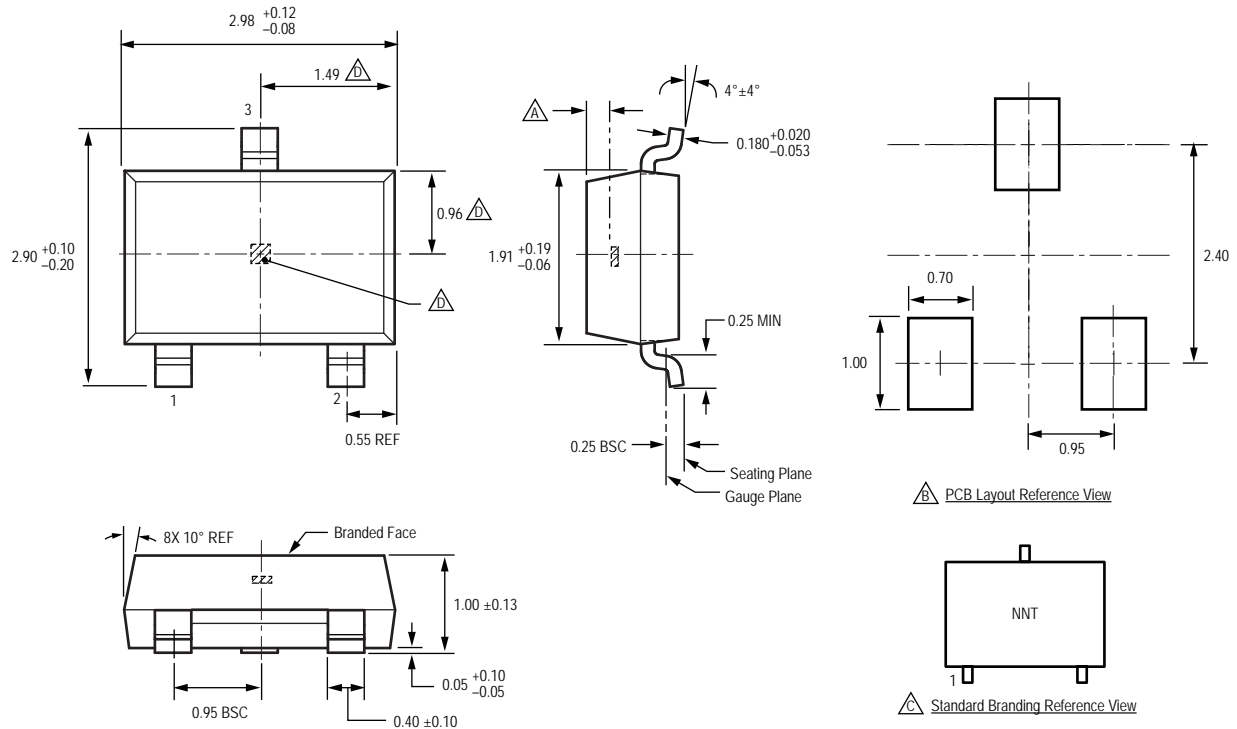

For Reference Only; not for tooling use (reference dwg. 802840)
 Dimensions in millimeters
 Dimensions exclusive of mold flash, gate burrs, and dambar protrusions
 Exact case and lead configuration at supplier discretion within limits shown

- △ Active Area Depth, 0.28 mm REF
- △ Reference land pattern layout
 All pads a minimum of 0.20 mm from all adjacent pads; adjust as necessary to meet application process requirements and PCB layout tolerances
- △ Branding scale and appearance at supplier discretion
- △ Hall element, not to scale

Package LH

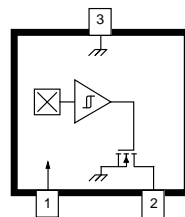

Terminal List

Name	Description	Number
VCC	Connects power supply to chip	1
VOUT	Output from circuit	2
GND	Ground	3

Copyright ©2005-2010, Allegro MicroSystems, Inc.

Allegro MicroSystems, Inc. reserves the right to make, from time to time, such departures from the detail specifications as may be required to permit improvements in the performance, reliability, or manufacturability of its products. Before placing an order, the user is cautioned to verify that the information being relied upon is current.

Allegro's products are not to be used in life support devices or systems, if a failure of an Allegro product can reasonably be expected to cause the failure of that life support device or system, or to affect the safety or effectiveness of that device or system.

The information included herein is believed to be accurate and reliable. However, Allegro MicroSystems, Inc. assumes no responsibility for its use; nor for any infringement of patents or other rights of third parties which may result from its use.

For the latest version of this document, visit our website:

www.allegromicro.com



Allegro MicroSystems, Inc.
115 Northeast Cutoff, Box 15036
Worcester, Massachusetts 01615-0036 (508) 853-5000
www.allegromicro.com