

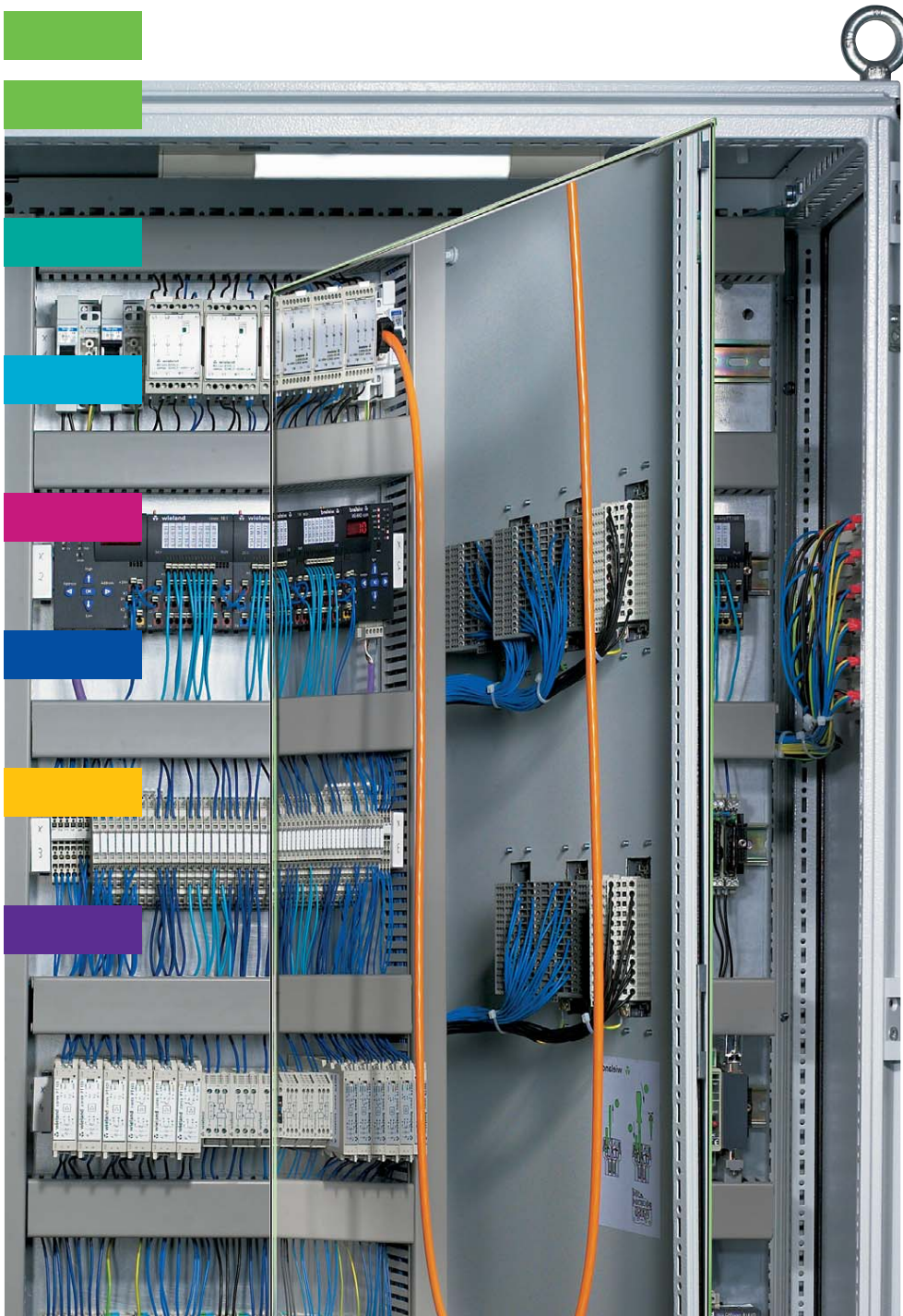

wieland

Electrical
Connections



*Best
Connections.*

0105.2 F 01/02

wieland

For more than 90 years, Wieland Electric has offered customers the broad product range, worldwide approvals, superior designs, unsurpassed quality, and custom development capabilities necessary to guarantee the most cost-effective, space-saving and time-saving interconnect solutions. More than just terminal blocks, Wieland's total offering includes products from PC board connectors to advanced electronic modules; I/O systems to DIN rail power supplies; and rectangular connectors to hazardous location components. And more than just products, Wieland has the design support, application assistance and custom solutions necessary to meet your most challenging interconnect requirements.

The cornerstone of all Wieland products is the superior design and our philosophy of continuous improvement through innovation. Our high degree of vertical integration and attention to product detail enable our products not only to perform above established standards, but also to minimize the purchase cost as well as associated installation and maintenance costs.

Best by design, best product offering and best support.

Wieland Best Connections.

Wieland Products and Industries Supported	Machine Manufacturers	Petrochemical	Heating, Ventilation & Air Conditioning	Process Controls & Instrumentation	Transportation	Water Treatment & Utilities	Telecommunications	Computers & Networking	Packaging & Material Handling	Automotive & Robotics
selos, fasis, taris DIN rail Mountable Terminal Blocks										
flare Electro-Mechanical & Solid State Relay Modules										
Signal Conditioning & Surge Suppression Modules										
ricos Remote Interface Communication System										
wipos DIN Rail Mounted Power Supplies										
Standard & Custom Interface Modules										
revos Industrial Multipole Connectors										
Wire Management Products										
gesis ST Compact Connector System										
wiecon Pluggable PC Board Terminal Strips										
wiecon Modular PC Board Terminal Strips										
europa & Compact Panel Mounted Terminal Strips										

U.S.A. • 49 International Road • Burgaw, NC 28425 • Phone (910) 259-5050 • Fax (910) 259-3691
 Canada • 2889 Brighton Road • Oakville, Ontario L6H 6C9 • Phone (905) 829-8414 • Fax (905) 829-8413



wieland

*....serving
industrial, manufacturing,
and process control markets
worldwide !*

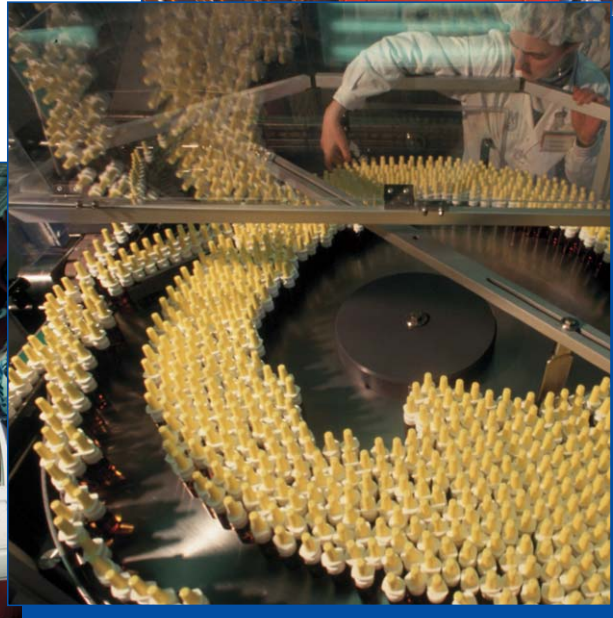
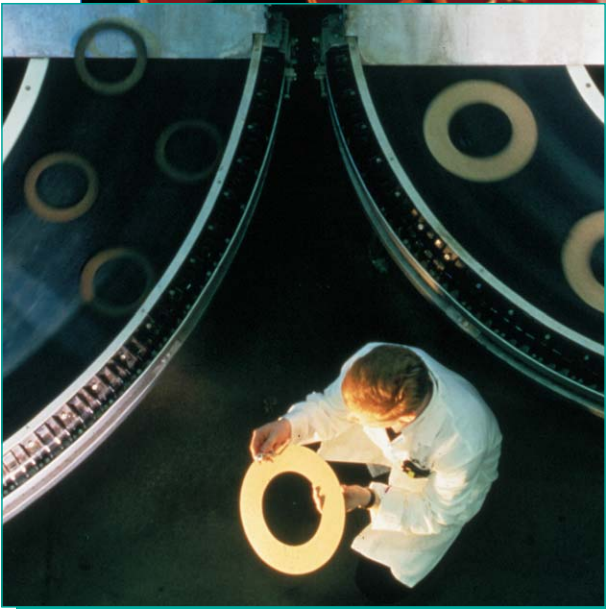
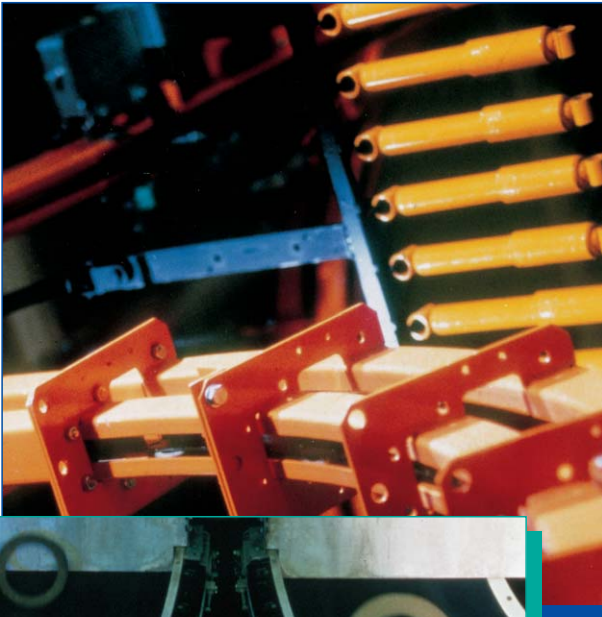

Wieland special products and custom capabilities provide unique solutions for your specific application needs. **For more information** on how **Wieland** products can connect you to your future designs, call **1-800-wieland** or visit us at

www.wielandinc.com

*Best
Connections.*

fasis DIN Rail Terminal Blocks – Spring Clamp Connection

selos DIN Rail Terminal Blocks – Screw Clamp Connection

taris DIN Rail Terminal Blocks – IDC Connection

appliance TERMINALS

wiecon PC Board Connectors

electronics

gesis[®] Connector Systems

revos Industrial Multipole connectors

facts & DATA

contents

DIN rail terminal blocks for TS35, type WKF
Multi-conductor terminal blocks
Application specific terminal blocks
Micro modular feed through blocks for TS15, type WKFM
Terminal blocks for electrical installations, type WKIF

DIN rail terminal blocks for electrical installations, type WKI
DIN rail terminal blocks with U foot, type WK/WKN
Feed through blocks for large cross section conductors
Multi-conductor terminal blocks
Application specific terminal blocks
DIN rail terminal blocks with extruded clamping body for TS35, type 9700A
TOP connector system
Busbar components
Stacking coordinates

DIN rail terminal blocks for TS35, type WKC
Multi-conductor terminal blocks with U foot
Application specific terminal blocks
Hybrid terminal blocks

Terminal strips
Lighting and appliance terminals
Plug/screw terminal strips
Terminal boxes
Divisible terminal strips
Mains connectors for appliance wiring

Pluggable PC board connectors, Insulated headers and pin strip headers, two piece design
DIN rail terminal blocks with pluggable connection for PC board connectors
Pluggable PC board connectors, edge card
PC board connectors
PC board connectors, 2-tier version
PC board connectors, 3-tier version
PC board connectors, 4-tier version
Special-purpose connectors, RAST 5 connection style
Feed through modules for control cabinets

Distributed I/O modules
Relay modules
Analog signal conditioning
Wieland power supply
Wieland Electronic modules
Wieland interface system
Empty housings for electronic components

The pluggable electrical system



Separate catalog – please order your copy at:

www.gesis.com
info@wielandinc.com

Standard – 400 V, 500 V, 400/690 V, cable to cable coupling, EMC etc.
Modular system
3 to 8 pole connectors
High-density connectors
24 pole connectors
Data cable feed through, D-Sub connections, bus system connections, fiber optic
Pg thread cable glands
High amperage connectors
Motor starter components

Pg threads are still available

Preparation of conductor ends with
– ferrules
– tools
Technical explanations
Tables
Approvals

Table of contents, structured as per
– type description

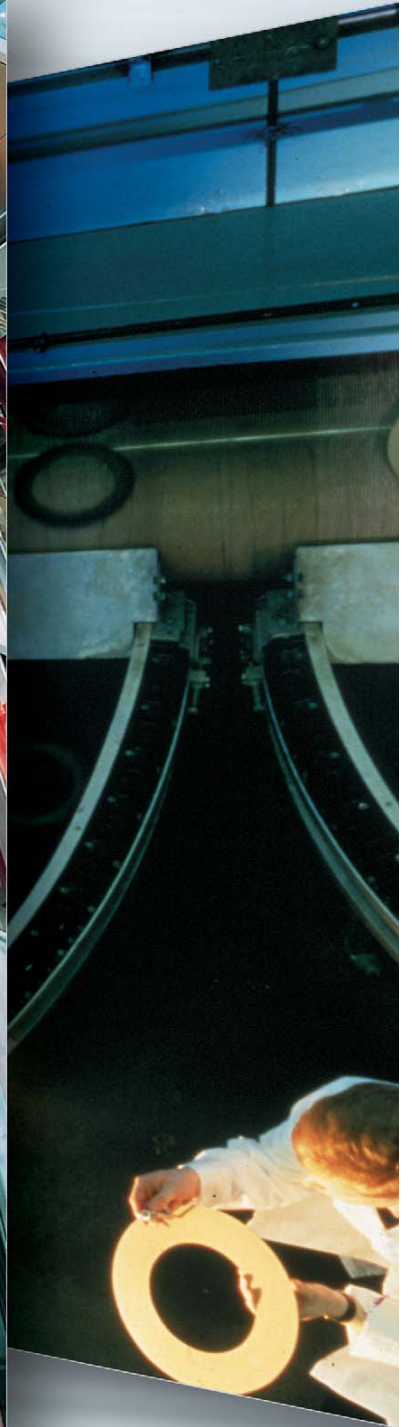
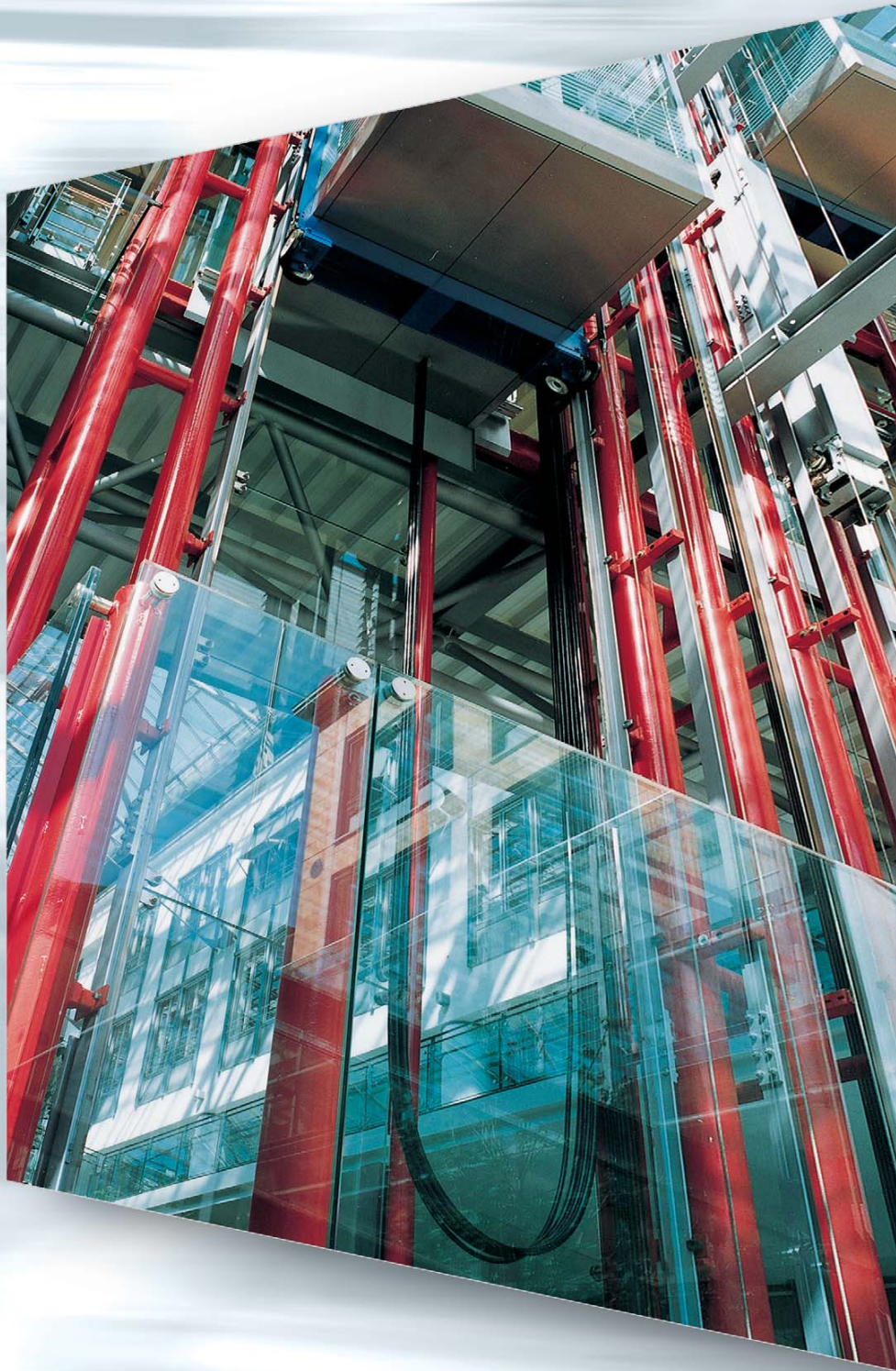

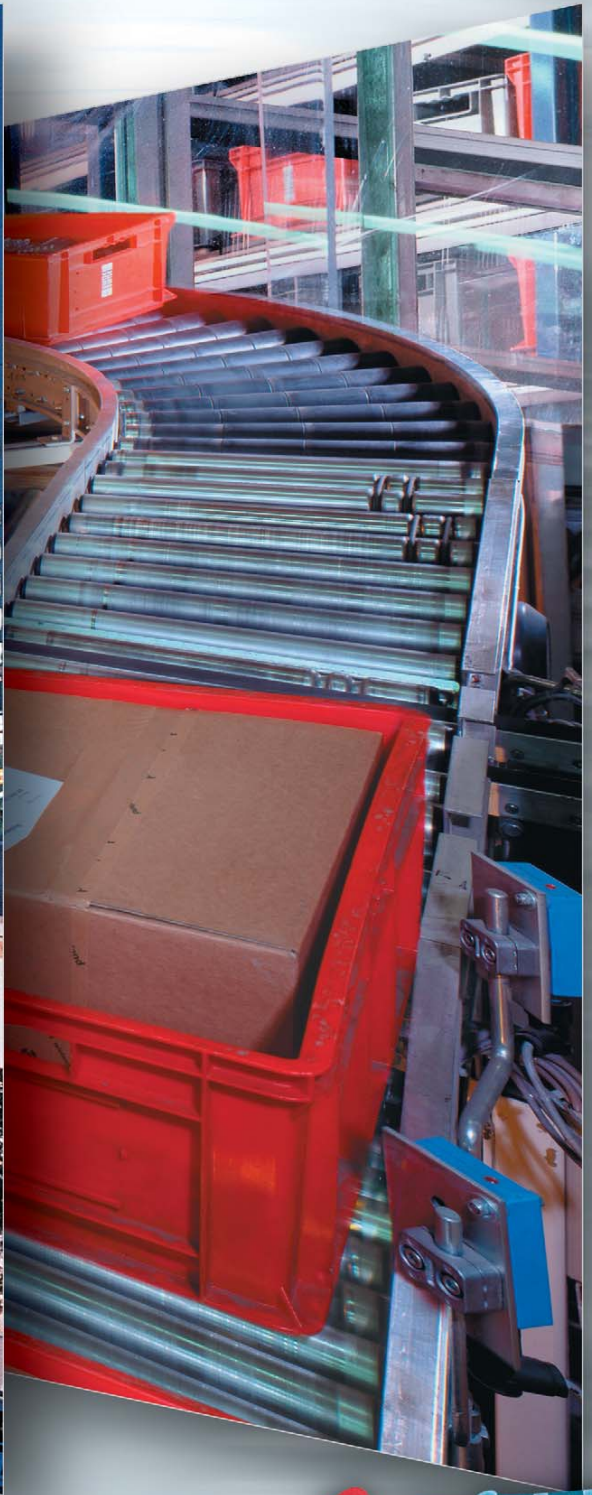

DIN Rail Terminal Blocks

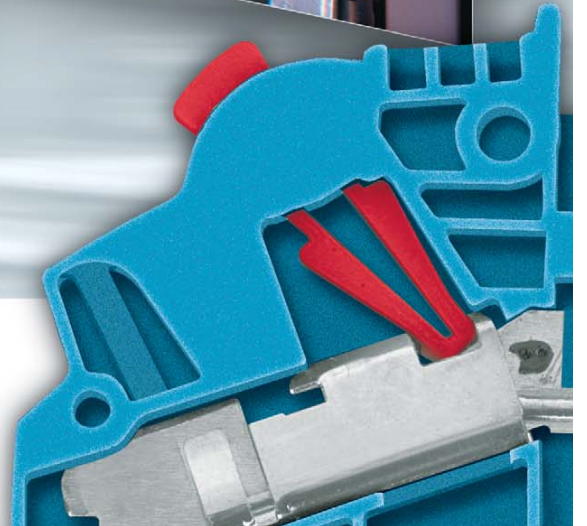

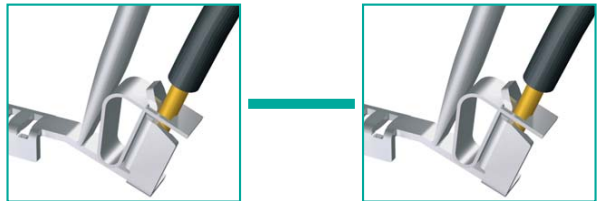

fasis DIN rail terminal blocks – spring clamp connection

BIT = Building
Installation
Technology

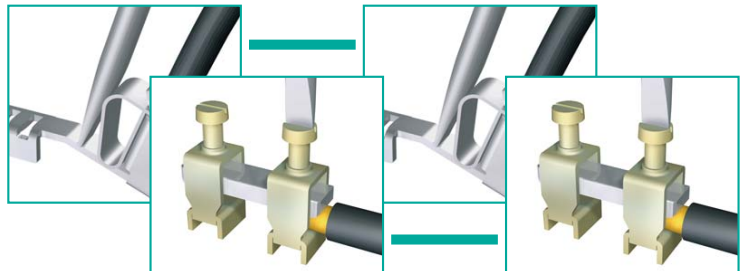

fasis BIT DIN rail terminal blocks – spring clamp connection
selos BIT DIN rail terminal blocks – screw clamp connection

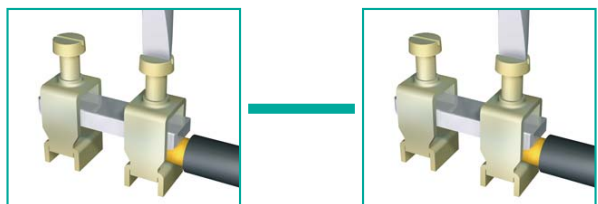

selos DIN rail terminal blocks – screw clamp connection

CONTENTS

<p>fasis DIN rail terminal blocks with spring clamp connection, type WKF</p>	<p>Product overview and information</p> <ul style="list-style-type: none"> • Feed through blocks • Ground blocks • Neutral disconnect blocks • Supply blocks for junction boxes • Duo feed through blocks • Duo ground blocks • Multi-tier blocks 	<p>Page 16 Page 20 Page 22 Page 24 Page 25 Page 26 Page 28 Page 30</p>
	<p>DIN rail terminal blocks with spring and plug-in connection for PC board terminals</p> <ul style="list-style-type: none"> • Duo feed through blocks with plug-in connection for PC board terminals • Disconnect blocks with fuse holder / diode plug • Knife-edge disconnect block • Micro modular feed through blocks, type WKFM <p>Initiator and actuator blocks, type WKF 1.5 KO</p> <ul style="list-style-type: none"> • Initiator and actuator blocks 	<p>Page 34 Page 36 Page 38 Page 39 Page 40 Page 42 Page 44</p>
<p>Accessories / marking accessories</p>	<p>for DIN rail terminal blocks with spring clamp connection, type WKF</p>	<p>Page 46</p>
<p>fasis BIT Installation blocks, type WKI/WKIF</p> <p>selos BIT Installation blocks, type WK/WKI</p>	<p>Product overview and information</p> <p>Installation blocks with spring clamp connection</p> <ul style="list-style-type: none"> • Installation blocks, type WKIF • Feed through blocks • Neutral disconnect blocks • Ground blocks <p>Installation blocks with screw clamp connection</p> <ul style="list-style-type: none"> • Installation blocks, type WKI 4... • Feed through blocks • Neutral disconnect blocks • Ground blocks • PEN assembly block 	<p>Page 50 Page 56 Page 58 Page 62 Page 64 Page 66 Page 68 Page 72 Page 78 Page 80 Page 82 Page 84</p>
<p>Accessories / marking accessories</p>	<p>for DIN rail terminal blocks with screw clamp connection for junction boxes</p>	<p>Page 86</p>
<p>selos DIN rail terminal blocks with screw clamp connection, type WKN</p>	<p>Product overview and information</p> <ul style="list-style-type: none"> • Feed through blocks, type WK/WKN • Neutral disconnect block with U-foot • Ground blocks • Duo feed through blocks • Multi-tier feed through blocks • Initiator blocks • Disconnect blocks • Fuse blocks • Feed through blocks with fuse • Fuse block with NEOZED[®] cartridge for TS 35 • Balance resistor terminals with trimmer potentiometer • Diode blocks • Thermal voltage terminals • Ground disconnect blocks 	<p>Page 92 Page 102 Page 106 Page 108 Page 112 Page 116 Page 118 Page 122 Page 124 Page 126 Page 128 Page 130 Page 131 Page 132 Page 133</p>

selos

DIN rail terminal blocks – screw clamp connection

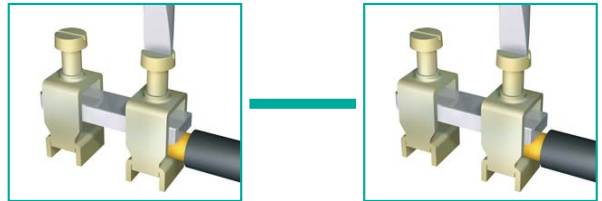

selos CLASSIC LINE

DIN rail terminal blocks – screw clamp connection

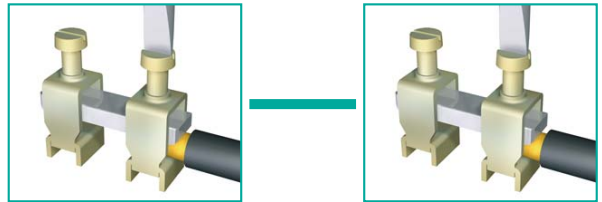

taris

DIN rail terminal blocks – IDC technology



CONTENTS

selos PLUG	<ul style="list-style-type: none"> • Feed through blocks with pluggable connection for PC board terminals • Feed through blocks / distribution blocks with screw / tab connection 	Page 134 Page 138
selos MINI	<ul style="list-style-type: none"> • Feed-through blocks with solder connection • Micro modular feed through blocks for TS 15 	Page 142 Page 144
Measuring disconnect blocks	Information	Page 146
selos POWER LINE	Information <ul style="list-style-type: none"> • Stud-type terminal blocks for TS 32 and TS 35 • Feed-through blocks up to 240 mm² 	Page 150 Page 152 Page 156
Accessories for DIN rail terminal blocks		Page 160
Marking accessories		Page 178
selos CLASSIC LINE, DIN rail terminal blocks with screw connection, type 9700 A.. S35	Product overview and information <ul style="list-style-type: none"> • Feed through blocks • Neutral disconnect blocks • Ground blocks • PEN assembly block 	Page 184 Page 190 Page 193 Page 194 Page 195
Accessories / marking accessories	for DIN rail terminal blocks with screw clamp connection, type 9700 A/.. S35	Page 196
TOP system	Information <ul style="list-style-type: none"> • Stacking coordinates 32pole • Shield connection clamps, type SK • Shield connection clamps, type SKN 	Page 202 Page 206 Page 210 Page 212
Busbar components	<ul style="list-style-type: none"> • Modular N and PE distributor terminals • Modular pluggable connectors with screw clamp connection • Compact pluggable connectors with screw clamp connection and coding • Modular feed-through blocks with solder tab connector 	Page 214 Page 216 Page 218 Page 219 Page 220
taris DIN rail terminal blocks with IDC technology, type WKC	Product overview and information <ul style="list-style-type: none"> • Feed through blocks, ground blocks • Duo feed through blocks and duo ground blocks • Multi-tier blocks, function blocks • Knife-edge disconnect block • Disconnect blocks 	Page 222 Page 232 Page 234 Page 238 Page 240 Page 242
Hybrid DIN rail terminal blocks with IDC and screw connection, type WKC...S/C	Information <ul style="list-style-type: none"> • Hybrid feed through and ground blocks 	Page 244 Page 232
Accessories / marking accessories	for DIN rail terminal blocks with IDC technology	Page 248

Software for DIN rail terminal blocks

wieplan

- Electronic catalog for terminal block assemblies
- Via software: drawing/part lists/order data
- Shopping cart function via www.wieland-electric.com



Part number
Software 95.502.1000.0

Manual 05.563.6389.0

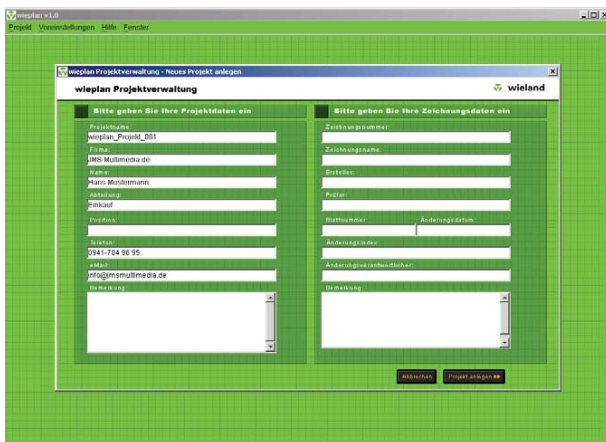

Project management

wieplan enables you to clearly manage your projects and part projects.

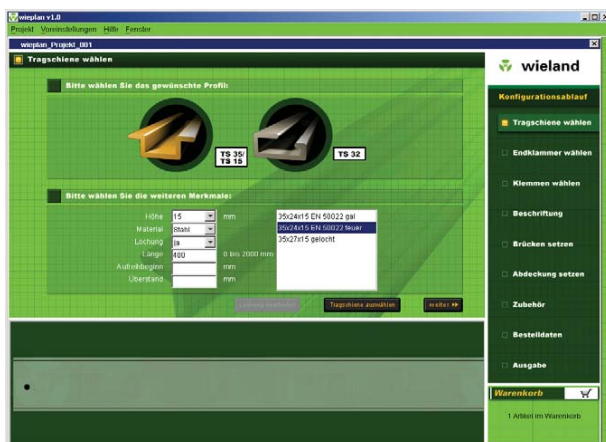

Select a mounting rail

You can select a mounting rail as per the following characteristics:

- Type / rail design
- Length
- Solid or slotted

You can also define the length of the rail section left empty in front of the block assembly and the spaces between the individual blocks.

wieplan

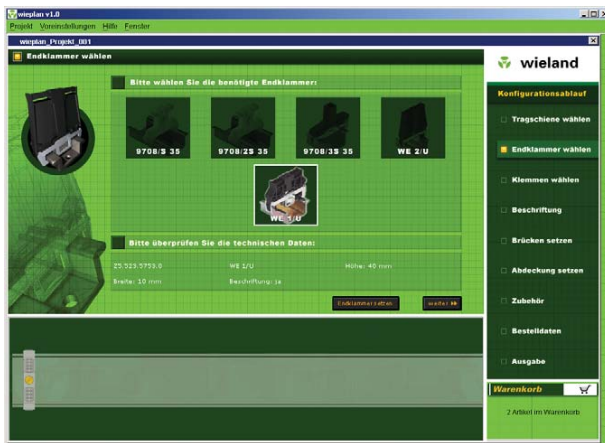

Select an end clamp

You can select the end clamp which matches your selected mounting rail.

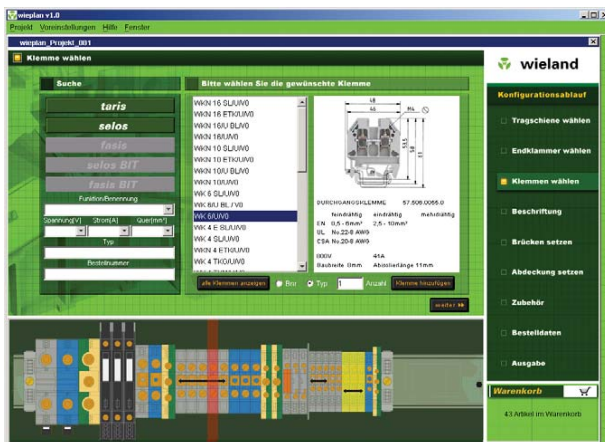

Select the terminal blocks

Intuitive selection of terminal blocks based on certain characteristics such as function, current, voltage, cross section or as per block type or part number. After composition of the terminal block assembly, the blocks can be jumpered and/or marked, and further accessories can be added. You are offered the matching accessories for each selection. Plausibility checks are made with regard to end plates, partitions, covers and more.

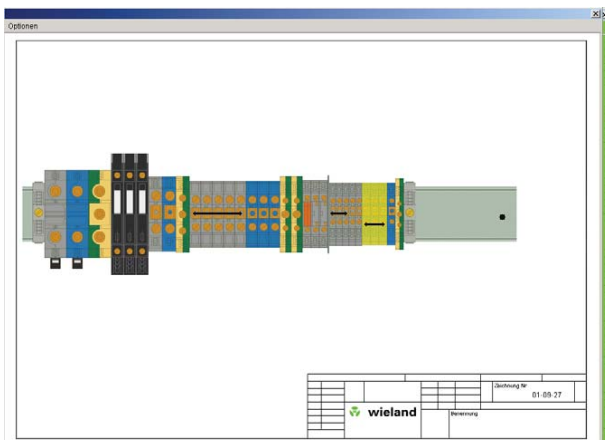

Print-out and drawing

The completed terminal block assembly can be displayed on the screen in form of a drawing, or it can be exported as a electronic file. The block assembly can also be completely mounted or individual parts can be ordered online.

DIN rail terminal blocks with spring clamp connection, type *WKF*

fasis

Spring clamp connection	0.13 to 16 mm²
Standard DIN rail terminal blocks	2.5 to 16 mm ²
Installation terminal blocks	2.5 to 16 mm ²
Duo terminal blocks	2.5/4 mm ² double/PCB
Multi-tier blocks	1.5 mm ²
Disconnect blocks	
Initiator/actuator terminal blocks	4 mm ²

fasis for TS 35

- with all required accessories
- with snap-on marking accessories
- with DQS certification
- Flammability class accord. to UL 94 V-0/V-2

All Wieland Components which require **CE** general certification are **CE** certified, and identified with the **CE** logo.

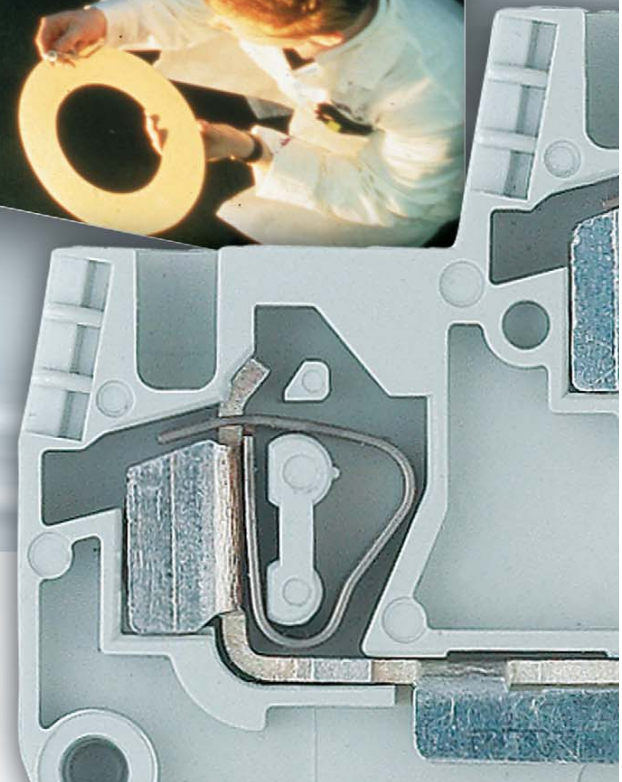
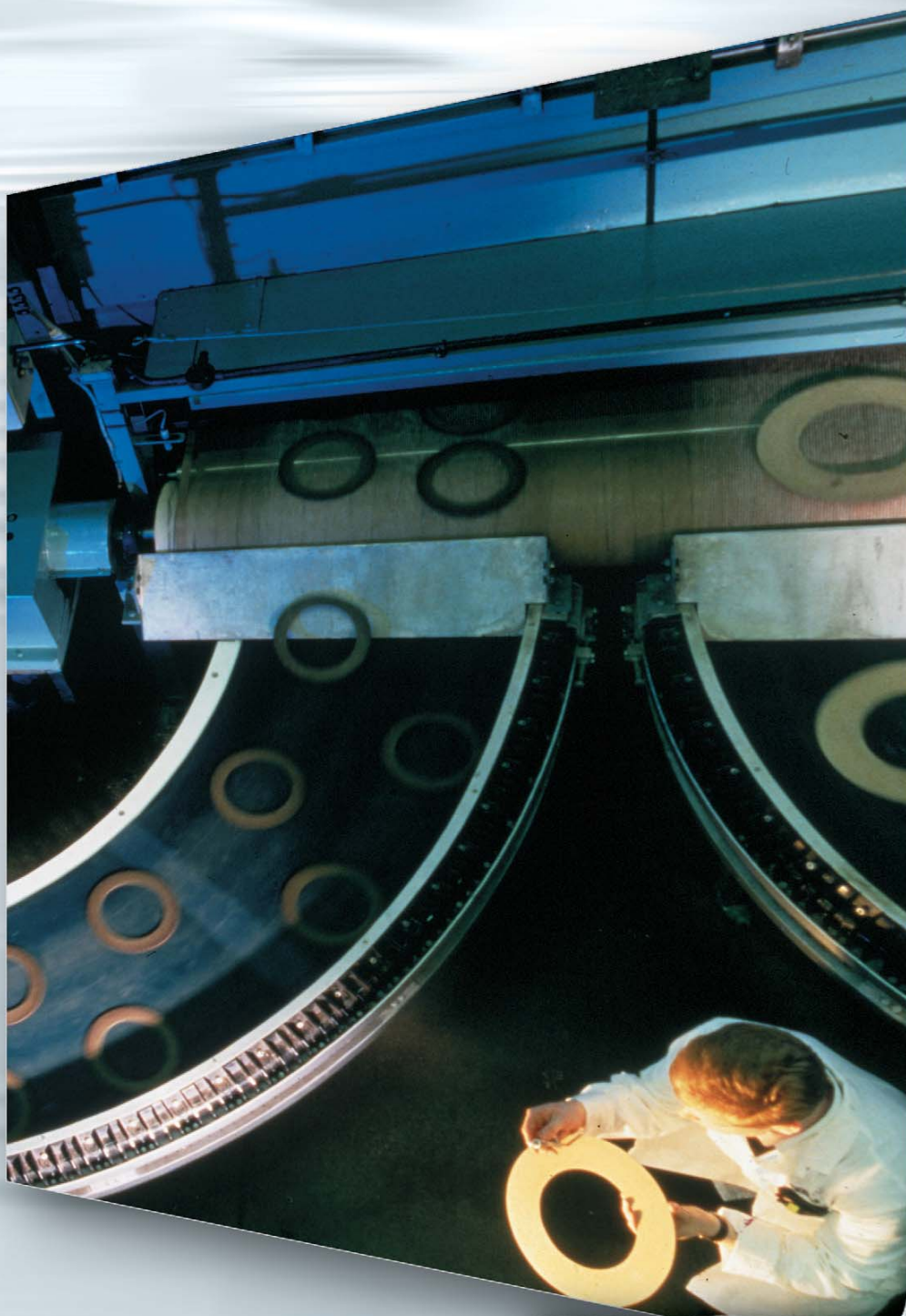

DIN Rail Terminal Blocks
with Spring Clamp Connection, Type *WKF*

DIN rail terminal blocks with spring clamp connection, type WKF

fasis

	2.5 mm ² (12 AWG)	4 mm ² (10 AWG)	6 mm ² (8 AWG)
Feed-through blocks			
Neutral feed-through blocks			
Ground blocks			

**Standard
DIN Rail Terminal Blocks**

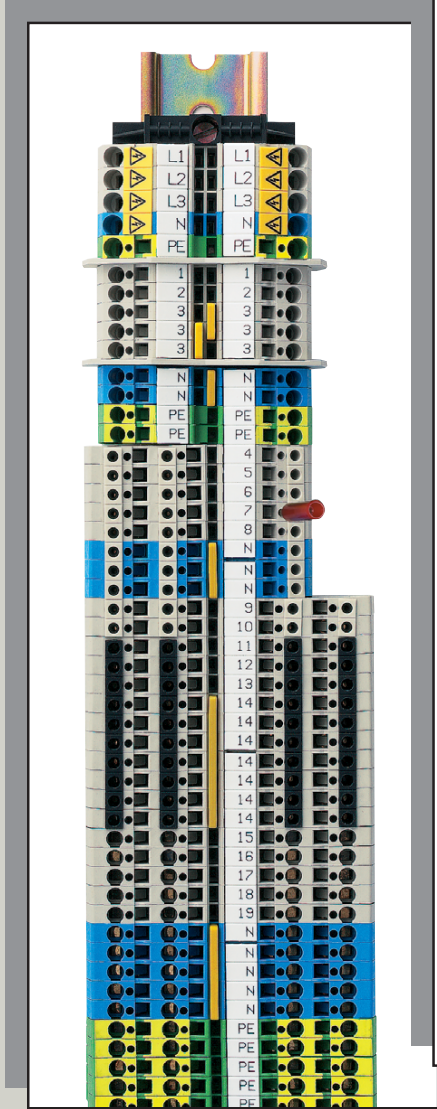

	1.5 mm ² (14 AWG)	4 mm ² (10 AWG)
Feed-through		
Branch Circuit VB		
Feed-through and Ground D/SL		
Ground		
Electronic Component Addition		
Double-tier block with pluggable connection		

Double-tier blocks

Knife edge disconnect block

Disconnect block with fuse plug

Disconnect block with diode plug



Disconnect

Feed-through blocks

Neutral disconnect blocks

Ground blocks

Sensor blocks with/without LED

<p>10 mm² (6 AWG)</p> 	<p>16 mm² (4 AWG)</p> 
--	---







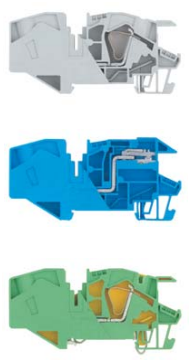





4 mm²
(10 AWG)



blocks

<p>2.5 mm² (12 AWG)</p>	<p>4 mm² (10 AWG)</p>	<p>16 mm² (4 AWG)</p>
<p>see fasis BIT Section</p>		

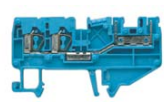
**Installation
DIN Rail Terminal Blocks**

<p>Feed-through blocks</p>	<p>2.5 mm² (12 AWG)</p> 	<p>4 mm² (10 AWG)</p> 	<p>Duo 1/2</p>
<p>Neutral feed-through</p>			
<p>Ground blocks</p>			
<p>Feed-through block</p>	<p>2.5 mm² (12 AWG)</p> 		<p>Duo 2/2</p>
<p>Duo feed-through block</p>			
<p>Neutral feed-through block</p>			
<p>Ground block</p>			
<p>Feed-through block with pluggable connection</p>			<p>Duo 2/8113</p>
<p>Neutral feed-through block with pluggable connection</p>			
<p>Ground block with pluggable connection</p>			

Duo DIN Rail Terminal Blocks

<p>KOE...</p> 	<p>KOI 3L...</p> 	<p>KOI 3L/SL...</p> 	<p>KOA 2L...</p> 
---	---	--	---

Sensor and actuator blocks

DIN rail terminal blocks with spring clamp connection, type WKF

fasis

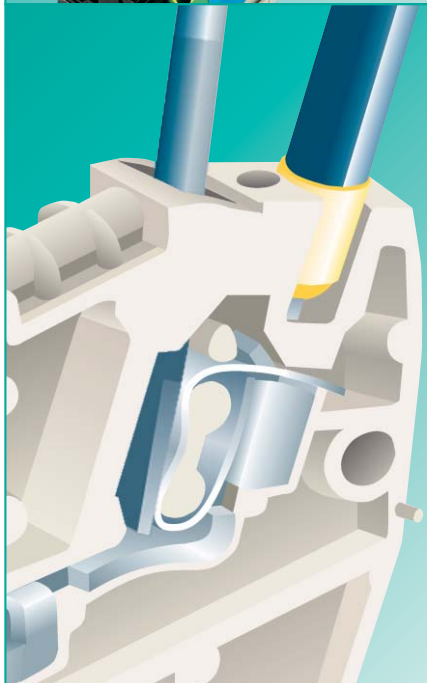
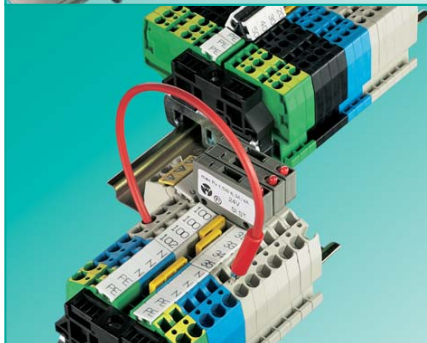
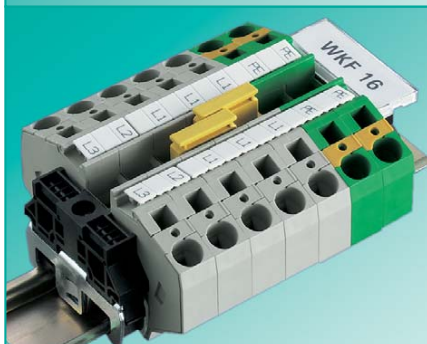
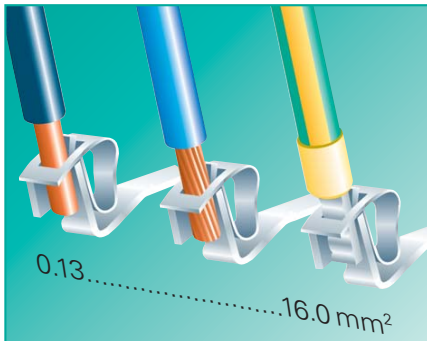

System advantages

- **Spring clamp connection,**
screwless technology

Separation of electrical and mechanical functions

- **TOP connection**

Wire entry and screwdriver access in the same plane

- **Built in test points**

Application advantages

- **Dynamic connections**
Protection of the connection against "cold flow" and creep
- **Pre-programmed clamping force**
The clamping force required to connect the wire, is created by the spring element of the clamp
- **Secure and maintenance-free electrical connection**
According to EN 60947-7-1

- **Clear and neat wiring**
In small confined spaces

- **Test points for test plugs** up to $\varnothing 2.3$ mm on all clamping points, without having to remove the connected wire

- **Connection capabilities**

The clamping bodies of the WKF series can take in any copper conductor types without ferrules

Due to the construction of the funnelled wire entry, stripped wires can be connected without fraying

- **Economic system**

- Time saving due to pluggable cross connectors in potential commoning

- **Fatigue-free handling**

- Both solid and stranded wires can be connected to WKF terminal blocks with and without ferrules

- **Tool**

For optimal operation of our WKF terminal blocks we recommend the use of the following DIN 5264 screwdrivers with cylindrical design and flat blades

→ Rated cross section

14 AWG	1.5 mm ²
12 AWG	2.5 mm ²
10 AWG	4 mm ²
8 AWG	6 mm ²
6 AWG	10 mm ²
4 AWG	16 mm ²

Blade dimensions of the screwdrivers

0.6 x 3.5 mm
0.6 x 3.5 mm
0.6 x 3.5 mm
0.8 x 4.0 mm
0.8 x 4.0 mm
1.0 x 5.5 mm

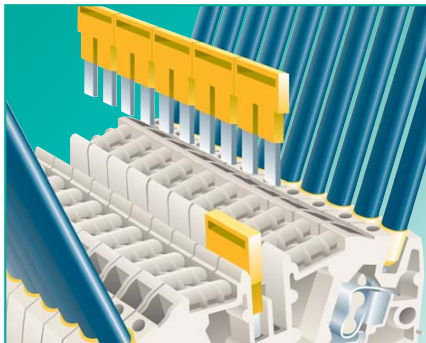

Cross connection (Jumper Bars)

- The insulated cross connectors IVB WKF... are completely touch safe
- No partition plates required between jumpered terminal groups of different potential
- The cross connectors IVB WKF... bear the same rated current as the terminal
- For modular test plugs see page 177**

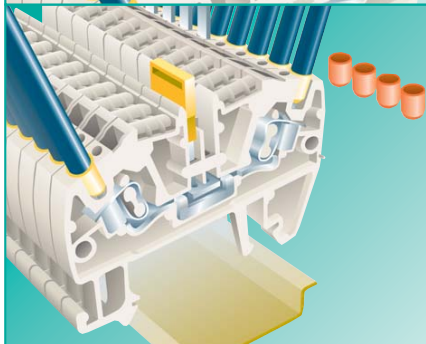

Wire entry guides

- For the connection of wires with cross sections smaller than 18 AWG, we recommend the use of wire entry guides
- Wire entry guides prevent the wires from being inserted beyond the optimal clamping point and ensures a safe and secure connection

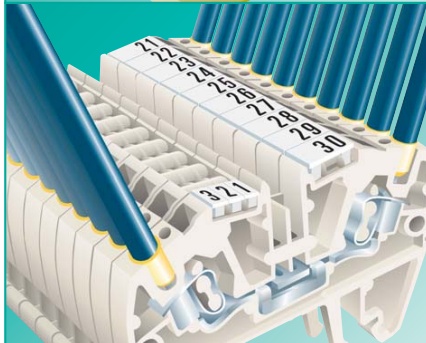

Marking systems

- Marking facility is down the center so that the marking tag is not covered by the conductor
- Single marking tag in 5, 6, or 8 mm spacing
- Marking strips (10 tags) to snap on to the terminal blocks
- Tear-off marking strips for 3-digit marking facilities per block
- Custom marking upon request

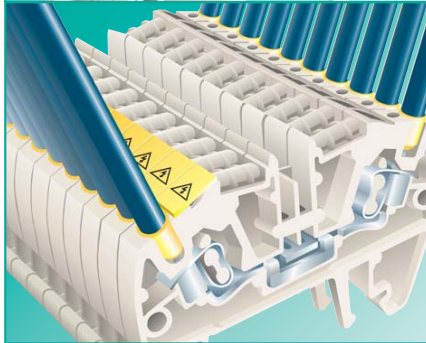

Cover with warning symbol

- Cover with warning symbol ADC to snap on to blocks which are still live after switched-off (VDE 0113)
- Cover can only be removed with a screwdriver

DQS certificates for all products

- Quality standard as per DIN ISO 9001 in Development, Production, Assembly
- Continued control of the quality standard by means of regular internal and external quality audits
- Compatible with certificates of other countries:
 - BSI Certificate, Great Britain
 - SQS Certificate, Switzerland
 - Aib-Vincotte Certificate, Belgium
 - ÖQS Certificate, Austria

Material

Metal parts

Special alloys and surface treatments provide low contact resistance and high corrosion resistance

Clamping spring: stainless CrNi steel

Current Carrying bar: tin-plated copper

Insulating material

Polyamide has excellent electrical, chemical and mechanical characteristics

Insulating housing: Polyamide 66/6

Tracking resistance: CTI 600

Flammability class:

Type WKF... UL 94 V-0

Type WKIF 16... UL 94 V-2

(see also section **facts & DATA**)

Our **wieplan** software helps to plan your DIN rail terminal block assemblies (see page 10/11).

Note

The information regarding cross-sectional areas and connection types pertains to wires without ferrules. Ferrules are not necessary for secure connection.

The voltage ratings apply to the terminals in their intended application. When different products are mounted adjacent to each other, the proper isolation distances must be adhered to. For this purpose, **Wieland** offers a large selection of appropriate accessories.

If the ground blocks of the WKF series are not used in block assemblies but are mounted to the rail as single terminal blocks, end clamps have to be used.

A detailed description of technical data, the standards requirements, and the application conditions can be found in catalogue section **facts & DATA**.



DIN Rail terminal blocks with spring clamp connection, type WKF

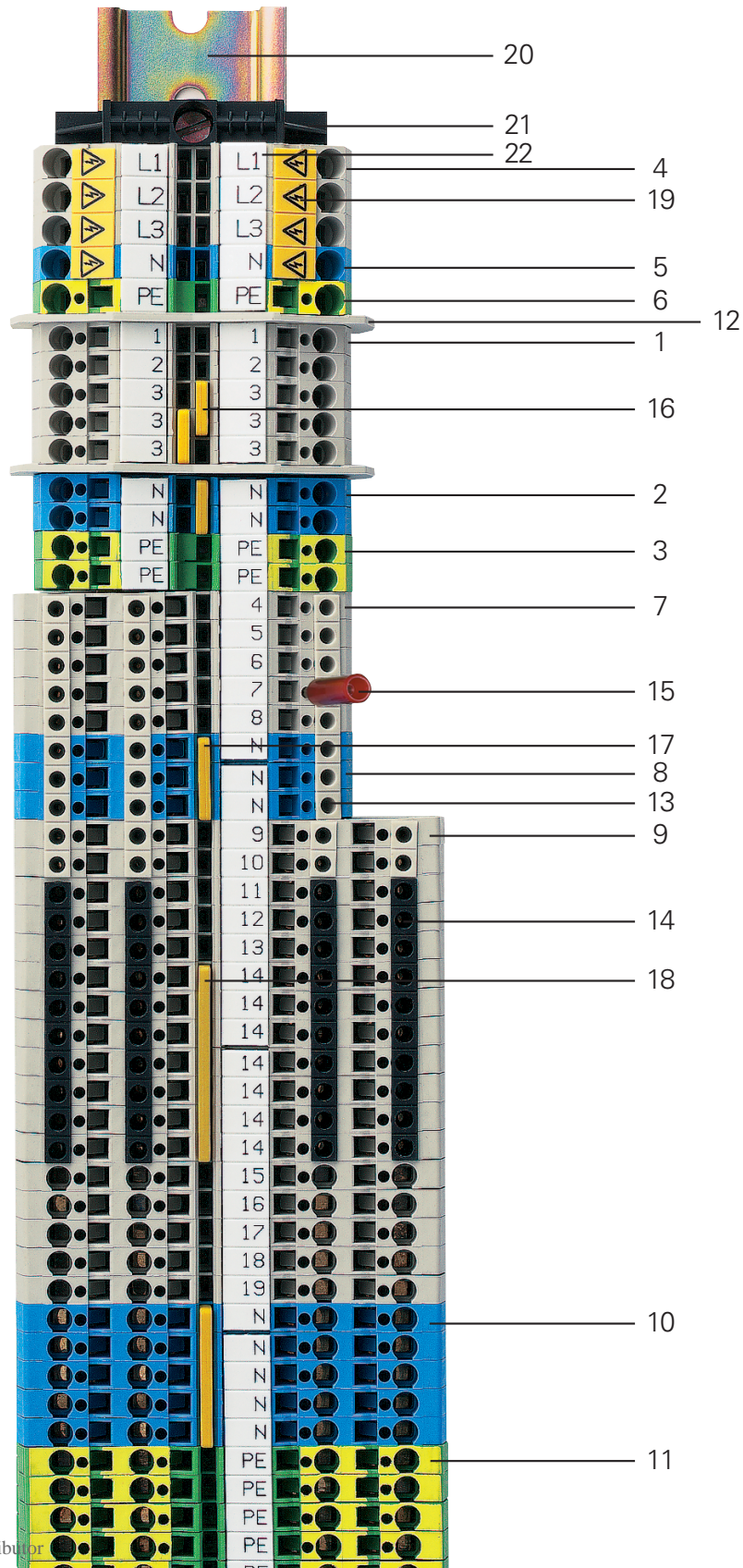

WKF sample rail

fasis

fasis

Pos.	Description	Type	Part. number
1	Feed-through block	WKF 2,5/35	56.703.0053.0
2	Feed-through block, blue	WKF 2,5/35 BLAU	56.703.0053.6
3	Ground block	WKF 2,5 SL/35	56.703.9053.0
4	Feed-through block	WKF 4/35	56.704.0053.0
5	Feed-through block, blue	WKF 4/35 BLAU	56.704.0053.6
6	Ground block	WKF 4 SL/35	56.704.9053.0
7	Duo feed-through block	WKF 2,5/D1/2/35	56.703.5053.0
8	Duo feed-through block, blue	WKF 2,5/D1/2/35 BLAU	56.703.5053.6
9	Duo feed-through block	WKF 2,5/D2/2/35	56.703.5153.0
10	Duo feed-through block, blue	WKF 2,5/D2/2/35 BLAU	56.703.5153.6
11	Duo ground block	WKF 2,5/D2/2/SL/35	56.703.9153.0
12	Partition plate	TWF 2,5-4	07.312.2253.0
13	Wire entry guide	LEL 2,5/2 GRAU	05.561.6553.0
14	Wire entry guide	LEL 2,5/3 SCHWARZ	05.561.6753.0
15	Test plug with insulated handle	WK 2,5/ST2/2,3	Z5.553.2921.0
16	Cross connector, insulated	IVB WKF 2,5-2	Z7.280.6227.0
17	Cross connector, insulated	IVB WKF 2,5-3	Z7.280.6327.0
18	Cross connector, insulated	IVB WKF 2,5-7	Z7.280.6727.0
19	Cover with warning symbol	ADF 4/4 GELB	04.343.6153.8
20	Mounting rail	35x27x7,5 gelocht	98.300.1000.0
21	End clamp	9808/2 S35	Z5.522.8553.0
22	Marking strips	9705 A/6/10 B	04.856.0453.0

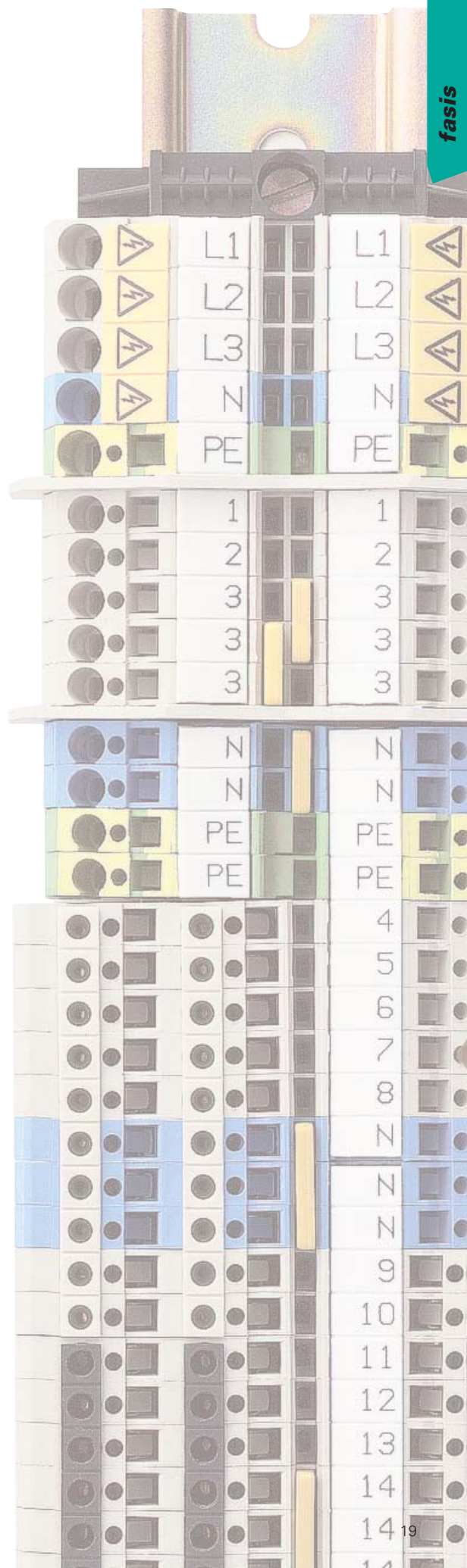

Feed-through blocks with spring clamp connection, type **WKF**

fasis

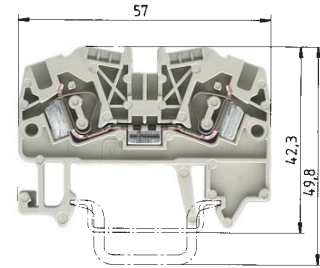
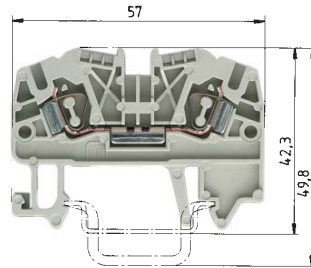

WKF 2.5/35

fine stranded solid V A
 0.13 – 2.5 mm² 0.13 – 4 mm² 800 V/8 kV/3 24
 No. 22-12 AWG 600 V 20/30
 No. 24-12 AWG 600 V 25
 5 mm 11 mm



WKF 4/35

fine stranded solid V A
 0.13 – 4 mm² 0.13 – 6 mm² 800 V/8 kV/3 32
 No. 22-10 AWG 600 V 20/30
 No. 22-10 AWG 600 V 35
 6 mm 11 mm

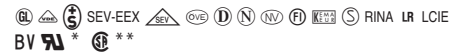

EN 60 947-7-1/DIN VDE 0611 T1
 UL ratings field/factory wiring
 CSA ratings
 Width Wire strip length
 Approvals

		Type	Part no.	Std. pack	Type	Part no.	Std. pack
Feed-through block	Color: gray	WKF 2,5/35	56.703.0053.0	100	WKF 4/35	56.704.0053.0	100
Feed-through block	Color: blue	WKF 2,5/35 BLAU	56.703.0053.6	100	WKF 4/35 BLAU	56.704.0053.6	100
Accessories							
1. Mounting rail 35, 7.5 mm high	L = 2 m	35x27x7,5 EN 60715	98.300.0000.0	1	35x27x7,5 EN 60715	98.300.0000.0	1
Mounting rail 35, 15 mm high	L = 2 m	35x24x15 EN 60715	98.360.0000.0	1	35x24x15 EN 60715	98.360.0000.0	1
2. End clamp TS 35, with screw	8 mm wide	9708/2 S35	Z5.522.8553.0	100	9708/2 S35	Z5.522.8553.0	100
End clamp TS 35, without screw	8 mm wide	WEF 1/35	Z5.523.9353.0	100	WEF 1/35	Z5.523.9353.0	100
3. End plate	Color: gray	APF 2,5 – 4	07.312.2153.0	10	APF 2,5 – 4	07.312.2153.0	10
	Color: blue	APF 2,5 – 4 BLAU	07.312.2153.6	10	APF 2,5 – 4 BLAU	07.312.2153.6	10
4. Partition plate	Color: gray	TWF 2,5 – 4	07.312.2253.0	10	TWF 2,5 – 4	07.312.2253.0	10
	Color: blue	TWF 2,5 – 4 BLAU	07.312.2253.6	10	TWF 2,5 – 4 BLAU	07.312.2253.6	10
5. Cross connector	2pole	IVB WKF 2,5 – 2	Z7.280.6227.0	10	IVB WKF 4 – 2	Z7.261.1227.0	10
insulated (jumper bar)	3pole	IVB WKF 2,5 – 3	Z7.280.6327.0	10	IVB WKF 4 – 3	Z7.261.1327.0	10
	4pole	IVB WKF 2,5 – 4	Z7.280.6427.0	10	IVB WKF 4 – 4	Z7.261.1427.0	10
	5pole	IVB WKF 2,5 – 5	Z7.280.6527.0	10	IVB WKF 4 – 5	Z7.261.1527.0	10
	6pole	IVB WKF 2,5 – 6	Z7.280.6627.0	10	IVB WKF 4 – 6	Z7.261.1627.0	10
	7pole	IVB WKF 2,5 – 7	Z7.280.6727.0	20	IVB WKF 4 – 7	Z7.261.1727.0	20
	8pole	IVB WKF 2,5 – 8	Z7.280.6827.0	20	IVB WKF 4 – 8	Z7.261.1827.0	20
	9pole	IVB WKF 2,5 – 9	Z7.280.6927.0	20	IVB WKF 4 – 9	Z7.261.1927.0	20
	10pole	IVB WKF 2,5 – 10	Z7.280.7027.0	20	IVB WKF 4 – 10	Z7.261.2027.0	20
6. Wire entry guide	0.13 – 0.2 mm ²	LEL 2,5/1 WEISS	05.561.6553.0	100	LEL 4/1 WEISS	05.561.8553.0	100
	0.25 – 0.5 mm ²	LEL 2,5/2 GRAU	05.561.6653.0	100	LEL 4/2 GRAU	05.561.8653.0	100
	0.75 – 1.0 mm ²	LEL 2,5/3 SCHWARZ	05.561.6753.0	100	LEL 4/3 SCHWARZ	05.561.8753.0	100
7. Cover with warning symbol over 4 blocks		ADF 2,5/4 GELB	04.343.6053.8	10	ADF 4/4 GELB	04.343.6153.8	10
8. Screwdriver, uninsulated (jumper bar)		DIN 5264 B 0,6x3,5	06.502.4000.0	5	DIN 5264 B 0,6x3,5	06.502.4000.0	5
9. Test plug with spring connection		PSWKC/F	Z1.299.9753.0		PSWKC/F	Z1.299.9753.0	
End plate / spacer		ZP/APPS	07.312.6053.0		ZP/APPS	07.312.6053.0	
Blank module for staggered testing			01.299.9753.0			01.299.9753.0	
*) End plate required for each test plug to achieve							
6 mm pitch		* CL I, ZN1, AExe II			* CL I, ZN1, AExe II		
Marking accessories see page 48/49 and page 90/91		**CL I, ZN1, Exe II			**CL I, ZN1, Exe II		

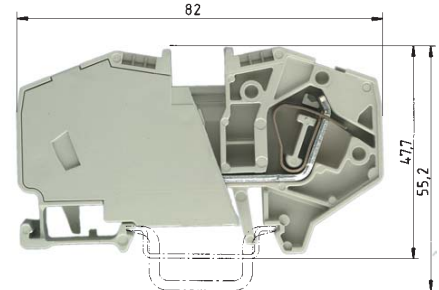
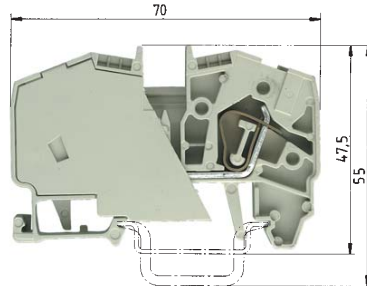
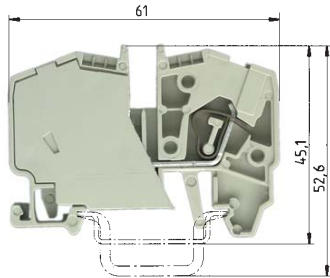

WKF 6/35

fine stranded	solid	V	A
0.5 – 6 mm ²	0.5 – 6 mm ²	800 V/8 kV/3	41
No. 20-8 AWG		600 V	40
No. 20-8 AWG		600 V	47
8 mm			12 mm



WKF 10/35

fine stranded	solid	V	A
2.5 – 10 mm ²	2.5 – 10 mm ²	800 V/8 kV/3	57
No. 14-6 AWG		600 V	55
No. 14-6 AWG		600 V	65
10 mm			13 mm



WKF 16/35

fine stranded	stranded	V	A
4 – 16 mm ²	4 – 16 mm ²	800 V/8 kV/3	76
No. 12-4 AWG		600 V	75
No. 12-4 AWG		600 V	78
12 mm			15 mm



Type	Part no.	Std. pack	Type	Part no.	Std. pack	Type	Part no.	Std. pack
WKF 6/35	56.706.0053.0	100	WKF 10/35	56.710.0053.0	50	WKF 16/35	56.716.0053.0	50
WKF 6/35 BLAU	56.706.0053.6	100	WKF 10/35 BLAU	56.710.0053.6	50	WKF 16/35 BLAU	56.716.0053.6	50
35x27x7,5 EN 60715	98.300.0000.0	1	35x27x7,5 EN 60715	98.300.0000.0	1	35x27x7,5 EN 60715	98.300.0000.0	1
35x24x15 EN 60715	98.360.0000.0	1	35x24x15 EN 60715	98.360.0000.0	1	35x24x15 EN 60715	98.360.0000.0	1
9708/2 S35	Z5.522.8553.0	100	9708/2 S35	Z5.522.8553.0	100	9708/2 S35	Z5.522.8553.0	100
WEF 1/35	Z5.523.9353.0	100	WEF 1/35	Z5.523.9353.0	100	WEF 1/35	Z5.523.9353.0	100
IVB WKF 6 – 2	Z7.282.4227.0	10	IVB WKF 10 – 2	Z7.283.8227.0	10	IVB WKF 16 – 2	Z7.284.4227.0	10
ADF 6/4 GELB	04.343.6253.8	10	ADF 10/4 GELB	04.343.6453.8	10	ADF 16/4 GELB	04.343.6653.8	10
DIN 5264 B 0,8x4	06.502.4100.0	5	DIN 5264 B 0,8x4	06.502.4100.0	5	DIN 5264 B 1x5,5	06.502.4200.0	5
PSWKC/F	Z1.299.9753.0		PSWKC/F	Z1.299.9753.0		PSWKC/F	Z1.299.9753.0	
ZP/APPS	07.312.6053.0		ZP/APPS	07.312.6053.0		ZP/APPS	07.312.6053.0	
	01.299.9753.0			01.299.9753.0			01.299.9753.0	
* CL I, ZN1, AExe II			* CL I, ZN1, AExe II			* CL I, ZN1, AExe II		
**CL I, ZN1, Exe II			**CL I, ZN1, Exe II			**CL I, ZN1, Exe II		

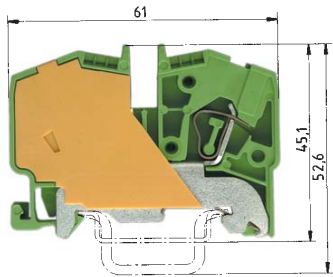

Current carrying capabilities of the mounting rails see catalogue section **facts & DATA**

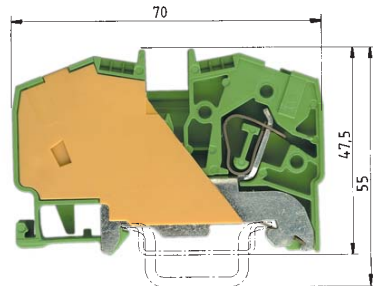

Current carrying capabilities of the mounting rails see catalogue section **facts & DATA**

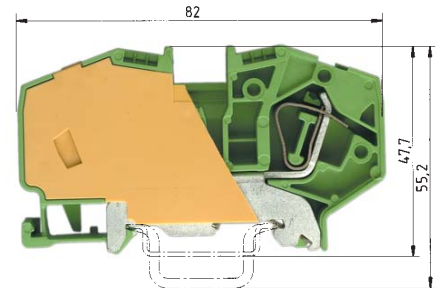

Current carrying capabilities of the mounting rails see catalogue section **facts & DATA**

WKF 6 SL/35

fine stranded	solid	V	A
0.5 – 6 mm ²	0.5 – 6 mm ²	800 V/8 kV/3	41
No. 20-8 AWG		600 V	
No. 20-8 AWG		600 V	
8 mm			12 mm

WKF 10 SL/35

fine stranded	solid	V	A
2.5 – 10 mm ²	2.5 – 10 mm ²	800 V/8 kV/3	57
No. 14-6 AWG		600 V	
No. 14-6 AWG		600 V	
10 mm			13 mm

WKF 16 SL/35

fine stranded	stranded	V	A
4 – 16 mm ²	4 – 16 mm ²	800 V/8 kV/3	76
No. 12-4 AWG		600 V	
No. 12-4 AWG		600 V	
12 mm			15 mm

Type	Part no.	Std. pack	Type	Part no.	Std. pack	Type	Part no.	Std. pack
WKF 6 SL/35	56.706.9053.0	100	WKF 10 SL/35	56.710.9053.0	50	WKF 16 SL/35	56.716.9053.0	50
35x27x7,5 EN 60715	98.300.0000.0	1	35x27x7,5 EN 60715	98.300.0000.0	1	35x27x7,5 EN 60715	98.300.0000.0	1
35x24x15 EN 60715	98.360.0000.0	1	35x24x15 EN 60715	98.360.0000.0	1	35x24x15 EN 60715	98.360.0000.0	1
9708/2 S35	Z5.522.8553.0	100	9708/2 S35	Z5.522.8553.0	100	9708/2 S35	Z5.522.8553.0	100
WEF 1/35	Z5.523.9353.0	100	WEF 1/35	Z5.523.9353.0	100	WEF 1/35	Z5.523.9353.0	100
DIN 5264 B 0,8x4	06.502.4100.0	5	DIN 5264 B 0,8x4	06.502.4100.0	5	DIN 5264 B 1x5,5	06.502.4200.0	5
* CL I, ZN1, AExe II			* CL I, ZN1, AExe II			* CL I, ZN1, AExe II		
**CL I, ZN1, Exe II			**CL I, ZN1, Exe II			**CL I, ZN1, Exe II		
Please see note on page 17!			Please see note on page 17!			Please see note on page 17!		

Neutral disconnect blocks with spring clamp connection, type **WKF**

fasis

Combination with
Feed-through block WKF 4/35
ground block WKF 4 SL/35

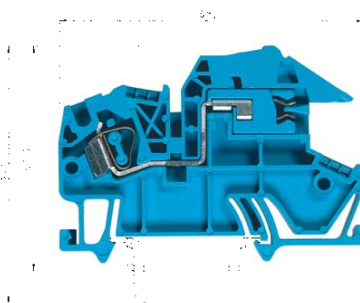

WKF 4 NT/35

EN 60 947-7-1; 1991/DIN VDE 0611 T1/08.92	fine stranded	solid	V	A
UL ratings	0.13 – 4 mm ²	0.13 – 6 mm ²	400 V/6 kV/3	30
CSA ratings	No. 22-10 AWG		600 V	25
Width	6 mm			11 mm
Approvals	Wire strip length			

		Type	Part no.	Std. pack	
Feed-through block	Color: gray				
Feed-through block	Color: blue				
Neutralleiter-Trennklemme	Color: blue	WKF 4 NT/35	56.704.8153.0	100	
Ground block	Color: green/yellow				
Accessories					
1. Mounting rail 35, 7.5 mm high	L = 2 m	35x27x7,5 EN 60715	98.300.0000.0	1	
Mounting rail 35, 15 mm high	L = 2 m	35x24x15 EN 60715	98.360.0000.0	1	
2. End clamp TS 35, with screw	8 mm wide	9708/2 S35	Z5.522.8553.0	100	
End clamp TS 35, without screw	8 mm wide	WEF 1/35	Z5.523.9353.0	100	
3. End plate	Color: gray				
	Color: blue	APF 4 NT	07.312.6053.0	10	
4. Partition plate					
5. Cross connector	2pole	IVB WKF 4 – 2	Z7.261.1227.0	10	
insulated (jumper bar)	3pole	IVB WKF 4 – 3	Z7.261.1327.0	10	
	4pole	IVB WKF 4 – 4	Z7.261.1427.0	10	
	5pole	IVB WKF 4 – 5	Z7.261.1527.0	10	
	6pole	IVB WKF 4 – 6	Z7.261.1627.0	10	
	7pole	IVB WKF 4 – 7	Z7.261.1727.0	20	
	8pole	IVB WKF 4 – 8	Z7.261.1827.0	20	
	9pole	IVB WKF 4 – 9	Z7.261.1927.0	20	
	10pole	IVB WKF 4 – 10	Z7.261.2027.0	20	
6. Wire entry guide	0.13 – 0.2 mm ²	LEL 4/1 WEISS	05.561.8553.0	100	
	0.25 – 0.5 mm ²	LEL 4/2 GRAU	05.561.8653.0	100	
	0.75 – 1.0 mm ²	LEL 4/3 SCHWARZ	05.561.8753.0	100	
7. Cover with warning symbol over 4 blocks		ADF 4/4 GELB	04.343.6153.8	10	
8. Bus bar, E-Cu 10 x 3 mm, tin-plated	L = 1 m	9813 M SN	98.290.1000.0	1	
9. Connector clamp for bus bar	8.5 mm wide	WAK 16/2 BLAU	30.494.3021.6	100	
	17 mm wide	WAK 35/2	30.494.4121.0	50	
10. Bus bar support	8 mm wide	WKIF SH/E/35	Z1.108.8453.0	10	
11. Screwdriver uninsulated (jumper bar)		DIN 5264 B 0,6x3,5	06.502.4000.0	5	
Marking accessories see page 48/49 and page 90/91					

Supply blocks for junction box with spring clamp connection, type **WKIF**

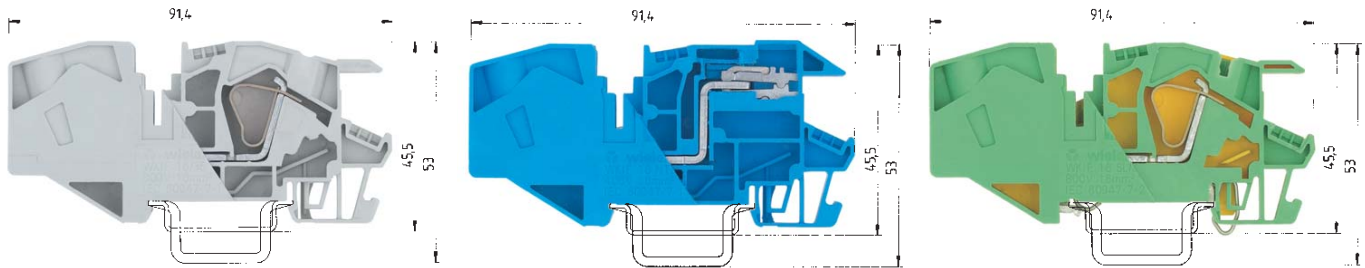

WKIF 16/35

fine stranded stranded V A
4 – 16 mm² 4 – 16 mm² 800 V/8 kV/3 76

12 mm

16 mm

WKIF 16 NT/35

fine stranded stranded V A
4 – 16 mm² 4 – 16 mm² 400 V/6 kV/3 68

12 mm

16 mm

WKIF 16 SL/35

fine stranded stranded V A
4 – 16 mm² 4 – 16 mm² 800 V/8 kV/3 76

12 mm

16 mm

Type	Part no.	Std. pack	Type	Part no.	Std. pack	Type	Part no.	Std. pack
WKIF 16/35	56.716.1153.0	50						
WKIF 16/35 BLAU	56.716.1153.6	50						
			WKIF 16 NT/35	56.716.8153.0	50			
						WKIF 16 SL/35	56.716.9153.0	50
35x27x7,5 EN 60715	98.300.0000.0	1	35x27x7,5 EN 60715	98.300.0000.0	1	35x27x7,5 EN 60715	98.300.0000.0	1
35x24x15 EN 60715	98.360.0000.0	1	35x24x15 EN 60715	98.360.0000.0	1	35x24x15 EN 60715	98.360.0000.0	1
9708/2 S35	Z5.522.8553.0	100	9708/2 S35	Z5.522.8553.0	100	9708/2 S35	Z5.522.8553.0	100
			WEF 1/35	Z5.523.9353.0	100			
IVB WKIF 16 – 2	Z7.284.6227.0	10	IVB WKIF 16 – 2	Z7.284.6227.0	10	IVB WKIF 16 – 2	Z7.284.6227.0	10
9813 M SN	98.290.1000.0	1	9813 M SN	98.290.1000.0	1	9813 M SN	98.290.1000.0	1
WAK 16/2 BLAU	30.494.3021.6	100	WAK 16/2 BLAU	30.494.3021.6	100	WAK 16/2 BLAU	30.494.3021.6	100
WAK 35/2	30.494.4121.0	50	WAK 35/2	30.494.4121.0	50	WAK 35/2	30.494.4121.0	50
WKIF SH/E/35	Z1.108.8453.0	10	WKIF SH/E/35	Z1.108.8453.0	10	WKIF SH/E/35	Z1.108.8453.0	10
DIN 5264 B 1x5	06.502.4200.0	5	DIN 5264 B 1x5	06.502.4200.0	5	DIN 5264 B 1x5	06.502.4200.0	5

Duo-feed-through blocks with spring clamp connection, type WKF

fasis

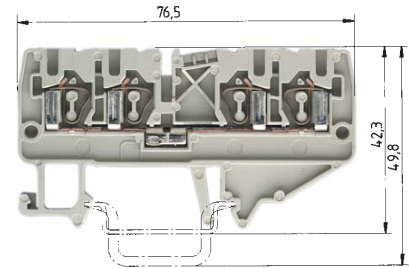
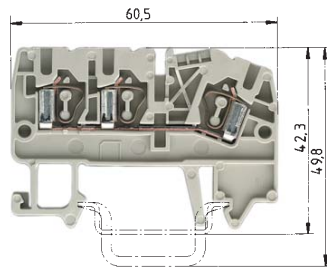

WKF 2.5 D1/2/35

fine stranded solid V A
 0.13 – 2.5 mm² 0.5 – 4 mm² 800 V/8 kV/3 24
 No. 22-12 AWG 600 V 20/30
 No. 24-12 AWG 600 V 25
 5 mm 11 mm

SEV-EEX SEV GVB I N NV FI KEMA S RINA LR
 LCIE BV * **

WKF 2.5 D2/2/35

fine stranded solid V A
 0.13 – 2.5 mm² 0.5 – 4 mm² 800 V/8 kV/3 24
 No. 22-12 AWG 600 V 20/30
 No. 24-12 AWG 600 V 25
 5 mm 11 mm

SEV-EEX SEV GVB I N NV FI KEMA S RINA LR
 LCIE BV * **

EN 60 947-7-1/DIN VDE 0611 T1
 UL ratings field/factory wiring
 CSA ratings
 Width Wire strip length
 Approvals

		Type	Part no.	Std. pack	Type	Part no.	Std. pack	
Duo feed-through block 1/2	Color: gray	WKF 2,5/D1/2/35	56.703.5053.0	100				
	Color: blue	WKF 2,5/D1/2/35 BLAU	56.703.5053.6	100				
Duo feed-through block 2/2	Color: gray				WKF 2,5/D2/2/35	56.703.5153.0	100	
	Color: blue				WKF 2,5/D2/2/35 BLAU	56.703.5153.6	100	
Double feed-through block	Color: black							
Accessories								
1. Mounting rail 35, 7.5 high	L = 2 m	35x27x7,5 EN 60715	98.300.0000.0	1	35x27x7,5 EN 60715	98.300.0000.0	1	
	L = 2 m	35x24x15 EN 60715	98.360.0000.0	1	35x24x15 EN 60715	98.360.0000.0	1	
2. End clamp TS 35, with screw	8 mm wide	9708/2 S35	Z5.522.8553.0	100	9708/2 S35	Z5.522.8553.0	100	
	8 mm wide	WEF 1/35	Z5.523.9353.0	100	WEF 1/35	Z5.523.9353.0	100	
3. End plate	Color: gray	APF 2,5 /D1/2	07.312.2353.0	10	APF 2,5 /D2/2	07.312.2553.0	10	
	Color: blue	APF 2,5/D1/2 BLAU	07.312.2353.6	10	APF 2,5/D2/2 BLAU	07.312.2553.6	10	
4. Partition plate	Color: gray	TWF 2,5/D1/2	07.312.2453.0	10	TWF 2,5/D2/2	07.312.2653.0	10	
	Color: blue	TWF 2,5/D1/2 BLAU	07.312.2453.6	10	TWF 2,5/D2/2 BLAU	07.312.2653.6	10	
5. Cross connector	2pole	IVB WKF 2,5 – 2	Z7.280.6227.0	10	IVB WKF 2,5 – 2	Z7.280.6227.0	10	
	insulated (jumper bar)	3pole	IVB WKF 2,5 – 3	Z7.280.6327.0	10	IVB WKF 2,5 – 3	Z7.280.6327.0	10
		4pole	IVB WKF 2,5 – 4	Z7.280.6427.0	10	IVB WKF 2,5 – 4	Z7.280.6427.0	10
	5pole	IVB WKF 2,5 – 5	Z7.280.6527.0	10	IVB WKF 2,5 – 5	Z7.280.6527.0	10	
	6pole	IVB WKF 2,5 – 6	Z7.280.6627.0	10	IVB WKF 2,5 – 6	Z7.280.6627.0	10	
	7pole	IVB WKF 2,5 – 7	Z7.280.6727.0	20	IVB WKF 2,5 – 7	Z7.280.6727.0	20	
	8pole	IVB WKF 2,5 – 8	Z7.280.6827.0	20	IVB WKF 2,5 – 8	Z7.280.6827.0	20	
6. Wire entry guide	0.13 – 0.2 mm ²	LEL 2,5/1 WEISS	05.561.6553.0	100	LEL 2,5/1 WEISS	05.561.6553.0	100	
	0.25 – 0.5 mm ²	LEL 2,5/2 GRAU	05.561.6653.0	100	LEL 2,5/2 GRAU	05.561.6653.0	100	
	0.75 – 1.0 mm ²	LEL 2,5/3 SCHWARZ	05.561.6753.0	100	LEL 2,5/3 SCHWARZ	05.561.6753.0	100	
7. Cover with warning symbol over 4 blocks		ADF 2,5/4 GELB	04.343.6053.8	10	ADF 2,5/4 GELB	04.343.6053.8	10	
8. Screwdriver, uninsulated (jumper bar)		DIN 5264 B 0,6x3,5	06.502.4000.0	5	DIN 5264 B 0,6x3,5	06.502.4000.0	5	
9. Test plug with spring connection		PSWKC/F	Z1.299.9753.0		PSWKC/F	Z1.299.9753.0		
	End plate / spacer	ZP/APPS	07.312.6053.0		ZP/APPS	07.312.6053.0		
	Blank module for staggered testing		01.299.9753.0			01.299.9753.0		
Marking accessories see page 48/49 and page 90/91		* CL I, ZN1, AExe II / **CL I, ZN1, Exe II			* CL I, ZN1, AExe II / **CL I, ZN1, Exe II			

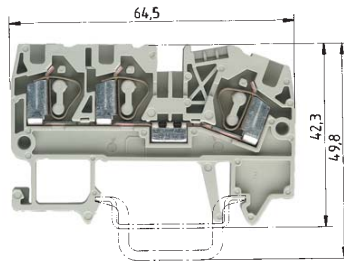
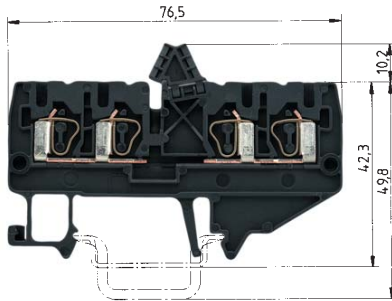

WKF 2.5 D/D/35

fine stranded solid V A
 0.13 – 2.5 mm² 0.5 – 4 mm² 800 V/8 kV/3 24
 No. 22-12 AWG 600 V 20/30
 No. 24-12 AWG 600 V 25
 5 mm 11 mm

WKF 4 D1/2/35

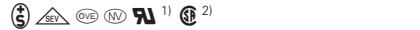
fine stranded solid V A
 0.13 – 4 mm² 0.5 – 6 mm² 800 V/8 kV/3 32
 No. 22-10 AWG 600 V 30
 No. 22-10 AWG 600 V 35
 6 mm 11 mm

Type	Part no.	Std. pack	Type	Part no.	Std. pack
			WKF 4 D1/2/35	56.704.5053.0	100
			WKF 4 D1/2/35 BLAU	56.704.5053.6	100
WKF 2,5/D/D/35	56.703.5253.0	100			
35x27x7,5 EN 60715	98.300.0000.0	1	35x27x7,5 EN 60715	98.300.0000.0	1
35x24x15 EN 60715	98.360.0000.0	1	35x24x15 EN 60715	98.360.0000.0	1
9708/2 S35	Z5.522.8553.0	100	9708/2 S35	Z5.522.8553.0	100
WEF 1/35	Z5.523.9353.0	100	WEF 1/35	Z5.523.9353.0	100
APF 2,5/D2/2	07.312.2553.0	10	APF 4/D1/2	07.312.4853.0	10
TWF 2,5/D2/2	07.312.2653.0	10	APF 4/D1/2 BLAU	07.312.4853.6	10
			TWF 4/D1/2	07.312.4953.0	10
			TWF 4/D1/2 BLAU	07.312.4953.6	10
			IVB WKF 4 – 2	Z7.261.1227.0	10
			IVB WKF 4 – 3	Z7.261.1327.0	10
			IVB WKF 4 – 4	Z7.261.1427.0	10
			IVB WKF 4 – 5	Z7.261.1527.0	10
			IVB WKF 4 – 6	Z7.261.1627.0	10
			IVB WKF 4 – 7	Z7.261.1727.0	20
			IVB WKF 4 – 8	Z7.261.1827.0	20
			IVB WKF 4 – 9	Z7.261.1927.0	20
			IVB WKF 4 – 10	Z7.261.2027.0	20
LEL 2,5/1 WEISS	05.561.6553.0	100	LEL 4/1 WEISS	05.561.8553.0	100
LEL 2,5/2 GRAU	05.561.6653.0	100	LEL 4/2 GRAU	05.561.8653.0	100
LEL 2,5/3 SCHWARZ	05.561.6753.0	100	LEL 4/3 SCHWARZ	05.561.8753.0	100
ADF 2,5/4 GELB	04.343.6053.8	10	ADF 4/4 GELB	04.343.6153.8	10
DIN 5264 B 0,6x3,5	06.502.4000.0	5	DIN 5264 B 0,6x3,5	06.502.4000.0	5
PSWKC/F	Z1.299.9753.0		PSWKC/F	Z1.299.9753.0	
ZP/APPS	07.312.6053.0		ZP/APPS	07.312.6053.0	
	01.299.9753.0			01.299.9753.0	

¹⁾ CL I, ZN1, Exe II, ²⁾ CL I, ZN1, AExe II

¹⁾ CL I, ZN1, Exe II, ²⁾ CL I, ZN1, AExe II

Double tier terminals with spring clamp connection, type WKF

fasis

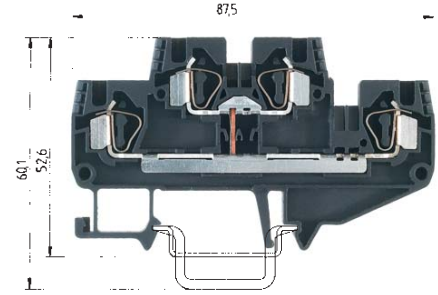
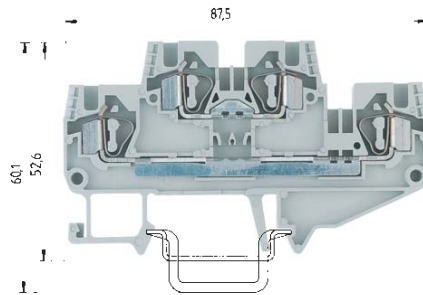

WKF 4 E/35

fine stranded solid V A
0.13 - 4 mm² 0.13 - 6 mm² 800 V/8 kV/3 32

6 mm 11 mm
 pending

WKF 4 E/VB/35

fine stranded solid V A
0.13 - 4 mm² 0.13 - 6 mm² 800 V/8 kV/3 32

6 mm 11 mm
 pending

EN 60 947-7-1
UL ratings
CSA ratings
Width
Approvals

field/factory wiring

Wire strip length

		Type	Part no.	Std. pack	Type	Part no.	Std. pack
Double Tier	Color: gray	WKF 4 E/35	56.704.7053.0	100			
Double Tier-Branch circuit	Color: black				WKF 4 E/VB/35	56.704.6953.1	100
Double Tier-Ground	Color: green/yellow						
Function Terminal	Color: red						
Function Terminal	Color: orange						
Accessories							
1. Mounting rail 35, 7.5 mm high, solid	L = 2 m	35x27x7,5 EN 60715	98.300.0000.0	1	35x27x7,5 EN 60715	98.300.0000.0	1
Mounting rail 35, 15 mm high, solid	L = 2 m	35x24x15 EN 60715	98.360.0000.0	1	35x24x15 EN 60715	98.360.0000.0	1
2. End clamp TS 35, screwmount	8 mm wide	9708/2 S35	Z5.522.8553.0	100	9708/2 S35	Z5.522.8553.0	100
End clamp TS 35, screwless	8 mm wide	WEF 1/35	Z5.523.9353.0	100	WEF 1/35	Z5.523.9353.0	100
3. End plate	1.5 mm wide	Color: gray	APF 4 E...07.312.5753.0	10	Color: gray	07.312.5753.0	10
	1.5 mm wide	Color: blue					
	1.5 mm wide	Color: green					
4. Partition plate	1.5 mm wide	Color: gray	TWF 4 E...07.312.5853.0	10	Color: gray	TWF 4 E...07.312.5853.0	10
	1.5 mm wide	Color: blue					
5. Cross connector	2pole	IVB WKF 4 - 2	Z7.261.1227.0	10	IVB WKF 4 - 2	Z7.261.1227.0	10
insulated (jumper bar)	3pole	IVB WKF 4 - 3	Z7.261.1327.0	10	IVB WKF 4 - 3	Z7.261.1327.0	10
	4pole	IVB WKF 4 - 4	Z7.261.1427.0	10	IVB WKF 4 - 4	Z7.261.1427.0	10
	5pole	IVB WKF 4 - 5	Z7.261.1527.0	10	IVB WKF 4 - 5	Z7.261.1527.0	10
	6pole	IVB WKF 4 - 6	Z7.261.1627.0	10	IVB WKF 4 - 6	Z7.261.1627.0	10
	7pole	IVB WKF 4 - 7	Z7.261.1727.0	20	IVB WKF 4 - 7	Z7.261.1727.0	20
	8pole	IVB WKF 4 - 8	Z7.261.1827.0	20	IVB WKF 4 - 8	Z7.261.1827.0	20
	9pole	IVB WKF 4 - 9	Z7.261.1927.0	20	IVB WKF 4 - 9	Z7.261.1927.0	20
	10pole	IVB WKF 4 - 10	Z7.261.2027.0	20	IVB WKF 4 - 10	Z7.261.2027.0	20
6. Vertical Jumper	1pole	IVB WKF-V*)	Z7.261.1127.0				
7. Wire entry guide	0.13 - 0.2 mm ²	LEL 4/1 WEISS	05.561.8553.0	100	LEL 4/1 WEISS	05.561.8553.0	100
	0.25 - 0.5 mm ²	LEL 4/2 GRAU	05.561.8653.0	100	LEL 4/2 GRAU	05.561.8653.0	100
	0.75 - 1.0 mm ²	LEL 4/3 SCHWARZ	05.561.8753.0	100	LEL 4/3 SCHWARZ	05.561.8753.0	100
8. Cover with warning symbol for 4 terminals		ADF 4/4 GELB	04.343.6153.8	10	ADF 4/4 GELB	04.343.6153.8	10
9. Screwdriver		DIN 5264 B 0,6x3,5	06.502.4000.0	5	DIN 5264 B 0,6x3,5	06.502.4000.0	5
Screwdriver, MINI		DIN 5264 B 0,6x3,5 M	06.502.5000.0	10	DIN 5264 B 0,6x3,5 M	06.502.5000.0	10
Marking accessories see page 48/49 and page 90/91							

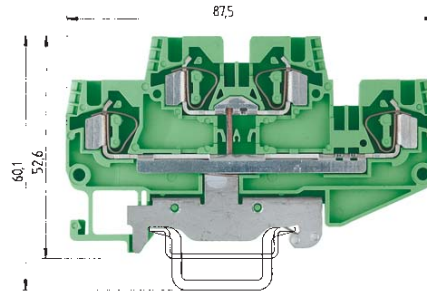
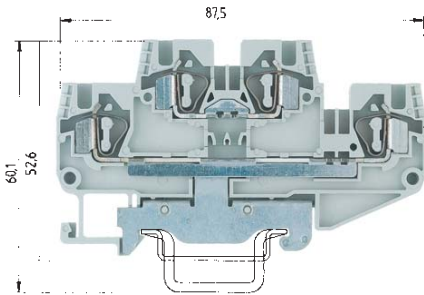

WKF 4 E /D/SL/35

fine stranded solid V A
0.13 - 4 mm² 0.13 - 6 mm² 800 V/8 kV/3 32

6 mm 11 mm
 pending

WKF 4 E SL/35

fine stranded solid V A
0.13 - 4 mm² 0.13 - 6 mm² 800 V/8 kV/3 32

6 mm 11 mm
 pending

Type	Part no.	Std. pack	Type	Part no.	Std. pack
WKF 4 E /D/SL/35	56.704.9953.0	100	WKF 4 E SL/35	56.704.9253.0	100
35x27x7,5 EN 60715	98.300.0000.0	1	35x27x7,5 EN 60715	98.300.0000.0	1
35x24x15 EN 60715	98.360.0000.0	1	35x24x15 EN 60715	98.360.0000.0	1
9708/2 S35	Z5.522.8553.0	100	9708/2 S35	Z5.522.8553.0	100
WEF 1/35	Z5.523.9353.0	100	WEF 1/35	Z5.523.9353.0	100
APF 4 E...	07.312.5753.0	10	APF 4 E...	07.312.5753.7	10
TWF 4 E...	07.312.5853.0	10			
IVB WKF 4 - 2	Z7.261.1227.0	10			
IVB WKF 4 - 3	Z7.261.1327.0	10			
IVB WKF 4 - 4	Z7.261.1427.0	10			
IVB WKF 4 - 5	Z7.261.1527.0	10			
IVB WKF 4 - 6	Z7.261.1627.0	10			
IVB WKF 4 - 7	Z7.261.1727.0	20			
IVB WKF 4 - 8	Z7.261.1827.0	20			
IVB WKF 4 - 9	Z7.261.1927.0	20			
IVB WKF 4 - 10	Z7.261.2027.0	20			
LEL 4/1 WEISS	05.561.8553.0	100	LEL 4/1 WEISS	05.561.8553.0	100
LEL 4/2 GRAU	05.561.8653.0	100	LEL 4/2 GRAU	05.561.8653.0	100
LEL 4/3 SCHWARZ	05.561.8753.0	100	LEL 4/3 SCHWARZ	05.561.8753.0	100
ADF 4/4 GELB	04.343.6153.8	10	ADF 4/4 GELB	04.343.6153.8	10
DIN 5264 B 0,6x3,5	06.502.4000.0	5	DIN 5264 B 0,6x3,5	06.502.4000.0	5
DIN 5264 B 0,6x3,5 M	06.502.5000.0	10	DIN 5264 B 0,6x3,5 M	06.502.5000.0	10

Double tier blocks with spring clamp connection, type WKF

fasis

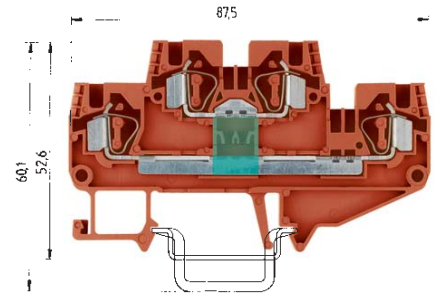
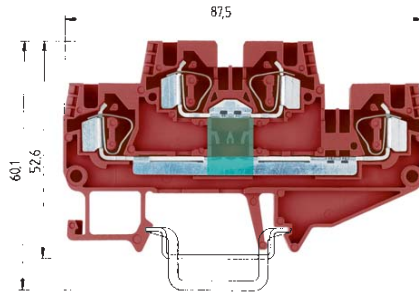

WKF 4 E /35...

fine stranded solid V A
0.13 - 4 mm² 0.13 - 6 mm²

EN 60 947-7-1
UL ratings
CSA ratings
Width
Approvals

field/factory wiring

Wire strip length

6 mm

11 mm

pending

Function Diagram

	Type	Part no.	Std. pack
Double tier block Color: gray			
Double tier-Branch circuit Color: black			
Double tier-Ground Color: green/yellow			
Function Terminal Color: red	WKF 4 E /35...	56.704.XX53.5	
Function Terminal Color: orange	WKF 4 E /35...	56.704.XX53.9	
Accessories			
1. Mounting rail 35, 7.5 mm high L = 2 m	35x27x7,5 EN 60715	98.300.0000.0	1
Mounting rail 35, 15 mm high L = 2 m	35x24x15 EN 60715	98.360.0000.0	1
2. End clamp TS 35, with screw 8 mm wide	9708/2 S35	Z5.522.8553.0	100
End clamp TS 35, without screw 8 mm wide	WEF 1/35	Z5.523.9353.0	100
3. End plate 1.5 mm wide Color: gray	APF 4 E...	07.312.5753.0	10
1.5 mm wide Color: blue			
1.5 mm wide Color: green			
4. Partition plate 1.5 mm wide Color: gray	TWF 4 E...	07.312.5853.0	10
1.5 mm wide Color: blue			
5. Cross connector 2pole	IVB WKF 4 - 2	Z7.261.1227.0	10
Insulated (jumper bar) 3pole	IVB WKF 4 - 3	Z7.261.1327.0	10
4pole	IVB WKF 4 - 4	Z7.261.1427.0	10
5pole	IVB WKF 4 - 5	Z7.261.1527.0	10
6pole	IVB WKF 4 - 6	Z7.261.1627.0	10
7pole	IVB WKF 4 - 7	Z7.261.1727.0	20
8pole	IVB WKF 4 - 8	Z7.261.1827.0	20
9pole	IVB WKF 4 - 9	Z7.261.1927.0	20
10pole	IVB WKF 4 - 10	Z7.261.2027.0	20
6. Vertical Jumper 1pole			
7. Wire entry guide 0.13 - 0.2 mm ²	LEL 4/1 WEISS	05.561.8553.0	100
0.25 - 0.5 mm ²	LEL 4/2 GRAU	05.561.8653.0	100
0.75 - 1.0 mm ²	LEL 4/3 SCHWARZ	05.561.8753.0	100
8. Cover with warning symbol over 4 blocks	ADF 4/4 GELB	04.343.6153.8	10
9. Screwdriver, uninsulated (jumper bar)	DIN 5264 B 0,6x3,5	06.502.4000.0	5
Screwdriver, uninsulated (jumper bar), MINI	DIN 5264 B 0,6x3,5 M	06.502.5000.0	10
Marking accessories see page 48/49 and page 90/91			

56.704.7553.9

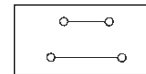

56.704.7553.5



56.704.7153.5



56.704.7153.9



56.704.8053.9

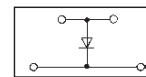

I = 1 A
U = 1000 V

56.704.8253.5

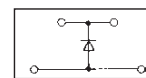

I = 1 A
U = 1000 V

56.704.7953.5

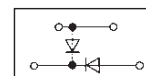

I = 1 A
U = 1000 V

56.704.8353.5

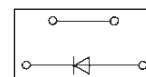

I = 1 A
U = 1000 V

56.704.7453.9

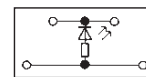

LED red

R = 4.7 KΩ
P = 0.5 W
U = 24 V DC

56.704.7253.5

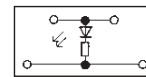

LED red

R = 4.7 KΩ
P = 0.5 W
U = 24 V DC

56.704.7353.5

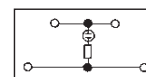

R = 680 KΩ
P = 0.25 W
U = 100-500 V

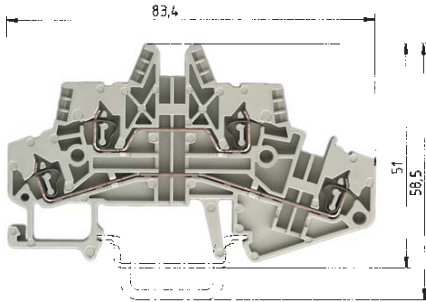

WKF 1.5 E/35

fine stranded solid V A
 0.13 – 1.5 mm² 0.13 – 2.5 mm² 400 V/6 kV/3 17.5
 30-14 AWG 300 V 15 A
 CSA No. 28-14 AWG 600 V 20 A
 5 mm 8 mm

UL * CE **

Type	Part no.	Std. pack
WKF 1,5 E/35	56.702.7053.0	100
35x27x7,5 EN 60715	98.300.0000.0	1
35x24x15 EN 60715	98.360.0000.0	1
9708/2 S35	Z5.522.8553.0	100
WEF 1/35	Z5.523.9353.0	100
APF 1,5 E	07.312.3553.0	10
TWF 1,5 E	07.312.3653.0	10
IVB WKF 2,5 – 2	Z7.280.6227.0	10
IVB WKF 2,5 – 3	Z7.280.6327.0	10
IVB WKF 2,5 – 4	Z7.280.6427.0	10
IVB WKF 2,5 – 5	Z7.280.6527.0	10
IVB WKF 2,5 – 6	Z7.280.6627.0	10
IVB WKF 2,5 – 7	Z7.280.6727.0	20
IVB WKF 2,5 – 8	Z7.280.6827.0	20
IVB WKF 2,5 – 9	Z7.280.6927.0	20
IVB WKF 2,5 – 10	Z7.280.7027.0	20
IVB WKFC-V*)	Z7.261.1127.0	
LEL 1,5/1 WEISS	05.562.2453.0	100
LEL 1,5/2 GRAU	05.562.2553.0	100
LEL 1,5/3 SCHWARZ	05.562.2653.0	100
ADF 1,5/4 GELB	04.343.8353.8	10
DIN 5264 B 0,6x3,5	06.502.4000.0	5
DIN 5264 B 0,6x3,5 M	06.502.5000.0	10
* CL I, ZN1, AExe II		
**CL I, ZN1, Exe II		

DIN rail terminal blocks with spring clamp connection and pluggable connections

fasis

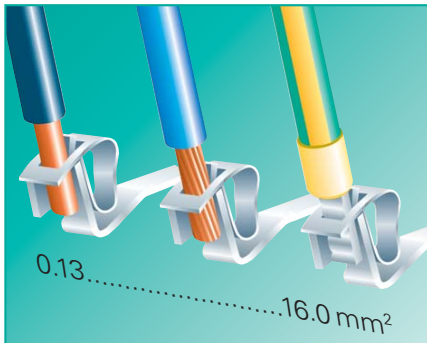

System advantages

- Spring clamp connection,** screwless technology

Separation of electrical and mechanical functions

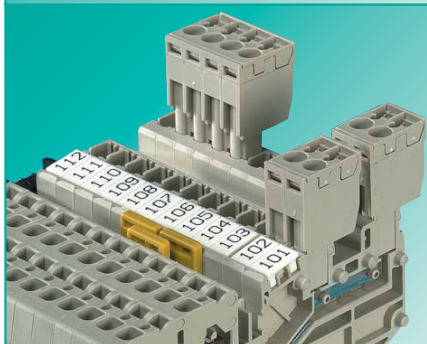

- TOP connection**

Wire entry and screwdriver access in same plane

- Built in Test Points**

- Preassembled modules**

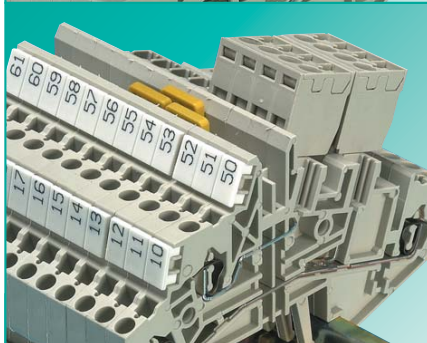

- Pluggable wiring inside the control cabinet**

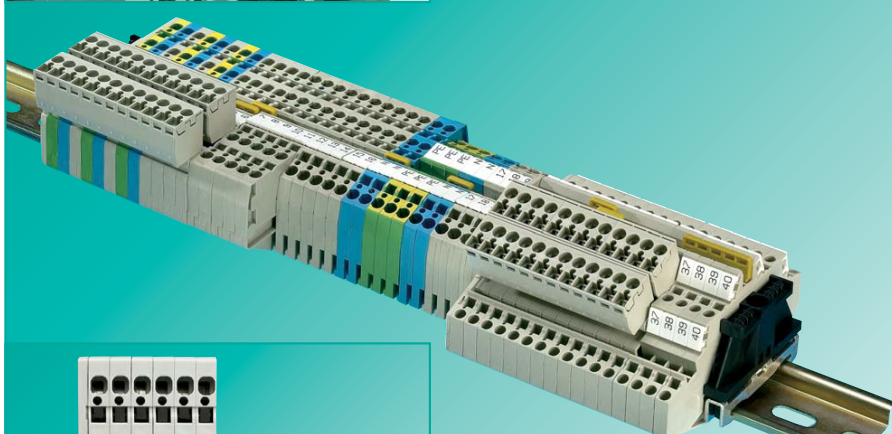

- Touch safe**

- Safety through coding**

Application advantages

- **Dynamic connections**

Protection of the connection against "cold flow" and creep

- **Pre-programmed clamping force**

The clamping force required to connect the wire, is created by the spring elements of the clamp

- **Secure and maintenance-free electrical connection**

According to EN 60947-7-1

- **Clear wiring**

In small confined spaces

- **Test points for test plugs** up to

Ø 2.3 mm on all clamping points, without having to remove the connected wire

- **Reduced downtime** due to quick and easy component replacement

- **Wiring errors reduced to a minimum**

- **Cost reduction** in assembly on site

- **Time saving due to pluggable accessories**

- **Flexible potential commoning**

- Two versions of DIN rail terminal blocks:

- WKF 2.5/D2/81 13... with 2 inputs and 2 outputs on one potential, only 5 mm wide

- WKF 2.5 E/81 13/35 with 2 input and 2 output with different potentials in double-tier design

- **Dead front safety** as per IEC 60529 due to shrouded pins on the plug-in side

- **Coding pieces** prevents incorrect mating of the pluggable connector

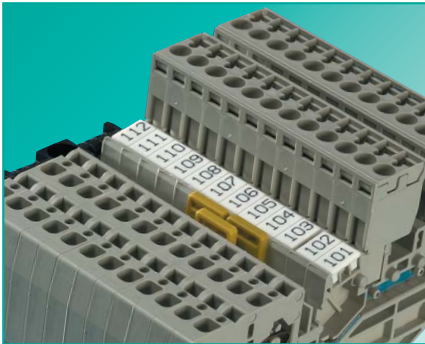

Cross connection (Jumper Bars)

- The insulated cross connectors IVB WKF... are completely touch safe
- No partition plates required between jumpered terminal groups of different potential
- Cross connector IVB WKF 2.5... can bear the same rated current as the terminal (pg. 17)



Wire entry guides

- For the connection of wires with cross sections smaller than 18 AWG, we recommend the use of wire entry guides
- Wire entry guides prevent the wires from being inserted beyond the optimal clamping point and ensure a safe and secure connection



Marking systems

- Marking facility is down the center so that the marking tag is not covered by the conductor
- Single marking tag 5, 6, or 8 mm spacing
- Marking strips (10 tags) to snap on to the terminal blocks
- Tear-off marking strips for 3-digit marking facilities per block
- Custom marking upon request



Cover with warning symbol

- Cover with warning symbol ADC to snap on to blocks which are still live after switched-off (VDE 0113)
- Cover can only be removed with a screwdriver

DQS certificates for all products

- Quality standard as per DIN ISO 9001 in Development, Production, Assembly
- Continued control of the quality standard by means of regular internal and external quality audits
- Compatible with certificates of other countries:
 - BSI Certificate, Great Britain
 - SQS Certificate, Switzerland
 - Aib-Vincotte Certificate, Belgium
 - ÖQS Certificate, Austria

Material

Metal parts

Special alloys and surface treatments provide low contact resistance and high corrosion resistance

Clamping spring: stainless CrNi steel

Current Carrying bar: tin-plated copper

Insulating material

Polyamide has excellent electrical, chemical and mechanical characteristics

Insulating housing: Polyamide 66/6

Tracking resistance: CTI 600

Flammability class: UL 94 V-0

(see also section **facts & DATA**)

Our **wieplan** software helps to plan your DIN rail terminal block assemblies (see page 10/11).

Note

The information regarding cross-sectional areas and connection types pertains to wires without ferrules. Ferrules are not necessary for secure connection.

The voltage ratings apply to the terminals in their intended application. When different products are mounted adjacent to each other, the proper isolation distances must be adhered to. For this purpose, **Wieland** offers a large selection of appropriate accessories.

If the ground blocks of the WKF series are not used in block assemblies but are mounted to the rail as single terminal blocks, end clamps have to be used.

A detailed description of technical data, the standards requirements, and the application conditions can be found in catalog section **facts & DATA**.



Duo feed-through blocks with pluggable connection

fasis

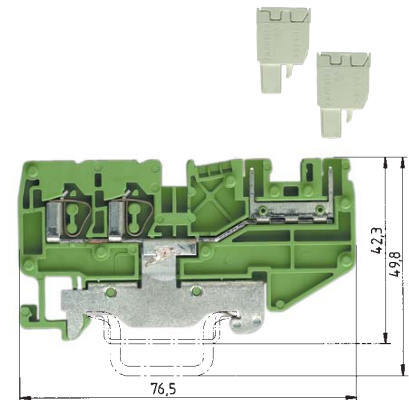
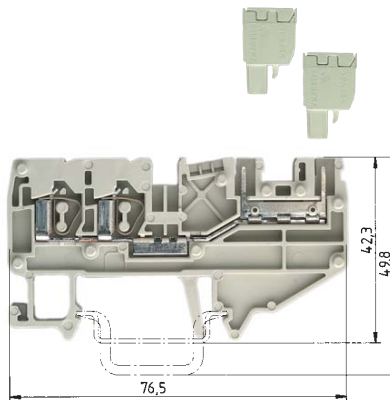

WKF 2.5 D2/8113/35

fine stranded	solid	V	A
0.13 – 2.5 mm ²	0.13 – 4 mm ²	250 V/4 kV/3	16
No. 22-12 AWG		300 V	15
No. 24-12 AWG		300 V	15
Wire strip length	5 mm		11 mm

WKF 2.5 D2/8113 SL/35

fine stranded	solid	V	A
0.13 – 2.5 mm ²	0.13 – 4 mm ²	250 V/4 kV/3	16
No. 22-12 AWG		300 V	
No. 24-12 AWG		300 V	
Wire strip length	5 mm		11 mm

EN 60 947-7-1/DIN VDE 0611 T1

UL ratings

CSA ratings

Width

Approvals

Wire strip length

		Type	Part no.	Std. pack.	Type	Part no.	Std. pack.
Duo feed-through block	Color: gray	WKF 2,5 D2/8113/35	56.703.2053.0	100			
	Color: blue	WKF 2,5 D2/8113/35 BLAU	56.703.2053.6	100			
Duo ground block	Color: green/yellow				WKF 2,5 D2/8113 SL/35	56.703.9253.0	100
Double-tier block	Color: gray						
Accessories							
1. Mounting rail 35, 7.5 mm high	L = 2 m	35x27x7,5 EN 60715	98.300.0000.0	1	35x27x7,5 EN 60715	98.300.0000.0	1
Mounting rail 35, 15 mm high	L = 2 m	35x24x15 EN 60715	98.360.0000.0	1	35x24x15 EN 60715	98.360.0000.0	1
2. End clamp TS 35, with screw	8 mm wide	9708/2 S35	Z5.522.8553.0	100	9708/2 S35	Z5.522.8553.0	100
End clamp TS 35, screwless	8 mm wide	WEF 1/35	Z5.523.9353.0	100	WEF 1/35	Z5.523.9353.0	100
3. End plate	Color: gray	APF 2,5/D2/8113	07.312.4153.0	10	APF 2,5/D2/8113	07.312.4153.0	10
	Color: blue	APF 2,5/D2/8113	07.312.4153.6	10			
4. Partition plate	Color: gray						
	Color: blue						
5. Cross connector	2pole	IVB WKF 2,5 – 2	Z7.280.6227.0	10			
insulated (jumper bar)	3pole	IVB WKF 2,5 – 3	Z7.280.6327.0	10			
	4pole	IVB WKF 2,5 – 4	Z7.280.6427.0	10			
	5pole	IVB WKF 2,5 – 5	Z7.280.6527.0	10			
	6pole	IVB WKF 2,5 – 6	Z7.280.6627.0	10			
	7pole	IVB WKF 2,5 – 7	Z7.280.6727.0	20			
	8pole	IVB WKF 2,5 – 8	Z7.280.6827.0	20			
	9pole	IVB WKF 2,5 – 9	Z7.280.6927.0	20			
	10pole	IVB WKF 2,5 – 10	Z7.280.7027.0	20			
6. Wire entry guide	0.13 – 0.2 mm ²	LEL 2,5/1 WEISS	05.561.6553.0	100	LEL 2,5/1 WEISS	05.561.6553.0	100
	0.25 – 0.5 mm ²	LEL 2,5/2 GRAU	05.561.6653.0	100	LEL 2,5/2 GRAU	05.561.6653.0	100
	0.75 – 1.0 mm ²	LEL 2,5/3 SCHWARZ	05.561.6753.0	100	LEL 2,5/3 SCHWARZ	05.561.6753.0	100
7. Cover with warning symbol over 4 blocks		ADF 2,5/4 GELB	04.343.6053.8	10	ADF 2,5/4 GELB	04.343.6053.8	10
Cover with warning symbol over 4 poles		AD 8113/4 GELB	04.343.6853.8	10	AD 8113/4 GELB	04.343.6853.8	10
8. Screwdriver, uninsulated		DIN 5264 B 0,6x3,5	06.502.4000.0	5	DIN 5264 B 0,6x3,5	06.502.4000.0	5
9. Coding strip			05.561.0053.0	100		05.561.0053.0	100
10. Test plug with sping connection		PSWKC/F	Z1.299.9753.0		PSWKC/F	Z1.299.9753.0	
End plate / spacer		ZP/APPS	07.312.6053.0		ZP/APPS	07.312.6053.0	
Blank module for staggered testing			01.299.9753.0			01.299.9753.0	
Marking accessories see page 48/49 and page 90/91					Please see note on page 17!		

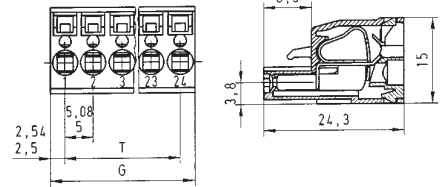
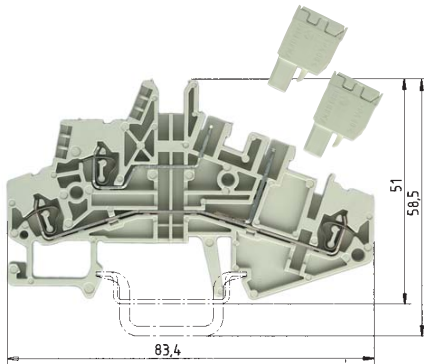

WKF 1.5 E/8113/35

	fine stranded	solid	V	A
0.13 – 1.5 mm ²	0.13 – 2.5 mm ²	250 V/4 kV/3	16	
No. 22-14		300 V	15	
No. 24-14				
5 mm			8 mm	

Rated voltages: VDE 0110/01.89
 250 V/4 kV/3 – Overvoltage category III
 400 V/4 kV/2 – Overvoltage category II
 1000 V/4 kV/1 – Overvoltage category I
 CSA No. 22-12 AWG 300 V 12 A
 Rated current: 12 A

Type 8113 BFK

	fine stranded	solid	V	A
0.13 – 2.5 mm ²	0.13 – 4 mm ²			12
22-12 AWG		300 V	12	
22-12 AWG		300 V	12	
5 mm			9 mm	



Type	Part no.	Std. pack.	Std. pack.	G	T	Pole	Part no.	Part no.
			5 mm pitch				unmarked	marked
			100	10.00	5.00	2	25.820.3253.0	25.820.0253.0
WKF 1,5 E/8113/35	56.702.2053.0	100	100	15.00	10.00	3	25.820.3353.0	25.820.0353.0
			50	20.00	15.00	4	25.820.3453.0	25.820.0453.0
			50	25.00	20.00	5	25.820.3553.0	25.820.0553.0
35x27x7,5 EN 60715	98.300.0000.0	1	50	30.00	25.00	6	25.820.3653.0	25.820.0653.0
35x24x15 EN 60715	98.360.0000.0	1	50	35.00	30.00	7	25.820.3753.0	25.820.0753.0
9708/2 S35	Z5.522.8553.0	100	50	40.00	35.00	8	25.820.3853.0	25.820.0853.0
WEF 1/35	Z5.523.9353.0	100	50	45.00	40.00	9	25.820.3953.0	25.820.0953.0
APF 1,5/E/8113	07.312.4753.0	10	50	50.00	45.00	10	25.820.4053.0	25.820.1053.0
			50	55.00	50.00	11	25.820.4153.0	25.820.1153.0
			50	60.00	55.00	12	25.820.4253.0	25.820.1253.0
			50	65.00	60.00	13	25.820.4353.0	25.820.1353.0
IVB WKF 2,5 – 2	Z7.280.6227.0	10	50	70.00	65.00	14	25.820.4453.0	25.820.1453.0
IVB WKF 2,5 – 3	Z7.280.6327.0	10	50	75.00	70.00	15	25.820.4553.0	25.820.1553.0
IVB WKF 2,5 – 4	Z7.280.6427.0	10	50	80.00	75.00	16	25.820.4653.0	25.820.1653.0
IVB WKF 2,5 – 5	Z7.280.6527.0	10	17- to 24-pole configurations upon request					
IVB WKF 2,5 – 6	Z7.280.6627.0	10						
IVB WKF 2,5 – 7	Z7.280.6727.0	20						
IVB WKF 2,5 – 8	Z7.280.6827.0	20						
IVB WKF 2,5 – 9	Z7.280.6927.0	20						
IVB WKF 2,5 – 10	Z7.280.7027.0	20						
LEL 1,5/1 WEISS	05.562.2453.0	100						
LEL 1,5/2 GRAU	05.562.2553.0	100						
LEL 1,5/3 SCHWARZ	05.562.2653.0	100						
ADF 2,5/4 GELB	04.343.6053.8	10				DIN 5264 B 0,6x3,5	06.502.4000.0 5	
AD 8113/4 GELB	04.343.6853.8	10					05.561.9153.0 100	
DIN 5264 B 0,6x3,5	06.502.4000.0	5						
	05.561.0053.0	100						
PSWKC/F	Z1.299.9753.0							
ZP/APPS	07.312.6053.0							
	01.299.9753.0							

Disconnect blocks with spring clamp connection, type **WKF**

fasis

Fuse plug:

Nominal voltage: 250 V ~ to VDE 0820 T2/IEC 257
 Nominal current: – 6.3 A for single blocks
 – 4 A for neighbouring blocks

Max. power loss of the fuse insert: 1.6 W
 Indicator (24 V): LED color red
 current consumption: 10.3 mA
 Indicator (110 - 220 V): LED color red
 current consumption: 0.3 mA

*1) The current load is determined by the fuse. The voltage range is determined by the built-in LED.

**1) The current load is determined by the component installed

***1) For use with 5 x 20 mm fuses

Periodic peak voltage 1000 V
 Direction of the diode: Anode Cathode¹⁾
 Cathode Anode²⁾

EN 60 947-7-1, EN 60 127-6

UL ratings

CSA ratings

Width

Wire strip length

Approvals

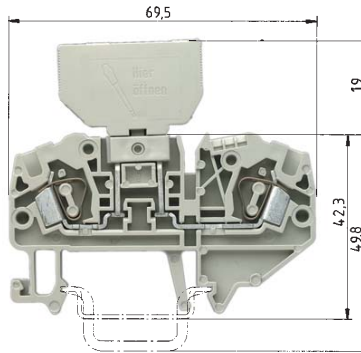

WKF 4 TKG/35 with fuse holder

fine stranded	solid	V	A
0.13 – 4 mm ²	0.13 – 6 mm ²	800 V/8 kV/3*)	*)
No. 22-10 AWG		600 V	10***)
No. 22-10 AWG		300 V	6.3***)
6 mm			11 mm

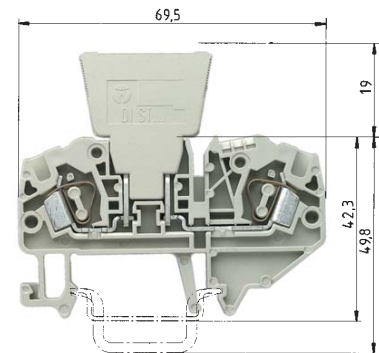

WKF 4 TKG/35 with diode plug

fine stranded	solid	V	A
0.13 – 4 mm ²	0.13 – 6 mm ²	800 V/8 kV/3	**)
No. 22-10 AWG		600 V	10**)
No. 22-10 AWG		600 V	10**)
6 mm			11 mm



Disconnect block	Color: gray	Type	Part no.	Std. pack.	Type	Part no.	Std. pack.
		WKF 4 TKG/35	56.704.4053.0	100	WKF 4 TKG/35	56.704.4053.0	100
Fuse holder for fuse 5 x 20	Color: gray	Si ST	Z1.299.4055.0				
Fuse holder with indicator (24 V)	Color: gray	Si ST LED	Z1.299.4155.0	10			
Fuse holder with indicator (110 - 220 V)	Color: gray	Si ST GL	Z1.299.4255.0				
Diode plug – empty	J _{max} = 10 A Color: gray				DIST ...	Z1.299.3055.0	
Diode plug – diode	J _{max} = 1 A Color: gray				DIST-1 N 4007-1 ¹⁾	Z1.299.3155.0	
Diode plug – diode	J _{max} = 1 A Color: gray				DIST-1 N 4007-2 ²⁾	Z1.299.3355.0	
Diode plug with jumper	J _{max} = 10 A Color: gray				DIST-D	Z1.299.3255.0	
Accessories							
1. Mounting rail 35, 7.5 mm high	L = 2 m	35x27x7,5 EN 60715	98.300.0000.0	1	35 x 27 x 7,5 EN 60715	98.300.0000.0	1
Mounting rail 35, 15 mm high	L = 2 m	35x24x15 EN 60715	98.360.0000.0	1	35 x 24 x 15 EN 60715	98.360.0000.0	1
Mounting rail 35, 15 mm high	L = 2 m	35 x 27 x 15	98.370.0000.0	1	35 x 27 x 15	98.370.0000.0	1
2. End clamp TS 35, with screw	8 mm wide	9708/2 S35	Z5.522.8553.0	100	9708/2 S35	Z5.522.8553.0	100
End clamp TS 35, screwless	8 mm wide	WEF 1/35	Z5.523.9353.0	100	WEF 1/35	Z5.523.9353.0	100
3. End plate	Color: gray	APF 4 TK	07.312.2853.0	10	APF 4 TK	07.312.2853.0	10
4. Partition plate							
5. Cross connector	2pole	IVB WKF 4-2	Z7.261.1227.0	10	IVB WKF 4-2	Z7.261.1227.0	10
insulated (jumper bar)	3pole	IVB WKF 4-3	Z7.261.1327.0	10	IVB WKF 4-3	Z7.261.1327.0	10
	4pole	IVB WKF 4-4	Z7.261.1427.0	10	IVB WKF 4-4	Z7.261.1427.0	10
	5pole	IVB WKF 4-5	Z7.261.1527.0	10	IVB WKF 4-5	Z7.261.1527.0	10
	6pole	IVB WKF 4-6	Z7.261.1627.0	10	IVB WKF 4-6	Z7.261.1627.0	10
	7pole	IVB WKF 4-7	Z7.261.1727.0	20	IVB WKF 4-7	Z7.261.1727.0	20
	8pole	IVB WKF 4-8	Z7.261.1827.0	20	IVB WKF 4-8	Z7.261.1827.0	20
	9pole	IVB WKF 4-9	Z7.261.1927.0	20	IVB WKF 4-9	Z7.261.1927.0	20
	10pole	IVB WKF 4-10	Z7.261.2027.0	20	IVB WKF 4-10	Z7.261.2027.0	20
6. Wire entry guide	0.13 – 0.2 mm ²	LEL 4/1 WEISS	05.561.8553.0	100	LEL 4/1 WEISS	05.561.8553.0	100
	0.25 – 0.5 mm ²	LEL 4/2 GRAU	05.561.8653.0	100	LEL 4/2 GRAU	05.561.8653.0	100
	0.75 – 1.0 mm ²	LEL 4/3 SCHWARZ	05.561.8753.0	100	LEL 4/3 SCHWARZ	05.561.8753.0	100
7. Cover with warning symbol over 4 blocks		ADF 4/4 GELB	04.343.6153.8	10	ADF 4/4 GELB	04.343.6153.8	10
8. Screwdriver, uninsulated		DIN 5264 B 0,6x3,5	06.502.4000.0	5	DIN 5264 B 0,6 x 3,5	06.502.4000.0	5
Marking accessories see page 48/49 and page 90/91							

Knife edge disconnect block with spring clamp connection, type WKF

The disconnecting knife in these WKF versions swing in and out on a pivot point. The distinctive color of the disconnecting lever signals the open state. The terminals can be connected with the lever open or closed.

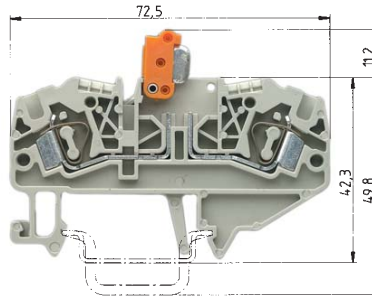

WKF 4 TKM/35

EN 60 947-7-1/DIN VDE 0611 T1		fine stranded	solid	V	A
UL ratings		0.13 – 4 mm ²	0.13 – 6 mm ²	800 V/8 kV/3	16
CSA ratings		No. 22-10 AWG		600 V	20
Width	Wire strip length	No. 22-10 AWG		600 V	20
Approvals		6 mm			11 mm

		Type	Part no.	Std. pack.
Knife edge disconnect block	Color: gray	WKF 4 TKM/35	56.704.2053.0	100
Accessories				
1. Mounting rail 35, 7.5 mm high	L = 2 m	35x27x7,5 EN 60715	98.300.0000.0	1
Mounting rail 35, 15 mm high	L = 2 m	35x24x15 EN 60715	98.360.0000.0	1
Mounting rail 35, 15 mm high	L = 2 m	35 x 27 x 15	98.370.0000.0	1
2. End clamp TS 35	8 mm wide	9708/2 S35	Z5.522.8553.0	100
End clamp TS 35, screwless	8 mm wide	WEF 1/35	Z5.523.9353.0	100
3. End plate	Color: gray	APF 4 TKM	07.312.4353.0	10
4. Partition plate				
5. Cross connector	2pole	IVB WKF 4-2	Z7.261.1227.0	10
insulated (jumper bar)	3pole	IVB WKF 4-3	Z7.261.1327.0	10
	4pole	IVB WKF 4-4	Z7.261.1427.0	10
	5pole	IVB WKF 4-5	Z7.261.1527.0	10
	6pole	IVB WKF 4-6	Z7.261.1627.0	10
	7pole	IVB WKF 4-7	Z7.261.1727.0	20
	8pole	IVB WKF 4-8	Z7.261.1827.0	20
	9pole	IVB WKF 4-9	Z7.261.1927.0	20
	10pole	IVB WKF 4-10	Z7.261.2027.0	20
6. Wire entry guide	0.13 - 0.2 mm ²	LEL 4/1 WEISS	05.561.8553.0	100
	0.25 - 0.5 mm ²	LEL 4/2 GRAU	05.561.8653.0	100
	0.75 - 1.0 mm ²	LEL 4/3 SCHWARZ	05.561.8753.0	100
7. Cover with warning symbol over 4 blocks		ADF 4/4 GELB	04.343.6153.8	10
8. Screwdriver, uninsulated		DIN 5264 B 0,6x3,5	06.502.4000.0	5

Mini spring terminals, type WKMF

fasis MINI

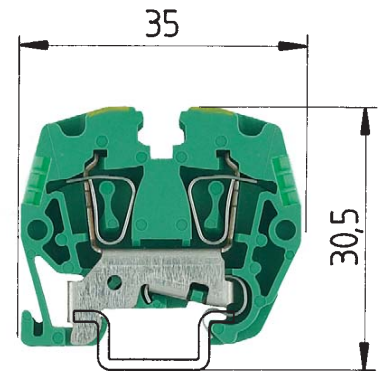
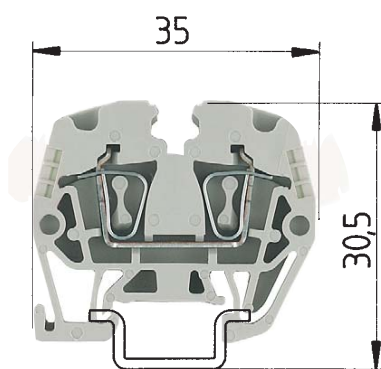

EN 60 947-7-1

UL ratings

CSA ratings

Width

Approvals

field/factory wiring

Wire strip length

WKMF 2.5/15

fine stranded solid V A
 0.13–2.5 mm² 0.13–2.5 mm² 500 V/6kV/3 24
 No. 26-12 AWG 600 V 20
 No. 26-12 AWG 300 V 20
 5 mm 10 mm
 UL CE pending

WKMF 2.5 SL/15

fine stranded solid V A
 0.13–2.5 mm² 0.13–2.5 mm² 500 V/6kV/3 24
 No. 26-12 AWG 600 V 20
 No. 26-12 AWG 300 V 20
 5 mm 10 mm
 UL CE pending

		Type	Part no.	Std. pack.	Type	Part no.	Std. pack.
Feed-through terminal	Color: gray	WKMF 2,5/15	55.703.0053.0				
Feed-through terminal	Color: blue	WKMF 2,5/15	55.703.0053.6				
Ground terminal	Color: green/yellow				WKMF 2,5 SL/15	55.703.9053.0	
Accessories							
1. Mounting rail 15, 5.5 mm high	L = 2 m	9021/15x5,5 EN 60715	98.090.0015.0	10	9021/15x5,5 EN 60715	98.090.0015.0	10
2. End clamp TS 15, metal	7.5 mm wide	9222	Z5.522.5010.0	100	9222	Z5.522.5010.0	100
End clamp TS 15, polyamide	7.5 mm wide	9208 S 15	Z5.522.7553.0	100	9208 S 15	Z5.522.7553.0	100
3. End plate	1.5 mm wide	Color: gray	APMF 2,5 /15	07.312.5953.0	APMF 2,5 /15	07.312.5953.0	
	1.5 mm wide	Color: blue					
	1.5 mm wide	Color: green					
4. Partition plate	1.5 mm wide	Color: gray					
	1.5 mm wide	Color: blue					
5. Cross connector	2pole	IVB WKMF 2,5 – 2	Z7.260.0229.0				
insulated (jumper bar)	3pole	IVB WKMF 2.5 – 3	Z7.260.0329.0				
	4pole	IVB WKMF 2.5 – 4	Z7.260.0429.0				
	5pole	IVB WKMF 2.5 – 5	Z7.260.0529.0				
	6pole	IVB WKMF 2.5 – 6	Z7.260.0629.0				
	7pole	IVB WKMF 2.5 – 7	Z7.260.0729.0				
	8pole	IVB WKMF 2.5 – 8	Z7.260.0829.0				
	9pole	IVB WKMF 2.5 – 9	Z7.260.0929.0				
	10pole	IVB WKMF 2.5 – 10	Z7.260.1029.0				
	50pole	IVB WKMF 2.5 – 10	Z7.260.0029.0				
6. Wire entry guide	0.13 – 0.2 mm ²						
	0.25 – 0.5 mm ²						
	0.75 – 1.0 mm ²						
7. Cover with warning symbol for 4 terminals							
8. Screwdriver, uninsulated		DIN 5264 B 0,6x3,5	06.502.4000.0	5	DIN 5264 B 0,6x3,5	06.502.4000.0	5
Screwdriver, uninsulated, MINI		DIN 5264 B 0,6x3,5 M	06.502.5000.0	10	DIN 5264 B 0,6x3,5 M	06.502.5000.0	10
Marking accessories see page 48/49 and page 90/91							

fasis

fasis

Sensor and actuator blocks with spring clamp connection, type WKF 1.5 KO...

fasis

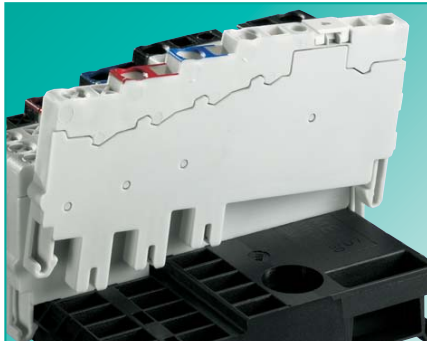

System advantages

- Built in Bus System on the base module for power distribution (+, -, shield)
- Separate terminal for power input
- 35 mm DIN rail or panel mount

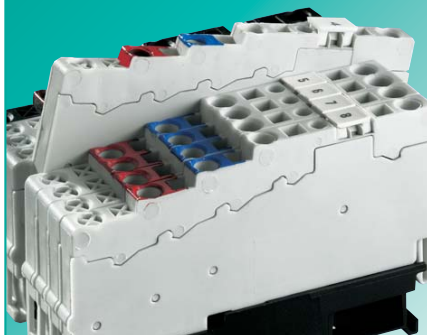

- Individual blocks can be replaced without interrupting power to the other sensor and actuator blocks
- Clear wiring with TOP connection, even in narrow spaces
- Compact design

Application advantages

- Snapping a sensor or actuator terminal into the base module automatically establishes direct contact to the bus bar
- No external jumper bars required
- The configuration of the base module matches standard I/O cards of PLC's with 8 or 16 I/O

- Modifications and expansions can be easily and quickly done
- Safe and easy connection of sensors and actuators

→ 8 sensors or actuators can be terminated in a 45 x 65 mm (1.75" x 2.5") area

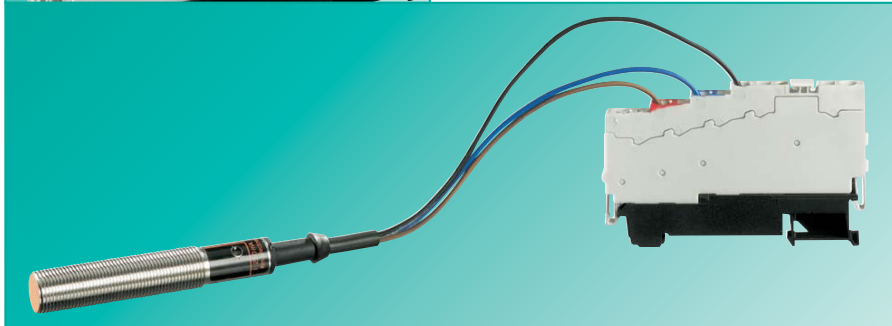

- Sensor block WKF 1.5 KOI 3L... for the connection of proximity switches

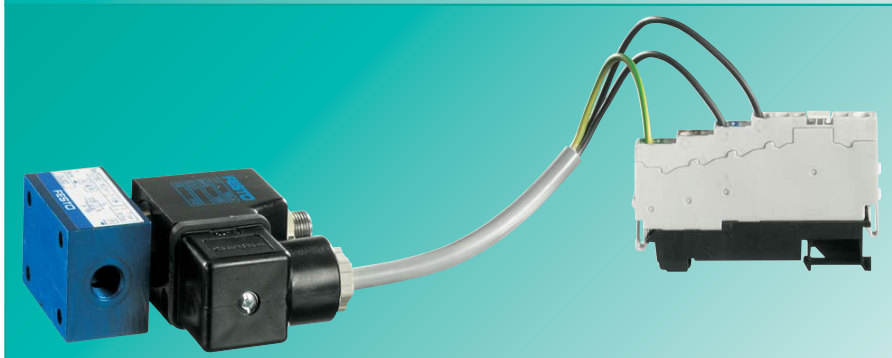

- Actuator block WKF 1,5 KOA 2L... for the connection of actuators such as solenoid valves



- Sensor/Actuator terminals available with yellow LED for switch status indication
- Power input terminals available with green LED for "Power On" indication

- Easy maintenance and remote troubleshooting of the electrical system



Cross connection (Jumpering)

- Potential commoning is achieved by snapping the blocks on to the base module
- Dead front safety covers for unused termination points



Wire entry guides

- Recommended for wires smaller than 18 AWG
- Prevent the wires from being inserted beyond the optimal clamping point for safe and secure connections



Marking facilities

- Single marking tag in 5-mm spacing
- Marking strips (10 single marking tags) to the snap on to the terminal blocks



- Tear-off marking strips for 3-digit marking facilities per block
- Custom marking upon request



DQS certificates for all products

- Quality standard as per DIN ISO 9001 in Development, Production, Assembly
- Continued control of the quality standard by means of regular internal and external quality audits
- Compatible with certificates of other countries:
 - BSI Certificate, Great Britain
 - SQS Certificate, Switzerland
 - Aib-Vincotte Certificate, Belgium
 - ÖQS Certificate, Austria

Material

Metal parts

Special alloys and surface treatments provide low contact resistance and high corrosion resistance

Clamping spring: stainless CrNi steel

Current Carrying bar: tin-plated copper

Insulating material

Polyamide has excellent electrical, chemical and mechanical characteristics

Insulating housing: Polyamide 66/6

Tracking resistance: CTI 600

Flammability class: UL 94 V-2

(see also section **facts & DATA**)

Our **wieplan** software helps to plan your DIN rail terminal block assemblies (see page 10/11).

Note

The information regarding cross-sectional areas and connection types pertains to wires without ferrules. Ferrules are not necessary for secure connection.

The voltage ratings apply to the terminals in their intended application. When different products are mounted adjacent to each other, the proper isolation distances must be adhered to. For this purpose, **Wieland** offers a large selection of appropriate accessories.

A detailed description of technical data, the standards requirements, and the application conditions can be found in catalog section **facts & DATA**.

Sensor and actuator blocks with spring clamp connection, type **WKF 1.5 KO...**

fasis

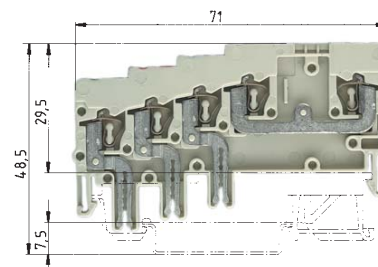
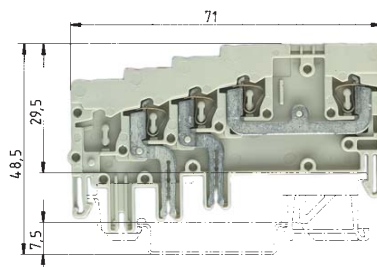

37.702.7453.0
* 65 V/1.5 kV/3



37.702.8453.0
* DC 24 V
same as picture,
but with LED



37.702.7553.0
* 65 V/1.5 kV/3

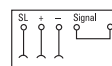

37.702.8553.0
* DC 24 V
same as picture,
but with LED

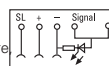

WKF 1.5 KOI 3L...

fine stranded	solid	V	A
0.13 – 1.5 mm ²	0.13 – 1.5 mm ²	*	10
No. 28-16 AWG		65 V	
10 A			
5 mm		10 mm	

WKF 1.5 KOI 3L/SL...

fine stranded	solid	V	A
0.13 – 1.5 mm ²	0.13 – 1.5 mm ²	*	10
No. 28-16 AWG		65 V	
10 A			
5 mm		10 mm	

EN 60 947-7-1/DIN VDE 0611 T1

UL ratings field/factory wiring

CSA ratings

Width

Wire strip length

Approvals

		Type	Part no.	Std. pack.	Type	Part no.	Std. pack.
Sensor block	Color: gray	WKF 1,5 KOI 3L	37.702.7453.0	50			
Sensor block with LED (PNP)	Color: gray	WKF 1,5 KOI 3L-PGE	37.702.8453.0	50			
Sensor block	Color: gray				WKF 1,5 KOI 3L/SL	37.702.7553.0	50
Sensor block with LED (PNP)	Color: black				WKF 1,5 KOI 3L/SL-PGE	37.702.8553.0	50
Supply block	Color: black						
Supply block with LED	Color: gray						
Actuator block	Color: gray						
Actuator block with LED	Color: gray						
Connection module for 9 blocks	Color: black						
Connection module for 18 blocks	Color: black						
Accessories							
1. Mounting rail 35, 7.5 mm high	L = 2 m	35x27x7,5 EN 60715	98.300.0000.0	1	35x27x7,5 EN 60715	98.300.0000.0	1
Mounting rail 35, 15 mm high	L = 2 m	35x24x15 EN 60715	98.360.0000.0	1	35x24x15 EN 60715	98.360.0000.0	1
2. End clamp TS 35, with screw	8 mm wide	9708/2 S35	Z5.522.8553.0	100	9708/2 S35	Z5.522.8553.0	100
End clamp TS 35, screwless	8 mm wide	WEF 1/35	Z5.523.9353.0	100	WEF 1/35	Z5.523.9353.0	100
3. End plate							
4. Partition plate							
5. Cross connector	2pole						
insulated (jumper bar)	3pole						
	4pole						
	5pole						
	6pole						
	7pole						
	8pole						
	9pole						
	10pole						
6. Wire entry guide	0.13 – 0.2 mm ²	LEL 1,5/1 WEISS	05.562.2453.0	100	LEL 1,5/1 WEISS	05.562.2453.0	100
	0.25 – 0.5 mm ²	LEL 1,5/2 GRAU	05.562.2553.0	100	LEL 1,5/2 GRAU	05.562.2553.0	100
	0.75 – 1.0 mm ²	LEL 1,5/3 SCHWARZ	05.562.2653.0	100	LEL 1,5/3 SCHWARZ	05.562.2653.0	100
7. Cover for connection module							
8. Screwdriver, uninsulated		DIN 5264 B 0,6x3,5	06.502.4000.0	5	DIN 5264 B 0,6x3,5	06.502.4000.0	5
Marking accessories see page 48/49 and page 90/91							

Marking accessories for DIN rail terminal blocks

fasis

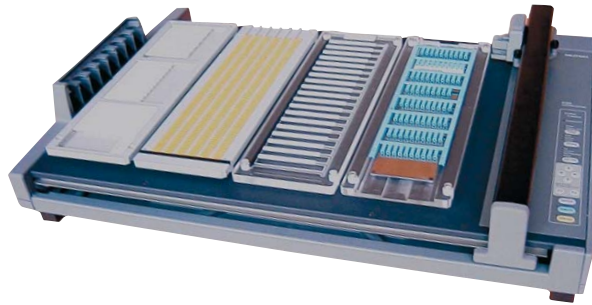

wiemarc

wieplot MUT

Type	Part no.	Std. pack	Type	Part no.	Std. pack
wiemarc CD	95.502.0501.0		wieplot MUT	95.502.0601.0	
Description			Description		
<p>wiemarc is a Windows® based plotter software (Windows 95/98/ME/NT/XP) that is able to drive the following plotter systems:</p> <ul style="list-style-type: none"> – wieplot MUT (Mutoh system) – Roland system <p>for custom printing on standard Wieland marking tags.</p> <p>wiemarc makes preparing data for custom printing easier and faster than ever. Intuitive handling allows printing of marking tag cards in single, multipole and series marking jobs. Import of marking data from Excel files, text files and CAD/CAE programs is possible. wiemarc data file management is user-friendly as printing data can be stored and found very easily in the file library. wiemarc knows several special characters for electrical marking. wiemarc is able to mark tags with upward or downward series, series steps can be chosen as well as leading or following characters. Multipole line printing is possible depending on tag size, number of digits and type size. Automatic adaptation of type size according to tag size and number of digits.</p> <p>Requirements: Pentium II PC or compatible, min. 200 MHz or higher, 64 MByte RAM, CD-ROM Drive, VGA Grafic Adaptor and Monitor</p> <p>wiemarc supports Windows 95®, Windows 98®, Windows 2000®, Windows NT®, Windows ME® and Windows XP® Professional.</p>			<p>wieplot MUT is a plotter system that uses wiemarc to interface with a PC, allowing custom printing on standard Wieland marking tags. These standard marking tags provide circuit identification for Wieland DIN rail mount terminal blocks, rectangular multipole connectors and WEB/WEG electronic housings.</p> <p>Resolution: 0.025 mm</p> <p>Accuracy: +/- 0.1 mm</p> <p>Power supply: 50/60 Hz, 180 – 264 V, 90 – 132 V</p> <p>Automatic switch over from 110 V to 230 V</p> <p>Power rating: About 0.3 A for 220 V</p> <p>Approvals: UL-UL478 (REV .4) CSA-22.2 No. 220 and VDE EN 60 950</p> <p>Interference: FCC Class B FCC Part 15 and VDE Class B</p> <p>Dimensions: 620 mm x 425 mm x 106.5 mm</p> <p>Weight: 6.4 kg</p> <p>Interfaces: RS-232 C and parallel (Centronics)</p>		
Standard template for all Wieland tags			95.502.0621.0		

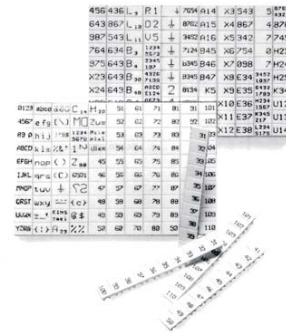

Accessories

Type	Part no.	Std. pack	Type	Part no.	Std. pack
Accessory kit consists of plotter pen 0.25 mm, Ink-cartridge, permanent plotter pen 0.3 mm and cleaning set.			Marker Cards:		
Accessory kit (pen basic equipment)	95.502.0602.0		110 tags per card	9075 A/5/10/11	Z4.242.5053.0
Plotter pens for ROLAND and wieplot MUT systems:			60 tags per card	9705 AL/5/10/6	Z4.242.5153.0
Plotter pen 0.18 mm	95.502.0118.0		110 tags per card	9705 A/6/10/11	Z4.242.6053.0
Plotter pen 0.25 mm	95.502.0125.0		60 tags per card	9705 AL/6/10/6	Z4.242.6153.0
Plotter pen 0.35 mm	95.502.0135.0		84 tags per card	9705 A/6.7/12/7	Z4.242.6753.0*
Plotter pen 0.50 mm	95.502.0150.0		36 tags per card	9705 AL/6.7/12/7	Z4.242.6853.0*
Plotter pen 0.70 mm	95.502.0170.0				
Plotter pen 1.00 mm	95.502.0100.0				
Permanent Plotter pen					
0.30 mm black	95.502.0230.0				
0.70 mm black	95.502.0270.0				
Permanent Plotter pen set					
consisting of black, red, blue, green pen.					
set 0.30 mm	95.502.0234.0				
set 0.70 mm	95.502.0274.0				
Hand pens					
Hand pen 0.25 mm	95.502.0425.0				
Hand pen 0.35 mm	95.502.0435.0				
Hand pen 0.50 mm	95.502.0450.0				
Hand pen 0.70 mm	95.502.0470.0				
Ink cartridge P1.0 5 x 1 ml	95.502.0199.0				
Cleaning set	95.502.0198.0				
Pen cleaner	95.502.0197.0				
wiemarc-Templates for Wieland cards:					
for updating existing plotter systems to wiemarc					
for marcom 2000 and Phoenix CMS-System	95.502.0621.0				
for Weidmueller M-Print (Mutoh IP 220)	95.502.0622.0				
for murrplastic ACS (Roland DXY1150A) set high	95.502.0623.0				
for Wago System and murrplastic ACS set low	95.502.0624.0				

	9075A/ 5/10/11	9075AL/ 5/10/6	9075A/ 6/10/11	9075AL/ 6/10/6	9075A/ 6.7/12/7	9075AL/ 6.7/12/7	9075A/ 8/10/7
fasis							
WKF 2.5 ...	X	X					
WKF 4 ...			X	X			
WKF 6 ...					X	X*	X
WKF 10 ...	X*	X*					
WKF 16 ...			X*	X*			
WKM 2.5 ...	X	X					
taris							
WKC 1 ...	X	X					
WKC 2.5 ...			X	X			
selos							
WK 2.5 ...	X	X					
WK 4 ...			X	X			
WK 6 ...					X*	X*	X
WKN 10 ...	X*	X*					
WKN 16 ...			X*	X*			
WKN 35 ...					X*	X*	X*
WKN 70 ...					X*	X*	
WKM 2.5 ...	X	X					
WKM 4 ...			X	X			
9220 A/6			X	X			
9700 A/5	X	X					
9700 A/6			X	X			
9700 A/8					X*	X*	X
9700 A/10	X*	X*					
9700 A/12			X*	X*			
9700 A/16					X*	X*	

* 2 strips needed for 10 terminals
+ markers must be mounted individually
Note: the AL-markers are 69% longer than the A-markers
AL/6.7 is twice as long to allow more printing area

Terminal blocks for electrical installations
type WKI

fasis BIT



Terminal Blocks for Electrical Installations, Type WKI

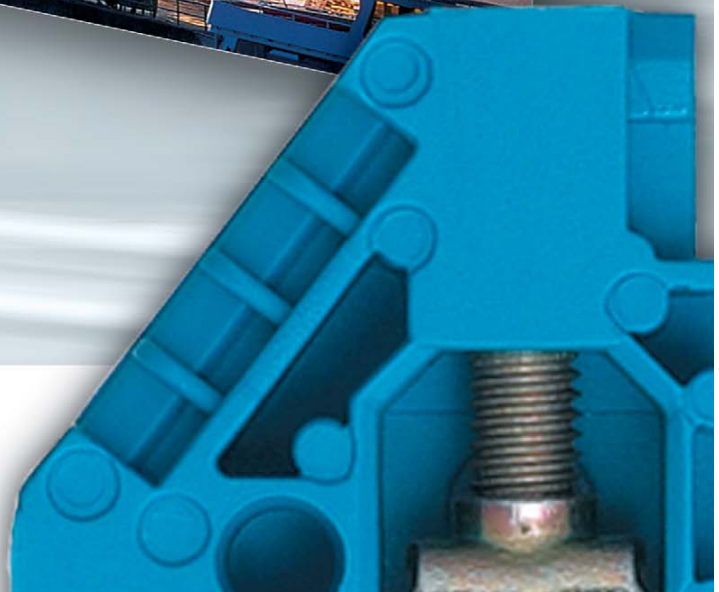

Terminal blocks with spring connection
for junction boxes

fasis BIT

Terminal blocks for electrical installations

2.5 mm²

(12 AWG)



D



D-D



D-D-SL



N-D-SL



NT-D-SL



Standard terminal blocks

4 mm²
(10 AWG)

10 mm²
(6 AWG)

16 mm²
(4 AWG)

Feed-through
blocks



Neutral
disconnect
blocks

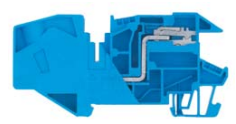

Ground
blocks



Terminal blocks with screw connection for junction boxes

selos BIT

Terminal blocks for electrical installations

4 mm²
(10 AWG)



DU



D-D



D-D-SL



N-D-SL



NT-D-SL



NTN-D-SL

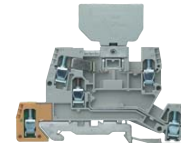

TKG-D-SL

Feed-through blocks

4 mm²
(10 AWG)



10 mm²
(6 AWG)



16 mm²
(4 AWG)



35 mm²
(2 AWG)



Neutral terminal blocks



Ground blocks



Standard terminal blocks

PEN assembly blocks

10 mm²
(6 AWG)



16 mm²
(4 AWG)



35 mm²
(2 AWG)

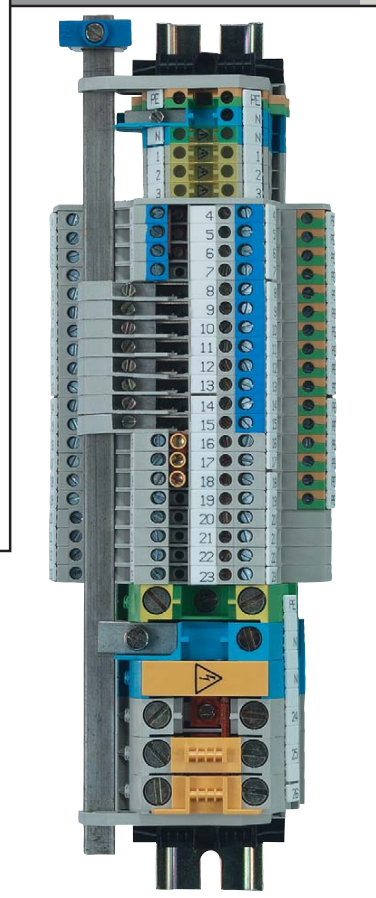

Terminal blocks for electrical installations
with spring connection, type WKIF

fasis BIT

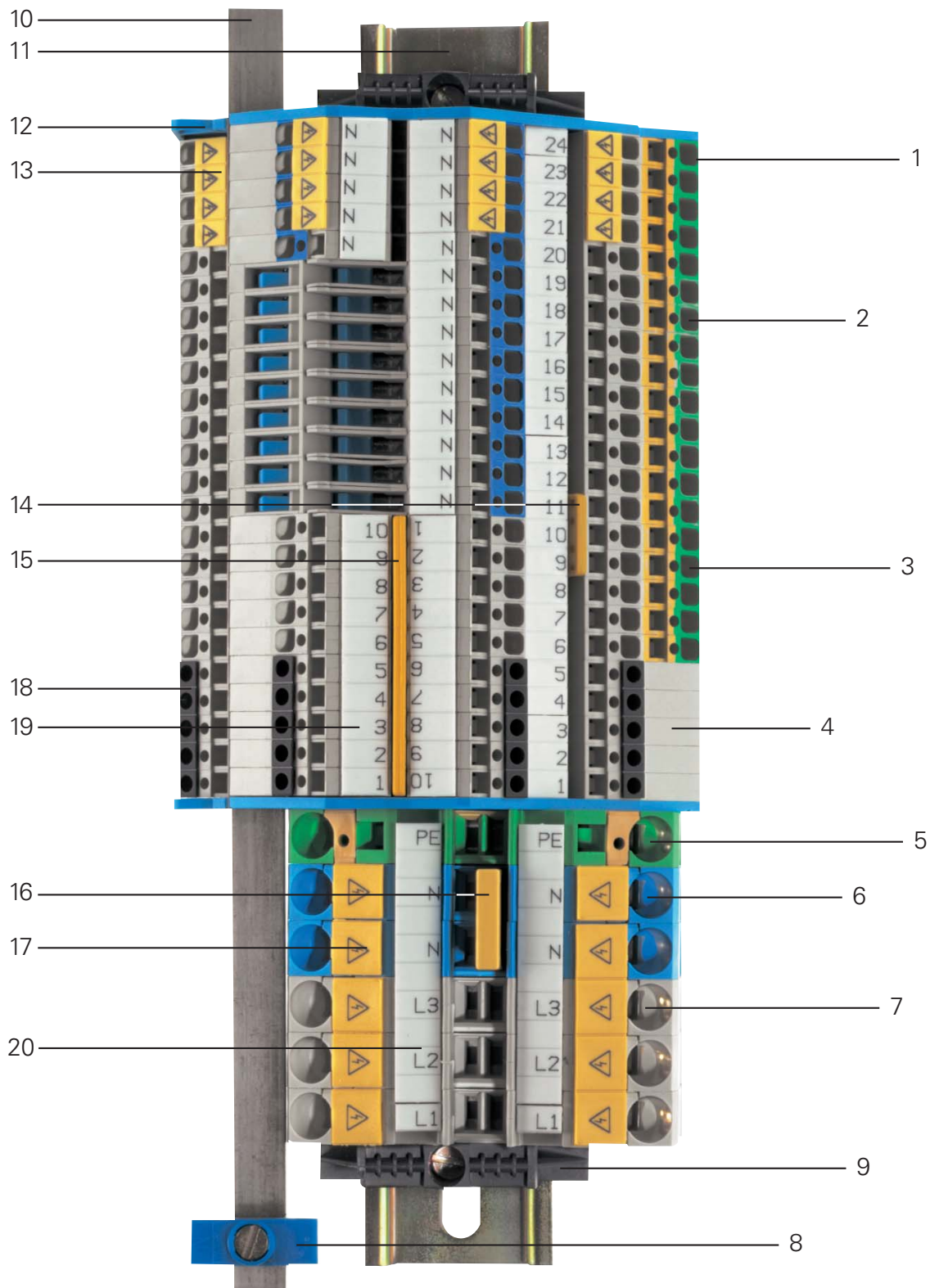

Item	Description	Type	Part number
1	Installation blocks	WKIF 2.5 N-D-SL	56.703.9453.0
2	Installation blocks	WKIF 2.5 NT-D-SL	56.703.9553.0
3	Installation blocks	WKIF 2.5 D-D-SL	56.703.9853.0
4	Installation blocks	WKIF 2.5 D-D	56.703.9753.0
5	Ground block	WKF 10 SL/35	56.710.9053.0
6	Feed through block	WKF 10/35 BLAU	56.710.0053.6
7	Feed through block	WKF 10/35	56.710.0053.0
8	Connector clamp	WAK 16/2 BLAU	30.494.3021.6
9	End clamp	9708/2 S35	Z5.522.8553.0
10	Busbar 10 x 3	9813 M Sn	98.290.1000.0
11	Mounting rail	35 x 27 x 7.5	98.300.0000.0
12	Busbar support	WKIF/SH/35	01.108.7653.0
13	Cover with warning symbol	ADF 2.5/4 GELB	04.343.6053.8
14	Cross connector, insulated	IVB WKF 2.5-3	Z7.280.6327.0
15	Cross connector, insulated	IVB WKF 2.5-10	Z7.280.7027.0
16	Cross connector, insulated	IVB WKF 10-2	Z7.283.8227.0
17	Cover with warning symbol	ADF 10/4 GELB	04.343.6453.8
18	Wire entry guide	LEL 2.5/3 SCHWARZ	05.561.6753.0
19	Marking strips *	9705 A/5/10 B	04.842.5053.0
20	Marking strips *	9705 A/5/10/5 B	04.842.5553.0

*Custom marking upon request

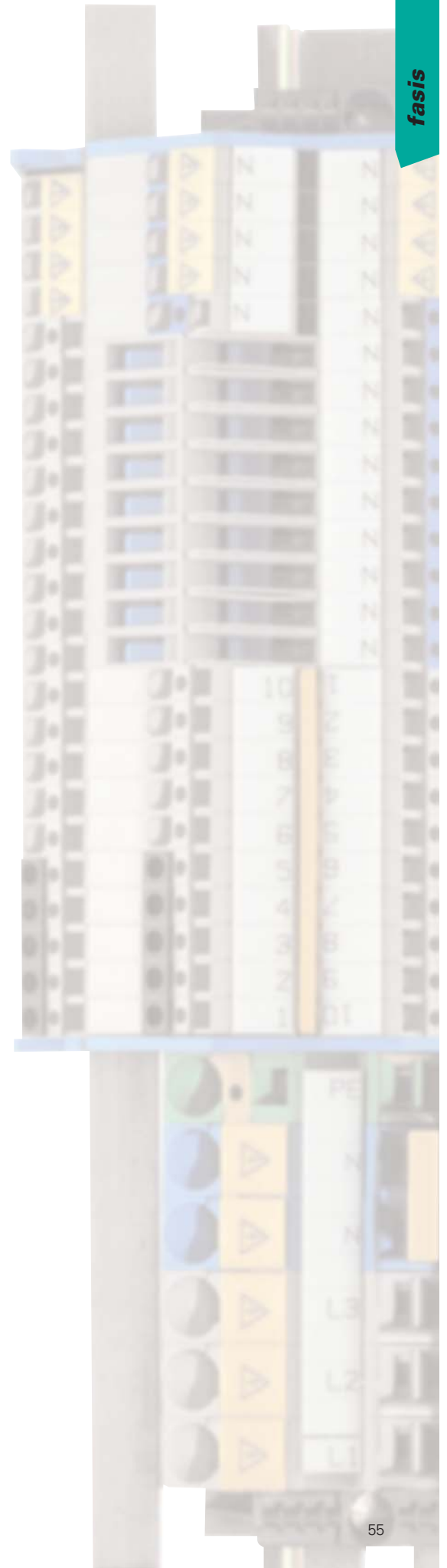

Terminal blocks for electrical installations with spring connection, type WKIF

fasis BIT

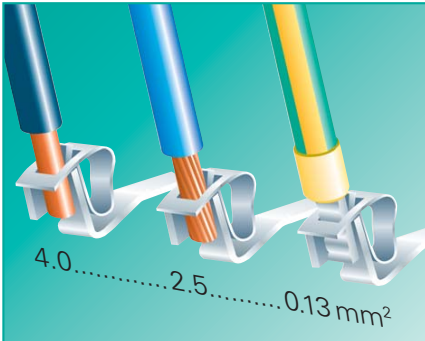

WKIF provides ...

- Very convenient operation due to screwless spring connection
- Small package in a three-tier design
- Screwless neutral conductor disconnect

Application advantages

- The TOP connection technique enables easy and safe wiring according to EN 60947-7-1 even in narrow spaces which are difficult to access
- High density as the installation blocks are only 5mm wide
- Suited for small junction boxes with cover according to DIN 43871
- Maintenance-friendly design for after-sales service and inspection
- Blue indicator shows the state of the neutral circuit
- Fast and safe disconnection of the neutral conductor with WKIF 2.5 NT-D-SL

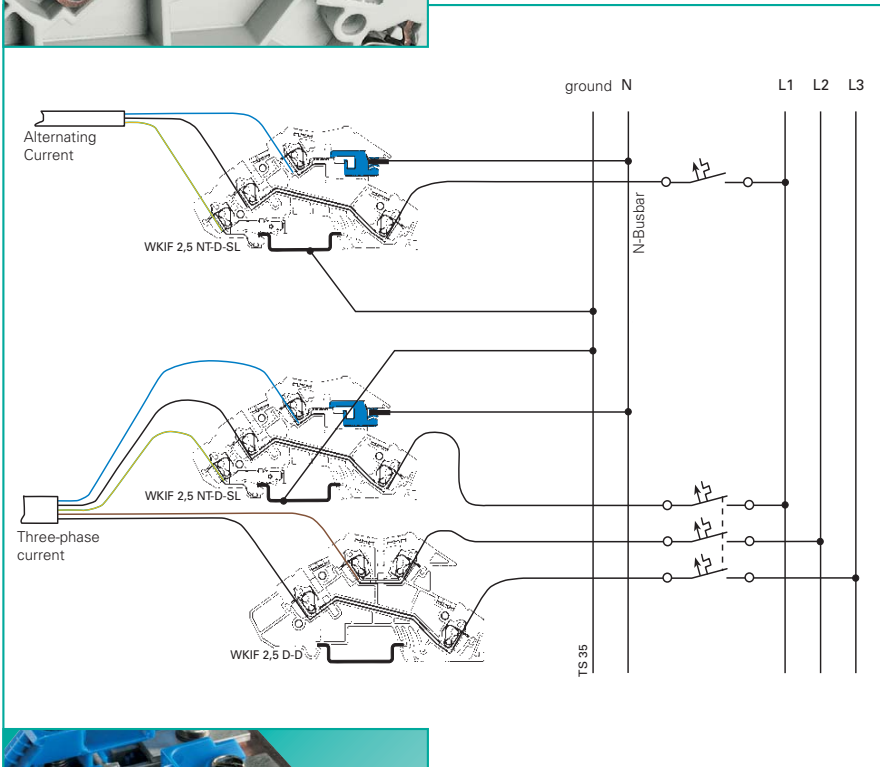

- fasis BIT** is designed to meet the wiring and installation requirements of distribution systems in commercial and institutional buildings (such as hospitals, schools, shopping malls, theaters, office buildings, airports) according to VDE 0100 (IEC 60364) and standard control requirements.
- WKIF 2.5 NT-D-SL allows the required circuit isolation test without disconnecting the neutral conductor
- WKIF offers installation terminal blocks in 5 versions:
 - WKIF 2.5 D
 - WKIF 2.5 D-D
 - WKIF 2.5 D-D-SL
 - WKIF 2.5 N-D-SL
 - WKIF 2.5 NT-D-SL
- other applications include control wiring. For example, analog signal (+, -, shield) all in one terminal block.



- Connection slot on the terminal block for the neutral busbar.

- The terminal blocks for electrical installations of the WKIF series in the NT version can be combined with ...
 - ...the terminal blocks of the WKI series (screw connection style)
 - ...the neutral disconnect blocks (ETK) of the WKN series (screw connection style)

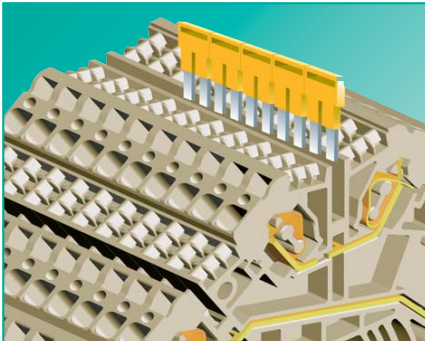

Cross connection

- Jumping with insulated cross connector **IVB WKF 2.5...**
- No partition plates required between adjacent cross connectors
- Cross connectors **IVB WKF 2.5...** are rated for the same current as the terminal block

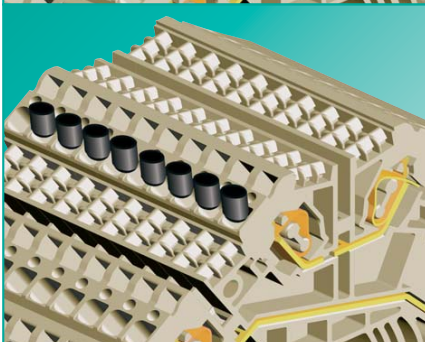

Wire entry guide

- Wire entry guides **LEL** are recommended when connecting wires with cross sections below 1 mm² or 18 AWG
- Wire entry guides **LEL** prevent the wires from being inserted beyond optimal clamping position and therefore guarantee safe connection

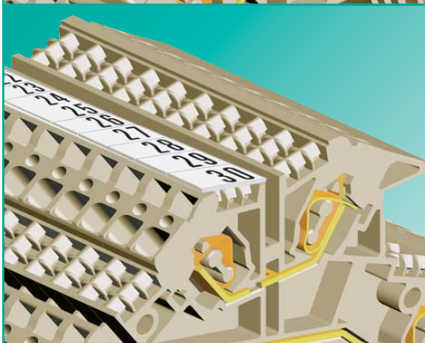

Marking facilities

- Marking facility is down the center so that the marking tag is not covered by the conductor
- Tear-off marking strips for 3-digit marking facilities per block
- Single marking tags in 5 mm spacing
- Marking strips (10 individual marking tags) to snap on to 10 terminal blocks
- Custom marking upon request

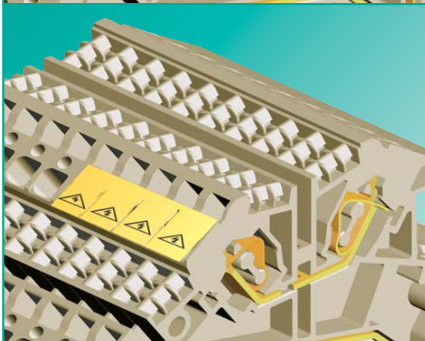

Cover with warning symbol

- Cover with warning symbol **ADC** to snap on to blocks which remain live when the main switch is disconnected (VDE 0113)
- Can only be removed with a screwdriver

DQS certificates for all company divisions

- Quality standard as per DIN ISO 9001 in development, production and assembly
- Continued control of the quality standard by means of regular internal and external quality audits
- Compatible with certificates of other countries:
 - BSI Certificate, Great Britain
 - SQS Certificate, Switzerland
 - Aib-Vincotte Certificate, Belgium
 - ÖQS Certificate, Austria

Material

Metal parts

Special alloys enable a low contact resistance and provide a gas-tight contact area

Clamping spring: stainless CrNi steel
Current carrying bar: tin-plated copper

Insulation material

Polyamide has excellent electrical, chemical and mechanical characteristics

Insulating housings: Polyamide 66/6

Tracking current resistance: CTI 600

Flammability class: UL 94-V0

(also see master catalog section **facts & DATA**)

You can use our **wieplan** software to configure your own terminal block assemblies (see page 10/11).

Note:

The information regarding cross sectional area and connection types pertains to unprepared wires without ferrules.

The voltage ratings apply to the terminals in their intended application. When different products are mounted adjacent to each other, the proper isolation distances must be adhered to. For this purpose, **Wieland** offers a large selection of appropriate accessories.

A detailed description of technical data, the standards' requirements, and the application conditions can be found in part catalog section **facts & DATA**: "Technical information".



Terminal blocks for electrical installations, type WKIF

fasis BIT

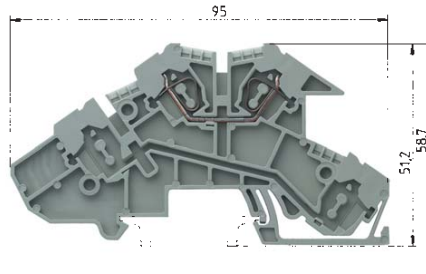

Upper tier equipped only!

D – line feedthrough, upper tier

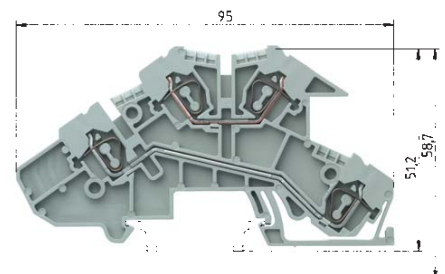

D – line feedthrough

D – line feedthrough

WKIF 2.5 D

fine stranded	solid	V	A
0.13 – 2.5 mm ²	0.13 – 4 mm ²	400 V/6 kV/3	24
UL			
No. 22-12 AWG		300 V	20
5 mm			11 mm

WKIF 2.5 D-D

fine stranded	solid	V	A
0.13 – 2.5 mm ²	0.13 – 4 mm ²	400 V/6 kV/3	24
UL			
No. 22-12 AWG		300 V	20
5 mm			11 mm

EN 60947-7-1/DIN VDE 0611 T1

UL ratings field/factory wiring

CSA ratings

Width Wire strip length

Approvals

Installation block	Color: gray	Type	Part no.	Std. pack	Type	Part no.	Std. pack
		WKIF 2,5 D	56.703.9653.0	50	WKIF 2,5 D-D	56.703.9753.0	50
Accessories							
1. Mounting rail TS 35, DIN rail 7.5mm high	L = 2 m	35 x 27 x 7,5 EN 60715	98.300.0000.0	1	35 x 27 x 7,5 EN 60715	98.300.0000.0	1
Mounting rail TS 35, DIN rail 15mm high	L = 2 m	35 x 24 x 15 EN 60715	98.360.0000.0	1	35 x 24 x 15 EN 60715	98.360.0000.0	1
2. End clamp for TS 35, with screw	8 mm wide	9708/2 S35	Z5.522.8553.0	100	9708/2 S35	Z5.522.8553.0	100
End clamp for TS 35, without screws	8 mm wide	WEF 1/35	Z5.523.9353.0	100	WEF 1/35	Z5.523.9353.0	100
3. End plate	1.5 mm wide	APIF 2,5	07.311.8353.0	10	APIF 2,5	07.311.8353.0	10
4. Cross connector, insulated jumper bar	2pole	IVB WKF 2,5-2	Z7.280.6227.0	10	IVB WKF 2,5-2	Z7.280.6227.0	10
	3pole	IVB WKF 2,5-3	Z7.280.6327.0	10	IVB WKF 2,5-3	Z7.280.6327.0	10
	4pole	IVB WKF 2,5-4	Z7.280.6427.0	10	IVB WKF 2,5-4	Z7.280.6427.0	10
	5pole	IVB WKF 2,5-5	Z7.280.6527.0	10	IVB WKF 2,5-5	Z7.280.6527.0	10
	6pole	IVB WKF 2,5-6	Z7.280.6627.0	10	IVB WKF 2,5-6	Z7.280.6627.0	10
	7pole	IVB WKF 2,5-7	Z7.280.6727.0	20	IVB WKF 2,5-7	Z7.280.6727.0	20
	8pole	IVB WKF 2,5-8	Z7.280.6827.0	20	IVB WKF 2,5-8	Z7.280.6827.0	20
	9pole	IVB WKF 2,5-9	Z7.280.6927.0	20	IVB WKF 2,5-9	Z7.280.6927.0	20
	10pole*	IVB WKF 2,5-10	Z7.280.7027.0	20	IVB WKF 2,5-10	Z7.280.7027.0	20
5. Wire entry guide	0.13 – 0.2 mm ²	LEL 2,5/1 WEISS	05.561.6553.0	100	LEL 2,5/1 WEISS	05.561.6553.0	100
	0.25 – 0.5 mm ²	LEL 2,5/2 GRAU	05.561.6653.0	100	LEL 2,5/2 GRAU	05.561.6653.0	100
	0.75 – 1.0 mm ²	LEL 2,5/3 SCHWARZ	05.561.6753.0	100	LEL 2,5/3 SCHWARZ	05.561.6753.0	100
6. Cover with warning symbol over 4 blocks		ADF 2,5/4 GELB	04.343.6053.8	10	ADF 2,5/4 GELB	04.343.6053.8	10
7. Busbar, E-Cu 10x3 mm, tin-plated	L = 1 m	9813 M Sn	98.290.1000.0	1	9813 M Sn	98.290.1000.0	1
8. Connector clamp for busbar							
	16 mm ² 8.5 mm wide	WAK 16/2 BLAU	30.494.3021.6	100	WAK 16/2 BLAU	30.494.3021.6	100
	35 mm ² 17 mm wide	WAK 35/2	30.494.4121.0	50	WAK 35/2	30.494.4121.0	50
9. Busbar support	2 mm wide	WKIF/SH/35	01.108.7653.0	10	WKIF/SH/35	01.108.7653.0	10
Busbar support, as end clamp	8 mm wide	WKIF SH/E/35	Z1.108.8453.0	10	WKIF SH/E/35	Z1.108.8453.0	10
10. Screwdriver, uninsulated		DIN 5264 B 0,6 x 3,5	06.502.4000.0	5	DIN 5264 B 0,6 x 3,5	06.502.4000.0	5
Marking accessories see page 48/49 and page 90/91		*Available up to 20 poles					

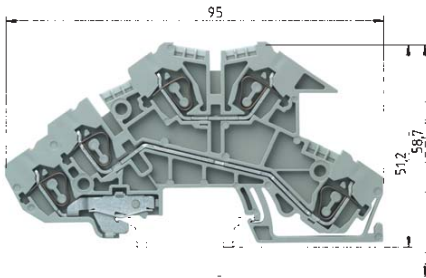

D – line feedthrough
D – line feedthrough
SL – ground

WKIF 2.5 D-D-SL

fine stranded	solid	V	A
0.13 – 2.5 mm ²	0.13 – 4 mm ²	400 V/250 V/4 kV/3	24
UL			
No. 22-12 AWG	300 V	20	
5 mm	11 mm		

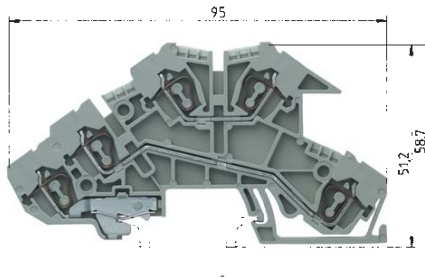

D – line feedthrough
N – neutral feedthrough
SL – ground

WKIF 2.5 N-D-SL

fine stranded	solid	V	A
0.13 – 2.5 mm ²	0.13 – 4 mm ²	400 V/250 V/4 kV/3	24
UL			
No. 22-12 AWG	300 V	20	
5 mm	11 mm		

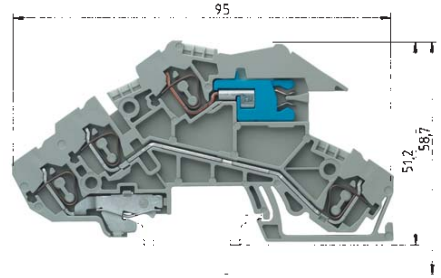

D – line feedthrough
NT – neutral feedthrough, disconnectable
SL – ground

WKIF 2.5 NT-D-SL

fine stranded	solid	V	A
0.13 – 2.5 mm ²	0.13 – 4 mm ²	400 V/250 V/6 kV/3	20
UL			
No. 22-12 AWG	300 V	20	
5 mm	11 mm		

Type	Part no.	Std. pack	Type	Part no.	Std. pack	Type	Part no.	Std. pack
WKIF 2,5 D-D-SL	56.703.9853.0	50	WKIF 2,5 N-D-SL	56.703.9453.0	50	WKIF 2,5 NT-D-SL	56.703.9553.0	50
35 x 27 x 7,5 EN 60715	98.300.0000.0	1	35 x 27 x 7,5 EN 60715	98.300.0000.0	1	35 x 27 x 7,5 EN 60715	98.300.0000.0	1
35 x 24 x 15 EN 60715	98.360.0000.0	1	35 x 24 x 15 EN 60715	98.360.0000.0	1	35 x 24 x 15 EN 60715	98.360.0000.0	1
9708/2 S35	Z5.522.8553.0	100	9708/2 S35	Z5.522.8553.0	100	9708/2 S35	Z5.522.8553.0	100
WEF 1/35	Z5.523.9353.0	100	WEF 1/35	Z5.523.9353.0	100	WEF 1/35	Z5.523.9353.0	100
APIF 2,5	07.311.8353.0	10	APIF 2,5	07.311.8353.0	10	APIF 2,5	07.311.8353.0	10
IVB WKF 2,5-2	Z7.280.6227.0	10	IVB WKF 2,5-2	Z7.280.6227.0	10	IVB WKF 2,5-2	Z7.280.6227.0	10
IVB WKF 2,5-3	Z7.280.6327.0	10	IVB WKF 2,5-3	Z7.280.6327.0	10	IVB WKF 2,5-3	Z7.280.6327.0	10
IVB WKF 2,5-4	Z7.280.6427.0	10	IVB WKF 2,5-4	Z7.280.6427.0	10	IVB WKF 2,5-4	Z7.280.6427.0	10
IVB WKF 2,5-5	Z7.280.6527.0	10	IVB WKF 2,5-5	Z7.280.6527.0	10	IVB WKF 2,5-5	Z7.280.6527.0	10
IVB WKF 2,5-6	Z7.280.6627.0	10	IVB WKF 2,5-6	Z7.280.6627.0	10	IVB WKF 2,5-6	Z7.280.6627.0	10
IVB WKF 2,5-7	Z7.280.6727.0	20	IVB WKF 2,5-7	Z7.280.6727.0	20	IVB WKF 2,5-7	Z7.280.6727.0	20
IVB WKF 2,5-8	Z7.280.6827.0	20	IVB WKF 2,5-8	Z7.280.6827.0	20	IVB WKF 2,5-8	Z7.280.6827.0	20
IVB WKF 2,5-9	Z7.280.6927.0	20	IVB WKF 2,5-9	Z7.280.6927.0	20	IVB WKF 2,5-9	Z7.280.6927.0	20
IVB WKF 2,5-10	Z7.280.7027.0	20	IVB WKF 2,5-10	Z7.280.7027.0	20	IVB WKF 2,5-10	Z7.280.7027.0	20
LEL 2,5/1 WEISS	05.561.6553.0	100	LEL 2,5/1 WEISS	05.561.6553.0	100	LEL 2,5/1 WEISS	05.561.6553.0	100
LEL 2,5/2 GRAU	05.561.6653.0	100	LEL 2,5/2 GRAU	05.561.6653.0	100	LEL 2,5/2 GRAU	05.561.6653.0	100
LEL 2,5/3 SCHWARZ	05.561.6753.0	100	LEL 2,5/3 SCHWARZ	05.561.6753.0	100	LEL 2,5/3 SCHWARZ	05.561.6753.0	100
ADF 2,5/4 GELB	04.343.6053.8	10	ADF 2,5/4 GELB	04.343.6053.8	10	ADF 2,5/4 GELB	04.343.6053.8	10
9813 M Sn	98.290.1000.0	1	9813 M Sn	98.290.1000.0	1	9813 M Sn	98.290.1000.0	1
WAK 16/2 BLAU	30.494.3021.6	100	WAK 16/2 BLAU	30.494.3021.6	100	WAK 16/2 BLAU	30.494.3021.6	100
WAK 35/2	30.494.4121.0	50	WAK 35/2	30.494.4121.0	50	WAK 35/2	30.494.4121.0	50
WKIF/SH/35	01.108.7653.0	10	WKIF/SH/35	01.108.7653.0	10	WKIF/SH/35	01.108.7653.0	10
WKIF SH/E/35	Z1.108.8453.0	10	WKIF SH/E/35	Z1.108.8453.0	10	WKIF SH/E/35	Z1.108.8453.0	10
DIN 5264 B 0,6 x 3,5	06.502.4000.0	5	DIN 5264 B 0,6 x 3,5	06.502.4000.0	5	DIN 5264 B 0,6 x 3,5	06.502.4000.0	5

DIN rail terminal blocks with spring connection, type **WKF**

fasis BIT

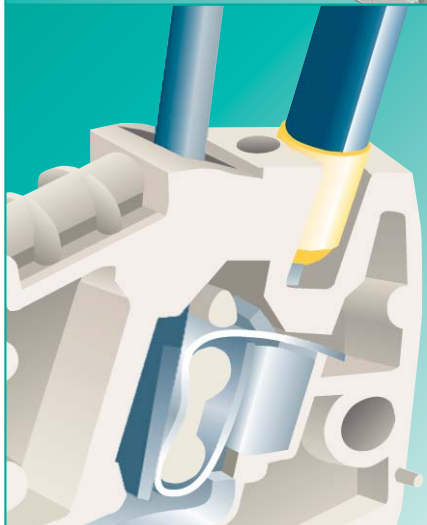
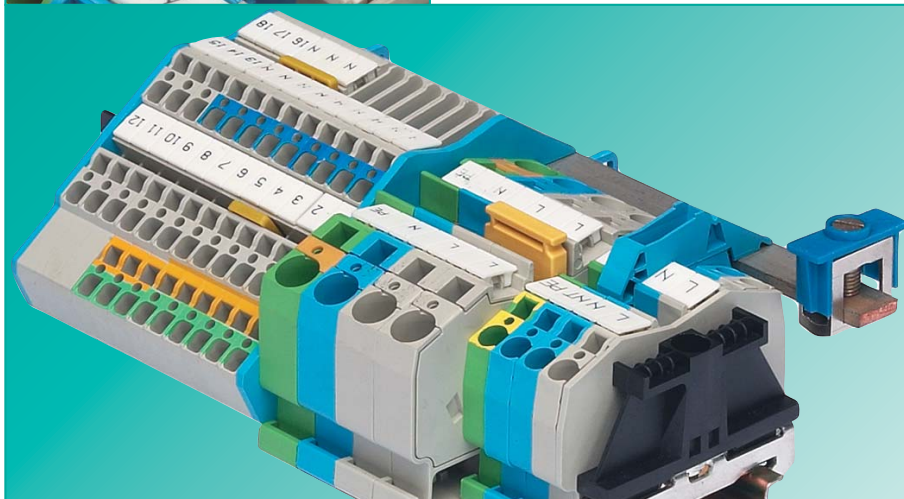
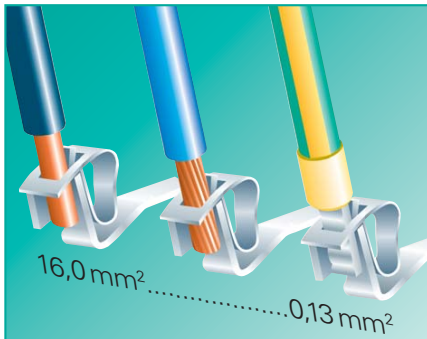

WKF provides ...

- Spring connection technology – screwless connection**
Separation of electrical and mechanical functions
- TOP connection**
Wire entry and operation in same plane
- Testing capabilities**
- Neutral conductor disconnect function**
- Economic system**

Connection capabilities

The clamping bodies of the WKFseries can take in any copper conductor types without ferrules

Due to the construction of the funnelled wire entry, stripped wires can be connected without causing wire splitting, provided that they are used in the proper way

Tool

For an optimal operation of our terminal blocks with spring connection we recommend to use the following DIN 5264 screwdrivers
i.e. cylinder-shaped screwdrivers with wedge-shaped blades

Application advantages

- **Dynamic terminal connection**
Balances the cold flow properties of the connection
- **Personnel cannot influence the clamping force** (no torque specs)
The clamping force required to connect a certain conductor, is determined by the spring element at the clamp
- **Secure and maintenance-free electrical connection**
according to EN 60947-7-1
- **Clear wiring in difficult and confined wiring applications**
- **Testing is possible on all** termination points by means of test plugs of up to 2.3 mm in diameter without having to disconnect the wires
- **Screwless disconnect unit**
Easy and safe disconnection of the neutral circuit with visual display of the circuit state
- **Time-saving due to pluggable accessories**

- fasis** BIT is designed to meet the wiring and connection requirements of distribution systems in commercial and institutional buildings (such as hospitals, schools, shopping malls, theaters, office buildings, airports) according to IEC 60364
- The neutral disconnect blocks of the WKIF/WKF series enable the required circuit isolation test without disconnecting the neutral conductor
- fasis** BIT is suited for small junction boxes with cover according to DIN 43871

- Both solid and stranded wires with and without ferrules can be connected to the WKF terminal blocks

→ Rated cross section	Blade dimensions of the screwdrivers
12 AWG 2.5 mm ²	0.6 x 3.5 mm
10 AWG 4 mm ²	0.6 x 3.5 mm
6 AWG 10 mm ²	0.8 x 4.0 mm
16 mm ²	1.0 x 5.5 mm

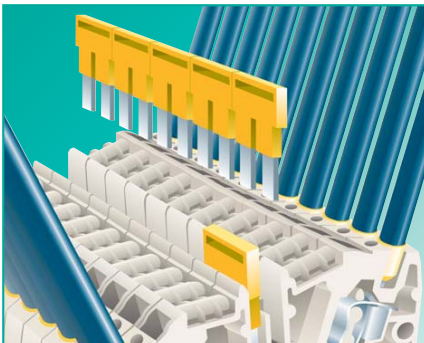

Cross connection

- The insulated jumper bars **IVB** WKF... are completely touchproof
- Partition plates are therefore not required between adjacent jumper bars of different potentials
- The insulated jumper bars **IVB** WKF... carry the same rated current as the corresponding feed through terminal block

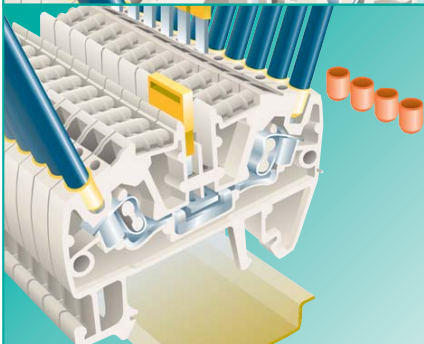

Wire entry guides

- Wire entry guides **LEL** are recommended when connecting wires with cross sections below 1 mm² or 18 AWG
- Wire entry guides **LEL** keep the wires from being inserted too far and therefore guarantee safe connection

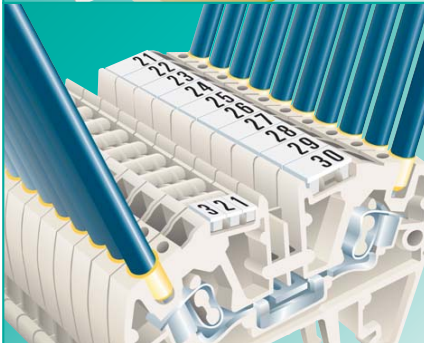

Marking facilities

- Marking facility is down the center so that the marking tag is not covered by the conductor
- Individual marking tag in 5mm spacing
- Snap-on marking strips (10 individual marking tags) for terminal block assemblies
- Tear-off marking strips for 3-digit marking facilities per block
- Custom marking upon request

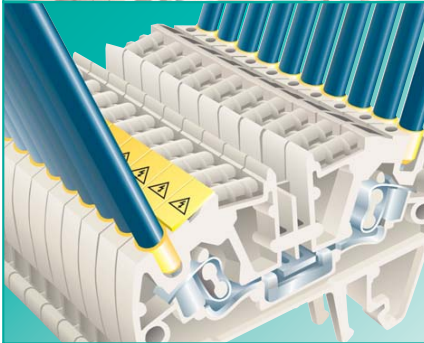

Cover with warning symbol

- Cover with warning symbol **ADC** to snap on to blocks which remain live when the main switch is disconnected (VDE 0113)
- The cover can only be removed with a screwdriver

DQS certificates for all companydivisions

- Quality standard as per DIN ISO 9001 in development, production and assembly
- Continued control of the quality standard by means of regular internal and external quality audits
- Compatible with certificates of other countries:
 - BSI Certificate, Great Britain
 - SQS Certificate, Switzerland
 - Aib-Vincotte Certificate, Belgium
 - ÖQS Certificate, Austria

Material

Metal parts

Special alloys enable a low contact resistance and provide a gas-tight contact area

Clamping spring: stainless CrNi steel

Current carrying bar: tin-plated copper

Insulation material

Polyamide has excellent electrical, chemical and mechanical characteristics

Insulating housings: Polyamide 66/6

Tracking current resistance: CTI 600

Flammability class:

WKF 4...	UL 94-V0
WKF 10...	UL 94-V0
WKIF 16...	UL 94-V2

(also see master catalog section **facts & DATA**)

You can use our **wieplan** software to configure your own terminal block assemblies (see page 10/11).

Note:

The information regarding cross sectional area and connection types pertains to unprepared wires without ferrules.

Ferrules are not required for safe connection!

The voltage ratings apply to the terminals in their intended application. When different products are mounted adjacent to each other, the proper isolation distances must be adhered to.

For this purpose, Wieland offers a large selection of appropriate accessories.

If the ground blocks of the WKF series are not used in block assemblies, but are mounted to the rail as single terminal blocks, end brackets have to be used.

A detailed description of technical data, the standards' requirements, and the application conditions can be found in part catalog section **facts & DATA**: "Technical information".



Feed-through blocks with spring connection for junction boxes, type WKF/WKIF

fasis BIT

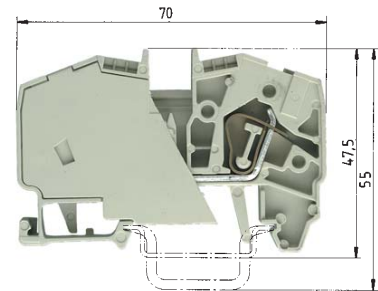
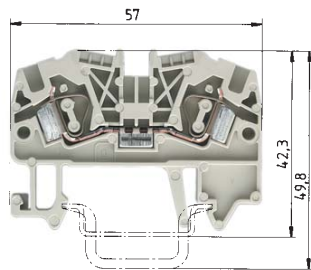

EN 60 947-7-1/DIN VDE 0611 T1
 UL ratings field/factory wiring
 CSA ratings
 Width Wire strip length
 Approvals

WKF 4/35

fine stranded solid V A
 0.13 – 4 mm² 0.13 – 6 mm² 800 V/8 kV/3 32
 No. 22-10 AWG 600 V 20/30
 No. 22-10 AWG 600 V 35
 6 mm 11 mm

UL SEV-EEX OVB N IVV P RINA LR
 LCIE BV

WKF 10/35

fine stranded solid V A
 2.5 – 10 mm² 2.5 – 10 mm² 800 V/8 kV/3 57
 No. 14-6 AWG 600 V 55
 No. 14-6 AWG 600 V 65
 10 mm 13 mm

UL LR

		Type	Part no.	Std. pack	Type	Part no.	Std. pack
Feed-through block	Color: gray	WKF 4/35	56.704.0053.0	100	WKF 10/35	56.710.0053.0	50
Feed-through block	Color: blue	WKF 4/35 BLAU	56.704.0053.6	100	WKF 10/35 BLAU	56.710.0053.6	50
Neutral disconnect block	Color: blue						
Ground block	Color: green/yellow						
Accessories							
1. Mounting rail TS 35, DIN rail 7.5 mm high	L = 2 m	35x27x7,5 EN 60715	98.300.0000.0	1	35x27x7,5 EN 60715	98.300.0000.0	1
Mounting rail TS 35, DIN rail 15 mm high	L = 2 m	35x24x15 EN 60715	98.360.0000.0	1	35x24x15 EN 60715	98.360.0000.0	1
2. End clamp TS 35, with screw	8 mm wide	9708/2 S35	Z5.522.8553.0	100	9708/2 S35	Z5.522.8553.0	100
End clamp TS 35, without screw	8 mm wide	WEF 1/35	Z5.523.9353.0	100	WEF 1/35	Z5.523.9353.0	100
3. End plate	Color: gray	APF 2,5 – 4	07.312.2153.0	10			
	Color: blue	APF 2,5 – 4 BLAU	07.312.2153.6	10			
4. Partition plate	Color: gray	TWF 2,5 – 4	07.312.2253.0	10			
	Color: blue	TWF 2,5 – 4 BLAU	07.312.2253.6	10			
5. Cross connector insulated	2pole	IVB WKF 4 – 2	Z7.261.1227.0	10	IVB WKF 10 – 2	Z7.283.8227.0	10
(jumper bar)	3pole	IVB WKF 4 – 3	Z7.261.1327.0	10			
	4pole	IVB WKF 4 – 4	Z7.261.1427.0	10			
	5pole	IVB WKF 4 – 5	Z7.261.1527.0	10			
	6pole	IVB WKF 4 – 6	Z7.261.1627.0	10			
	7pole	IVB WKF 4 – 7	Z7.261.1727.0	20			
	8pole	IVB WKF 4 – 8	Z7.261.1827.0	20			
	9pole	IVB WKF 4 – 9	Z7.261.1927.0	20			
	10pole	IVB WKF 4 – 10	Z7.261.2027.0	20			
6. Wire entry guide	0.13 – 0.2 mm ²	LEL 4/1 WEISS	05.561.8553.0	100			
	0.25 – 0.5 mm ²	LEL 4/2 GRAU	05.561.8653.0	100			
	0.75 – 1.0 mm ²	LEL 4/3 SCHWARZ	05.561.8753.0	100			
7. Cover with warning symbol 4 blocks		ADF 4/4 GELB	04.343.6153.8	10	ADF 10/4 GELB	04.343.6453.8	10
8. Busbar, E-Cu 10x3 mm, tin-plated	L = 1 m						
9. Connector clamp for busbar	8.5 mm wide						
	17 mm wide						
10. Busbar support, as end clamp	8 mm wide						
11. Screwdriver, uninsulated		DIN 5264 B 0,6x3,5	06.502.4000.0	5	DIN 5264 B 0,8x4	06.502.4100.0	5
Marking accessories see page 48/49 and page 90/91							

Neutral disconnect blocks with spring connection for junction boxes, type WKF/WKIF

fasis BIT

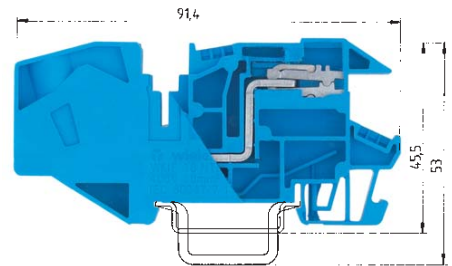
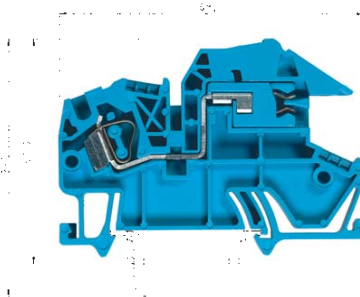

WKF 4 NT/35

fine stranded	solid	V	A
0.13 – 4 mm ²	0.13 – 6 mm ²	400 V/6 kV/3	30
		600 V	20
No. 22-10 AWG		600 V	25
6 mm		11 mm	



WKIF 16 NT/35

fine stranded	stranded	V	A
4 – 16 mm ²	4 – 16 mm ²	400 V/6 kV/3	68
12 mm			16 mm

EN 60 947-7-1; 1991/DIN VDE 0611 T1/08.92

UL ratings

CSA ratings

Width

Approvals

Wire strip length

		Type	Part no.	Std. pack	Type	Part no.	Std. pack
Feed-through block	Color: gray						
Feed-through block	Color: blue						
Neutral disconnect block	Color: blue	WKF 4 NT/35	56.704.8153.0	100	WKIF 16 NT/35	56.716.8153.0	50
Ground block	Color: green/yellow						
Accessories							
1. Mounting rail TS 35, DIN rail 7.5 mm high	L = 2 m	35x27x7,5 EN 60715	98.300.0000.0	1	35x27x7,5 EN 60715	98.300.0000.0	1
Mounting rail TS 35, DIN rail 15 mm high	L = 2 m	35x24x15 EN 60715	98.360.0000.0	1	35x24x15 EN 60715	98.360.0000.0	1
2. End clamp TS 35, with screw	8 mm wide	9708/2 S35	Z5.522.8553.0	100	9708/2 S35	Z5.522.8553.0	100
End clamp TS 35, without screw	8 mm wide	WEF 1/35	Z5.523.9353.0	100	WEF 1/35	Z5.523.9353.0	100
3. End plate	Color: gray						
	Color: blue	APF 4 NT	07.312.5653.0	10			
	Color: green						
4. Partition plate							
5. Cross connector insulated	2pole	IVB WKF 4 – 2	Z7.261.1227.0	10	IVB WKIF 16 – 2	Z7.284.6227.0	10
(jumper bar)	3pole	IVB WKF 4 – 3	Z7.261.1327.0	10			
	4pole	IVB WKF 4 – 4	Z7.261.1427.0	10			
	5pole	IVB WKF 4 – 5	Z7.261.1527.0	10			
	6pole	IVB WKF 4 – 6	Z7.261.1627.0	10			
	7pole	IVB WKF 4 – 7	Z7.261.1727.0	20			
	8pole	IVB WKF 4 – 8	Z7.261.1827.0	20			
	9pole	IVB WKF 4 – 9	Z7.261.1927.0	20			
	10pole	IVB WKF 4 – 10	Z7.261.2027.0	20			
6. Wire entry guide	0.13 – 0.2 mm ²	LEL 4/1 WEISS	05.561.8553.0	100			
	0.25 – 0.5 mm ²	LEL 4/2 GRAU	05.561.8653.0	100			
	0.75 – 1.0 mm ²	LEL 4/3 SCHWARZ	05.561.8753.0	100			
7. Cover with warning symbols over 4 blocks		ADF 4/4 GELB	04.343.6153.8	10			
8. Busbar, E-Cu 10x3 mm, tin-plated	L = 1 m	9813 M SN	98.290.1000.0	1	9813 M SN	98.290.1000.0	1
9. Connector clamp for busbar	8.5 mm wide	WAK 16/2 BLAU	30.494.3021.6	100	WAK 16/2 BLAU	30.494.3021.6	100
	17 mm wide	WAK 35/2	30.494.4121.0	50	WAK 35/2	30.494.4121.0	50
10. Busbar support as, end clamp	8 mm wide	WKIF SH/E/35	Z1.108.8453.0	10	WKIF SH/E/35	Z1.108.8453.0	10
11. Screwdriver, uninsulated		DIN 5264 B 0,6x3,5	06.502.4000.0	5	DIN 5264 B 1x5	06.502.4200.0	5
Marking accessories see page 48/49 and page 90/91							

fasis

fasis

Ground blocks with spring connection for junction boxes, type **WKF/WKIF**

fasis BIT

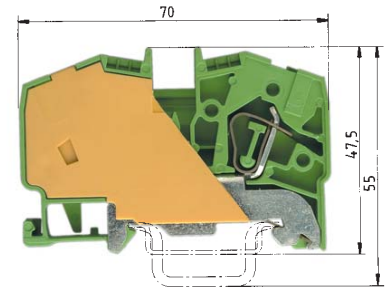
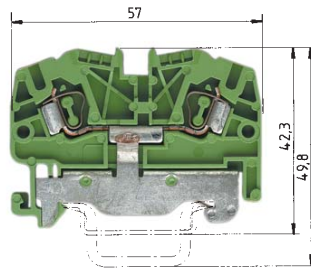

Ratings for adjacent feed-through blocks of same series and size
Current carrying capabilities of the mounting rails see catalog section **facts & DATA**

Ratings for adjacent feed-through blocks of same series and size
Current carrying capabilities of the mounting rails see catalog section **facts & DATA**

WKF 4 SL/35

fine stranded	solid	V	A
0.13 – 4 mm ²	0.13 – 6 mm ²	800 V/8 kV/3	32
No. 22-10 AWG		600 V	
No. 22-10 AWG		600 V	
6 mm			11 mm

WKF 10 SL/35

fine stranded	solid	V	A
2.5 – 10 mm ²	2.5 – 10 mm ²	800 V/8 kV/3	57
No. 14-6 AWG		600 V	
No. 14-6 AWG		600 V	
10 mm			13 mm

EN 60 947-7-2/DIN VDE 0611 T3
UL ratings field/factory wiring
CSA ratings
Width Wire strip length
Approvals



	Type	Part no.	Std. pack	Type	Part no.	Std. pack
Feed-through block Color: gray						
Feed-through block Color: blue						
Neutral disconnect block Color: blue						
Ground block Color: green/yellow	WKF 4 SL/35	56.704.9053.0	100	WKF 10 SL/35	56.710.9053.0	50
Accessories						
1. Mounting rail TS 35, DIN rail 7.5mm high L = 2 m	35 x 27 x 7,5 EN 60715	98.300.0000.0	1	35 x 27 x 7,5 EN 60715	98.300.0000.0	1
Mounting rail TS 35, DIN rail 15mm high L = 2 m	35 x 24 x 15 EN 60715	98.360.0000.0	1	35 x 24 x 15 EN 60715	98.360.0000.0	1
2. End clamp for TS 35, with screw 8 mm wide	9708/2 S35	Z5.522.8553.0	100	9708/2 S35	Z5.522.8553.0	100
End clamp for TS 35, without screws 8 mm wide	WEF 1/35	Z5.523.9353.0	100	WEF 1/35	Z5.523.9353.0	100
3. End plate Color: gray						
Color: blue						
Color: green	APF 2,5-4 GRÜN	07.312.2153.7	10			
4. Partition plate Color: gray						
Color: blue						
5. Cross connector insulated 2pole						
(jumper bar) 3pole						
4pole						
5pole						
6pole						
7pole						
8pole						
9pole						
10pole						
6. Wire entry guide 0.13 – 0.2 mm ²	LEL 4/1 WEISS	05.561.8553.0	100			
0.25 – 0.5 mm ²	LEL 4/2 GRAU	05.561.8653.0	100			
0.75 – 1.0 mm ²	LEL 4/3 SCHWARZ	05.561.8753.0	100			
7. Cover with warning symbol over 4 blocks	ADF 4/4 GELB	04.343.6153.8	10	ADF 10/4 GELB	04.343.6453.8	10
8. Busbar, E-Cu 10 x 3 mm, tin-plated L = 1 m						
9. Connector clamp for busbar 8.5 mm wide						
	17 mm wide					
10. Busbar support, as end clamp 8 mm wide						
11. Screwdriver, uninsulated	DIN 5264 B 0,6 x 3,5	06.502.4000.0	5	DIN 5264 B 0,8 x 4	06.502.4100.0	5
Marking accessories see page 48/49 and page 90/91						

Terminal blocks for electrical installations
with screw connection, type WKI

selos BIT

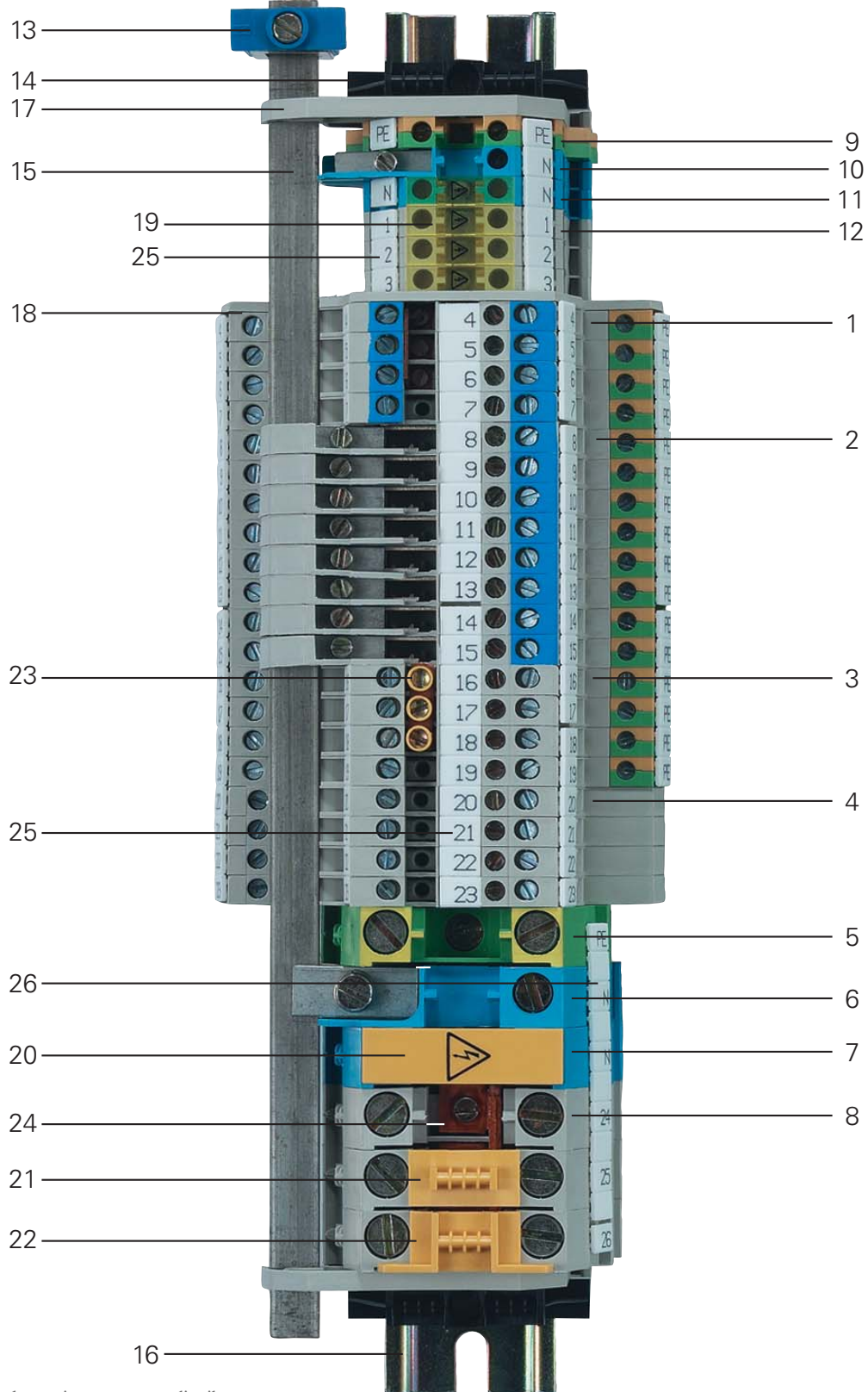

selos

Item Description	Type	Part number
1 Installation blocks	WKI 4 N-D-SL	56.404.9455.0
2 Installation blocks	WKI 4 NT-D-SL	56.404.9555.0
3 Installation blocks	WKI 4 D-D-SL	56.404.9855.0
4 Installation block	WKI 4 D-D	56.404.9755.0
5 Ground block	WKI 16 SL/35	56.516.9255.0
6 Neutral disconnect block	WKI 16 ETK/U	57.516.8255.0
7 Feed through block	WKI 16 /U BLAU	57.516.1155.6
8 Feed through block	WKI 16 /U	57.516.1155.0
9 Ground block	WK 4 SL/U	57.504.9055.0
10 Neutral disconnect block	WKN 4 ETK/U	57.504.8155.0
11 Feed through block	WK 4 /U BLAU	57.504.0055.6
12 Feed through block	WK 4 /U	57.504.0055.0
13 Connector clamp	WAK 16/2 BLAU	30.494.3021.6
14 End clamp	9708/2 S35	Z5.522.8553.0
15 Busbar 10 x 3	9813 M Sn	98.290.1000.0
16 Mounting rail	35 x 27 x 7.5	98.300.0000.0
17 Busbar support	WKI SH/U	01.108.3255.0
18 End plate	API 4/2	07.311.6555.0
19 Cover with warning symbol	AD 4/4 GELB	04.343.4856.8
20 Cover with warning symbol	ADI 16/1 GELB	04.325.8553.8
21 Cover with marking facility	AD VB 16 GELB	04.326.2453.8
22 Partition plate with marking facility	TS 16 GELB	07.311.2453.8
23 Cross connector, insulated (12pole)	IVB WKI 4-12	Z7.271.5227.0
24 Cross connector, uninsulated	VB WKI 16-3	Z7.289.0327.0
25 Marking strip	9705 A/6/10 B	04.842.6053.0
26 Marking strip	9705 A/6/10/5 B	04.842.6553.0

Terminal blocks for electrical installations with screw connection, type *WKI*

selos BIT

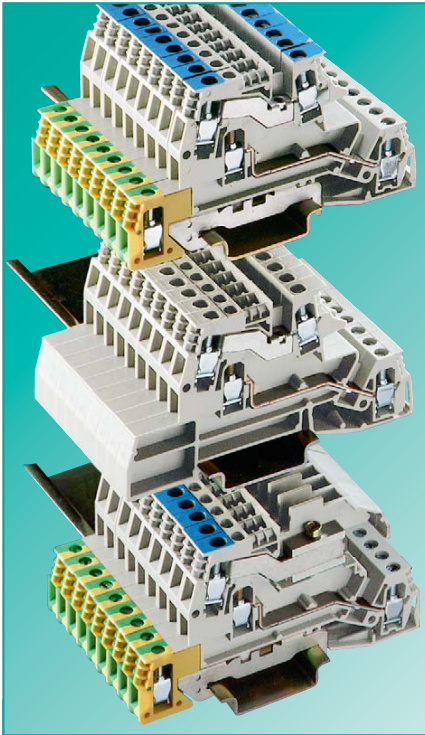

WKI provides ...

- Clear circuit identification
- Small dimensions in three-tier design
- Neutral conductor disconnect function
- All wire entry points in the same plane
- Mounting for TS 35 DIN rail
- Circuit protection via fuse
- Ground connection directly to the DIN rail

Application advantages

- Multiple circuits with color coding in one terminal block
- Best suited for small junction boxes with cover according to DIN 43871
- Fast and safe disconnection of the neutral conductor with WKI 4 NT-D-SL
- Easy wiring
- Sliding disconnect shows the state of the neutral circuit (open or closed)

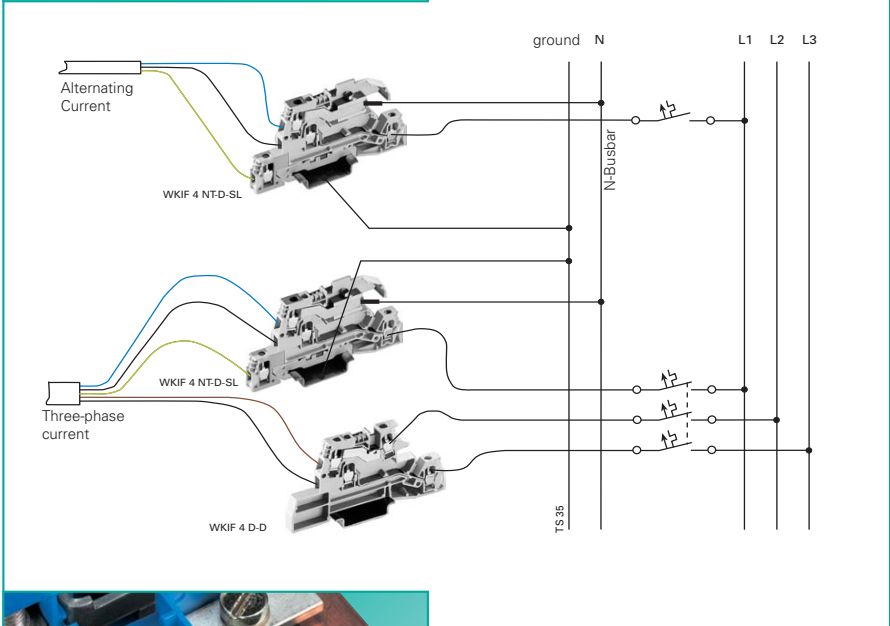

- selos BIT** is designed to meet the wiring and installation requirements of distribution systems in commercial and institutional buildings (such as hospitals, schools, shopping malls, theaters, office buildings, institutes, airports) according to IEC 60364 and standard control requirements

- WKI 4 NT-D-SL enables the required circuit isolation test without disconnecting the neutral conductor
- WKI provides installation blocks in 5 versions:
 WKI 4 DU
 WKI 4 D-D
 WKI 4 D-D-SL
 WKI 4 N-D-SL
 WKI 4 NT-D-SL

- 3 special variants:
 WKI 4 NT-D-SL-GL
 WKI 4 NTN-D-SL
 WKI 4 TKG-D-SL

- Other applications include control wiring. For example WKI 4 TKG-D-SL signal in one terminal with fusing of the (+) circuit

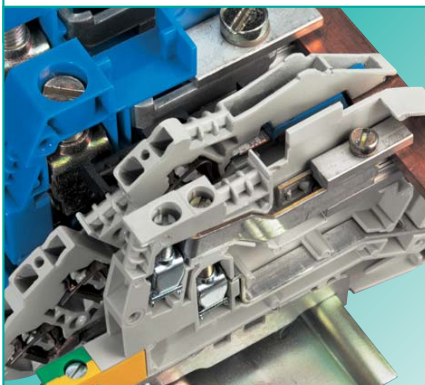

- Connection slot on the terminal block for the neutral busbar
- Captive hardware and vibration design

- The terminal blocks for electrical installations of the WKI series in the NT version can be combined with ...

the terminal blocks of the WKIF series (spring connection technology)

the neutral disconnect blocks (ETK) of the WKN series (screw connection technology)

selos

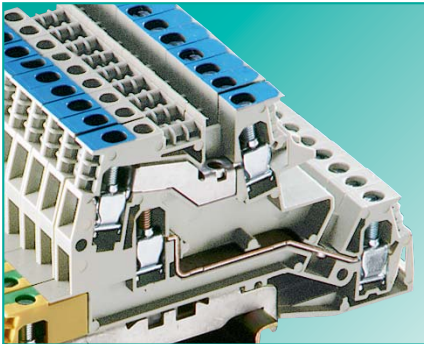

Jumpering with cross connectors

- Jumpering with insulated and uninsulated cross connectors (jumperbars)
- Cross connectors do not take up clamping space
- Uninsulated cross connectors can be cut to length
- When using cross connectors, end plates or partitions are required to maintain max. voltage rating
- Cross connectors come pre-assembled

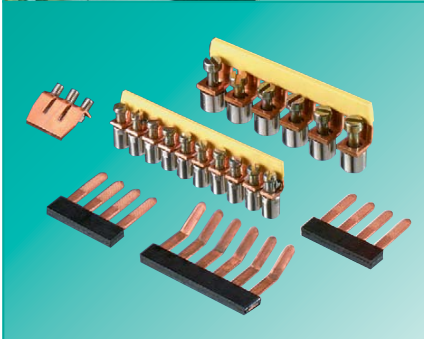

Jumpering with jumper combs

- Jumpering with insulated jumper combs
- Jumper comb and conductor are inserted in the clamping body and clamped

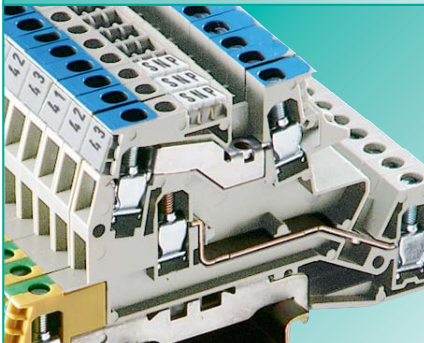

Marking facilities

- Marking facility for each termination point
- Tear-off marking strips for 3-digit marking facilities per block
- Single marking tags in 5 mm spacing
- Marking strips (10 individual marking tags) to snap on to 10 terminal blocks
- Custom marking upon request

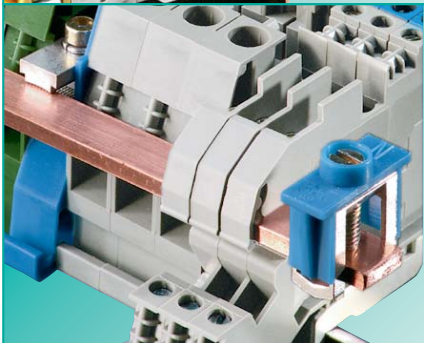

Connector clamps

- Connector clamps for busbar 10x3 mm (E-Cu, tin-plated)
- WAK 16/2... 0.75–16 mm²
- WAK 35/2... 16–35 mm²
- Clear identification of the circuit task when the external neutral conductor is connected to the busbar

DQS certificates for all company divisions

- Quality standard as per DIN ISO 9001 in Development, Production and Assembly
- Continued control of the quality standard by means of regular internal and external quality audits
- Compatible with certificates of other countries:
 - BSI Certificate, Great Britain
 - SQS Certificate, Switzerland
 - Aib-Vincotte Certificate, Belgium
 - ÖQS Certificate, Austria

Material

Metal parts

Special alloys enable a low contact resistance and provide a gas-tight contact area:

Clamping body/clamping screws:
Steel, zinc-plated and dichromated

Current carrying bar: tin-plated copper

Insulation material

Polyamide has excellent electrical, chemical and mechanical characteristics

Insulating housings: Polyamide 66/6

Tracking current resistance: CTI 600

Flammability class: UL 94-V0

(also see master catalog section **facts & DATA**: Technical information)

You can use our **wieplan** software to configure your own terminal block assemblies (see page 10/11).

Note:

The information regarding cross sectional area and connection types pertains to unprepared wires without ferrules.

The voltage ratings apply to the terminals in their intended application. When different products are mounted adjacent to each other, the proper isolation distances must be adhered to. For this purpose, **Wieland** offers a large selection of appropriate accessories.

A detailed description of technical data, the standards' requirements, and the application conditions can be found in part catalog section **facts & DATA**: "Technical information".



selos

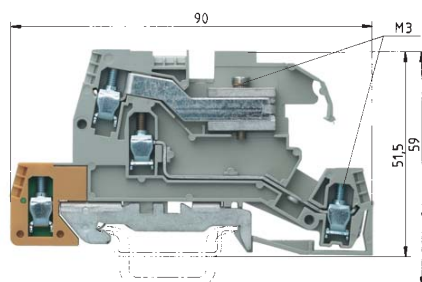
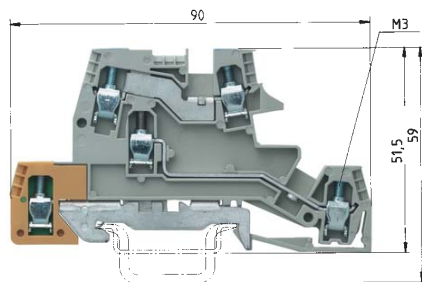
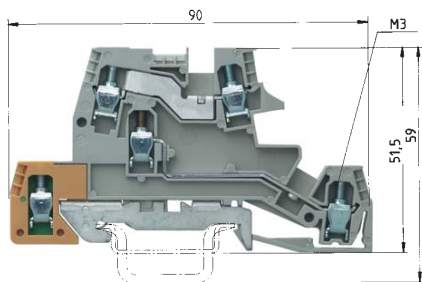

D – line feed through block
D – line feed through block
SL – ground

N – neutral feed-through block
D – line feed through block
SL – ground

N – disconnect block
D – line feed through block
SL – ground
GL – indicator lamp

WKI 4 D-D-SL

fine stranded	solid	V	A
0.5 – 4 mm ²	0.5 – 6 mm ²	400 V/6 kV/3	26*)
No. 22-10 AWG		300 V	24
No. 22-10 AWG		300 V	25
6 mm			7 mm



WKI 4 N-D-SL

fine stranded	solid	V	A
0.5 – 4 mm ²	0.5 – 6 mm ²	400 V/6 kV/3	26*)
No. 22-10 AWG		300 V	24
No. 22-10 AWG		300 V	25
6 mm			7 mm



WKI 4 NT-D-SL (-GL)

fine stranded	solid	V	A
0.5 – 4 mm ²	0.5 – 6 mm ²	400 V/6 kV/3	26*)
No. 22-10 AWG		300 V	24
No. 22-10 AWG		300 V	25
6 mm			7 mm



Type	Part no.	Std. pack	Type	Part no.	Std. pack	Type	Part no.	Std. pack
WKI 4 D-D-SL	56.404.9855.0	50	WKI 4 N-D-SL	56.404.9455.0	50	WKI 4 NT-D-SL	56.404.9555.0	50
						WKI 4 NT-D-SL-GL	56.404.9255.0	50
35 x 27 x 7,5 EN 60715	98.300.0000.0	1	35 x 27 x 7,5 EN 60715	98.300.0000.0	1	35 x 27 x 7,5 EN 60715	98.300.0000.0	1
35 x 24 x 15 EN 60715	98.360.0000.0	1	35 x 24 x 15 EN 60715	98.360.0000.0	1	35 x 24 x 15 EN 60715	98.360.0000.0	1
9708/2 S35	Z5.522.8553.0	100	9708/2 S35	Z5.522.8553.0	100	9708/2 S35	Z5.522.8553.0	100
WEF 1/35	Z5.523.9353.0	100	WEF 1/35	Z5.523.9353.0	100	WEF 1/35	Z5.523.9353.0	100
API 4/2	07.311.6555.0	10	API 4/2	07.311.6555.0	10	API 4/2	07.311.6555.0	10
TWI 4	07.311.6955.0	10	TWI 4	07.311.6955.0	10			
9703/6-2	Z7.211.0227.0	50	9703/6-2	Z7.211.0227.0	50	9703/6-2	Z7.211.0227.0	50
9703/6-6	Z7.211.0627.0	50	9703/6-6	Z7.211.0627.0	50	9703/6-6	Z7.211.0627.0	50
IVB WKI 4-12	Z7.271.5227.0	10	IVB WKI 4-12	Z7.271.5227.0	10	IVB WKI 4-12	Z7.271.5227.0	10
9703/6 M-70	Z7.211.0027.0	10	9703/6 M-70	Z7.211.0027.0	10	9703/6 M-70	Z7.211.0027.0	10
9813 M	98.290.0000.0	1	9813 M	98.290.0000.0	1	9813 M	98.290.0000.0	1
9813 M Sn	98.290.1000.0	1	9813 M Sn	98.290.1000.0	1	9813 M Sn	98.290.1000.0	1
WKI/SH/U	01.108.3255.0	10	WKI/SH/U	01.108.3255.0	10	WKI/SH/U	01.108.3255.0	10
WKIF SH/E/35	Z1.108.8453.0	10	WKIF SH/E/35	Z1.108.8453.0	10	WKIF SH/E/35	Z1.108.8453.0	10
WAK 16/2 BLAU	30.494.3021.6	100	WAK 16/2 BLAU	30.494.3021.6	100	WAK 16/2 BLAU	30.494.3021.6	100
WAK 35/2	30.494.4121.0	50	WAK 35/2	30.494.4121.0	50	WAK 35/2	30.494.4121.0	50
DIN 5264 B 0,6 x 3,5	06.502.4000.0	5	DIN 5264 B 0,6 x 3,5	06.502.4000.0	5	DIN 5264 B 0,6 x 3,5	06.502.4000.0	5

*CL I, ZN1, AExe II

Terminal blocks for electrical installations with screw connection, type WKI 4

selos BIT

Fuse application:
 Nominal current accord to VDE 0820 T2/EN 60 127-2 when using 1.6 W
 – 6.3 A for single blocks
 – 4 A for blocks mounted directly adjacent to each other
 Voltage and current are determined by the LED and the fuse used in the end application

Ground application:
 *) For the current carrying capability of the mounting rail see catalog **facts & DATA**

Busbar application:
 Position these terminals at the beginning or end of the assembly when incorporating the busbar system

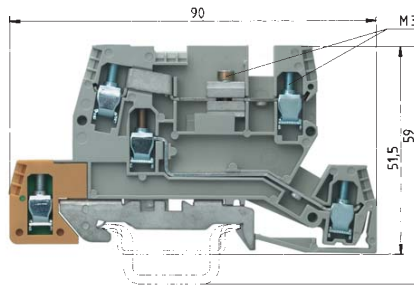

NTN – disconnect block
 D – line feed through block:
 SL – ground

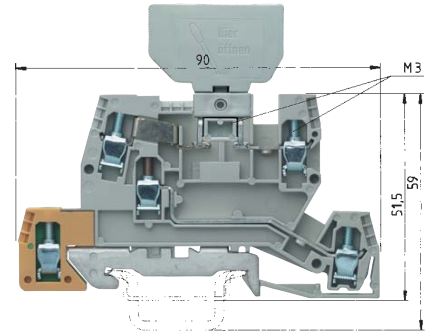

TKG – fuse plug for 5 x 20 fuse
 D – line feed through block:
 SL – ground block

WKI 4 NTN-D-SL

fine stranded	solid	V	A
0.5 – 4 mm ²	0.5 – 6 mm ²	400 V/6 kV/3	26*)
No. 22-10 AWG		300 V	24
No. 22-10 AWG		300 V	25
6 mm			7 mm



WKI 4 TKG-D-SL

fine stranded	solid	V	A
0.5 – 4 mm ²	0.5 – 6 mm ²	400 V/6 kV/3	26*)
No. 22-10 AWG		300 V	12
No. 22-10 AWG		300 V	25
6 mm			7 mm



EN 60 947-7-1, EN 60 947-7-2

UL ratings

CSA ratings

Width

Wire strip length

Approvals

	Type	Part no.	Std. pack	Type	Part no.	Std. pack	
Installation block	Color: gray	WKI 4 NTN-D-SL	56.404.9155.0	50	WKI 4 TKG-D-SL	56.404.8855.0	50
Fuse holder for 5 x 20 fuse	Color: gray				Si ST	Z1.299.4055.0	10
Fuse holder with indicator (24 V)	Color: gray				Si ST LED	Z1.299.4155.0	10
Fuse holder with indicator (110 – 220 V)	Color: gray				Si ST GL	Z1.299.4255.0	10
(G fuse-links DIN 41571, 250 V/6.3 A, 5 x 20 mm)							
Accessories							
1. Mounting rail TS 35, DIN rail 7.5 mm high L = 2 m	35 x 27 x 7,5 EN 60715	98.300.0000.0	1	35 x 27 x 7,5 EN 60715	98.300.0000.0	1	
Mounting rail TS 35, DIN rail 15 mm high L = 2 m	35 x 24 x 15 EN 60715	98.360.0000.0	1	35 x 24 x 15 EN 60715	98.360.0000.0	1	
2. End clamp for TS 35, with screw 8 mm wide	9708/2 S35	Z5.522.8553.0	100	9708/2 S35	Z5.522.8553.0	100	
End clamp, screwless 8 mm thick	WEF 1/35	Z5.523.9353.0	100	WEF 1/35	Z5.523.9353.0	100	
3. End plate 2 mm thick	API 4/3	07.311.6855.0	10	API 4/3	07.311.6855.0	10	
4. Partition plate							
5. Cross connector with screws, (jumper bar)							
uninsulated 2pole	9703/6-2	Z7.211.0227.0	50	9703/6-2	Z7.211.0227.0	50	
to 6pole	9703/6-6	Z7.211.0627.0	50	9703/6-6	Z7.211.0627.0	50	
insulated 12pole	IVB WKI 4-12	Z7.271.5227.0	10	IVB WKI 4-12	Z7.271.5227.0	10	
Field-divisible strip – 70pole	9703/6 M-70	Z7.211.0027.0	10	9703/6 M-70	Z7.211.0027.0	10	
6. Busbar, E-Cu 10 x 3 mm, I _N = 140 A L = 1 m							
Busbar, tin-plated, I _N = 140 A L = 1 m							
7. Busbar support 4 mm wide							
Busbar support 8 mm wide							
8. Connector clamp for busbar							
16 mm ² 8.5 mm wide							
35 mm ² 17 mm wide							
9. Screwdriver, uninsulated	DIN 5264 B 0,6 x 3,5	06.502.4000.0	5	DIN 5264 B 0,6 x 3,5	06.502.4000.0	5	
Marking accessories see page 48/49 and page 90/91							

selos

selos BIT

Terminal blocks with screw connection for junction boxes, type WKI

selos BIT

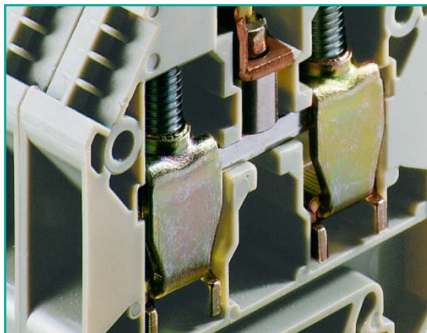

WKI provides ...

- Screw connection technology**
in rising cage clamp system with one-piece threaded collar



- Convenient handling**

- Neutral conductor disconnect**

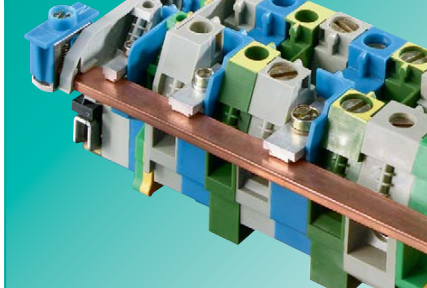
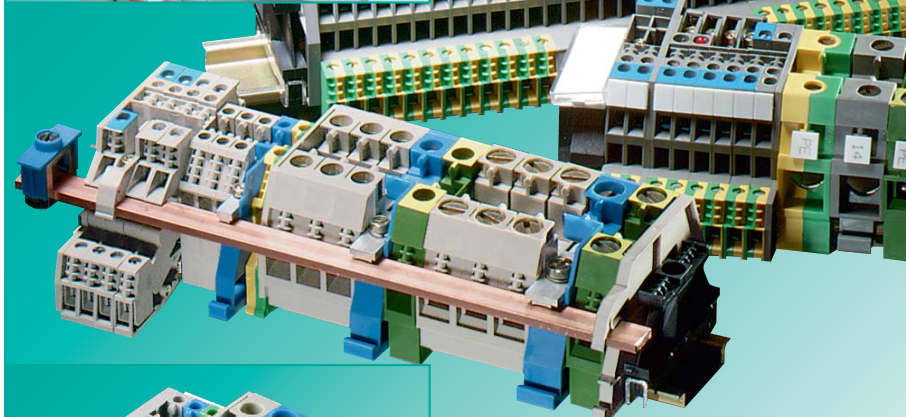

- Height**

Due to their height, the terminal blocks of the **selos BIT** family are suited for small junction boxes with cover according to DIN 43871.

- Connection slot on the terminal block for the neutral busbar

- Ground directly to the DIN rail

- Captive hardware and vibration resistant design

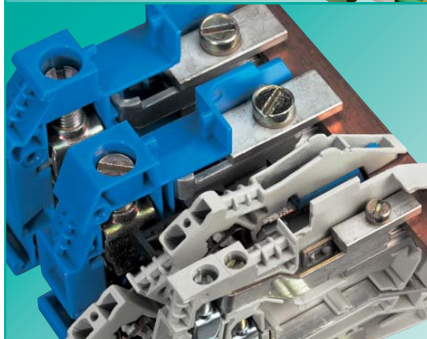

Application advantages

- **High connection range**
Connection of solid, fine stranded and stranded conductors in the rated wire gauge with and without ferrules
- **High clamping force, low contact resistance**
High tightening torques (master catalog, section 8) create high clamping forces for large contact areas resulting in low contact resistance and a gas tight connection
- **Clamping body**
Delivered in open position, ready to wire
- **Sliding disconnect**
clearly shows state (open or closed) of the circuit and allows quick and easy disconnect from the busbar

- selos BIT** is designed to meet the wiring and installation requirements of distribution systems in commercial and institutional buildings (such as hospitals, schools, shopping malls, theaters, office buildings, airports) according to IEC 60364

- The neutral disconnect blocks of the WKI series enable the required insulation test without disconnecting the neutral conductor

- The WKI series provides

Feed-through blocks	4–35 mm ² 10-2 AWG
Neutral disconnect blocks	4–16 mm ² 10-4 AWG
Ground blocks	4–35 mm ² 10-2 AWG
PEN assembly blocks	10–35 mm ² 6-2 AWG

- Neutral disconnect blocks (ETK) of the WKI series can be combined with ...

the installation blocks of the WKI series (screw connection technology)

Installation blocks of the WKIF series (spring connection technology)

Neutral disconnect blocks (ETK) of the WKN series (screw connection technology)

selos

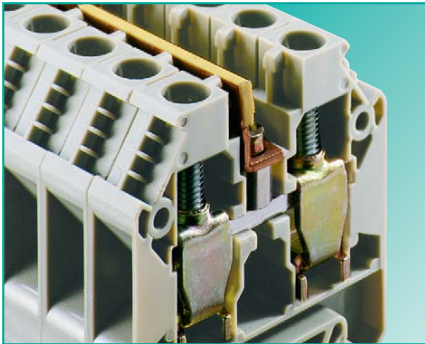

Cross connection

- ❑ Jumpering with insulated or uninsulated cross connectors (jumper bars)
- ❑ Insulated cross connectors are touch-safe according to regulation VBG 4
- ❑ Cross connectors come preassembled
- ❑ Available in 2– 12pole configurations or as a field-divisible strip – up to 70 poles
- ❑ When used with an end plate or partition the cross connector is rated for the same voltage as the terminal block

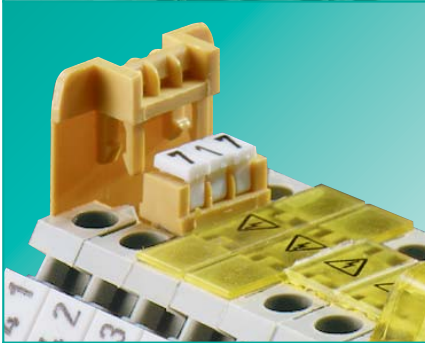

Partition plates

- ❑ Provides electrical and visual separation for adjacent terminal block groups
- ❑ Pre and post assembly versions
- ❑ Can only be removed with a screwdriver
- ❑ Post assembly version offers marking tag facility and cover
- ❑ 4-digit marking strip for additional marking



Marking facilities

- ❑ Marking facility at every termination point
- ❑ Tear-off marking strips for 3-digit marking facilities per block
- ❑ Single marking tags in 5 mm spacing
- ❑ Marking strips (10 individual marking tags) to snap on to 10 terminal blocks
- ❑ Custom marking upon request

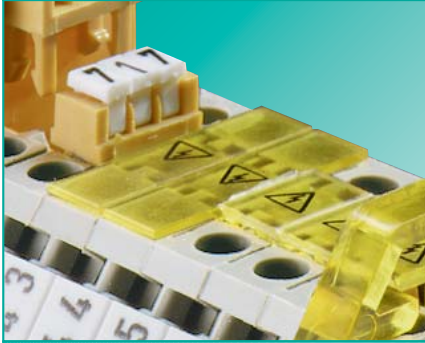

Cover

- ❑ Cover with warning symbol to snap on to blocks which remain live when the main switch is disconnected (VDE 0113)
- ❑ Cover for uninsulated cross connectors to prevent electrical shock
- ❑ Can only be removed with a screwdriver
- ❑ Extended covers available to prevent tampering with terminal block

DQS certificates for all company divisions

- ❑ Quality standard as per DIN ISO 9001 in development, production and assembly
- ❑ Continued control of the quality standard by means of regular internal and external quality audits
- ❑ Compatible with certificates of other countries:
 - BSI Certificate, Great Britain
 - SQS Certificate, Switzerland
 - Aib-Vincotte Certificate, Belgium
 - ÖQS Certificate, Austria

Material

❑ Metal parts

Special alloys enable a low contact resistance and provide a gas-tight contact area

Clamping body/clamping screws: steel, zinc-plated and dichromated

Current carrying bar: tin-plated copper

❑ Insulation material

Polyamide has excellent electrical, chemical and mechanical characteristics

Insulating housings: Polyamide 66/6

Tracking current resistance: CTI 600

Flammability class: UL 94-V0

(also see master catalog section **facts & DATA**: Technical information)

You can use our **wieplan** software to configure your own terminal block assemblies (see page 10/11).

Note:

The information regarding cross sectional area and connection types pertains to unprepared wires without ferrules.

The voltage ratings apply to the terminals in their intended application. When different products are mounted adjacent to each other, the proper isolation distances must be adhered to. For this purpose, **Wieland** offers a large selection of appropriate accessories.

A detailed description of technical data, the standards' requirements, and the application conditions can be found in part catalog section **facts & DATA**: "Technical information".



Terminal blocks with screw connection for junction boxes, type WKI

selos BIT

Additional colors available on request:
Contact Factory

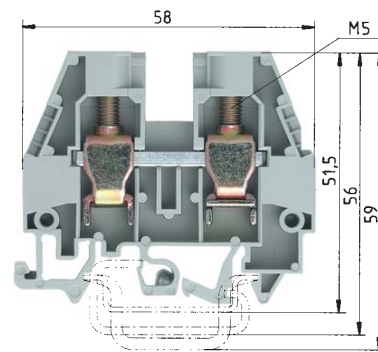
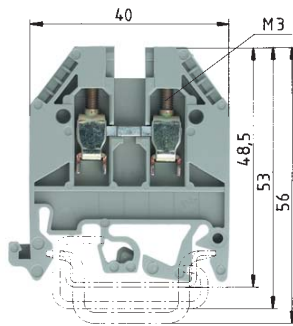

WK 4/U

fine stranded	solid	V	A
0.5 – 4 mm ²	0.5 – 6 mm ²	800 V/8 kV/3	32
No. 22-10 AWG		600 V	30/35
No. 20-10 AWG		600 V	40
6 mm			9 mm



WKI 10/U

fine stranded	stranded	V	A
1 – 10 mm ²	10 – 16 mm ²	400 V/6 kV/3	57
No. 16-6 AWG		600 V	65/65
No. 16-6 AWG		600 V	70
10 mm			18 mm



EN 60 947-7-1/DIN VDE 0611 T1

UL ratings field/factory

wiring

CSA ratings

Width

Approvals

field/factory

Wire strip length

		Type	Part no.	Std. pack	Type	Part no.	Std. pack
Feed through block	Color: gray	WK 4/U	57.504.0055.0	100	WKI 10/U	57.510.1155.0	50
Feed through block	Color: blue	WK 4/U BLAU	57.504.0055.6	100	WKI 10/U BLAU	57.510.1155.6	50
Accessories							
1. Mounting rail TS 35, DIN rail 7.5mm high	L = 2 m	35 x 27 x 7,5 EN 60715	98.300.0000.0	1	35 x 27 x 7,5 EN 60715	98.300.0000.0	1
Mounting rail TS 35, DIN rail 15mm high	L = 2 m	35 x 27 x 15 EN 60715	98.360.0000.0	1	35 x 27 x 15 EN 60715	98.360.0000.0	1
2. End clamp for TS 35, with screw	8 mm wide	9708/2 S35	Z5.522.8553.0	100	9708/2 S35	Z5.522.8553.0	100
End clamp for TS 35, without screws	8 mm wide	WEF 1/35	Z5.523.9353.0	100	WEF 1/35	Z5.523.9353.0	100
3. End plate	1.5 mm thick	Color: gray	AP 2,5-4	07.311.0155.0	10		
	1.5 mm thick	Color: blue	AP 2,5-4 BLAU	07.311.0155.6	10		
	1.5 mm thick	Color: green					
End plate	2 mm thick	Color: gray			API 10-16	07.311.9455.0	10
	2 mm thick	Color: blue			API 10-16 BLAU	07.311.9455.6	10
	2 mm thick	Color: green					
4. Partition plate	Color: gray	TW 2,5-4	07.311.1155.0	10			
	Color: blue	TW 2,5-4 BLAU	07.311.1155.6	10			
5. Cross connector with screws (jumper bar)	2pole	IVB WK 4-2	Z7.281.1227.0	10	IVB WKN 10-2	Z7.283.2227.0	10
	3pole	IVB WK 4-3	Z7.281.1327.0	10	IVB WKN 10-3	Z7.283.2327.0	10
	4pole	IVB WK 4-4	Z7.281.1427.0	10	IVB WKN 10-4	Z7.283.2427.0	10
	5pole	IVB WK 4-5	Z7.281.1527.0	10	IVB WKN 10-5	Z7.283.2527.0	10
	6pole	IVB WK 4-6	Z7.281.1627.0	10	IVB WKN 10-6	Z7.283.2627.0	10
6. Partition plate with marking facility	Color: yellow	TS 4 GELB	07.311.2153.8	10	TS 10 GELB	07.311.2353.8	10
7. Cover with marking facility	Color: yellow	AD VB 4 GELB	04.326.2153.8	10	AD VB 10 GELB	04.342.1056.8	10
8. Cover with warning symbol over 4 blocks	Color: yellow	AD 4/4 GELB	04.343.4856.8	10			
Cover with warning symbol for 1 block	Color: yellow				ADI 10/1 GELB	04.325.8553.8	10
9. Busbar							
	E-Cu 10 x 3 mm, tin-plated, I _N = 140	L = 1 m					
	E-Cu 10 x 3 mm, unplated, I _N = 140 A	L = 1 m					
10. Connector clamp for busbar							
	16 mm ²	8.5 mm wide					
	35 mm ²	17 mm wide					
11. Busbar support	4 mm wide						
Busbar support	8 mm wide						
Marking accessories see page 48/49 and page 90/91							

selos

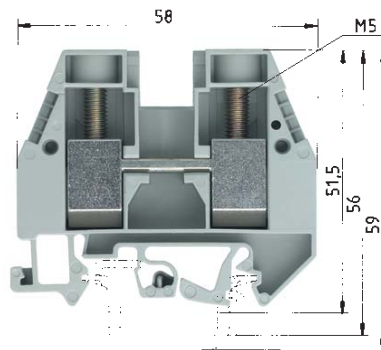
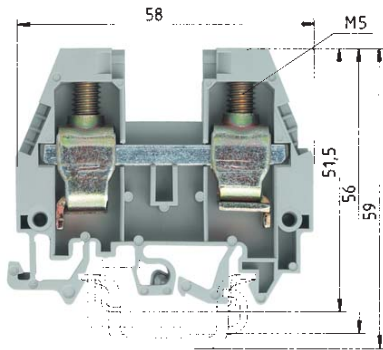

WKI 16/U

fine stranded	stranded	V	A
1-16 mm ²	10-25 mm ²	400 V/6 kV/3	76
No. 12-4 AWG		600 V	65/90
No. 14-4 AWG		600 V	95
12 mm			16 mm



WKI 35/U

fine stranded	stranded	V	A
16-35 mm ²	16-50 mm ²	400 V/6 kV/3	125
No. 10-2 AWG		600 V	95/95
No. 10-2 AWG		600 V	110
16 mm			13 mm



Type	Part no.	Std. pack	Type	Part no.	Std. pack
WKI 16/U	57.516.1155.0	50	WKI 35/U	57.535.1155.0	20
WKI 16/U BLAU	57.516.1155.6	50	WKI 35/U BLAU	57.535.1155.6	20
35 x 27 x 7,5 EN 60715	98.300.0000.0	1	35 x 27 x 7,5 EN 60715	98.300.0000.0	1
35 x 27 x 15 EN 60715	98.360.0000.0	1	35 x 27 x 15 EN 60715	98.360.0000.0	1
9708/2 S 35	Z5.522.8553.0	100	9708/2 S 35	Z5.522.8553.0	100
API 10-16	07.311.9455.0	10	API 35	07.311.8855.0	10
API 10-16 BLAU	07.311.9455.6	10	API 35 BLAU	07.311.8855.6	10
IVB WKI 16-2	Z7.284.9227.0		IVB WKI 35-2	Z7.285.4227.0	5
IVB WKI 16-3	Z7.284.9327.0		IVB WKI 35-3	Z7.285.4327.0	5
IVB WKI 16-4	Z7.284.9427.0		IVB WKI 35-4	Z7.285.4427.0	5
IVB WKI 16-5	Z7.284.9527.0		IVB WKI 35-5	Z7.285.4527.0	5
IVB WKI 16-6	Z7.284.9627.0		IVB WKI 35-6	Z7.285.4627.0	5
TS 16 GELB	07.311.2453.8	10	TS 35 GELB	07.311.8653.8	10
AD VB 16 GELB	04.326.2453.8	10			
ADI 16/1 GELB	04.325.8653.8	10	ADI 35/1 GELB	04.325.8753.8	

Neutral disconnect blocks with screw connection for junction boxes, type **WKI**

selos BIT

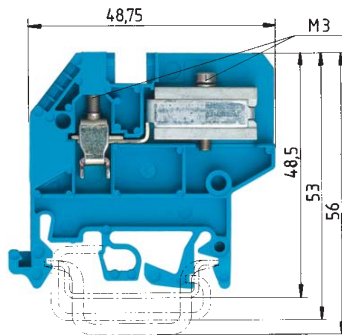

Current carrying capability:
fine stranded: 4 mm² 25 A
solid: 6 mm² 30 A

WKN 4 ETK/U

fine stranded solid V A
0.5 – 4 mm² 0.5 – 6 mm² 400 V/6 kV/3**)

UL pending
No. 20-10 AWG 600 V 25
6 mm 9 mm

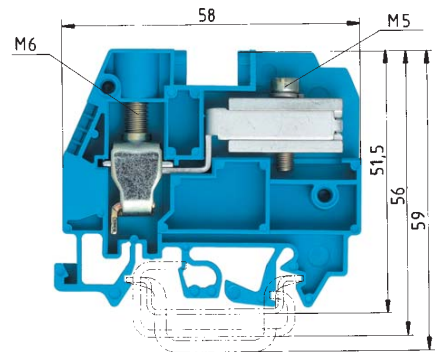

Current carrying capability:
fine stranded: 10 mm² 45 A
stranded: 16 mm² 50 A

WKI 10 ETK/U

fine stranded stranded V A
1 – 10 mm² 10 – 16 mm² 400 V/6 kV/3**)

No. 16-6 AWG 600 V 45
10 mm 13 mm



EN 60 947-7-1/DIN VDE 0611 T1

UL ratings

CSA ratings

Width

Approvals

Wire strip length

	Type	Part no.	Std. pack	Type	Part no.	Std. pack
Neutral-disconnect block Color: blue	WKN 4 ETK/U	57.504.8155.0	100	WKI 10 ETK/U	57.510.8255.0	50
Connector clamp for Cu busbar Color: blue						
Color: unplated						
Accessories						
1. Mounting rail TS 35, DIN rail 7.5 mm high L = 2 m	35 x 27 x 7,5 EN 60715	98.300.0000.0	1	35 x 27 x 7,5 EN 60715	98.300.0000.0	1
Mounting rail TS 35, DIN rail 15 mm high L = 2 m	35 x 27 x 15 EN 60715	98.360.0000.0	1	35 x 27 x 15 EN 60715	98.360.0000.0	1
2. End clamp for TS 35, with screw 8 mm wide	9708/2 S35	Z5.522.8553.0	100	9708/2 S35	Z5.522.8553.0	100
End clamp for TS 35, without screws 8 mm wide	WEF 1/35	Z5.523.9353.0	100	WEF 1/35	Z5.523.9353.0	100
3. End plate 1.5 mm thick Color: gray						
1.5 mm thick Color: blue	APN 4 ETK	07.311.1155.0	10	API 10-16 ETK/1	07.312.1955.0	10
1.5 mm thick Color: green						
End plate 2 mm thick Color: gray						
2 mm thick Color: blue						
2 mm thick Color: green						
4. Partition plate Color: gray						
Color: blue						
5. Cross connector with screws (jumper bar) 2pole						
insulated 3pole						
4pole						
5pole						
6pole						
6. Partition plate with marking facility Color: yellow						
7. Cover with marking facility Color: yellow						
8. Cover with warning symbol over 4 blocks Color: yellow						
Cover with warning symbol for 1 block Color: yellow						
9. Busbar						
E-Cu 10 x 3 mm, tin-plated, I _N = 140 A L = 1 m	9813 M	98.290.0000.0	1	9813 M	98.290.0000.0	1
E-Cu 10 x 3 mm, unplated, I _N = 140 A L = 1 m	9813 M SN	98.290.1000.0	1	9813 M SN	98.290.1000.0	1
10. Connector clamp for busbar						
16 mm ² 8.5 mm wide	WAK 16/2 BLAU	30.494.3021.0		WAK 16/2 BLAU	30.494.3021.0	
35 mm ² 17 mm wide	WAK 35/2	30.494.4121.0	50	WAK 35/2	30.494.4121.0	50
11. Busbar support 4 mm wide	WKI SH/U	01.108.3255.0	10	WKI SH/U	01.108.3255.0	10
Busbar support 8 mm wide	WKIF SH/E/35	Z1.108.8453.0	10	WKIF SH/E/35	Z1.108.8453.0	10
Marking accessories see page 48/49 and page 90/91						

Connector clamp for Cu busbar (10 x 3 mm), type WAK

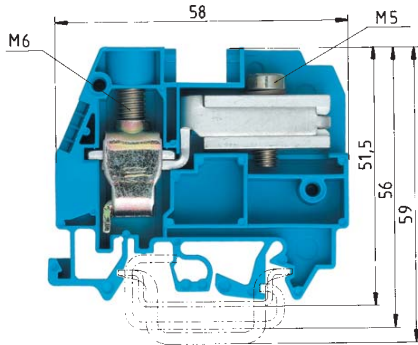

Current carrying capability:
 fine stranded: 16 mm² 62 A
 stranded: 25 mm² 67 A

EN 60 998-2-1 CCA/CH

EN 60 998-2-1 CCA/CH

WKI 16 ETK/U

fine stranded stranded V A
 1 – 16 mm² 10 – 25 mm² 400 V/6 kV/3***)

No. 14-4 AWG 600 V 65
 12 mm 15 mm



WAK 16/2

fine stranded stranded V A
 1.5 – 16 mm² 10 – 16 mm² 76

8.4 mm 16 mm



WAK 35/2

fine stranded stranded V A
 16 – 35 mm² 16 – 35 mm² 125

17 mm 14 mm



Type	Part no.	Std. pack	Type	Part no.	Std. pack	Type	Part no.	Std. pack
WKI 16 ETK/U	57.516.8255.0	50	WAK 16/2 BLAU	30.494.3021.6	100	WAK 35/2 BLAU	30.494.4121.6	
						WAK 35/2	30.494.4121.0	50
35 x 27 x 7,5 EN 60715	98.300.0000.0	1						
35 x 27 x 15 EN 60715	98.360.0000.0	1						
9708/2 S35	Z5.522.8553.0	100						
API 10-16 ETK/1	07.312.1955.0	10						
9813 M	98.290.0000.0	1	9813 M	98.290.0000.0	1	9813 M	98.290.0000.0	1
9813 M SN	98.290.1000.0	1	9813 M SN	98.290.1000.0	1	9813 M SN	98.290.1000.0	1
WAK 16/2 BLAU	30.494.3021.0							
WAK 35/2	30.494.4121.0	50						
WKI SH/U	01.108.3255.0	10	WKI SH/U	01.108.3255.0	10	WKI SH/U	01.108.3255.0	10
WKIF SH/E/35	Z1.108.8453.0	10	WKIF SH/E/35	Z1.108.8453.0	10	WKIF SH/E/35	Z1.108.8453.0	10

Ground blocks with screw connection for junction boxes, type **WKI SL**

selos BIT

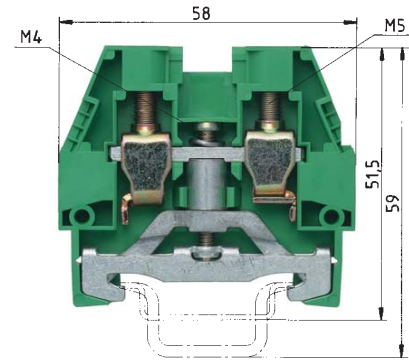
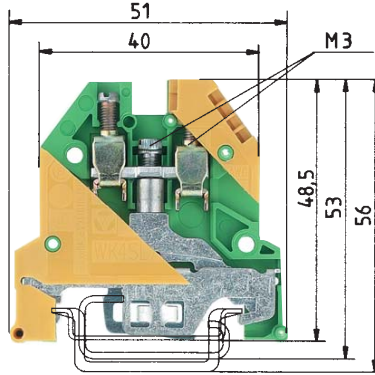

*1 Ratings of adjacent feed-through block same series and size

EN 60 947-7-2/DIN VDE 0611 T3
UL ratings
CSA ratings
Width
Approvals

Wire strip length

enclosed design

WKI 4 SL/U

fine stranded solid V A
0.5 – 4 mm² 0.5 – 6 mm² 800 V/8 kV/3*)
No. 22-10 AWG 600 V
No. 22-10 AWG
6 mm 9 mm
EPM SEV-EEX S3 N W P WEF EEP S LR UL CE
BKI-EEEx

WKI 10/35

fine stranded solid/stranded V A
1 – 10 mm² 1.5 – 16 mm² 800 V/8 kV/3*)
No. 16-6 AWG 600 V
No. 16-6 AWG
10 mm 18 mm
UL CE

Ground block	Color: green/yellow	Type	Part no.	Std. pack	Type	Part no.	Std. pack
		WKI 4 SL/U	57.504.9055.0	100	WKI 10 SL/35	56.510.9255.0	50
Accessories							
1. Mounting rail TS 35, DIN rail 7.5 mm high	L = 2 m	35 x 27 x 7,5 EN 60715	98.300.0000.0	1	35 x 27 x 7,5 EN 60715	98.300.0000.0	1
Mounting rail TS 35, DIN rail 15 mm high	L = 2 m	35 x 27 x 15 EN 60715	98.360.0000.0	1	35 x 27 x 15 EN 60715	98.360.0000.0	1
2. End clamp for TS 35, with screw	8 mm wide	9708/2 S35	Z5.522.8553.0	100	9708/2 S35	Z5.522.8553.0	100
End clamp for TS 35, without screws	8 mm wide	WEF 1/35	Z5.523.9353.0	100	WEF 1/35	Z5.523.9353.0	100
3. End plate	1.5 mm thick						
	1.5 mm thick						
	1.5 mm thick				API 10-16 SL	07.311.9555.0	10
End plate	2 mm thick						
	2 mm thick						
	2 mm thick						
4. Partition plate							
5. Cross connector with screws (jumper bar)	2pole						
insulated	3pole						
	4pole						
	5pole						
	6pole						
6. Partition plate with marking facility	Color: yellow						
7. Cover with marking facility	Color: yellow	AD VB4 GELB	04.326.2153.8	10	AD VB 10 GELB	04.326.2353.8	10
8. Cover with warning symbol over 4 blocks	Color: yellow	AD 4/4 GELB	04.343.5856.8				
Cover with warning symbol for 1 block	Color: yellow				AD 10/1 GELB	04.325.8553.8	10
9. Busbar							
E-Cu 10 x 3 mm, tin-plated, I _N = 140 A	L = 1 m						
E-Cu 10 x 3 mm, unplated, I _N = 140 A	L = 1 m						
10. Connector clamp for busbar							
	16 mm ²	8.5 mm wide					
	35 mm ²	17 mm wide					
11. Busbar support	4 mm wide						
Busbar support	8 mm wide						
Marking accessories see page 48/49 and page 90/91							

selos

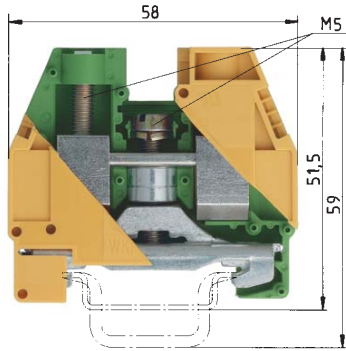
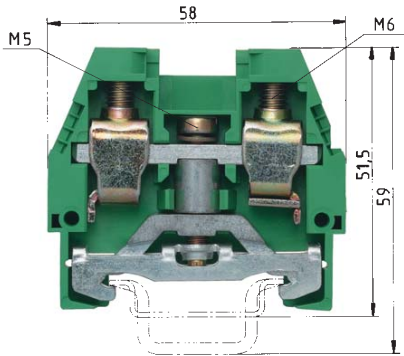

enclosed design

WKI 16 SL/35

fine stranded solid/stranded V A
 1 – 16 mm² 1.5 – 25 mm² 400 V/6 kV/3*)
 No. 12-4 AWG 600 V
 No. 14-4 AWG
 12 mm 16 mm

WKI 35 SL/35

fine stranded stranded V A
 16 – 35 mm² 16 – 50 mm² 400 V/6 kV/3*)
 UL pending
 No. 10-2 AWG
 16 mm 13 mm

Type	Part no.	Std. pack	Type	Part no.	Std. pack
WKI 16 SL/35	56.516.9255.0	50	WKI 35 SL/35	56.535.9255.0	20
35 x 27 x 7,5 EN 60715	98.300.0000.0	1	35 x 27 x 7,5 EN 60715	98.300.0000.0	1
35 x 27 x 15 EN 60715	98.360.0000.0	1	35 x 27 x 15 EN 60715	98.360.0000.0	1
9708/2 S35	Z5.522.8553.0	100	9708/2 S35	Z5.522.8553.0	100
API 10-16 SL	07.311.9555.0	10			
AD VB 16 GELB	04.326.2453.8	10	AD VB 10 GELB	04.326.2353.8	10
AD 16/1 GELB	04.325.8653.8	10	AD 35/1 GELB	04.325.8753.8	

PEN assembly block with screw connection for junction boxes, type WKI...

selos BIT

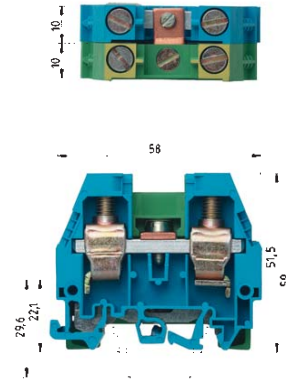
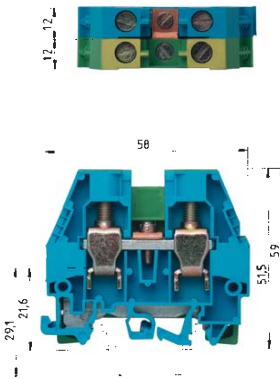

WKI 10 PEN/35

	fine stranded	solid/stranded	V	A
	1 – 10 mm ²	1.5 – 16 mm ²	400 V/6 kV/3	57
	No. 16-6 AWG		600 V	65/65
	No. 16-6 AWG		600 V	70
Wire strip length	20 mm			18 mm

WKI 16 PEN/35

	fine stranded	solid/stranded	V	A
	1 – 16 mm ²	1.5 – 25 mm ²	400 V/6 kV/3	76
	No. 12-4 AWG		600 V	65/65
	No. 14-4 AWG		600 V	95
Wire strip length	24 mm			16 mm

EN 60 947-7-1, EN 60 947-7-2

UL ratings

CSA ratings

Width

Approvals

Wire strip length

PEN assembly block		Color: green/yellow – blue	Type	Part no.	Std. pack	Type	Part no.	Std. pack
			WKI 10 PEN/35	56.510.9455.0	20	WKI 16 PEN/35	56.516.9455.0	20
Accessories								
1.	Mounting rail TS 35, DIN rail 7.5mm high	L = 2 m	35 x 27 x 7,5 EN 60715	98.300.0000.0	1	35 x 27 x 7,5 EN 60715	98.300.0000.0	1
	Mounting rail TS 35, DIN rail 15mm high	L = 2 m	35 x 27 x 15 EN 60715	98.360.0000.0	1	35 x 27 x 15 EN 60715	98.360.0000.0	1
2.	End clamp for TS 35, with screw	8 mm wide	9708/2 S35	Z5.522.8553.0	100	9708/2 S35	Z5.522.8553.0	100
	End clamp for TS 35, without screws	8 mm wide	WEF 1/35	Z5.523.9353.0	100			
3.	End plate	1.5 mm thick						
		1.5 mm thick	API 10-16 BLAU	07.311.9455.6	10	API 10-16 BLAU	07.311.9455.6	10
		1.5 mm thick						
	End plate	2 mm thick						
		2 mm thick						
		2 mm thick						
		2 mm thick						
4.	Partition plate							
		Color: gray						
		Color: blue						
5.	Cross connector with screws (jumper bar)	2pole						
		insulated						
		3pole						
		4pole						
		5pole						
		6pole						
6.	Partition plate with marking facility	Color: yellow	TS 10 GELB	07.311.2353.8	10	TS 16 GELB	07.311.2453.8	10
7.	Cover with marking facility	Color: yellow	AD VB 10 GELB	04.326.2353.8	10	AD VB 16 GELB	04.326.2453.8	10
8.	Cover with warning symbol over 4 blocks	Color: yellow						
	Cover with warning symbol for 1 block	Color: yellow	ADI 10/1 GELB	04.325.8553.8	10	AD 16/1 GELB	04.325.8653.8	10
9.	Busbar							
	E-Cu 10 x 3 mm, tin-plated, I _N = 140 A	L = 1 m						
	E-Cu 10 x 3 mm, unplated, I _N = 140 A	L = 1 m						
10.	Connector clamp for busbar							
		16 mm ²						
		8.5 mm wide						
		35 mm ²						
		17 mm wide						
11.	Busbar support	4 mm wide						
	Busbar support	8 mm wide						
Marking accessories see page 48/49 and page 90/91								

selos

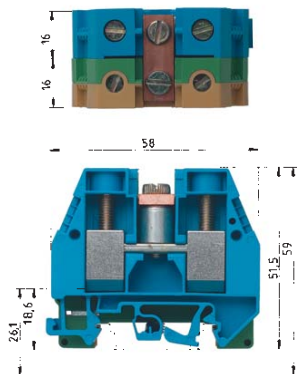

WKI 35 PEN/35

fine stranded	stranded	V	A
16 – 35 mm ²	16 – 50 mm ²	400 V/6 kV/3	125
No. 10-2 AWG		600 V	95/95
No. 10-2 AWG		600 V	110
32 mm			13 mm

Type	Part no.	Std. pack
WKI 35 PEN/35	56.535.9455.0	10
35 x 27 x 7,5 EN 60715	98.300.0000.0	1
35 x 27 x 15 EN 60715	98.360.0000.0	1
9708/2 S35	Z5.522.8553.0	100
API 35 BLAU	07.311.8855.6	10
TS 35 GELB	07.311.8653.8	10
AD 35/1 GELB	04.325.8753.8	

PEN assembly block for junction box IEC 947-7-2 EN 60947-7-2

Electrical power is often supplied to the plant in a 4 conductor three phase system (L1, L2, L3, and Ground). However, the electrical equipment in the plant may require a 5 conductor three phase system (L1, L2, L3, N, and Ground). Therefore, it is important to have a connection system to accommodate both possibilities.

The Wieland WKI ... PEN/35 system accomplishes this task. The PEN assembly terminal block consists of a ground terminal which is grounded to the DIN rail and a neutral terminal (color coded blue) which is electrically isolated from the DIN rail. The two terminals are commoned via a cross connector (jumper bar) thereby, tying the neutral terminal to ground.

When using the PEN assembly terminal block system, the DIN mounting rail only acts as a grounding bus. Therefore, copper mounting rail is not required and standard zinc plated steel DIN can be used for grounding purposes.

These assemblies have the same symmetry as the corresponding feed through terminals of the WKI series and fit the height required for junction boxes per DIN 43871 when using DIN rail size 35 x 27 x 7.5.

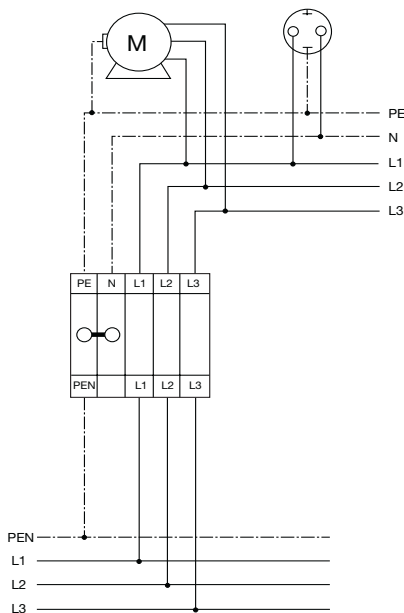

Accessories for DIN rail Terminal blocks with screw connection for junction boxes

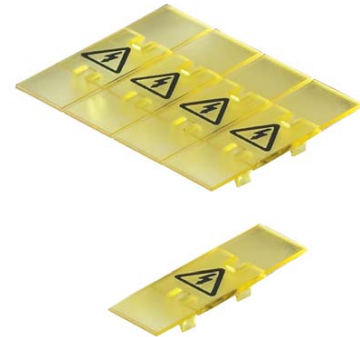
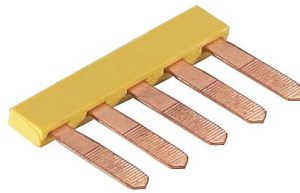
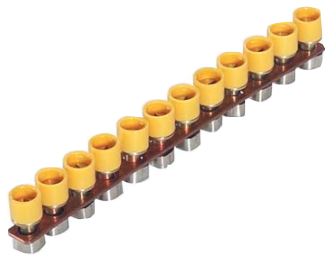

Cross connectors (jumper bars) for installation blocks

Insulated jumper combs for installation blocks

Cover with warning symbol

Type	Part no.	Std. pack	Type	Part no.	Std. pack	Type	Part no.	Std. pack
for terminal blocks type			for terminal blocks type			for terminal blocks type		
WKI 4 D-D			WKI 4 D-D			Cover with warning symbol over 4 blocks		
WKI 4 DU			WKI 4 DU					
WKI 4 N-D-SL			WKI 4 N-D-SL			WK 4		
WKI 4 NT-D-SL... (and variants)			WKI 4 NT-D-SL... (and variants)			AD 4/4 GELB	04.343.5856.6	10
WKI 4 NTN-D-SL			WKI 4 NTN-D-SL					
WKI 4 TKG-D-SL			WKI 4 TKG-D-SL					
WKI 4 D-D-SL			WKI 4 D-D-SL			Cover with warning symbol for 1 block		
			0.5 mm thick, 6 mm spacing Color: yellow			WKI 10		
Cross connectors, uninsulated (jumper bars)			2pole IVB 0,5 WK 4..-2	Z7.255.0227.0	10	AD 10/1 GELB	04.325.8553.8	10
2pole 9703/6-2	Z7.211.0227.0	50	3pole IVB 0,5 WK 4..-3	Z7.255.0327.0	10			
3pole 9703/6-3	Z7.211.0327.0	50	4pole IVB 0,5 WK 4..-4	Z7.255.0427.0	10			
4pole 9703/6-4	Z7.211.0427.0	50	5pole IVB 0,5 WK 4..-5	Z7.255.0527.0	10			
5pole 9703/6-5	Z7.211.0527.0	50	6pole IVB 0,5 WK 4..-6	Z7.255.0627.0	10	WKI 16		
6pole 9703/6-6	Z7.211.0627.0	50	7pole IVB 0,5 WK 4..-7	Z7.255.0727.0	10	AD 16/1 GELB	04.325.8653.8	10
70pole 9703/6 M-70	Z7.211.0027.0	10	8pole IVB 0,5 WK 4..-8	Z7.255.0827.0	10			
			9pole IVB 0,5 WK 4..-9	Z7.255.0927.0	10			
Cross connectors, insulated (jumper bars)			10pole IVB 0,5 WK 4..-10	Z7.255.1027.0	10	WKI 35		
12pole IVB WKI 4-12	Z7.271.5227.0	10	11pole IVB 0,5 WK 4..-11	Z7.255.1127.0	10	AD 35/1 GELB	04.325.8753.0	10
			12pole IVB 0,5 WK 4..-12	Z7.255.1227.0	10			
			1 mm thick, 6 mm spacing Color: yellow					
			2pole IVB 1 WK 4..-2	Z7.255.4227.0	10			
			3pole IVB 1 WK 4..-3	Z7.255.4327.0	10			
			4pole IVB 1 WK 4..-4	Z7.255.4427.0	10			
			5pole IVB 1 WK 4..-5	Z7.255.4527.0	10			
			6pole IVB 1 WK 4..-6	Z7.255.4627.0	10			
			7pole IVB 1 WK 4..-7	Z7.255.4727.0	10			
			8pole IVB 1 WK 4..-8	Z7.255.4827.0	10			
			9pole IVB 1 WK 4..-9	Z7.255.4927.0	10			
			10pole IVB 1 WK 4..-10	Z7.255.5027.0	10			
			11pole IVB 1 WK 4..-11	Z7.255.5127.0	10			
			12pole IVB 1 WK 4..-12	Z7.255.5227.0	10			



Uninsulated cross connectors (jumper bars) for feed-through blocks

**Partition plates with marking facility
Cover with marking facility**

Insulated cross connectors (jumper bars) for feed-through blocks

Type	Part no.	Std. pack	Type	Part no.	Std. pack	Type	Part no.	Std. pack
for terminal blocks type			Partition plate with marking facility			for terminal blocks type		
			Color: yellow			WK 4/U		
WK 4/U			for terminal blocks type			2pole IVB WK 4-2 Z7.281.1227.0 10		
2pole VB WK 4-2	Z7.281.0227.0	10	WK 4/U			3pole IVB WK 4-3 Z7.281.1327.0 10		
3pole VB WK 4-3	Z7.281.0327.0	10	TS 4 YELLOW			4pole IVB WK 4-4 Z7.281.1427.0 10		
4pole VB WK 4-4	Z7.281.0427.0	10	WKI 10			5pole IVB WK 4-5 Z7.281.1527.0 10		
5pole VB WK 4-5	Z7.281.0527.0	10	TS 10 YELLOW			6pole IVB WK 4-6 Z7.281.1627.0 10		
6pole VB WK 4-6	Z7.281.0627.0	10	WKI 16			7pole IVB WK 4-7 Z7.281.1727.0 10		
70pole VB WK 4 M-70	Z7.281.0027.0	10	TS 16 YELLOW			8pole IVB WK 4-8 Z7.281.1827.0 10		
WKI 10/U			WKI 35			9pole IVB WK 4-9 Z7.281.1927.0 10		
2pole VB WKI 10-2	Z7.288.0227.0	10	TS 35 YELLOW			10pole IVB WK 4-10 Z7.281.2027.0 10		
3pole VB WKI 10-3	Z7.288.0327.0	10	Cover with marking facility			11pole IVB WK 4-11 Z7.281.2127.0 10		
4pole VB WKI 10-4	Z7.288.0427.0	10	for cross connector Color: yellow			12pole IVB WK 4-12 Z7.281.2227.0 10		
5pole VB WKI 10-5	Z7.288.0527.0	10	for terminal blocks type			WKI 10/U		
6pole VB WKI 10-6	Z7.288.0627.0	10	WK 4			2pole IVB WKN 10-2 Z7.283.2227.0 10		
40pole VB WKI 10 M-40	Z7.288.0027.0	10	AD VB 4 YELLOW			3pole IVB WKN 10-3 Z7.283.2327.0 10		
WKI 16/U			WKI 10			4pole IVB WKN 10-4 Z7.283.2427.0 10		
2pole VB WKI 16-2	Z7.289.0227.0	10	AD VB 10 YELLOW			5pole IVB WKN 10-5 Z7.283.2527.0 10		
3pole VB WKI 16-3	Z7.289.0327.0	10	WKI 16			6pole IVB WKN 10-6 Z7.283.2627.0 10		
4pole VB WKI 16-4	Z7.289.0427.0	10	AD VB 16 YELLOW			WKI 16/U		
5pole VB WKI 16-5	Z7.289.0527.0	10				2pole IVB WKI 16-2 Z7.284.9227.0 10		
6pole VB WKI 16-6	Z7.289.0627.0	10				3pole IVB WKI 16-3 Z7.284.9327.0 10		
20pole VB WKI 16 M-20	Z7.289.0027.0	10				4pole IVB WKI 16-4 Z7.284.9427.0 10		
						5pole IVB WKI 16-5 Z7.284.9527.0 10		
						6pole IVB WKI 16-6 Z7.284.9627.0 10		
						WKI 35/U		
						2pole IVB WKI 35-2 Z7.285.4227.0 5		
						3pole IVB WKI 35-3 Z7.285.4327.0 5		
						4pole IVB WKI 35-4 Z7.285.4427.0 5		
						5pole IVB WKI 35-5 Z7.285.4527.0 5		
						6pole IVB WKI 35-6 Z7.285.4627.0 5		

Accessories for DIN rail terminal blocks for junction boxes

fasis BIT
selos BIT

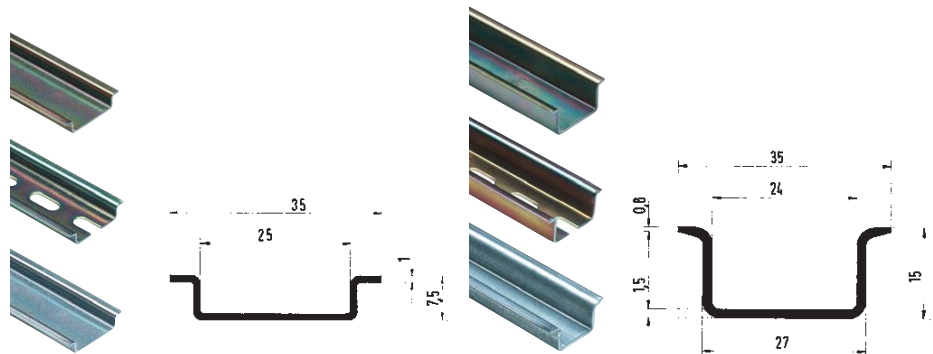

Mounting rail 35 x 7.5
accord. to DIN EN 60715

Mounting rail 35 x 15
accord. to DIN EN 60715

Mounting rail	Type	Part no.	Std. pack	Type	Part no.	Std. pack
1. Steel, galv. zinc-plated and dichromated, unslotted L = 2 m	35 x 27 x 7.5 EN 60715	98.300.0000.0	1	35 x 27 x 15 EN 60715	98.370.0000.0	1
Steel, galv. zinc-plated and dichromated, slotted L = 2 m	35 x 27 x 7.5 EN 60715 slotted	98.300.1000.0	1	35 x 27 x 15 EN 60715	98.370.1000.0	1
2. Steel, unplated unslotted L = 2 m	35 x 27 x 7.5 EN 60715 unplated	98.300.0010.0	1			
Steel, unplated slotted L = 2 m						
3. Steel, hot-galvanized unslotted L = 2 m						
Steel, hot-galvanized slotted L = 2 m						
4. E copper unslotted L = 2 m						
E copper slotted L = 2 m						
5. Aluminium unslotted L = 2 m		98.750.0000.0	1 *			
slotted L = 1 m		98.800.1000.0	1 *			
6. Stainless steel unslotted L = 2 m		98.330.0000.0	1 *			
	*available in North America only					
End clamp						
5. End clamp for TS 35, with screw 8 mm wide						
6. End clamp for TS 35, with screw with marking facility for block assemblies 8/17.5 mm wide						
7. End clamp for TS 35, screwless 8 mm wide						
8. End clamp for TS 35, screwless with marking facility for block assemblies 8/17.5 mm wide						
9. Marking card in perforated sheets (1 sheet = 100 single tags)						

fasis

selos BIT

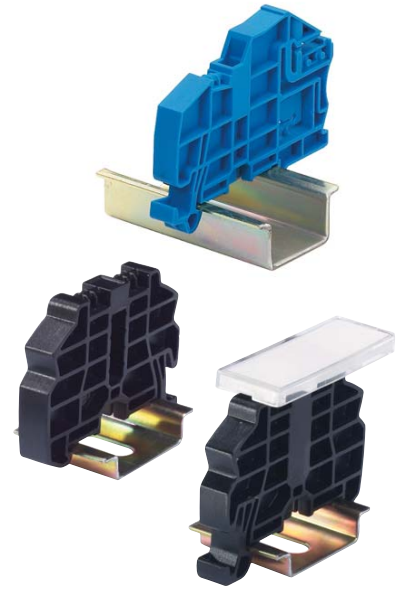
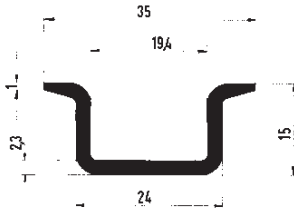
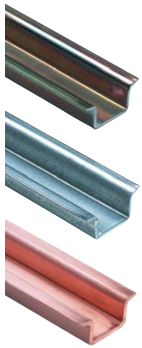

Mounting rail 35 x 15 accord. to DIN EN 60715

End clamp for TS 35 fixed with screw

End clamp for TS 35 fixed without screw

Type	Part no.	Std. pack	Type	Part no.	Std. pack	Type	Part no.	Std. pack
35 x 27 x 15 EN 60715	98.360.0000.0	1						
35 x 27 x 15 EN 60715 ZN	98.360.0004.0	1						
35 x 27 x 15 EN 60715 CU	98.380.0000.0	10						
			9708/2 S 35	Z5.522.8553.0	100			
			9708/2 BS/35	69.920.0553.0	100			
						WEF 1/35	Z5.523.9353.0	100
						WEF 1 BS/35	69.920.1053.0	100
						WKIF SH/E/35	Z1.108.8453.0	10
						BS/R	Z4.243.8453.0	
				04.019.0289.0	10			
							04.019.0289.0	10

Marking accessories for DIN rail terminal blocks for junction boxes

fasis BIT

selos BIT

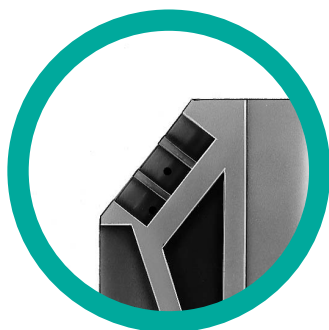

Material:
Polyamide 66/6
Color: black figures on white background

DIN rail terminal blocks, type WKF, can take in marking tags on both sides on top of the block in a 3-chamber slot. It can be either 3 single number tags from the tear-off marking strip, or single tags, or marking strips.

1. **Marking strips** marked and unmarked, made from Polyamide 66/6, suitable for 10 blocks in a row.

Marking 1-10, 11-20 etc. up to 991-999.

Type 9705 A/5/10 (5 mm spacing)

for terminal blocks type WKIF 2.5...

Type 9705 A/6/10 (6 mm spacing)

for terminal blocks type WK/WKF 4...

Type 9705 A/5/10/5 B (10 mm spacing)

for terminal blocks type WKI/WKF 10...

Type 9705 A/6/10/5 B (12 mm spacing)

for terminal blocks type WKI/WKIF 16...

Type 9705 A/8/10/5 B (16 mm spacing)

for terminal blocks type WKI 35...

2. **Tear-off marking strip** with 10 marking tags, made from Polyamide 66/6, white, marked and unmarked.

This marking system considerably reduces the time required for marking terminal block rows. For numerical marking of terminal block rows only 11 stock positions are required. As the time used for picking and attaching the tags is reduced, and as stockkeeping is low and the prices extremely favorable, enormous cost savings are the result from using these tear-off marking strips.

Type 9704 A...
(see page 180)

3. **Single marking tag** made from white Polyamide 66/6, marked and unmarked.
Type 9705 A...

Marking computer in system kit

Type	Part no.	Std. pack	Type	Part no.	Std. pack
Marking computer for markingcards			Single marking tag, unmarked		
			9705 A	04.242.0850.0	500
			Single marking tag, marked		
marcom 2	95.502.0000.0	1	9705 AB*	04.842.0850.0	500
Description					
<p>wieland marcom 2 is a freely programmable marking computer for marking tags of DIN rail terminal blocks, pluggable connectors, cables and switching devices. The program technology with flexible menu control produces excellent results requiring only few input. Entry of a sequence of figures is automatically limited by the parameters of the selected marking tags, making wrong print-out impossible. Repeated operations can be saved as so-called JOBS and are therefore immediately available for print-out without further entries. The computer disposes of a large number of fonts, with numerical, alphanumeric (small/capital letters) and symbolic characters.</p> <p>marcom 2 is powered by an attached power supply. For a mains-independent operation, the marcom 2 Power Pack is available.</p>			<p>Single marking tag, unmarked with enlarged marking area</p> <p>9705 AL 04.242.1553.0 500</p> <p>Single marking tag, marked for enlarged marking area</p> <p>9705 ALB 04.842.1553.0 500</p>		
Marking tag plates for marcom 2					
9705 A/5/10/11 marcom	Z4.242.5053.0	10			
9705 AL/5/10/6 marcom	Z4.242.5153.0	10			
9705 A/6/10/11 marcom	Z4.242.6053.0	10			
9705 AL/6/10/6 marcom	Z4.242.6353.0	10			
9705 A/8/10/7 marcom	Z4.242.8053.0	10			
*Custom marking upon request					



2,5 mm²/5 mm Width



4 mm²/6 mm Width



10 mm²/10 mm Width

16 mm²/12 mm Width

35 mm²/16 mm Width

Type	Part no.	Std. pack	Type	Part no.	Std. pack	Type	Part no.	Std. pack
Marking strips, unmarked			Marking strips, unmarked			10 mm²/10 mm Width		
9705 A/5/10	04.242.5053.0	25	9705 A/6/10	04.242.6053.0	25	marked for 5 blocks (every 2nd tag) *		
Marking strips, marked			Marking strips, marked			9705 A/5/10/5 B 04.842.5553.0 25		
9705 A/5/9 B 1 - 9	04.842.4953.0	25	9705 A/6/9 B 1 - 9	04.842.5953.0	25	16 mm²/12 mm Width		
9705 A/5/10 B*	04.842.5053.0	25	9705 A/6/10 B*	04.842.6053.0	25	marked for 5 blocks (every 2nd tag) *		
9705 A/5/10 B 1 - 10	04.845.0153.0	25	9705 A/6/10 B 1 - 10	04.846.0153.0	25	9705 A/6/10/5 B 04.842.6553.0 25		
11 - 20	04.845.0253.0	25	11 - 20	04.846.0253.0	25	35 mm²/16 mm Width		
21 - 30	04.845.0353.0	25	21 - 30	04.846.0353.0	25	marked for 5 blocks (every 2nd tag) *		
31 - 40	04.845.0453.0	25	31 - 40	04.846.0453.0	25	9705 A/8/10/5 B 04.842.8553.0 25		
41 - 50	04.845.0553.0	25	41 - 50	04.846.0553.0	25			
51 - 60	04.845.0653.0	25	51 - 60	04.846.0653.0	25			
61 - 70	04.845.0753.0	25	61 - 70	04.846.0753.0	25			
71 - 80	04.845.0853.0	25	71 - 80	04.846.0853.0	25			
81 - 90	04.845.0953.0	25	81 - 90	04.846.0953.0	25			
91 - 100	04.845.1053.0	25	91 - 100	04.846.1053.0	25			
⊕ (10 x) 04.855.0053.0 25			⊕ (10 x) 04.856.0053.0 25					
± (10 x) 04.855.0153.0 25			± (10 x) 04.856.0153.0 25					
+ (10 x) 04.855.0253.0 25			+ (10 x) 04.856.0253.0 25					
- (10 x) 04.855.0353.0 25			- (10 x) 04.856.0353.0 25					
L1 (10 x) 04.855.0453.0 25			L1 (10 x) 04.856.0453.0 25					
L2 (10 x) 04.855.0553.0 25			L2 (10 x) 04.856.0553.0 25					
L3 (10 x) 04.855.0653.0 25			L3 (10 x) 04.856.0653.0 25					
PE (10 x) 04.855.0753.0 25			PE (10 x) 04.856.0753.0 25					
SL (10 x) 04.855.3153.0 25			SL (10 x) 04.856.3153.0 25					
N (10 x) 04.855.3253.0 25			N (10 x) 04.856.3253.0 25					
F1 (10 x) 04.855.0953.0 25			F1 (10 x) 04.856.0953.0 25					
F2 (10 x) 04.855.1053.0 25			F2 (10 x) 04.856.1053.0 25					
L1, L2, L3, N, PE (2 x) 04.855.0853.0 25			L1, L2, L3, N, PE (2 x) 04.856.0853.0 25					
with enlarged marking area			with enlarged marking area					
9705 AL/5/10	04.242.5153.0	25	9705 AL/6/10	04.242.6353.0	25			
*Custom marking upon request			*Custom marking upon request			* indicate required marking with part no.		

DIN rail terminal blocks with screw connection, type WKN

selos

Rising cage clamp connection up to 150 mm²

Standard DIN rail terminal blocks

Fuse blocks

Disconnect blocks

Duo feed through blocks /
multi-tier blocks

Initiator /
actuator blocks

Micro modular feed through blocks for TS 35

selos accord. to US standard UL 94 V-0

- Elastic clamping body
- Rated cross section: 2.5 to 150 mm²
- Connection range: 0.5 to 185 mm²
- Universal foot

All Wieland Components which require **CE** general certification are **CE** certified, and identified with the **CE** logo.

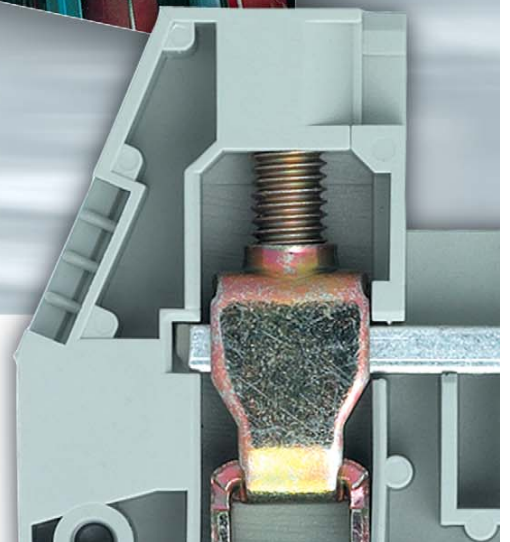

DIN Rail Terminal Blocks

Screw Connection, Type *WKN*

DIN rail terminal blocks with screw connection, type WKN

selos

	2.5 mm ² (12 AWG)	4 mm ² (10 AWG)	6 mm ² (8 AWG)	10 mm ² (6 AWG)	16 mm ² (4 AWG)
Feed-through blocks 2,5-150mm ² 12 AWG – 350 MCM					
2,5-150mm ² 12 AWG – 350 MCM					
Neutral disconnect blocks					
Ground blocks					

Standard DIN rail terminal blocks with rising

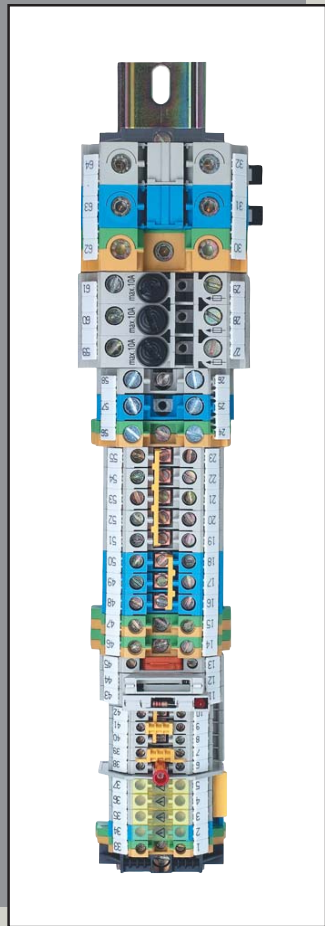

Disconnect lever fuse block		Disconnect block with diode plug	
Fuseblock		Disconnect-block with fuse holder	
with indicator		Knife edge disconnect block	
Feed-through block		Invertible plug disconnect block	
		Feed-through block	
Fuse blocks		Disconnect blocks	

35 mm ² (2 AWG)	70 mm ² (2/0 AWG)	150 mm ² (350 MCM)

cage clamp

4 mm ² (10 AWG)		4 mm ² (10 AWG)	
D1/2			
D2/2		E	
D/E		E/V B	
D2/2SL		E/SL	

Duo feed-through blocks **Multi-tier blocks**

Connector clamps for busbars

	2.5 mm ² (12 AWG)	4 mm ² (10 AWG)
Feed-through block with solder connection		
Feed-through block		
Groundblock		

Micro modular feed through blocks TS15

Three-tier feed-through block

Four-tier feed-through blocks

Initiator and actuator blocks

DIN rail terminal blocks with screw connection, type *WKN*

selos

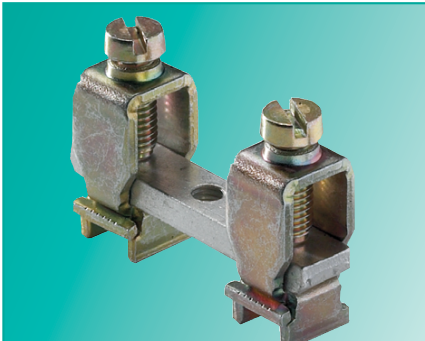

WKN provides ...

- Rising cage clamp technology
- Elastic clamping body
- One piece threaded collar

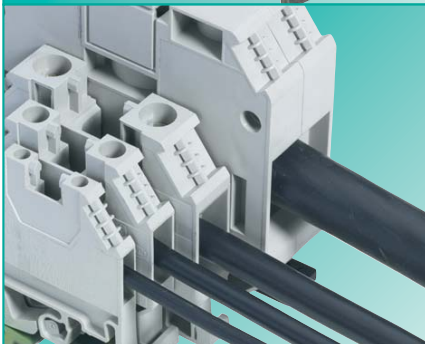

- Rated cross section**
2.5 – 150 mm²
12 AWG – 350 MCM
- Connection range**
0.5 – 185 mm²
24 AWG – 350 MCM

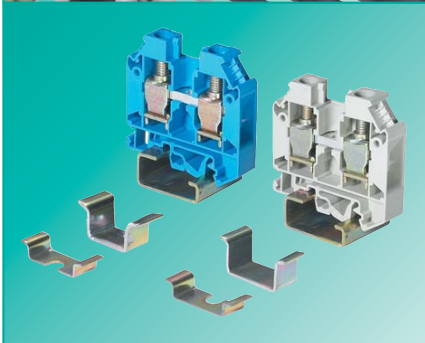

- Universal foot** for
 - TS35 accord. to DIN 60715
 - TS32 accord. to DIN 60715
- Terminal is centered on the rail.

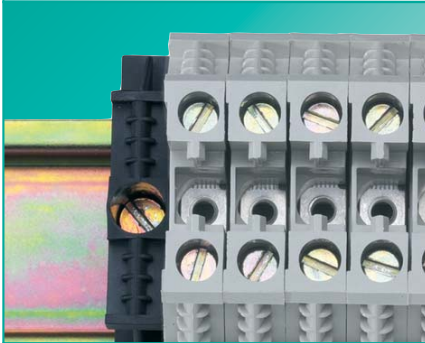

- Guided screwdriver access

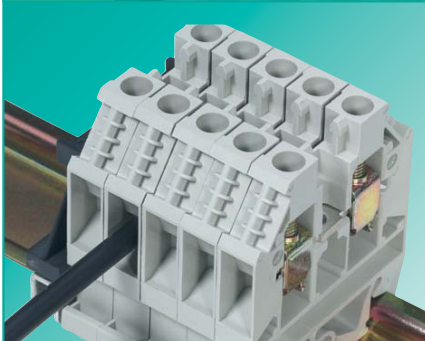

- 4-sided **Funneled wire entry**
- The terminal blocks are delivered the **clamping body** in the open position

Application advantages

- Low contact resistance due to large surface area
- High and stable contact force
- **Vibration proof contact** – low maintenance
- **Guaranteed functionality**, even after repeated tightening and loosening of the screws
- Solid, fine stranded and stranded wires can be connected to the WKN terminal blocks **without the use of ferrules**
- If ferrules are used, the rated cross section does not have to be reduced
- One terminal for all common mounting rails
- Error free mounting foot provides clear identification of terminals mounted incorrectly
- **Mounting safety**
- When pneumatic or electric screwdrivers are used, the screwdriver guide prevents the blade from slipping of the screw head.

- **Safe and rapid installation of the wire**
- Stranded and fine stranded wires can easily be inserted in the terminal block even without ferrules
- Reduces installation time

selos



❑ Captive hardware

- The clamping screws are securely **held** within the insulating housing.
- Tapered plastic fins in the screw turret grip the screw head to ensure a secure connection
- The screw design prevents the screw from coming out of the clamping body. Turning the screwdriver counter clockwise will cause the screw to spin in the idle position. This guarantees safe installation when using pneumatic or electric screwdrivers.

Material

- ❑ Special alloys and surface treatment
- ❑ Low contact resistance
- ❑ High resistance to corrosion

Metal parts:

- ❑ Current carrying bar: tin plated; brass or copper
- ❑ Clamping body and clamping screws: steel, zinc-plated and dichromated

Insulating housing:

- ❑ Use of Polyamide 66/6 for its excellent chemical and mechanical properties (for more information see section **facts & DATA**)
- ❑ Material accord. to US standard UL 94-V0

Accessories:

- ❑ Stamped components: bright copper
- ❑ Test bolts and switchable connecting links: galvanized copper alloy

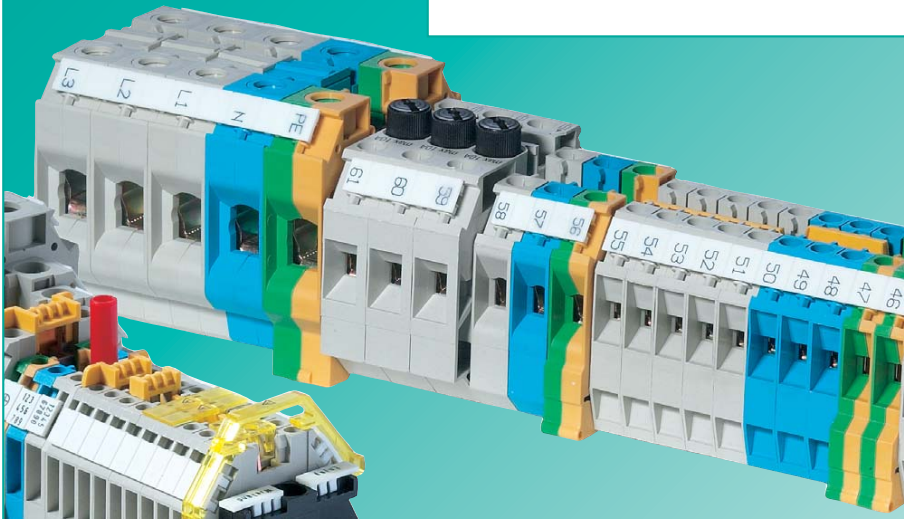

DQS certificates for all product families

- ❑ Quality standard as per DIN ISO 9001 in Development, Production, Assembly
- ❑ Continued control of the quality standard by means of regular internal and external quality audits
- ❑ Compatible with certificates of other countries:
 - BSI Certificate, Great Britain
 - SQS Certificate, Switzerland
 - Aib-Vincotte Certificate, Belgium
 - ÖQS Certificate, Austria

Various German and international approvals are available for feed-through terminal blocks. They are indicated in detail on the corresponding product pages. The feed-through blocks of series WK/WKN are approved for the increased-safety type of protection Eex "e" accord. to DIN EN 50019/VDE 0170/0171 part 6 where indicated. No type test is required for the Eex "i" type of protection.

You can use our **wieplan** software to configure your own terminal block assemblies (see page 10/11).

Note:

The information regarding cross sectional area and connection types pertains to unprepared wires without ferrules.

The voltage ratings apply to the terminals in their intended application. When different products are mounted adjacent to each other, the proper isolation distances must be adhered to. For this purpose, **Wieland** offers a large selection of appropriate accessories.

A detailed description of technical data, the standards' requirements, and the application conditions can be found in part **facts & DATA**.



DIN rail terminal blocks with screw connection, type WKN

selos

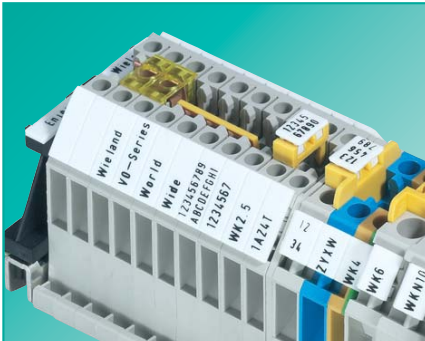

Marking accessories

- Single marking tags to match the terminal block spacing
- Snap-on marking strips (10 individual marking tags per strip) for rapid marking
- Tear-off marking strips marking up to 3-digits per terminal block
- Custom marking upon request

Cross connection (jumping)

- Potential commoning can be achieved by means of cross connectors (jumpers) or jumper bars
- Insulated and uninsulated cross connectors are available in 2-12 pole configuration. Uninsulated versions are also available in larger pole configurations which can be cut to order.
- Cross connectors** (jumpers) are mounted in the center thread of the current carrying bar
- They are preassembled for easy installation and the screws are secured against accidental loosening.
- In order to keep the rated voltage, end plates partitions or partition plates must be used

Jumper combs

- Number of poles: 2 to 12; with cut-to-order strips higher pole configurations can be achieved
- Terminal blocks of different potentials must be mounted in staggering order
- When using **jumper combs** you must insert the comb and the wire together in the clamping body
- AWG must be reduced to the next size when using jumper combs
- All insulated cross connectors IVB WK... and insulated jumper combs IVK WK... are protected against accidental contact accord. to VBG 4

Cover with warning symbol

- Cover with warning symbol to snap on to blocks which remain live when the main switch is disconnected (VDE 0113)
- The cover can only be removed with a screwdriver

Partition plates

- Full rated voltage is maintained when using partition plate with cross connectors (jumpers).
- Can be installed post assembly
- The partition plates can only be removed with a screwdriver
- The cross connector covers protect the user against accidental contact
- Various marking options are available with the standard Wieland marking system

selos

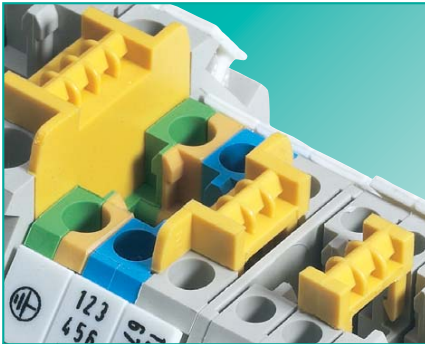

Protection against accidental contact for cross connectors

In addition to the partition plates you can use covers to protect the uninsulated cross connectors against accidental contact. They snap on tight and can be marked with the Wieland marking accessories.



Switchable connecting links

- Shorts two terminals together and provides a separable connection
- Mounted to the center thread of the current carrying bar on the terminal blocks



Test sockets

Test plugs

Shorting plug

- Stud bolts for test plugs and cross connector plugs are mounted on the center thread of the current carrying bar on the terminal blocks
- Test plugs with locking levers can be snapped together in any pole configuration



Partition plates

End plates

- Partition plates optically separate different terminal block groups, and are required to keep the air and creepage distances when cross connectors of different potentials are mounted adjacent to each other
- For safety reasons the partitions are constructed in a way that they can only be removed together with the neighboring terminal block



You can use our **wieplan** software to design your own terminal block assemblies (see page 10/11).

DIN rail terminal blocks with screw connection, type WKN

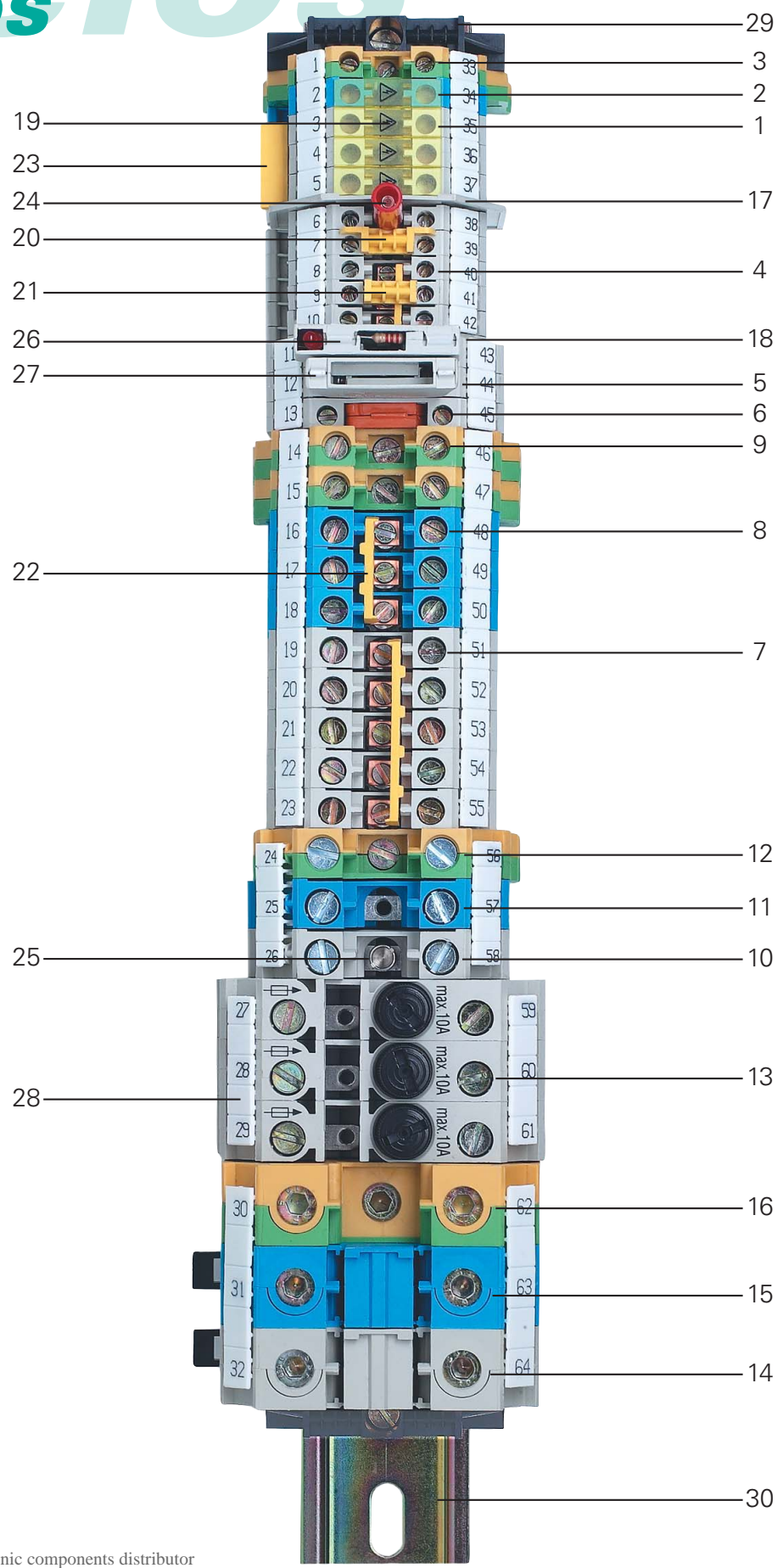

selos

selos

Item	Description	Type	Part number
1	Feed through block	WK 4/U	57.504.0055.0
2	Feed-through block, blue	WK 4/U BLAU	57.504.0055.6
3	Ground block	WK 4 SL/U	57.504.9055.0
4	Feed through block	WK 2,5/U	57.503.0055.0
5	Disconnect block	WK 4 TKG/U	57.504.4055.0
6	Knife edge disconnect block	WK 4 TKM/U	57.504.2055.0
7	Feed through block	WK 6/U	57.506.0055.0
8	Feed-through block, blue	WK 6/U BLAU	57.506.0055.6
9	Ground block	WK 6 SL/U	57.506.9055.0
10	Feed through block	WKN 10/U	57.510.0155.0
11	Feed-through block, blue	WKN 10/U BLAU	57.510.0155.6
12	Ground block	WKN 10 SL/U	57.510.9055.0
13	Fuse block	WK 10 SI/U 5x20	57.910.5055.0
14	Feed through block	WKN 35/U	57.535.0155.0
15	Feed-through block, blue	WKN 35/U BLAU	57.535.0155.6
16	Ground block	WKN 35/U	57.535.9055.0
17	Partition	TW 2,5-4	07.311.1155.0
18	End plate	AP 2,5-4	07.311.0155.0
19	Cover strip with warning symbol	AD VB 6/4 GELB	04.343.4856.8
20	over 4 blocks Partition plate, yellow	TS 2,5 GELB	07.311.2053.8
21	Single cover for cross conn. with mark. facil.	AD VB 2,5 GELB	04.326.2053.8
22	Cross connector with screws, insulated	IVB WK 6-3	Z7.282.2327.0
23	Jumper comb, insulated	IVB 0,5 WK 4-3	Z7.255.0327.0
24	Test plug	ST 2/2,3	Z5.553.2921.0
25	Stud bolt for test plug	9011B	05.508.3221.0
26	Fuse holder with indicator	SIST LED	Z1.299.4155.0
27	Diode plug, without contacts	DIST	Z1.299.3155.0
28	Marking strip	9705 A/8/10 B	04.842.0153.0
29	End clamp with U-foot	WE 1/U	Z5.523.5753.0
30	Mounting rail	35x27x7,5 slotted	98.300.0000.0

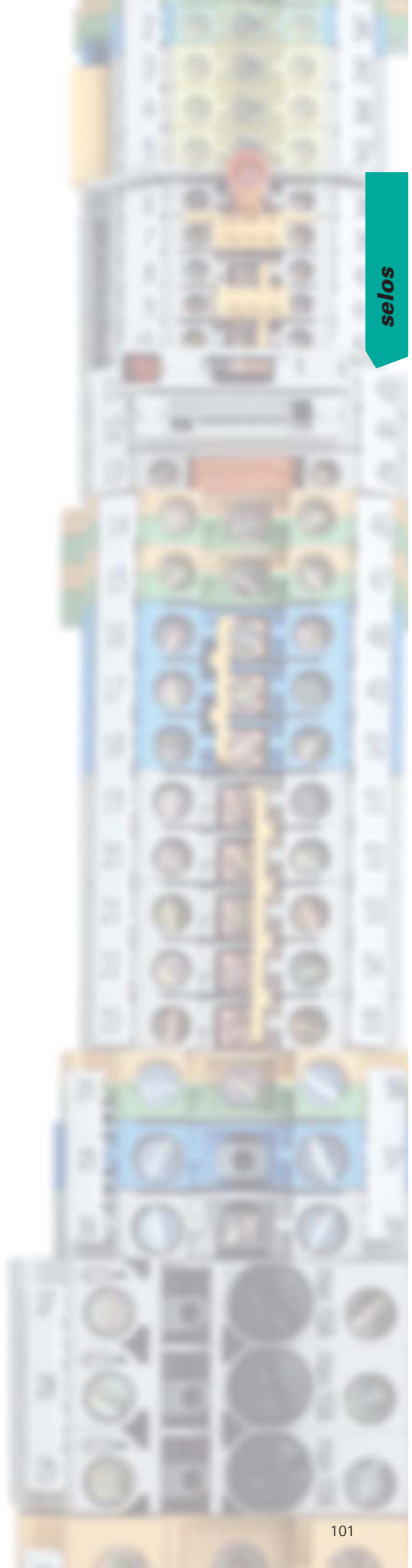

selos

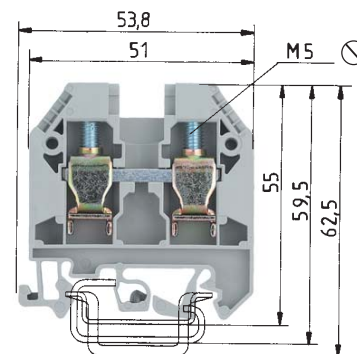
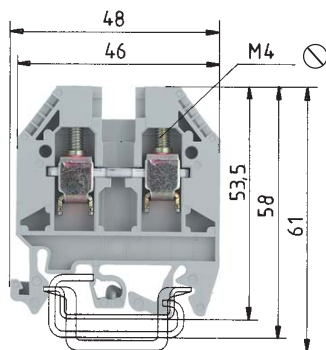
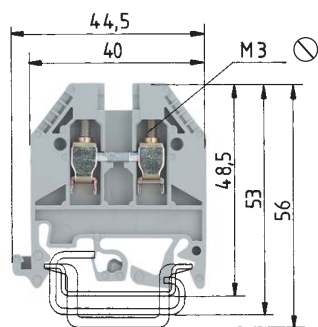

WK 4/U

fine stranded solid V A
 0.5 – 4 mm² 0.5 – 6 mm² 800 V/8 kV/3 32
 No. 22-10 AWG³⁾ 600 V 30/35
 No. 20-10 AWG 600 V 40
 6 mm 9 mm



WK 6/U

fine stranded solid V A
 0.5 – 6 mm² 2.5 – 10 mm² 800 V/8 kV/3 41
 No. 22-8 AWG⁴⁾ 600 V 50/50
 No. 20-8 AWG 600 V 45
 8 mm 11 mm



WKN 10/U

fine stranded solid/stranded V A
 2.5 – 10 mm² 1.5 – 16 mm² 800 V/8 kV/3 57
 No. 16-6 AWG⁵⁾ 600 V 65/65
 No. 16-6 AWG 600 V 70
 10 mm 13 mm



Type	Part no.	Std. pack	Type	Part no.	Std. pack	Type	Part no.	Std. pack
WK 4/U	57.504.0055.0	100	WK 6/U	57.506.0055.0	100	WKN 10/U	57.510.0155.0	50
WK 4/U BLAU	57.504.0055.6	100	WK 6/U BLAU	57.506.0055.6	100	WKN 10/U BLAU	57.510.0155.6	50
WK 4/U ²⁾	57.504.0055.0	100	WK 6/U ²⁾	57.506.0055.0	100	WKN 10/U	57.510.0155.0	50
35 x 27 x 7,5 EN 60715	98.300.0000.0	1	35 x 27 x 7,5 EN 60715	98.300.0000.0	1	35 x 27 x 7,5 EN 60715	98.300.0000.0	1
35 x 24 x 15 EN 60715	98.360.0000.0	1	35 x 24 x 15 EN 60715	98.360.0000.0	1	35 x 24 x 15 EN 60715	98.360.0000.0	1
9006 EN 60715 G-32	98.190.0000.0	1	9006 EN 60715 G-32	98.190.0000.0	1	9006 EN 60715 G-32	98.190.0000.0	1
WE 1/U	Z5.523.5753.0	100	WE 1/U	Z5.523.5753.0	100	WE 1/U	Z5.523.5753.0	100
9708/2 S35	Z5.522.8553.0	100	9708/2 S35	Z5.522.8553.0	100	9708/2 S35	Z5.522.8553.0	100
9708	Z5.522.7053.0	100	9708	Z5.522.7053.0	100	9708	Z5.522.7053.0	100
AP 2,5 - 4	07.311.0155.0	10	AP 6	07.311.0255.0	10	APN 10	07.311.6655.0	10
AP 2,5 - 4 BLAU	07.311.0155.6	10	AP 6 BLAU	07.311.0255.6	10	APN 10 BLAU	07.311.6655.6	10
TW 2,5 - 4	07.311.1155.0	10	TW 6	07.311.1255.0	10	TWN 10	07.311.7655.0	10
TW 2,5 - 4 BLAU	07.311.1155.6	10	TW 6 BLAU	07.311.1255.6	10	TWN 10 BLAU	07.311.7655.6	10
IVB WK 4 - 2	Z7.281.1227.0	10	IVB WK 6 - 2	Z7.282.2227.0	10	IVB WKN 10 - 2	Z7.283.2227.0	10
IVB WK 4 - 3	Z7.281.1327.0	10	IVB WK 6 - 3	Z7.282.2327.0	10	IVB WKN 10 - 3	Z7.283.2327.0	10
IVB WK 4 - 12	Z7.281.2227.0	10	IVB WK 6 - 12	Z7.282.3227.0	10	IVB WKN 10 - 12	Z7.283.3227.0	10
AD VB 4 GELB	04.326.2153.8	10	AD VB 6 GELB	04.326.2253.8	10	AD VB 10 GELB	04.326.2353.8	10
TS 4 GELB	07.311.2153.8	10	TS 6 GELB	07.311.2253.8	10	TS 10 GELB	07.311.2353.8	10
AD VB 6/10 P GELB	04.342.3656.8	10	AD VB 8/10 P GELB	04.342.3856.8	10	AD VB 10/10 P GELB	04.342.4056.8	10
AD VB 6/4 GELB	04.343.4856.8	10	AD VB 8/4 GELB	04.343.4956.8	10	AD VB 10/4 GELB	04.343.5056.8	10

* CL I, ZN1, AExe II / **CL I, ZN1, Exe II pending

* CL I, ZN1, AExe II / **CL I, ZN1, Exe II pending

* CL I, ZN1, AExe II / **CL I, ZN1, Exe II pending

Feed through blocks type WKN

selos

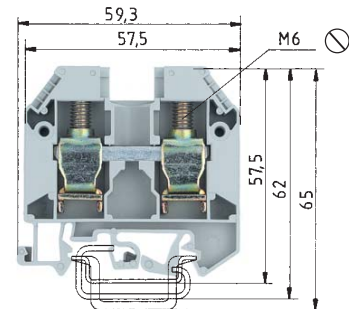

EN 60 947-7-1/DIN VDE 0611 T1
 UL-ratings field/factory wiring
 CSA ratings
 Width Wire strip length
 Approvals

WKN 16/U

fine stranded solid/stranded V A
 4 – 16 mm² 1.5 – 25 mm² 800 V/8 kV/3 76
 No. 12-4 AWG 600 V 85/90
 No. 14-4 AWG 600 V 95
 12 mm 15 mm
 Ⓢ SEV-EEx Ⓢ BKI-EEx Ⓢ LR 9L *

Mounting instructions for EEx e applications

- If feed-through blocks are mounted directly adjacent to feed-through blocks of a different size, or directly adjacent to ground blocks, the open side of a group of the same type of blocks has to be covered by an end plate or partition.
- If neighboring terminal blocks are jumpered by a cross connector, the required isolation distances have to be maintained by inserting either a snap-in partition plate (without increased pitch), an end plate, or a partition between the different block groups, in front of or behind the cross-connected terminal block group.

	Type	Part no.	Std. pack
Feed through block	Color: gray	WKN 16/U	57.516.0155.0 50
Feed-through block EEx i	Color: blue	WKN 16/U BLAU	57.516.0155.6 50
Feed-through block EEx e*¹⁾	Color: gray	WKN 16/U ²⁾	57.516.0155.0 50
Accessories			
1. Mounting rail TS 35, DIN rail 7.5mm high L = 2 m	35 x 27 x 7,5 EN 60715	98.300.0000.0	1
Mounting rail TS 35, DIN rail, 15mm high L = 2 m	35 x 24 x 15 EN 60715	98.360.0000.0	1
Mounting rail TS 32, G rail L = 2 m	9006 EN 60715 G-32	98.190.0000.0	1
2. End clamp with U-foot 10 mm wide	WE 1/U	Z5.523.5753.0	100
End clamp TS 35, with screw 8 mm wide	9708/2 S 35	Z5.522.8553.0	100
End clamp TS 32, with screw 7.5 mm wide	9708	Z5.522.7053.0	100
3. End plate, 1.5 mm thick	Color: gray		
	Color: blue		
End plate, 2 mm thick	Color: gray	APN 16	07.311.6755.0 10
	Color: blue	APN 16 BLAU	07.311.6755.6 10
Partition, 1.5 mm thick	Color: gray		
	Color: blue		
Partition, 2 mm thick	Color: gray	TWN 16	07.311.7755.0 10
	Color: blue	TWN 16 BLAU	07.311.7755.6 10
Partition, 3 mm thick	Color: gray		
	Color: blue		
5. Cross connector with screws, E-Cu			
insulated (jumper) 2pole	IVB WKN 16 - 2	Z7.284.2227.0	10
	3pole	IVB WKN 16 - 3	Z7.284.2327.0 10
	to 12pole	IVB WKN 16 - 12	Z7.284.3227.0 10
6. Single cover f. cross conn. with mark.facility			
7. Partition plate with marking facility	TSN 16 GELB	07.311.8453.8	10
Partition plate with cover	TSN AD 16 GELB	07.311.8553.8	10
8. Cover strip for cross conn. over 10 blocks			
Cover strip with warn. symb. over 4 blocks	AD VB 12/4 GELB	04.343.5156.8	10
For more accessories see pages 160-177			
For marking systems see pages 178-179 and 200-202			* CL I, ZN1, AExe II / **CL I, ZN1, Exe II pending

*¹⁾ with CCA certificate

¹⁾ EEx e terminal blocks are subject to certification. The relevant indications in the certificate apply (e.g. 660V)

²⁾ Part certificates for EEx e approval: EEx e II ASEV 91.1 B11638U

selos

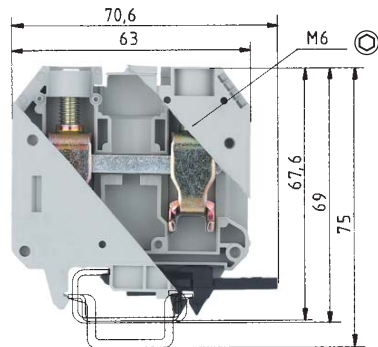

enclosed design

WKN 35/U

fine stranded stranded V A
 10–35 mm² 10–50 mm² 800 V/8 kV/3 125
 No. 10-2 AWG 600 V 95/95
 No. 10-2 AWG 600 V 110
 16 mm 18 mm
 EPM SEV-EEX D N NV FI MIP S LR **RU** *
 ** BKI-EEx

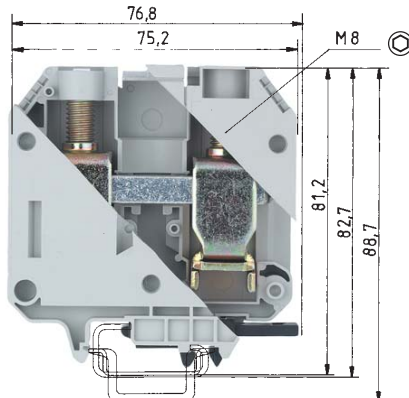

enclosed design

WKN 70/U

fine stranded stranded V A
 10–70 mm² 16–95 mm² 800 V/8 kV/3 192
 No. 6-2/0 AWG 600 V 175/175
 No. 6-2/0 AWG 600 V 170
 24 mm 24 mm
 SEV-EEX D NV LR **RU** ¹⁾ ²⁾
 BKI-EEx

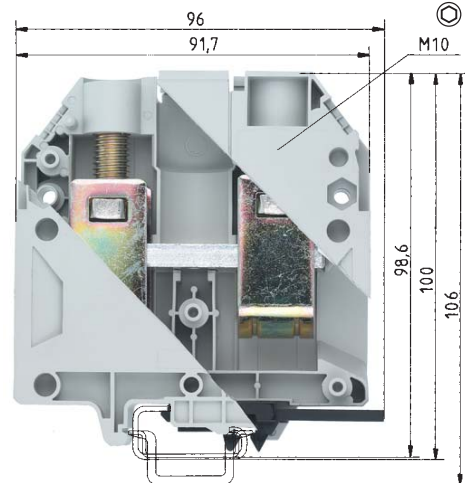

enclosed design

WKN 150/U

fine stranded stranded V A
 35–150 mm² 35–185 mm² 1000 V/8 kV/3 309
 No. 2/0 AWG - 350 kcmil 600 V 335/335
 No. 2/0 AWG - 350 MCM 1000 V 365
 28 mm 30 mm
 SEV-EEX D **RU** ¹⁾ ²⁾ BKI-EEx

Type	Part no.	Std. pack	Type	Part no.	Std. pack	Type	Part no.	Std. pack
WKN 35/U	57.535.0155.0	20	WKN 70/U	57.570.0155.0	20	WKN 150/U	57.597.0155.0	10
WKN 35/U BLAU	57.535.0155.6	20	WKN 70/U BLAU	57.570.0155.6	20	WKN 150/U BLAU	57.597.0155.6	10
WKN 35/U ²⁾	57.535.0155.0	20	WKN 70/U ²⁾	57.570.0155.0	20	WKN 150/U ²⁾	57.597.0155.0	10
35 x 27 x 7,5 EN 60715	98.300.0000.0	1	35 x 27 x 7,5 EN 60715	98.300.0000.0	1	35 x 27 x 7,5 EN 60715	98.300.0000.0	1
35 x 24 x 15 EN 60715	98.360.0000.0	1	35 x 24 x 15 EN 60715	98.360.0000.0	1	35 x 24 x 15 EN 60715	98.360.0000.0	1
9006 EN 60715 G-32	98.190.0000.0	1	9006 EN 60715 G-32	98.190.0000.0	1	9006 EN 60715 G-32	98.190.0000.0	1
WE 2/U	Z5.523.5653.0	100	WE 2/U	Z5.523.5653.0	100	WE 2/U	Z5.523.5653.0	100
9708/2 S 35	Z5.522.8553.0	100	9708/2 S 35	Z5.522.8553.0	100	9708/2 S 35	Z5.522.8553.0	100
9708	Z5.522.7053.0	100	9708	Z5.522.7053.0	100	9708	Z5.522.7053.0	100
TWN 35	07.311.7855.0	10	TWN 70	07.311.7955.0	10			
TWN 35 BLAU	07.311.7855.6	10	TWN 70 BLAU	07.311.7955.6	10			
			jumper bars unisulated see page 165			jumper bars unisulated see page 165		
IVB WKN 35 - 2	Z7.285.2227.0	5						
IVB WKN 35 - 3	Z7.285.2327.0	5						
IVB WKN 35 - 12	Z7.285.3227.0	5						
AD VB 35 GELB	04.326.2553.8	10	AD VB 70 GELB	04.326.2653.8	10			
AD VB 16/4 GELB	04.343.5256.8	10	AD VB 24/4 GELB	04.343.5356.8	10	AD VB 28/4 GELB	04.343.5456.8	10

* CL I, ZN1, AExe II / ** CL I, ZN1, Exe II pending

¹⁾ ²⁾ CL I, ZN1, AExe II, Exe II pending

¹⁾ ²⁾ CL I, ZN1, AExe II, Exe II pending

Neutral disconnect blocks for installation with U-foot, type WKN

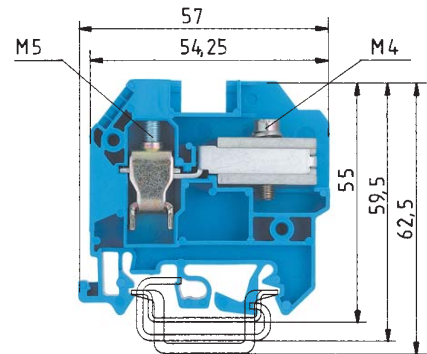
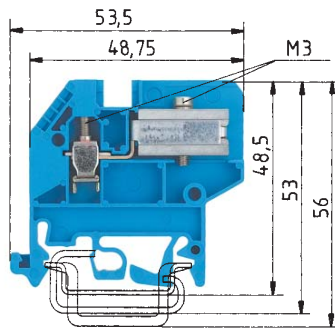
Current carrying capability:
fine stranded: 4 mm² 25 A
solid: 6 mm² 30 A

Current carrying capability:
fine stranded: 10 mm² 45 A
stranded: 16 mm² 50 A

WKN 4 ETK/U

fine stranded solid V A
0.5 – 4 mm² 0.5 – 6 mm² 400 V/6 kV/3^{*)}
CSA No. 20-10 AWG 600V 25
6 mm 9 mm



WKN 10 ETK/U

fine stranded solid/stranded V A
1 – 10 mm² 1 – 16 mm² 400 V/6 kV/3^{*)}
CSA No. 16-6 AWG 600V 45
10 mm 13 mm



EN 60 947-7-1/DIN VDE 0611 T1
UL-ratings/CSA ratings field/factory wiring
Width Wire strip length
Approvals

Neutral disconnect block		Type	Part no.	Std. pack	Type	Part no.	Std. pack
Color: blue		WKN 4 ETK/U	57.504.8155.0	100	WKN 10 ETK/U	57.510.8155.0	50
Accessories							
1. Mounting rail TS 35, DIN rail, 7.5 mm high L = 2 m		35 x 27 x 7,5 EN 60715	98.300.0000.0	1	35 x 27 x 7,5 EN 60715	98.300.0000.0	1
Mounting rail TS 35, DIN rail 15 mm high L = 2 m		35 x 24 x 15 EN 60715	98.360.0000.0	1	35 x 24 x 15 EN 60715	98.360.0000.0	1
Mounting rail TS 32, G rail L = 2 m		9006 EN 60715 G-32	98.190.0000.0	1	9006 EN 60715 G-32	98.190.0000.0	1
2. End clamp with U-foot 10 mm wide		WE 1/U	Z5.523.5753.0	100	WE 1/U	Z5.523.5753.0	100
End clamp TS 35, with screw 8 mm wide		9708/2 S35	Z5.522.8553.0	100	9708/2 S35	Z5.522.8553.0	100
End clamp TS 32, with screw 7.5 mm wide		9708	Z5.522.7053.0	100	9708	Z5.522.7053.0	100
3. End plate 1,5 mm thick Color: gray							
End plate 2 mm thick Color: gray		APN 4 ETK	07.312.1155.0	10	APN 10 ETK	07.312.0955.0	10
		Color: blue					
4. Partition, 1.5 mm thick Color: gray							
		Color: blue					
Partition, 2 mm thick Color: gray							
		Color: blue					
Partition, 3 mm thick Color: gray							
		Color: blue					
5. Busbar support 10 x 3 4 mm wide		WKI SH/U	01.108.3255.0	10	WKI SH/U	01.108.3255.0	10
6. Busbar E-Cu, 10 x 3 L = 1 m		9813 M	98.290.0000.0	1	9813 M	98.290.0000.0	1
Busbar, tin-plated, 10 x 3 L = 1 m		9813 M SN	98.290.1000.0	1	9813 M SN	98.290.1000.0	1
7. Connector clamps for busbar Farbe: blue							
Connector clamps for busbar Color: unplated							
8. Single cover f. cross conn. with marking facility		AD VB 4 GELB	04.326.2153.8	10	AD VB 10 GELB	04.326.2353.8	10
9. Partition plate with marking facility							
10. Cover strip for cross conn. over 10 blocks							
Cover strip with warn. symb. over 4 blocks							
For more accessories see pages 160-177							
For marking systems see pages 178-179 and 200-202							
*) For use in grounded networks 690/400 V							

Ground blocks type WK/WKN... SL/U

selos

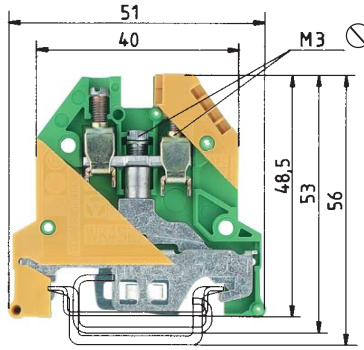

enclosed design

WK 4 SL/U

fine stranded solid V A
 0.5 – 4 mm² 0.5 – 6 mm² 800 V/8 kV/3^{*} **)
 No. 22-10 AWG
 No. 20-10 AWG
 6 mm 9 mm
 EPM SEV-EEX SEP N NV P K12 K13 S LR UL * CE **
 BKI-EEEx

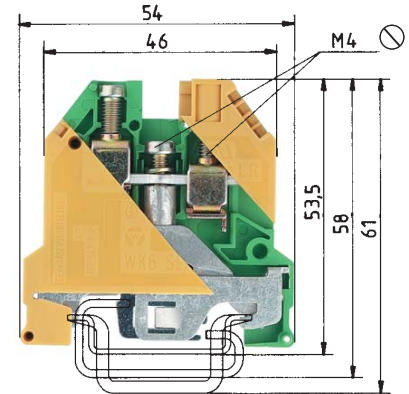

enclosed design

WK 6 SL/U

fine stranded solid V A
 0.5 – 6 mm² 0.5 – 10 mm² 800 V/8 kV/3^{*} **)
 No. 22-8 AWG
 No. 20-8 AWG
 8 mm 12 mm
 EPM SEV-EEX SEP N NV P K12 K13 S LR UL * CE **
 BKI-EEEx

EN 60 947-7-2/DIN VDE 0611 T3
 UL-ratings field/factory wiring
 CSA ratings
 Width Wire strip length
 Approvals

Ground block with U-foot	Color: yellow/green	Type	Part no.	Std. pack	Type	Part no.	Std. pack
EEx e ground block with U-foot¹⁾		WK 4 SL/U	57.504.9055.0	100	WK 6 SL/U	57.506.9055.0	100
		WK 4 SL/U ²⁾	57.504.9055.0	100	WK 6 SL/U ²⁾	57.506.9055.0	100
Accessories							
1. Mounting rail TS 35, DIN rail, 7.5 mm high	L = 2 m	35 x 27 x 7,5 EN 60715	98.300.0000.0	1	35 x 27 x 7,5 EN 60715	98.300.0000.0	1
Mounting rail TS 35, DIN rail, 15mm high	L = 2 m	35 x 24 x 15 EN 60715	98.360.0000.0	1	35 x 24 x 15 EN 60715	98.360.0000.0	1
Mounting rail TS 32, G rail	L = 2 m	9006 EN 60715 G-32	98.190.0000.0	1	9006 EN 60715 G-32	98.190.0000.0	1
2. End clamp with U-foot	10 mm wide						
End clamp TS 35, with screw	8 mm wide						
End clamp TS 32, with screw	7.5 mm wide						
3. End plate, 1.5 mm thick	Color: gray						
	Color: blue						
End plate, 2 mm thick	Color: gray						
	Color: blue						
4. Partition, 1.5 mm thick	Color: gray						
	Color: blue						
Partition, 2 mm thick	Color: gray						
	Color: blue						
Partition, 3 mm thick	Color: gray						
	Color: blue						
5. Cross connector with screws, E-Cu							
insulated (jumper)	2pole						
	3pole						
	to 12pole						
6. Single cover f. cross conn. with marking facility							
7. Snap-in partition plate with marking facility							
8. Cover strip for cross conn. over 10 blocks							
Cover strip with warn. symb. over 4 blocks							
For more accessories see pages 160-177							
For marking systems see pages 178-179 and 200-202		* CL I, ZN1, AExe II / **CL I, ZN1, Exe II pending					
^{*)} Ratings to adjacent feed-through blocks of the same series and size ^{**)} For the current carrying capability of the mounting rail see section facts & DATA ¹⁾ EEx e terminal blocks are subject to certification. The relevant indications in the certificate apply (e.g. 660V) ²⁾ Part certificates for EEx e approval: EEx e II ASEV 91.1 B11638U							
						* CL I, ZN1, AExe II / **CL I, ZN1, Exe II pending	

Ground blocks with screw connection, type WKN



For ground blocks of 70 mm² or more only mounting rails from E-copper must be used because of the current carrying capability.

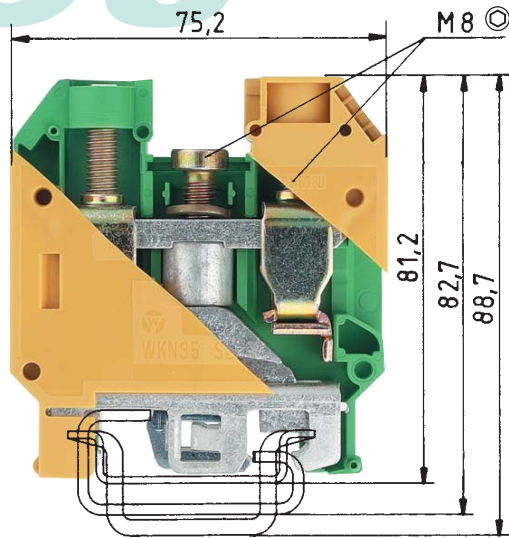

enclosed design available from October 2001

WKN 70 SL/U

DIN VDE 0611 Teil 3/11.89, DIN VDE 0110/01.89
UL-ratings field/factory wiring
CSA ratings
Width Wire strip length
Approvals

fine stranded stranded V A
10 – 70 mm² 16 – 95 mm² 800 V/8 kV/3 **)
CSA No. 6-2/0 AWG Pending
24 mm
UL * CE *

	Type	Part no.	Std. pack
Ground block with U-foot Color: yellow/green	WKN 70 SL/U	57.570.9055.0	
Ground block for TS 35 EN60715 Color: yellow/green			
Accessories			
1. Mounting rail TS 35, DIN rail, 7.5 mm high L = 2 m			
Mounting rail TS 35, DIN rail, 15mm high L = 2 m	35 x 24 x 15 EN 60715 CU	98.380.0000.0	10
Mounting rail TS 32, G rail L = 2 m	9006 EN 60715 G-32 E-CU	98.220.0000.0	10
2. End clamp with U-foot 10 mm wide			
End clamp TS 35, with screw 8 mm wide			
End clamp TS 32, with screw 7.5 mm wide			
3. End plate, 1.5 mm thick Color: gray			
Color: blue			
End plate, 2 mm thick Color: gray			
Color: blue			
4. Partition, 1.5 mm thick Color: gray			
Color: blue			
Partition, 2 mm thick Color: gray			
Color: blue			
Partition, 3 mm thick Color: gray			
Color: blue			
5. Cross connector (jumper) with screws, E-Cu			
insulated 2pole			
3pole			
to 12pole			
6. Single cover f. cross conn. with marking facility			
7. Partition plate with marking facility			
8. Cover strip for cross conn. over 10 blocks			
Cover strip with warn. symb. over 4 blocks			
For more accessories see pages 160-177			
For marking systems see pages 178-179 and 200-202	* CL I, ZN1, AExe II / Exe II pending		
**) For the current carrying capability of the mounting rail see section facts & DATA			

Duo feed through blocks, type WK 4/D...

selos

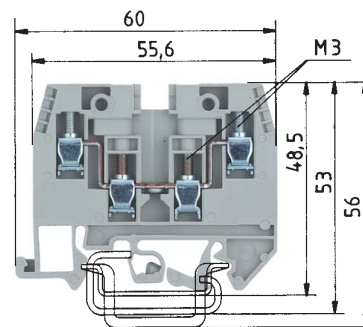
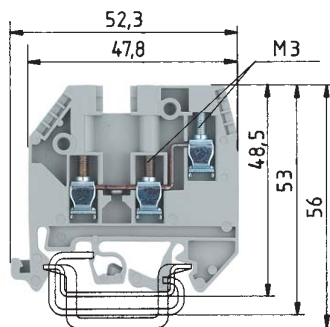

WK 4/D 1/2 /U

fine stranded	solid	V	A
0.5 – 4 mm ²	0.5 – 6 mm ²	500 V/6 kV/3	32
No. 22-10 AWG		600 V	30
No. 20-10 AWG		600 V	30
6 mm			9 mm



WK 4/D 2/2 /U

fine stranded	solid	V	A
0.5 – 4 mm ²	0.5 – 6 mm ²	500 V/6 kV/3	32
No. 22-10 AWG		600 V	30
No. 20-10 AWG		600 V	30
6 mm			9 mm



EN 60 947-7-1/DIN VDE 0611 T1
 EN 60 947-7-2/DIN VDE 0611 T3
 UL-ratings field/factory wiring
 CSA ratings
 Width Wire strip length
 Approvals

	Type	Part no.	Std. pack	Type	Part no.	Std. pack	
Duo feed-through block 1/2	Color: gray	WK 4/D 1/2 /U	57.504.5055.0	100			
	Color: blue	WK 4/D 1/2 /U BLAU	57.504.5055.6	100			
Duo feed-through block 2/2	Color: gray			WK 4/D 2/2 /U	57.504.5155.0	100	
	Color: blue			WK 4/D 2/2 /U BLAU	57.504.5155.6	100	
Duo multi-tier block	Color: gray						
Duo ground block 2/2	Color: green/yellow						
Accessories							
1. Mounting rail TS 35, DIN rail, 7.5 mm high L = 2 m	35 x 27 x 7,5 EN 60715	98.300.0000.0	1	35 x 27 x 7,5 EN 60715	98.300.0000.0	1	
Mounting rail TS 35, DIN rail 15 mm high L = 2 m	35 x 24 x 15 EN 60715	98.360.0000.0	1	35 x 24 x 15 EN 60715	98.360.0000.0	1	
Mounting rail TS 32, G rail L = 2 m	9006 EN 60715 G-32	98.190.0000.0	1	9006 EN 60715 G-32	98.190.0000.0	1	
2. End clamp with U-foot 10 mm wide	WE 1/U	Z5.523.5753.0	100	WE 1/U	Z5.523.5753.0	100	
End clamp TS 35, with screw 8 mm wide	9708/2 S 35	Z5.522.8553.0	100	9708/2 S 35	Z5.522.8553.0	100	
End clamp TS 32 with screw 7.5 mm wide	9708	Z5.522.7053.0	100	9708	Z5.522.7053.0	100	
3. End plate, 1.5 mm thick	Color: gray	AP 4/D 1/2	07.311.6455.0	10	AP 4/D..	07.311.6355.0	10
	Color: blue	AP 4/D 1/2 BLAU	07.311.6455.6		AP 4/D.. BLAU	07.311.6355.6	10
4. Partition, 1.5 mm thick	Color: gray						
	insulated (jumper) 2pole	IVB WK 4 D...-2	Z7.281.7227.0	10	IVB WK 4 D...-2	Z7.281.7227.0	10
	3pole	IVB WK 4 D...-3	Z7.281.7327.0	10	IVB WK 4 D...-3	Z7.281.7327.0	10
	to 12pole	IVB WK 4 D...-12	Z7.281.8227.0	10	IVB WK 4 D...-12	Z7.281.8227.0	10
6. Jumper comb for lower tier blocks	insulated 2pole	IVK WK 4/D...-2	Z7.256.2227.0	10	IVK WK 4/D...-2	Z7.256.2227.0	10
	to 6pole	IVK WK 4/D...-6	Z7.256.2627.0	10	IVK WK4/D...-6	Z7.256.2627.0	10
	Jumper comb, straight, 1mm thick 2pole to 6pole						
7. Single cover f. cross conn. with marking facility	AD VB 4 GELB	04.326.2153.8	10	AD VB 4 GELB	04.326.2153.8	10	
8. Partition plate with marking facility	TS 4/15 GELB	07.311.2953.8	10	TS 4/15 GELB	07.311.2953.8	10	
9. Cover strip for cross conn. over 10 blocks	AD VB 6/10 GELB	04.342.0656.8	10	AD VB 6/10 GELB	04.342.0656.8	10	
Cover strip with warn. symb. over 4 blocks							
10. Cover with warning symbol							
For more accessories see pages 160-177							
For marking systems see pages 178-179 and 200-202							

* CL I, ZN1, AExe II / **CL I, ZN1, Exe II pending

* CL I, ZN1, AExe II / **CL I, ZN1, Exe II pending

selos

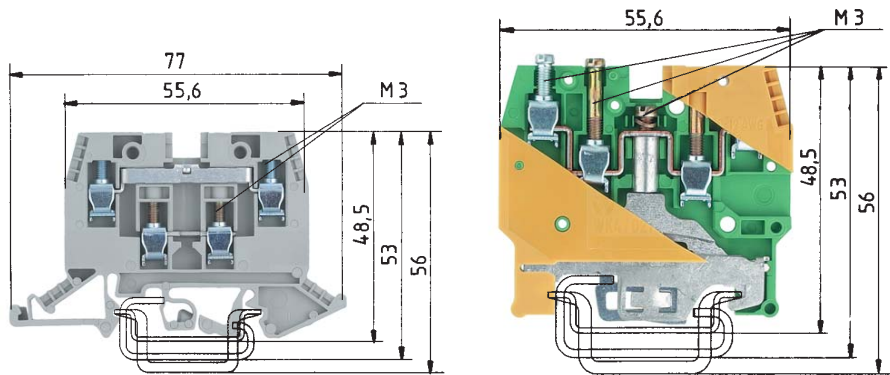

*¹ 500 V/6 kV/3 with partition plate 07.311.2953.8 between two adjacent blocks
 **¹ with partition plate 07.311.2953.8 between two adjacent blocks

enclosed design
 *¹ For the ratings to adjacent feed-through blocks of the same series and size and the current carrying capability of the mounting rail see section **facts & DATA**

WK 4/D EU

Type	Part no.	Std. pack	V	A
0.5 – 4 mm ²	0.5 – 6 mm ²	320 V/4 kV/3* ¹	26	
No. 22-10 AWG		300 V** ¹	30	
No. 20-10 AWG		600 V** ¹	30	
6 mm			9 mm	



WK 4/D 2/2 SL U

Type	Part no.	Std. pack	V	A
0.5 – 4 mm ²	0.5 – 6 mm ²	500 V/6 kV/3* ¹		
No. 22-10 AWG				
No. 20-10 AWG				
6 mm			9 mm	



Type	Part no.	Std. pack	Type	Part no.	Std. pack
WK 4/D EU	57.504.5255.0	100	WK 4/D 2/2 SL U	57.504.9155.0	100
35 x 27 x 7,5 EN 60715	98.300.0000.0	1	35 x 27 x 7,5 EN 60715	98.300.0000.0	1
35 x 24 x 15 EN 60715	98.360.0000.0	1	35 x 24 x 15 EN 60715	98.360.0000.0	1
9006 EN 60715 G-32	98.190.0000.0	1	9006 EN 60715 G-32	98.190.0000.0	1
WE 1/U	Z5.523.5753.0	100			
9708/2 S 35	Z5.522.8553.0	100			
9708	Z5.522.7053.0	100			
AP 4/D...	07.311.6355.0	10			
AP 4/D.. BLAU	07.311.6355.6	10			
IVB WK 4/DEU-2	Z7.271.0227.0	10			
IVB WK 4 /DEU-3	Z7.271.0327.0	10			
IVB WK 4/DEU-12	Z7.271.1227.0	10			
IVK WK 4/D...-2	Z7.256.2227.0	10			
IVK WK 4/D...-6	Z7.256.2627.0	10			
AD VB 4 GELB	04.326.2153.8	10			
TS 4/15 GELB	07.311.2953.8	10			
AD VB 6/10 GELB	04.342.0656.8	10			

* CL I, ZN1, AExe II / **CL I, ZN1, Exe II

* CL I, ZN1, AExe II / **CL I, ZN1, Exe II

Multi-tier blocks type WK 4 E...

selos

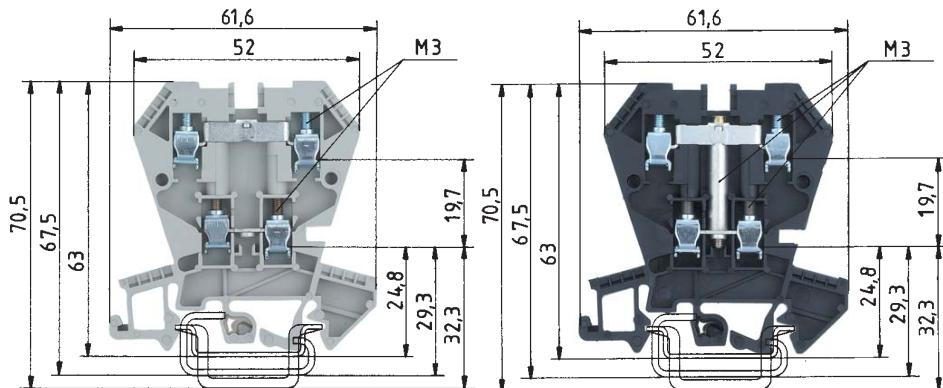

WK 4 E/U

	fine stranded	solid	V	A
	0.5 – 4 mm ²	0.5 – 4 mm ²	400 V/6 kV/3 ¹⁾	32
	No. 22-10 AWG		300 V	20
	No. 20-12 AWG		300 V	10
	6 mm			9 mm



WK 4 E/U /VB

	fine stranded	solid	V	A
	0.5 – 4 mm ²	0.5 – 4 mm ²	400 V/6 kV/3	32
	No. 22-10 AWG		300 V	20
	No. 20-12 AWG		300 V	10
	6 mm			9 mm



EN 60 947-7-1/DIN VDE 0611 T1
 EN 60 947-7-2/DIN VDE 0611 T3
 UL-ratings field/factory wiring
 CSA ratings
 Width Wire strip length
 Approvals

	Type	Part no.	Std. pack	Type	Part no.	Std. pack
Multi-tier block Color: gray	WK 4 E/U	57.404.7055.0	100			
Multi-tier block Color: black				WK 4 E/U/VB SCHWARZ	57.404.6955.1	100
Multi-tier block with inverted diode Color: orange						
Multi-tier block Color: red						
Ground block Color: green/yellow						
Accessories						
1. Mounting rail TS 35, DIN rail, 7.5 mm high L = 2 m	35 x 27 x 7,5 EN 60715	98.300.0000.0	1	35 x 27 x 7,5 EN 60715	98.300.0000.0	1
Mounting rail TS 35, DIN rail 15 mm high L = 2 m	35 x 24 x 15 EN 60715	98.360.0000.0	1	35 x 24 x 15 EN 60715	98.360.0000.0	1
Mounting rail TS 32, G rail L = 2 m	9006 EN 60715 G-32	98.190.0000.0	1	9006 EN 60715 G-32	98.190.0000.0	1
2. End clamp with U-foot 10 mm wide	WE 1/U	Z5.523.5753.0	100	WE 1/U	Z5.523.5753.0	100
End clamp TS 35, with screw 8 mm wide	9708/2 S 35	Z5.522.8553.0	100	9708/2 S 35	Z5.522.8553.0	100
End clamp TS 32 with screw 7.5 mm wide	9708	Z5.522.7053.0	100	9708	Z5.522.7053.0	100
3. End plate, 1.5 mm thick Color: gray	AP 4 E	07.311.4055.0	10	AP 4 E	07.311.4055.0	10
Partition, 1.5 mm thick Color: gray	TW 4 E	07.311.5055.0	10	TW 4 E	07.311.5055.0	10
5. Cross connector with screws, E-Cu						
uninsulated for top tier 2pole	9215-2	Z7.210.3227.0	50		Z7.210.3227.0	50
3pole	9215-3	Z7.210.3327.0	50		Z7.210.3327.0	50
to 6pole	9215-6	Z7.210.3627.0	50		Z7.210.3627.0	50
6. Jumper comb for lower tier block						
angled, 1 mm thick insulation 2pole	IVBS WK 4 E-2	Z7.256.4227.0	10	IVBS WK 4 E-2	Z7.256.4227.0	10
to 6pole	IVBS WK 4 E-6	Z7.256.4627.0	10	IVBS WK 4 E-6	Z7.256.4627.0	10
Jumper comb for lower tier block						
straight, 1mm thick insulated 2pole	IVB WK 4 E-2	Z7.255.2227.0	10	IVB WK 4 E-2	Z7.255.2227.0	10
to 6pole	IVB WK 4 E-6	Z7.255.2627.0	10	IVB WK 4 E-6	Z7.255.2627.0	10
7. Single cover f. cross conn. with marking facility	IVB WK 4 E-6	Z7.255.2627.0	10			
8. Snap-in partition plate with marking facility	AD VB 4/15 GELB	04.326.2953.8	10			
9. Cover strip for cross conn. over 10 blocks				AD VB 6/10 E GELB	04.342.2656.8	10
Cover strip with warning symbol over 4 blocks	AD VB 6/10 E GELB	04.342.2656.8	10			
For more accessories see pages 160-177						
For marking systems see pages 178-179 and 200-202						

¹⁾ With end plates 500 V/6 kV/3

* CL I, ZN1, AExe II / ** CL I, ZN1, Exe II pending

Multi-tier feed-through block

selos

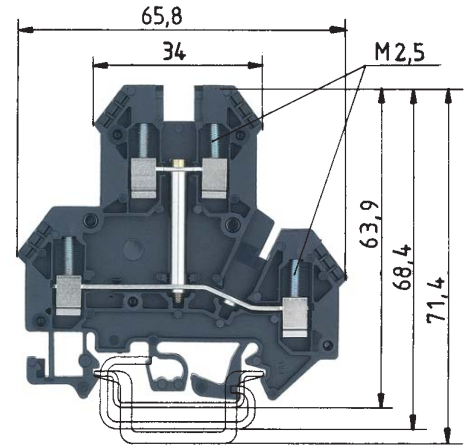
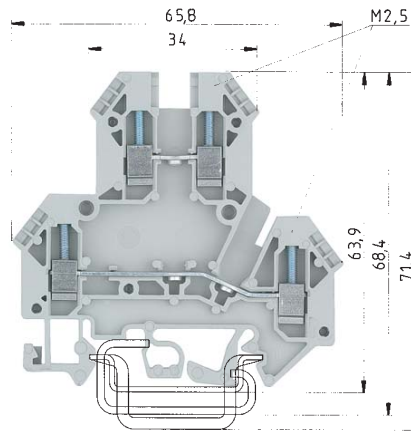

WKN 2,5 E/U

	V	A
fine stranded solid	500 V/6 kV/3	24
0.5 – 2.5 mm ² 0.5 – 4 mm ²	600 V	20/25
No. 22-12 AWG	600 V	25
No. 24-12 AWG		8 mm
5 mm		



WKN 2,5 E/U/VB

	V	A
fine stranded solid	500 V/6 kV/3	24
0.5 – 2.5 mm ² 0.5 – 4 mm ²	600 V	20/25
No. 22-12 AWG	600 V	25
No. 24-12 AWG		8 mm
5 mm		



EN 60 947-7-1/DIN VDE 0611 T1
 UL-ratings field/factory wiring
 CSA ratings
 Width Wire strip length
 Approvals

		Type	Part no.	Std. pack	Type	Part no.	Std. pack
Multi-tier feed-through block	Color: gray	WKN 2,5 E/U	57.403.7055.0	100			
upper and lower feed-through tier connected	Color: black				WKN 2,5 E/U/VB	57.403.6955.1	100
Accessories							
1. Mounting rail TS 35, DIN rail 7.5mm high	L = 2 m	35 x 27 x 7,5 EN 60715	98.300.0000.0	1	35 x 27 x 7,5 EN 60715	98.300.0000.0	1
Mounting rail TS 35, DIN rail 1.5mm high	L = 2 m	35 x 24 x 15 EN 60715	98.360.0000.0	1	35 x 24 x 15 EN 60715	98.360.0000.0	1
Mounting rail TS 32, G rail	L = 2 m	9006 EN 60715 G-32	98.190.0000.0	1	9006 EN 60715 G-32	98.190.0000.0	1
2. End clamp with U-foot	10 mm wide	WE 1/U	Z5.523.5753.0	100	WE 1/U	Z5.523.5753.0	100
End clamp TS 35, with screw	8 mm wide	9708/2 S 35	Z5.522.8553.0	100	9708/2 S 35	Z5.522.8553.0	100
End clamp TS 32, with screw	7.5 mm wide	9708	Z5.522.7053.0	100	9708	Z5.522.7053.0	100
3. End plate	1.5 mm thick	APN 2,5 E	07.312.1755.0	10	APN 2,5 E	07.312.1755.0	10
4. Partition	1.5 mm thick	TWN 2,5 E	07.312.1855.0	10	TWN 2,5 E	07.312.1855.0	10
5. Cross connector with screws for upper and lower feed-through tier, insulated	2pole	IVB WK 2,5 - 2	Z7.280.2227.0	10	IVB WK 2,5 - 2	Z7.280.2227.0	10
	3pole	IVB WK 2,5 - 3	Z7.280.2327.0	10	IVB WK 2,5 - 3	Z7.280.2327.0	10
	to 12pole	IVB WK 2,5 - 12	Z7.280.3227.0	10	IVB WK 2,5 - 12	Z7.280.3227.0	10
6. Single cover f. cross conn. with marking facility		AD VB 2,5 GELB	04.326.2053.8	10	AD VB 2,5 GELB	04.326.2053.8	10
7. Cover strip for cross conn. over 10 blocks		AD VB 5/10 GELB	04.342.0556.8	10	AD VB 5/10 GELB	04.342.0556.8	10
8. Cover strip with warning symbol over 4 blocks			04.343.4756.8	10		04.343.4756.8	10
9. Snap-in partition plate		TS 2,5 GELB	07.311.2053.8	10	TS 2,5 GELB	07.311.2053.8	10
For marking systems see pages 178-183		* CL I, ZN1, AExe II pending					

selos



Sensor/actuator blocks 250 V with LED for 24 V

selos

- Compact design for sensor/actuator wiring
- Insulated jumpers eliminate redundant wiring
- The blocks are also available with integrated LED for NPN or PNP sensors
- The use of cross connectors (jumper combs), requires partitions in order to maintain the air and creepage distances.

Indicator: R = 2.2 K; 0.35 W
Lamp color: green: 24 V DC

*) 24 V_{DC} with LED

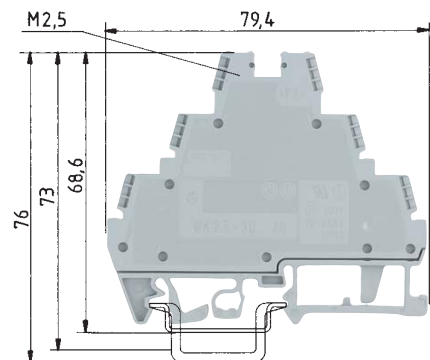
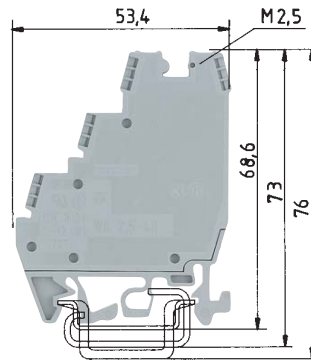

WK 2,5 - 4 KI/U-NGN

WK 2,5 - 4 KI/U-PGN

WK 2,5 - 3 D/U-NGN

WK 2,5 - 3 D/U-PGN

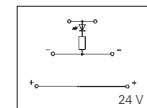
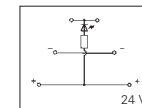
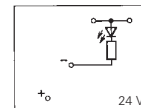
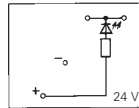

WK 2,5-4 KI/U

fine stranded	solid	V	A
0.5 – 2.5 mm ²	0.5 – 4 mm ²	250 V/4 kV/3*)	24
No. 22-12 AWG		300 V*)	25
No. 22-12 AWG		300 V*)	25
6 mm			7 mm



WK 2,5-3 D/U

fine stranded	solid	V	A
0.5 – 2.5 mm ²	0.5 – 4 mm ²	400 V/6 kV/3*)	24
No. 22-12 AWG		300 V*)	25
No. 22-12 AWG		300 V*)	25
6 mm			7 mm



EN 60 947-7-1/DIN VDE 0611 T1

UL-ratings field/factory wiring

CSA ratings

Width Wire strip length

Approvals

		Type	Part no.	Std. pack	Type	Part no.	Std. pack
Sensor/actuator block	Color: gray	WK 2,5 - 4 KI/U	57.503.7855.0	100			
with LED (green) for NPN	Color: gray	WK 2,5 - 4 KI/U-NGN	57.503.7955.0	100			
with LED (green) for PNP	Color: gray	WK 2,5 - 4 KI/U-PGN	57.503.8055.0	100			
with LED (red) for PNP	Color: gray						
Three-tier feed through block	Color: gray				WK 2,5 - 3 D/U	57.503.8855.0	50
with LED for NPN	Color: gray				WK 2,5 - 3 D/U-NGN	57.503.8955.0	50
with LED for PNP	Color: gray				WK 2,5 - 3 D/U-PGN	57.503.9055.0	50
Accessories							
1. Mounting rail TS 35, DIN rail, 7.5 mm high	L = 2 m	35 x 27 x 7,5 EN 60715	98.300.0000.0	1	35 x 27 x 7,5 EN 60715	98.300.0000.0	1
Mounting rail TS 35, DIN rail 15 mm high	L = 2 m	35 x 24 x 15 EN 60715	98.360.0000.0	1	35 x 24 x 15 EN 60715	98.360.0000.0	1
Mounting rail TS 32, G rail	L = 2 m	9006 EN 60715 G-32	98.190.0000.0	1	9006 EN 60715 G-32	98.190.0000.0	1
2. End clamp with U-foot	10 mm wide	WE 2/U	Z5.523.5653.0	100	WE 2/U	Z5.523.5653.0	100
End clamp TS 35, with screw	8 mm wide	9708/2 S 35	Z5.522.8553.0	100	9708/2 S 35	Z5.522.8553.0	100
End clamp TS 32, with screw	7.5 mm wide	9708	Z5.522.7053.0	100	9708	Z5.522.7053.0	100
3. Partition, 2 mm thick	Color: gray	TW 2,5 - 3 K/U	07.312.0555.0	10	TW 2,5 - 3 D/U	07.312.1255.0	50
4. Cross connector with screws, E-Cu							
insulated (jumpers)	2pole, yellow				IVB WK/3D-02	Z7.270.0227.0	10
	3pole, yellow				IVB WK/3D-03	Z7.270.0327.0	10
	to 12pole, yellow				IVB WK/3D-12	Z7.270.1227.0	10
5. Jumper comb, angled (middle & lower tier)							
insulated	2pole, red	IVB WK 2,5-K-2 ROT	Z7.267.0227.5	10	IVB WK 2,5-K-2 ROT	Z7.267.0227.5	10
	to 12pole, red	IVB WK 2,5-K-12 ROT	Z7.267.1227.5	10	IVB WK 2,5-K-12 ROT	Z7.267.1227.5	10
insulated	2pole blue	IVB WK 2,5-K-2 BLAU	Z7.267.0227.6	10	IVB WK 2,5-K-2 BLAU	Z7.267.0227.6	10
	to 12pole blue	IVB WK 2,5-K-12 BLAU	Z7.267.1227.6	10	IVB WK 2,5-K-12 BLAU	Z7.267.1227.6	10
For more accessories see pages 160-177							
For marking systems see pages 178-179 and 200-202							

Sensor/actuator terminals with top entry system

selos

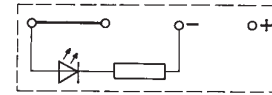
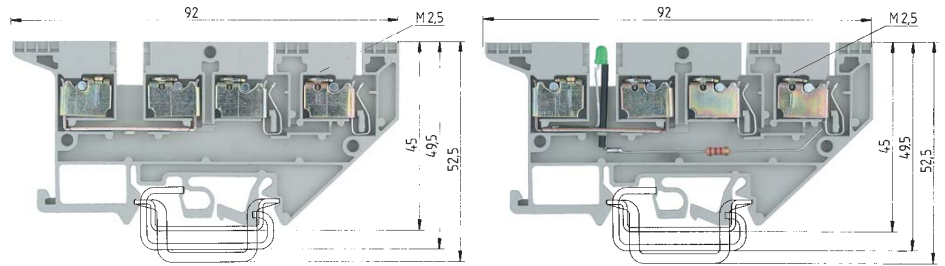

Indicator: R = 2.2 K; 0.35 W
Lamp color: green

WK 2,5-4 KOI/U

fine stranded	solid	V	A
0.5 - 2,5 mm ²	0.5 - 4 mm ²	400 V/6 kV/3	16 ^{*)}
No. 22-12 AWG		300 V	20/30
No. 22-12 AWG		300 V	25
5 mm			10 mm



WK 2,5-4 KOI/U-NGN

fine stranded	solid	V	A
0.5 - 2,5 mm ²	0.5 - 4 mm ²	24 DC	16 ^{*)}
No. 22-12 AWG		24 V	20/30
No. 22-12 AWG		24 V	25
5 mm			10 mm



EN 60 947-7-1/DIN VDE 0611 T1

UL-ratings field/factory wiring

CSA ratings

Width Wire strip length

Approvals

	Type	Part no.	Std. pack	Type	Part no.	Std. pack
Sensor/actuator terminal Color: gray	WK 2,5-4 KOI/U	57.503.7055.0	50			
Sensor/actuator terminal W/ LED (NPN) Color: gray				WK 2,5-4 KOI/U-NGN	57.503.7155.0	50
Accessories						
1. Mounting rail TS 35, DIN rail 7.5mm high L = 2 m	35 x 27 x 7,5 EN 60715	98.300.0000.0	1	35 x 27 x 7,5 EN 60715	98.300.0000.0	1
Mounting rail TS 35, DIN rail 1.5mm high L = 2 m	35 x 24 x 15 EN 60715	98.360.0000.0	1	35 x 24 x 15 EN 60715	98.360.0000.0	1
Mounting rail TS 32, G rail L = 2 m	9006 EN 60715 G-32	98.190.0000.0	1	9006 EN 60715 G-32	98.190.0000.0	1
2. End clamp with U-foot 10 mm wide	WE 1/U	Z5.523.5753.0	100	WE 1/U	Z5.523.5753.0	100
End clamp TS 35, with screw 8 mm wide	9708/2 S 35	Z5.522.8553.0	100	9708/2 S 35	Z5.522.8553.0	100
End clamp TS 32, with screw 7.5 mm wide	9708	Z5.522.7053.0	100	9708	Z5.522.7053.0	100
3. End plate 1.5 mm thick	AP 2,5-4 K0	07.310.9355.0	50	AP 2,5-4 K0	07.310.9355.0	50
4. Partition plate 1.5 mm thick	TW 2,5-4 K0	07.310.9455.0	50	TW 2,5-4 K0	07.310.9455.0	50
5. Cross connector for voltage supply						
uninsulated 2pole	VB WK 2,5 K0-2	07.257.0227.0	100	VB WK 2,5 K0-2	07.257.0227.0	100
3pole	VB WK 2,5 K0-3	07.257.0327.0	100	VB WK 2,5 K0-3	07.257.0327.0	100
to 20pole	VB WK 2,5 K0-20	07.257.2027.0	50	VB WK 2,5 K0-20	07.257.2027.0	50
6. Jumper bar for signal, uninsulated 2pole	VB WK 2,5-2	Z7.280.0227.0	10	VB WK 2,5-2	Z7.280.0227.0	10
3pole	VB WK 2,5-3	Z7.280.0327.0	10	VB WK 2,5-3	Z7.280.0327.0	10
to 6pole	VB WK 2,5-6	Z7.280.0627.0	10	VB WK 2,5-6	Z7.280.0627.0	10
7. Single cover f. cross conn. with marking facility	AD VB 2,5 GELB	04.326.2053.8	10	AD VB 2,5 GELB	04.326.2053.8	10
8. Cover strip with test hole over 10 blocks	AD VB 5/10 P GELB	04.342.3556.8	10	AD VB 5/10 P GELB	04.342.3556.8	10
9. Cover strip for cross connectors over 10 blocks	AD VB 5/10	04.342.0556.0	10	AD VB 5/10	04.342.0556.0	10
10. Partition plate	TS 2,5 GELB	07.311.2053.8	10	TS 2,5 GELB	07.311.2053.8	10
11. Tear-off marking strip, red, marked "+"	9705 A/5/10 B + ROT	04.855.0253.5	25	9705 A/5/10 B + ROT	04.855.0253.5	25
12. Tear-off marking strip, blue, marked "-"	9705 A/5/10 B - BLAU	04.855.0353.6	25	9705 A/5/10 B - BLAU	04.855.0353.6	25
For marking systems see pages 178-179 and 200-202						
*) feed-through 16 A						

selos

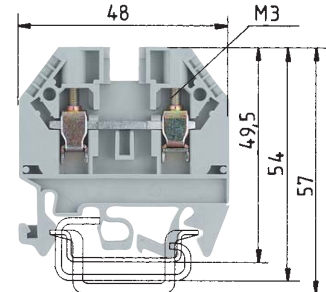
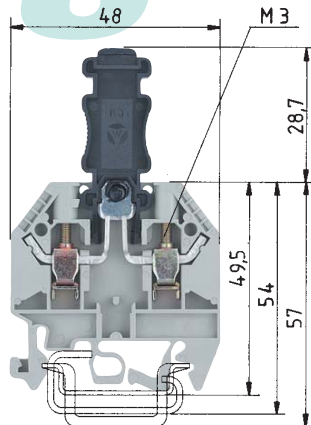
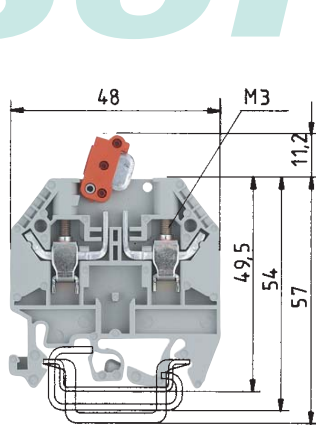

selos

The disconnecting knife in these WK versions swing in and out on a pivot point. The distinctive color of the disconnecting lever signals the open state. The terminals can be connected with the lever open or closed. Designs with a different number and arrangement of test sockets permit safe measurements using the test plug.

The plug in disconnect terminal has the same profile as the modular terminal WK4. The isolating connector is detachable and can be fitted as a dummy plug. This signals the open state. Designs with different numbers of test sockets permit safe measurements using the test plug.

same dimensions as types
WK 4 TKG/U and WK 4/TKM/U
for symmetry across the rail

WK 4/TKM

fine stranded	solid	V	A
0.5 – 4 mm ²	0.5 – 6 mm ²	800 V/8 kV/3*)	20
No. 22-10 AWG		600 V	20
No. 22-10 AWG		600 V*)	20
6 mm			9 mm



WK 4 TKG-TRST/U

fine stranded	solid	V	A
0.5 – 4 mm ²	0.5 – 6 mm ²	800 V/8 kV/3*)	20
No. 22-10 AWG		300 V	10
No. 22-10 AWG		600 V*)	20
6 mm			9 mm



WK 4 TKS D/U

fine stranded	solid	V	A
0.5 – 4 mm ²	0.5 – 6 mm ²	800 V/8 kV/3	32
No. 22-10 AWG		300 V	25
No. 20-10 AWG		600 V	20
6 mm			9 mm



Type	Part no.	Std. pack	Type	Part no.	Std. pack	Type	Part no.	Std. pack
WK 4/TKM/U	57.504.2055.0	100						
WK 4/TKM/U BLAU	57.504.2055.6	100						
WK 4/TKM/P3/U	57.504.2355.0	100						
			WK 4 TKG-TRST/U	57.504.4555.0	100			
			WK 4 TKG-TRST P3/U	57.504.4855.0	100			
						WK 4 TKS D/U	57.504.4455.0	100
35 x 27 x 7,5 EN 60715	98.300.0000.0	1	35 x 27 x 7,5 EN 60715	98.300.0000.0	1	35 x 27 x 7,5 EN 60715	98.300.0000.0	1
35 x 24 x 15 EN 60715	98.360.0000.0	1	35 x 24 x 15 EN 60715	98.360.0000.0	1	35 x 24 x 15 EN 60715	98.360.0000.0	1
9006 EN 60715 G-32	98.190.0000.0	1	9006 EN 60715 G-32	98.190.0000.0	1	9006 EN 60715 G-32	98.190.0000.0	1
WE 2/U	Z5.523.5653.0	100	WE 2/U	Z5.523.5653.0	100	WE 2/U	Z5.523.5653.0	100
9708/2 S 35	Z5.522.8553.0	100	9708/2 S 35	Z5.522.8553.0	100	9708/2 S 35	Z5.522.8553.0	100
9708	Z5.522.7053.0	100	9708	Z5.522.7053.0	100	9708	Z5.522.7053.0	100
AP 4 TK	07.311.6155.0	10	AP 4 TK	07.311.6155.0	10	AP 4 TK	07.311.6155.0	10
AP 4 TK BLAU	07.311.6155.6	10						
TW 4 TK	07.311.8155.0	10	TW 4 TK	07.311.8155.0	10	TW 4 TK	07.311.8155.0	10
TW 4 TK BLAU	07.311.8155.6							
IVB 1 WK 4..-2	Z7.255.4227.0	10	IVB 1 WK 4..-2	Z7.255.4227.0	10	IVB 1 WK 4..-2	Z7.255.4227.0	10
IVB 1 WK 4..-6	Z7.255.4627.0	10	IVB 1 WK 4..-6	Z7.255.4627.0	10	AD VB 4 GELB	04.326.2153.8	10
						TS 4 GELB	07.311.2153.8	10

*) Version with test bolt: CSA: 300 V
EN 60 947-7-1/DIN VDE 0611 T1 – 690 V/6 kV/3
Test bolt can be loaded with 1 A

*) Version with test bolt: CSA: 300 V
EN 60 947-7-1/DIN VDE 0611 T1 – 690 V/6 kV/3
Test bolt can be loaded with 1 A

selos

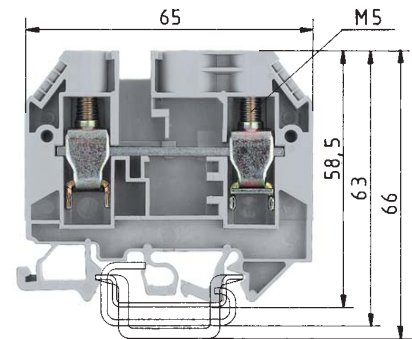
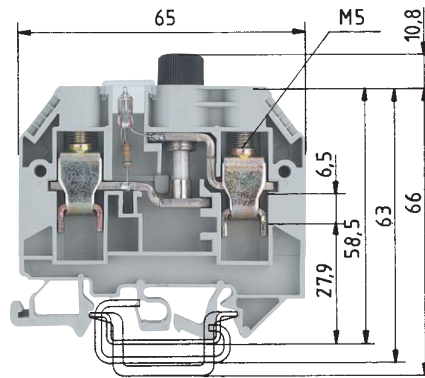
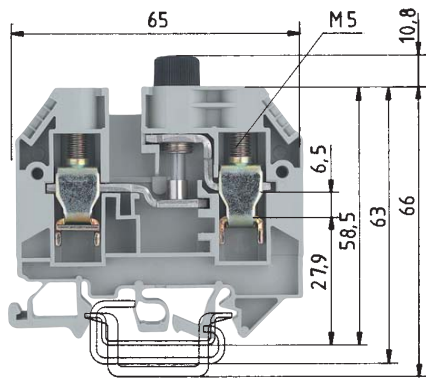

*) Voltage and current are determined by the built-in LED and the inserted G-fuse.
⁹⁾ 6.3 A up to a power loss of 1.6 W
¹⁰⁾ 10 A up to a power loss of 2.5 W

*) Voltage and current are determined by the built-in indicator and the inserted G-fuse.
⁷⁾ 6.3 A up to a power loss of 1.6 W
⁸⁾ 10 A up to a power loss of 2.5 W

WK 10/SI ... /U

fine stranded	solid/stranded	V	A
1 – 10 mm ²	1 – 16 mm ²	500 V/6 kV/3 ^{*)}	10 ^{*)}
No. 22-6 AWG		600 V ^{*)}	15
No. 16-6 AWG		600 V ^{*)}	max. 15
12 mm			13 mm



WK 10/SI ... /U with indicator

fine stranded	solid/stranded	V	A
1 – 10 mm ²	1 – 16 mm ²	500 V/6 kV/3 ^{*)}	max. 10 ^{*)}
No. 22-6 AWG		600 V ^{*)}	15
No. 16-6 AWG		600 V ^{*)}	max. 15
12 mm			13 mm



WK 10/SI U D

fine stranded	solid/stranded	V	A
1 – 10 mm ²	1 – 16 mm ²	500 V/6 kV/3	57
No. 22-6 AWG		600 V	50
No. 16-6 AWG		600 V	65
12 mm			13 mm

Type	Part no.	Std. pack	Type	Part no.	Std. pack	Type	Part no.	Std. pack
WK 10/Si U 5 x 20 ²⁾ -8)9)10)	57.910.5055.0	50	WK 10/Si U 5x20M, NGL ²⁾⁻⁶⁾⁷⁾⁸⁾	57.910.5455.0	50	WK 10/Si U D	57.910.4955.0	50
WK 10/Si U 5 x 25 ²⁾ -8)9)10)	57.910.5155.0	50	WK 10/Si U 5x20M, GLB ²⁾⁻⁶⁾⁷⁾⁸⁾	57.910.5855.0	50			
WK 10/Si U 5 x 30 ²⁾ -8)10)	57.910.5255.0	50	WK 10/Si U 6,3x32M, NGL ¹⁾⁻⁶⁾⁸⁾	57.910.5755.0	50			
WK 10/Si U 6,3 x 32 ¹⁾⁻⁸⁾¹⁰⁾	57.910.5355.0	50	WK 10/Si U 6,3x32M, GLB ¹⁾⁻⁶⁾⁸⁾	57.910.6155.0	50			
35 x 27 x 7,5 EN 60715	98.300.0000.0	1	35 x 27 x 7,5 EN 60715	98.300.0000.0	1	35 x 27 x 7,5 EN 60715	98.300.0000.0	1
35 x 24 x 15 EN 60715	98.360.0000.0	1	35 x 24 x 15 EN 60715	98.360.0000.0	1	35 x 24 x 15 EN 60715	98.360.0000.0	1
9006 EN 60715 G-32	98.190.0000.0	1	9006 EN 60715 G-32	98.190.0000.0	1	9006 EN 60715 G-32	98.190.0000.0	1
WE 1/U	Z5.523.5753.0	100	WE 1/U	Z5.523.5753.0	100	WE 1/U	Z5.523.5753.0	100
9708/2 S 35	Z5.522.8553.0	100	9708/2 S 35	Z5.522.8553.0	100	9708/2 S 35	Z5.522.8553.0	100
9708	Z5.522.7053.0	100	9708	Z5.522.7053.0	100	9708	Z5.522.7053.0	100
AP 10/Si	07.311.4155.0	10	AP 10/Si	07.311.4155.0	10	AP 10/Si	07.311.4155.0	10
VB WK 10/Si-2	Z7.287.0227.0	10	VB WK 10/Si-2	Z7.287.0227.0	10	VB WK 10/Si-2	Z7.287.0227.0	10
VB WK 10/Si-3	Z7.287.0327.0	10	VB WK 10/Si-3	Z7.287.0327.0	10	VB WK 10/Si-3	Z7.287.0327.0	10
VB WK 10/Si-6	Z7.287.0627.0	10	VB WK 10/Si-6	Z7.287.0627.0	10	VB WK 10/Si-6	Z7.287.0627.0	10
	04.312.2056.0	100		04.312.2056.0	100		04.312.2056.0	100
			VDE	CSA	UL			
			57.910.5453.0	Indicator	110 - 250 V ~	500 V	150 V	
				Current consumed:	0.16 – 0.8 mA ⁹⁾			
			57.910.5853.0	Indicator	28 V ~	28 V	28 V	
				Current consumed:	24 mA ¹⁰⁾			
			57.910.5753.0	Indicator	110 - 500 V ~	500 V	150 V	
				Current consumed:	0.16 – 0.8 mA ⁹⁾			
			57.910.6153.0	Indicator	28 V ~	28 V	28 V	
				Current consumed:	24 mA ¹⁰⁾			
Screw cap made from thermoset type 131 and silver-plated brass			Lamp color of the indicator: ⁹⁾ red, ¹⁰⁾ yellow					

selos



Fuse block for NEOZED® mounting on TS 35 and TS 32 rail

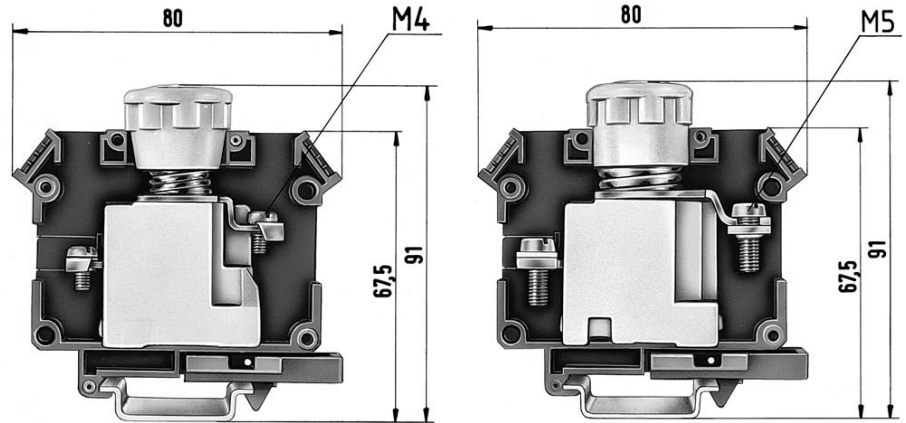

*) Current and voltage are determined by the fuse

DIN VDE 0636
UL-ratings
CSA ratings
Width
Approvals

Wire strip length

9700 B/30 Si E 14/S 35

fine stranded 1.5 – 4 mm² solid 1.5 – 4 mm²

2–16 A

V A
400 V ~*) 16*)

9700 B/30 Si E 18/S 35

fine stranded 1.5 – 25 mm² solid/stranded 1.5 – 25 mm²

2–63 A

V A
400 V ~*) 63*)

30 mm

10 mm

30 mm

12 mm

Fuse block		Type	Part no.	Std. pack	Type	Part no.	Std. pack
complete with closed insulating housing	Color: gray	9700 B/30 Si E 14/S 35	56.904.4055.0	20	9700 B/30 Si E 18/S 35	56.925.4055.0	20
Accessories							
1. Mounting rail TS 35, DIN rail, 7.5 mm high	L = 2 m	35 x 27 x 7,5 EN 60715	98.300.0000.0	1	35 x 27 x 7,5 EN 60715	98.300.0000.0	1
Mounting rail TS 35, DIN rail 1.5mm high	L = 2 m	35 x 24 x 15 EN 60715	98.360.0000.0	1	35 x 24 x 15 EN 60715	98.360.0000.0	1
Mounting rail TS 32, G rail							
2. End clamp with U-foot	10 mm wide	WE 1/U	Z5.523.5753.0	100	WE 1/U	Z5.523.5753.0	100
End clamp TS 35, with screw	8 mm wide	9708/2 S 35	Z5.522.8553.0	100	9708/2 S 35	Z5.522.8553.0	100
End clamp TS 32, with screw	7.5 mm wide						
3. NEOZED® adapter sleeve	2 A – pink		05.595.9200.0	50		05.595.5900.0	50
	4 A – brown		05.595.9300.0	50		05.595.6000.0	50
	6 A – green		05.595.9400.0	50		05.595.6100.0	50
	10 A – red		05.595.9500.0	50		05.595.6200.0	50
	16 A – gray					05.595.6300.0	50
	20 A – blue					05.595.6400.0	50
	25 A – yellow					05.595.6500.0	50
	35 A – black					05.595.6600.0	50
	50 A – white					05.595.6700.0	50
4. Cover cap			04.326.1053.0	100		04.326.1053.0	100
5. Jumper comb							
	6pole					07.250.3027.0	25
	uninsulated10pole					07.250.3127.0	10
6. Special retaining clip						05.549.0500.0	
For marking systems see pages 178-179 and 200-202							
NEOZED® = registered trademark of Siemens AG							

selos

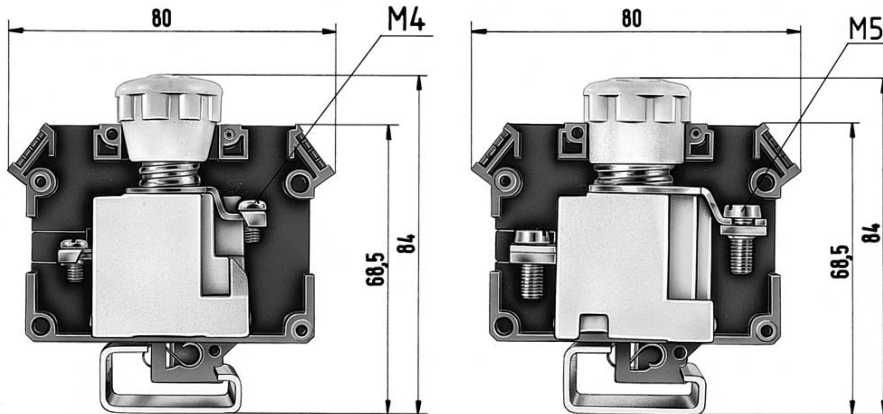

9700 B/30 Si E 14/S 32	2-16 A	9700 B/30 Si E 18/S 32	2-63 A
fine stranded	solid	V	A
1.5-4 mm ²	1.5-4 mm ²	400 V ~*)	16*)

30 mm	10 mm	30 mm	12 mm

Type	Part no.	Std. pack	Type	Part no.	Std. pack
9700 B/30 Si E 14/S 35	54.904.4055.0	20	9700 B/30 Si E 18/S 32	54.925.4055.0	20
9006 EN 60715 G-32	98.190.0000.0	1	9006 EN 60715 G-32	98.360.0000.0	1
WE 1/U	Z5.523.5753.0	100	WE 1/U	Z5.523.5753.0	100
9780	Z5.522.7053.0	100	9780	Z5.522.7053.0	100
	05.595.9200.0	50		05.595.5900.0	50
	05.595.9300.0	50		05.595.6000.0	50
	05.595.9400.0	50		05.595.6100.0	50
	05.595.9500.0	50		05.595.6200.0	50
				05.595.6300.0	50
				05.595.6400.0	50
				05.595.6500.0	50
				05.595.6600.0	50
				05.595.6700.0	50
	04.326.1053.0	100		04.326.1053.0	100
				07.250.3027.0	25
				07.250.3127.0	10
				05.549.0500.0	

Compensating terminals with trimming potentiometer and as a potential divider / U-foot

selos

The compensating terminal is available from 10 to 50 Ohms. The 12 mm width has two clamping points for connecting the adjustable resistance and two clamping points for connecting the return conductor. A marking facility is provided for each clamping point. Switch symbols on the insulating housing identify the connections and the direction of rotation for the adjustable resistance. The device operates with a linear characteristic. The fine spread of the main spindle enables the desired resistance value to be set accurately. Insulating housing with snap on end section.

Electrical specifications for the compensating terminal.

Resistor range: 0.25 Ω to 100 Ω
 Resistor tolerance: ± 10%
 Resistor range: 100 Ω to 50 kΩ
 Resistor tolerance: ± 20%
 Limited continuous resistance value:
 0.75 W to 70 °C
 Max. load: 100 mA
 Temperature coefficient: 0 to +500 ppm/°C
 Max. operating voltage: 300 V

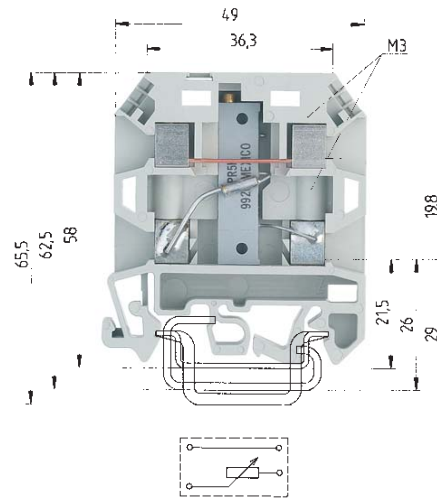

9785 U/...

fine stranded solid V A
 0.5 – 2.5 mm² 0.5 – 2.5 mm² see the description

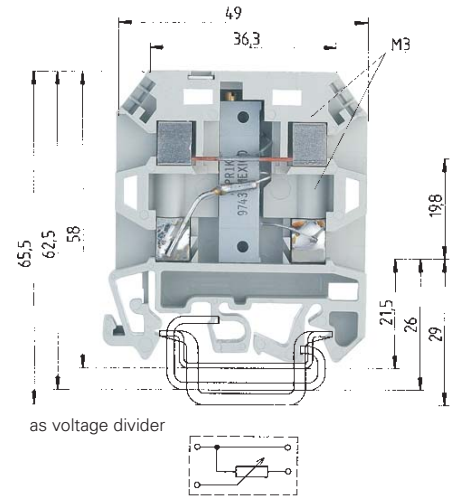

as voltage divider

9785 U/... - SPT

fine stranded solid V A
 0.5 – 2.5 mm² 0.5 – 2.5 mm² see the description

EN 60 947-7-1/DIN VDE 0611 T1

UL ratings

CSA ratings

Width

Wire strip length

12 mm

9 mm

12 mm

9 mm

Approvals

Compensating terminal		Type	Part no.	Std. pack	Type	Part no.	Std. pack
Color: gray	10 Ω	9785 U/10 Ω	57.904.0055.0	50	9785 U/10 Ω-SPT	57.904.3955.0	50
with potentiometer	20 Ω	9785 U/20 Ω	57.904.0155.0	50	9785 U/20 Ω-SPT	57.904.4155.0	50
	50 Ω	9785 U/50 Ω	57.904.0255.0	50	9785 U/50 Ω-SPT	57.904.4255.0	50
	100 Ω	9785 U/100 Ω	57.904.0355.0	50	9785 U/100 Ω-SPT	57.904.4355.0	50
	200 Ω	9785 U/200 Ω	57.904.0455.0	50	9785 U/200 Ω-SPT	57.904.4455.0	50
	510 Ω	9785 U/500 Ω	57.904.0555.0	50	9785 U/500 Ω-SPT	57.904.4555.0	50
	1 kΩ	9785 U/1 kΩ	57.904.0655.0	50	9785 U/1 kΩ-SPT	57.904.4655.0	50
	2 kΩ	9785 U/2 kΩ	57.904.0755.0	50	9785 U/2 kΩ-SPT	57.904.4755.0	50
	5 kΩ	9785 U/5 kΩ	57.904.0855.0	50	9785 U/5 kΩ-SPT	57.904.4855.0	50
	10 kΩ	9785 U/10 kΩ	57.904.0955.0	50	9785 U/10 kΩ-SPT	57.904.4955.0	50
	20 kΩ	9785 U/20 kΩ	57.904.1055.0	50	9785 U/20 kΩ-SPT	57.904.5055.0	50
	50 kΩ	9785 U/50 kΩ	57.904.1155.0	50	9785 U/50 kΩ-SPT	57.904.5155.0	50
Diode terminal							
Accessories							
1. Mounting rail TS 35, DIN rail 7.5mm high	L = 2 m	35 x 27 x 7,5 EN 60715	98.300.0000.0	1	35 x 27 x 7,5 EN 60715	98.300.0000.0	1
Mounting rail TS 35, DIN rail 1.5mm high	L = 2 m	35 x 24 x 15 EN 60715	98.360.0000.0	1	35 x 24 x 15 EN 60715	98.360.0000.0	1
Mounting rail TS 32	G rail	9006 EN 60715 G-32	98.190.0000.0	1	9006 EN 60715 G-32	98.190.0000.0	1
2. End clamp with U-foot	10 mm wide	WE 1/U	Z5.523.5753.0	100	WE 1/U	Z5.523.5753.0	100
End clamp TS 35, with screw	8 mm wide	9708/2 S 35	Z5.522.8553.0	100	9708/2 S 35	Z5.522.8553.0	100
End clamp TS 32, with screw	7.5 mm wide	9708	Z5.522.7053.0	100	9708	Z5.522.7053.0	100
3. Jumper comb							
uninsulated	2pole	VB 9786-2	07.253.0227.0	50	VB 9786-2	07.253.0227.0	50
	3pole	VB 9786-3	07.253.0327.0	50	VB 9786-3	07.253.0327.0	50
	to 6pole	VB 9786-6	07.253.0627.0	50	VB 9786-6	07.253.0627.0	50
For more accessories see pages 160-177							
For marking systems see pages 178-179 and 200-202							

selos

Field of application:

In thermocouple measurement circuits, thermocouples are extended using compensating lines. Compensating lines are made of materials which have the same thermal emf values as the thermocouples up to 200 °C. In the thermocouple terminals, the combined metals are made up of the same materials as the compensating lines in accordance with DIN 43713 and DIN 43714 in order to ensure that no corrupting thermal electromotive forces are produced and the basic values in accordance with DIN IED 584 are maintained at the compensating line.

The thermocouple terminal consists of an insulating housing and a snap-in end section.

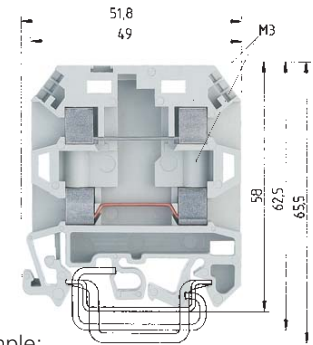

Example:

Fe/constantan

Fe/CuNi 44



fully enclosed design

*) to the adjacent terminal block type 9786 U/...

9786 U/TSK...

fine stranded solid V A
0.5 - 2,5 mm² 0.5 - 2.5 mm² 800 V/8 kV/3*)

EN 60 947-7-1/DIN VDE 0611 T1

UL-ratings

CSA ratings

Width

Wire strip length

12 mm

9 mm

Approvals

	Type	Part no.	Std. pack
Thermocouple terminal Typ T-Cu/CuNi 44	9786 U/TSK Cu-CuNi	57.904.7355.0	50
Thermocouple terminal Typ E-NiCr/CuNi 44	9786 U/TSK NiCr-CuNi	57.904.7055.0	50
Thermocouple terminal Typ J-Fe/CuNi 44	9786 U/TSK Fe-CuNi	57.904.7155.0	50
Thermocouple terminal Typ K-NiCr/Ni	9786 U/TSK NiCr-Ni	57.904.7255.0	50
Thermocouple terminal Typ R-PtRh 13/Pt	9786 U/TSK E-Cu-A-Cu	57.904.7455.0	50
Earth disconnect 24 - 48 V \approx with LED Typ S-PtRh 10/Pt			
Earth disconnect 110 - 220 V \approx with indicator lamp			
Accessories			
1. Mounting rail TS 35, DIN rail 7.5 mm high L = 2 m	35 x 27 x 7,5 EN 60715	98.300.0000.0	1
Mounting rail TS 35, DIN rail 1.5mm high L = 2 m	35 x 24 x 15 EN 60715	98.360.0000.0	1
Mounting rail TS 32, G rail L = 2 m	9006 EN 60715 G-32	98.190.0000.0	1
2. End clamp with U-foot 10 mm wide	WE 1/U	Z5.523.5753.0	100
End clamp TS 35, with screw 8 mm wide	9708/2 S 35	Z5.522.8553.0	100
End clamp TS 32, with screw 7.5 mm wide	9708	Z5.522.7053.0	100
For more accessories see pages 160-177			
For marking systems see pages 178-179 and 200-202			

Modular terminal block with socket for PCB pluggable connector

selos PLUG

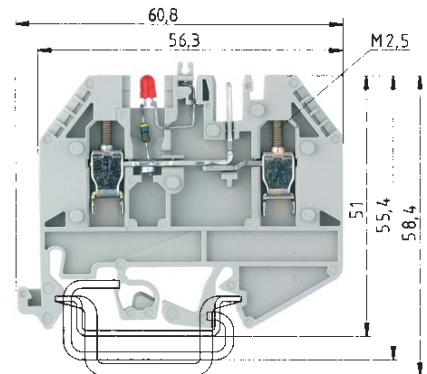
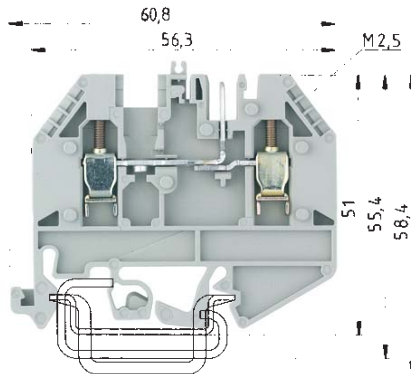

for PC board terminal type:

Type 8113 B
Type 8313 B
Type 8113 B/VL
Type 8113 B/VR
Type 8113 B/Top

Indicator: R = 4.7 K; 0.5 W
Lamp color: red

¹⁾ voltage rating determined by lamp / LED

WK 2,5 U/D/8113 S/V

	fine stranded	solid	V	A
	0.5 – 2.5 mm ²	0.5 – 4 mm ²	250 V/4 kV/3	12
No. 22-12 AWG			300 V ¹⁾	15
No. 24-12 AWG			300 V ¹⁾	15
Width	5 mm		9 mm	



WK 2,5 U/D/8113 S/V/LED 25

	fine stranded	solid	V	A
	0.5 – 2.5 mm ²	0.5 – 4 mm ²	¹⁾	12
No. 22-12 AWG			300 V ¹⁾	15
No. 24-12 AWG			25 V due to LED/300 V ¹⁾	15
Width	5 mm		9 mm	



EN 60 947-7-1/DIN VDE 0611 T1

UL-ratings field/factory wiring

CSA ratings

Width Wire strip length

Approvals

	Type	Part no.	Std. pack	Type	Part no.	Std. pack
Pluggable terminal	Color: gray	WK 2,5 U/D/8113 S/V...	57.503.2155.0	50		
Pluggable terminal with LED 25 V¹⁾	Color: gray				WK 2,5 U/D/8113 S/V/LED 25	57.503.2255.0 50
Pluggable terminal with LED 50 V¹⁾	Color: gray					
Supply terminal	Color: blue					
PCB Pluggable connector type 8113 (in <i>wiecon</i> section)						
Accessories						
1. Mounting rail TS 35, DIN rail, 7.5 mm high L = 2 m	35 x 27 x 7,5 EN 60715	98.300.0000.0	1	35 x 27 x 7,5 EN 60715	98.300.0000.0	1
Mounting rail TS 35, DIN rail 15mm high L = 2 m	35 x 24 x 15 EN 60715	98.360.0000.0	1	35 x 24 x 15 EN 60715	98.360.0000.0	1
Mounting rail TS 35, G rail L = 2 m	9006 EN 60715 G-32	98.190.0000.0	1	9006 EN 60715 G-32	98.190.0000.0	1
2. End clamp with U-foot 10 mm wide	2/U	Z5.523.5653.0	100	WE 2/U	Z5.523.5653.0	100
End clamp TS 35 with screw 8 mm wide	9708/2 S 35	Z5.522.8553.0	100	9708/2 S 35	Z5.522.8553.0	100
End clamp TS 32 with screw 7.5 mm wide	9708	Z5.522.7053.0	100	9708	Z5.522.7053.0	100
3. End plate 2.5 mm thick Color: gray	AP 2,5 U/D/8113 S/V	07.311.9055.0	10	AP 2,5 U/D/8113 S/V	07.311.9055.0	10
End plate 2.5 mm thick Color: blue						
4. Spacer 2.5 mm thick Color: gray	ZP 2,5 U/D/8113 S/V	07.311.9155.0	10	ZP 2,5 U/D/8113 S/V	07.311.9155.0	10
Spacer 2.5 mm thick Color: blue						
use for 7.5 mm pitch pluggable connectors						
5. Cross connector with screws, 2pole	IVB WK 2,5-2	Z7.280.2227.0	10	IVB WK 2,5-2	Z7.280.2227.0	10
E-Cu, insulated 3pole	IVB WK 2,5-3	Z7.280.2327.0	10	IVB WK 2,5-3	Z7.280.2327.0	10
12pole	IVB WK 2,5-12	Z7.280.3227.0	10	IVB WK 2,5-12	Z7.280.3227.0	10
6. LED bus bar, tin-plated brass L = 0.4 m					05.561.4125.0	1
7. Cover strip for LED (transparent)	AD VB 5/10 P	04.342.3556.8	10	AD VB 5/10 P	04.342.3556.8	10
8. Single cover f. cross conn. with mark.facility	AD VB 2,5 GELB	04.326.2053.8	10	AD VB 2,5 GELB	04.326.2053.8	10
9. Cover stripfor PCB terminal 24pole		04.343.9056.8	10		04.343.9056.8	10
with warning symbol 24pole		04.343.9156.8	10		04.343.9156.8	10
10. Snap-in partition	TS 2,5 GELB	07.311.2053.8	10	TS 2,5 GELB	07.311.2053.8	10
11. Coding strip		05.561.0053.0	100		05.561.0053.0	100
12. Locking piece 10pole						
For marking systems see pages 178-179 and 200-202						

selos

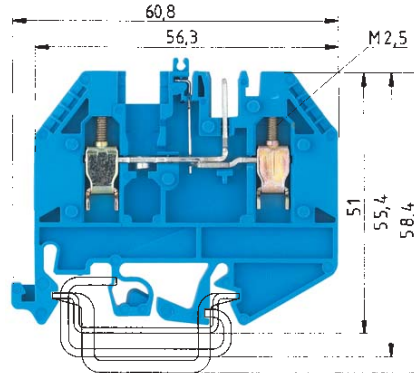
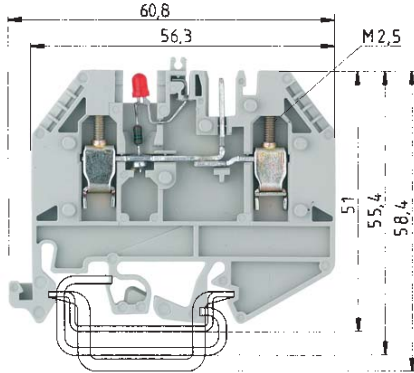

Indicator: R = 10 K; 0.5 W
Lamp color: red

¹⁾ voltage rating determined by lamp / LED

WK 2,5 U/D/8113 S/V/LED 50

fine stranded solid	V	A
0.5 – 2.5 mm ² 0.5 – 4 mm ²	¹⁾	12
No. 22-12 AWG	300 V ¹⁾	15
No. 24-12 AWG	50 V due to LED/300 V ¹⁾	15
5 mm		9 mm



WK 2,5 U/D/8113 S/V/VK

fine stranded solid	V	A
0.5 – 2.5 mm ² 0.5 – 4 mm ²	250 V/4 kV/3	12
No. 22-12 AWG	300 V	15
No. 24-12 AWG	300 V	15
5 mm		9 mm



Type	Part no.	Std. pack	Type	Part no.	Std. pack
WK 2,5 U/D/8113 S/V/LED 50	57.503.2355.0	50	WK 2,5 U/D/8113 S/V/VK	57.503.2555.6	50
35 x 27 x 7,5 EN 60715	98.300.0000.0	1	35 x 27 x 7,5 EN 60715	98.300.0000.0	1
35 x 24 x 15 EN 60715	98.360.0000.0	1	35 x 24 x 15 EN 60715	98.360.0000.0	1
9006 EN 60715 G-32	98.190.0000.0	1	9006 EN 60715 G-32	98.190.0000.0	1
WE 2/U	Z5.523.5653.0	100	WE 2/U	Z5.523.5653.0	100
9708/2 S 35	Z5.522.8553.0	100	9708/2 S 35	Z5.522.8553.0	100
9708	Z5.522.7053.0	100	9708	Z5.522.7053.0	100
AP 2,5 U/D/8113 S/V	07.311.9055.0	10	AP 2,5 U/D/8113 S/V	07.311.9055.0	10
ZP 2,5 U/D/8113 S/V	07.311.9155.0	10	ZP 2,5 U/D/8113 S/V	07.311.9155.0	10
IVB WK 2,5-2	Z7.280.2227.0	10	IVB WK 2,5-2	Z7.280.2227.0	10
IVB WK 2,5-3	Z7.280.2327.0	10	IVB WK 2,5-3	Z7.280.2327.0	10
IVB WK 2,5-12	Z7.280.3227.0	10	IVB WK 2,5-12	Z7.280.3227.0	10
	05.561.4125.0	1		05.561.4125.0	1
AD VB 5/10 P	04.342.3556.8	10	AD VB 5/10 P	04.342.3556.8	10
AD VB 2,5 GELB	04.326.2053.8	10	AD VB 2,5 GELB	04.326.2053.8	10
	04.343.9056.8	10		04.343.9056.8	10
	04.343.9156.8	10		04.343.9156.8	10
TS 2,5 GELB	07.311.2053.8	10	TS 2,5 GELB	07.311.2053.8	10
	05.561.0053.0	100		05.561.0053.0	100

Modular terminal block with socket for PCB pluggable connector

selos PLUG

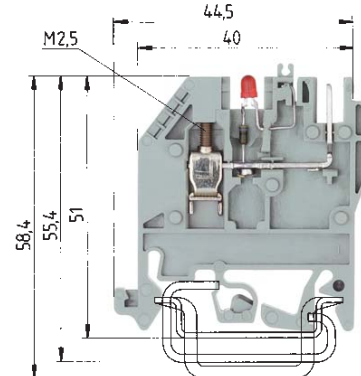
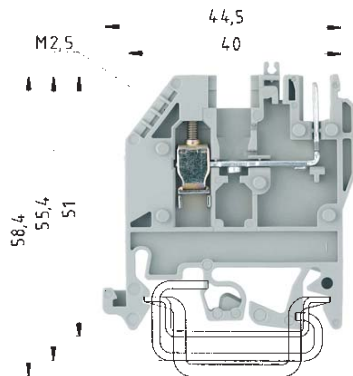

for PCB terminal types:

- Type 8113 B
- Type 8313 B
- Type 8113 B/VL
- Type 8113 B/VR
- Type 8113 B/Top

Indicator: R = 4.7 K; 0.5 W
Lamp color: red

¹⁾ voltage rating determined by lamp / LED

WK 2,5 U/8113 S/V

fine stranded	solid	V	A
0.5 – 2.5 mm ²	0.5 – 4 mm ²	250 V/4 kV/3	12
No. 22-12 AWG		300 V	15
No. 24-12 AWG		300 V	15
Width	Wire strip length	5 mm	9 mm



WK 2,5 U/8113 S/V/LED 25

fine stranded	solid	V	A
0.5 – 2.5 mm ²	0.5 – 4 mm ²	25 V ¹⁾	12
No. 22-12 AWG		300 V ¹⁾	15
No. 24-12 AWG		25 V due to LED/300 V ¹⁾	15
Width	Wire strip length	5 mm	9 mm



DIN VDE 0110
UL-ratings
CSA ratings
Width
Approvals

field/factory wiring
Wire strip length

	Type	Part no.	Std. pack	Type	Part no.	Std. pack
Pluggable terminal Color: gray	WK 2,5 U/8113 S/V...	57.503.2655.0	50			
Pluggable terminal with LED 25 V ¹⁾ Color: gray				WK 2,5 U/8113 S/V/LED 25	57.503.2755.0	50
Pluggable terminal with LED 50 V ¹⁾ Color: gray						
Supply terminal Color: blue						
Pluggable terminal with pluggable connection for PCB						
PCB Pluggable connector type 8113 (in wiecon section)						
Accessories						
1. Mounting rail TS 35, DIN rail, 7.5 mm high L = 2 m	35 x 27 x 7,5 EN 60715	98.300.0000.0	1	35 x 27 x 7,5 EN 60715	98.300.0000.0	1
Mounting rail TS 35, DIN rail 15mm high L = 2 m	35 x 24 x 15 EN 60715	98.360.0000.0	1	35 x 24 x 15 EN 60715	98.360.0000.0	1
Mounting rail TS 35, G rail L = 2 m	9006 EN 60715 G-32	98.190.0000.0	1	9006 EN 60715 G-32	98.190.0000.0	1
2. End clamp with U-foot 10 mm wide	2/U	Z5.523.5653.0	100	WE 2/U	Z5.523.5653.0	100
End clamp TS 35 with screw 8 mm wide	9708/2 S 35	Z5.522.8553.0	100	9708/2 S 35	Z5.522.8553.0	100
End clamp TS 32 with screw 7.5 mm wide	9708	Z5.522.7053.0	100	9708	Z5.522.7053.0	100
3. End plate for right side, 2.5 mm thick Color: gray	AP 2,5 U/8113 S/V	07.312.1555.0	10	AP 2,5 U/8113 S/V	07.312.1555.0	10
End plate for left side, 2.5 mm thick Color: gray	AP 2,5 U/8113	07.312.4655.0	10	AP 2,5 U/8113	07.312.4655.0	10
End plate 2.5 mm thick Color: blue						
4. Spacer, right side, 2.5 mm thick Color: gray	ZP 2,5 U/8113 S/V	07.312.1655.0	10	ZP 2,5 U/8113 S/V	07.312.1655.0	10
Spacer 2.5 mm thick Color: blue						
use for 7.5 mm pitch pluggable connectors						
5. Cross connector with screws, 2pole	IVB WK 2,5-2	Z7.280.2227.0	10			
E-Cu, insulated 3pole	IVB WK 2,5-3	Z7.280.2327.0	10			
12pole	IVB WK 2,5-12	Z7.280.3227.0	10			
6. LED bus bar, tin-plated brass L = 0.4 m					05.561.4125.0	1
7. Cover strip for LED (transparent)						
8. Single cover f. cross conn. with marking facility	AD VB 2,5 GELB	04.326.2053.8	10	AD VB 2,5 GELB	04.326.2053.8	10
9. Cover strip for PCB terminal 24pole		04.343.9056.8	10		04.343.9056.8	10
with warning symbol 24pole		04.343.9156.8	10		04.343.9156.8	10
10. Snap-in partition plate	TS 2,5 GELB	07.311.2053.8	10	TS 2,5 GELB	07.311.2053.8	10
11. Coding strip		05.561.0053.0	100		05.561.0053.0	100
12. Locking piece 10pole						
For marking systems see pages 178-179 and 200-202						

selos

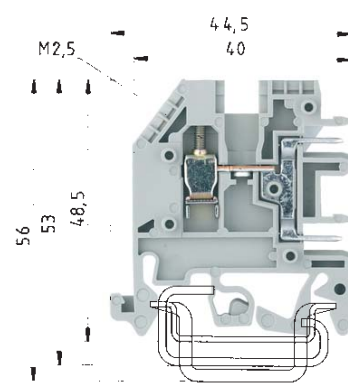
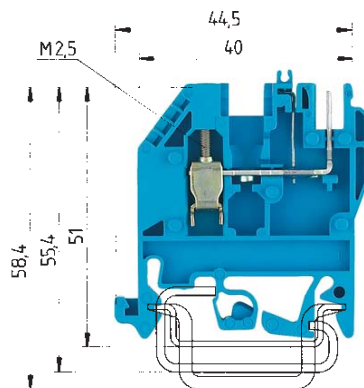
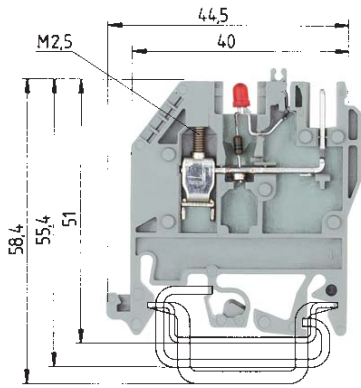

Indicator: R = 10 K; 0.5 W
Lamp color: red

¹⁾ voltage rating determined by lamp / LED

WK 2,5 U/8113 S/V/LED 50

fine stranded solid	V	A
0.5 – 2.5 mm ² 0.5 – 4 mm ²	12	
No. 22-12 AWG	300 V ¹⁾	15
No. 24-12 AWG	50 V due to LED/300 V ¹⁾	15
5 mm		9 mm



WK 2,5 U/8113 S/V/VK

fine stranded solid	V	A
0.5 – 2.5 mm ² 0.5 – 4 mm ²	250 V/4 kV/3	12
No. 22-12 AWG	300 V	15
No. 24-12 AWG	300 V	15
5 mm		9 mm



WK 2,5 U/D/8113 S/V/VK

fine stranded solid	V	A
0.5 – 2.5 mm ² 0.5 – 4 mm ²	250 V/4 kV/3	12
No. 22-12 AWG	300 V	20
No. 24-12 AWG	300 V	15
5 mm		9 mm



Type	Part no.	Std. pack	Type	Part no.	Std. pack	Type	Part no.	Std. pack
WK 2,5 U/8113 S/V/LED 50	57.503.2855.0	50	WK 2,5 U/8113 S/V/VK	57.503.3055.6	50	WK 2,5 U/8113 S/H	57.503.2055.0	100
35 x 27 x 7,5 EN 60715	98.300.0000.0	1	35 x 27 x 7,5 EN 60715	98.300.0000.0	1	35 x 27 x 7,5 EN 60715	98.300.0000.0	1
35 x 24 x 15 EN 60715	98.360.0000.0	1	35 x 24 x 15 EN 60715	98.360.0000.0	1	35 x 24 x 15 EN 60715	98.360.0000.0	1
9006 EN 60715 G-32	98.190.0000.0	1	9006 EN 60715 G-32	98.190.0000.0	1	9006 EN 60715 G-32	98.190.0000.0	1
WE 2/U	Z5.523.5653.0	100	WE 2/U	Z5.523.5653.0	100	WE 2/U	Z5.523.5653.0	100
9708/2 S 35	Z5.522.8553.0	100	9708/2 S 35	Z5.522.8553.0	100	9708/2 S 35	Z5.522.8553.0	100
9708	Z5.522.7053.0	100	9708	Z5.522.7053.0	100	9708	Z5.522.7053.0	100
AP 2,5 U/8113 S/V	07.312.1555.0	10	AP 2,5 U/8113	07.312.4655.0	10	AP 2,5 U/8113 S/H***)	07.311.9853.0	
AP 2,5 U/8113	07.312.4655.0	10	AP 2,5 U/8113 S/V BL	07.312.1555.6	10			
ZP 2,5 U/8113 S/V	07.312.1655.0	10	ZP 2,5 U/8113 S/V	07.312.1655.0	10			
			ZP 2,5 U/8113 S/V BL	07.312.1655.6	10			
			IVB WK 2,5-2	Z7.280.2227.0	10	IVB WK 2,5-2	Z7.280.2227.0	10
			IVB WK 2,5-3	Z7.280.2327.0	10	IVB WK 2,5-3	Z7.280.2327.0	10
			IVB WK 2,5-12	Z7.280.3227.0	10	IVB WK 2,5-12	Z7.280.3227.0	10
	05.561.4125.0	1						
AD VB 2,5 GELB	04.326.2053.8	10	AD VB 2,5 GELB	04.326.2053.8	10	AD VB 2,5 GELB	04.326.2053.8	10
	04.343.9056.8	10		04.343.9056.8	10			
	04.343.9156.8	10		04.343.9156.8	10			
TS 2,5 GELB	07.311.2053.8	10	TS 2,5 GELB	07.311.2053.8	10	TS 2,5 GELB	07.311.2053.8	10
	05.561.0053.0	100		05.561.0053.0	100		05.584.0053.0	100
							05.576.5853.0	25

selos

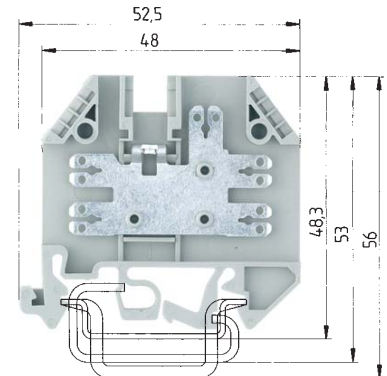
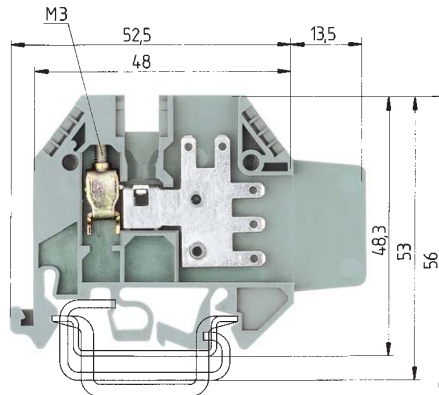
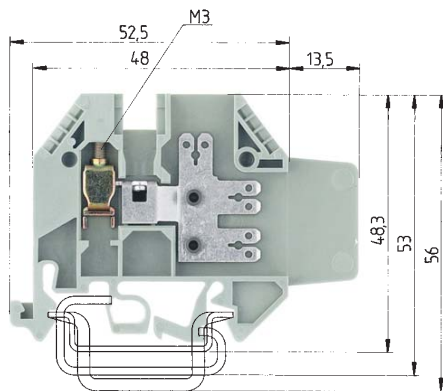

Push-on connectors 2.8 x 0.8 accord. to DIN 46247
Push-on connectors 6.3 x 0.8 accord. to DIN 46247

Push-on connectors 2.8 x 0.8 accord. to DIN 46247

Push-on connectors 2.8 x 0.8 accord. to DIN 46247
Push-on connectors 6.3 x 0.8 accord. to DIN 46247

WK 4-3-6 S 1 K/IW/U

fine stranded	solid	V	A
0.5 – 4 mm ²	0.5 – 6 mm ²	800 V/8 kV/3	20 ^{*)}
No. 22-12 AWG		600 V	10
No. 22-12 AWG		300 V	10
6 mm			9 mm



WK 4-5 S 2,8 1 K/IW/U

fine stranded	solid	V	A
0.5 – 4 mm ²	0.5 – 6 mm ²	800 V/8 kV/3	20 ^{*)}
No. 22-12 AWG		600 V	10
No. 22-12 AWG		300 V	10
6 mm			9 mm



WK/5-10 S/U

fine stranded	solid	V	A
		800 V/8 kV/3	20 ^{*)}
No. 22-12 AWG		300 V	10
6 mm		300 V	10



Type	Part no.	Std. pack	Type	Part no.	Std. pack	Type	Part no.	Std. pack
WK 4-3-6 S 1 K/IW/U	57.504.2755.0	100	WK 4-5 S 2,8 1 K/IW/U	57.504.2855.0	100	WK/5-10 S/U	57.504.3655.0	100
35 x 27 x 7,5 EN 60715	98.300.0000.0	1	35 x 27 x 7,5 EN 60715	98.300.0000.0	1	35 x 27 x 7,5 EN 60715	98.300.0000.0	1
35 x 24 x 15 EN 60715	98.360.0000.0	1	35 x 24 x 15 EN 60715	98.360.0000.0	1	35 x 24 x 15 EN 60715	98.360.0000.0	1
9006 EN 60715 G-32	98.190.0000.0	1	9006 EN 60715 G-32	98.190.0000.0	1	9006 EN 60715 G-32	98.190.0000.0	1
WE 2/U	Z5.523.5653.0	100	WE 2/U	Z5.523.5653.0	100	WE 2/U	Z5.523.5653.0	100
9708/2 S 35	Z5.522.8553.0	100	9708/2 S 35	Z5.522.8553.0	100	9708/2 S 35	Z5.522.8553.0	100
9708	Z5.522.7053.0	100	9708	Z5.522.7053.0	100	9708	Z5.522.7053.0	100
AP4 3 S 1 K	07.311.3855.0	10	AP4 3 S 1 K	07.311.3855.0	10	AP 5 S	07.311.4655.0	10
	05.592.7553.0	2000		05.592.7553.0	2000		05.592.7553.0	2000
	05.592.7653.0	2000		05.592.7653.0	2000		05.592.7653.0	2000
IVB WK 4-2	Z7.281.1227.0	10	IVB WK 4-2	Z7.281.1227.0	10	IVB WKI 4-2	Z7.271.4227.0	10
IVB WK 4-3	Z7.281.1327.0	10	IVB WK 4-3	Z7.281.1327.0	10	IVB WKI 4-3	Z7.271.4327.0	10
IVB WK 4-12	Z7.281.2227.0	10	IVB WK 4-12	Z7.281.2227.0	10	IVB WKI 4-12	Z7.271.5227.0	10
AD VB 4 GELB	04.326.2153.8	10	AD VB 4 GELB	04.326.2153.8	10	AD VB 4 GELB	04.326.2153.8	10
AD VB 6/10 GELB	04.342.0656.8	10	AD VB 6/10 GELB	04.342.0656.8	10	AD VB 6/10 GELB	04.342.0656.8	10
TS 4 GELB	07.311.2153.8	10	TS 4 GELB	07.311.2153.8	10	TS 4 GELB	07.311.2153.8	10

selos

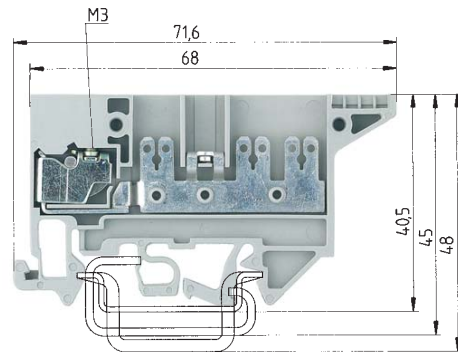
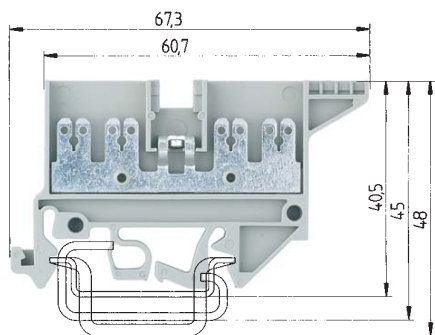
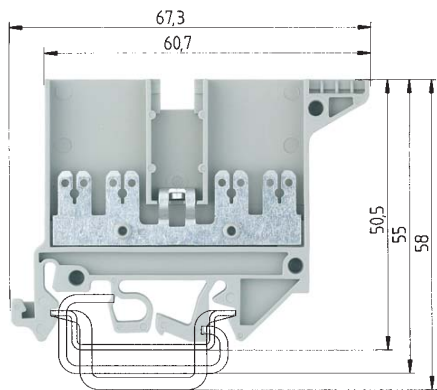

Push-on connectors 2.8 x 0.8 accord. to DIN 46247
Push-on connectors 6.3 x 0.8 accord. to DIN 46247

Push-on connectors 2.8 x 0.8 accord. to DIN 46247
Push-on connectors 6.3 x 0.8 accord. to DIN 46247

Push-on connectors 2.8 x 0.8 accord. to DIN 46247
Push-on connectors 6.3 x 0.8 accord. to DIN 46247

WK/4-8 S/IW/U

fine stranded solid	V	A
	800 V/8 kV/3	20
	600 V	10
No. 22-12 AWG	300 V	10
6 mm		



WK/4-8 S/U

fine stranded solid	V	A
	800 V/8 kV/3	20
	300 V	10
No. 22-12 AWG		
6 mm		



WK/3-6 S KO/U

fine stranded solid	V	A
0.5 – 4 mm ²	690 V/8 kV/3	20
No. 22-12 AWG	300 V	10
No. 22-12 AWG	300 V	10
6 mm		9 mm



Type	Part no.	Std. pack	Type	Part no.	Std. pack	Type	Part no.	Std. pack
WK/4-8 S/IW/U	57.504.6355.0	100	WK/4-8 S/U	57.504.6255.0	100	WK/3-6 S KO/U	57.504.7355.0	
35 x 27 x 7,5 EN 60715	98.300.0000.0	1	35 x 27 x 7,5 EN 60715	98.300.0000.0	1	35 x 27 x 7,5 EN 60715	98.300.0000.0	1
35 x 24 x 15 EN 60715	98.360.0000.0	1	35 x 24 x 15 EN 60715	98.360.0000.0	1	35 x 24 x 15 EN 60715	98.360.0000.0	1
9006 EN 60715 G-32	98.190.0000.0	1	9006 EN 60715 G-32	98.190.0000.0	1	9006 EN 60715 G-32	98.190.0000.0	1
WE 2/U	Z5.523.5653.0	100	WE 2/U	Z5.523.5653.0	100	WE 2/U	Z5.523.5653.0	100
9708/2 S 35	Z5.522.8553.0	100	9708/2 S 35	Z5.522.8553.0	100	9708/2 S 35	Z5.522.8553.0	100
9708	Z5.522.7053.0	100	9708	Z5.522.7053.0	100	9708	Z5.522.7053.0	100
AP 4 S/IW	07.311.4355.0	50	AP 4 S	07.311.4255.0	10	9701 A/6 1 S KO TP 2	07.310.5855.0	50
	05.592.7553.0	2000		05.592.7553.0	2000		05.592.7553.0	2000
	05.592.7653.0	2000		05.592.7653.0	2000		05.592.7653.0	2000
VB WK/...S/IW/U-2	Z7.281.3227.0	10	9703/6-2	Z7.211.0227.0	50	2072/2	Z7.220.0227.0	50
VB WK/...S/IW/U-3	Z7.281.3327.0	10	9703/6-3	Z7.211.0327.0	50	2072/2	Z7.220.0227.0	50
VB WK/...S/IW/U-6	Z7.281.3627.0	10	9703/6-6	Z7.211.0627.0	50	2072/6	Z7.220.0627.0	50
AD VB 4 GELB	04.326.2153.8	10	AD VB 4 GELB	04.326.2153.8	10			
AD VB 6-10 GELB	04.342.0653.8		AD VB 6-10 GELB	04.342.0653.8				
TS 4 GELB	07.311.2153.8	10	TS 4 GELB	07.311.2153.8	10			

Feed-through blocks with solder connection

selos

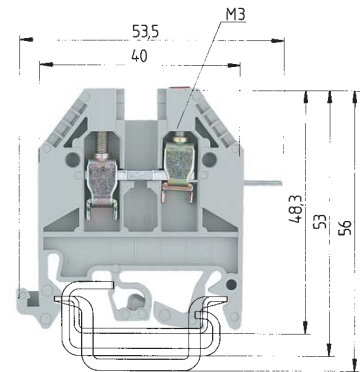
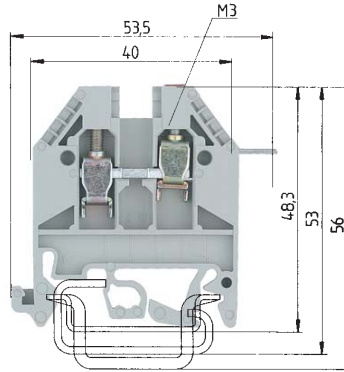

terminals WK 4/UF1 and WK 4/UF2 should be mounted alternately in order to observe the creepages and clearances required for the specific rated voltages.

WK 4/U F1

	fine stranded	solid	V	A
	0.5 - 4 mm ²	0.5 - 6 mm ²	400 V/6 kV/3	32
UL-ratings	No. 22-10 AWG		300 V	30
CSA ratings	No. 22-10 AWG		300 V	20
Width	6 mm			9 mm
Wire strip length				



WK 4/U F2

	fine stranded	solid	V	A
	0.5 - 4 mm ²	0.5 - 6 mm ²	400 V/6 kV/3	32
UL-ratings	No. 22-10 AWG		300 V	30
CSA ratings	No. 22-10 AWG		300 V	20
Width	6 mm			9 mm
Wire strip length				



EN 60 947-7-1/DIN VDE 0611 T1

UL-ratings

CSA ratings

Width

Approvals

Wire strip length

	Type	Part no.	Std. pack	Type	Part no.	Std. pack
Feed through terminal	WK 4/U F1	57.504.1055.0	100	WK 4/U F2	57.504.1155.0	100
Color: gray						
same dimensions as WK4						
Accessories	35 x 27 x 7,5 EN 60715	98.300.0000.0	1	35 x 27 x 7,5 EN 60715	98.300.0000.0	1
1. Mounting rail TS 35, DIN rail 7.5mm high L = 2 m	35 x 24 x 15 EN 60715	98.360.0000.0	1	35 x 24 x 15 EN 60715	98.360.0000.0	1
Mounting rail TS 35, DIN rail 1.5mm high L = 2 m	9006 EN 60715 G-32	98.190.0000.0	1	9006 EN 60715 G-32	98.190.0000.0	1
Mounting rail TS 32 G rail L = 2 m	WE 1/U	Z5.523.5753.0	100	WE 1/U	Z5.523.5753.0	100
2. End clamp with U-foot 10 mm wide	9708/2 S 35	Z5.522.8553.0	100	9708/2 S 35	Z5.522.8553.0	100
End clamp TS 35, with screw 8 mm wide	9708	Z5.522.7053.0	100	9708	Z5.522.7053.0	100
End clamp TS 32, with screw 7.5 mm wide	AP 2,5-4	07.311.0155.0	10	AP 2,5-4	07.311.0155.0	10
3. End plate, 1.5 mm thick Color: gray						
	TW 2,5-4	07.311.1155.0	10	TW 2,5-4	07.311.1155.0	10
4. Partition, 1.5 mm thick						
5. Cross connector with screws, E-Cu insulated	IVB WK 4-2	Z7.281.1227.0	10	IVB WK 4-2	Z7.281.1227.0	10
	IVB WK 4-3	Z7.281.1327.0	10	IVB WK 4-3	Z7.281.1327.0	10
	IVB WK 4-12	Z7.281.2227.0	10	IVB WK 4-12	Z7.281.2227.0	10
6. Cover for jumper bar with marking capability	AD VB 4 GELB	04.326.2153.8	10	AD VB 4 GELB	04.326.2153.8	10
7. Partition plate	TS 4 GELB	07.311.2153.8	10	TS 4 GELB	07.311.2153.8	10
For marking systems see pages 178-179 and 200-202						

selos

selos

Current transformer disconnect terminals

selos

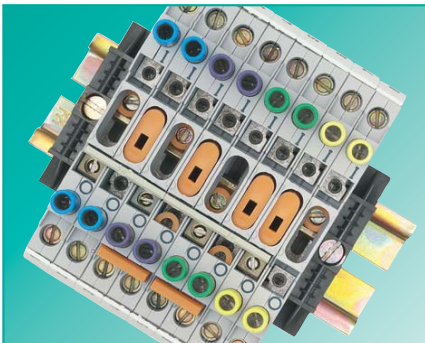

Current transformer circuits must always have a closed secondary circuit. This rule applies even when changing measuring instruments or electric meters and when carrying out reference measurements with external measuring instruments.

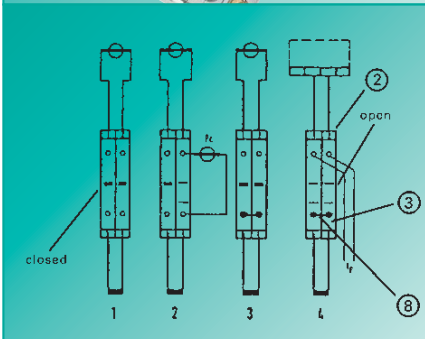

- The WKT-Terminal Block Series meets all circuit applications with the addition of a few accessories.
 - This modular concept reduces inventory and component costs.



- All components including the terminal block and accessories are insulated.
 - Test points are touch safe to the standard VGB4
 - Sliding link and jumper bars are touch safe.



- **Compact design:**
 - Easy to operate Sliding-Link
 - The insulated housing on the Sliding-Link provides a guide for the screwdriver blade. This prevents the blade from accidentally slipping off the screw head. The insulated housing also provides visual indication of the circuit status (open or closed).
 - Jumper Bars
 - Sliding Shorting Bars
 - Test plug socket
 - Accessories are easily installed with a screwdriver, even the test plugs.



- Safe operation of the sliding shorting bar:
 - The sliding shorting bar is designed such that the test plug socket remains available for testing.

selos



Insulated Jumpering System

Distribution of the K - potential is possible due to the open slots for both the sliding shorting bar and the stationary jumper bar. Commoning every other terminal is possible by removing every other pole from the stationary jumper bar (see drawing on page 149).



Insulated Test sockets

The test sockets accept Wieland standard plugs or commercially available safety plugs with a diameter of 4mm.

This allows current tests without shut-down.



The sliding disconnect locking device prevents tampering of the disconnect screw. The locking device can lock the screw in open or closed position. This device is easily installed into the top of the terminal block. Removing the locking device requires a standard screwdriver.



Marking capability with the standard Wieland marking system.

- Single marking tags in the same pitch as the terminal block
- Snap-on marking strips (10 individual marking tags per strip) for rapid marking
- Tear-off marking strips for marking up to 3-digits per terminal block

DQS certificates for all product families

- Quality standard as per DIN ISO 9001
- in Development, Production, Assembly
- Continued control of the quality standard by means of regular internal and external quality audits
- Compatible with certificates of other countries:
 - BSI Certificate, Great Britain
 - SQS Certificate, Switzerland
 - Aib-Vincotte Certificate, Belgium
 - ÖQS Certificate, Austria



Material

- Special alloys and surface treatments
- Low contact resistance
- High corrosion Resistance

Metal parts

Clamping body/clamping screws: steel, zinc-plated and dichromated

Current carrying bar: Tin plated copper alloy

Insulation material

Polyamide 66/6 for its excellent electrical, chemical and mechanical characteristics (see section **facts & DATA**)
Material accord. to US standard UL 94-V0

You can use our **wieplan** software to configure your own terminal block assemblies (see page 10/11).

Note:

The information regarding cross sectional area and connection types pertains to unprepared wires without ferrules.

The voltage ratings apply to the terminals in their intended application. When different products are mounted adjacent to each other, the proper isolation distances must be adhered to. For this purpose, **Wieland** offers a large selection of appropriate accessories.

A detailed description of technical data, the standards' requirements, and the application conditions can be found in part **facts & DATA**.

Current transformer disconnect terminal block

selos

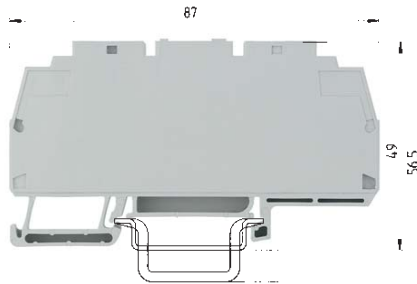

available from 02/02

WK6 TK/35

fine stranded	solid	V	A
0.5 – 6 mm ²	0.5 – 10 mm ²	400 V/6 kV/3	32
No. 20-8 AWG		600 V	45
No. 20-8 AWG		300 V	45
Width	Wire strip length	8 mm	
pending			

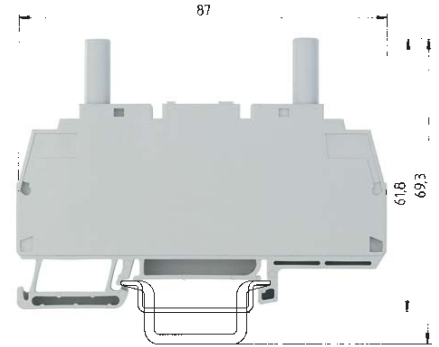

available from 02/02

WK6 TK P3/35

fine stranded	solid	V	A
0.5 – 6 mm ²	0.5 – 10 mm ²	400 V/6 kV/3	32
No. 20-8 AWG		600 V	45
No. 20-8 AWG		300 V	45
Width	Wire strip length	8 mm	
pending			

EN 60 947-7-1/DIN VDE 0611 T1
 UL-ratings field/factory wiring
 CSA ratings
 Width Wire strip length
 Approvals

	Type	Part no.	Std. pack	Type	Part no.	Std. pack
Current transformer disconnect terminal	WK6 TK/35	56.106.0553.0		WK6 TK P3/35	56.106.0653.0	
Accessories						
1. Mounting rail TS 35, DIN rail 7.5mm high L = 2 m	35 x 27 x 7,5 EN 60715	98.300.0000.0	1	35 x 27 x 7,5 EN 60715	98.300.0000.0	1
Mounting rail TS 35, DIN rail, 15mm high L = 2 m	35 x 24 x 15 EN 60715	98.360.0000.0	1	35 x 24 x 15 EN 60715	98.360.0000.0	1
Mounting rail TS 32, G rail L = 2 m						
2. End clamp with U-foot 10 mm wide	WE 1/U	Z5.523.5753.0	100	WE 1/U	Z5.523.5753.0	100
End clamp TS 35 with screw 8 mm wide	9708/2 S 35	Z5.522.8553.0	100	9708/2 S 35	Z5.522.8553.0	100
End clamp TS32 with screw 7.5 mm wide						
3. Disconnect locking device	SP WK6 TK	05.563.5453.0		SP WK6 TK	05.563.5453.0	
4. Sliding short-circuit slide						
insulated 2pole	IVS WK6 TK-2	Z7.212.2227.0		IVS WK6 TK-2	Z7.212.2227.0	
3pole	IVS WK6 TK-3	Z7.212.2327.0		IVS WK6 TK-3	Z7.212.2327.0	
4pole	IVS WK6 TK-4	Z7.212.2427.0		IVS WK6 TK-4	Z7.212.2427.0	
5. Jumper bar with screws, E-Cu						
insulated 2pole	IVB WK6 TK-2	Z7.212.1227.0		IVB WK6 TK-2	Z7.212.1227.0	
3pole	IVB WK6 TK-3	Z7.212.1327.0		IVB WK6 TK-3	Z7.212.1327.0	
4pole	IVB WK6 TK-4	Z7.212.1427.0		IVB WK6 TK-4	Z7.212.1427.0	
5pole	IVB WK6 TK-5	Z7.212.1527.0		IVB WK6 TK-5	Z7.212.1527.0	
10pole	IVB WK6 TK-10	Z7.212.2027.0		IVB WK6 TK-10	Z7.212.2027.0	
6. Test socket						
Color: gray	SB 4 GRAU	05.511.2953.0		SB 4 GRAU	05.511.2953.0	
Color: violet	SB 4 VIOLETT	05.511.2953.9		SB 4 VIOLETT	05.511.2953.9	
Color: green	SB 4 GRÜN	05.511.2953.7		SB 4 GRÜN	05.511.2953.7	
Color: yellow	SB 4 GELB	05.511.2953.8		SB 4 GELB	05.511.2953.8	
For more accessories see pages 160-177						
For marking systems see pages 178-179 and 200-202						

selos POWER LINE

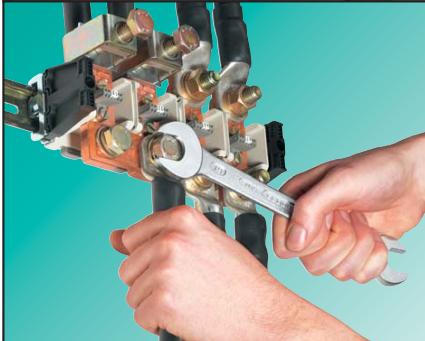
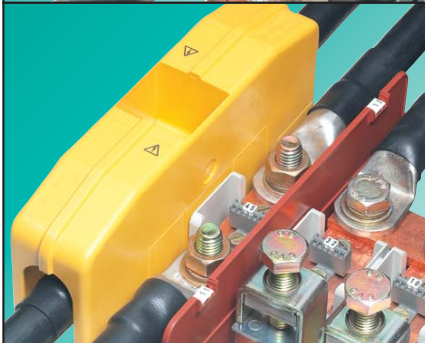
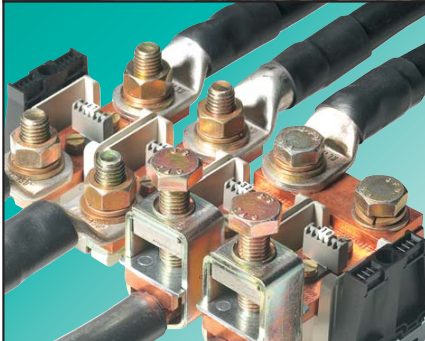
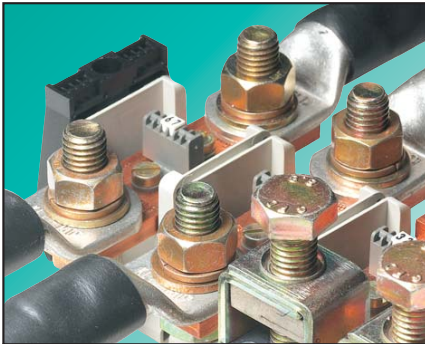

RFK offers ...

❑ Rising Cage Connection Technology

❑ Rising Cage and Ring Terminal Connection

- ❑ **Ring Terminal** connections in two styles:
 - Screw (bolt) with nut
 - Screw (bolt) with threaded current bar

❑ **Rated cross section:** 95 – 240 mm²

❑ **Connection Range:** 2/0 AWG - 500 MCM

❑ **Material:**

- Insulating housing, partition, cover: Polyamide 66/6
- Current carrying bar and jumper rail: E-Cu
- Screws, nuts, washers, clamping bodies: galvanically zinc-plated steel

❑ **Touch Safe Covers**

❑ **Partition Plates** with marking capability

❑ **Jumper bar:**

Available in 2, 3, or 4 pole versions.

Installation instructions:

When tightening the terminal screw, it is recommended that you hold it against the conductor in order to prevent deformation of the mounting rail and to keep the foot of the terminal free from torsional forces.

Application advantages

- A stripped wire can be connected without ferules/unprepared
- Secure connection due to the elastic design of the clamping body
- Connection requires ring lug terminal
- Secure connection with use of lock washers
- Due to its excellent electrical, chemical and mechanical properties
- Low contact resistance
- Touch safe covers can be installed after connections have been made and do not increase the pitch of the assembly.
- Partition plates provide both visual and electrical separation of adjacent terminals. They do not increase the pitch of the assembly and can be marked with the Wieland standard marking system.
- Jumper bars are used to common the potential of RFK terminals with ring connection.

The threaded hole in the foot of the terminal type RFK 1/...PA enables the terminals to be screwed to the mounting rail. Perforated rails are available for the purpose and the mounting rail is pre-drill accordingly on site or at the factory.

Caution: Make sure that the recommended stripped length for the conductor of 27 mm is observed!

selos

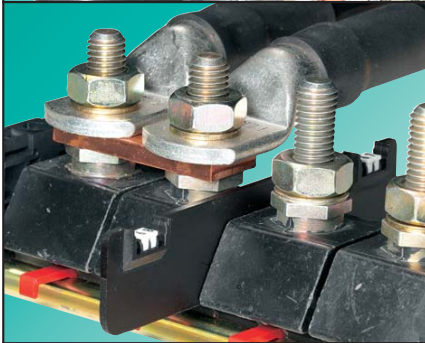
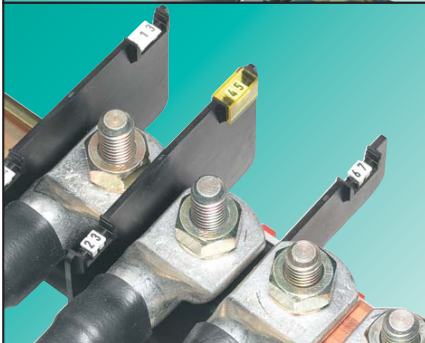
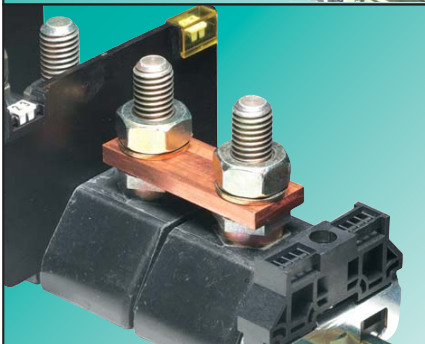
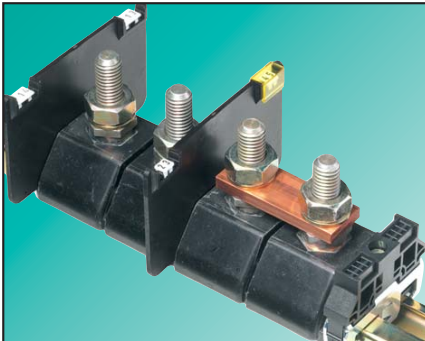

BK offers ...

- Stud bolt connection
 - Torque values to stud bolt diameter standard up to 10 Nm
- Connection range per stud bolt diameter standard
DIN 46 234 from 2.5 to 240 mm**

- Material:**
 - Insulated housing: epoxy resin
 - Stud Bolt, nut and lock washer: galvanized steel, zinc plated
 - Jumper Bar: E-Cu
 - Locking slide, marking tag, and marking tag holder: Polyamide

- End plates / partition plate** with marking capability

- Marking tag cover**

- Jumper bar:**
Available in 2, 3, 4 pole versions
- Locking slides**
allows the BK series to be locked onto the DIN rail

DQS certificates for all company divisions

- Quality standard as per DIN ISO 9001
- in Development, Production, Assembly
- Continued control of the quality standard by means of regular internal and external quality audits
- Compatible with certificates of other countries:
 - BSI Certificate, Great Britain
 - SQS Certificate, Switzerland
 - Aib-Vincotte Certificate, Belgium
 - ÖQS Certificate, Austria

Application advantages

- No loose wires
- High contact force ensures a secure connection with the use of a lock washer
- Constant operating temperature; 150 °C
- Nuts, washer, lock washer are included but are packaged separately
- End plates/partition plates provide both visual and electrical separation of adjacent terminals. They do not increase the pitch of the assembly and can be marked with the Wieland standard marking system.
- The marking tag cover is a translucent yellow material which protects the marking tag against dust and other industrial elements.
- With the BK terminal series for ring connection, it is possible to common the potential of adjacent terminals with a jumper bar.
- The locking slide ensures secure mounting of the BK terminal on the DIN rail. This is important due to larger conductor sizes and higher torque values of the BK series.

You can use our **wieplan** software to configure your own terminal block assemblies (see page 10/11).

A detailed description of technical data, the standards' requirements, and the application conditions can be found in part **facts & DATA**.

Stud bolt terminal for 32 mm DIN rail

selos POWER LINE

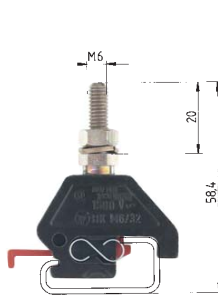

The wire size is dependent on the hole diameter of the ring terminal of 6.5 mm and the max. ring terminal width of 15 mm

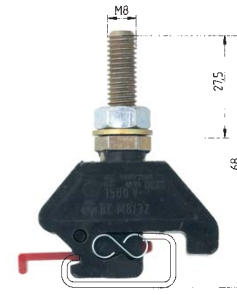

The wire size is dependent on the hole diameter of the ring terminal of 6.5 mm and the max. ring terminal width of 15 mm

BK M 6/32

DIN VDE 0110
UL-ratings
CSA ratings
Width
Approvals

field/factory wiring
Wire strip length

1500 V~	1800 V...	V	A
2 AWG		Gr. C	
18 mm		600 V	115



BK M 8/32

1500 V~	1800 V...	V	A
3/0 AWG		Gr. C	
26 mm		1000 V	200



Stud bolt terminal	Type	Part no.	Std. pack	Type	Part no.	Std. pack
	BK M 6/32	32.630.0042.0	50	BK M 8/32	32.640.0042.0	50
Accessories						
1. Mounting rail TS 35, DIN rail, 7.5 mm high	L = 2 m					
Mounting rail TS 35, DIN rail 15 mm high	L = 2 m					
Mounting rail TS 35, G rail	L = 2 m	9006 EN 60715 G-32	98.190.0000.0 1	9006 EN 60715 G-32	98.190.0000.0 1	
2. End clamp with U-foot	10 mm wide	WE 1/U	Z5.523.5753.0 100	WE 1/U	Z5.523.5753.0 100	
End clamp TS32 with screw	8 mm wide					
End clamp TS32 with screw	7.5 mm wide	9708	Z5.522.7053.0 100	9708	Z5.522.7053.0 100	
3. End plate with marking capability			07.340.4153.0 50		07.340.4153.0 50	
				or	07.340.4353.0 *) 50	
4. Partition with marking capability			07.340.1153.0 50		07.340.1153.0 50	
				or	07.340.1353.0 *) 50	
5. Jumper bar	from E-Cu					
	for 2 blocks					
	for 3 blocks					
	for 4 blocks					
6. Marking tag cover (see page 151)	Color: yellow		04.326.0056.0 100		04.326.0056.0 100	
7. Marking plate			07.340.2153.0 50		07.340.2153.0 50	
				or	07.340.2353.0 *) 50	
For marking systems see pages 178-179 and 200-202						
*) When selecting the partition you have to consider the air and creepage distances.						

Terminal blocks for up to 240 mm² (500 MCM)

selos POWER LINE

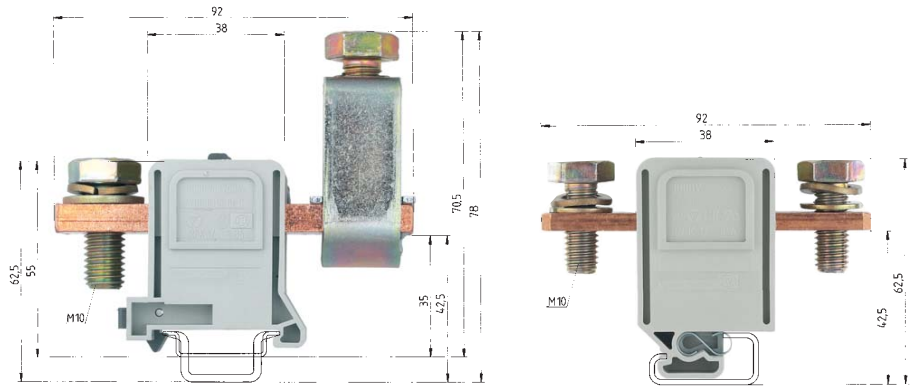

RFK 1/95... S35

fine stranded	V	A
16-95 mm ²	1000 V	250
6-3/0 AWG	600 V	200
6-3/0 AWG	600 V	200
32 mm		27 mm



RFK 1/95... PA

fine stranded	V	A
16-95 mm ²	1000 V	250
6-3/0 AWG	600 V	200
6-3/0 AWG	600 V	200
32 mm		27 mm



DIN VDE 0611 Teil 1/EN 60947-7-1
 UL-ratings field/factory wiring
 CSA ratings
 Width Wire strip length
 Approvals

Configurations	Color: gray	F	Type	Part no.	Std. pack	Type	Part no.	Std. pack
			RFK 1/95 F S 35	56.395.0055.0	10	RFK 1/95 F PA	59.195.0055.0	10
			RFK 1/95 K S 35	56.395.0155.0	10	RFK 1/95 K PA	59.195.0155.0	10
			RFK 1/95 FK S 35	56.395.0255.0	10	RFK 1/95 FK PA	59.195.0255.0	10
			RFK 1/95 FM S 35	56.395.1055.0	10	RFK 1/95 FM PA	59.195.1055.0	10
			RFK 1/95 FMK S 35	56.395.1255.0	10	RFK 1/95 FMK PA	59.195.1255.0	10
Accessories								
1. Mounting rail TS 35, DIN rail, 7.5 mm high	L = 2 m		35 x 27 x 7.5 EN 60715	98.300.0000.0	1			
Mounting rail TS 35, DIN rail 15 mm high	L = 2 m		35 x 24 x 15 EN 60715	98.360.0000.0	1			
Mounting rail TS 35, G rail	L = 2 m					9006 EN 60715 G-32	98.190.0000.0	1
2. End clamp with U-foot	10 mm wide		WE 2/U	Z5.523.5653.0	100	WE 2/U	Z5.523.5653.0	100
End clamp TS35 with screw	8 mm wide		9708/2 S35	Z5.522.8553.0	100	9708/2 S35	Z5.522.8553.0	100
End clamp TS32 with screw	7.5 mm wide		9708	Z5.522.7053.0	100	9708	Z5.522.7053.0	100
3. Cover for RFK 1/...	Color: yellow			Z7.409.5753.0	10		Z7.409.5753.0	10
4. Partition/end plate PA 66/6	2.8 mm thick		TE/RFK 1/95	07.340.0353.0	50	TE/RFK 1/95	07.340.0353.0	50
5. Screws for fixation on the mounting rail						AM 5 x 12 DIN 933	06.065.0021.0	100
6. Jumper bar for tab connection blocks	from E-Cu							
	for 2 blocks		VB RFK 1/95/2/32	07.205.1227.0	20	VB RFK 1/95/2/32	07.205.1227.0	20
	for 3 blocks		VB RFK 1/95/3/32	07.205.1327.0	10	VB RFK 1/95/3/32	07.205.1327.0	10
	for 4 blocks		VB RFK 1/95/4/32	07.205.1427.0	10	VB RFK 1/95/4/32	07.205.1427.0	10
For marking systems see pages 178-179 and 200-202								

selos

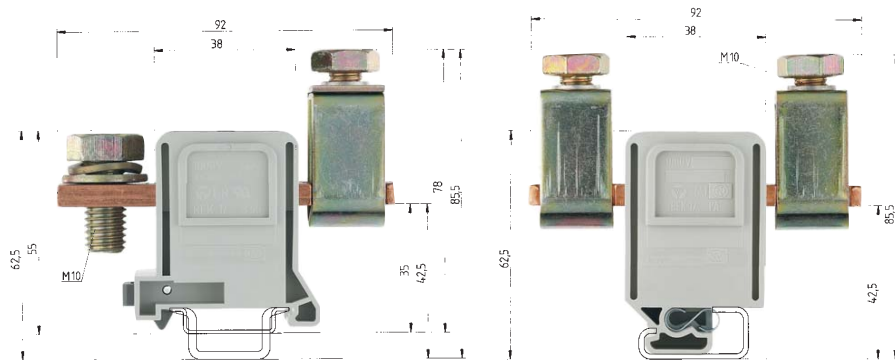

RFK 1/150... S35

fine stranded	V	A
70-240 mm ² 70-240 mm ²	1000 V	335
0 AWG - 300 MCM	600 V	275
0 AWG - 300 MCM	600 V	300
42 mm		27 mm



RFK 1/150... PA

fine stranded	V	A
70-240 mm ² 70-240 mm ²	1000 V	335
0 AWG - 300 MCM	600 V	275
0 AWG - 300 MCM	600 V	300
42 mm		27 mm



mm ²	Type	a x b	M I	M II	H	L	F	E
95	F, K, FK, FM, FMK	5 x 18	M10	M 8	78	180	92	46
150	K, FK, FMK	6 x 26	M12	M10	85.5	200	92	46

Type	Part no.	Std. pack	Type	Part no.	Std. pack
RFK 1/150 K S35	56.397.0155.0		RFK 1/150 K PA	59.197.0155.0	10
RFK 1/150 FK S35	56.397.0255.0		RFK 1/150 FK PA	59.197.0255.0	10
RFK 1/150 FMK S35	56.397.1255.0		RFK 1/150 FMK PA	59.197.1255.0	10
35 x 27 x 7,5 EN 60715	98.300.0000.0	1			
35 x 24 x 15 EN 60715	98.360.0000.0	1			
WE 2/U	Z5.523.5653.0	100	9006 EN 60715 G-32	98.190.0000.0	1
9708/2 S35	Z5.522.8553.0	100	WE 2/U	Z5.523.5653.0	100
9708	Z5.522.7053.0	100	9708/2 S 35	Z5.522.8553.0	100
	Z7.409.5753.0	10	9708	Z5.522.7053.0	100
TE/RFK 1/150 - 240 PA	07.340.1053.0	50		Z7.409.5753.0	10
			TE/RFK 1/150 - 240 PA	07.340.1053.0	50
			AM 5 x 12 DIN 933	06.065.0021.0	100
VB RFK 1/185/2	07.201.4227.0	10	VB RFK 1/185/2	07.201.4227.0	10
VB RFK 1/185/3	07.201.4327.0	10	VB RFK 1/185/3	07.201.4327.0	10
VB RFK 1/185/4	07.201.4427.0	10	VB RFK 1/185/4	07.201.4427.0	10

Configurations:

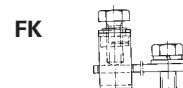
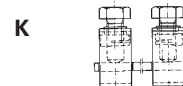
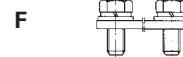

Terminal blocks for up to 240 mm² (500 MCM)

selos POWER LINE

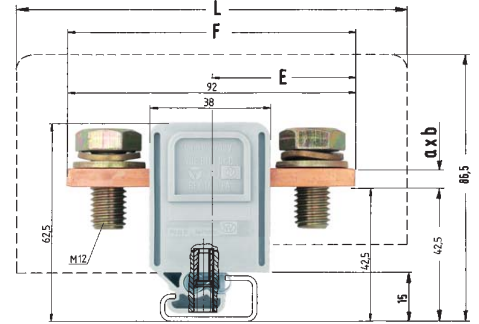
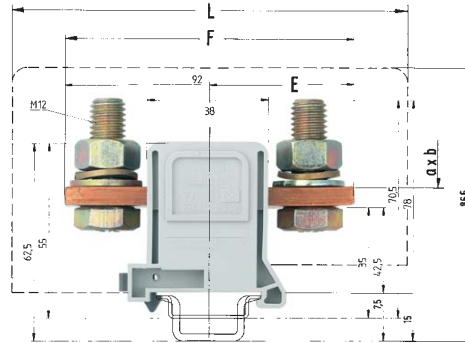

RFK 1/185... S35

RFK 1/185... PA

EN 60 947-7-1/DIN VDE 0611 T1

UL-ratings field/factory wiring

CSA ratings

Width

Approvals

Wire strip length

0 AWG - 400 kcmil
0 AWG - 400 MCM
42 mm

V A
1000 V/8 kV/3 353
600 V 375
600 V 375
27 mm

0 AWG - 400 kcmil
0 AWG - 400 MCM
42 mm

V A
1000 V/8 kV/3 353
600 V 375
600 V 375
27 mm



Configuration	Color: gray	F	Type	Part no.	Std. pack	Type	Part no.	Std. pack
	Color: gray	K	RFK 1/185 F S 35	56.398.0055.0	10	RFK 1/185 F PA	59.198.0055.0	10
	Color: gray	FK						
	Color: gray	FM	RFK 1/185 FM S 35	56.398.1055.0	10	RFK 1/185 FM PA	59.198.1055.0	10
	Color: gray	FMK						
Accessories								
1. Mounting rail TS 35, DIN rail, 7.5 mm high	L = 2 m		35 x 27 x 7,5 EN 60715	98.300.0000.0	1			
Mounting rail TS 35, DIN rail 15 mm high	L = 2 m		35 x 24 x 15 EN 60715	98.360.0000.0	1			
Mounting rail TS 35, G rail	L = 2 m					9006 EN 60715 G-32	98.190.0000.0	1
2. End clamp with U-foot	10 mm wide		WE 2/U	Z5.523.5653.0	100	WE 2/U	Z5.523.5653.0	100
End clamp TS32 with screw	8 mm wide		9708/2 S35	Z5.522.8553.0	100			
End clamp TS32 with screw	7.5 mm wide					9708	Z5.522.7053.0	100
3. Cover for RFK 1/...	Color: yellow			Z7.409.5853.0	10		Z7.409.5853.0	10
4. Partition/end plate PA 66/6	2.8 mm thick		TE/RFK 1/150 - 240 PA	07.340.1053.0	50	TE/RFK 1/150 - 240 PA	07.340.1053.0	50
5. Screws for fixation on the mounting rail						AM 5 x 12 DIN 933	06.065.0021.0	100
6. Jumper bar for tab connection blocks	from E-Cu							
	for 2 blocks		VB RFK 1/185/2	07.201.4227.0	10	VB RFK 1/185/2	07.201.4227.0	10
	for 3 blocks		VB RFK 1/185/3	07.201.4327.0	10	VB RFK 1/185/3	07.201.4327.0	10
	for 4 blocks		VB RFK 1/185/4	07.201.4427.0	10	VB RFK 1/185/4	07.201.4427.0	10

For marking systems see pages 178-179 and 200-202

selos

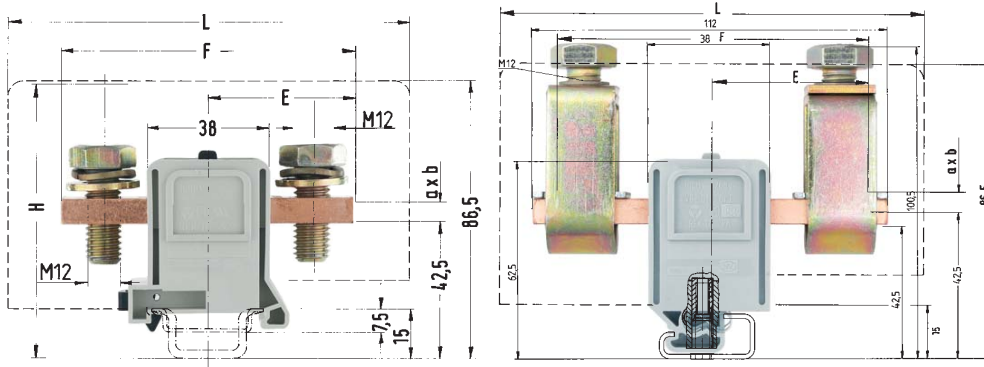

RFK 1/240... S35

fine stranded stranded V A
 70-240 mm² 70-240 mm² 1000 V/8 kV/3 415
 0 AWG - 500 kcmil 600 V 375
 3/0 AWG - 500 MCM 600 V 425
 42 mm 27 mm



RFK 1/240... PA

fine stranded stranded V A
 70-240 mm² 70-240 mm² 1000 V/8 kV/3 415
 0 AWG - 500 kcmil 600 V 375
 3/0 AWG - 500 MCM 600 V 425
 42 mm 27 mm



mm ²	Type	a x b	M I	M II	H	L	F	E
185	F, FM	6 x 26	M 12	-	-	200	92	46
	F, FM	8 x 26	M 12	-	-	200	92	46
240	FK, FMK	8 x 26	M 12	M 12	100.5	200	102	46
	K	8 x 26	-	M 12	100.5	200	112	56

Type	Part no.	Std. pack	Type	Part no.	Std. pack
RFK 1/240 F S 35 ^{*)}	56.399.0055.0	10	RFK 1/240 F PA ^{*)}	59.199.0055.0	10
RFK 1/240 K S 35	56.399.0155.0	10	RFK 1/240 K PA	59.199.0155.0	10
RFK 1/240 FK S 35 ^{*)}	56.399.0255.0	10	RFK 1/240 FK PA ^{*)}	59.199.0255.0	10
RFK 1/240 FM S 35 ^{*)}	56.399.1055.0	10	RFK 1/240 FM PA ^{*)}	59.199.1055.0	10
RFK 1/240 FMK S 35 ^{*)}	56.399.1255.0	10	RFK 1/240 FMK PA ^{*)}	59.199.1255.0	10
35 x 27 x 7,5 EN 60715	98.300.0000.0	1			
35 x 24 x 15 EN 60715	98.360.0000.0	1			
WE 2/U	Z5.523.5653.0	100	9006 EN 60715 G-32	98.190.0000.0	1
9708/2 S 35	Z5.522.8553.0	100	WE 2/U	Z5.523.5653.0	100
			9708	Z5.522.7053.0	100
	Z7.409.5853.0	10		Z7.409.5853.0	10
TE/RFK 1/150 - 240 PA	07.340.1053.0	50	TE/RFK 1/150 - 240 PA	07.340.1053.0	50
			AM 5 x 12 DIN 933	06.065.0021.0	100
VB RFK 1/240/2	07.201.8227.0	10	VB RFK 1/240/2	07.201.8227.0	10
VB RFK 1/240/3	07.201.8327.0	10	VB RFK 1/240/3	07.201.8327.0	10
VB RFK 1/240/4	07.201.8427.0	10	VB RFK 1/240/4	07.201.8427.0	10

Configurations:

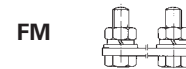
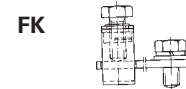
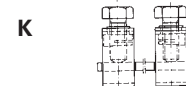
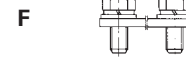

^{*)} Only use ring terminals accord. to DIN 46234

Accessories for DIN rail terminal blocks

selos

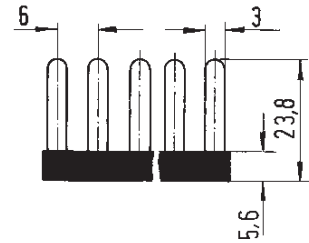
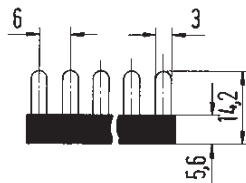
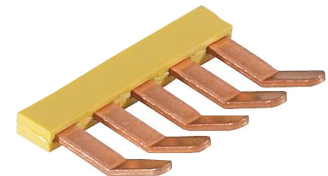
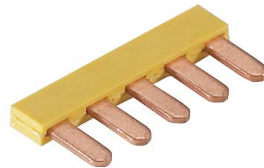

Jumper comb, insulated

Type	Part no.	Std. pack	Type	Part no.	Std. pack	Type	Part no.	Std. pack
for terminal blocks type			WK 4 E/U			WK 4 E/U		
			1 mm thick			1 mm thick, angled		
WK 2,5-4 KI/U			2pole IVB WK 4 E-2	Z7.255.2227.0	10	2pole IVBS WK 4 E-2	Z7.256.4227.0	10
WK 2,5-4 KI/U-NGN			3pole IVB WK 4 E-3	Z7.255.2327.0	10	3pole IVBS WK 4 E-3	Z7.256.4327.0	10
WK 2,5-4 KI/U-PGN			4pole IVB WK 4 E-4	Z7.255.2427.0	10	4pole IVBS WK 4 E-4	Z7.256.4427.0	10
WK 2,5-4 KI SL			5pole IVB WK 4 E-5	Z7.255.2527.0	10	5pole IVBS WK 4 E-5	Z7.256.4527.0	10
WK 2,5-4 KI SL-NGN			6pole IVB WK 4 E-6	Z7.255.2627.0	10	6pole IVBS WK 4 E-6	Z7.256.4627.0	10
WK 2,5-4 KI SL-PGN			7pole IVB WK 4 E-7	Z7.255.2727.0	10	7pole IVBS WK 4 E-7	Z7.256.4727.0	10
WK 2,5-3 D/U			8pole IVB WK 4 E-8	Z7.255.2827.0	10	8pole IVBS WK 4 E-8	Z7.256.4827.0	10
WK 2,5-3 D/U-NGN			9pole IVB WK 4 E-9	Z7.255.2927.0	10	9pole IVBS WK 4 E-9	Z7.256.4927.0	10
WK 2,5-3 D/U-PGN			10pole IVB WK 4 E-10	Z7.255.3027.0	10	10pole IVBS WK 4 E-10	Z7.256.5027.0	10
WK 2,5-3 D SL			11pole IVB WK 4 E-11	Z7.255.3127.0	10	11pole IVBS WK 4 E-11	Z7.256.5127.0	10
WK 2,5-3 D SL-NGN			12pole IVB WK 4 E-12	Z7.255.3227.0	10	12pole IVBS WK 4 E-12	Z7.256.5227.0	10
WK 2,5-3 D SL-PGN								
0.8 mm thick, angled			for lower tier blocks only			for lower tier blocks only		
2pole VB WK 2,5-K-2	red	Z7.267.0227.5 10						
3pole IVB WK 2,5-K-3	red	Z7.267.0327.5 10						
4pole IVB WK 2,5-K-4	red	Z7.267.0427.5 10						
5pole IVB WK 2,5-K-5	red	Z7.267.0527.5 10						
6pole IVB WK 2,5-K-6	red	Z7.267.0627.5 10						
7pole IVB WK 2,5-K-7	red	Z7.267.0727.5 10						
8pole IVB WK 2,5-K-8	red	Z7.267.0827.5 10						
9pole IVB WK 2,5-K-9	red	Z7.267.0927.5 10						
10pole IVB WK 2,5-K-10	red	Z7.267.1027.5 10						
11pole IVB WK 2,5-K-11	red	Z7.267.1127.5 10						
12pole IVB WK 2,5-K-12	red	Z7.267.1227.5 10						
70pole IVB WK 2,5-K-M-70	red	Z7.267.0027.5 10						
0.8 mm thick, angled								
2pole IVB WK 2,5-K-2	blue	Z7.267.0227.6 10						
3pole IVB WK 2,5-K-3	blue	Z7.267.0327.6 10						
4pole IVB WK 2,5-K-4	blue	Z7.267.0427.6 10						
5pole IVB WK 2,5-K-5	blue	Z7.267.0527.6 10						
6pole IVB WK 2,5-K-6	blue	Z7.267.0627.6 10						
7pole IVB WK 2,5-K-7	blue	Z7.267.0727.6 10						
8pole IVB WK 2,5-K-8	blue	Z7.267.0827.6 10						
9pole IVB WK 2,5-K-9	blue	Z7.267.0927.6 10						
10pole VB WK 2,5-K-10	blue	Z7.267.1027.6 10						
11pole IVB WK 2,5-K-11	blue	Z7.267.1127.6 10						
12pole IVB WK 2,5-K-12	blue	Z7.267.1227.6 10						
70pole VB WK 2,5-K-M-70	blue	Z7.267.0027.6 10						

Accessories for DIN rail terminal blocks

selos



Cross connectors (jumper bars), insulated

Type	Part no.	Std. pack	Type	Part no.	Std. pack	Type	Part no.	Std. pack
for terminal blocks type			WK 4 TKG/U	6 mm spacing Screw: M 3		WK 4 E/U	6 mm spacing Screw: M 3	
WK 2,5 U	5 mm spacing Screw: M 2.5		WK 4 TKM/U			WK 4		
WK 2,5-4 KOI/U			WK 4/U			2pole IVB WK 4E/U-2	Z7.271.2227.0	10
WK 2,5 U/8113 S/H			WK 4 TKS D/U			3pole IVB WK 4E/U-3	Z7.271.2327.0	10
2pole IVB WK 2,5-2	Z7.280.2227.0	10	WK 4 TKG-TRST/U			4pole IVB WK 4E/U-4	Z7.271.2427.0	10
3pole IVB WK 2,5-3	Z7.280.2327.0	10	12pole IVB WKI 4-12	Z7.271.5227.0	10	5pole IVB WK 4E/U-5	Z7.271.2527.0	10
4pole IVB WK 2,5-4	Z7.280.2427.0	10				6pole IVB WK 4E/U-6	Z7.271.2627.0	10
5pole IVB WK 2,5-5	Z7.280.2527.0	10	WK 4/U	6 mm spacing Screw: M 3		7pole IVB WK 4E/U-7	Z7.271.2727.0	10
6pole IVB WK 2,5-6	Z7.280.2627.0	10	WK 4 TKS D/U			8pole IVB WK 4E/U-8	Z7.271.2827.0	10
7pole IVB WK 2,5-7	Z7.280.2727.0	10	WK 4 3 S 1 K/U			9pole IVB WK 4E/U-9	Z7.271.2927.0	10
8pole IVB WK 2,5-8	Z7.280.2827.0	10	WK 4 3-6 S 1 K/U			10pole IVB WK 4E/U-10	Z7.271.3027.0	10
9pole IVB WK 2,5-9	Z7.280.2927.0	10	WK 4 5 S 2,8 1 K/U			11pole IVB WK 4E/U-11	Z7.271.3127.0	10
10pole IVB WK 2,5-10	Z7.280.3027.0	10	WK 4 3 S 1 K/W/U			12pole IVB WK 4E/U-12	Z7.271.3227.0	10
11pole IVB WK 2,5-11	Z7.280.3127.0	10	WK 4 3-6 S 1 K/W/U					
12pole IVB WK 2,5-12	Z7.280.3227.0	10	WK 4/U F1			WK 4/D 1/2 U	6 mm spacing Screw: M 3	
			WK 4/U F2			WK 4/D 2/2 U		
WK 2,5-3 D/U	6 mm spacing Screw: M 2.5		2pole IVB WK 4-2	Z7.281.1227.0	10	2pole IVB WK 4/D..-2	Z7.281.7227.0	10
WK 2,5-3 D SL			3pole IVB WK 4-3	Z7.281.1327.0	10	3pole IVB WK 4/D..-3	Z7.281.7327.0	10
2pole IVB WK 2,5-3 D-2	Z7.270.0227.0	10	4pole IVB WK 4-4	Z7.281.1427.0	10	4pole IVB WK 4/D..-4	Z7.281.7427.0	10
3pole IVB WK 2,5-3 D-3	Z7.270.0327.0	10	5pole IVB WK 4-5	Z7.281.1527.0	10	5pole IVB WK 4/D..-5	Z7.281.7527.0	10
4pole IVB WK 2,5-3 D-4	Z7.270.0427.0	10	6pole IVB WK 4-6	Z7.281.1627.0	10	6pole IVB WK 4/D..-6	Z7.281.7627.0	10
5pole IVB WK 2,5-3 D-5	Z7.270.0527.0	10	7pole IVB WK 4-7	Z7.281.1727.0	10	7pole IVB WK 4/D..-7	Z7.281.7727.0	10
6pole IVB WK 2,5-3 D-6	Z7.270.0627.0	10	8pole IVB WK 4-8	Z7.281.1827.0	10	8pole IVB WK 4/D..-8	Z7.281.7827.0	10
7pole IVB WK 2,5-3 D-7	Z7.270.0727.0	10	9pole IVB WK 4-9	Z7.281.1927.0	10	9pole IVB WK 4/D..-9	Z7.281.7927.0	10
8pole IVB WK 2,5-3 D-8	Z7.270.0827.0	10	10pole IVB WK 4-10	Z7.281.2027.0	10	10pole IVB WK 4/D..-10	Z7.281.8027.0	10
9pole IVB WK 2,5-3 D-9	Z7.270.0927.0	10	11pole IVB WK 4-11	Z7.281.2127.0	10	11pole IVB WK 4/D..-11	Z7.281.8127.0	10
10pole IVB WK 2,5-3 D-10	Z7.270.1027.0	10	12pole IVB WK 4-12	Z7.281.2227.0	10	12pole IVB WK 4/D..-12	Z7.281.8227.0	10
11pole IVB WK 2,5-3 D-11	Z7.270.1127.0	10				WK 4/DEU	6 mm spacing Screw: M 3	
12pole IVB WK 2,5-3 D-12	Z7.270.1227.0	10				2pole IVB WK 4/DEU-2	Z7.271.0227.0	10
70pole IVB WK 2,5-3 D M-70	Z7.270.0027.0	10				3pole IVB WK 4/DEU-3	Z7.271.0327.0	10
						4pole IVB WK 4/DEU-4	Z7.271.0427.0	10
						5pole IVB WK 4/DEU-5	Z7.271.0527.0	10
						6pole IVB WK 4/DEU-6	Z7.271.0627.0	10
						7pole IVB WK 4/DEU-7	Z7.271.0727.0	10
						8pole IVB WK 4/DEU-8	Z7.271.0827.0	10
						9pole IVB WK 4/DEU-9	Z7.271.0927.0	10
						10pole IVB WK 4/DEU-10	Z7.271.1027.0	10
						11pole IVB WK 4/DEU-11	Z7.271.1127.0	10
						12pole IVB WK 4/DEU-12	Z7.271.1227.0	10

Type	Part no.	Std. pack	Type	Part no.	Std. pack
WK 6/U 8 mm spacing Screw: M 3			WKN 16/U 12 mm spacing Screw: M 4		
2pole IVB WK 6-2	Z7.282.2227.0	10	2pole IVB WKN 16-2	Z7.284.2227.0	10
3pole IVB WK 6-3	Z7.282.2327.0	10	3pole IVB WKN 16-3	Z7.284.2327.0	10
4pole IVB WK 6-4	Z7.282.2427.0	10	4pole IVB WKN 16-4	Z7.284.2427.0	10
5pole IVB WK 6-5	Z7.282.2527.0	10	5pole IVB WKN 16-5	Z7.284.2527.0	10
6pole IVB WK 6-6	Z7.282.2627.0	10	6pole IVB WKN 16-6	Z7.284.2627.0	10
7pole IVB WK 6-7	Z7.282.2727.0	10	7pole IVB WKN 16-7	Z7.284.2727.0	10
8pole IVB WK 6-8	Z7.282.2827.0	10	8pole IVB WKN 16-8	Z7.284.2827.0	10
9pole IVB WK 6-9	Z7.282.2927.0	10	9pole IVB WKN 16-9	Z7.284.2927.0	10
10pole IVB WK 6-10	Z7.282.3027.0	10	10pole IVB WKN 16-10	Z7.284.3027.0	10
11pole IVB WK 6-11	Z7.282.3127.0	10	11pole IVB WKN 16-11	Z7.284.3127.0	10
12pole IVB WK 6-12	Z7.282.3227.0	10	12pole IVB WKN 16-12	Z7.284.3227.0	10
			30pole IVB WKN 16 M-30	Z7.284.2027.0	10
WKN 10/U 10 mm spacing Screw: M 3.5			WKN 35/U 16 mm spacing Screw: M 5		
2pole IVB WKN 10-2	Z7.283.2227.0	10	2pole IVB WKN 35-2	Z7.285.2227.0	5
3pole IVB WKN 10-3	Z7.283.2327.0	10	3pole IVB WKN 35-3	Z7.285.2327.0	5
4pole IVB WKN 10-4	Z7.283.2427.0	10	4pole IVB WKN 35-4	Z7.285.2427.0	5
5pole IVB WKN 10-5	Z7.283.2527.0	10	5pole IVB WKN 35-5	Z7.285.2527.0	5
6pole IVB WKN 10-6	Z7.283.2627.0	10	6pole IVB WKN 35-6	Z7.285.2627.0	5
7pole IVB WKN 10-7	Z7.283.2727.0	10	7pole IVB WKN 35-7	Z7.285.2727.0	5
8pole IVB WKN 10-8	Z7.283.2827.0	10	8pole IVB WKN 35-8	Z7.285.2827.0	5
9pole IVB WKN 10-9	Z7.283.2927.0	10	9pole IVB WKN 35-9	Z7.285.2927.0	5
10pole IVB WKN 10-10	Z7.283.3027.0	10	10pole IVB WKN 35-10	Z7.285.3027.0	5
11pole IVB WKN 10-11	Z7.283.3127.0	10	11pole IVB WKN 35-11	Z7.285.3127.0	5
12pole IVB WKN 10-12	Z7.283.3227.0	10	12pole IVB WKN 35-12	Z7.285.3227.0	5
			20pole IVB WKN 35 M-20	Z7.285.2027.0	10

Accessories for DIN rail terminal blocks

selos



Cross connectors, (jumper bars) uninsulated

Type	Part no.	Std. pack	Type	Part no.	Std. pack	Type	Part no.	Std. pack
for terminal blocks type			for terminal blocks type			for terminal blocks type		
WK 2,5/U	5 mm spacing Screw: M 2.5		WK 4/U	6 mm spacing Screw: M 3		WK 4/3-6 SKO	6 mm spacing Screw: M 3	
WK 2,5 - 4 KOI/U			WK 4TKS D/U			2pole 2072/2	Z7.220.0227.0	50
WK 2,5 U/8113 S/H			WK 4 3 S 1 K/U			3pole 2072/3	Z7.220.0327.0	50
WKN 2,5 E/U			WK 4 3-6 S 1 K/U			4pole 2072/4	Z7.220.0427.0	50
2pole VB WK 2,5-2	Z7.280.0227.0	10	WK 4 5 S 2,8 1 K/U			5pole 2072/5	Z7.220.0527.0	50
3pole VB WK 2,5-3	Z7.280.0327.0	10	WK 4 3 S 1 K/IW/U			6pole 2072/6	Z7.220.0627.0	50
4pole VB WK 2,5-4	Z7.280.0427.0	10	WK 4 3-6 S 1 K/IW/U			70pole 2072/M	Z7.210.1027.0	10
5pole VB WK 2,5-5	Z7.280.0527.0	10	WK 4/U F1			WK/5 S/U	6 mm spacing Screw: M 3	
6pole VB WK 2,5-6	Z7.280.0627.0	10	WK 4/U F2			WK/5-10 S/U		
80pole VB WK 2,5 M-80	Z7.280.0027.0	10	2pole VB WK 4-2	Z7.281.0227.0	10	WK/3-6 S/U		
WKM 2,5/15	5 mm spacing Screw: M 2.5		3pole VB WK 4-3	Z7.281.0327.0	10	WK/4 S/U		
WKM 2,5 F1/15			4pole VB WK 4-4	Z7.281.0427.0	10	WK/4-8 S/U		
WKM 2,5 F2/15			5pole VB WK 4-5	Z7.281.0527.0	10	2pole 9703/6-2	Z7.211.0227.0	50
WKM 2,5/2 S 2,8 1 K/15			6pole VB WK 4-6	Z7.281.0627.0	10	3pole 9703/6-3	Z7.211.0327.0	50
WKM 2,5 TP1 O/15			70pole VB WK 4 M-70	Z7.281.0027.0	10	4pole 9703/6-4	Z7.211.0427.0	50
WKM 2,5 TP2 O/15			WK 4/D 1/2 U	6 mm spacing Screw: M 3		5pole 9703/6-5	Z7.211.0527.0	50
2pole VB WKM 2,5/15-2	Z7.215.4227.0	50	WK 4/D 2/2 U			6pole 9703/6-6	Z7.211.0627.0	50
3pole VB WKM 2,5/15-3	Z7.215.4327.0	50	2pole VB WK 4 D...-2	Z7.281.6227.0	10	70pole 9703/6 M-70	Z7.211.0027.0	10
4pole VB WKM 2,5/15-4	Z7.215.4427.0	50	3pole VB WK 4 D...-3	Z7.281.6327.0	10			
5pole VB WKM 2,5/15-5	Z7.215.4527.0	50	4pole VB WK 4 D...-4	Z7.281.6427.0	10			
6pole VB WKM 2,5/15-6	Z7.215.4627.0	50	5pole VB WK 4 D...-5	Z7.281.6527.0	10			
60pole VB WKM 2,5/15 M#0	Z7.215.4027.0	10	6pole VB WK 4 D...-6	Z7.281.6627.0	10			
WK/3 S/IW/U	6 mm spacing Screw: M 3		70pole VB WK 4 D... M-70	Z7.281.6027.0	10			
WK/3 - 6 S/IW/U			WKM 4/15	6 mm spacing Screw: M 3				
WK/4 S/IW/U			WK 4/D EU					
WK/4-8 S/IW/U			WK 4 E/U for upper tier block					
2pole VB WK/...S/IW/U-2	Z7.281.3227.0	10	WK 4 E/U GU ORANGE					
3pole VB WK/...S/IW/U-3	Z7.281.3327.0	10	WK 4 E/U GO					
4pole VB WK/...S/IW/U-4	Z7.281.3427.0	10	WK 4 E/U G2					
5pole VB WK/...S/IW/U-5	Z7.281.3527.0	10	WK 4 E/U G1 ORANGE					
6pole VB WK/...S/IW/U-6	Z7.281.3627.0	10	WK 4 E/U G-URL					
20pole VB WK/...S/IW/U-20	Z7.281.3027.0	10	WK 4 E/U G-ULR					
			WK 4 E/U VB SCHWARZ					
			2pole 9215 - 2	Z7.210.3227.0	50			
			3pole 9215 - 3	Z7.210.3327.0	50			
			4pole 9215 - 4	Z7.210.3427.0	50			
			5pole 9215 - 5	Z7.210.3527.0	50			
			6pole 9215 - 6	Z7.210.3627.0	50			
			70pole 9215 M-70	Z7.210.3027.0	10			

selos



Type	Part no.	Std. pack
WK 6/U	8 mm spacing Screw: M 3.5	
2pole VB WK 6-2	Z7.282.0227.0	10
3pole VB WK 6-3	Z7.282.0327.0	10
4pole VB WK 6-4	Z7.282.0427.0	10
5pole VB WK 6-5	Z7.282.0527.0	10
6pole VB WK 6-6	Z7.282.0627.0	10
40pole VB WK 6 M-40	Z7.282.0027.0	10
WK 10/Si U 5 x 20	Spacing: 8 mm Screw: M 3	
WK 10/Si U 5 x 25		
WK 10/Si U 5 x 30		
WK 10/Si U 6.3 x 32		
WK 10/Si UD		
2pole VB WK 10/Si-2	Z7.287.0227.0	10
3pole VB WK 10/Si-3	Z7.287.0327.0	10
4pole VB WK 10/Si-4	Z7.287.0427.0	10
5pole VB WK 10/Si-5	Z7.287.0527.0	10
6pole VB WK 10/Si-6	Z7.287.0627.0	10
30pole VB WK 10/Si M-30	Z7.287.0027.0	10
WKN 10/U	10 mm spacing Screw: M 3.5	
2pole VB WKN 10-2	Z7.283.6227.0	10
3pole VB WKN 10-3	Z7.283.6327.0	10
4pole VB WKN 10-4	Z7.283.6427.0	10
5pole VB WKN 10-5	Z7.283.6527.0	10
6pole VB WKN 10-6	Z7.283.6627.0	10
40pole VB WKN 10 M-40	Z7.283.6027.0	10
WKN 70/U	Spacing: 24 mm Screw: M 6	
2pole VB WKN 70-2	Z7.286.3227.0	5
3pole VB WKN 70-3	Z7.286.3327.0	5
4pole VB WKN 70-4	Z7.286.3427.0	5
5pole VB WKN 70-5	Z7.286.3527.0	5
6pole VB WKN 70-6	Z7.286.3627.0	5
WKN 150/U	28 mm spacing Screw: M 8	
2pole VB WKN 150-2	Z7.287.1227.0	5
3pole VB WKN 150-3	Z7.287.1327.0	5

selos



Partition plate

with marking facilities

Partition

with marking facilities

Type	Part no.	Std. pack	Type	Part no.	Std. pack
for terminal block type					
WK 2,5/U			for TS 32 + 35	Z7.311.1753.0	
TS 2,5 GELB	07.311.2053.8	10	for TS 15	Z7.311.2753.0	10
WK/3...					
WK 4/U					
WK 4/...					
WK 4 3 ...					
WK 4 5 S					
WK 5					
TS 4 GELB	07.311.2153.8	10			
WK 6/U					
TS 6 GELB	07.311.2253.8	10			
WKM 2,5 F...					
TSM 2,5/15	07.311.2853.8	10			
WKM 4/15					
TS 4/15 GELB	07.311.2953.8	10			
Partition plate with cover					
WKN 16/U					
TSN AD 16 GELB	07.311.8553.8	10			

Accessories for DIN rail terminal blocks

selos

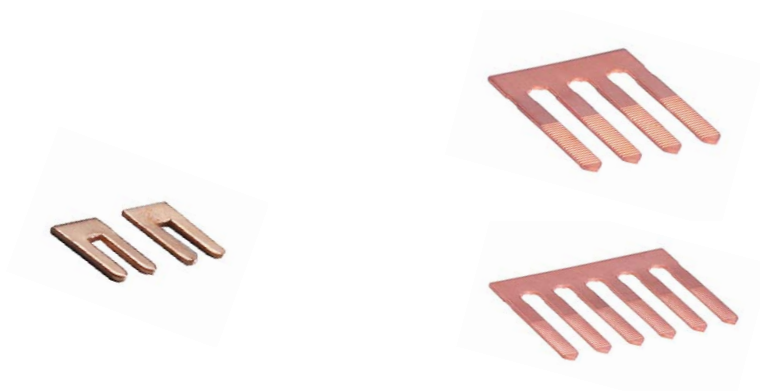

Jumper combs, uninsulated

(for rated voltages of up to 50 V)

Type	Part no.	Std. pack	Type	Part no.	Std. pack	Type	Part no.	Std. pack
for terminal block type			WK 4 E/U			WK 4 TKM/U		
			1 mm thick			WK 4/U		
9785 U/10Ω bis 50 kΩ			2pole VB WK 4 E-2 07.255.2227.0 10			WK 4 TKS D/U		
9785 U/10Ω-SPT bis 50 kΩ-SPT			3pole VB WK 4 E-3 07.255.2327.0 10			WK 4 TRST/U		
9786 U/12			4pole VB WK 4 E-4 07.255.2427.0 10			0.5 mm thick		
9786 U/12 D			5pole VB WK 4 E-5 07.255.2527.0 10			2pole VB 0,5 WK 4..-2 07.255.0227.0 50		
9786 U/12 D-G1			6pole VB WK 4 E-6 07.255.2627.0 10			3pole VB 0,5 WK 4..-3 07.255.0327.0 50		
9786 U/12 G 2-4 K			7pole VB WK 4 E-7 07.255.2727.0 10			4pole VB 0,5 WK 4..-4 07.255.0427.0 50		
9786 U/12 G 2-3 K			8pole VB WK 4 E-8 07.255.2827.0 10			5pole VB 0,5 WK 4..-5 07.255.0527.0 10		
1 mm thick			9pole VB WK 4 E-9 07.255.2927.0 10			6pole VB 0,5 WK 4..-6 07.255.0627.0 10		
2pole VB 9786-2 07.253.0227.0 50			10pole VB WK 4 E-10 07.255.3027.0 10			7pole VB 0,5 WK 4..-7 07.255.0727.0 50		
3pole VB 9786-3 07.253.0327.0 50			11pole VB WK 4 E-11 07.255.3127.0 10			8pole VB 0,5 WK 4..-8 07.255.0827.0 10		
4pole VB 9786-4 07.253.0427.0 50			12pole VB WK 4 E-12 07.255.3227.0 10			9pole VB 0,5 WK 4..-9 07.255.0927.0 50		
			70pole VB WK 4 EM-70 07.255.2027.0 10			10pole VB 0,5 WK 4..-10 07.255.1027.0 50		
			1 mm thick, angled			11pole VB 0,5 WK 4..-11 07.255.1127.0 50		
			2pole VBS WK 4 E-2 07.256.4227.0 10			12pole VB 0,5 WK 4..-12 07.255.1227.0 10		
			3pole VBS WK 4 E-3 07.256.4327.0 10			70pole VB 0,5 WK 4.. M-70 07.255.0027.0 10		
			4pole VBS WK 4 E-4 07.256.4427.0 10			1 mm thick		
			5pole VBS WK 4 E-5 07.256.4527.0 10			2pole VB 1 WK 4..-2 07.255.4227.0 10		
			6pole VBS WK 4 E-6 07.256.4627.0 10			3pole VB 1 WK 4..-3 07.255.4327.0 10		
			7pole VBS WK 4 E-7 07.256.4727.0 10			4pole VB 1 WK 4..-4 07.255.4427.0 10		
			8pole VBS WK 4 E-8 07.256.4827.0 10			5pole VB 1 WK 4..-5 07.255.4527.0 10		
			9pole VBS WK 4 E-9 07.256.4927.0 10			6pole VB 1 WK 4..-6 07.255.4627.0 10		
			10pole VBS WK 4 E-10 07.256.5027.0 10			7pole VB 1 WK 4..-7 07.255.4727.0 10		
			11pole VBS WK 4 E-11 07.256.5127.0 10			8pole VB 1 WK 4..-8 07.255.4827.0 10		
			12pole VBS WK 4 E-12 07.256.5227.0 10			9pole VB 1 WK 4..-9 07.255.4927.0 10		
						10pole VB 1 WK 4..-10 07.255.5027.0 10		
						11pole VB 1 WK 4..-11 07.255.5127.0 10		
						12pole VB 1 WK 4..-12 07.255.5227.0 10		
						70pole VB 1 WK 4.. M-70 07.255.4027.0 10		

selos



Test plug (test off the screw)

for WK 4 terminal blocks

with locking device and strain relief I

$I_{min} = 10 \text{ mA}$

$I_{max} = 3,5 \text{ A}$

$U_{nom} = 10 \text{ V}$

$U_{max} = 250 \text{ V} \sim 300 \text{ V} \dots$

Test plug with spring clamp connection

for WKF/WKC terminal blocks

PSWKC/F

012 - 1,5 mm² 013 - 2,5 mm² 400 V 2,5

Type	Part no.	Std. pack	Type	Part no.	Std. pack
1pole			1pole		
without contact pin	Z1.299.9253.0	10	5mm pitch		
			PSWKC/F	Z1.299.9753.0	
1pole			Blank for staggering terminals		
without contact pin			blocks	01.299.9753.0	
snap-on	Z1.299.9453.0	10	End plate and		
			partition for 6 mm pitch		
10pole without contact pins			ZP/AP PS	07.312.6053.0	10
with locking device and strain relief			One end plate per module is required for 6 mm pitch		
marked 1 - 10					
PST 10 WK 4	Z1.299.9553.0	10			
Contact pin	05.549.1200.0	1			
			jumpered with		
			at RM5	Z7.280.6227.0	
			to	Z7.280.7027.0	..
			at RM6	Z7.261.1227.0	
			to	Z7.261.2027.0	
			Screwdriver,		
			uninsulated	06.502.4000.0	
For marking systems see pages 178-179 and 200-202					

Marking accessories for DIN rail terminal blocks

selos

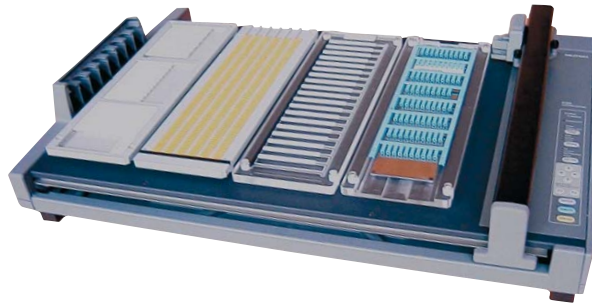

wiemarc

wieplot MUT

Type	Part no.	Std. pack	Type	Part no.	Std. pack
wiemarc CD	95.502.0501.0		wieplot MUT	95.502.0601.0	
Description			Description		
<p>wieplot MUT is a plotter system that uses wiemarc to interface with a PC, allowing custom printing on standard Wieland marking tags. These standard marking tags provide circuit identification for Wieland DIN rail mount terminal blocks, rectangular multipole connectors and WEB/WEG electronic housings.</p>			<p>wieplot MUT is a plotter system that uses wiemarc to interface with a PC, allowing custom printing on standard Wieland marking tags. These standard marking tags provide circuit identification for Wieland DIN rail mount terminal blocks, rectangular multipole connectors and WEB/WEG electronic housings.</p>		
Discription			Discription		
<p>wiemarc is a Windows® based plotter software (Windows 95/98/ME/NT/XP) that is able to drive the following plotter systems:</p> <ul style="list-style-type: none"> – wieplot MUT (Mutoh system) – Roland system <p>for custom printing on standard Wieland marking tags.</p>			<p>Standard template for all Wieland tags</p>		
<p>wiemarc makes preparing data for custom printing easier and faster than ever.</p> <p>Intuitive handling allows printing of marking tag cards in single, multipole and series marking jobs.</p> <p>Import of marking data from Excel files, text files and CAD/CAE programs is possible.</p> <p>wiemarc data file management is user-friendly as printing data can be stored and found very easily in the file library.</p> <p>wiemarc knows several special characters for electrical marking.</p> <p>wiemarc is able to mark tags with upward or downward series, series steps can be chosen as well as leading or following characters. Multipole line printing is possible depending on tag size, number of digits and type size. Automatic adaptation of type size according to tag size and number of digits.</p>			<p>Resolution: 0.025 mm</p> <p>Accuracy: +/- 0.1 mm</p> <p>Power supply: 50/60 Hz, 180 – 264 V, 90 – 132 V</p> <p>Automatic switch over from 110 V to 230 V</p> <p>Power rating: About 0.3 A for 220 V</p> <p>Approvals: UL-UL478 (REV .4) CSA-22.2 No. 220 and VDE EN 60 950</p> <p>Interference: FCC Class B FCC Part 15 and VDE Class B</p> <p>Dimensions: 620 mm x 425 mm x 106.5 mm</p> <p>Weight: 6.4 kg</p> <p>Interfaces: RS-232 C and parallel (Centronics)</p>		
Requirements:			Requirements:		
<p>Pentium II PC or compatible, min. 200 MHz or higher, 64 MByte RAM, CD-ROM Drive, VGA Grafic Adaptor and Monitor</p>					
<p>wiemarc supports Windows 95®, Windows 98®, Windows 2000®, Windows NT®, Windows ME® and Windows XP® Professional.</p>					



2.5 mm²/5 mm Width



4 mm²/6 mm Width



10 mm²/10 mm Width

16 mm²/12 mm Width

35 mm²/16 mm Width



Type	Part no.	Std. pack	Type	Part no.	Std. pack	Type	Part no.	Std. pack
Marking strips, unmarked			Marking strips, unmarked			10 mm²/10 mm Width		
9705 A/5/10	04.242.5053.0	25	9705 A/6/10	04.242.6053.0	25	marked for 5 blocks (every 2nd tag) *		
Marking strips, marked			Marking strips, marked			16 mm²/12 mm Width		
9705 A/5/9 B 1 - 9	04.842.4953.0	25	9705 A/6/9 B 1 - 9	04.842.5953.0	25	marked for 5 blocks (every 2nd tag) *		
9705 A/5/10 B*	04.842.5053.0	25	9705 A/6/10 B*	04.842.6053.0	25	16 mm²/12 mm Width		
9705 A/5/10 B 1 - 10	04.845.0153.0	25	9705 A/6/10 B 1 - 10	04.846.0153.0	25	marked for 5 blocks (every 2nd tag) *		
11 - 20	04.845.0253.0	25	11 - 20	04.846.0253.0	25	16 mm²/12 mm Width		
21 - 30	04.845.0353.0	25	21 - 30	04.846.0353.0	25	marked for 5 blocks (every 2nd tag) *		
31 - 40	04.845.0453.0	25	31 - 40	04.846.0453.0	25	16 mm²/12 mm Width		
41 - 50	04.845.0553.0	25	41 - 50	04.846.0553.0	25	marked for 5 blocks (every 2nd tag) *		
51 - 60	04.845.0653.0	25	51 - 60	04.846.0653.0	25	16 mm²/12 mm Width		
61 - 70	04.845.0753.0	25	61 - 70	04.846.0753.0	25	marked for 5 blocks (every 2nd tag) *		
71 - 80	04.845.0853.0	25	71 - 80	04.846.0853.0	25	16 mm²/12 mm Width		
81 - 90	04.845.0953.0	25	81 - 90	04.846.0953.0	25	marked for 5 blocks (every 2nd tag) *		
91 - 100	04.845.1053.0	25	91 - 100	04.846.1053.0	25	16 mm²/12 mm Width		
35 mm²/16 mm Width			35 mm²/16 mm Width			35 mm²/16 mm Width		
⊕ (10 x)	04.855.0053.0	25	⊕ (10 x)	04.856.0053.0	25	marked for 5 blocks (every 2nd tag) *		
± (10 x)	04.855.0153.0	25	± (10 x)	04.856.0153.0	25	35 mm²/16 mm Width		
+	04.855.0253.0	25	+	04.856.0253.0	25	marked for 5 blocks (every 2nd tag) *		
-	04.855.0353.0	25	-	04.856.0353.0	25	35 mm²/16 mm Width		
L1 (10 x)	04.855.0453.0	25	L1 (10 x)	04.856.0453.0	25	marked for 5 blocks (every 2nd tag) *		
L2 (10 x)	04.855.0553.0	25	L2 (10 x)	04.856.0553.0	25	35 mm²/16 mm Width		
L3 (10 x)	04.855.0653.0	25	L3 (10 x)	04.856.0653.0	25	marked for 5 blocks (every 2nd tag) *		
PE (10 x)	04.855.0753.0	25	PE (10 x)	04.856.0753.0	25	35 mm²/16 mm Width		
SL (10 x)	04.855.3153.0	25	SL (10 x)	04.856.3153.0	25	marked for 5 blocks (every 2nd tag) *		
N (10 x)	04.855.3253.0	25	N (10 x)	04.856.3253.0	25	35 mm²/16 mm Width		
F1 (10 x)	04.855.0953.0	25	F1 (10 x)	04.856.0953.0	25	marked for 5 blocks (every 2nd tag) *		
F2 (10 x)	04.855.1053.0	25	F2 (10 x)	04.856.1053.0	25	35 mm²/16 mm Width		
L1, L2, L3, N, PE (2 x)	04.855.0853.0	25	L1, L2, L3, N, PE (2 x)	04.856.0853.0	25	marked for 5 blocks (every 2nd tag) *		
with enlarged marking area			with enlarged marking area			35 mm²/16 mm Width		
9705 AL/5/10	04.242.5153.0	25	9705 AL/6/10	04.242.6353.0	25	marked for 5 blocks (every 2nd tag) *		
*Custom marking upon request			*Custom marking upon request			* indicate required marking with part no.		

Marking accessories for DIN rail terminal blocks

selos



Tear-off marking strip with 10 marking tags

Material: Polyamide 66/6 white, marking in black	Marking per strip	Type	Part no.	Stand. pack		
unmarked		9704 A	04.241.1150.0	25		
marked with the same number		9704 A/1 B	04.841.1150.0	25		
		9704 A/2 B	04.841.1250.0	25		
		9704 A/3 B	04.841.1350.0	25		
		9704 A/4 B	04.841.1450.0	25		
		9704 A/5 B	04.841.1550.0	25		
		9704 A/6 B	04.841.1650.0	25		
		9704 A/7 B	04.841.1750.0	25		
		9704 A/8 B	04.841.1850.0	25		
		9704 A/9 B	04.841.1950.0	25		
		9704 A/0 B	04.841.2050.0	25		
		marked with consecutive numbers		9704 A/1-0 B	04.841.2150.0	25
marked with the same symbols		9704 A/+ B	04.841.7450.0	25		
		9704 A/- B	04.841.7550.0	25		
		9704 A// B	04.841.7650.0	25		
		9704 A/. B	04.841.7750.0	25		
1 set of the same numbers = 10 x 25 strips = 2500 numbers	1 1 1 ... 0 0 0	A to Z (capital letters)	04.841.9050.0	1		
		1 set of capital letters = 26 x 25 strips = 6500 letters	A A A ... Z Z Z	a to z (small letters)	04.841.9150.0	1
		1 set of small letters = 26 x 25 strips = 6500 letters	a a a ... z z z		04.841.9250.0	1

DIN rail terminal blocks with screw clamp technology, type 9700 A.. S35

selos CLASSIC LINE



Standard terminal blocks

2.5 mm²
(12 AWG)



4 mm²
(10 AWG)



Feed-through blocks



Neutral disconnect blocks



Ground blocks



selos

10 mm²
(8 AWG)



16 mm²
(6 AWG)



25 mm²
(4 AWG)



35 mm²
(2 AWG)



PEN assembly block

35 mm²



DIN rail terminal blocks with screw clamp connection, type 9700 A.. S35

selos CLASSIC LINE

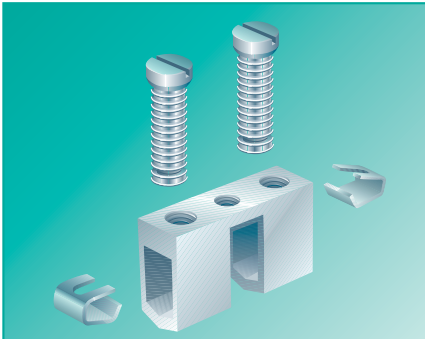

9700 A S35 offers...

- ☐ **Screw clamp technology**
made from nickel-plated copper alloy

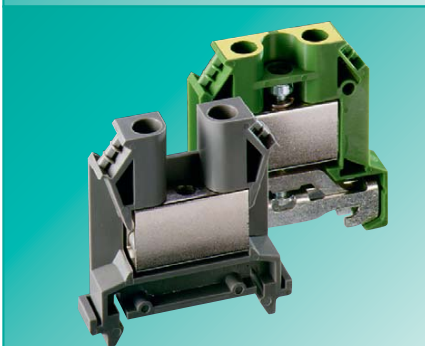

- ☐ **Connection range**
12-2 AWG

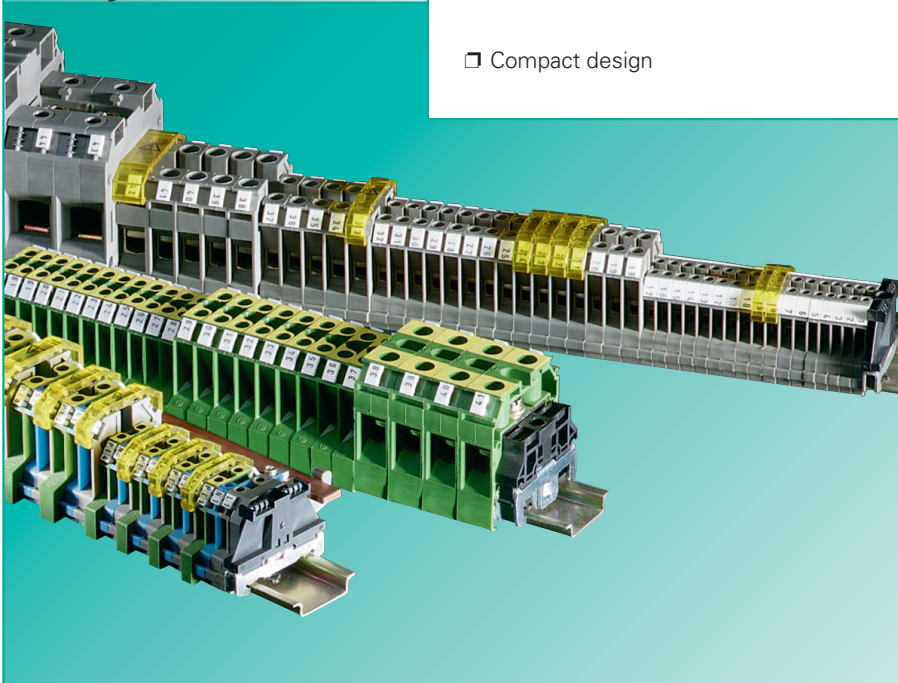

- ☐ **Compact design**

Application advantages

- Low contact resistance
 - Clamping body has similar physical and chemical characteristics as the conductor
 - One piece clamping body/current bar
- **Connection of Aluminum Conductors**
 - Clamping body is able to penetrate aluminium oxide
- **Steel free Clamping Body**
 - High corrosion resistance

- Wire gauge from 18-2 AWG solid, stranded and fine stranded conductors can be terminated without ferrules.

→ Save space on the rail

- **selos** Classic Line offers higher density due to the wire size and terminal block pitch.

Connection range	Pitch
12 AWG	5 mm
10 AWG	6 mm
8 AWG	8 mm
6 AWG	10 mm
4 AWG	12 mm
2 AWG	16 mm

→ **selos** CLASSIC LINE

- Mounting on TS 35 DIN Rail (DIN 60 715)
- Product range:
 - Feed-through terminals
 - Ground terminals
 - Neutral Bus terminals
 - PEN terminals

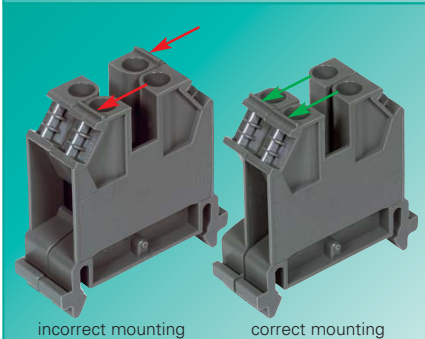

- ☐ **Function and Installation safety**

- Incorrect mounting indicator on the top of terminal
 - terminals mounted incorrectly are easily identified and fixed.

selos

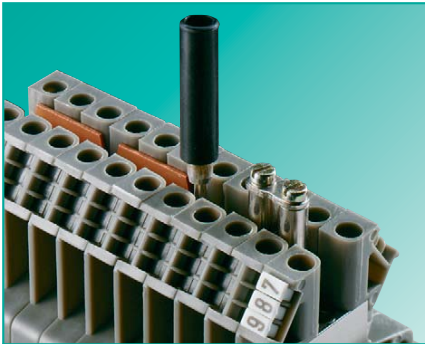

Test plugs and shorting plugs

- Test sockets which accept the test plugs and the shorting plugs are installed in the threaded slot on the carrying bar.
- Modular test plugs are available to create test plug modules greater than two poles.

Switchable connecting links (SCL)

- For easy commoning and disconnecting two terminals

Jumper bar

- Allow easy commoning of potential
- Available in pre-cut 2-6 pole versions
- Available in cut to length version in 50, 70, or 90 pole versions depending on the terminal block
- End plates and partitions are required to maintain creepage distances.



Marking systems

- Single marking tags in 5, 6, or 8mm pitch
- Marking strips (10 tags) to snap on 10 terminals at the same time
- Tear-off marking strips for marking up to 3 digits per terminal block
- Custom marking available upon request

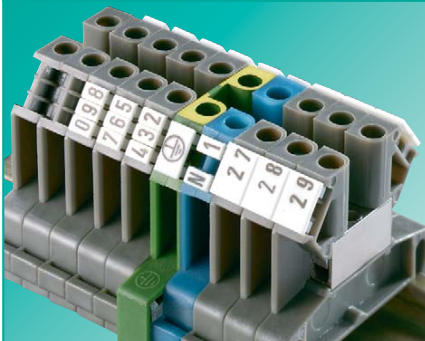

Cover with warning symbol

- For terminals that remain live after the mains have been switched off (VDE 0113)
- Can be removed with a screwdriver

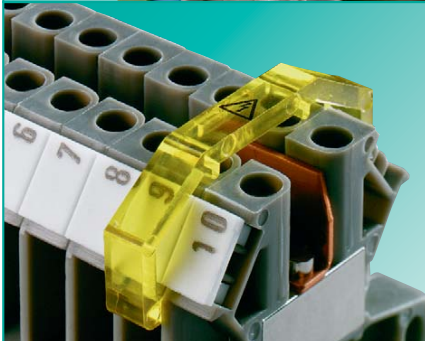

DQS certificates for all company divisions

- Quality standard as per DIN ISO 9001 in Development, Production, Assembly
- Continued control of the quality standard by means of regular internal and external quality audits
- Compatible with certificates of other countries:
 - BSI Certificate, Great Britain
 - SQS Certificate, Switzerland
 - Aib-Vincotte Certificate, Belgium
 - ÖQS Certificate, Austria

Material

Metal components

Special alloys and surface treatments offer low contact resistance and a gas tight connection

Clamping body: nickel plated copper alloy
Screws: nickel plated copper alloy

Jumper bar: copper
Test socket: copper alloy, plated
SCL: copper alloy

Insulation housing

Polyamide has excellent electrical, chemical and mechanical characteristics

Insulating housing: Polyamide 66/6
Tracking current resistance: CTI 600
Flammability class: UL 94 V-2

(also see section **facts & DATA**)

You can use our **wieplan** software to configure your own terminal block assemblies (see page 10/11).

Note:

The information regarding cross sectional area and connection types pertains to unprepared wires without ferrules.

The voltage ratings apply to the terminals in their intended application. When different products are mounted adjacent to each other, the proper isolation distances must be adhered to.

For this purpose, Wieland offers a large selection of appropriate accessories.

A detailed description of technical data, the standards' requirements, and the application conditions can be found in part **facts & DATA**.



DIN rail terminal blocks
with screw technology, type 9700 A.. S35

selos CLASSIC LINE

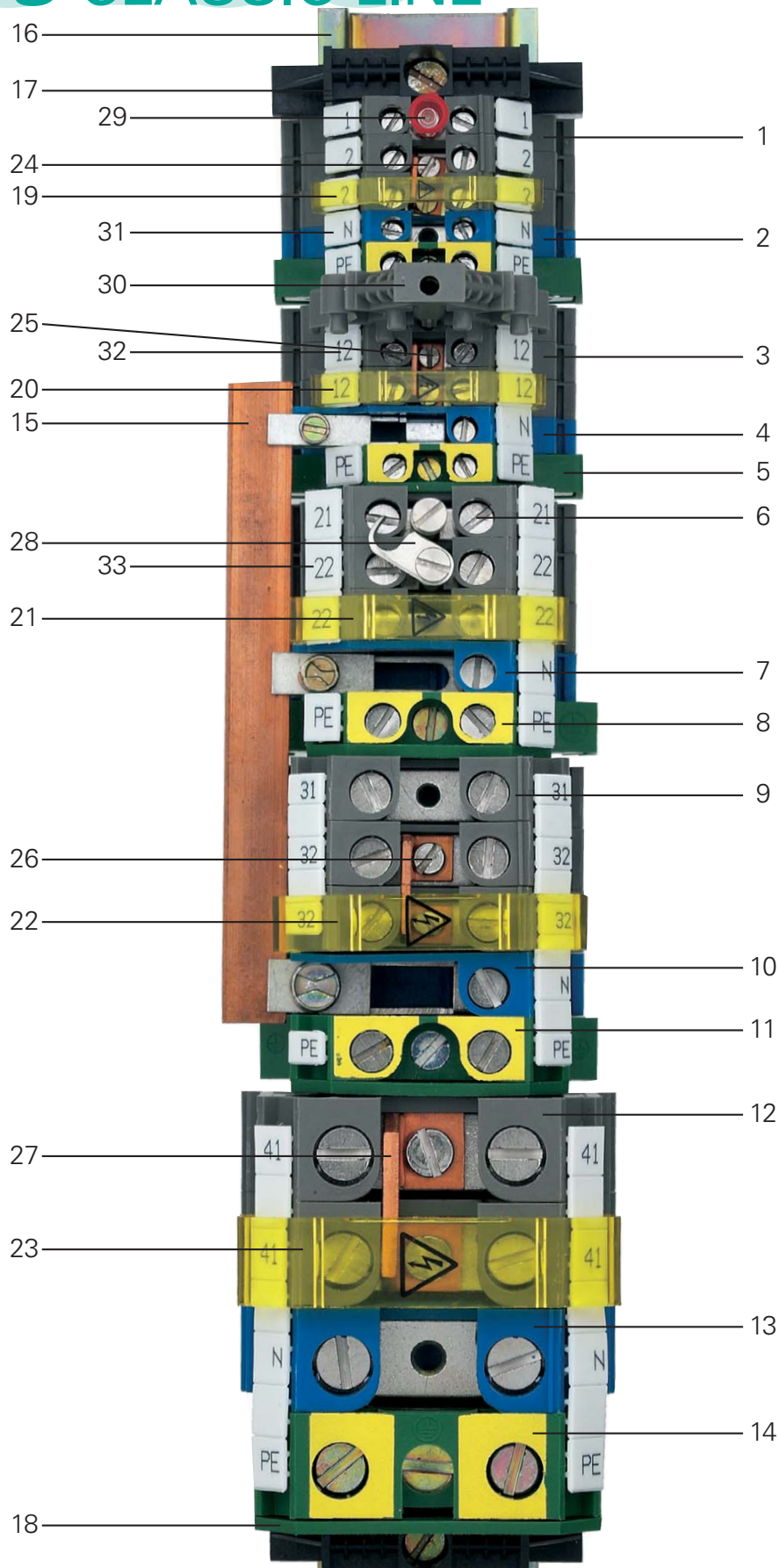

selos

Item	Description	Type	Part number
1	Feed through block	9700 A/5 S35	54.003.7553.0
2	Feed-through block, BLUE	9700 A/5 S35 BLAU	54.003.7553.6
3	Feed through block	9700 A/6 S35	54.004.7553.0
4	Neutral disconnect block	9700 A/6 ETK S35	54.004.7753.0
5	Ground block	9700 A/6 SL2 S35	56.004.9053.0
6	Feed through block	9700 A/8 S35	54.010.7553.0
7	Neutral disconnect block	9700 A/8 ETK S35	54.010.7753.0
8	Ground block	9700 A/8 SL2 S35	56.010.9053.0
9	Feed through block	9700 A/10 S35	54.016.7553.0
10	Neutral disconnect block	9700 A/10 ETK S35	54.016.7753.0
11	Ground block	9700 A/10 SL2 S35	56.016.9053.0
12	Feed through block	9700 A/16 S35	54.035.7553.0
13	Feed-through block, BLUE	9700 A/16 S35 BLAU	54.035.7553.6
14	Ground block	9700 A/16 SL2 S35	56.035.9053.0
15	Busbar 10x3	9813 M Sn	98.290.1000.0
16	Mounting rail	35 x 27 x 7,5	98.300.0000.0
17	End clamp for TS 35 with screw	9708/2 S35	Z5.522.8553.0
18	End plate, GREEN	9701/16 SL	07.312.0353.0
19	Warning cover	2,5 mm ²	04.325.1656.0
20	Warning cover	4 mm ²	04.325.1056.0
21	Warning cover	10 mm ²	04.325.1156.0
22	Warning cover	16 mm ²	04.325.1256.0
23	Warning cover	35 mm ²	04.325.1456.0
24	Cross connector with screws, uninsulated	9703/5-2	Z7.215.0227.0
25	Cross connector with screws, uninsulated	9703/6-2	Z7.211.0227.0
26	Cross connector with screws, uninsulated	9703/10-2	Z7.214.0227.0
27	Cross connector with screws, uninsulated	9703/16-2	Z7.216.0227.0
28	Switchable connecting link, complete	10 mm ²	Z7.269.3023.0
29	Test plug with insulated handle, Ø 2.3 mm	ST 2/2,3	Z5.553.2921.0
	Stud bolt	2,5 mm ²	05.508.8921.0
30	Test plug with locking lever		Z1.299.7153.0
31	Marking tag	9705 A	04.842.0850.0
32	Marking strip	9705 A/6/10 B	04.842.6053.0
33	Marking strip	9705 A/8/10 B	04.842.8053.0

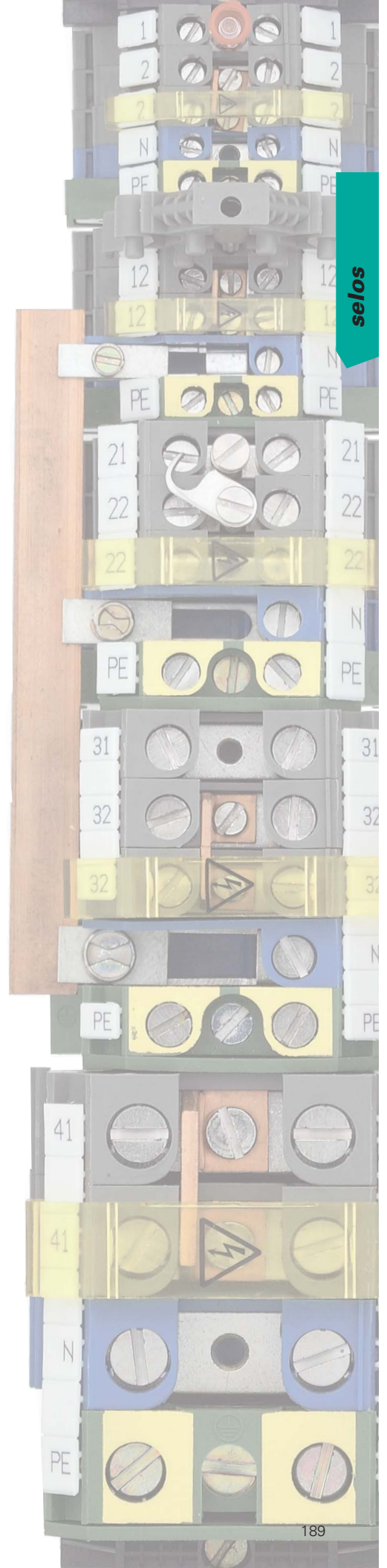

Feed-through blocks with screw connection, type 9700 A.. S35

selos CLASSIC LINE

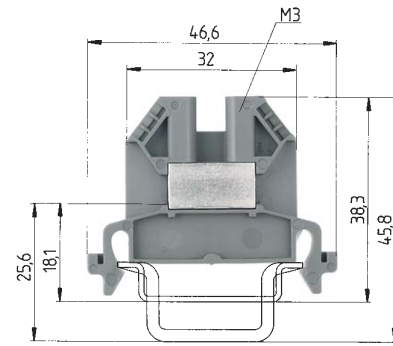
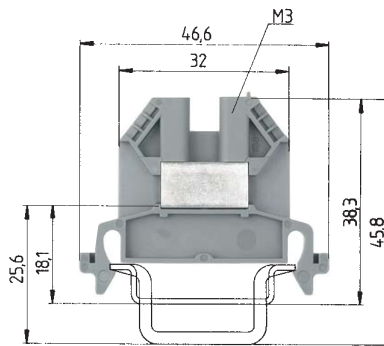

9700 A/5 S35

fine stranded	solid	V	A
0.5–2.5 mm ²	0.5–4 mm ²	800 V/8 kV/3	24
No. 18-12 AWG		600 V	20/30
No. 22-12 AWG		600 V	25
5 mm			9 mm



9700 A/6 S35

fine stranded	solid	V	A
0.5–4 mm ²	0.5–6 mm ²	800 V/8 kV/3	32
No. 18-10 AWG		600 V	30/30
No. 22-10 AWG		600 V	35
6 mm			9 mm



DIN VDE 0611 Teil 3/11.98

UL-ratings

CSA ratings

Width

Approvals

field/factory wiring

Wire strip length

	Type	Part no.	Std. pack	Type	Part no.	Std. pack
Feed-through terminal Color: gray	9700 A/5 S35	54.003.7553.0	100	9700 A/6 S35	54.004.7553.0	100
Feed-through terminal, (Ex)i Color: blue	9700 A/5 S35 BLAU	54.003.7553.6	100	9700 A/6 S35 BLAU	54.004.7553.6	100
Neutral disconnect block Color: blue						
Ground block Color: green-yellow						
PEN terminal Color: green/yellow - blue						
Accessories						
1. Mounting rail TS 35, DIN rail, 7.5 mm high L = 2 m	35 x 27 x 7,5 EN 60715	98.300.0000.0	1	35 x 27 x 7,5 EN 60715	98.300.0000.0	1
Mounting rail TS 35, DIN rail 15 mm high L = 2 m	35 x 27 x 15 EN 60715	98.360.0000.0	1	35 x 27 x 15 EN 60715	98.360.0000.0	1
2. End clamp TS 35, with screw 8 mm wide	9708/2 S35	Z5.522.8553.0	100	9708/2 S35	Z5.522.8553.0	100
3. End plate Color: gray	9701/6	07.310.3153.0	10	9701/6	07.310.3153.0	10
Color: blue	9701/6 BLAU	07.310.3153.6	10	9701/6 BLAU	07.310.3153.6	10
Color: green						
4. Partition plate Color: gray	9702/6	07.310.3453.0	10	9702/6	07.310.3453.0	10
Color: blue	9702/6 BLAU	07.310.3453.6	10	9702/6 BLAU	07.310.3453.6	10
5. Jumper bar with screws, 2pole	9703/5-2	Z7.215.0227.0	50	9703/6-2	Z7.211.0227.0	50
E-Cu, uninsulated 3pole	9703/5-3	Z7.215.0327.0	50	9703/6-3	Z7.211.0327.0	50
4pole	9703/5-4	Z7.215.0427.0	50	9703/6-4	Z7.211.0427.0	50
5pole	9703/5-5	Z7.215.0527.0	50	9703/6-5	Z7.211.0527.0	50
6pole	9703/5-6	Z7.215.0627.0	50	9703/6-6	Z7.211.0627.0	50
Cut-to-order strip 0.6 m long	9703/5-M	Z7.215.0027.0	10	9703/5-M	Z7.211.0027.0	10
6. Switchable connecting link		Z7.269.3523.0	50		Z7.269.2923.0	50
7. Stud bolt for test plug	9011 D	05.508.8921.0	10	9011 C	05.508.8821.0	10
8. Test plug	ST 2/2,3	Z5.553.2921.0	10	ST 2/2,3	Z5.553.2921.0	10
9. Cover with warn. symbol over 1 block Color: yellow		04.325.1656.0	10		04.325.1056.0	10
10. Busbar						
E-Cu, 10 x 3 mm, tin-plated, I _N = 140 A L = 1 m						
E-Cu, 10 x 3 mm, unplated, I _N = 140 A L = 1 m						
11. Connector clamps for busbar						
25 mm ² 11.1 mm wide						
35 mm ² 14.3 mm wide						
12. Busbar support 6 mm wide						
13. Rapid mounting tool		05.593.5853.0	10		05.593.4153.0	
For marking accessories see pages 178-179 and 200/202	*CL I, ZN1, AExe II			*CL I, ZN1, AExe II		

Feed-through blocks with screw connection, type 9700 A.. S35

selos CLASSIC LINE

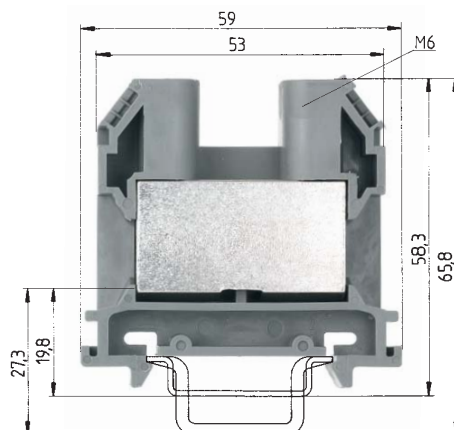

9700 A/16 S35

fine stranded	solid/stranded	V	A
2.5–35 mm ²	2.5–50 mm ²	800 V/8 kV/3	125
No. 12-2 AWG		600 V	115/130
No. 12-2 AWG		600 V	125
16 mm			20 mm

DIN VDE 0611 Teil 3/11.98

UL-ratings

CSA ratings

Width

Approvals

field/factory wiring

Wire strip length



	Type	Part no.	Std. pack
Feed-through block Color: gray	9700 A/16 S 35	54.035.7553.0	50
Feed-through block, (Ex)i Color: blue	9700 A/16 S 35 BLAU	54.035.7553.6	50
Neutral disconnect block Color: blue			
Ground block Color: green-yellow			
PEN terminal Color: green/yellow - blue			
Accessories			
1. Mounting rail TS 35, DIN rail, 7.5 mm high L = 2 m	35 x 27 x 7,5 EN 60715	98.300.0000.0	1
Mounting rail TS 35, DIN rail 15mm high L = 2 m	35 x 24 x 15 EN 60715	98.360.0000.0	1
2. End clamp for TS 35, with screw 8 mm wide	9708/2 S35	Z5.522.8553.0	100
3. End plate Color: gray	9701/12	07.310.3353.0	10
Color: blue	9701/12 BLAU	07.310.3353.6	10
Color: green			
4. Partition plate Color: gray	9702/12	07.310.3653.0	10
Color: blue	9702/12 BLAU	07.310.3653.6	10
5. Jumper bar with screws, 2pole	9703/16-2	Z7.216.0227.0	50
E-Cu, uninsulated 3pole	9703/16-3	Z7.216.0327.0	50
4pole	9703/16-4	Z7.216.0427.0	50
5pole	9703/16-5	Z7.216.0527.0	50
6pole	9703/16-6	Z7.216.0627.0	50
Cut-to-order strip 0.6 m long			
6. Switchable connecting link		Z7.269.3423.0	50
7. Stud bolt for test plug		05.508.6521.0	10
8. Test plug	ST 2/4	Z5.553.3021.0	10
9. Cover with warn. symbol over 1 block Color: yellow		04.325.1456.0	10
10. Busbar			
E-Cu, 10 x 3 mm, tin-plated, I _N = 140 A L = 1 m			
E-Cu, 10 x 3 mm, unplated, I _N = 140 A L = 1 m			
11. Connector clamps for busbar			
25 mm ² 11.1 mm wide			
35 mm ² 14.3 mm wide			
12. Busbar support 6 mm wide			
13. Rapid mounting tool			
For marking accessories see pages 178-179 and 200/202	*CL I, ZN1, AExe II		

selos

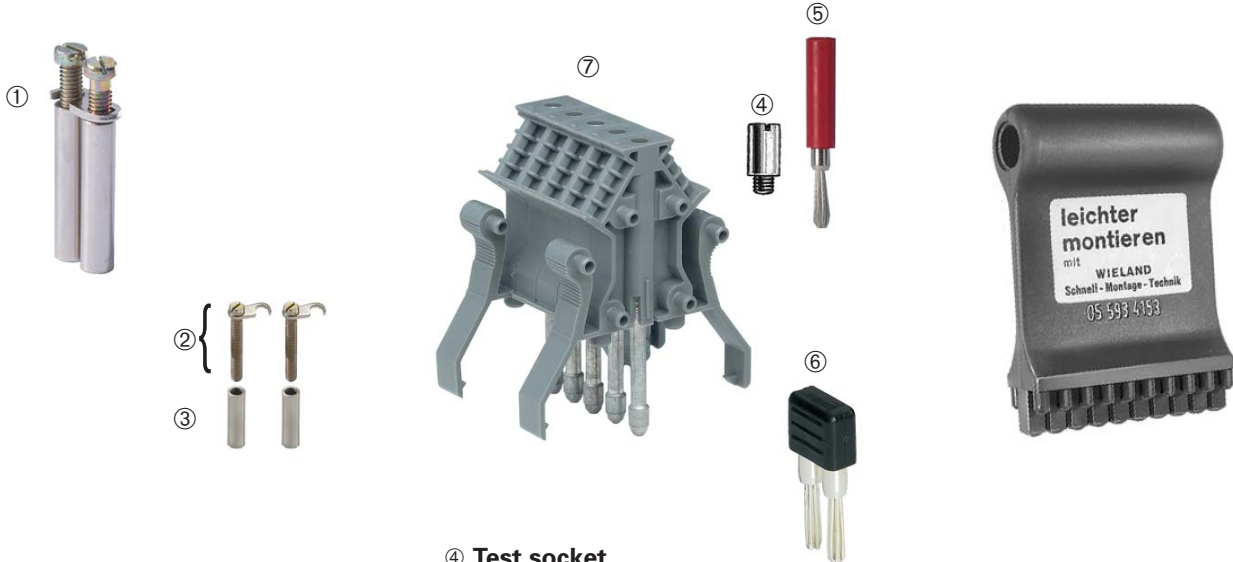

- ① Switchable connecting link
- ② Screws with link
- ③ Screw spacer

- ④ Test socket
- ⑤ Test plug with insulated handle
- ⑦ Shorting plug
- ⑥ Modular test plug

Rapid mounting tool

Type	Part no.	Std. pack	Type	Part no.	Std. pack	Type	Part no.	Std. pack
for terminal block type 9700 A/.. S 35			for terminal block type 9700 A/.. S 35			for terminal block type 9700 A/.. S 35		
Switchable connecting link			Test socket			Rapid mounting tool		
2,5 mm ²	Z7.269.3523.0	50	2,5 mm ²	05.508.8921.0	10	2,5 mm ²	05.593.5853.0	10
4 mm ²	Z7.269.2923.0	50	4 mm ²	05.508.8821.0	10	4 mm ²	05.593.4153.0	
10 mm ²	Z7.269.3023.0	50	10 mm ²	05.508.3221.0	10	10 mm ²	05.593.5953.0	10
16 mm ²	Z7.269.3123.0	50	16 mm ²	05.508.3121.0	10			
25 mm ²	Z7.269.3223.0	50	25 mm ²	05.508.6521.0	10			
35 mm ²	Z7.269.3423.0	50	35 mm ²	05.508.6521.0	10			
Switchable connecting link with screws			Test plug with insulated handle					
2,5 mm ²	Z7.269.2823.0	50	Ø 2,3 mm 2,5/4 mm ² red					
4 mm ²	Z7.269.0623.0	50	Ø 4 mm 10/16/25/35 mm ² black					
10 mm ²	Z7.269.0523.0	50	2,5 mm ²	Z5.553.2921.0	10			
16 mm ²	Z7.269.0723.0	50	4 mm ²	Z5.553.2921.0	10			
Threaded stud bolt (screw spacer)			10 mm ²	Z5.553.3021.0	10			
2,5 mm ²	05.508.8621.0	50	16 mm ²	Z5.553.3021.0	10			
4 mm ²	05.508.8621.0	50	25 mm ²	Z5.553.3021.0	10			
10 mm ²	05.508.8721.0	50	35 mm ²	Z5.553.3021.0	10			
16 mm ²	05.508.9721.0	50	Shorting plug					
			Z5.553.9400.0 100					
			For all 6 mm wide control cabinet terminal blocks, to be used together with stud bolts (part no. 05.508.8821)					
			Modular test plug					
			snap-on with locking lever for 9700 A 6/S 35					
			Z1.299.7153.0 10					
			Test plug					
			snap-on					
			Z1.299.8153.0 10					

Marking accessories for DIN rail terminal blocks

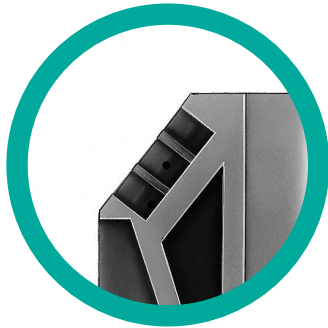

Material:
Polyamide 66/6
Color: black figures on white background

5 mm pitch

DIN rail terminal blocks with screw connection of series 97..., can take in marking tags on both sides on top of the block in a 3-chamber slot. It can be either 3 single number tags from the tear-off marking strip, or single tags, or marking strips.

- 1. Marking strips** marked and unmarked, made from Polyamide 66/6, suitable for 10 blocks in a row.
Marking 1-10, 11-20 etc. up to 991-999.
Type 9705 A/5/10 (5 mm spacing) for 5mm wide terminal blocks
Type 9705 A/6/10 (6 mm spacing) for 6 mm wide terminal blocks
Type 9705 A/8/10 (8 mm spacing) for 8 mm wide terminal blocks
Type 9705 A/5/10/5 B (10 mm spacing) for 10 mm wide terminal blocks
Type 9705 A/6/10/5 B (12 mm spacing) for 12 mm wide terminal blocks
Type 9705 A/8/10/5 B (16 mm spacing) for 16 mm wide terminal blocks

- 2. Tear-off marking strip** with 10 marking tags, made from Polyamide 66/6, white, marked and unmarked.

This marking system considerably reduces the time required for marking terminal block rows. For numerical marking of terminal block rows only 11 stock positions are required. As the time used for picking and attaching the tags is reduced, and as stockkeeping is low and the prices extremely favorable, enormous cost savings are the result from using these tear-off marking strips.

Type 9704 A...
(see page 180)

- 3. Single marking tag** made from white Polyamide 66/6, marked and unmarked.
Type 9705 A...

All terminal widths/pitch

Type	Part no.	Std. pack	Type	Part no.	Std. pack
Single marking tag, unmarked			Marking strips, unmarked		
9705 A	04.242.0850.0	500	9705 A/5/10	04.242.5053.0	25
Single marking tag, marked			Marking strips, marked		
9705 AB*	04.842.0850.0	500			
			9705 A/5/9 B	1 - 9	04.842.4953.0 25
			9705 A/5/10 B*		04.842.5053.0 25
			9705 A/5/10 B	1 - 10	04.845.0153.0 25
				11 - 20	04.845.0253.0 25
				21 - 30	04.845.0353.0 25
				31 - 40	04.845.0453.0 25
				41 - 50	04.845.0553.0 25
				51 - 60	04.845.0653.0 25
				61 - 70	04.845.0753.0 25
				71 - 80	04.845.0853.0 25
				81 - 90	04.845.0953.0 25
				91 - 100	04.845.1053.0 25
				⊕ (10 x)	04.855.0053.0 25
				± (10 x)	04.855.0153.0 25
				+	04.855.0253.0 25
				-	04.855.0353.0 25
				L1 (10 x)	04.855.0453.0 25
				L2 (10 x)	04.855.0553.0 25
				L3 (10 x)	04.855.0653.0 25
				PE (10 x)	04.855.0753.0 25
				SL (10 x)	04.855.3153.0 25
				N (10 x)	04.855.3253.0 25
				F1 (10 x)	04.855.0953.0 25
				F2 (10 x)	04.855.1053.0 25
				L1, L2, L3, N, PE (2 x)	04.855.0853.0 25
				with enlarged marking area	
				9705 AL/5/10	04.242.5153.0 25
*Custom marking upon request			* Custom marking upon request		



6 mm pitch



8 mm pitch



10 mm pitch

12 mm pitch



16 mm pitch

Type	Part no.	Std. pack	Type	Part no.	Std. pack	Type	Part no.	Std. pack
Marking strips, unmarked			Marking strips, unmarked			16 mm²/10 mm pitch		
9705 A/6/10	04.242.6053.0	25	9705 A/8/10	04.242.8053.0	25			
Marking strips, marked			Marking strips, marked			marked for 5 blocks (every 2nd tag) *		
9705 A/6/9 B 1 - 9	04.842.5953.0	25	9705 A/8/9 B 1 - 9	04.842.7953.0	25	9705 A/5/10/5 B	04.842.5553.0	25
9705 A/6/10 B*	04.842.6053.0	25	9705 A/8/10 B*	04.842.8053.0	25			
9705 A/6/10 B 1 - 10	04.846.0153.0	25	9705 A/8/10 B 1 - 10	04.848.0153.0	25			
11 - 20	04.846.0253.0	25	11 - 20	04.848.0253.0	25			
21 - 30	04.846.0353.0	25	21 - 30	04.848.0353.0	25	25 mm²/12 mm pitch		
31 - 40	04.846.0453.0	25	31 - 40	04.848.0453.0	25	marked for 5 blocks (every 2nd tag) *		
41 - 50	04.846.0553.0	25	41 - 50	04.848.0553.0	25	9705 A/6/10/5 B	04.842.6553.0	25
51 - 60	04.846.0653.0	25	51 - 60	04.848.0653.0	25			
61 - 70	04.846.0753.0	25	61 - 70	04.848.0753.0	25			
71 - 80	04.846.0853.0	25	71 - 80	04.848.0853.0	25			
81 - 90	04.846.0953.0	25	81 - 90	04.848.0953.0	25			
91 - 100	04.846.1053.0	25	91 - 100	04.848.1053.0	25			
						35 mm²/16 mm pitch		
⊕ (10 x)	04.856.0053.0	25	⊕ (10 x)	04.858.0053.0	25	marked for 5 blocks (every 2nd tag) *		
± (10 x)	04.856.0153.0	25	± (10 x)	04.858.0153.0	25	9705 A/8/10/5 B	04.842.8553.0	25
+ (10 x)	04.856.0253.0	25	+ (10 x)	04.858.0253.0	25			
- (10 x)	04.856.0353.0	25	- (10 x)	04.858.0353.0	25			
L1 (10 x)	04.856.0453.0	25	L1 (10 x)	04.858.0453.0	25			
L2 (10 x)	04.856.0553.0	25	L2 (10 x)	04.858.0553.0	25			
L3 (10 x)	04.856.0653.0	25	L3 (10 x)	04.858.0653.0	25			
PE (10 x)	04.856.0753.0	25	PE (10 x)	04.858.0753.0	25			
SL (10 x)	04.856.3153.0	25	SL (10 x)	04.858.3153.0	25			
N (10 x)	04.856.3253.0	25	N (10 x)	04.858.3253.0	25			
F1 (10 x)	04.856.0953.0	25	F1 (10 x)	04.858.0953.0	25			
F2 (10 x)	04.856.1053.0	25	F2 (10 x)	04.858.1053.0	25			
L1, L2, L3, N, PE (2 x)	04.856.0853.0	25	L1, L2, L3, N, PE (2 x)	04.858.0853.0	25			
with enlarged marking area								
9705 AL/6/10	04.242.6353.0	25						
* Custom marking upon request			*Custom marking upon request			* indicate required marking with part no.		

Marking accessories for DIN rail terminal blocks



Tear-off marking strip with 10 marking tags

Material: Polyamide 66/6 white, marking in black	Marking per strip	Type	Part no.	Stand. pack																																																																																																				
unmarked		9704 A	04.241.1150.0	25																																																																																																				
marked with the same number	 <table border="1"> <tr><td>1</td><td>1</td><td>1</td><td>1</td><td>1</td><td>1</td><td>1</td><td>1</td><td>1</td><td>1</td></tr> <tr><td>2</td><td>2</td><td>2</td><td>2</td><td>2</td><td>2</td><td>2</td><td>2</td><td>2</td><td>2</td></tr> <tr><td>3</td><td>3</td><td>3</td><td>3</td><td>3</td><td>3</td><td>3</td><td>3</td><td>3</td><td>3</td></tr> <tr><td>4</td><td>4</td><td>4</td><td>4</td><td>4</td><td>4</td><td>4</td><td>4</td><td>4</td><td>4</td></tr> <tr><td>5</td><td>5</td><td>5</td><td>5</td><td>5</td><td>5</td><td>5</td><td>5</td><td>5</td><td>5</td></tr> <tr><td>6</td><td>6</td><td>6</td><td>6</td><td>6</td><td>6</td><td>6</td><td>6</td><td>6</td><td>6</td></tr> <tr><td>7</td><td>7</td><td>7</td><td>7</td><td>7</td><td>7</td><td>7</td><td>7</td><td>7</td><td>7</td></tr> <tr><td>8</td><td>8</td><td>8</td><td>8</td><td>8</td><td>8</td><td>8</td><td>8</td><td>8</td><td>8</td></tr> <tr><td>9</td><td>9</td><td>9</td><td>9</td><td>9</td><td>9</td><td>9</td><td>9</td><td>9</td><td>9</td></tr> <tr><td>0</td><td>0</td><td>0</td><td>0</td><td>0</td><td>0</td><td>0</td><td>0</td><td>0</td><td>0</td></tr> </table>	1	1	1	1	1	1	1	1	1	1	2	2	2	2	2	2	2	2	2	2	3	3	3	3	3	3	3	3	3	3	4	4	4	4	4	4	4	4	4	4	5	5	5	5	5	5	5	5	5	5	6	6	6	6	6	6	6	6	6	6	7	7	7	7	7	7	7	7	7	7	8	8	8	8	8	8	8	8	8	8	9	9	9	9	9	9	9	9	9	9	0	0	0	0	0	0	0	0	0	0	9704 A/1 B 9704 A/2 B 9704 A/3 B 9704 A/4 B 9704 A/5 B 9704 A/6 B 9704 A/7 B 9704 A/8 B 9704 A/9 B 9704 A/0 B	04.841.1150.0 04.841.1250.0 04.841.1350.0 04.841.1450.0 04.841.1550.0 04.841.1650.0 04.841.1750.0 04.841.1850.0 04.841.1950.0 04.841.2050.0	25 25 25 25 25 25 25 25 25 25
1	1	1	1	1	1	1	1	1	1																																																																																															
2	2	2	2	2	2	2	2	2	2																																																																																															
3	3	3	3	3	3	3	3	3	3																																																																																															
4	4	4	4	4	4	4	4	4	4																																																																																															
5	5	5	5	5	5	5	5	5	5																																																																																															
6	6	6	6	6	6	6	6	6	6																																																																																															
7	7	7	7	7	7	7	7	7	7																																																																																															
8	8	8	8	8	8	8	8	8	8																																																																																															
9	9	9	9	9	9	9	9	9	9																																																																																															
0	0	0	0	0	0	0	0	0	0																																																																																															
marked with consecutive numbers	 <table border="1"> <tr><td>1</td><td>2</td><td>3</td><td>4</td><td>5</td><td>6</td><td>7</td><td>8</td><td>9</td><td>0</td></tr> </table>	1	2	3	4	5	6	7	8	9	0	9704 A/1-0 B	04.841.2150.0	25																																																																																										
1	2	3	4	5	6	7	8	9	0																																																																																															
marked with the same symbols	<table border="1"> <tr><td>+</td><td>+</td><td>+</td><td>+</td><td>+</td><td>+</td><td>+</td><td>+</td><td>+</td><td>+</td></tr> <tr><td>-</td><td>-</td><td>-</td><td>-</td><td>-</td><td>-</td><td>-</td><td>-</td><td>-</td><td>-</td></tr> <tr><td>/</td><td>/</td><td>/</td><td>/</td><td>/</td><td>/</td><td>/</td><td>/</td><td>/</td><td>/</td></tr> <tr><td>.</td><td>.</td><td>.</td><td>.</td><td>.</td><td>.</td><td>.</td><td>.</td><td>.</td><td>.</td></tr> </table>	+	+	+	+	+	+	+	+	+	+	-	-	-	-	-	-	-	-	-	-	/	/	/	/	/	/	/	/	/	/	9704 A/+ B 9704 A/- B 9704 A// B 9704 A/. B	04.841.7450.0 04.841.7550.0 04.841.7650.0 04.841.7750.0	25 25 25 25																																																												
+	+	+	+	+	+	+	+	+	+																																																																																															
-	-	-	-	-	-	-	-	-	-																																																																																															
/	/	/	/	/	/	/	/	/	/																																																																																															
.																																																																																															
1 set of the same numbers = 10 x 25 strips = 2500 numbers 1 set of capital letters = 26 x 25 strips = 6500 letters 1 set of small letters = 26 x 25 strips = 6500 letters	<table border="1"> <tr><td>1</td><td>1</td><td>1</td><td>...</td><td>0</td><td>0</td><td>0</td></tr> <tr><td>A</td><td>A</td><td>A</td><td>...</td><td>Z</td><td>Z</td><td>Z</td></tr> <tr><td>a</td><td>a</td><td>a</td><td>...</td><td>z</td><td>z</td><td>z</td></tr> </table>	1	1	1	...	0	0	0	A	A	A	...	Z	Z	Z	a	a	a	...	z	z	z	A to Z (capital letters) a to z (small letters)	04.841.9050.0 04.841.9150.0 04.841.9250.0	1 1 1																																																																															
1	1	1	...	0	0	0																																																																																																		
A	A	A	...	Z	Z	Z																																																																																																		
a	a	a	...	z	z	z																																																																																																		

TOP system selos

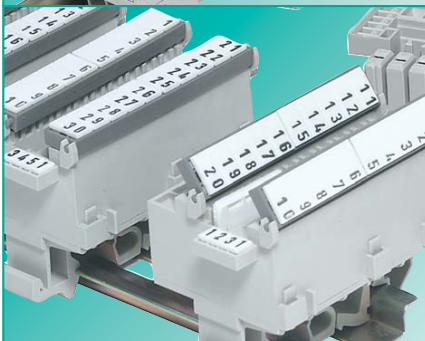
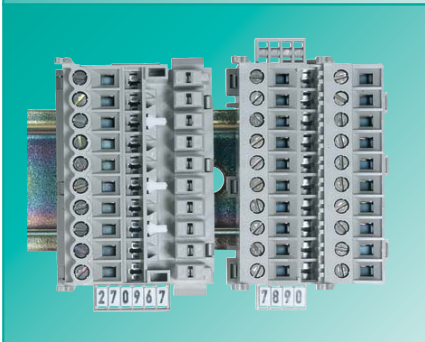
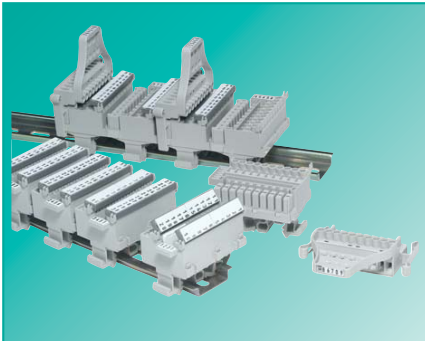

The TOP system offers

- Terminal block module based on narrow pitch of 5mm
- Top-System allows wire entry and screwdriver access in the same plane

Universal mounting foot for

- TS 35 mm DIN rail to EN 60715
 - TS 32 mm DIN rail to EN 60715
- Feed-through terminals located in the center

Materials:

Insulating housing: Polyamide 66/6
Clamping body / clamping screws: steel, zinc-plated and dichromated
Current Carrying Bar: Tin-plated copper alloy

TOP plug system

Accepts 10 pole plug-able connector

Coding capability: 28 coding configurations

Plug-able connector with locking levers

Strain relief

Top-system standard

10 pole feed through terminal block module

Orientation perpendicular to the mounting rail

Pitch/width is only 39 mm for 10 terminals

Screw technology

Marking tag system

- Snap in marking tag carrier
- Marking facility for module
- Marking system uses Wieland standard tags
- Module is molded with marking 1-10

Potential commoning

- Insulated plug-in jumper bars (2-10 pole)

Application advantages

- Save space in the panel – up to 40%
- Ease of inserting and terminating the conductor

- Easy mounting, secure attachment on all types of DIN rail

- Due to its excellent electrical, chemical and mechanical properties
- Low contact resistance
- Each terminal can be marked individually

Ease of use

Clean and neat wiring

Plug-able connector cannot be mismatched

Plug-able connector provides a safe connection which locks in place

Strain relief with cable ties via holes on the marking late

Ease of use

Clean and neat wiring

Secure connection

- Mark every termination point
- Mark modules individually

→ Reduces Inventory

→ Quick and easy installation (no screws)

→ Increased safety due to tough safe design

Busbar components

selos

Insulating housing: Polyamide
 66/6 - tracking resistant
 Clamping body: nickel-plated brass
 Wire protection: phosphor bronze
 Clamping screws: steel,
 zinc-plated and dichromated

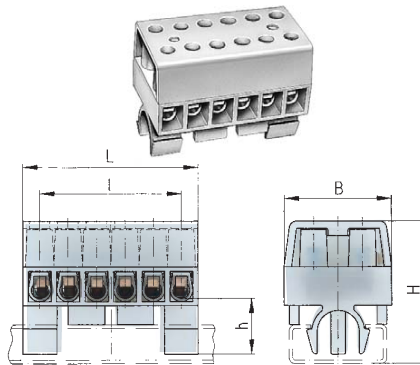

	L	I	H	h	B
4 mm ²	35.9	5 x 5.8 = 29	29	14	20
16 mm ²	64.5	5 x 10.5 = 52.5	36	14	27.5

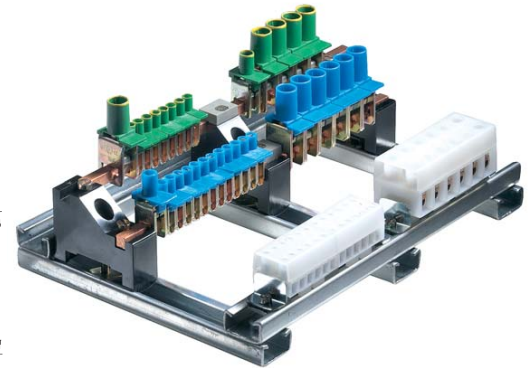

Complete sheet-steel distribution systems in accordance with IEC 61 984 and VDE 0108 can be assembled using these components. The widths of the terminals are chosen so that it is easy to identify which terminal is allocated to each individual circuit and so that they match the spacing of the miniature circuit breakers. The PE and N busbar (E-Cu 6 x 6mm) are attached to the busbar mounting brackets. The bare supply and distribution board terminals are pushed onto 6 x 6mm busbars. The PE busbar is attached to the top connection of the bracket and N busbar to the bottom one. The insulate terminals for the phase connections are pushed into the perforated rail from the top. For identifying the individual poles of the isolated terminals, marker strips are available in rolls numbered in sequences from 1 to 99 for AC circuits and from 101 for DC circuits.

DIN VDE 0110

V
 500 V/6 kV/3

A

Approvals



	Type	Part no.	Std. pack
Terminal block (up to 10 AWG)	KL28/6DSPA	33.011.0653.0	50
Terminal block (up to 4 AWG)	KL29/6DSPA	33.041.0653.0	20
Accessories for N and PE distribution terminals			
1. PE and N rail carrier with sliding nut			
2. Spacer for separating busbars			
3. Slotted mounting rail			
4. End clamp, 9mm wide			
5. Sliding nut			
6. Jumper bar, insulated for KL28	2pole	IVBIK4-2	Z7.255.0227.0 10
	3pole	IVBIK4-3	Z7.255.0327.0 10
	to 6pole	IVBIK4-6	Z7.255.0627.0 10
7. Marking strip rolls, 60 m each			
for KL 28 and terminal blocks 1-99 Distance			
between figures: 6 mm		04.007.1080.0	1
for KL 29 and terminal block 1-55 Distance			
between figures: 10.8 mm		04.007.3080.0	1

Modular N and PE distributor terminals

selos

Material:
Insulated Housing:
Polyamide 66/6

Metal parts:
Steel, zinc plated
dichromated

Bus bar distribution terminals
with plastic cover, screw turret,
screw break point, and marking
ledge.

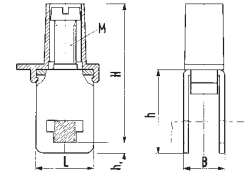
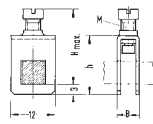
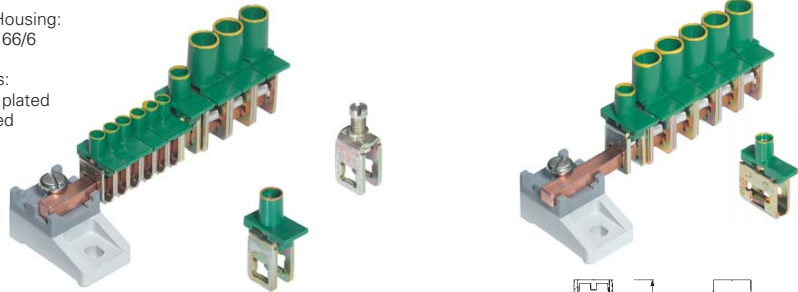

	H	h	M	B
4 mm ²	23.6	16	M3.5	6.0
16 mm ²	30.8	20.2	M5	9.5

	H	h	h ₁	L	M	B
4 mm ²	26	16	3	12	M3.5	6,0
16 mm ²	33.5	20.2	3	12	M5	10,7
25 mm ²	41.5	23.1	2.8	16	M6	11.5
35 mm ²	44	25.2	2.8	16	M6	14.3

EN 60998-2-1

Approvals

Ⓢ CCA/CH

Ⓢ CCA/CH

	Type	Part no.	Std. pack	Type	Part no.	Std. pack
Distribution terminal 4 mm ²	WAK4/1	30.494.0010.0	250	WAK4/3	30.494.0110.0	250
Distribution N terminal 4 mm ² Cap: blue	WAK4/1 bl	30.494.0010.6	500	WAK4/3 bl	30.494.0110.6	500
Distribution PE terminal 4 mm ² Cap: green-yellow	WAK4/1 gr-gb	30.494.0010.7	500	WAK4/3 gr-gb	30.494.0110.7	500
Distribution terminal 16 mm ²	WAK16/1	30.494.1010.0	250			
Distribution N terminal 16 mm ² Cap: blue	WAK16/1 bl	30.494.1010.6	250			
Distribution PE terminal 16 mm ² Cap: green-yellow	WAK16/1 gr-gb	30.494.1010.7	250			
Distribution terminal 25 mm ²				WAK25/3	30.494.1110.0	100
Distribution N terminal 25 mm ² Cap: blue				WAK25/3 bl	30.494.1110.6	100
Distribution PE terminal 25 mm ² Cap: green-yellow				WAK25/3 gr-gb	30.494.1110.7	100
Distribution terminal 35 mm ²				WAK35/3	30.494.2510.0	100
Distribution N terminal 35 mm ² Cap: blue				WAK35/3 bl	30.494.2510.6	100
Distribution PE terminal 35 mm ² Cap: green-yellow				WAK35/3 gr-gb	30.494.2510.7	100
Neutral conductor rail 15x3 mm I _N =140A L = 1 m with DIN 85 screws and lock washers						
without screws and washers						
Distributor with busbar 6 x 6 mm accord. to A802						
Accessories						
1. Rail carrier base	KS011/1ZKR	19.230.0040.0	65	KS011/1ZKR	19.230.0040.0	65
2. Busbar 6 x 6 mm E-Cu I _N =140A L = 2 m		98.320.0000.0	1		98.320.0000.0	1
3. Busbar 6 x 6 mm E-Cu I _N =140A L = 1 m		98.325.1000.0	1		98.325.1000.0	1
4. Busbar 10 x 3 mm E-Cu I _N =140A L = 1 m					98.290.0000.0	1
Marking stip rolls, 60 m each						
for KL 28 and terminal blocks 1-99 Distance between figures: 6 mm		04.007.1080.0	1		04.007.1080.0	1
for KL 29 and terminal blocks 1-55 Distance between figures: 10.8 mm		04.007.3080.0	1		04.007.3080.0	1

selos



IDC DIN rail terminal blocks, type WKC

taris

IDC connection for:

Standard DIN rail terminal blocks

Duo terminal blocks

Multi-tier terminal blocks

Disconnect blocks

taris connects copper wires **easily, fast** and **safely**

taris for TS 35

- no wire stripping, no ferrules
- no special tools - a screwdriver is all you need
- 60 % time savings = reduced costs
- low packing density (5 mm wide)
- optical control of the switching state
- cross sections up to 1.0 mm² and 2.5 mm²

All Wieland Components which require **CE** general certification are **CE** certified, and identified with the **CE** logo.



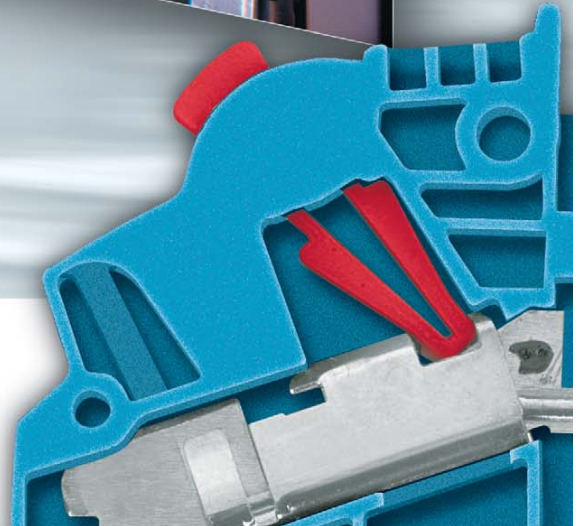

IDC DIN rail terminal blocks type WKC





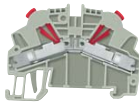
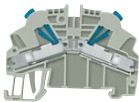
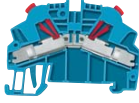

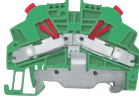
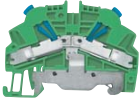
IDC DIN rail terminal blocks, type WKC

taris



	1.0 mm²	2.5 mm²	taris
Feed-through blocks			
Neutral feed-through blocks			
Ground blocks			

Standard DIN rail terminal blocks



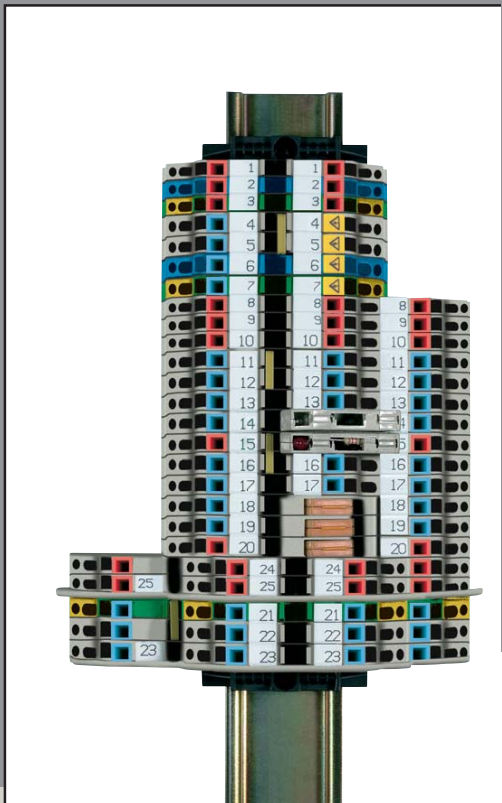

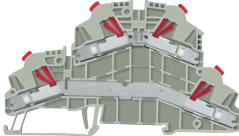
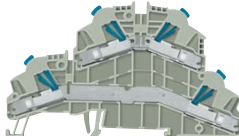

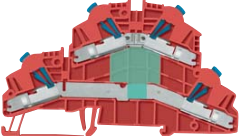
	1.0 mm²	2.5 mm²	taris
Feed through blocks			
Ground blocks			



Hybrid DIN rail terminal blocks

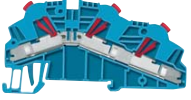

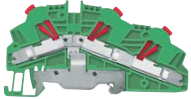



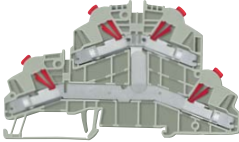
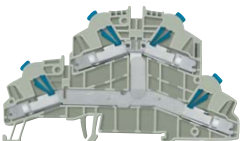
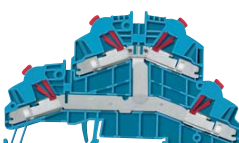
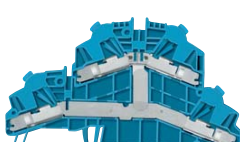

	1.0 mm²	2.5 mm²	taris
Double-tier block			
Double-tier blocks as function blocks, possible diode switches upon request			
			

Double-tier blocks

	1.0 mm ²	2.5 mm ²	
Feed-through blocks			Duo 1/2
Neutral feed-through blocks			
Ground blocks			

	1.0 mm ²	2.5 mm ²	
Feed-through blocks			Duo 2/2
Neutral feed-through blocks			
Ground blocks			

Duo DIN rail terminal blocks

	1.0 mm ²	2.5 mm ²	
Knife edge disconnect blocks			taris
Disconnect blocks with fuse plug			
Disconnect blocks with diode plug			

Disconnect blocks

IDC DIN rail terminal blocks

type **WKC**

taris

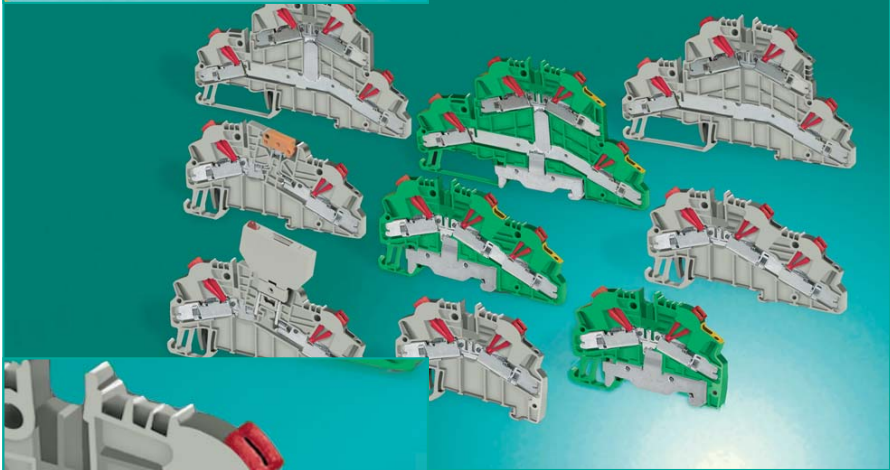
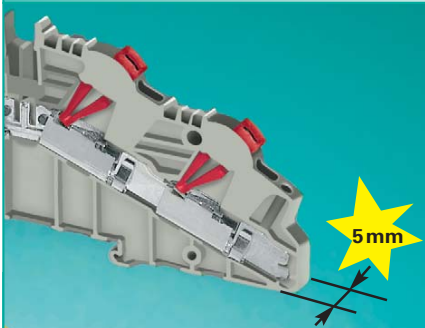
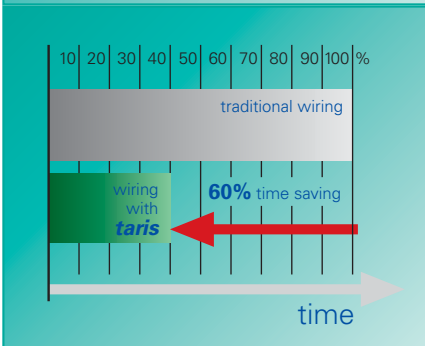
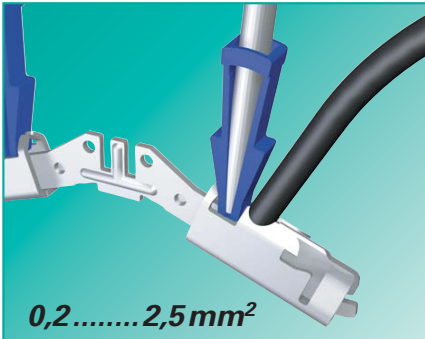

taris technology

Wieland's **taris** (WKC) Series represents the industry's most comprehensive line of advanced IDC (insulation displacement contact) technology terminal blocks. The superior design of the **taris** IDC contact system reduces wiring installation time and labor, especially in high volume wiring applications. **taris** IDC terminal blocks are suitable for applications in automated equipment and machine tools, packaging and material handling machinery, railway/mass transit systems, petrochemical, and any applications requiring high-volume interconnects for low-voltage control and signal circuitry where labor cost reduction and ease of assembly is a goal.

taris features

- The industry's narrowest blocks at just 5 mm and 6 mm wide
- Operates with a standard screwdriver
- Dual jumpering slots
- Built-In test points
- Contact design moves the clamp to engage the wire
- Top-entry system puts the wire entry and the screwdriver access in the same plane
- Tin-plated copper alloy contact material
- UL 94-VO non-flammability rating on the polyamide 66/6 insulation material

benefits

- uses less space in the cabinet
- No special tools required
- Flexibility in commoning potentials of adjacent blocks
- Provide true measurement reading without removing wires
- Ensures secure, gas-tight and vibration-resistant connection even when the wire length is maxed out
- Easy circuit identification and troubleshooting
- Corrosion resistant connection
- Increased safety
- Easy installation even in confined spaces

WKC series terminal block versions

- taris** is designed for long-term use under demanding conditions
- Feed-through
- Ground
- Disconnect
- Fuse
- Arc suppression
- Reverse polarity protection
- 1-in, 2-out feed-through
- 1-in, 2-out ground
- Double-tier feed-through
- Double-tier ground
- Voltage indication

taris

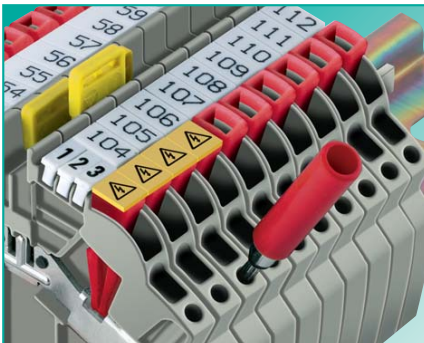

Test plug

- All **taris** IDC DIN rail terminal blocks feature built in test points so that measuring values can be taken without removing the wire.
- Entry guides on each side of the blocks permit measuring with standard 2.3 mm test probes and test plugs for easy maintenance and trouble-shooting

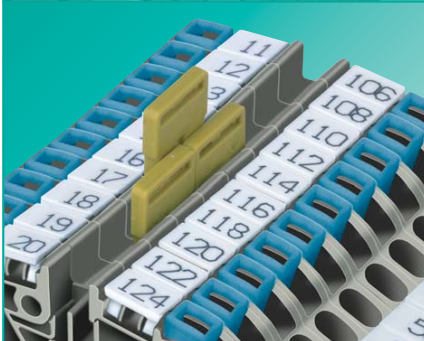

Cross connection

- IVB WKF insulated cross connectors offer complete protection from shock-hazard per EN 60352-3/4 and EN 60947-7-1.
- Partition plates between neighboring cross connections are not necessary to meet creepage requirements.
- IVB WKF cross connectors bear the same rated current as the terminal block



Marking facilities

- single marking tags
- Snap=On marking strips
- Tear-off marking strips
- Custom marking options

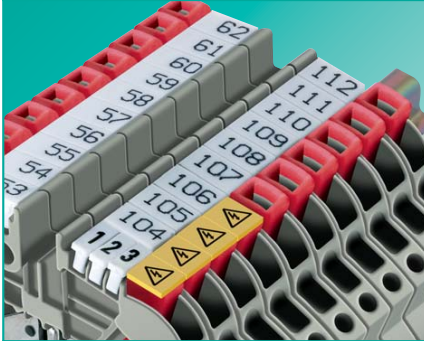

ADC warning cover

- taris** offers a Snap-On cover with the ADC warning symbol to prevent tampering of blocks which remain live after the system is switched off. A tool is required to remove the cover for added safety.

DQS certificates for all products

- Quality standard as per DIN ISO 9001 in Development, Production, Assembly
- Continued control of the quality standard by means of regular internal and external quality audits
- Compatible with certificates of other countries:
 - BSI Certificate, Great Britain
 - SQS Certificate, Switzerland
 - Aib-Vincotte Certificate, Belgium
 - ÖQS Certificate, Austria

taris material

- taris** utilizes special alloys and surface treatments to provide low contact resistance and a high degree of protection from corrosion. **taris** material composition makes it suitable for use under extreme conditions and guarantees a long-term stable connection.

taris metal compositions

- clamping body and current bar constructed of tin-plated copper
- ground foot is constructed of tin-plated brass

taris insulating housing compositions

- housings are constructed of polyamide 6.6 for its excellent mechanical, electrical and chemical properties
 - UL 94-VO non-flammability rating, the best in the industry
- (see also section **facts & DATA**)

Our **wieplan** software helps to plan your DIN rail terminal block assemblies (see page 10/11).

Note

The information regarding cross-sectional areas and connection types pertains to wires without ferrules. Ferrules are not necessary for secure connection.

The voltage ratings apply to the terminals in their intended application. When different products are mounted adjacent to each other, the proper isolation distances must be adhered to. For this purpose, **Wieland** offers a large selection of appropriate accessories.

A detailed description of technical data, the standards requirements, and the application conditions can be found in catalog section **facts & DATA**.



Concept

taris

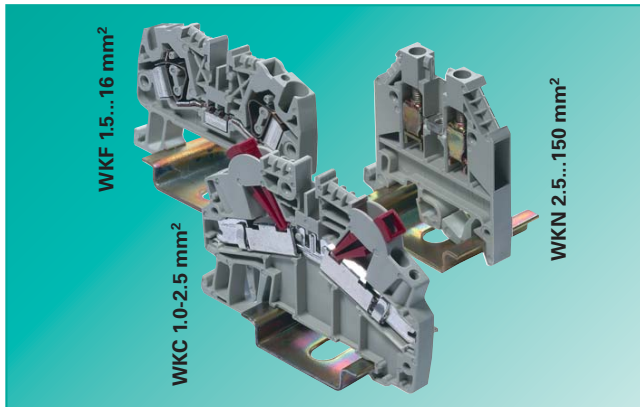

taris

With the addition of **taris** IDC terminal blocks, Wieland now offers the broadest range of screw clamp, spring clamp, and IDC technology, to provide the best possible connection for any control cabinet application. At just 5mm and 6mm wide, the **taris** series includes the industry's narrowest IDC block capable of accepting 14 AWG. Like other Wieland products, **taris** is designed with superior function and quality in mind, thereby offering the most features and benefits of any terminal block on the market. To lower production costs or reduce installation and maintenance time, Wieland's **taris** WKC series terminal blocks offer the connection technology you need.

The 2-second connection

Terminating copper wires is easy, fast and safe with **taris**.

- **Easy** – Cut the wire to length and insert into the wire entry guide. Move the clamping body into the wire by inserting and levering a standard flat screwdriver
- **Fast** – There is no prep time with **taris** - no wire stripping and no ferruling. **taris** reduces installation time by as much as 60%.
- **Safe** – the wire does not move during the operation - no risk of losing the wires. No live parts are able to be touched due to the design of the insulating housing. Jumpers are insulated as well.

taris makes disconnecting wires just as easy, fast and safe.

- It is possible to re-use spliced wires with **taris** by cutting the end of the wire before each new/re-termination
- After connecting a larger wire, a smaller diameter wire can be connected to the same contact.

A color-coded screwdriver guide indicates the rated cross section of the terminal block:

- WKC 1 30-18 AWG red indicator
- WKC 2.5 18-14 AWG blue indicator

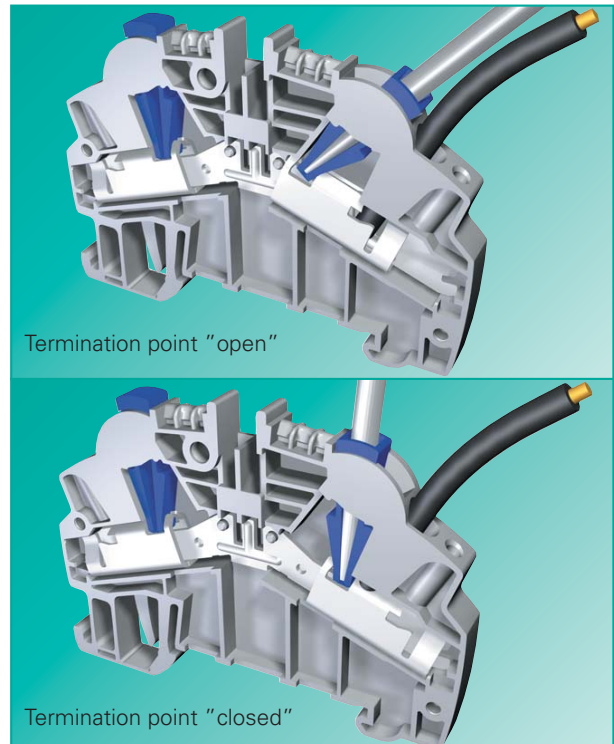

Wire specifications

taris terminates solid or fine stranded copper wires with AWG between 24 and 14 with two size of terminal blocks.

WKC ...1 : copper wire between AWG 24-18; 5mm wide terminal block
WKC ...2,5: copper wire between AWG 18-14; 6mm wide terminal block

Standard control wire with PVC- and PE- insulation can be terminated

Wire with other insulation material can also be terminated, please consult Wieland for recommendation

For fine stranded copper wires, the wire diameter must be a minimum of 0.2mm. the composition of conductors is based on DIN VDE 0295

K1, 1-5.

taris

Wire connection

Insert the wire into the clamping body through the wire entry guide. Insert a flat screwdriver into the colored screwdriver guide and push the screwdriver forward to move the clamping body into the wire. This action cuts into the insulation of the wire at two defined points with proper contact and no damage to the copper wire. The result is a gas tight, vibration and corrosion resistant contact.

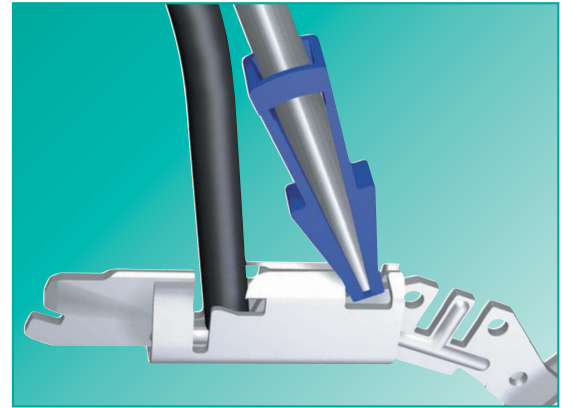

taris

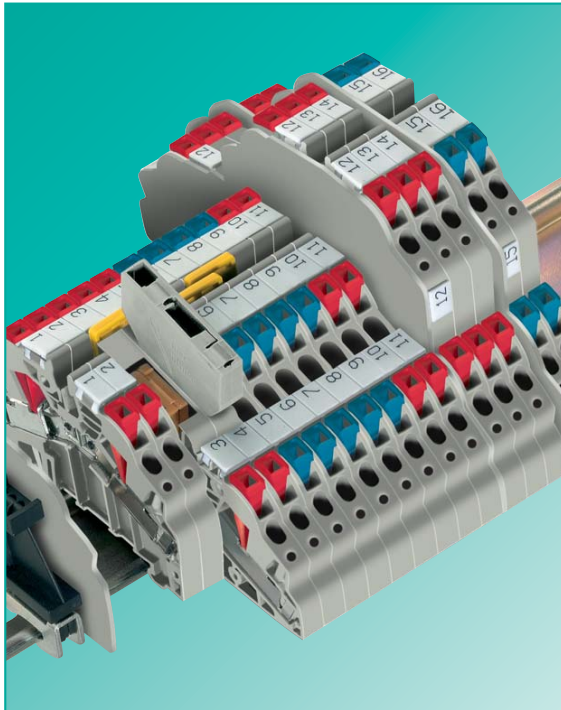

The **taris** series

For various application requirements, **taris** offers a variety of terminal blocks in two different ranges of AWG cross sections. Both cross sections have the same contour outside for a clean symmetrical look along the DIN rail.

Standard terminals

- DIN rail terminal blocks as feed-through and ground blocks with one termination point on each side of the terminal block
- DIN rail terminal blocks with two jumpering slots provide flexibility in commoning potentials
- DIN rail terminal blocks with marking facilities on every termination point
- DIN rail terminal blocks with test points for test probes on every termination point

Duo terminals

- Duo DIN rail terminal blocks with more than two termination points for one potential
- Duo DIN rail terminal blocks as feed-through and ground blocks in D 1/2 and D2/2 version
- Duo DIN rail terminal blocks D 1/2 can be jumpered with the standard DIN rail terminal blocks

Disconnect terminals

- as knife edge disconnect blocks or disconnect blocks for diode or fuse plugs
- can be jumpered with standard or Duo 1/2 DIN rail terminals.

Double-deck rail terminals

- double-tier blocks with same contour as Duo 2/2 blocks.
- double-tier blocks as function block for diode switchings

Accessories

- **taris** utilizes Wieland's standard marking system
- **taris** utilizes the same insulated cross connectors as Wieland's WKF series spring clamp connection technology for potential commoning.
- For more complex connections, **taris** uses the disconnect block with fuse plug SIST or diode plug DIST for WK or WKF series.
- For visual separation of terminal block groups, **taris** offers partitions and end plates, which also maintain shock-hazard protection.
- **taris** features built-in test points which accommodate Wieland test plugs or test probes from standard meters for way maintenance and trouble-shooting.

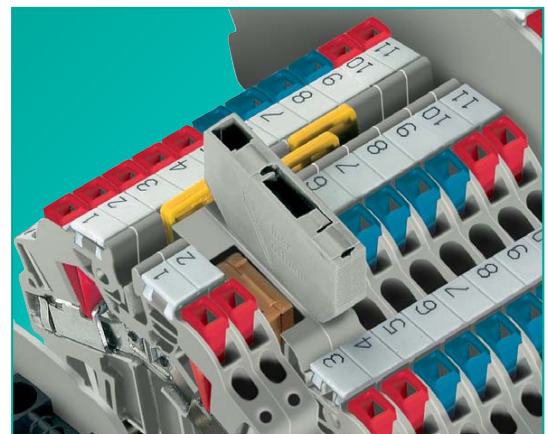

IDC DIN rail terminal blocks,
type WKC
taris

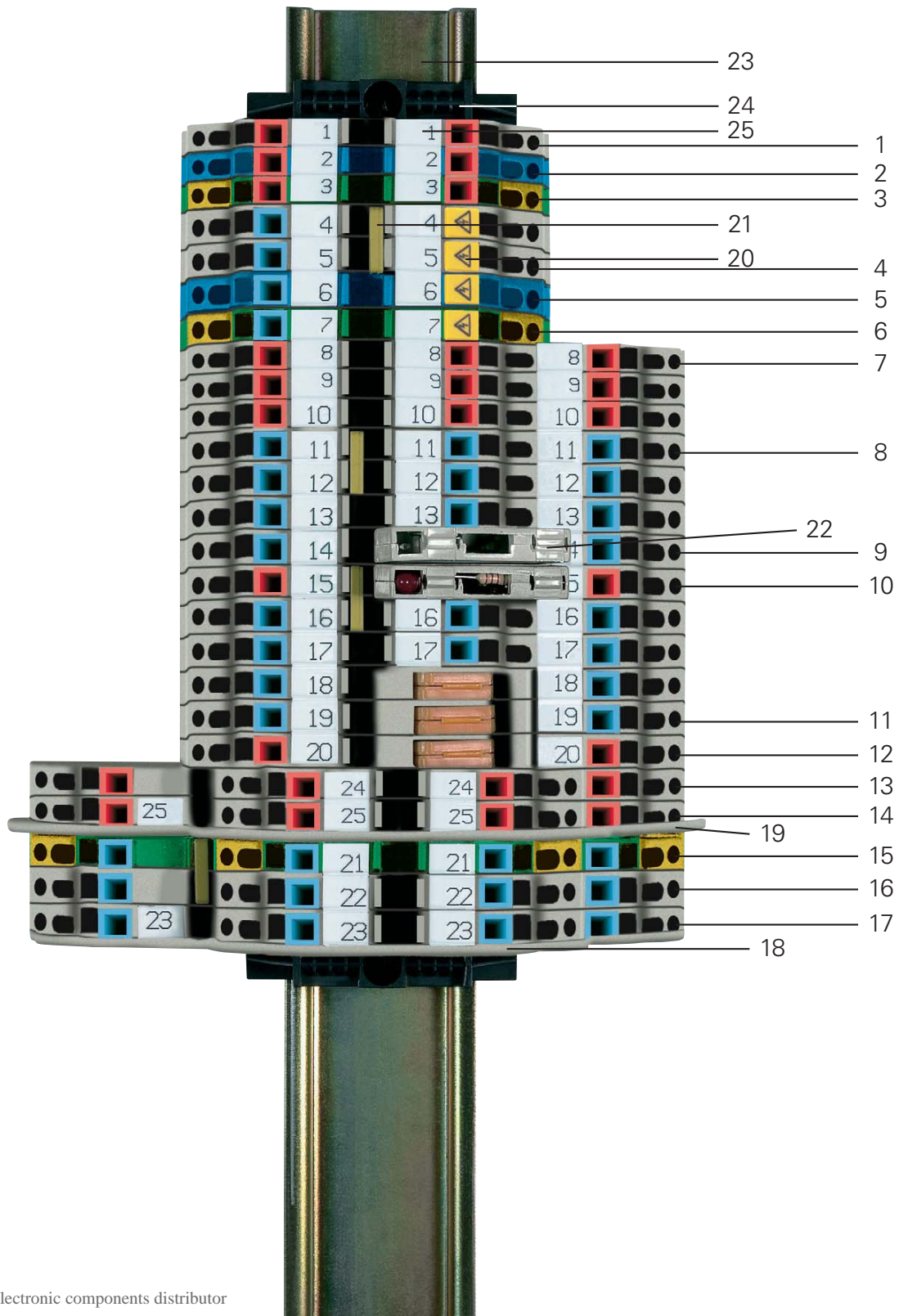

taris sample rail

taris

Pos.	Description	Type	Part no.
1	Feed-through block	WKC 1/35	56.301.0053.0
2	Feed-through block, blue	WKC 1/35 BLAU	56.301.0053.6
3	Ground block	WKC 1 SL/35	56.301.9053.0
4	Feed-through block	WKC 2,5/35	56.303.0053.0
5	Feed-through block, blue	WKC 2,5/35 BLAU	56.303.0053.6
6	Ground block	WKC 2,5 SL/35	56.303.9053.0
7	Duo feed-through block	WKC 1 D1/2/35	56.301.5053.0
8	Duo feed-through block	WKC 2,5 D1/2/35	56.303.5053.0
9	Disconnect block	WKC 2,5 TKG/35	56.303.4053.0
10	Disconnect block	WKC 1 TKG/35	56.301.4053.0
11	Knife edge disconnect block	WKC 2,5 TKM/35	56.303.2053.0
12	Knife edge disconnect block	WKC 1 TKM/35	56.301.2053.0
13	Duo feed-through block	WKC 1 D2/2/35	56.301.5153.0
14	Double-tier block	WKC 1 E/35	56.301.7053.0
15	Duo-ground block	WKC 2,5 D2/2/SL/35	56.303.9153.0
16	Duo-feed-through block	WKC 2,5 D2/2/35	56.303.5153.0
17	Double-tier block	WKC 2,5 E/35	56.303.7053.0
18	End plate	APC 1-2,5 D2./E.	07.312.5453.0
19	Partition plate	TWC 1-2,5 D2./E.	07.312.5553.0
20	Cover with warning symbol	ADC 2,5 GELB	04.344.0353.8
21	Jumper bar, insulated	IVB WKF 4-2	Z7.261.1227.0
22	Fuse plug (G 5x20)	SIST	Z1.299.4053.0
23	Mounting rail	35x27x7,5 EN 60715	98.300.0000.0
24	End clamp	9708/2 S35	Z5.522.8553.0
25	Marking strips	9705 A/5/10 B	04.842.5053.0

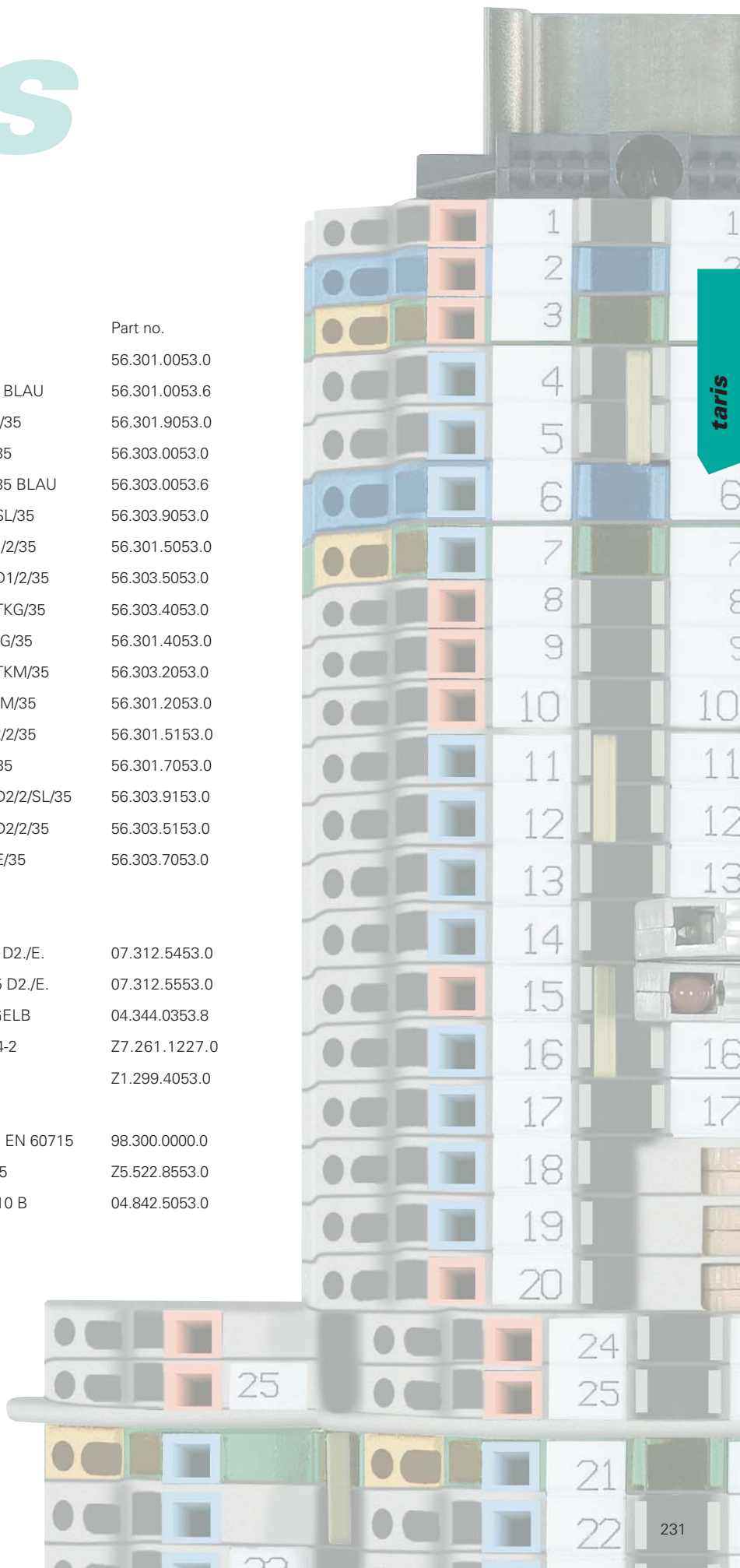

IDC feed-through blocks, type WKC

taris

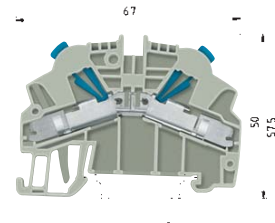
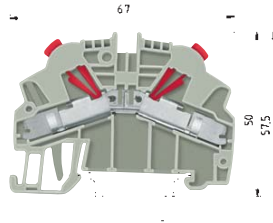

WKC 1/35

fine stranded	solid	V	A
0.2 – 1 mm ²	0.2 – 1 mm ²	800 V/8 kV/3	13.5
No. 30-18 AWG		600 V	13
No. 24-18 AWG		600 V	13
Width	Rated cross section	5 mm	1 mm ²



WKC 2.5/35

fine stranded	solid	V	A
1 – 2.5 mm ²	1 – 2.5 mm ²	800 V/8 kV/3	24
No. 18-14 AWG		600 V	22
No. 16-14 AWG		600 V	20
Width	Rated cross section	6 mm	2.5 mm ²



EN 60 947-7-1

UL ratings

CSA ratings

Width

Approvals

Rated cross section

		Type	Part no.	Std. pack	Type	Part no.	Std. pack
Feed-through block	Color: gray	WKC 1/35	56.301.0053.0	100	WKC 2,5/35	56.303.0053.0	100
Feed-through block	Color: blue	WKC 1/35 BLAU	56.301.0053.6	100	WKC 2,5/35 BLAU	56.303.0053.6	100
Accessories							
1. Mounting rail 35, 7.5 mm high	L = 2 m	35 x 27 x 7,5 EN 60715	98.300.0000.0	1	35 x 27 x 7,5 EN 60715	98.300.0000.0	1
Mounting rail 35, 15 mm high	L = 2 m	35 x 24 x 15 EN 60715	98.360.0000.0	1	35 x 24 x 15 EN 60715	98.360.0000.0	1
2. End clamp for TS 35	8 mm wide	9708/2 S 35	Z5.522.8553.0	100	9708/2 S 35	Z5.522.8553.0	100
End clamp for TS 35, screwless	8 mm wide	WEF 1/35	Z5.523.9353.0	100	WEF 1/35	Z5.523.9353.0	100
3. End plate	Color: gray	APC 1-2,5	07.312.5053.0	10	APC 1-2,5	07.312.5053.0	10
	Color: blue	APC 1-2,5 BLAU	07.312.5053.6	10	APC 1-2,5 BLAU	07.312.5053.6	10
	Color: green						
4. Partition plate	Color: gray	TWC 1-2,5	07.312.5153.0	10	TWC 1-2,5	07.312.5153.0	10
	Color: blue	TWC 1-2,5 BLAU	07.312.5153.6	10	TWC 1-2,5 BLAU	07.312.5153.6	10
5. Jumper bar,	2pole	IVB WKF 2,5-2	Z7.280.6227.0	10	IVB WKF 4-2	Z7.261.1227.0	10
insulated	3pole	IVB WKF 2,5-3	Z7.280.6327.0	10	IVB WKF 4-3	Z7.261.1327.0	10
	4pole	IVB WKF 2,5-4	Z7.280.6427.0	10	IVB WKF 4-4	Z7.261.1427.0	10
	5pole	IVB WKF 2,5-5	Z7.280.6527.0	10	IVB WKF 4-5	Z7.261.1527.0	10
	6pole	IVB WKF 2,5-6	Z7.280.6627.0	10	IVB WKF 4-6	Z7.261.1627.0	10
	7pole	IVB WKF 2,5-7	Z7.280.6727.0	20	IVB WKF 4-7	Z7.261.1727.0	20
	8pole	IVB WKF 2,5-8	Z7.280.6827.0	20	IVB WKF 4-8	Z7.261.1827.0	20
	9pole	IVB WKF 2,5-9	Z7.280.6927.0	20	IVB WKF 4-9	Z7.261.1927.0	20
	10pole*	IVB WKF 2,5-10	Z7.280.7027.0	20	IVB WKF 4-10	Z7.261.2027.0	20
6. Cover w. warning symbol over 4 blocks		ADC 1 GELB	04.344.0153.8	10	ADC 2,5 GELB	04.344.0353.8	10
7. Test plug		WK 2,5 ST 2/2,3	Z5.553.2921.0	10	WK 2,5 ST 2/2,3	Z5.553.2921.0	10
8. Screw driver, uninsulated		DIN 5264 B 0,6 x 3,5	06.502.4000.0	5	DIN 5264 B 0,6 x 3,5	06.502.4000.0	5
*Available up to 20 pole		* CL I, ZN1, AExe II			* CL I, ZN1, AExe II		
Marking accessories also see page 178-179 and 250-251		**CL I, ZN1, Exe II			**CL I, ZN1, Exe II		

IDC duo feed-through blocks, type WKC

taris

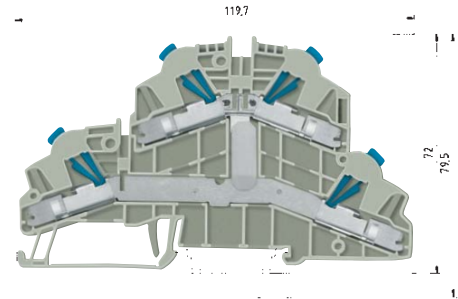
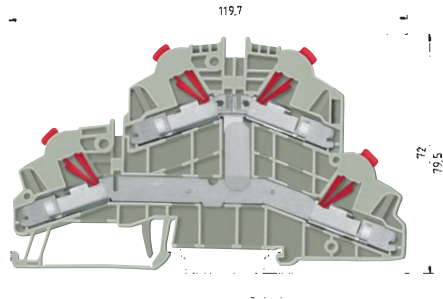

WKC 1 D2/2/35

fine stranded	solid	V	A
0.2 – 1 mm ²	0.2 – 1 mm ²	500 V/6 kV/3	13.5
No. 30-18 AWG		600 V	13
No. 24-18 AWG		300/600 V*	13
Width	Rated cross section	5 mm	1 mm ²

WKC 2.5 D2/2/35

fine stranded	solid	V	A
1 – 2.5 mm ²	1 – 2.5 mm ²	500 V/6 kV/3	24
No. 18-14 AWG		600 V	22
No. 16-14 AWG		360/600 V*	20
Width	Rated cross section	6 mm	2.5 mm ²

EN 60 947-7-1

UL ratings

CSA ratings

Width

Approvals

Rated cross section

Duo feed-through block		Type	Part no.	Std. pack	Duo feed-through block		Type	Part no.	Std. pack
Color: gray		WKC 1 D2/2/35	56.301.5153.0	50	Color: blue		WKC 2,5 D2/2/35	56.303.5153.0	50
Color: blue		WKC 1 D2/2/35 BLAU	56.301.5153.6	50	Color: blue		WKC 2,5 D2/2/35 BLAU	56.303.5153.6	50
Accessories									
1. Mounting rail 35, 7.5 mm high	L = 2 m	35 x 27 x 7,5 EN 60715	98.300.0000.0	1	35 x 27 x 7,5 EN 60715	98.300.0000.0	1		
Mounting rail 35, 15 mm high	L = 2 m	35 x 24 x 15 EN 60715	98.360.0000.0	1	35 x 24 x 15 EN 60715	98.360.0000.0	1		
2. End clamp for TS 35	8 mm wide	9708/2 S 35	Z5.522.8553.0	100	9708/2 S 35	Z5.522.8553.0	100		
End clamp for TS 35, screwless	8 mm wide	WEF 1/35	Z5.523.9353.0	100	WEF 1/35	Z5.523.9353.0	100		
3. End plate	Color: gray	APC 1-2,5 D2./E.	07.312.5453.0	10	APC 1-2,5 D2./E.	07.312.5453.0	10		
	Color: blue	APC 1-2,5 D2./E. BLAU	07.312.5453.6	10	APC 1-2,5 D2./E. BLAU	07.312.5453.6	10		
	Color: green								
4. Partition plate	Color: gray	TWC 1-2,5 D2./E.	07.312.5553.0	10	TWC 1-2,5 D2./E.	07.312.5553.0	10		
	Color: blue	TWC 1-2,5 D2./E. BLAU	07.312.5553.6	10	TWC 1-2,5 D2./E. BLAU	07.312.5553.6	10		
5. Cross connector,	2pole	IVB WKF 2,5-2	Z7.280.6227.0	10	IVB WKF 4-2	Z7.261.1227.0	10		
insulated	3pole	IVB WKF 2,5-3	Z7.280.6327.0	10	IVB WKF 4-3	Z7.261.1327.0	10		
	4pole	IVB WKF 2,5-4	Z7.280.6427.0	10	IVB WKF 4-4	Z7.261.1427.0	10		
	5pole	IVB WKF 2,5-5	Z7.280.6527.0	10	IVB WKF 4-5	Z7.261.1527.0	10		
	6pole	IVB WKF 2,5-6	Z7.280.6627.0	10	IVB WKF 4-6	Z7.261.1627.0	10		
	7pole	IVB WKF 2,5-7	Z7.280.6727.0	20	IVB WKF 4-7	Z7.261.1727.0	20		
	8pole	IVB WKF 2,5-8	Z7.280.6827.0	20	IVB WKF 4-8	Z7.261.1827.0	20		
	9pole	IVB WKF 2,5-9	Z7.280.6927.0	20	IVB WKF 4-9	Z7.261.1927.0	20		
	10pole	IVB WKF 2,5-10	Z7.280.7027.0	20	IVB WKF 4-10	Z7.261.2027.0	20		
6. Cover w. warning symbol over 4 blocks		ADC 1 GELB	04.344.0153.8	10	ADC 2,5 GELB	04.344.0353.8	10		
7. Test plug		WK 2,5 ST 2/2,3	Z5.553.2921.0	10	WK 2,5 ST 2/2,3	Z5.553.2921.0	10		
8. Screw driver, uninsulated		DIN 5264 B 0,6 x 3,5	06.502.4000.0	5	DIN 5264 B 0,6 x 3,5	06.502.4000.0	5		
*300 V for use group C					*300 V for use group C				
600 V for use group D, E					*600 V for use group D, E				
* CL I, ZN1, AExe II					* CL I, ZN1, AExe II				
**CL I, ZN1, Exe II					**CL I, ZN1, Exe II				

IDC double-tier blocks, type WKC

taris

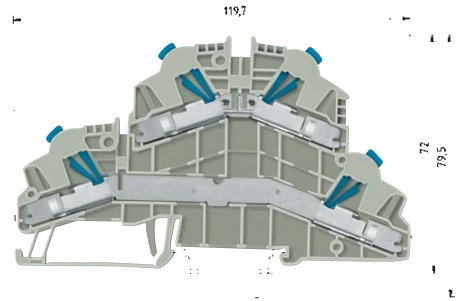
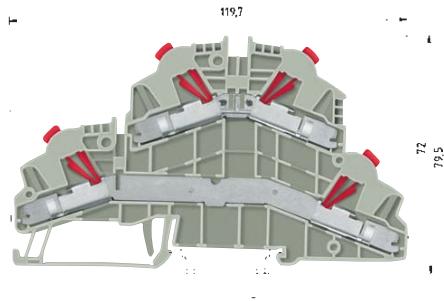

WKC 1 E/35

fine stranded	solid	V	A
0.2 – 1 mm ²	0.2 – 1 mm ²	500 V/6 kV/3	13.5
No. 30-18 AWG		600 V	13
No. 24-18 AWG		300/600 V**	13
5 mm	Rated cross section	1 mm ²	

WKC 2.5 E/35

fine stranded	solid	V	A
1 – 2.5 mm ²	1 – 2.5 mm ²	500 V/6 kV/3	24
No. 18-14 AWG		600 V	22
No. 16-14 AWG		300/600 V**	20
6 mm	Rated cross section	2.5 mm ²	

EN 60 947-7-1

UL ratings

CSA ratings

Width

Approvals

Rated cross section



		Type	Part no.	Std. pack	Type	Part no.	Std. pack	
Double-tier block	Color: gray	WKC 1 E/35	56.301.7053.0	50	WKC 2,5 E/35	56.303.7053.0	50	
Double-tier block	Color: blue	WKC 1 E/35	56.301.7053.6		WKC 2,5 E/35	56.303.7053.6		
Accessories								
1. Mounting rail 35, 7.5 mm high	L = 2 m	35 x 27 x 7,5 EN 60715	98.300.0000.0	1	35 x 27 x 7,5 EN 60715	98.300.0000.0	1	
Mounting rail 35, 15 mm high	L = 2 m	35 x 24 x 15 EN 60715	98.360.0000.0	1	35 x 24 x 15 EN 60715	98.360.0000.0	1	
2. End clamp for TS 35	8 mm wide	9708/2 S 35	Z5.522.8553.0	100	9708/2 S 35	Z5.522.8553.0	100	
End clamp for TS 35, screwless	8 mm wide	WEF 1/35	Z5.523.9353.0	100	WEF 1/35	Z5.523.9353.0	100	
3. End plate	Color: gray	APC 1-2,5 D2./E.	07.312.5453.0	10	APC 1-2,5 D2./E.	07.312.5453.0	10	
	Color: blue	APC 1-2,5 D2./E. BLAU	07.312.5453.6	10	APC 1-2,5 D2./E. BLAU	07.312.5453.6	10	
	Color: green							
4. Partition plate	Color: gray	TWC 1-2,5 D2./E.	07.312.5553.0	10	TWC 1-2,5 D2./E.	07.312.5553.0	10	
	Color: blue	TWC 1-2,5 D2./E. BLAU	07.312.5553.6	10	TWC 1-2,5 D2./E. BLAU	07.312.5553.6	10	
5. Jumper bar,	2pole	IVB WKF 2,5-2	Z7.280.6227.0	10	IVB WKF 4-2	Z7.261.1227.0	10	
insulated	3pole	IVB WKF 2,5-3	Z7.280.6327.0	10	IVB WKF 4-3	Z7.261.1327.0	10	
	4pole	IVB WKF 2,5-4	Z7.280.6427.0	10	IVB WKF 4-4	Z7.261.1427.0	10	
	5pole	IVB WKF 2,5-5	Z7.280.6527.0	10	IVB WKF 4-5	Z7.261.1527.0	10	
	6pole	IVB WKF 2,5-6	Z7.280.6627.0	10	IVB WKF 4-6	Z7.261.1627.0	10	
	7pole	IVB WKF 2,5-7	Z7.280.6727.0	20	IVB WKF 4-7	Z7.261.1727.0	20	
	8pole	IVB WKF 2,5-8	Z7.280.6827.0	20	IVB WKF 4-8	Z7.261.1827.0	20	
	9pole	IVB WKF 2,5-9	Z7.280.6927.0	20	IVB WKF 4-9	Z7.261.1927.0	20	
	10pole	IVB WKF 2,5-10	Z7.280.7027.0	20	IVB WKF 4-10	Z7.261.2027.0	20	
6. Cover w. warning symbol over 4 blocks		ADC 1 GELB	04.344.0153.8	10	ADC 2,5 GELB	04.344.0353.8	10	
7. Test plug		WK 2,5 ST 2/2,3	Z5.553.2921.0	10	WK 2,5 ST 2/2,3	Z5.553.2921.0	10	
8. Screw driver, uninsulated		DIN 5264 B 0,6 x 3,5	06.502.4000.0	5	DIN 5264 B 0,6 x 3,5	06.502.4000.0	5	
				**300 V for use group C				
				600 V for use group D, E				
				* CL I, ZN1, AExe II				
				**CL I, ZN1, Exe II				
				* CL I, ZN1, AExe II				
				**CL I, ZN1, Exe II				

IDC function blocks, type WKC

taris

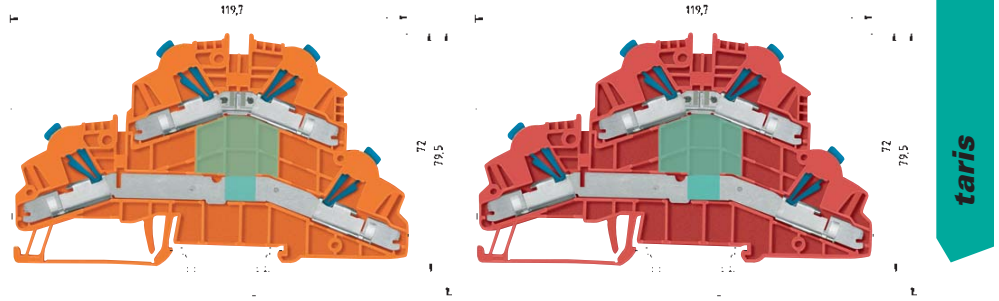

WKC 2,5 E/35...

EN 60 947-7-1
UL ratings
CSA ratings
Width
Approvals

Rated cross section

fine stranded solid V A
1 – 2.5 mm² 1 – 2.5 mm²
No. 18-14 AWG
No. 16-14 AWG
6 mm 2.5 mm²

The double-tier block is available upon request as function block for most different connection tasks.

Examples of functions

	Type	Part no.	Std. pack
Double-tier block	Color: red	WKC 2,5 E/35...	56.303.xx53.5
	Color: orange	WKC 2,5 E/35...	56.303.xx53.9
Accessories			
1. Mounting rail 35, 7.5 mm high	L = 2 m	35 x 27 x 7,5 EN 60715	98.300.0000.0 1
Mounting rail 35, 15 mm high	L = 2 m	35 x 24 x 15 EN 60715	98.360.0000.0 1
2. End clamp for TS 35	8 mm wide	9708/2 S 35	Z5.522.8553.0 100
End clamp for TS 35, screwless	8 mm wide	WEF 1/35	Z5.523.9353.0 100
3. End plate	Color: gray	APC 1-2,5 D2./E.	07.312.5453.0 10
	Color: blue		
	Color: green		
4. Partition plate	Color: gray	TWC 1-2,5 D2./E.	07.312.5553.0 10
	Color: blue	TWC 1-2,5 D2./E. BLAU	07.312.5553.6 10
5. Jumper bar,	2pole	IVB WKF 4-2	Z7.261.1227.0 10
insulated	3pole	IVB WKF 4-3	Z7.261.1327.0 10
	4pole	IVB WKF 4-4	Z7.261.1427.0 10
	5pole	IVB WKF 4-5	Z7.261.1527.0 10
	6pole	IVB WKF 4-6	Z7.261.1627.0 10
	7pole	IVB WKF 4-7	Z7.261.1727.0 20
	8pole	IVB WKF 4-8	Z7.261.1827.0 20
	9pole	IVB WKF 4-9	Z7.261.1927.0 20
	10pole	IVB WKF 4-10	Z7.261.2027.0 20
6. Cover w. warning symbol over 4 blocks		ADC 2,5 GELB	04.344.0353.8 10
7. Test plug		WK 2,5 ST 2/2,3	Z5.553.2921.0 10
8. Screw driver, uninsulated		DIN 5264 B 0,6 x 3,5	06.502.4000.0 5

56.303.7553.9		
56.303.7553.5		
56.303.7153.5		
56.303.7153.9		
56.303.8053.9		I = 1 A U = 1000 V
56.303.8253.5		I = 1 A U = 1000 V
56.303.7953.5		I = 1 A U = 1000 V
56.303.8353.5		I = 1 A U = 1000 V
56.303.7453.9		R = 4,7 KΩ P = 0,5 W U = 24 V DC
56.303.7253.5		R = 4,7 KΩ P = 0,5 W U = 24 V DC
56.303.7353.5		R = 680 KΩ P = 0,25 W U = 100-500 V



taris



taris

IDC disconnect block, type WKC

taris

Fused plug:

Nominal voltage: 250 V
 Nominal current: VDE 0820 T2/IEC 127-2 with a leakage loss of 1.6W.
 – 6.3 A for single blocks
 – 4 A for blocks directly side by side
 Indicator (24 V): red light
 Power consumption 10.3 mA
 Indicator (220 V): red light
 Power consumption: 0.3 mA

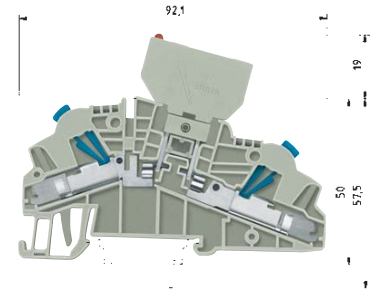
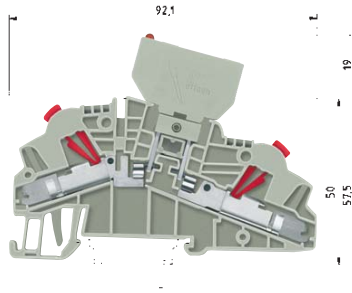

*) The power load is determined by the built-in fuse.
 The voltage range is determined by the built-in LED.

WKC 1 TKG/35 with fuse holder

fine stranded	solid	V	A
0.2 – 1 mm ²	0.2 – 1 mm ²	800 V/8 kV/3	*
No. 30-18 AWG		600 V***	6.3***
No. 24-18 AWG		300 V	6.3
Width	Rated cross section	6 mm	1 mm ²



WKC 2.5 TKG/35 with fuse holder

fine stranded	solid	V	A
1 – 2.5 mm ²	1 – 2.5 mm ²	800 V/8 kV/3	*
No. 18-14 AWG		600 V***	6.3***
No. 16-14 AWG		300 V	6.3
Width	Rated cross section	6 mm	2.5 mm ²



EN 60 947-7-1

UL ratings

CSA ratings

Width

Approvals

		Type	Part no.	Std. pack	Type	Part no.	Std. pack
Disconnect block	Color: gray	WKC 1 TKG/35	56.301.4053.0	50	WKC 2,5 TKG/35	56.303.4053.0	50
Fuse holder for fuse 5 x 20	Color: gray	Si ST	Z1.299.4055.0	10	Si ST	Z1.299.4055.0	10
Fuse holder with indicator (24 V)	Color: gray	Si ST LED	Z1.299.4155.0	10	Si ST LED	Z1.299.4155.0	10
Fuse holder with indicator (220 V)	Color: gray	Si ST GL	Z1.299.4255.0	10	Si ST GL	Z1.299.4255.0	10
Accessories							
1. Mounting rail 35, 7.5 mm high	L = 2 m	35 x 27 x 7,5 EN 60715	98.300.0000.0	1	35 x 27 x 7,5 EN 60715	98.300.0000.0	1
Mounting rail 35, 15 mm high	L = 2 m	35 x 24 x 15 EN 60715	98.360.0000.0	1	35 x 24 x 15 EN 60715	98.360.0000.0	1
2. End clamp for TS 35	8 mm wide	9708/2 S 35	Z5.522.8553.0	100	9708/2 S 35	Z5.522.8553.0	100
End clamp for TS 35, screwless	8 mm wide	WEF 1/35	Z5.523.9353.0	100	WEF 1/35	Z5.523.9353.0	100
3. End plate	Color: gray	APC 1-2,5 D1./TK.	07.312.5253.0	10	APC 1-2,5 D1./TK.	07.312.5253.0	10
	Color: blue						
	Color: green						
4. Partition plate	Color: gray	TWC 1-2,5 D1.	07.312.5353.0	10	TWC 1-2,5 D1.	07.312.5353.0	10
	Color: blue						
5. Jumper bar,	2pole	IVB WKF 4-2	Z7.261.1227.0	10	IVB WKF 4-2	Z7.261.1227.0	10
insulated	3pole	IVB WKF 4-3	Z7.261.1327.0	10	IVB WKF 4-3	Z7.261.1327.0	10
	4pole	IVB WKF 4-4	Z7.261.1427.0	10	IVB WKF 4-4	Z7.261.1427.0	10
	5pole	IVB WKF 4-5	Z7.261.1527.0	10	IVB WKF 4-5	Z7.261.1527.0	10
	6pole	IVB WKF 4-6	Z7.261.1627.0	10	IVB WKF 4-6	Z7.261.1627.0	10
	7pole	IVB WKF 4-7	Z7.261.1727.0	20	IVB WKF 4-7	Z7.261.1727.0	20
	8pole	IVB WKF 4-8	Z7.261.1827.0	20	IVB WKF 4-8	Z7.261.1827.0	20
	9pole	IVB WKF 4-9	Z7.261.1927.0	20	IVB WKF 4-9	Z7.261.1927.0	20
	10pole	IVB WKF 4-10	Z7.261.2027.0	20	IVB WKF 4-10	Z7.261.2027.0	20
6. Cover w. warning symbol over 4 blocks		ADC 2,5 GELB	04.344.0353.8	10	ADC 2,5 GELB	04.344.0353.8	10
7. Test plug		WK 2,5 ST 2/2,3	Z5.553.2921.0	10	WK 2,5 ST 2/2,3	Z5.553.2921.0	10
8. Screw driver, uninsulated		DIN 5264 B 0,6 x 3,5	06.502.4000.0	5	DIN 5264 B 0,6 x 3,5	06.502.4000.0	5
Marking accessories also see page 178-179 and 250-251							

IDC disconnect block, type WKC

taris

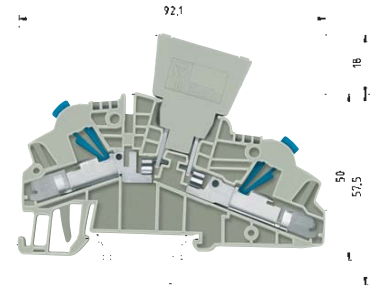
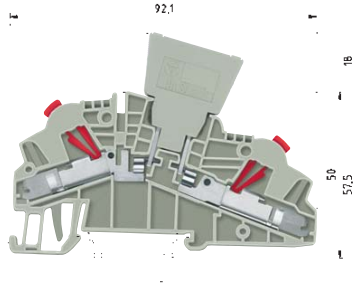

***) 300 V for use Group C
600 V for use Group B, D per UL 1059
Group D, E per CSA C 22.2

***) The power load is determined by the installed component

Periodic peak voltage 1000 V

Direction of the diode: Anode Cathode¹⁾ Cathode Anode²⁾

WKC 1 TKG/35 with diode plug

WKC 2,5 TKG/35 with diode plug

EN 60 947-7-1

UL ratings

CSA ratings

Width

Approvals

Rated cross section

	fine stranded	solid	V	A		fine stranded	solid	V	A
	0.2 – 1 mm ²	0.2 – 1 mm ²	800 V/8 kV/3	**		1 – 2.5 mm ²	1 – 2.5 mm ²	800 V/8 kV/3	**
	No. 30-18 AWG		300/600 V***	**		No. 18-14 AWG		300/600 V***	**
	No. 24-18 AWG		300/600 V	**		No. 16-14 AWG		300/600 V	**
	6 mm				1 mm ²	6 mm			2.5 mm ²



		Type	Part no.	Std. pack	Type	Part no.	Std. pack
Disconnect block		WKC 1 TKG/35	56.301.4053.0	50	WKC 2,5 TKG/35	56.303.4053.0	50
Diode plug – empty	$J_{max} = 10$ A	DIST ...	Z1.299.3053.0		DIST ...	Z1.299.3053.0	
Diode plug – diode	$J_{max} = 1$ A	DIST-1 N 4007-1 ¹⁾	Z1.299.3155.0	10	DIST-1 N 4007-1 ¹⁾	Z1.299.3155.0	10
Diode plug – diode	$J_{max} = 1$ A	DIST-1 N 4007-2 ²⁾	Z1.299.3355.0	10	DIST-1 N 4007-2 ²⁾	Z1.299.3355.0	10
Diode plug with jumper	$J_{max} = 10$ A	DIST-D	Z1.299.3255.0	10	DIST-D	Z1.299.3255.0	
Accessories							
1. Mounting rail 35, 7.5 mm high	L = 2 m	35 x 27 x 7,5 EN 60715	98.300.0000.0	1	35 x 27 x 7,5 EN 60715	98.300.0000.0	1
Mounting rail 35, 15 mm high	L = 2 m	35 x 24 x 15 EN 60715	98.360.0000.0	1	35 x 24 x 15 EN 60715	98.360.0000.0	1
2. End clamp for TS 35	8 mm wide	9708/2 S 35	Z5.522.8553.0	100	9708/2 S 35	Z5.522.8553.0	100
End clamp for TS 35, screwless	8 mm wide	WEF 1/35	Z5.523.9353.0	100	WEF 1/35	Z5.523.9353.0	100
3. End plate	Color: gray	APC 1-2,5 D1./TK.	07.312.5253.0	10	APC 1-2,5 D1./TK.	07.312.5253.0	10
	Color: blue						
	Color: green						
4. Partition plate	Color: gray	TWC 1-2,5 D1.	07.312.5353.0	10	TWC 1-2,5 D1.	07.312.5353.0	10
	Color: blue						
5. Jumper bar,	2pole	IVB WKF 4-2	Z7.261.1227.0	10	IVB WKF 4-2	Z7.261.1227.0	10
insulated	3pole	IVB WKF 4-3	Z7.261.1327.0	10	IVB WKF 4-3	Z7.261.1327.0	10
	4pole	IVB WKF 4-4	Z7.261.1427.0	10	IVB WKF 4-4	Z7.261.1427.0	10
	5pole	IVB WKF 4-5	Z7.261.1527.0	10	IVB WKF 4-5	Z7.261.1527.0	10
	6pole	IVB WKF 4-6	Z7.261.1627.0	10	IVB WKF 4-6	Z7.261.1627.0	10
	7pole	IVB WKF 4-7	Z7.261.1727.0	20	IVB WKF 4-7	Z7.261.1727.0	20
	8pole	IVB WKF 4-8	Z7.261.1827.0	20	IVB WKF 4-8	Z7.261.1827.0	20
	9pole	IVB WKF 4-9	Z7.261.1927.0	20	IVB WKF 4-9	Z7.261.1927.0	20
	10pole	IVB WKF 4-10	Z7.261.2027.0	20	IVB WKF 4-10	Z7.261.2027.0	20
6. Cover w. warning symbol over 4 blocks		ADC 2,5 GELB	04.344.0353.8	10	ADC 2,5 GELB	04.344.0353.8	10
7. Test plug		WK 2,5 ST 2/2,3	Z5.553.2921.0	10	WK 2,5 ST 2/2,3	Z5.553.2921.0	10
8. Screw driver, uninsulated		DIN 5264 B 0,6 x 3,5	06.502.4000.0	5	DIN 5264 B 0,6 x 3,5	06.502.4000.0	5

Hybrid DIN rail mount terminal blocks with IDC and screw technology, type WKC...S/C

taris HYBRID

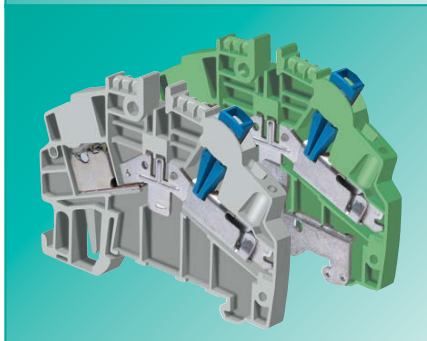
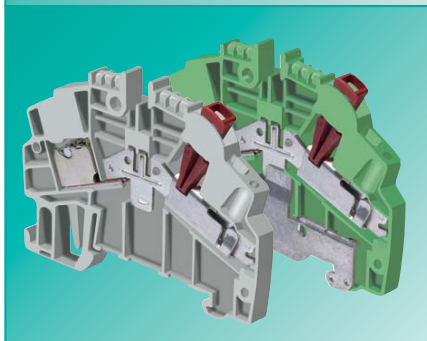
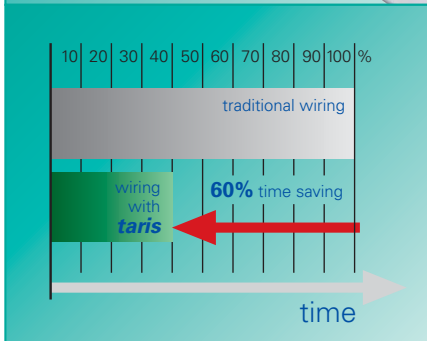
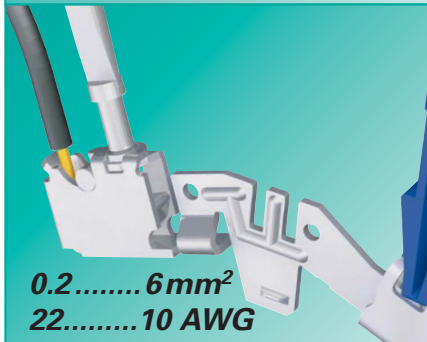
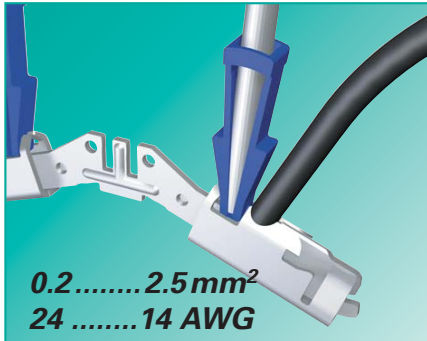

With **taris** HYBRID all the benefits of using IDC technology can be realized for factory wiring. While, the field side can be terminated with familiar screw technology.

taris HYBRID offers...

... for factory wiring

IDC technology

- easy of use
- reduced wiring times
- compact design
- Screwdriver guide

... for field wiring

Screw technology

TOP entry system

Wide range of Conductor Types

Terminal variations

Application advantages.

- No special tools required
- No stripping necessary
- Reduces panel space
- Indicates open or closed state of the contact

→ Well known termination technology

→ Wire and screwdriver entry in same plane

→ Ease of wiring in small confined spaces
Use of any conductor insulation type

→ feed through and ground

→ identification in the type description

C = IDC technology

S = screw connection

→ Indication of the position

WKC 1... Red actuator

WKC 2.5... Blue actuator*

WKC 1 S/C..

solid/stranded copper

stranded copper

solid copper

stranded copper with ferrules

torque specification

→ Connector and wire gauge

C = 0.2 – 1 mm² / AWG 24-18

S = 0.5 – 2.5 mm² / AWG 22-12

S = 0.5 – 4 mm² / AWG 22-12

S = 0.5 – 2.5 mm² / AWG 22-12

S = 8 lb. - in/0.6 Nm (M2.5)

WKC 2.5 S/C..

solid/stranded copper

stranded copper

solid copper

stranded copper with ferrules

torque specification

→ Connection and wire gauge

C = 1 – 2.5 mm² / AWG 16-14

S = 0.5 – 4 mm² / AWG 22-10

S = 0.5 – 6 mm² / AWG 22-10

S = 0.5 – 4 mm² / AWG 22-10

S = 8 lb. - in/0.7 Nm (M3)

taris



Test plug

- taris** offers testing for all terminals, without removing any of the wiring
- Built-in test points at each termination point for use with 2.3 mm diameter test plugs
- Modular test plug modules available on pages 176, 177**

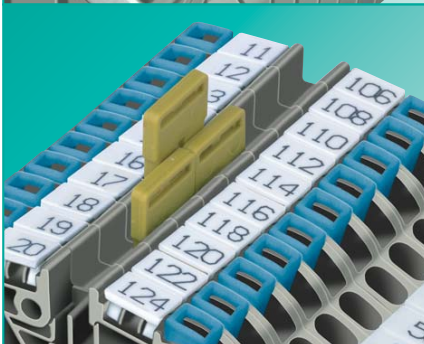

Jumper bars

- The insulated push-in jumper bars, IVB WKF... are completely touch safe
- No partition plate is required between jumpered terminals of different potential
- The IVB WKF... jumper bars are rated for the same current as the terminal block



Marking capability

- Single marking tags
- Marking tag strips (10 tags per strip) to rapidly identify the terminals and circuitry
- Tear-off marking strip for marking up to 3 digits per terminal block
- Marking facility is down the center so that the marking tag is not covered by the conductor.

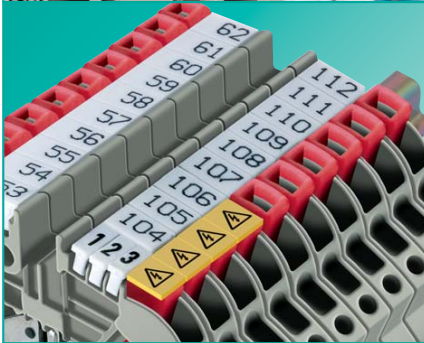

Cover with warning symbol

- Over with warning symbol **ADC** to snap on to blocks which remain live after the mains have been switch off (VDE 0113)
- Cover can only be removed with a screwdriver

DQS certificates for all products

- Quality standard as per DIN ISO 9001 in Development, Production, Assembly
- Continued control of the quality standard by means of regular internal and external quality audits
- Compatible with certificates of other countries:
 - BSI Certificate, Great Britain
 - SQS Certificate, Switzerland
 - Aib-Vincotte Certificate, Belgium
 - ÖQS Certificate, Austria

Material

Metal parts:

special alloys and surface treatments provide low contact resistance and high corrosion resistance:

clamping body made of tin-plated copper

current carrying bar made of tin-plated copper

grounding foot - tin-plated copper alloy

Insulating material:

Polyamide has excellent electrical, chemical and mechanical properties

Insulating housings: Polyamide 66/6

Tracking current resistance: CTI 600

Flammability class: UL 94-V0

(also see section **facts & DATA**)

Our **wieplan** software helps to plan your own terminal block assembly (see page 10/11).

Various German and international approvals are available for feed-through terminal blocks. They are indicated in detail on the corresponding pages. The feed-through blocks of series WK/WKN are approved for the increased-safety type of protection EEx "e" in accordance to DIN EN 50019 / VDE 0170/0171 part 6 where indicated. No type test is required for the EEx "i" type of protection.

Note

The information regarding cross-sectional areas and connection types pertains to wires without ferrules. Ferrules are not necessary for secure connection.

The voltage ratings apply to the terminals in their intended application. When different products are mounted adjacent to each other, the proper isolation distances must be adhered to. For this purpose, **Wieland** offers a large selection of appropriate accessories.

A detailed description of technical data, the standards requirements, and the application conditions can be found in catalog section **facts & DATA**.



Hybrid feed-through terminals with IDC and screw technology, type **WKC...S/C**

taris HYBRID

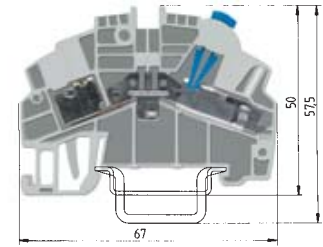
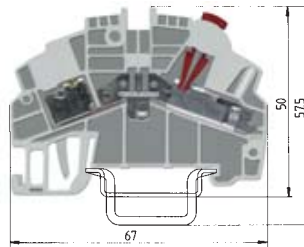

Clamping point "S" = screw technology
Clamping point "C" = IDC technology

Wire strip length applies to the screw terminal only

WKC 1 S/C/35

fine stranded	solid	V	A
0.21 – 1 mm ²	0.21 – 1 mm ²	800 V/8 kV/3	13.5
"S" 22-12 AWG / "C" 24-18 AWG	600V		13
"S" 22-12 AWG / "C" 24-18 AWG	600V		13
5 mm			10mm

WKC 2.5 S/C/35

fine stranded	solid	V	A
1 – 2.5 mm ²	1 – 2.5 mm ²	800 V/8 kV/3	24
"S" 22-10 AWG / "C" 18-14 AWG	600V		22
"S" 22-10 AWG / "C" 16-14 AWG	600V		20
6 mm			10mm

EN 60 947-7-1

UL ratings

CSA ratings

Width

Approvals

Wire strip length

5 mm
UL pending

6 mm
UL pending

		Type	Part no.	Std. pack	Type	Part no.	Std. pack	
Feed-through terminal	Color: gray	WKC 1 S/C/35	56.351.0053.0		WKC 2,5 S/C/35	56.353.0053.0		
Feed-through terminal	Color: blue	WKC 1 S/C/35 BLAU	56.351.0053.6		WKC 2,5 S/C/35	56.353.0053.6		
Ground terminal	Color: green/yellow							
Accessories								
1. Mounting rail 35, 7.5 mm high	L = 2 m	35 x 27 x 7,5 EN 60715	98.300.0000.0	1	35 x 27 x 7,5 EN 60715	98.300.0000.0	1	
Mounting rail 35, 15 mm high	L = 2 m	35 x 24 x 15 EN 60715	98.360.0000.0	1	35 x 24 x 15 EN 60715	98.360.0000.0	1	
2. End clamp for TS 35, with screw	8 mm wide	9708/2 S 35	Z5.522.8553.0	100	9708/2 S 35	Z5.522.8553.0	100	
End clamp for TS 35, screwless	8 mm wide	WEF 1/35	Z5.523.9353.0	100	WEF 1/35	Z5.523.9353.0	100	
3. End plate	1.5 mm wide	Color: gray	APC 1-2,5	07.312.5053.0	10	APC 1-2,5	07.312.5053.0	10
	1.5 mm wide	Color: blue	APC 1-2,5 BLAU	07.312.5053.6	10	APC 1-2,5 BLAU	07.312.5053.6	10
	1.5 mm wide	Color: green						
4. Partition plate	1.5 mm wide	Color: gray	TWC 1-2,5	07.312.5153.0	10	TWC 1-2,5	07.312.5153.0	10
	1.5 mm wide	Color: blue	TWC 1-2,5 BLAU	07.312.5153.6	10	TWC 1-2,5 BLAU	07.312.5153.6	10
5. Jumper bar,	2pole	IVB WKF 2,5-2	Z7.280.6227.0	10	IVB WKF 4-2	Z7.261.1227.0	10	
insulated	3pole	IVB WKF 2,5-3	Z7.280.6327.0	10	IVB WKF 4-3	Z7.261.1327.0	10	
	4pole	IVB WKF 2,5-4	Z7.280.6427.0	10	IVB WKF 4-4	Z7.261.1427.0	10	
	5pole	IVB WKF 2,5-5	Z7.280.6527.0	10	IVB WKF 4-5	Z7.261.1527.0	10	
	6pole	IVB WKF 2,5-6	Z7.280.6627.0	10	IVB WKF 4-6	Z7.261.1627.0	10	
	7pole	IVB WKF 2,5-7	Z7.280.6727.0	20	IVB WKF 4-7	Z7.261.1727.0	20	
	8pole	IVB WKF 2,5-8	Z7.280.6827.0	20	IVB WKF 4-8	Z7.261.1827.0	20	
	9pole	IVB WKF 2,5-9	Z7.280.6927.0	20	IVB WKF 4-9	Z7.261.1927.0	20	
	10pole	IVB WKF 2,5-10	Z7.280.7027.0	20	IVB WKF 4-10	Z7.261.2027.0	20	
6. Cover w. warning symbol over 4 blocks								
	Clamping point „C“	ADC 1/4 GELB	04.344.0153.8	10	ADC 2,5 GELB	04.344.0353.8	10	
	Clamping point „S“	ADF 2,5/4 GELB	04.343.6053.8	10	ADF 4/4 GELB	04.343.6153.8	10	
7. Test plug		WK 2,5 ST 2/2,3	Z5.553.2921.0	10	WK 2,5 ST 2/2,3	Z5.553.2921.0	10	
8. Screw driver, uninsulated		DIN 5264 B 0,6 x 3,5	06.502.4000.0	5	DIN 5264 B 0,6 x 3,5	06.502.4000.0	5	
Screw driver, uninsulated, MINI		DIN 5264 B 0,6 x 3,5 M	06.502.5000.0	10	DIN 5264 B 0,6 x 3,5 M	06.502.5000.0	10	
Marking accessories also see page 178-179 and 250-251								

Hybrid ground terminals with IDC and screw technology, type WKC...S/C

taris

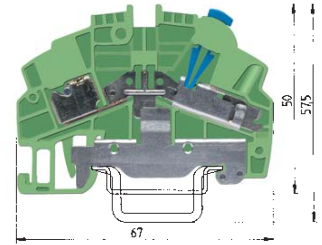
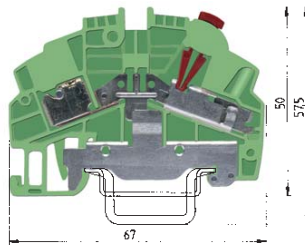

taris

Clamping point "S" = screw technology
Clamping point "C" = IDC technology

Wire strip length applies to the screw terminal only

EN 60 947-7-1

UL ratings

CSA ratings

Width

Approvals

Wire strip length

WKC 1 S/C/SL/35

fine stranded	solid	V	A
0.21 – 1 mm ²	0.21 – 1 mm ²	800 V/8 kV/3	13.5
"S" 22-12 AWG/ "C" 24-18 AWG		600V	13
"S" 22-12 AWG/ "C" 24-18 AWG		600V	13

5 mm 10mm

pending

WKC 2.5 S/C/35

fine stranded	solid	V	A
1 – 2,5 mm ²	1 – 2,5 mm ²	800 V/8 kV/3	24
"S" 22-10 AWG/ "C" 18-14 AWG		600V	22
"S" 22-10 AWG/ "C" 16-14 AWG		600V	20

6 mm 10mm

pending

		Type	Part no.	Std. pack	Type	Part no.	Std. pack	
Feed-through terminal	Color: gray							
Feed-through terminal	Color: blue							
Ground terminal	Color: green/yellow	WKC 1 S/C/SL/35	56.351.9053.0		WKC 2,5 S/C/SL/35	56.353.9053.0		
Accessories								
1. Mounting rail 35, 7.5 mm high	L = 2 m	35 x 27 x 7,5 EN 60715	98.300.0000.0	1	35 x 27 x 7,5 EN 60715	98.300.0000.0	1	
Mounting rail 35, 15 mm high	L = 2 m	35 x 24 x 15 EN 60715	98.360.0000.0	1	35 x 24 x 15 EN 60715	98.360.0000.0	1	
2. End clamp for TS 35, with screw	8 mm wide	9708/2 S 35	Z5.522.8553.0	100	9708/2 S 35	Z5.522.8553.0	100	
End clamp for TS 35, screwless	8 mm wide	WEF 1/35	Z5.523.9353.0	100	WEF 1/35	Z5.523.9353.0	100	
3. End plate	1.5 mm wide							
	1.5 mm wide							
	1.5 mm wide	Color: green	APC 1-2,5 GRÜN	07.312.5053.7	10	APC 1-2,5 GRÜN	07.312.5053.7	10
4. Partition plate	1.5 mm wide	Color: gray						
	1.5 mm wide	Color: blue						
5. Jumper bar,	2pole							
insulated	3pole							
	4pole							
	5pole							
	6pole							
	7pole							
	8pole							
	9pole							
	10pole							
6. Cover w. warning symbol over 4 blocks								
	Clamping point „C“	ADC 1/4 GELB	04.344.0153.8	10	ADC 2,5 GELB	04.344.0353.8	10	
	Clamping point „S“	ADF 2,5/4 GELB	04.343.6053.8	10	ADF 4/4 GELB	04.343.6153.8	10	
7. Test plug		WK 2,5 ST 2/2,3	Z5.553.2921.0	10	WK 2,5 ST 2/2,3	Z5.553.2921.0	10	
8. Screw driver, uninsulated		DIN 5264 B 0,6 x 3,5	06.502.4000.0	5	DIN 5264 B 0,6 x 3,5	06.502.4000.0	5	
Screw driver, uninsulated, MINI		DIN 5264 B 0,6 x 3,5 M	06.502.5000.0	10	DIN 5264 B 0,6 x 3,5 M	06.502.5000.0	10	

Marking accessories for IDC DIN rail terminal blocks

taris

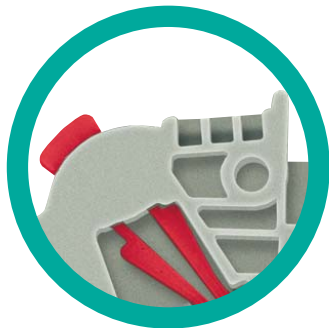

Material:
Polyamide 66/6
Color: black figures on white background

DIN rail terminal blocks with IDC connection, type WKC, accept marking tags on both sides on top of the block in a 3-chamber slot. It can be either 3 single number tags from the tear-off marking strip, or single tags, or marking strips.

- Marking strips**, marked and unmarked, made from Polyamide 66/6, suitable for 10 blocks in a row. Marking 1-10, 11-20 etc. up to 991-999.
Type 9705 A/5/10 (5 mm spacing) for terminal blocks type WKC 1...
Type 9705 A/6/10 (6 mm spacing) for terminal blocks type WKC 2.5...
- Tear-off marking strip** with 10 marking tags made of Polyamide 66/6, white, marked and unmarked.
This marking system considerably reduces the marking time of terminal block assemblies. For numerical marking of terminal block assemblies you require only 1 1 warehouse positions. As the time used for picking and attaching the tags is reduced, and as stockkeeping is low and the prices extremely favorable, enormous cost savings are the result from using these tear-off marking strips.
Type 9704 A...
(see page 180)
- Single marking tag** made of Polyamide 66/6, white, marked and unmarked.
Type 9705 A...
- Marking plates** made of Polyamide 66/6 consisting of 11 marking strips.
Type 9705 A/5/10 (5 mm spacing) for terminal blocks type WKC 1...
Type 9705 A/6/10 (6 mm spacing) for terminal blocks type WKC 2.5...

Bezeichnungscomputer im Systemkoffer

Type	Part no.	Std. pack
Marking computer for markingcards		
marcom 2	95.502.0000.0	1
Description		
<p>wieland marcom 2 is a freely programmable marking computer for marking tags of DIN rail terminal blocks, pluggable connectors, cables and switching devices. The program technology with flexible menu control produces excellent results requiring only few input. Entry of a sequence of figures is automatically limited by the parameters of the selected marking tags, making wrong print-out impossible. Repeated operations can be saved as so-called JOBS and are therefore immediately available for print-out without further entries. The computer disposes of a large number of fonts, with numerical, alphanumerical (small/capital letters) and symbolic characters.</p> <p>marcom 2 is powered by an attached power supply. For a mains-independent operation, the marcom 2 Power Pack is available.</p>		
Marking tag plates for marcom 2		
9705 A/5/10/11 marcom	Z4.242.5053.0	10
9705 AL/5/10/6 marcom	Z4.242.5153.0	10
9705 A/6/10/11 marcom	Z4.242.6053.0	10
9705 AL/6/10/6 marcom	Z4.242.6353.0	10
9705 A/8/10/7 marcom	Z4.242.8053.0	10

Marking strips and marking plates, marked



1 mm²/5 mm Width

2.5 mm²/6 mm Width

Marking strips, unmarked				Marking strips, unmarked			
9705 A/5/10		04.242.5053.0	25	9705 A/6/10		04.242.6053.0	25
Marking strips, marked				Marking strips, marked			
9705 A/5/10 B	1 - 10	04.845.0153.0	25	9705 A/6/10 B	1 - 10	04.846.0153.0	25
	11 - 20	04.845.0253.0	25		11 - 20	04.846.0253.0	25
	21 - 30	04.845.0353.0	25		21 - 30	04.846.0353.0	25
	31 - 40	04.845.0453.0	25		31 - 40	04.846.0453.0	25
	41 - 50	04.845.0553.0	25		41 - 50	04.846.0553.0	25
	51 - 60	04.845.0653.0	25		51 - 60	04.846.0653.0	25
	61 - 70	04.845.0753.0	25		61 - 70	04.846.0753.0	25
	71 - 80	04.845.0853.0	25		71 - 80	04.846.0853.0	25
	81 - 90	04.845.0953.0	25		81 - 90	04.846.0953.0	25
	91 - 100	04.845.1053.0	25		91 - 100	04.846.1053.0	25
	⊕ (10 x)	04.855.0053.0	25		⊕ (10 x)	04.856.0053.0	25
	⊖ (10 x)	04.855.0153.0	25		⊖ (10 x)	04.856.0153.0	25
	+	04.855.0253.0	25		+	04.856.0253.0	25
	-	04.855.0353.0	25		-	04.856.0353.0	25
	L1 (10 x)	04.855.0453.0	25		L1 (10 x)	04.856.0453.0	25
	L2 (10 x)	04.855.0553.0	25		L2 (10 x)	04.856.0553.0	25
	L3 (10 x)	04.855.0653.0	25		L3 (10 x)	04.856.0653.0	25
	PE (10 x)	04.855.0753.0	25		PE (10 x)	04.856.0753.0	25
	SL (10 x)	04.855.3153.0	25		SL (10 x)	04.856.3153.0	25
	N (10 x)	04.855.3253.0	25		N (10 x)	04.856.3253.0	25
	F1 (10 x)	04.855.0953.0	25		F1 (10 x)	04.856.0953.0	25
	F2 (10 x)	04.855.1053.0	25		F2 (10 x)	04.856.1053.0	25
	L1, L2, L3, N, PE (2 x)	04.855.0853.0	25		L1, L2, L3, N, PE (2 x)	04.856.0853.0	25
Marking plates, unmarked				Marking plates, unmarked			
9705 A/5/10/11		Z4.242.5053.0	10	9705 A/6/10/11		Z4.242.6053.0	10
custom marking upon request				custom marking upon request			





Appliance Terminals

appliance TERMINALS

All Wieland Components which require **CE** general certification are **CE** certified, and identified with the **CE** logo.

Terminal strips

Lighting and appliance terminals

Plug/screw terminal strips
Terminal box
Distribution terminal strips

Mains connectors for appliance wiring

appliance

CONTENTS

	KL 16 PA compact Europa terminal strips <ul style="list-style-type: none"> • 1.5 mm² to 16 mm² • Male/female terminal strips • Marking accessories 	Page 256 Page 257 Page 258 Page 258 Page 260
	1 to 4pole Modular terminals	Page 261 Page 263
	2 to 5pole 2 to 12pole Plug/screw KL 17 N	Page 264 Page 265 Page 267
	KL 58 <ul style="list-style-type: none"> • 6 – 10 mm² • 3, 5, 6pole • Screw/screw connections • Screw/tab connections 	Page 268 Page 268 Page 268 Page 267 Page 267

Unbreakable terminal strips for narrow spaces

KL 16 PA

Material:

Insulating housing: Polyamide 6 ivory
 Hardness test at 125 °C
 Glow-wire test with 850 °C
 Tracking test PTI 250
 Clamping body: nickel-plated brass
 Wire protection: phosphor bronze
 Clamping screws: steel, zinc-plated and dichromated

These terminal strips are designed for use under extreme conditions accord. to EN 60335-1/ DIN VDE 0700 T1.

Terminals with wire protection DS are fitted with a wire protection guard inside the clamping body, which prevents damage to the connected wire.

The clamping screws are secured against loosening and provide vibration-proof connections.

DIN VDE 0110 (fixed position)
 UL ratings
 CSA ratings
 EN 60335-1/DIN VDE 0700 T1
 Approvals

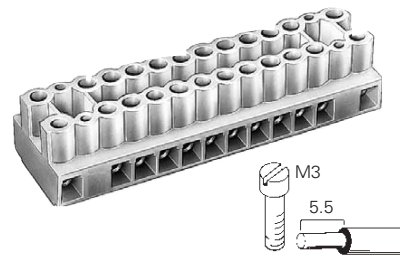
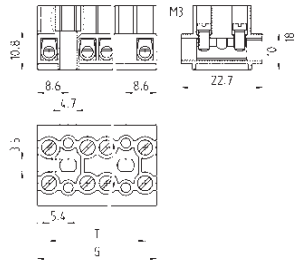

Type KL 16 PA 2.5 mm²

without wire protection

500 V/6 kV/3
 No. 22-12 AWG 250 V 20 A
 No. 22-12 AWG 300 V 25 A
 AC 400 V; 10 A; 1 – 1.5 mm²/1 – 2.5 mm²



Type KL 16 PA 2.5 mm²

with wire protection (DS)

500 V/6 kV/3
 No. 22-12 AWG 250 V 20 A
 No. 22-12 AWG 300 V 25 A
 AC 400 V; 10 A; 1 – 1.5 mm²/1 – 2.5 mm²



	Poles	G	T	Type	Part no.	Std. pack	Type	Part no.	Std. pack
	4	33.4	27	KL 16/4 PA	29.400.0453.0	65	KL 16/4 PA DS	29.401.0453.0	65
	6	44.2	37.8	KL 16/6 PA	29.400.0653.0	50	KL 16/6 PA DS	29.401.0653.0	50
	8	55	48.6	KL 16/8 PA	29.400.0853.0	40	KL 16/8 PA DS	29.401.0853.0	40
	12	76.6	70	KL 16/12 PA	29.400.1253.0	30	KL 16/12 PA DS	29.401.1253.0	30
	16	98.2	91.8	KL 16/16 PA	29.400.1653.0	20	KL 16/16 PA DS	29.401.1653.0	20
	20	119.8	113.4	KL 16/20 PA	29.400.2053.0	20	KL 16/20 PA DS	29.401.2053.0	20
Accessories									
Marking plate from white PVC, marking surface on both sides	4	33.4	27	BZKL 16/4 Z	Z4.102.0480.0	100	BZKL 16/4 Z	Z4.102.0480.0	100
and four plastic pins from Polyamide to fasten the marking plate	6	44.2	37.8	BZKL 16/6 Z	Z4.102.0680.0	100	BZKL 16/6 Z	Z4.102.0680.0	100
	8	55	48.6	BZKL 16/8 Z	Z4.102.0880.0	100	BZKL 16/8 Z	Z4.102.0880.0	100
	12	76.6	70	BZKL 16/12 Z	Z4.102.1280.0	100	BZKL 16/12 Z	Z4.102.1280.0	100
	16	98.2	91.8	BZKL 16/16 Z	Z4.102.1680.0	100	BZKL 16/16 Z	Z4.102.1680.0	100
	20	119.8	113.4	BZKL 16/20 Z	Z4.102.2080.0	100	BZKL 16/20 Z	Z4.102.2080.0	100
Fastening pins					05.592.1152.0			05.592.1152.0	
Marked marking plates, 4 to 20pole	4			BZKL 16/4 ZB	Z4.802.0480.0	100	BZKL 16/4 ZB	Z4.802.0480.0	100
	20			BZKL 16/20 ZB	Z4.802.2080.0	100	BZKL 16/20 ZB	Z4.802.2080.0	100
Jumper bars of E-Cu	2	7.4			07.250.0027.0	10		07.250.0027.0	10
	80	596			07.250.1627.0	10		07.250.1627.0	10

Divisible Europa terminal strips



Material:

Insulating housing: Polyamide 6 ivory
 Hardness test at 125 °C
 Glow-wire test with 850 °C
 Tracking test PTI 250
 Clamping body: nickel-plated brass
 Wire protection: phosphor bronze
 Clamping screws: steel, zinc-plated and dichromated

Permanent temperature 100 °C
 Permanent temperature 130 °C accord. to UL 746 B
 Tracking resistance accord. to DIN IEC 112 CTI > 600.

Terminals with wire protection DS are fitted with a wire protection guard inside the clamping body, which prevents damage to the connected wire. All parts are captive in the insulating housing. The clamping screws are secured against loosening and provide vibration-proof connections. The terminal strips are supplied with the clamping screws in the "open" position.

EN 60998-1/-2-1 (fixed position)
 EN60335-1/DIN VDE 0700 T1
 Approvals

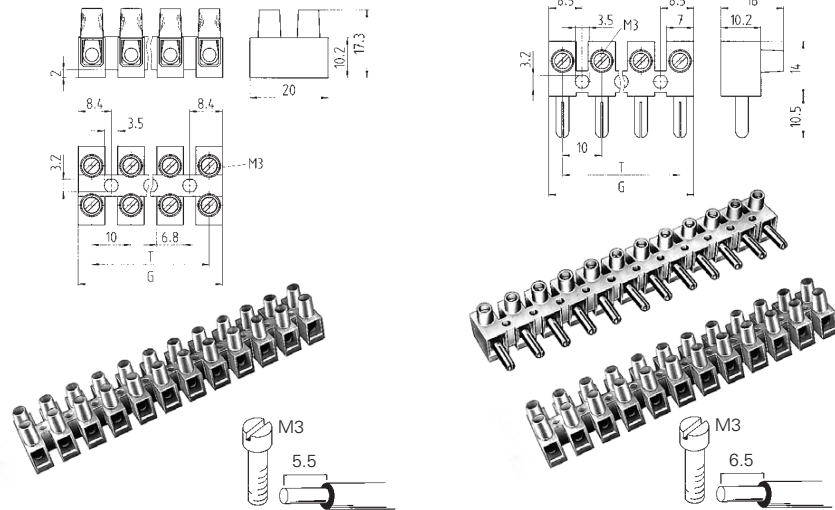

Type 6 E

with DS: up to 2.5 mm²/fine-stranded
 400 V; 24 A;

4 mm²



Male terminal strip without wire protection Type 6 ES

Female terminal strip without wire protection Type 6 E

4 mm²

AC 400 V; 10 A; 1 – 1.5 mm²/1 – 2.5 mm²*)
 Approval logos: CE, VDE, TÜV, etc.

	Poles	G	T	Type	Part no.	Std. pack	G	T	Type	Part no.	Std. pack	
without wire protection	1	7	-	6 E/ 1	21.310.0153.0	4000	7	-	6 ES/ 1	22.310.0153.0	100	
UL ratings: AWG no. 20-12 20 A (6 E) 22-14 15 A (6 E DS) 22-12 20 A (6 ES, 6 E Female terminal strip) 22-8 40 A (10 E) 22-12 20 A (10 E DS) 22-8 50/65 A (16 E)-field/factory wiring 22-10 30/40 A (16 E DS)-field/factory wiring 20-4 70 A (20 E) 22-6 65/75 A (20 E DS)-field/factory wiring 300 V (600 V with PVC insulating spacer)	2	17	10	6 E/ 2	21.310.0253.0	1500	17	10	6 ES/ 2	22.310.0253.0	100	
	3	27	20	6 E/ 3	21.310.0353.0	1500	27	20	6 ES/ 3	22.310.0353.0	100	
	4	37	30	6 E/ 4	21.310.0453.0	1000	37	30	6 ES/ 4	22.310.0453.0	100	
	5	47	40	6 E/ 5	21.310.0553.0	500	47	40	6 ES/ 5	22.310.0553.0	100	
	6	57	50	6 E/ 6	21.310.0653.0	500	57	50	6 ES/ 6	22.310.0653.0	100	
	7	67	60	6 E/ 7	21.310.0753.0	50	67	60	6 ES/ 7	22.310.0753.0	50	
	8	77	70	6 E/ 8	21.310.0853.0	50	77	70	6 ES/ 8	22.310.0853.0	50	
	9	87	80	6 E/ 9	21.310.0953.0	50	87	80	6 ES/ 9	22.310.0953.0	50	
	10	97	90	6 E/10	21.310.1053.0	50	97	90	6 ES/10	22.310.1053.0	50	
	12	117	110	6 E	21.310.1253.0	250	117	110	6 ES	22.310.1253.0	50	
										Female terminal strip without wire protection		
	with wire protection (DS)	1	7	-	6 E/ 1 DS	21.311.0153.0	4000	7	-	6 E/ 1	99.261.3521.9	200
CSA ratings: AWG no. 22-14 20 A (6 E, 6 E DS) 22-14 20 A (6 ES, 6 E Female terminal strip) 22-12 25 A (10 E, 10 E DS) 20-10 40 A (16 E, 16 E DS) 18-8 65 A (20 E, 20 E DS) 300 V (600 V with PVC insulating spacer) - with insulating spacer and fastening screws from insulating material 800 V 6 E (DS) - with insulating spacer and fastening screws from insulating material 1000 V 10 E (DS), 16 E (DS), 20 E (DS) - 1pole version (without own fastening device) no VDE approval 20 E, 20 EDS: 18-6 AWG, 65 A, 600 V - no spacer required	2	17	10	6 E/ 2 DS	21.311.0253.0	1500	17	10	6 E/ 2	99.262.3521.9	100	
	3	27	20	6 E/ 3 DS	21.311.0353.0	1500	27	20	6 E/ 3	99.263.3521.9	100	
	4	37	30	6 E/ 4 DS	21.311.0453.0	1000	37	30	6 E/ 4	99.264.3521.9	100	
	5	47	40	6 E/ 5 DS	21.311.0553.0	500	47	40	6 E/ 5	99.265.3521.9	500	
	6	57	50	6 E/ 6 DS	21.311.0653.0	500	57	50	6 E/ 6	99.266.3521.9	100	
	7	67	60	6 E/ 7 DS	21.311.0753.0	50	67	60	6 E/ 7	99.267.3521.9	50	
	8	77	70	6 E/ 8 DS	21.311.0853.0	50	77	70	6 E/ 8	99.268.3521.9	50	
	9	87	80	6 E/ 9 DS	21.311.0953.0	50	87	80	6 E/ 9	99.269.3521.9	50	
	10	97	90	6 E/10 DS	21.311.1053.0	50	97	90	6 E/10	99.270.3521.9	50	
	12	117	110	6 E DS	21.311.1253.0	250	117	110	6 E	99.272.3521.9	50	
	Accessories											
	Jumper bars E-Cu	2			VB 11/1/2	07.250.0227.0	100					
	3			VB 11/1/3	07.250.0327.0	100						
	6	52.8		VB 11/1/6	07.250.0627.0	50						
	12	112.8		VB 11/1/12	07.250.1027.0	50						
Insulating spacer PVC polycarbonate-yellow												
for higher voltages 1000 mm		1000.0			07.470.1380.0	1						
Wire guard Polycarbonat-yellow	2 -	20.5		LH GE/2	07.470.2256.0	100						
	12	120		LH GE/12	07.470.3256.0	10						

*1 flexible wire/rigid wire

Appliance terminals

appliance TERMINALS



Material:

Insulating parts: glazed porcelain or melamine type 150, tracking resistant
 Clamping body: nickel-plated brass;
 Wire protection: phosphor bronze;
 Clamping screws: steel, zinc-plated and dichromated

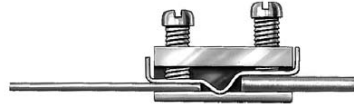
Terminals with wire protection DS are fitted with a wire protection guard inside the clamping body, which prevents damage to the connected wire.





Temperature range for porcelain: -40 °C → +150 °C

	Poles	mm ²	Type	Part no.	Std. pack	L	W	H	Distance Ø, Mount. holes	Fasten. screws DIN 84	
Appliance terminal with mounting hole	2		1032	14.200.0270.0	100	24					
 <p>M3 M3.5</p> <p>Insulating part: Glazed porcelain Wire strip length: 6 mm DIN VDE 0110 (position not fixed) 400 V/4 kV/2</p> <p>M3 = 10 A M3.5 = 16 A</p>	Dimensions in mm		2	1032 DS	14.201.0270.0	100					
	2		1032 M 3,5	14.200.1270.0	100						
	3		1033	14.200.0370.0	50	38	20	16	13	4.5	M4
	3	2.5	1033 DS	14.201.0370.0	50	38			13		
	3		1033 M 3,5	14.200.1370.0	50						
	4		1033 A	14.200.0470.0	50	39					
	4		1033 A DS	14.201.0470.0	50	39					
	4		1033 M 3,5	14.200.1470.0	50						
	Appliance terminal accord. to DIN 46284	2		2 DIN 46284 ST	14.210.0270.0	100	20				
	<p>Insulating part: Glazed porcelain Wire strip length: 6 mm DIN VDE 0110 (fixed position) 400 V/6 kV/3</p>	2		2 D DIN 46284 ST	14.211.0270.0	100	20				
		2.5				21	18		3.3	M3	
3			3 DIN 46284 ST	14.210.0370.0	100	34			12.5		
3			3 D DIN 46284 ST	14.211.0370.0	100	34			12.5		
Appliance terminal with mounting hole and base rail	2	2.5	1031	14.220.0270.0	100	24					
 <p>M3 (2.5 mm²) M5 (6 mm²)</p> <p>Insulating part: Glazed porcelain Wire strip length: 6 mm DIN VDE 0110 (position not fixed) 400 V/6 kV/3</p>	3	2.5	1029	14.220.0370.0	50	36	25	18	13	4.5	M4
	2	6	1027	14.230.0270.0	30	36	36	28		5.8	M5
	Appliance terminal 4pole	4	2.5	1033 A P KR	14.290.0440.0	100	40	20	18.5		5.3
 <p>M3</p> <p>Insulating part: melamine type 150, tracking resistant Wire strip length: 6 mm DIN VDE 0110 (fixed position) 400 V/6 kV/3</p>	4	2.5	1033 A P DS KR	14.291.0440.0	100						

Modular terminals for mounting rail 10 x 2.5 mm

appliance

with insulating housing from unglazed
steatite

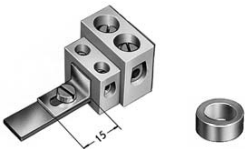
	DIN VDE 0110	Wire strip length	Type	Part no.	Std. pack	L	B	mm ² solid/stranded/fine-stranded	with ferrule	Cl.screw	
Modular terminal without wire protection Dimensions in mm 	250 V/4 kV/3	7	1038 A	30.400.0675.0	125	19	8.5 ± 0.3	6	4	2.5	M3
	250 V/4 kV/3	10	1038 B	30.400.1075.0	100	24	12.5 ± 0.35	10	10	6	M4
	400 V/6 kV/3	10	1038 C	30.400.1675.0	75	28	15 ± 0.4	16	10	10	M5
Modular terminal with wire protection 	250 V/4 kV/3	6	1038 A DS	30.401.0475.0	125	19	8.5 ± 0.3	4	4	1.5	M3
	250 V/4 kV/3	7	1038 B DS	30.401.0675.0	100	24	12.5 ± 0.35	6	6	2.5	M4
	400 V/6 kV/3	7	1038 C DS	30.401.1075.0	75	28	15 ± 0.4	10	10	4	M5
Accessories											
											
Mounting rail: steel, galv. zinc-plated, L = 1 m			1039 M	98.060.0000.0	50						
10 x 2.5 mm											
End bracket			1039 W	05.522.0725.0	250						
Distance ring: outside Ø 7, inside Ø 4.5			1036 R	05.590.3121.0	500						

Distribution terminal strips for plug and screw connections

KL 17 N

Material:

Insulating part: Polyamid 66 ivory
 Permanent temperature 100 °C
 Permanent temperature 125 °C accord. to UL 746 B
 (All indicated temperatures include the power load caused by the operation)

Tracking resistance accord. to DIN IEC 112. CTI > 600
 Hardness test at 125 °C
 Glow-wire test with 850 °C
 Tracking test PTI 600

- with insulating spacer 400 V

** 24 A screw clamp terminal with 2.5 mm² conductor
 12 A tab connector with 1.5 mm² conductor

CSA: 300 A, 20 A, 22 - 12 AWG

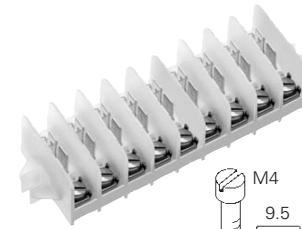
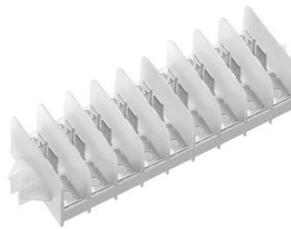
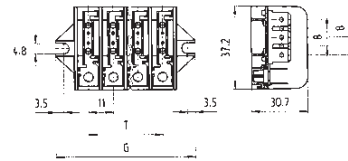

appliance TERMINALS

Distribution terminal strip Type KL 17 N/*.../

for plug connections

* indicate the number of poles, e.g. KL 17 N/5/
 AC 230/400 V/2; **A;
 1 - 2.5 mm²/5x (6.3 x 0.8 mm)

Distribution terminal strip Type KL 17 N/*.../K

for plug and screw connections

* indicate the number of poles, e.g. KL 17 N/5/K
 AC 230/400 V/2; **A;
 1 - 2.5 mm²/5x (6.3 x 0.8 mm)
 with clamping spring and screw M4 x 8 DIN 85

EN 60998-1-2-1; EN 61210 (fixed position)

	Poles	G	Type	Part no.	Std. pack	Type	Part no.	Std. pack
5 tab connectors 6.3 x 0.8 mm	1	29.8		29.608.0153.0	120		29.608.3153.0	120
tin-plated steel	2	40.8		29.608.0253.0	80		29.608.3253.0	80
	3	51.8		29.608.0353.0	60		29.608.3353.0	60
	4	62.8		29.608.0453.0	40		29.608.3453.0	40
	5	73.8		29.608.0553.0	40		29.608.3553.0	40
	6	84.8		29.608.0653.0	30		29.608.3653.0	30
	7	95.8		29.608.0753.0	30		29.608.3753.0	30
	8	106.8		29.608.0853.0	20		29.608.3853.0	20
	9	117.8		29.608.0953.0	20		29.608.3953.0	20
	10	128.8		29.608.1053.0	20		29.608.4053.0	20
	11	139.8		29.608.1153.0	20		29.608.4153.0	20
	12	150.8		29.608.1253.0	20		29.608.4253.0	20
	13	161.8		29.608.1353.0	10		29.608.4353.0	10
	14	172.8		29.608.1453.0	10		29.608.4453.0	10
	15	183.8		29.608.1553.0	10		29.608.4553.0	10
	16	194.8		29.608.1653.0	10		29.608.4653.0	10
	17	205.8		29.608.1753.0	10		29.608.4753.0	
	18	216.8		29.608.1853.0	10		29.608.4853.0	10
	19	227.8		29.608.1953.0	10		29.608.4953.0	
	20	238.8		29.608.2053.0	10		29.608.5053.0	10
	21	249.8		29.608.2153.0	10		29.608.5153.0	
Accessories	22	260.8		29.608.2253.0	10		29.608.5253.0	
Insulating spacer: cardboard 2061,	23	271.8		29.608.2353.0	10		29.608.5353.0	
1 to	24	282.8		29.608.2453.0	10		29.608.5453.0	10
24pole								
Marking plate: PVC								
1 to								
24pole								
				07.450.0187.0			07.450.0187.0	
				07.450.2487.0			07.450.2487.0	
				07.451.0180.0			07.451.0180.0	
				07.451.2480.0	100		07.451.2480.0	100

Mains connectors for appliance wiring 3, 5 and 6pole with screw connection

KL 58 1/5A

Material:

Insulating housing: Polyamide, fiberglass reinforced
Clamping body: tin-plated steel
Clamping screws and clamping spring: zinc-plated steel
Switchable connecting link E-Cu

Ambient temperature:

T 160 ... - 5 °C
Continuous maximum temperature: 125 °C

Insulating part:

Hardness test at 210 °C
Glow-wire test with 850 °C
Tracking test PTI 400

Air and creepage distances accord. to
DIN EN 60335-1/VDE 0700 part 1

VDE with Statement of Conformity

EN 60998-1-2-1; EN 61210; (fixed position)
UL-ratings field/factory wiring
CSA ratings
Approvals

AC 400 V; 41 A; 1.5 – 6 mm²
250 V; 40 A; No. 8 - 14/10 AWG
300 V Gr.B/150 V Gr.C; 40 A; No. 8/10 AWG

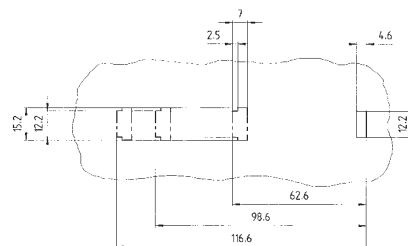

Cut-out 3, 5, 6pole for
*) "latching foot versions"
Metal sheet 1.5 mm thick

	Poles	Type	Part no.	Std. pack	
	3	KL 58/3/1	29.130.1353.0	200	
	5	KL 58/5/1	29.130.1553.0	100	
		3 links used as a bridge between poles 3 and 4			
	6	KL 58/6/1	29.130.1653.0	100	
		3 links used as a bridge between poles 4 and 5			
	3	KL 58/3 R/1*	29.130.2353.0	200	
	5	KL 58/5 R/1*	29.130.2553.0	100	
		3 links used as a bridge between poles 3 and 4			
	6	KL 58/6 R/1*	29.130.2653.0	100	
		3 links used as a bridge between poles 4 and 5			

	T (mm)	G
3pole	36	81
5pole	72	117
6pole	90	135

	T (mm)	G
3pole	36	66.5
5pole	72	102.5
6pole	90	120.5

Mains connectors for appliance wiring 3, 5 and 6pole with 3 tab connectors 6.3 x 0.8 mm per pole

Material:

Insulating housing: Polyamide, fiberglass reinforced
Clamping body: nickel-plated steel
Clamping screws and clamping spring: zinc-plated steel
Switchable connecting link E-Cu

Ambient temperature:

T 160 ... - 5 °C
Continuous maximum temperature: 125 °C

Insulating part:

Hardness test at 210 °C
Glow-wire test with 850 °C
Tracking test PTI 400

Air and creepage distances accord. to
DIN EN 60335-1/VDE 0700 part 1

- * 41 A Screw terminal with 6 mm² conductor
- ** 20 A Tab connector with 6 mm² conductor
VDE with Statement of Conformity

(mains side) **10 mm²**

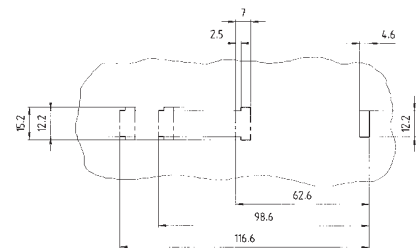

Cut-out 3, 5, 6pole for
*) "latching foot versions"
Metal sheet 1.5 mm thick

EN 60998-1/2-1; EN 61210; (fixed position)
UL-ratings field/factory wiring
CSA ratings
Approvals

AC 400 V; */** A; 1.5 – 6 mm²/3x (6.3 x 0.8 mm)
250 V; 40 A; No. 8 - 14/10 AWG
300 V Gr.B/150 V Gr.C; 40 A; No. 8/10 AWG

Note:

The air distance of 9.5 mm between the terminals and the mounting base must be guaranteed.

	Poles	Type	Part no.	Std. pack	
	3	KL 58/3 S/1	29.131.1353.0	200	
	5	KL 58/5 S/1	29.131.1553.0	100	
		3 links used as a bridge between poles 3 and 4			
	6	KL 58 S/6 S/1	29.131.1653.0	100	
		3 links used as a bridge between poles 4 and 5			
	3	KL 58/3 S R/1*	29.131.2353.0	200	
	5	KL 58/5 S R/1*	29.131.2553.0	100	
		3 links used as a bridge between poles 3 and 4			
	6	KL 58/6 S R/1*	29.131.2653.0	100	
		3 links used as a bridge between poles 4 and 5			

	T (mm)		G
3pole	36	81	
5pole	72	117	
6pole	90	135	

	T (mm)		G
3pole	36	66.5	
5pole	72	102.5	
6pole	90	120.5	

Special versions with ground connection to the mounting base: upon request

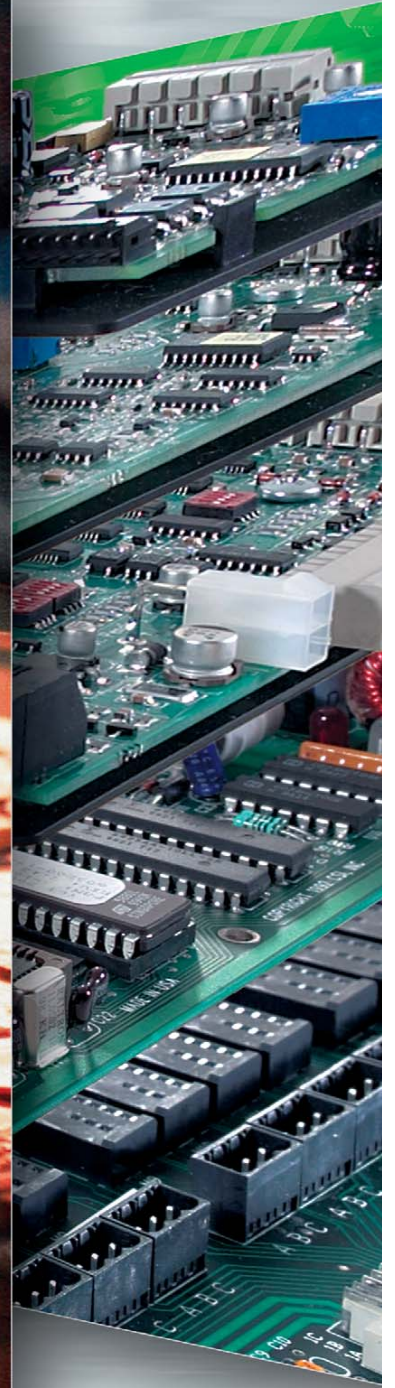
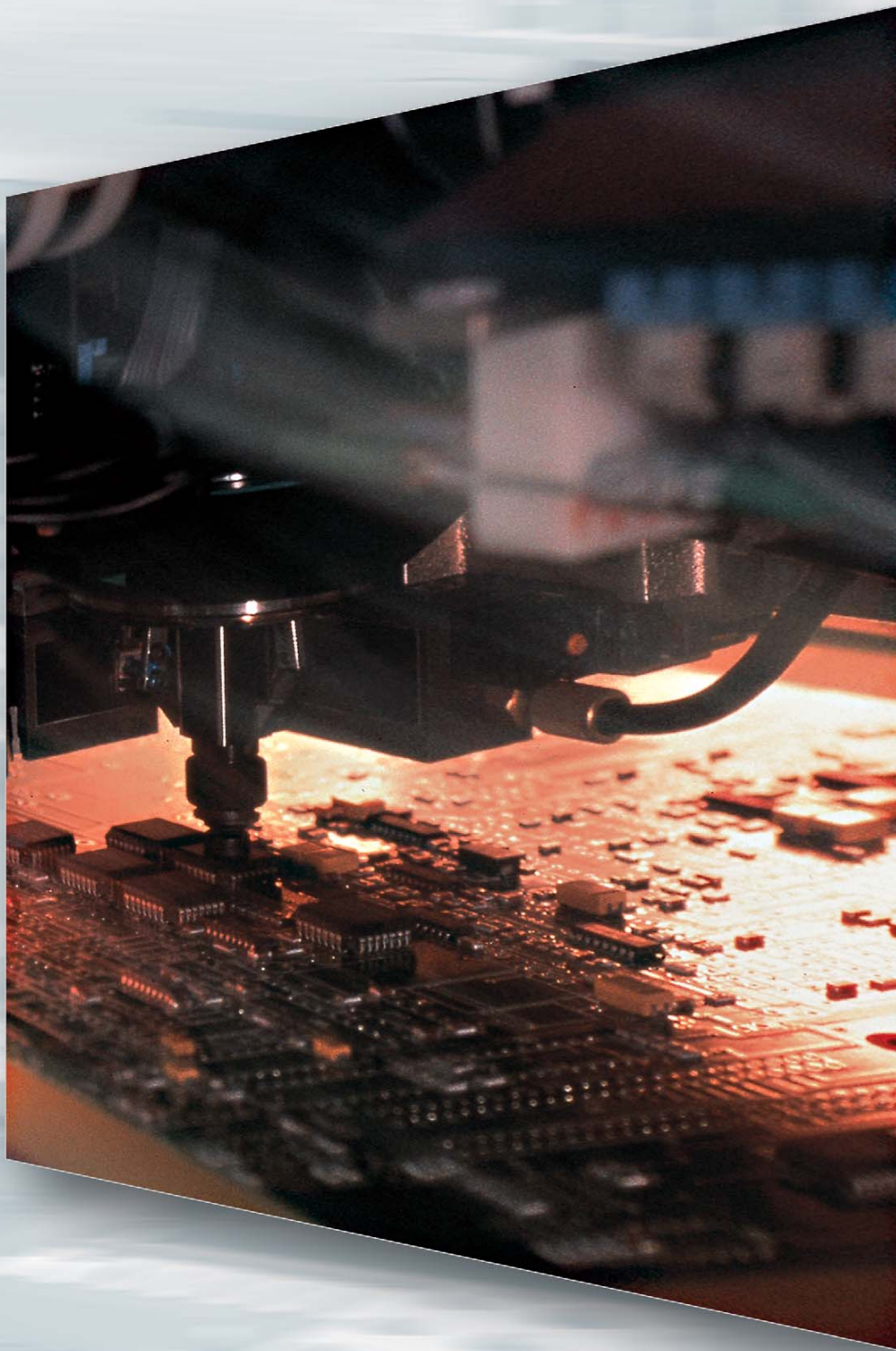

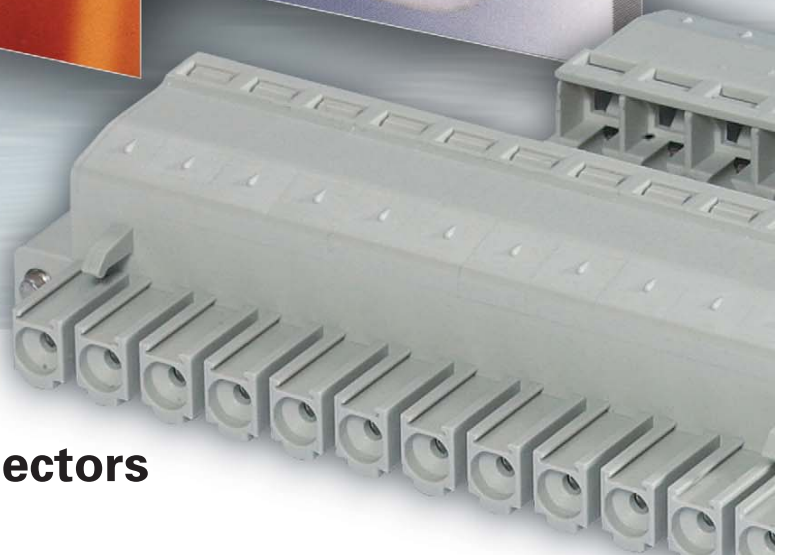
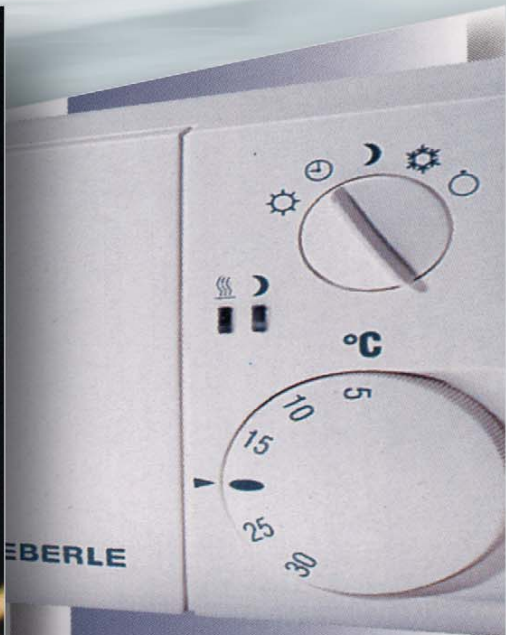
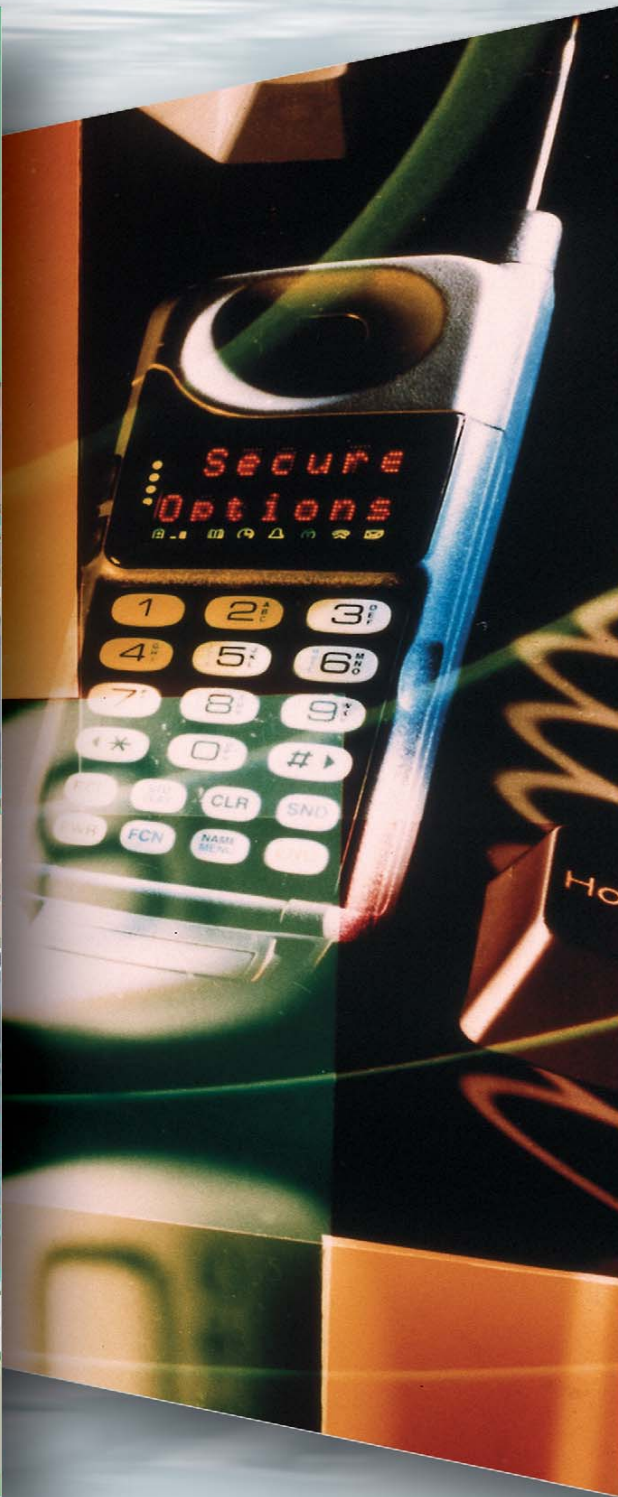
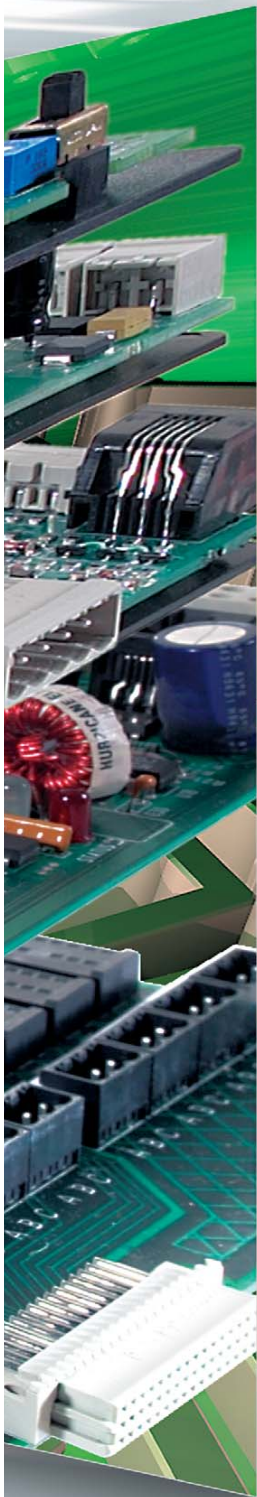

PC Board Connectors

PC board connectors

wiecon

All Wieland Components which require **CE** general certification are **CE** certified, and identified with the **CE** logo.

Pluggable PC board connectors with insulated headers, two piece design

Pluggable PC board connectors with pin strip headers, two piece design

DIN rail terminal blocks with pluggable connectors

Pluggable PC board connectors, edge card

PC board connectors

PC board connectors, 2-tier version

PC board connectors, 3-tier version

PC board connectors, 4-tier version

Special-purpose connectors

RAST 5 connectors
Feed-through modules for control cabinets
Marking tags / marking tag strips

CONTENTS

wiecon

	<p>Spacings: 3.50/3.81 mm</p> <ul style="list-style-type: none"> • Plug connectors, rising cage clamp Page 280 • Plug connectors, spring clamp Page 281 • Insulated headers Page 284 <p>Spacings: 5.00/5.08/7.50/7.62 mm</p> <ul style="list-style-type: none"> • Plug connectors, rising cage clamp Page 286 • Male plug with spring clamp connection (= inverted plug) Page 295 • Plug connectors, spring clamp Page 294 • Board to board connectors Page 295 • Insulated headers Page 297 • Pluggable TOP connector with strain relief Page 320
	<p>Spacings: 3.50/5.00 mm Compression screw clamp Page 316</p> <p>Spacing: 3.50 mm Spring clamp Page 324</p>
	<p>Spacing: 5.00 mm</p> <p>Feed-through DIN rail terminal blocks with pluggable connectors Page 310</p>
	<p>Spacing: 3.50 mm Rising cage clamp Page 328</p> <p>Spacing: 5.00 mm Spring clamp Page 330</p>
	<p>Spacings: 3.50/3.81 mm</p> <ul style="list-style-type: none"> • Rising cage clamp Page 336 <p>Spacings: 5.00/5.08 mm</p> <ul style="list-style-type: none"> • Rising cage clamp Page 286 • Spring clamp Page 292 <p>Spacings: 6.35 mm</p> <p>Spacings: 7.50/7.62 mm</p> <ul style="list-style-type: none"> • Rising cage clamp Page 288 • Spring clamp Page 294 <p>Spacings: 10.00/10.16 mm</p> <ul style="list-style-type: none"> • Rising cage clamp Page 318, 375, 377
	<p>Spacings: 5.00/5.08 mm</p> <ul style="list-style-type: none"> • Rising cage clamp Page 364
	<p>Spacings: 5.00/5.08 mm</p> <ul style="list-style-type: none"> • Rising cage clamp Page 370
	<p>Spacing: 5.00 mm</p> <ul style="list-style-type: none"> • Rising cage clamp Page 373
	<p>Spacing: 5.08 mm</p> <ul style="list-style-type: none"> • Feed through block Page 378 • PCB plunger disconnect block Page 378 • Fused feed through terminal block Page 379 • AS-I connector – IDC Technology Page 392
	<p>Page 380</p> <p>Page 386</p> <p>Page 394</p>

Pluggable PC board connectors with insulated headers, two piece design

wiecon PCB

		Page 298	Page 301	Page 299	Page 299	Page 301	Page 297	Page 300	Page 297	Page 298
Spacing: 5.00/5.08 mm Spacing: 7.50/7.62 mm	Spacing:	5.00/5.08	7.50/7.62	5.00/5.08	5.00/5.08	7.50/7.62	5.00/5.08	7.50/7.62	5.00/5.08	5.00/5.08
		8113 S/W 8213 S/W	8313 S/W 8413 S/W	8113 S/WOF 8213 S/WOF	8113 S/WF 8213 S/WF	8313 S/WF 8413 S/WF	8113 S/G 8213 S/G	8313 S/G 8413 S/G	8113 S/GOF 8213 S/GOF	8113 S/GF 8213 S/GF
	Poles	2 - 24	2 - 12	2 - 24	2 - 22	2 - 12	2 - 24	2 - 12	2 - 24	2 - 22
	Page 291 8113 BK 5.00	2 - 24 ● 8113		● 8113			● 8113		● 8113	
	Page 286 8113 B 8213 B 5.00 5.08	2 - 24 ●		●			●		●	
	Page 292 8113 BFK 8213 BFK 5.00 5.08	2 - 24 ●		●	●		●		●	
	Page 287 8213 B/S 5.08	2 - 24					● 8213		● 8213	
	Page 288 8313 B 8413 B 7.50 7.62	2 - 22	●					●		
	Page 286 8113 B/F 8213 B/F 5.00 5.08	2 - 12			●					●
	Page 288 8313 B/F 8413 B/F 7.50 7.62	2 - 24				●				
	Page 289 8113 B/VL 8213 B/VL 5.00 5.08	2 - 24 ●		●			●		●	
	Page 289 8113 B/VR 8213 B/VR 5.00 5.08	2 - 12 ●		●			●		●	
	Page 290 8413 B/VL 7.62	2 - 12	●					●		
	Page 290 8413 B/VR 7.62	2 - 24	●					●		
	Page 296 8113 B/TOP 8213 B/TOP 5.00 5.08	2 - 24 ●		●			●		●	
	Page 295 8213 BL/G 5.08	2 - 24 ●		●			●		●	
	Page 295 8213 BL/W 5.08	2 - 24 ●		●			●		●	

wiecon



Page 300	Page 302	Page 302	Page 293	Page 303	Page 303	Page 305	Page 305	Page 305	Page 304	Page 304	
7.50/7.62 8113 S/GF 8413 S/GF	5.00/5.08 8113 S/S 8213 S/S	5.00/5.08 8113 S/S1 8213 S/S1	5.08 8213 SUFK	5.00/5.08 8113 SE/W 8213 SE/W	5.00/5.08 8113 SE/G 8213 SE/G	5.08 8213 S/ DFWW	5.08 8213 S/ DFWWM	5.08 8213 S/ DFLS	5.08 8213 S/ DFLSM	5.00/5.08 8113 SEG/W 8213 SEG/W	5.00/5.08 8113 SEG/G 8213 SEG/G
2 - 12	2 - 24	2 - 24	2 - 12 (24)	2 - 24 snap together	2 - 24 snap together	2 - 24	2 - 22 with nut	2 - 24	2 - 22 with nut	2 - 24	2 - 24
	● 8113	● 8113		● 8113	● 8113					● 8113	● 8113
	●	●	● 8213	●	●	●		●		●	●
	●	●	● 8213	●	●	●	●	● 8213	●	●	●
	● 8213	● 8213	●	●	● 8213	●		●	● 8213		● 8213
			● 8213				●		●	●	●
	●										
	●	●	● 8213	●	●	●	●	● 8213	● 8213	●	●
	●	●	● 8213	●	●	●	●	● 8213	● 8213	●	●
	●	●	● 8213	●	●	●		●		●	●
	●	●	● 8213							● 8213	● 8213
			● 8213								



IERTES
 0 9001
 AD
 SICHERUNGSSYSTEM
 -Nr. 14 194-02

PC board connectors with DIN rail terminal blocks pluggable

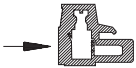
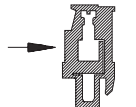
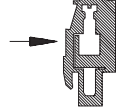
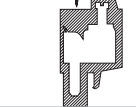
wiecon PCB

		Page 310	Page 310	Page 311	Page 312	Page 312	Page 308
Spacing: 5.00/7.50 mm		5.00	5.00	7.50	5.00	7.50	5.00
		2 – 24 snap together	2 – 24 snap together	2 – 12 snap together	2 – 24 snap together	2 – 12 snap together	2 – 24 snap together
	Page 286 8113 B	5.00	2 – 24	●	●	●	
	Page 288 8313 B	7.50	2 – 12		●	●	
	Page 289 8113 B/VL	5.00	2 – 24	●	●	●	
	Page 289 8113 B/VR	5.00	2 – 24	●	●	●	
	Page 296 8113 B/TOP	5.00	2 – 24	●	●	●	
	Page 292 8113 BFK	5.00	2 – 24	●	●	●	●

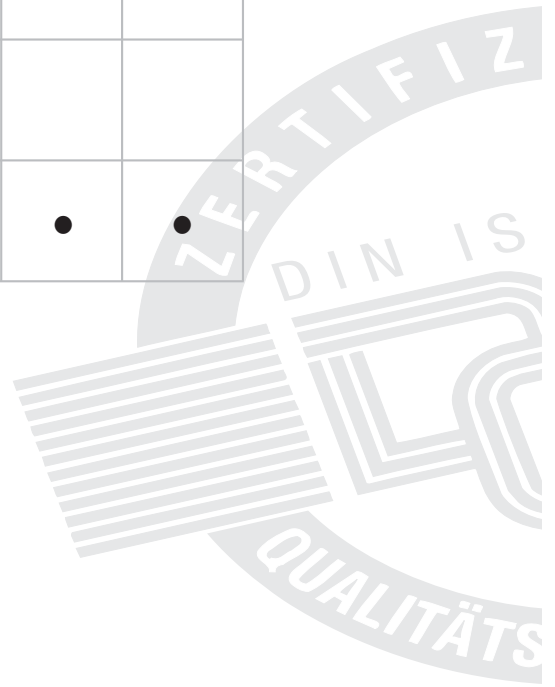

Reg.:

PC board connectors with insulated headers
two-piece design

wiecon

		Page 284	Page 285	Page 284	Page 285
		3.50/3.81	3.50/3.81	3.50/3.81	3.50/3.81
		8513 S/W 8813 S/W	8513 S/WF 8813 S/WF	8513 S/G 8813 S/G	8513 S/GF 8813 S/GF
		2 - 20	2 - 20	2 - 20	2 - 20
	Page 280 8513 B 8813 B	3.50 3.81	2 - 20	●	●
	Page 280 8513 B/F 8813 B/F	3.50 3.81	2 - 20	●	●
	Page 282 8813 B/VR	3.81	2 - 20	● 8813	● 8813
	Page 282 8813 B/VL	3.81	2 - 20	● 8813	● 8813
	Page 283 8813 B/VRF	3.81	2 - 20	● 8813	● 8813
	Page 283 8813 B/VLF	3.81	2 - 20	● 8813	● 8813
	Page 281 8513 BFK	3.50	2 - 20	● 8513	● 8513

wiecon

AP
SICHERUNGSSYSTEM
-Nr. 14 194-02

Pluggable PC board connectors with insulated headers, two piece design

wiecon PCB

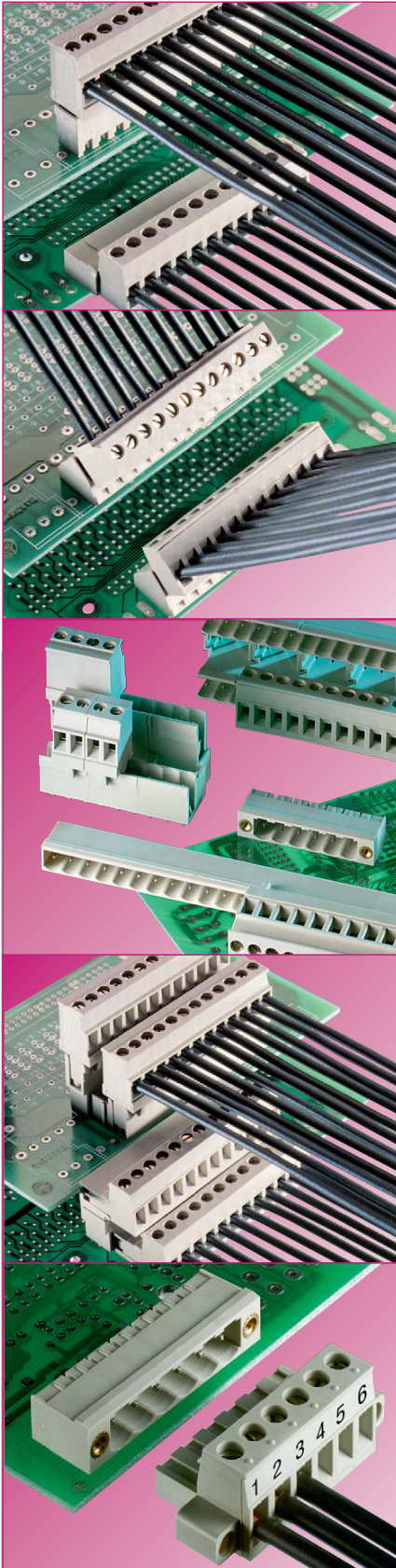

Pluggable connectors provide a simple 2-piece mateable connection between an external connector and the printed circuit board.

System features

- easy-to-operate, application specific
- user-friendly pluggability
- clear, straightforward connection
- mating direction and wire insertion for every application
- quick disconnect
- multiple pole configurations
- connection of solid and fine stranded up to 1.5 mm² and 2.5 mm² (up to 12 AWG)
- metric and inch spacing; inch spacing is indicated by a stud over the wire entry guide
- termination via rising cage clamp (screw connection)
- termination via TOP connection

Flange version

- additional screw connection of plug and insulated header preventing unintentional disconnect
- secure electrical and mechanical connection even under high mechanical stress (e.g. vibration)

Field of application

- pluggable PC board connectors simplify termination and service of PC boards
- with pre-manufactured cable harnesses, units can be adapted to the individual application without problems
- all pluggable PC board connectors can be coded without loss of pole position
- the plugs and their matching insulated headers can be interlocked
- clear markings ensure simple and correct marking

Variety of types

- 2 to 24pole
- mating orientation of the plugs horizontal and vertical to the wire entry
- plugs mate horizontal and vertical to the printed circuit board
- insulated headers with vertical and horizontal solder pins
- insulated headers with pins in 35° angle to the printed circuit board
- insulated headers with closed sides to prevent mis-mating
- open-ended insulated headers permit adjacent stacking without pole loss
- spacings: 3.81/5.00/5.08/7.50/7.62/10.00/10.16 mm
- two-tier headers

Coding

- protection against mis-mating via coding pieces inserted into slots in the plug and header
- coding without pole loss

Marking

- inkjet marking directly on the plug and header with smudge-proof ink
- custom marking possible, consult factory
- clear, easily legible marking

DQS certificates for all products

- quality standard as per DIN ISO 9001
- in Development, Production, Assembly
- continuous verification of the quality standard by means of regular internal and external quality audits
- compatible with certificates of other countries:
 - BSI Certificate, Great Britain
 - SQS Certificate, Switzerland
 - Aib-Vincotte Certificate, Belgium
 - ÖQS Certificate, Austria

wiecon

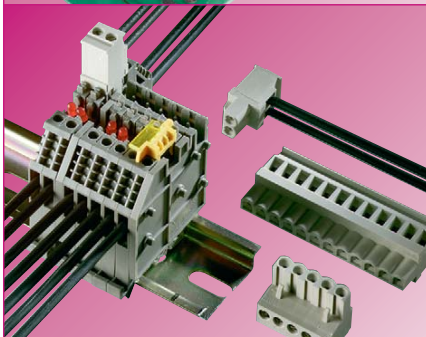
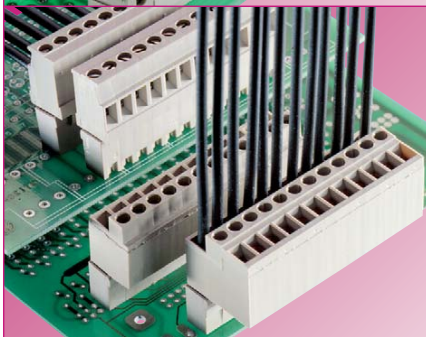
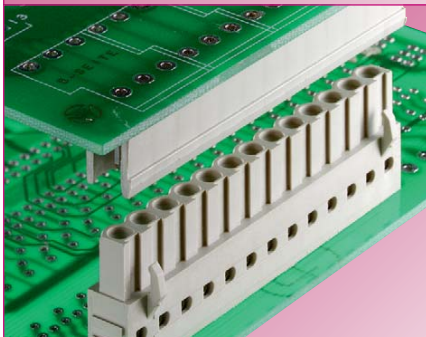
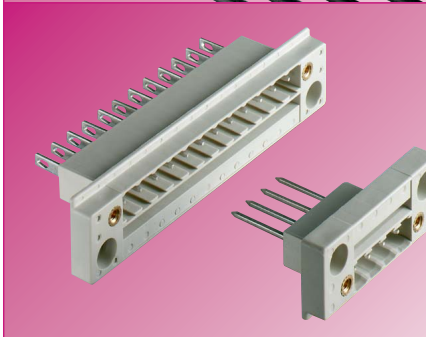
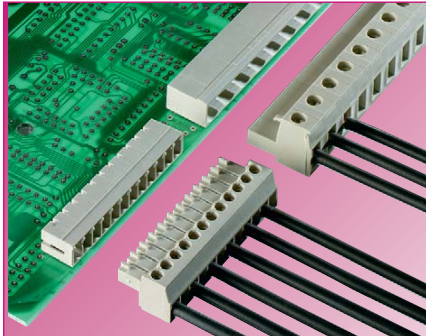

Types 8513-8813

- micro PC board connectors, 2 to 20 pole
- plug and insulated header horizontal and vertical to the printed circuit board
- total height: 11 mm, while only 8 mm above the printed circuit board
- in space-saving 3.5 and 3.81 mm spacing
- connector cross section: 1.5 mm²
- codable:
 - headers with coding pins
 - plug connectors with removable coding studs
- with locking screw flange

Panel mount feed through pluggables

- insulated headers mount directly to panel wall
- provide pluggable connection at panel
- header = panel mount feed through
- optional flange version for vibration secure mating
- header can be affixed with screws to the housing walls
- connection inside the housing via wire-wrap or solder connection

Inverted / board to board connectors

- board mounted female header with vertical and horizontal solder pins
- codable by means of coding pieces inserted in available slots
- interlocking flange available as accessory
- inverted plug available

TOP version

- screw connection, wire entry and mate direction all in same plane
- easy to operate in confined spaces
- with or without integrated LED

Application specific terminals

- for control systems:
 - DIN rail terminal blocks with pluggable connection at one side
 - plug connectors in 5.00 mm spacing
 - snap on to mounting rail
- DIN rail terminal blocks with pluggable connection for system 8113
- vertical plug orientation
- horizontal plug orientation

Material

Metal parts:

- made of special alloys and/or special surface platings
- minimum feed through resistance
- high corrosion resistance
- secure, consistent clamping function
- clamping body and clamping screw: made of nickel-plated brass (TOP version: zinc-plated steel, dichromated)
- plug contacts: tin-plated bronze
- solder pins: made from high-quality copper alloy

Insulating housings:

- Polyamide 66/6 for its excellent electrical, chemical and mechanical characteristics (see section **facts & DATA**)
- all housings UL 94 V-0
- glass-fibre reinforcement for high dimensional stability (not available for multi-tier header and solder parts)
- colors: gray, similar to RAL 7032; black; for others consult factory

Abbreviations for plastic materials:

- PA 66/6 = Polyamide 66/6
- PC = Polycarbonate
- PBT = Polybutylenterephthalate

Note:

The information regarding cross sectional areas and connection types pertains to conductors without ferrules.

The indicated rated current complies with the maximum load of the PCB connector with connected wire of the indicated rated cross section.

The rated voltage is indicated as per DIN VDE 0110 part 1 (IEC 60 664-1) – isolation coordination for electrical material in low voltage applications – and refers to the delivered state of the PC board connectors.

Before the PC board is fitted with connectors, an appropriate printed circuit board must be selected and dimensioned accordingly (e.g. regarding tracking resistance of the printed circuit board, distances of the leads and solder joints).

Furthermore, the ambient conditions under which the device is to be used (pollution degree) must be considered. The indicated rated voltages will be valid for the complete module only if the printed circuit board and its connectors are correctly and carefully matched to each other.

PC board connectors, pluggable, rising cage connection, spacings: 3.50/3.81 mm

wiecon PCB



1.5 mm²

Rated cross section:
1.5 mm²

Rated current:
8 A

Connection range:
0.14 – 1.5 mm² solid / fine stranded

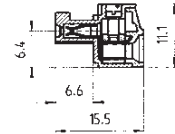
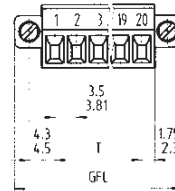
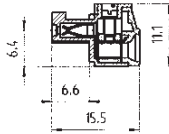
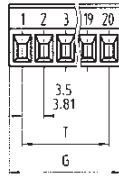

125 V/2.5 kV/3 – Overvoltage category III
250 V/2.5 kV/2 – Overvoltage category II
* 690 V/2.5 kV/1 – Overvoltage category I

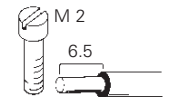
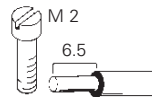

with screw flange

* max. 600 V for ungrounded networks or expected overvoltage ≤ 3 kV for L ≥ 2.00 mm and ≤ 2.5 kV for 2.0 mm > L ≥ 1.5 mm

Rated voltages: VDE 0110
UL ratings
CSA ratings
Approvals

Type 8513 B/..., 8813 B/...

plug-in 180° to wire entry

No. 30 – 16 AWG 300 V 8 A
No. 22 – 14 AWG 300 V 5 A



Type 8513 B/...F, 8813 B/...F

plug-in 180° to wire entry

No. 30 – 16 AWG 300 V 8 A
No. 22 – 14 AWG 300 V 5 A



Std. pack	GFL	G	T	Poles	Part no.	Part no.	Part no.	Part no.
Spacing: 3.50 mm					unmarked	marked	unmarked	marked
100	17.40	7.00	3.50	2	25.640.3253.0	25.640.0253.0	25.641.3253.0	25.641.0253.0
100	20.90	10.50	7.00	3	25.640.3353.0	25.640.0353.0	25.641.3353.0	25.641.0353.0
50	24.40	14.00	10.50	4	25.640.3453.0	25.640.0453.0	25.641.3453.0	25.641.0453.0
50	27.90	17.50	14.00	5	25.640.3553.0	25.640.0553.0	25.641.3553.0	25.641.0553.0
50	31.40	21.00	17.50	6	25.640.3653.0	25.640.0653.0	25.641.3653.0	25.641.0653.0
50	34.90	24.50	21.00	7	25.640.3753.0	25.640.0753.0	25.641.3753.0	25.641.0753.0
50	38.40	28.00	24.50	8	25.640.3853.0	25.640.0853.0	25.641.3853.0	25.641.0853.0
50	41.90	31.50	28.00	9	25.640.3953.0	25.640.0953.0	25.641.3953.0	25.641.0953.0
50	45.40	35.00	31.50	10	25.640.4053.0	25.640.1053.0	25.641.4053.0	25.641.1053.0
50	48.90	38.50	35.00	11	25.640.4153.0	25.640.1153.0	25.641.4153.0	25.641.1153.0
50	52.40	42.00	38.50	12	25.640.4253.0	25.640.1253.0	25.641.4253.0	25.641.1253.0
50	55.90	45.50	42.00	13	25.640.4353.0	25.640.1353.0	25.641.4353.0	25.641.1353.0
50	59.40	49.00	45.50	14	25.640.4453.0	25.640.1453.0	25.641.4453.0	25.641.1453.0
50	62.90	52.50	49.00	15	25.640.4553.0	25.640.1553.0	25.641.4553.0	25.641.1553.0
50	66.40	56.00	52.50	16	25.640.4653.0	25.640.1653.0	25.641.4653.0	25.641.1653.0
17 to 20pole upon request								
Spacing: 3.81 mm					unmarked	marked	unmarked	marked
100	18.01	8.41	3.81	2	25.620.3253.0	25.620.0253.0	25.621.3253.0	25.621.0253.0
100	21.82	12.22	7.62	3	25.620.3353.0	25.620.0353.0	25.621.3353.0	25.621.0353.0
50	25.63	16.03	11.43	4	25.620.3453.0	25.620.0453.0	25.621.3453.0	25.621.0453.0
50	29.44	19.84	15.24	5	25.620.3553.0	25.620.0553.0	25.621.3553.0	25.621.0553.0
50	33.25	23.65	19.05	6	25.620.3653.0	25.620.0653.0	25.621.3653.0	25.621.0653.0
50	37.06	27.46	22.86	7	25.620.3753.0	25.620.0753.0	25.621.3753.0	25.621.0753.0
50	40.87	31.27	26.67	8	25.620.3853.0	25.620.0853.0	25.621.3853.0	25.621.0853.0
50	44.68	35.08	30.48	9	25.620.3953.0	25.620.0953.0	25.621.3953.0	25.621.0953.0
50	48.49	38.89	34.29	10	25.620.4053.0	25.620.1053.0	25.621.4053.0	25.621.1053.0
50	52.30	42.70	38.10	11	25.620.4153.0	25.620.1153.0	25.621.4153.0	25.621.1153.0
50	56.11	46.51	41.91	12	25.620.4253.0	25.620.1253.0	25.621.4253.0	25.621.1253.0
50	59.92	50.32	45.72	13	25.620.4353.0	25.620.1353.0	25.621.4353.0	25.621.1353.0
50	63.73	54.13	49.53	14	25.620.4453.0	25.620.1453.0	25.621.4453.0	25.621.1453.0
50	67.54	57.94	53.34	15	25.620.4553.0	25.620.1553.0	25.621.4553.0	25.621.1553.0
50	71.35	61.75	57.15	16	25.620.4653.0	25.620.1653.0	25.621.4653.0	25.621.1653.0
17 to 20pole upon request								

PC board connectors, pluggable, spring clamp connection, spacing: 3.50 mm

codable

Rated cross section:
1.5 mm²

Rated current:
8 A

Connection range:
0.14 – 1.5 mm² solid / fine stranded

125 V/2.5 kV/3 – Overvoltage category III
250 V/2.5 kV/2 – Overvoltage category II
* 690 V/2.5 kV/1 – Overvoltage category I

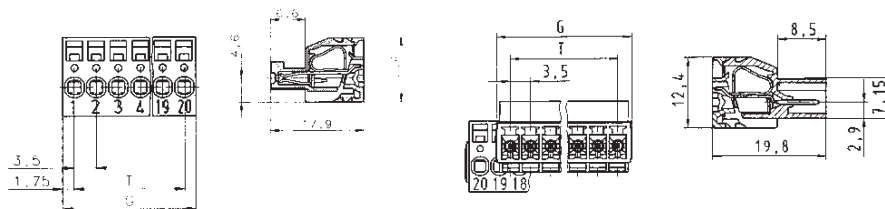

* max. 600 V for ungrounded networks or expected overvoltage ≤ 3 kV for L ≥ 2.00 mm and ≤ 2.5 kV for 2.0 mm > L ≥ 1.5 mm

Type 8513 BFK

Type 8513 SUFK

VDE 0110
UL ratings
CSA ratings
Approvals

No. 30 – 16 AWG
No. 22 – 14 AWG

300 V
300 V

8 A
5 A

No. 30 – 16 AWG
No. 22 – 14 AWG

300 V
300 V

8 A
5 A



Std. pack	G	T	Poles	Part no.	Part no.	Part no.	Part no.
Spacing: 3.50 mm				Type 8513 BFK	unmarked	marked	
100	6.90	3.50	2	25.630.3253.0	25.630.0253.0		
100	10.40	7.00	3	25.630.3353.0	25.630.0353.0		
50	13.90	10.50	4	25.630.3453.0	25.630.0453.0		
50	17.40	14.00	5	25.630.3553.0	25.630.0553.0		
50	20.90	17.50	6	25.630.3653.0	25.630.0653.0		
50	24.40	21.00	7	25.630.3753.0	25.630.0753.0		
50	27.90	24.50	8	25.630.3853.0	25.630.0853.0		
50	31.40	28.00	9	25.630.3953.0	25.630.0953.0		
50	34.90	31.50	10	25.630.4053.0	25.630.1053.0		
50	38.40	35.00	11	25.630.4153.0	25.630.1153.0		
50	41.90	38.50	12	25.630.4253.0	25.630.1253.0		
50	45.40	42.00	13	25.630.4353.0	25.630.1353.0		
50	48.90	45.50	14	25.630.4453.0	25.630.1453.0		
50	52.40	49.00	15	25.630.4553.0	25.630.1553.0		
50	55.90	52.50	16	25.630.4653.0	25.630.1653.0		
17 to 24pole upon request							
Spacing: 3.50 mm				Type 8513 SUFK	unmarked	marked	
100	8.40	3.50	2		25.642.3253.0	25.642.0253.0	
100	11.90	7.00	3		25.642.3353.0	25.642.0353.0	
50	15.40	10.50	4		25.642.3453.0	25.642.0453.0	
50	18.90	14.00	5		25.642.3553.0	25.642.0553.0	
50	22.40	17.50	6		25.642.3653.0	25.642.0653.0	
50	25.90	21.00	7		25.642.3753.0	25.642.0753.0	
50	29.40	24.50	8		25.642.3853.0	25.642.0853.0	
50	32.90	28.00	9		25.642.3953.0	25.642.0953.0	
50	36.40	31.50	10		25.642.4053.0	25.642.1053.0	
50	39.90	35.00	11		25.642.4153.0	25.642.1153.0	
50	43.40	38.50	12		25.642.4253.0	25.642.1253.0	
	46.90	42.00	13		25.642.4353.0	25.642.1353.0	
	50.40	45.50	14		25.642.4453.0	25.642.1453.0	
	53.90	49.00	15		25.642.4553.0	25.642.1553.0	
	57.40	52.50	16		25.642.4653.0	25.642.1653.0	
17 to 24pole upon request							
Accessories:							
Screwdriver DIN 5264 A 0.4 x 2.5				5	06.502.4300.0		

wiecon

wiecon

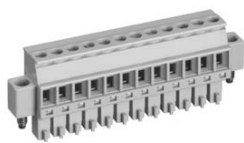
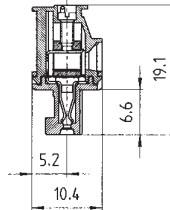
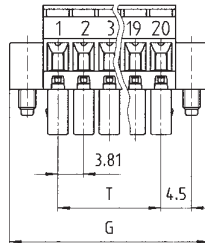
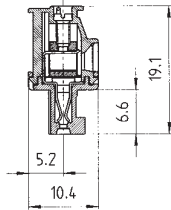
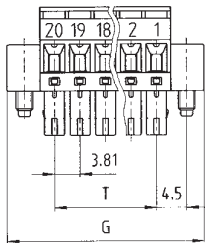

with screw flange

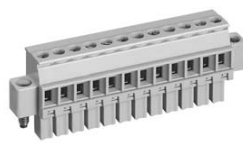
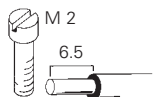

with screw flange

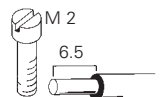

Type 8813 B/... VR F

vertical right plug, 90° to wire entry

No. 30 – 16 AWG
No. 22 – 14 AWG

300 V 8 A
300 V 5 A



Type 8813 B/... VL F

vertical left plug, 90° to wire entry

No. 30 – 16 AWG
No. 22 – 14 AWG

300 V 8 A
300 V 5 A



Part no.	Part no.	Part no.	Part no.	
unmarked	marked	unmarked	marked	
25.623.3253.0	25.623.0253.0	25.625.3253.0	25.625.0253.0	
25.623.3353.0	25.623.0353.0	25.625.3353.0	25.625.0353.0	
25.623.3453.0	25.623.0453.0	25.625.3453.0	25.625.0453.0	
25.623.3553.0	25.623.0553.0	25.625.3553.0	25.625.0553.0	
25.623.3653.0	25.623.0653.0	25.625.3653.0	25.625.0653.0	
25.623.3753.0	25.623.0753.0	25.625.3753.0	25.625.0753.0	
25.623.3853.0	25.623.0853.0	25.625.3853.0	25.625.0853.0	
25.623.3953.0	25.623.0953.0	25.625.3953.0	25.625.0953.0	
25.623.4053.0	25.623.1053.0	25.625.4053.0	25.625.1053.0	
25.623.4153.0	25.623.1153.0	25.625.4153.0	25.625.1153.0	
25.623.4253.0	25.623.1253.0	25.625.4253.0	25.625.1253.0	
25.623.4353.0	25.623.1353.0	25.625.4353.0	25.625.1353.0	
25.623.4453.0	25.623.1453.0	25.625.4453.0	25.625.1453.0	
25.623.4553.0	25.623.1553.0	25.625.4553.0	25.625.1553.0	
25.623.4653.0	25.640.1653.0	25.625.4653.0	25.625.1653.0	



Insulated headers for PC boards

Spacings: 3.50/3.81 mm

wiecon PCB

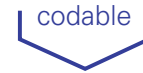

1.5 mm²

Rated current:
8 A

125 V/2.5 kV/3 – Overvoltage category III
250 V/2.5 kV/2 – Overvoltage category II
* 690 V/2.5 kV/1 – Overvoltage category I

Approvals for type 8513 available soon

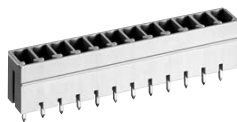
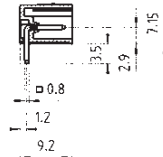
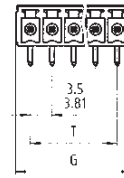
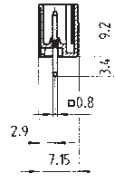
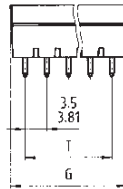

Solder pin 0.8 x 0.8 mm
Bore hole Ø 1.2 mm

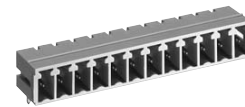

Solder pin 0.8 x 0.8 mm
Bore hole Ø 1.2 mm

* max. 600 V for ungrounded networks or expected overvoltage ≤ 3 kV for L ≥ 2.00 mm and ≤ 2.5 kV for 2.0 mm > L ≥ 1.5 mm

Type 8513 S/... G, 8813 S/... G
vertical mount

Type 8513 S/... W, 8813 S/... W
horizontal mount

Rated voltages: VDE 0110
UL ratings
CSA ratings
Approvals

300 V 8 A
300 V 5 A

300 V 8 A
300 V 5 A



Std. pack	GFL	G	T	Poles	Part no.	Part no.	Part no.	Part no.
Spacing: 3.50 mm					unmarked		unmarked	
100	17.40	8.40	3.50	2	25.646.0253.0		25.647.0253.0	
100	20.90	11.90	7.00	3	25.646.0353.0		25.647.0353.0	
50	24.40	15.40	10.50	4	25.646.0453.0		25.647.0453.0	
50	27.90	18.90	14.00	5	25.646.0553.0		25.647.0553.0	
50	31.40	22.40	17.50	6	25.646.0653.0		25.647.0653.0	
50	34.90	25.90	21.00	7	25.646.0753.0		25.647.0753.0	
50	38.40	29.40	24.50	8	25.646.0853.0		25.647.0853.0	
50	41.90	32.90	28.00	9	25.646.0953.0		25.647.0953.0	
50	45.40	36.40	31.50	10	25.646.1053.0		25.647.1053.0	
50	48.90	39.90	35.00	11	25.646.1153.0		25.647.1153.0	
50	52.40	43.40	38.50	12	25.646.1253.0		25.647.1253.0	
50	55.90	46.90	42.00	13	25.646.1353.0		25.647.1353.0	
50	59.40	50.40	45.50	14	25.646.1453.0		25.647.1453.0	
50	62.90	53.90	49.00	15	25.646.1553.0		25.647.1553.0	
50	66.40	57.40	52.50	16	25.646.1653.0		25.647.1653.0	
17 to 20pole upon request								
Spacing: 3.81 mm					unmarked		unmarked	
100	18.01	9.01	3.81	2	25.626.0253.0		25.627.0253.0	
100	21.82	12.82	7.62	3	25.626.0353.0		25.627.0353.0	
50	25.63	16.63	11.43	4	25.626.0453.0		25.627.0453.0	
50	29.44	20.44	15.24	5	25.626.0553.0		25.627.0553.0	
50	33.25	24.25	19.05	6	25.626.0653.0		25.627.0653.0	
50	37.06	28.06	22.86	7	25.626.0753.0		25.627.0753.0	
50	40.87	31.87	26.67	8	25.626.0853.0		25.627.0853.0	
50	44.68	35.68	30.48	9	25.626.0953.0		25.627.0953.0	
50	48.49	39.49	34.29	10	25.626.1053.0		25.627.1053.0	
50	52.30	43.30	38.10	11	25.626.1153.0		25.627.1153.0	
50	56.11	47.11	41.91	12	25.626.1253.0		25.627.1253.0	
50	59.92	50.92	45.72	13	25.626.1353.0		25.627.1353.0	
50	63.73	54.73	49.53	14	25.626.1453.0		25.627.1453.0	
50	67.54	58.54	53.34	15	25.626.1553.0		25.627.1553.0	
50	71.35	62.35	57.15	16	25.626.1653.0		25.627.1653.0	
17 to 20pole upon request								
Accessories:								
Coding piece (strip)	100				05.561.0053.0		05.561.0053.0	
Coding studs are molded into plugs; remove with knife at desired coding location								

wiecon

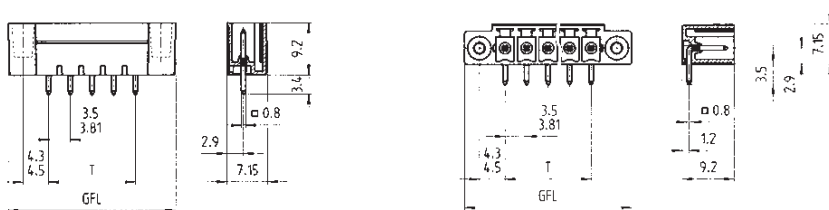

with screw flange

Solder pin 0.8 x 0.8 mm
Bore hole Ø 1.2 mm



with screw flange

Solder pin 0.8 x 0.8 mm
Bore hole Ø 1.2 mm

Type 8513 S/... GF, 8813 S/... GF

vertical mount

300 V 8 A
300 V 5 A



Type 8513 S/... WF, 8813 S/... WF

horizontal mount

300 V 8 A
300 V 5 A



Part no.	Part no.	Part no.	Part no.
unmarked		unmarked	
25.646.3253.0		25.647.3253.0	
25.646.3353.0		25.647.3353.0	
25.646.3453.0		25.647.3453.0	
25.646.3553.0		25.647.3553.0	
25.646.3653.0		25.647.3653.0	
25.646.3753.0		25.647.3753.0	
25.646.3853.0		25.647.3853.0	
25.646.3953.0		25.647.3953.0	
25.646.4053.0		25.647.4053.0	
25.646.4153.0		25.647.4153.0	
25.646.4253.0		25.647.4253.0	
25.646.4353.0		25.647.4353.0	
25.646.4453.0		25.647.4453.0	
25.646.4553.0		25.647.4553.0	
25.646.4653.0		25.647.4653.0	
unmarked		unmarked	
25.626.3253.0		25.627.3253.0	
25.626.3353.0		25.627.3353.0	
25.626.3453.0		25.627.3453.0	
25.626.3553.0		25.627.3553.0	
25.626.3653.0		25.627.3653.0	
25.626.3753.0		25.627.3753.0	
25.626.3853.0		25.627.3853.0	
25.626.3953.0		25.627.3953.0	
25.626.4053.0		25.627.4053.0	
25.626.4153.0		25.627.4153.0	
25.626.4253.0		25.627.4253.0	
25.626.4353.0		25.627.4353.0	
25.626.4453.0		25.627.4453.0	
25.626.4553.0		25.627.4553.0	
25.626.4653.0		25.627.4653.0	
05.561.0053.0		05.561.0053.0	

PC board connectors, pluggable, rising cage connection, spacings: 5.00/5.08 mm

wiecon PCB

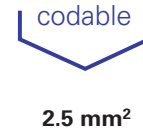

Rated cross section:
2.5 mm²

Rated current:
12 A

Connection range:
0.14 – 2.5 mm² solid / fine stranded

250 V/4 kV/3 – Overvoltage category III
400 V/4 kV/2 – Overvoltage category II
1000 V/4 kV/1 – Overvoltage category I

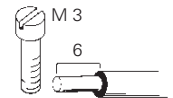
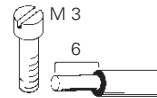
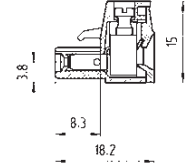
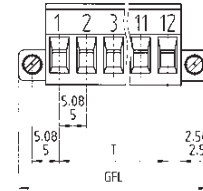
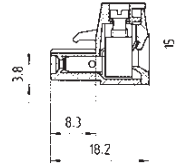
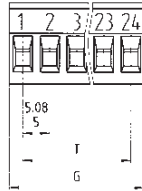

Type 8113 B/..., 8213 B/...
plug-in 180° to wire entry

Type 8113 B/... F, 8213 B/... F
plug-in 180° to wire entry

Rated voltages: VDE 0110
UL ratings
CSA ratings
Approvals

No. 22 – 12 AWG 300 V 15 A
No. 22 – 12 AWG 300 V 15 A

No. 22 – 12 AWG 300 V 15 A
No. 22 – 12 AWG 300 V 15 A

Std. pack	GFL	G	T	Poles	Part no.	Part no.	Part no.	Part no.
Spacing: 5.00 mm					Type 8113		Type 8113 F	
					unmarked	marked	unmarked	marked
100	20	10	5	2	25.320.3253.0	25.320.0253.0	25.322.3253.0	25.322.0253.0
100	25	15	10	3	25.320.3353.0	25.320.0353.0	25.322.3353.0	25.322.0353.0
50	30	20	15	4	25.320.3453.0	25.320.0453.0	25.322.3453.0	25.322.0453.0
50	35	25	20	5	25.320.3553.0	25.320.0553.0	25.322.3553.0	25.322.0553.0
50	40	30	25	6	25.320.3653.0	25.320.0653.0	25.322.3653.0	25.322.0653.0
50	45	35	30	7	25.320.3753.0	25.320.0753.0	25.322.3753.0	25.322.0753.0
50	50	40	35	8	25.320.3853.0	25.320.0853.0	25.322.3853.0	25.322.0853.0
50	55	45	40	9	25.320.3953.0	25.320.0953.0	25.322.3953.0	25.322.0953.0
50	60	50	45	10	25.320.4053.0	25.320.1053.0	25.322.4053.0	25.322.1053.0
50	65	55	50	11	25.320.4153.0	25.320.1153.0	25.322.4153.0	25.322.1153.0
50	70	60	55	12	25.320.4253.0	25.320.1253.0	25.322.4253.0	25.322.1253.0
50	75	65	60	13	25.320.4353.0	25.320.1353.0	25.322.4353.0	25.322.1353.0
50	80	70	65	14	25.320.4453.0	25.320.1453.0	25.322.4453.0	25.322.1453.0
50	85	75	70	15	25.320.4553.0	25.320.1553.0	25.322.4553.0	25.322.1553.0
50	90	80	75	16	25.320.4653.0	25.320.1653.0	25.322.4653.0	25.322.1653.0
					17 to 24pole upon request		17 to 22pole upon request	
Spacing: 5.08 mm					Type 8213		Type 8213 F	
					unmarked	marked	unmarked	marked
100	20.32	10.16	5.08	2	25.340.3253.0	25.340.0253.0	25.323.3253.0	25.323.0253.0
100	25.40	15.24	10.16	3	25.340.3353.0	25.340.0353.0	25.323.3353.0	25.323.0353.0
50	30.48	20.32	15.24	4	25.340.3453.0	25.340.0453.0	25.323.3453.0	25.323.0453.0
50	35.56	25.40	20.32	5	25.340.3553.0	25.340.0553.0	25.323.3553.0	25.323.0553.0
50	40.64	30.48	25.40	6	25.340.3653.0	25.340.0653.0	25.323.3653.0	25.323.0653.0
50	45.72	35.56	30.48	7	25.340.3753.0	25.340.0753.0	25.323.3753.0	25.323.0753.0
50	50.80	40.64	35.56	8	25.340.3853.0	25.340.0853.0	25.323.3853.0	25.323.0853.0
50	55.88	45.72	40.64	9	25.340.3953.0	25.340.0953.0	25.323.3953.0	25.323.0953.0
50	60.96	50.80	45.72	10	25.340.4053.0	25.340.1053.0	25.323.4053.0	25.323.1053.0
50	66.04	55.88	50.80	11	25.340.4153.0	25.340.1153.0	25.323.4153.0	25.323.1153.0
50	71.12	60.96	55.88	12	25.340.4253.0	25.340.1253.0	25.323.4253.0	25.323.1253.0
50	76.20	66.04	60.96	13	25.340.4353.0	25.340.1353.0	25.323.4353.0	25.323.1353.0
50	81.28	71.12	66.04	14	25.340.4453.0	25.340.1453.0	25.323.4453.0	25.323.1453.0
50	86.36	76.20	71.12	15	25.340.4553.0	25.340.1553.0	25.323.4553.0	25.323.1553.0
50	91.44	81.28	76.20	16	25.340.4653.0	25.340.1653.0	25.323.4653.0	25.323.1653.0
					17 to 22pole upon request		17 to 22pole upon request	
Accessories:								
Coding piece (strip)	100				05.561.9153.0	05.561.9153.0		

PC board connectors, pluggable, rising cage connection, spacings: 7.50/7.62 mm

wiecon PCB



2.5 mm²

Rated cross section:
2.5 mm²

Rated current:
12 A

Connection range:
0.14 – 2.5 mm² solid / fine stranded

400 V/4 kV/3 – Overvoltage category III
690 V/4 kV/2 – Overvoltage category II
1000 V/4 kV/1 – Overvoltage category I

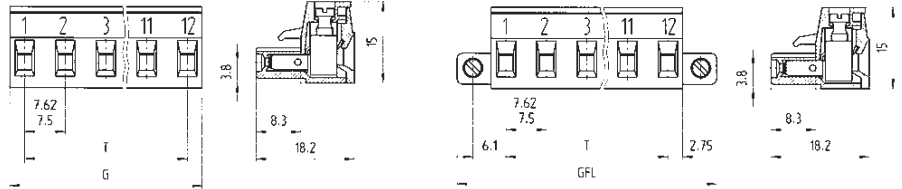

Type 8313 B/..., 8413 B/...
plug-in 180° to wire entry

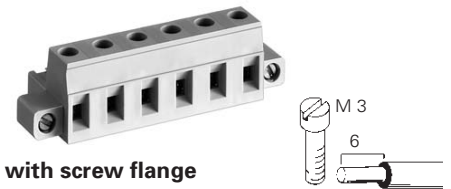

Type 8313 B/... F, 8413 B/... F
plug-in 180° to wire entry

Rated voltages: VDE 0110
UL ratings
CSA ratings
Approvals

No. 22 – 12 AWG
No. 22 – 12 AWG

300 V 15 A
300 V 15 A



No. 22 – 12 AWG
No. 22 – 12 AWG

300 V 15 A
300 V 15 A



Std. pack	GFL	G	T	Poles	Part no.	Part no.	Part no.	Part no.	
Spacing: 7.50 mm					Type 8313	unmarked	marked	unmarked	marked
100	25.54	13.00	7.50	2	25.360.3253.0	25.360.0253.0	25.324.2253.0	25.324.0253.0	
100	33.04	20.50	15.00	3	25.360.3353.0	25.360.0353.0	25.324.2353.0	25.324.0353.0	
50	40.54	28.00	22.50	4	25.360.3453.0	25.360.0453.0	25.324.2453.0	25.324.0453.0	
50	48.04	35.50	30.00	5	25.360.3553.0	25.360.0553.0	25.324.2553.0	25.324.0553.0	
50	55.54	43.00	37.50	6	25.360.3653.0	25.360.0653.0	25.324.2653.0	25.324.0653.0	
50	63.04	50.50	45.00	7	25.360.3753.0	25.360.0753.0	25.324.2753.0	25.324.0753.0	
50	70.54	58.00	52.50	8	25.360.3853.0	25.360.0853.0	25.324.2853.0	25.324.0853.0	
50	78.04	65.50	60.00	9	25.360.3953.0	25.360.0953.0	25.324.2953.0	25.324.0953.0	
50	85.54	73.00	67.50	10	25.360.4053.0	25.360.1053.0	25.324.3053.0	25.324.1053.0	
50	93.04	80.50	75.00	11	25.360.4153.0	25.360.1153.0	25.324.3153.0	25.324.1153.0	
50	100.54	88.00	82.50	12	25.360.4253.0	25.360.1253.0	25.324.3253.0	25.324.1253.0	
Spacing: 7.62 mm					Type 8413	unmarked	marked	unmarked	marked
100	25.66	13.12	7.62	2	25.380.3253.0	25.380.0253.0	25.324.6253.0	25.324.0253.0	
100	33.28	20.74	15.24	3	25.380.3353.0	25.380.0353.0	25.324.6353.0	25.324.0353.0	
50	40.90	28.36	22.86	4	25.380.3453.0	25.380.0453.0	25.324.6453.0	25.324.0453.0	
50	48.52	35.98	30.48	5	25.380.3553.0	25.380.0553.0	25.324.6553.0	25.324.0553.0	
50	56.14	43.60	38.10	6	25.380.3653.0	25.380.0653.0	25.324.6653.0	25.324.0653.0	
50	63.76	51.22	45.72	7	25.380.3753.0	25.380.0753.0	25.324.6753.0	25.324.0753.0	
50	71.38	58.84	53.34	8	25.380.3853.0	25.380.0853.0	25.324.6853.0	25.324.0853.0	
50	79.00	66.46	60.96	9	25.380.3953.0	25.380.0953.0	25.324.6953.0	25.324.0953.0	
50	86.62	74.08	68.58	10	25.380.4053.0	25.380.1053.0	25.324.7053.0	25.324.1053.0	
50	94.24	81.70	76.20	11	25.380.4153.0	25.380.1153.0	25.324.7153.0	25.324.1153.0	
50	101.86	89.32	83.82	12	25.380.4253.0	25.380.1253.0	25.324.7253.0	25.324.1253.0	
Accessories:									
Coding piece (strip)	100				05.561.9153.0		05.561.9153.0		

PC board connectors, pluggable, rising cage connection, spacings 5.00/5.08 mm



2.5 mm²

Rated cross section:
2.5 mm²

Rated current:
12 A

Connection range:
0.14 – 2.5 mm² solid / fine stranded

250 V/4 kV/3 – Overvoltage category III
400 V/4 kV/2 – Overvoltage category II
1000 V/4 kV/1 – Overvoltage category I

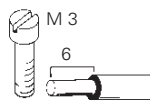
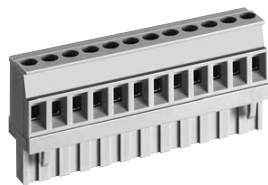
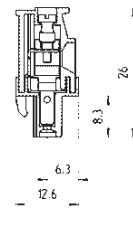
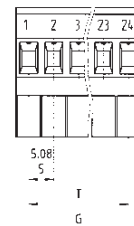
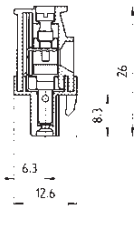
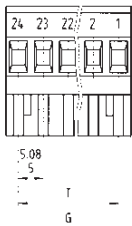

Type 8113 B/... VR, 8213 B/... VR
vertical right plug, 90° to wire entry

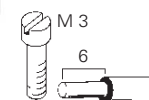

Type 8113 B/... VL, 8213 B/... VL
vertical left plug, 90° to wire entry

Rated voltages: VDE 0110
UL ratings
CSA ratings
Approvals

No. 22 – 12 AWG 300 V 15 A
No. 22 – 12 AWG 300 V 15 A

No. 22 – 12 AWG 300 V 15 A
No. 22 – 12 AWG 300 V 15 A



Std. pack	G	T	Poles	Part no.	Part no.	Part no.	Part no.
Spacing: 5.00 mm				Type 8113		unmarked marked	
100	10	5	2	25.325.3253.0	25.325.0253.0	25.326.3253.0	25.326.0253.0
100	15	10	3	25.325.3353.0	25.325.0353.0	25.326.3353.0	25.326.0353.0
50	20	15	4	25.325.3453.0	25.325.0453.0	25.326.3453.0	25.326.0453.0
50	25	20	5	25.325.3553.0	25.325.0553.0	25.326.3553.0	25.326.0553.0
50	30	25	6	25.325.3653.0	25.325.0653.0	25.326.3653.0	25.326.0653.0
50	35	30	7	25.325.3753.0	25.325.0753.0	25.326.3753.0	25.326.0753.0
50	40	35	8	25.325.3853.0	25.325.0853.0	25.326.3853.0	25.326.0853.0
50	45	40	9	25.325.3953.0	25.325.0953.0	25.326.3953.0	25.326.0953.0
50	50	45	10	25.325.4053.0	25.325.1053.0	25.326.4053.0	25.326.1053.0
50	55	50	11	25.325.4153.0	25.325.1153.0	25.326.4153.0	25.326.1153.0
50	60	55	12	25.325.4253.0	25.325.1253.0	25.326.4253.0	25.326.1253.0
50	65	60	13	25.325.4353.0	25.325.1353.0	25.326.4353.0	25.326.1353.0
50	70	65	14	25.325.4453.0	25.325.1453.0	25.326.4453.0	25.326.1453.0
50	75	70	15	25.325.4553.0	25.325.1553.0	25.326.4553.0	25.326.1553.0
50	80	75	16	25.325.4653.0	25.325.1653.0	25.326.4653.0	25.326.1653.0
17 to 24pole upon request							
Spacing: 5.08 mm				Type 8213		unmarked marked	
100	10.16	5.08	2	25.345.3253.0	25.345.0253.0	25.346.3253.0	25.346.0253.0
100	15.24	10.16	3	25.345.3353.0	25.345.0353.0	25.346.3353.0	25.346.0353.0
50	20.32	15.24	4	25.345.3453.0	25.345.0453.0	25.346.3453.0	25.346.0453.0
50	25.40	20.32	5	25.345.3553.0	25.345.0553.0	25.346.3553.0	25.346.0553.0
50	30.48	25.40	6	25.345.3653.0	25.345.0653.0	25.346.3653.0	25.346.0653.0
50	35.56	30.48	7	25.345.3753.0	25.345.0753.0	25.346.3753.0	25.346.0753.0
50	40.64	35.56	8	25.345.3853.0	25.345.0853.0	25.346.3853.0	25.346.0853.0
50	45.72	40.64	9	25.345.3953.0	25.345.0953.0	25.346.3953.0	25.346.0953.0
50	50.80	45.72	10	25.345.4053.0	25.345.1053.0	25.346.4053.0	25.346.1053.0
50	55.88	50.80	11	25.345.4153.0	25.345.1153.0	25.346.4153.0	25.346.1153.0
50	60.96	55.88	12	25.345.4253.0	25.345.1253.0	25.346.4253.0	25.346.1253.0
50	66.04	60.96	13	25.345.4353.0	25.345.1353.0	25.346.4353.0	25.346.1353.0
50	71.12	66.04	14	25.345.4453.0	25.345.1453.0	25.346.4453.0	25.346.1453.0
50	76.20	71.12	15	25.345.4553.0	25.345.1553.0	25.346.4553.0	25.346.1553.0
50	81.28	76.20	16	25.345.4653.0	25.345.1653.0	25.346.4653.0	25.346.1653.0
17 to 24pole upon request							
Accessories:							
Coding piece (strip)	100			05.561.9153.0			05.561.9153.0



PC board connectors, pluggable, rising cage connection, spacing: 7.62 mm

wiecon PCB

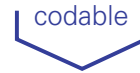

Rated cross section:
2.5 mm²

Rated current:
12 A

Connection range:
0.14 – 2.5 mm² solid / fine stranded

400 V/4 kV/3 – Overvoltage category III
690 V/4 kV/2 – Overvoltage category II
1000 V/4 kV/1 – Overvoltage category I

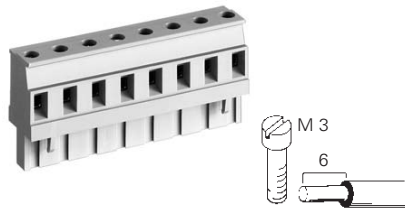
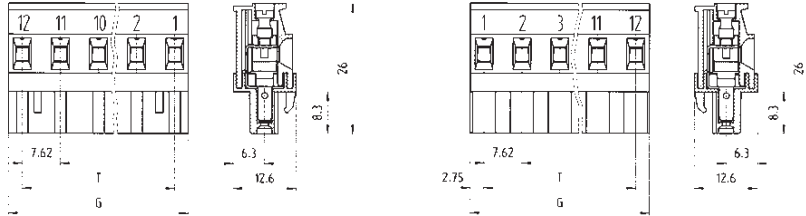

Type 8413 B/... VR
vertical right plug, 90° to wire entry

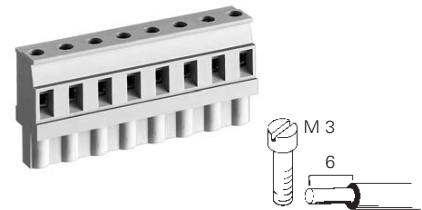

Type 8413 B/... VL
vertical left plug, 90° to wire entry

Rated voltages: VDE 0110
UL ratings
CSA ratings
Approvals

No. 22 – 12 AWG 300 V 15 A
No. 22 – 12 AWG 300 V 15 A

No. 22 – 12 AWG 300 V 15 A
No. 22 – 14 AWG 300 V 15 A

Std. pack	G	T	Poles	Part no.	Part no.	Part no.	Part no.	
Spacing: 7.62 mm				Type 8413		Type 8413		
				unmarked	marked	unmarked	marked	
a	100	13.12	7.62	2	25.385.2253.0	25.385.0253.0	25.386.2253.0	25.386.0253.0
	100	20.74	15.24	3	25.385.2353.0	25.385.0353.0	25.386.2353.0	25.386.0353.0
	50	28.36	22.86	4	25.385.2453.0	25.385.0453.0	25.386.2453.0	25.386.0453.0
	50	35.98	30.48	5	25.385.2553.0	25.385.0553.0	25.386.2553.0	25.386.0553.0
	50	43.60	38.10	6	25.385.2653.0	25.385.0653.0	25.386.2653.0	25.386.0653.0
	50	51.22	45.72	7	25.385.2753.0	25.385.0753.0	25.386.2753.0	25.386.0753.0
	50	58.84	53.34	8	25.385.2853.0	25.385.0853.0	25.386.2853.0	25.386.0853.0
	50	66.46	60.96	9	25.385.2953.0	25.385.0953.0	25.386.2953.0	25.386.0953.0
	50	74.08	68.58	10	25.385.3053.0	25.385.1053.0	25.386.3053.0	25.386.1053.0
	50	81.70	76.20	11	25.385.3153.0	25.385.1153.0	25.386.3153.0	25.386.1153.0
	50	89.32	83.82	12	25.385.3253.0	25.385.1253.0	25.386.3253.0	25.386.1253.0
Accessories:								
Coding piece (strip)	100				05.561.9153.0		05.561.9153.0	

Crimp connection

wiecon

Rated cross section:
1.0 or 2.5 mm²

Rated current:
10 A with a 1.0 mm² wire and 0.5 – 1.0 mm² contacts

12 A with a 2.5 mm² wire and 1.5 – 2.5 mm² contacts

Contacts for connection range:
0.5 – 1.0 mm² fine stranded
(insulation diameter 1.4 – 2.3 mm)

Connection range:
0.5 – 1.0 mm² fine stranded
(insulation diameter 1.4 – 3.1 mm)

250 V/4 kV/3 – Overvoltage category III
400 V/4 kV/2 – Overvoltage category II
1000 V/4 kV/1 – Overvoltage category I

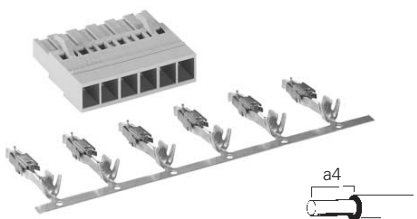
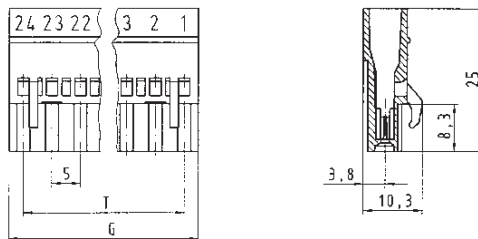

Type 8113 BK

Rated voltages: VDE 0110
UL ratings
CSA ratings
Approvals

No. 22 – 12 AWG 300 V 15 A
UL pending

Std. pack	G	T	Poles	Part no.	Part no.	Part no.	Part no.
Spacing: 5.00 mm							
100	10	5	2	unmarked	marked		
100	15	10	3	01.060.3253.0	01.060.0253.0		
50	20	15	4	01.060.3353.0	01.060.0353.0		
				01.060.3453.0	01.060.0453.0		
50	25	20	5	01.060.3553.0	01.060.0553.0		
50	30	25	6	01.060.3653.0	01.060.0653.0		
50	35	30	7	01.060.3753.0	01.060.0753.0		
50	40	35	8	01.060.3853.0	01.060.0853.0		
50	45	40	9	01.060.3953.0	01.060.0953.0		
50	50	45	10	01.060.4053.0	01.060.1053.0		
50	55	50	11	01.060.4153.0	01.060.1153.0		
50	60	55	12	01.060.4253.0	01.060.1253.0		
50	65	60	13	01.060.4353.0	01.060.1353.0		
50	70	65	14	01.060.4453.0	01.060.1453.0		
50	75	70	15	01.060.4553.0	01.060.1553.0		
50	80	75	16	01.060.4653.0	01.060.1653.0		
				17 to 24pole upon request			
Accessories:							
Crimp contacts							
Single contacts	500	0.5 – 1.0 mm ²	20-18 AWG	02.125.1629.0			
Single contacts	500	1.5 – 2.5 mm ²	16-14 AWG	02.125.1729.0			
Reel contacts	4000	0.5 – 1.0 mm ²	20-18 AWG	02.125.1600.0			
Reel contacts	3500	1.5 – 2.5 mm ²	16-14 AWG	02.125.1700.0			
Crimping tool:							
Crimping tool				95.101.0800.0			
Crimp dies				05.502.2500.0			



PC board connectors, spring clamp connection spacings 5.00/5.08 mm

wiecon PCB

Rated cross section*:
2.5 mm²

Rated current:
12 A

Connection range:
0.14 – 2.5 mm² solid / fine stranded

250 V/4 kV/3 – Overvoltage category III
400 V/4 kV/2 – Overvoltage category II
1000 V/4 kV/1 – Overvoltage category I

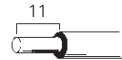
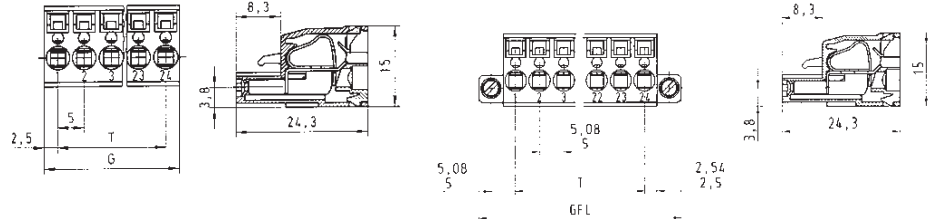

Type 8113/8213 BFK

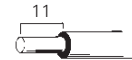
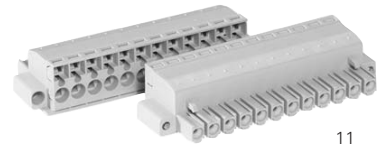

Type 8113/8213 BFK .../F

* When using ferrules for conductor cross section of 2.5 mm, use only ferrule no. 05.596.6127.0.

Rated voltages: VDE 0110
UL ratings
CSA ratings
Approvals

No. 22 – 12 AWG
No. 22 – 12 AWG

300 V 12 A
300 V 12 A



No. 22 – 12 AWG
No. 22 – 12 AWG

300 V 12 A
300 V 12 A



Std. pack	GFL	G	T	Poles	Part no. unmarked	Part no. marked	Part no. unmarked	Part no. marked
Spacing: 5.00 mm					unmarked		marked	
100	22.54	10	5	2	25.820.3253.0	25.820.0253.0	25.821.3253.0	25.821.0253.0
100	27.54	15	10	3	25.820.3353.0	25.820.0353.0	25.821.3353.0	25.821.0353.0
50	32.54	20	15	4	25.820.3453.0	25.820.0453.0	25.821.3453.0	25.821.0453.0
50	37.54	25	20	5	25.820.3553.0	25.820.0553.0	25.821.3553.0	25.821.0553.0
50	42.54	30	25	6	25.820.3653.0	25.820.0653.0	25.821.3653.0	25.821.0653.0
50	47.54	35	30	7	25.820.3753.0	25.820.0753.0	25.821.3753.0	25.821.0753.0
50	52.54	40	35	8	25.820.3853.0	25.820.0853.0	25.821.3853.0	25.821.0853.0
50	57.54	45	40	9	25.820.3953.0	25.820.0953.0	25.821.3953.0	25.821.0953.0
50	62.54	50	45	10	25.820.4053.0	25.820.1053.0	25.821.4053.0	25.821.1053.0
50	67.54	55	50	11	25.820.4153.0	25.820.1153.0	25.821.4153.0	25.821.1153.0
50	72.54	60	55	12	25.820.4253.0	25.820.1253.0	25.821.4253.0	25.821.1253.0
50	77.54	65	60	13	25.820.4353.0	25.820.1353.0	25.821.4353.0	25.821.1353.0
50	82.54	70	65	14	25.820.4453.0	25.820.1453.0	25.821.4453.0	25.821.1453.0
50	87.54	75	70	15	25.820.4553.0	25.820.1553.0	25.821.4553.0	25.821.1553.0
50	92.54	80	75	16	25.820.4653.0	25.820.1653.0	25.821.4653.0	25.821.1653.0
					17 to 24pole upon request		17 to 24pole upon request	
Spacing: 5.08 mm					unmarked		marked	
100	22.70	10.16	5.08	2	25.840.3253.0	25.840.0253.0	25.841.3253.0	25.841.0253.0
100	27.78	15.24	10.16	3	25.840.3353.0	25.840.0353.0	25.841.3353.0	25.841.0353.0
50	32.86	20.32	15.24	4	25.840.3453.0	25.840.0453.0	25.841.3453.0	25.841.0453.0
50	37.94	25.40	20.32	5	25.840.3553.0	25.840.0553.0	25.841.3553.0	25.841.0553.0
50	43.02	30.48	25.40	6	25.840.3653.0	25.840.0653.0	25.841.3653.0	25.841.0653.0
50	48.10	35.56	30.48	7	25.840.3753.0	25.840.0753.0	25.841.3753.0	25.841.0753.0
50	53.18	40.64	35.56	8	25.840.3853.0	25.840.0853.0	25.841.3853.0	25.841.0853.0
50	58.26	45.72	40.64	9	25.840.3953.0	25.840.0953.0	25.841.3953.0	25.841.0953.0
50	63.34	50.80	45.72	10	25.840.4053.0	25.840.1053.0	25.841.4053.0	25.841.1053.0
50	68.42	55.88	50.80	11	25.840.4153.0	25.840.1153.0	25.841.4153.0	25.841.1153.0
50	73.50	60.96	55.88	12	25.840.4253.0	25.840.1253.0	25.841.4253.0	25.841.1253.0
50	78.58	66.04	60.96	13	25.840.4353.0	25.840.1353.0	25.841.4353.0	25.841.1353.0
50	83.66	71.12	66.04	14	25.840.4453.0	25.840.1453.0	25.841.4453.0	25.841.1453.0
50	88.74	76.20	71.12	15	25.840.4553.0	25.840.1553.0	25.841.4553.0	25.841.1553.0
50	93.82	81.28	76.20	16	25.840.4653.0	25.840.1653.0	25.841.4653.0	25.841.1653.0
					17 to 24pole upon request		17 to 24pole upon request	

PC board connectors, spring clamp connection

Spacings: 5.08 mm

codable

2.5 mm²

Rated cross section*:
2.5 mm²

Rated current:
12 A

Connection range:
0,14 – 2.5 mm² solid / fine stranded

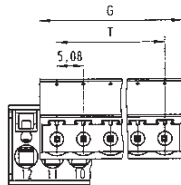

250 V/4 kV/3 – Overvoltage category III
400 V/4 kV/2 – Overvoltage category II
1000 V/4 kV/1 – Overvoltage category I

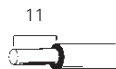

* When using ferrules for conductor cross section of 2.5 mm², use only ferrule no. 05.596.6127.0.

Type 8213 SUFK

Rated voltages: VDE 0110
UL ratings
CSA ratings
Approvals available soon

No. 22 – 12 AWG 300 V 12 A
No. 22 – 12 AWG 300 V 12 A



Std. pack	G	T	Poles	Part no. unmarked	Part no. marked
Spacing: 5.08 mm					
100	10.16	5.08	2	25.857.3253.0	25.857.0253.0
100	15.24	10.16	3	25.857.3353.0	25.857.0353.0
50	20.32	15.24	4	25.857.3453.0	25.857.0453.0
50	25.40	20.32	5	25.857.3553.0	25.857.0553.0
50	30.48	25.40	6	25.857.3653.0	25.857.0653.0
50	35.56	30.48	7	25.857.3753.0	25.857.0753.0
50	40.64	35.56	8	25.857.3853.0	25.857.0853.0
50	45.72	40.64	9	25.857.3953.0	25.857.0953.0
50	50.80	45.72	10	25.857.4053.0	25.857.1053.0
50	55.88	50.80	11	25.857.4153.0	25.857.1153.0
50	60.96	55.88	12	25.857.4253.0	25.857.1253.0
50	66.04	60.96	13	25.857.4353.0	25.857.1353.0
50	71.12	66.04	14	25.857.4453.0	25.857.1453.0
50	76.20	71.12	15	25.857.4553.0	25.857.1553.0
50	81.28	76.20	16	25.857.4653.0	25.857.1653.0
17 to 24pole upon request					
Accessories:					
Coding piece (strip)	100	05.561.9153.0			
Screwdriver DIN 5264 A 0.6 x 3.5	5	06.502.4000.0			



PC board connectors, pluggable

Spacings: 5.00/5.08 mm

wiecon PCB

Rated cross section:
2.5 mm²

Rated current:
12 A, feed through current 2.2 mA per LED

Rated voltages:
Type 8113 B/... TOP, 8213 B/... TOP
250 V/4 kV/3 – Overvoltage category III
400 V/4 kV/2 – Overvoltage category II
1000 V/4 kV/1 – Overvoltage category I

Type 8113 B/... TOP LED
24 V/4 kV/3 – Overvoltage category III
24 V/4 kV/2 – Overvoltage category II
24 V/4 kV/1 – Overvoltage category I

Connection range:
0.14 – 2.5 mm² solid / fine stranded

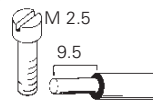
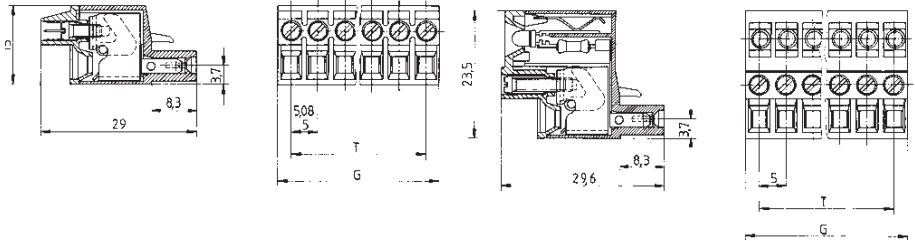

**TOP connection
LED with
common
negative pole**

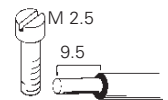

Type 8113 B/... TOP, 8213 B/... TOP
plug-in 180° to wire entry

Type 8113 B/... TOP LED
plug-in 180° to wire entry

Rated voltages: VDE 0110
UL ratings
CSA ratings
Approvals

No. 22 – 12 AWG 300 V 15 A
No. 22 – 12 AWG 300 V 15 A

No. 22 – 12 AWG 24 V 15 A
No. 22 – 12 AWG 24 V 15 A



Std. pack	TOP	G	T	Poles	Part no.	Part no.	Part no.	Part no.
Spacing: 5.00 mm					unmarked	marked	unmarked	marked
100	250	10	5	2	25.220.3253.0	25.220.0253.0	25.230.3253.0	25.230.0253.0
100	250	15	10	3	25.220.3353.0	25.220.0353.0	25.230.3353.0	25.230.0353.0
50	200	20	15	4	25.220.3453.0	25.220.0453.0	25.230.3453.0	25.230.0453.0
50	200	25	20	5	25.220.3553.0	25.220.0553.0	25.230.3553.0	25.230.0553.0
50	200	30	25	6	25.220.3653.0	25.220.0653.0	25.230.3653.0	25.230.0653.0
50	100	35	30	7	25.220.3753.0	25.220.0753.0	25.230.3753.0	25.230.0753.0
50	100	40	35	8	25.220.3853.0	25.220.0853.0	25.230.3853.0	25.230.0853.0
50	100	45	40	9	25.220.3953.0	25.220.0953.0	25.230.3953.0	25.230.0953.0
50	100	50	45	10	25.220.4053.0	25.220.1053.0	25.230.4053.0	25.230.1053.0
50	100	55	50	11	25.220.4153.0	25.220.1153.0	25.230.4153.0	25.230.1153.0
50	100	60	55	12	25.220.4253.0	25.220.1253.0	25.230.4253.0	25.230.1253.0
50	50	65	60	13	25.220.4353.0	25.220.1353.0	25.230.4353.0	25.230.1353.0
50	50	70	65	14	25.220.4453.0	25.220.1453.0	25.230.4453.0	25.230.1453.0
50	50	75	70	15	25.220.4553.0	25.220.1553.0	25.230.4553.0	25.230.1553.0
50	50	80	75	16	25.220.4653.0	25.220.1653.0	25.230.4653.0	25.230.1653.0
117 to 24pole upon request								
Spacing: 5.08 mm					unmarked	marked		
100	250	10.16	5.08	2	25.240.3253.0	25.240.0253.0		
100	250	15.24	10.16	3	25.240.3353.0	25.240.0353.0		
50	200	20.32	15.24	4	25.240.3453.0	25.240.0453.0		
50	200	25.40	20.32	5	25.240.3553.0	25.240.0553.0		
50	200	30.48	25.40	6	25.240.3653.0	25.240.0653.0		
50	100	35.56	30.48	7	25.240.3753.0	25.240.0753.0		
50	100	40.64	35.56	8	25.240.3853.0	25.240.0853.0		
50	100	45.72	40.64	9	25.240.3953.0	25.240.0953.0		
50	100	50.80	45.72	10	25.240.4053.0	25.240.1053.0		
50	100	55.88	50.80	11	25.240.4153.0	25.240.1153.0		
50	100	60.96	55.88	12	25.240.4253.0	25.240.1253.0		
50	50	66.04	60.96	13	25.240.4353.0	25.240.1353.0		
50	50	71.12	66.04	14	25.240.4453.0	25.240.1453.0		
50	50	76.20	71.12	15	25.240.4553.0	25.240.1553.0		
50	50	81.28	76.20	16	25.240.4653.0	25.240.1653.0		
17 to 24pole upon request								

Insulated headers for PC boards

Spacings: 5.00/5.08 mm



Rated current:
12 A

250 V/4 kV/3 – Overvoltage category III
400 V/4 kV/2 – Overvoltage category II
1000 V/4 kV/1 – Overvoltage category I

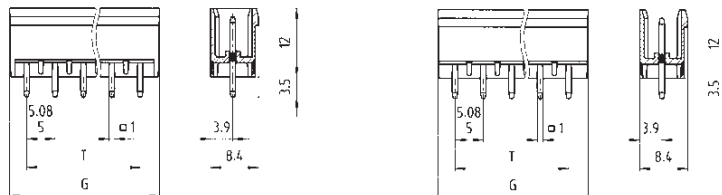

Solder pin 1 x 1 mm
Bore hole Ø 1.4 mm



Solder pin 1 x 1 mm
Bore hole Ø 1.4 mm

closed version

open version

Type 8113 S/... G, 8213 S/... G
vertical mount

Type 8113 S/... GOF, 8213 S/... GOF
vertical mount

Rated voltages: VDE 0110
UL ratings
CSA ratings
Approvals

300 V 15 A
300 V 15 A

300 V 15 A
300 V 15 A



Std. pack	G	T	Poles	Part no.	Part no.	G	T	Part no.
Spacing: 5.00 mm				unmarked		unmarked		
100	10.16	5	2	25.330.3253.0		10	5	99.202.9996.0
100	15.24	10	3	25.330.3353.0		15	10	99.203.9996.0
50	20.32	15	4	25.330.3453.0		20	15	99.204.9996.0
50	25.40	20	5	25.330.3553.0		25	20	99.205.9996.0
50	30.48	25	6	25.330.3653.0		30	25	99.206.9996.0
50	35.56	30	7	25.330.3753.0		35	30	99.207.9996.0
50	40.64	35	8	25.330.3853.0		40	35	99.208.9996.0
50	45.72	40	9	25.330.3953.0		45	40	99.209.9996.0
50	50.80	45	10	25.330.4053.0		50	45	99.210.9996.0
50	55.88	50	11	25.330.4153.0		55	50	99.211.9996.0
50	60.96	55	12	25.330.4253.0		60	55	99.212.9996.0
50	66.04	60	13	25.330.4353.0		65	60	99.213.9996.0
50	71.12	65	14	25.330.4453.0		70	65	99.214.9996.0
50	76.20	70	15	25.330.4553.0		75	70	99.215.9996.0
50	81.28	75	16	25.330.4653.0		80	75	99.216.9996.0
17 to 24pole upon request						17 to 24pole upon request		
Spacing: 5.08 mm				unmarked		unmarked		
100	11.56	5.08	2	25.350.3253.0		10.16	5.08	99.232.9996.1
100	16.64	10.16	3	25.350.3353.0		15.24	10.16	99.233.9996.1
50	21.72	15.24	4	25.350.3453.0		20.32	15.24	99.234.9996.1
50	26.80	20.32	5	25.350.3553.0		25.40	20.32	99.235.9996.1
50	31.88	25.40	6	25.350.3653.0		30.48	25.40	99.236.9996.1
50	36.96	30.48	7	25.350.3753.0		35.56	30.48	99.237.9996.1
50	42.04	35.56	8	25.350.3853.0		40.64	35.56	99.238.9996.1
50	47.12	40.64	9	25.350.3953.0		45.72	40.64	99.239.9996.1
50	52.20	45.72	10	25.350.4053.0		50.80	45.72	99.240.9996.1
50	57.28	50.80	11	25.350.4153.0		55.88	50.80	99.241.9996.1
50	62.36	55.88	12	25.350.4253.0		60.96	55.88	99.242.9996.1
50	67.44	60.96	13	25.350.4353.0		66.04	60.96	99.243.9996.1
50	72.52	66.04	14	25.350.4453.0		70.12	66.04	99.244.9996.1
50	77.60	71.12	15	25.350.4553.0		75.20	71.12	99.245.9996.1
50	82.68	76.20	16	25.350.4653.0		80.28	76.20	99.246.9996.1
17 to 24pole upon request						17 to 24pole upon request		
Accessories:								
Coding piece (strip)	100			05.561.0053.0		05.561.0053.0		
Fixing device assembly - for screw flanges on both sides of the header	100			Z5.523.2453.0				



Insulated headers for PC boards

Spacings: 5.00/5.08 mm



Rated current:
12 A

250 V/4 kV/3 – Overvoltage category III
400 V/4 kV/2 – Overvoltage category II
1000 V/4 kV/1 – Overvoltage category I

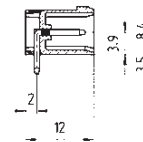
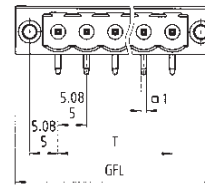
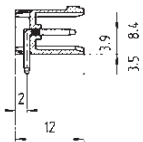
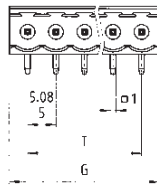

Solder pin 1 x 1 mm
Bore hole Ø 1.4 mm

open version



Solder pin 1 x 1 mm
Bore hole Ø 1.4 mm

with screw flange

Type 8113 S/... WOF, 8213 S/... WOF
horizontal mount

Type 8113 S/... WF, 8213 S/... WF
horizontal mount

Rated voltages: VDE 0110
UL ratings
CSA ratings
Approvals

300 V 15 A
300 V 15 A

300 V 15 A
300 V 15 A



Std. pack	G	T	Poles	Part no.	Part no.	GFL	G	T	Part no.	
Spacing: 5.00 mm				unmarked			unmarked			
100	11.40	5	2	99.262.9996.0		20	10	5	25.339.3253.0	
100	16.40	10	3	99.263.9996.0		25	15	10	25.339.3353.0	
50	21.40	15	4	99.264.9996.0		30	20	15	25.339.3453.0	
50	26.40	20	5	99.265.9996.0		35	25	20	25.339.3553.0	
50	31.40	25	6	99.266.9996.0		40	30	25	25.339.3653.0	
50	36.40	30	7	99.267.9996.0		45	35	30	25.339.3753.0	
50	41.40	35	8	99.268.9996.0		50	40	35	25.339.3853.0	
50	46.40	40	9	99.269.9996.0		55	45	40	25.339.3953.0	
50	51.40	45	10	99.270.9996.0		60	50	45	25.339.4053.0	
50	56.40	50	11	99.271.9996.0		65	55	50	25.339.4153.0	
50	61.40	55	12	99.272.9996.0		70	60	55	25.339.4253.0	
50	66.40	60	13	99.273.9996.0		75	65	60	25.339.4353.0	
50	71.40	65	14	99.274.9996.0		80	70	65	25.339.4453.0	
50	76.40	70	15	99.275.9996.0		85	75	70	25.339.4553.0	
50	81.40	75	16	99.276.9996.0		90	80	75	25.339.4653.0	
17 to 24pole upon request							17 to 22pole upon request			
Spacing: 5.08 mm				unmarked			unmarked			
100	11.56	5.08	2	99.202.9996.2		20.32	10.16	5.08	25.358.3253.0	
100	16.64	10.16	3	99.203.9996.2		25.40	15.24	10.16	25.358.3353.0	
50	21.72	15.24	4	99.204.9996.2		30.48	20.32	15.24	25.358.3453.0	
50	26.80	20.32	5	99.205.9996.2		35.56	25.40	20.32	25.358.3553.0	
50	31.88	25.40	6	99.206.9996.2		40.64	30.48	25.40	25.358.3653.0	
50	36.96	30.48	7	99.207.9996.2		45.72	35.56	30.48	25.358.3753.0	
50	42.04	35.56	8	99.208.9996.2		50.80	40.64	35.56	25.358.3853.0	
50	47.12	40.64	9	99.209.9996.2		55.88	45.72	40.64	25.358.3953.0	
50	52.20	45.72	10	99.210.9996.2		60.96	50.80	45.72	25.358.4053.0	
50	57.28	50.80	11	99.211.9996.2		66.04	55.88	50.80	25.358.4153.0	
50	62.36	55.88	12	99.212.9996.2		71.12	60.96	55.88	25.358.4253.0	
50	67.44	60.96	13	99.213.9996.2		76.20	66.04	60.96	25.358.4353.0	
50	72.52	66.04	14	99.214.9996.2		81.28	71.12	66.04	25.358.4453.0	
50	77.60	71.12	15	99.215.9996.2		86.36	76.20	71.12	25.358.4553.0	
50	82.68	76.20	16	99.216.9996.2		91.44	81.28	76.20	25.358.4653.0	
17 to 24pole upon request							17 to 22pole upon request			
Accessories:										
Coding piece (strip)	100				05.561.0053.0					05.561.0053.0
Fixing device assembly - for screw flanges on both sides of the header	100				Z5.523.2453.0					



Insulated headers for PC boards

Spacings: 7.50/7.62 mm

wiecon PCB

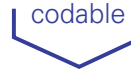

Rated current:
12 A

250 V/4 kV/3 – Overvoltage category III
400 V/4 kV/2 – Overvoltage category II
1000 V/4 kV/1 – Overvoltage category I

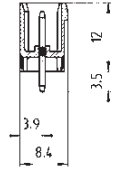
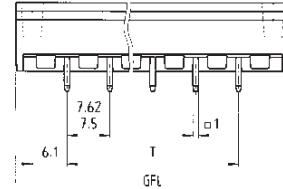
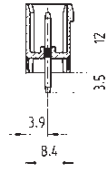
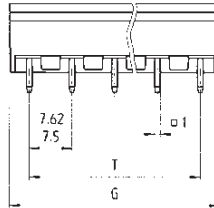

Solder pin 1 x 1 mm
Bore hole Ø 1.4 mm

closed version



Solder pin 1 x 1 mm
Bore hole Ø 1.4 mm

with screw flange

Type 8313 S/... G, 8413 S/... G

vertical mount

Type 8313 S/... GF, 8413 S/... GF

vertical mount

Rated voltages: VDE 0110

UL ratings

CSA ratings

Approvals

300 V 15 A
300 V 15 A

300 V 15 A
300 V 15 A



	Std. pack	G	T	Poles	Part no.	Part no.	GFL	T	Part no.
Spacing: 7.50 mm					unmarked				unmarked
	100	14.20	7.50	2	25.370.3253.0		25.54	7.50	25.374.6253.0
	100	21.70	15.00	3	25.370.3353.0		33.04	15.00	25.374.6353.0
	50	29.20	22.50	4	25.370.3453.0		40.54	22.50	25.374.6453.0
	50	36.70	30.00	5	25.370.3553.0		48.04	30.00	25.374.6553.0
	50	44.20	37.50	6	25.370.3653.0		55.54	37.50	25.374.6653.0
	50	51.70	45.00	7	25.370.3753.0		63.04	45.00	25.374.6753.0
	50	59.20	52.50	8	25.370.3853.0		70.54	52.50	25.374.6853.0
	50	66.70	60.00	9	25.370.3953.0		78.04	60.00	25.374.6953.0
	50	74.20	67.50	10	25.370.4053.0		85.54	67.50	25.374.7053.0
	50	81.70	75.00	11	25.370.4153.0		93.04	75.00	25.374.7153.0
	50	89.20	82.50	12	25.370.4253.0		100.54	82.50	25.374.7253.0
Spacing: 7.62 mm					unmarked				unmarked
	100	14.32	7.62	2	25.390.3253.0		25.66	7.62	25.398.6253.0
	100	21.94	15.24	3	25.390.3353.0		33.25	15.24	25.398.6353.0
	50	29.56	22.86	4	25.390.3453.0		40.90	22.86	25.398.6453.0
	50	37.18	30.48	5	25.390.3553.0		48.52	30.48	25.398.6553.0
	50	44.80	38.10	6	25.390.3653.0		56.14	38.10	25.398.6653.0
	50	52.42	45.72	7	25.390.3753.0		63.76	45.72	25.398.6753.0
	50	60.04	53.34	8	25.390.3853.0		71.38	53.34	25.398.6853.0
	50	67.66	60.64	9	25.390.3953.0		79.00	60.64	25.398.6953.0
	50	75.28	68.58	10	25.390.4053.0		86.62	68.58	25.398.7053.0
	50	82.90	76.20	11	25.390.4153.0		94.24	76.20	25.398.7153.0
	50	90.52	83.82	12	25.390.4253.0		101.86	83.82	25.398.7253.0
Accessories:									
Coding piece (strip)	100				05.561.0053.0		05.561.0053.0		
Fixing device assembly - for screw flanges on both sides of the header	100				Z5.523.2453.0				

Insulated headers for PC boards

Spacings: 7.50/7.62 mm



Rated current:
12 A

400 V/6 kV/3 – Overvoltage category III
690 V/6 kV/2 – Overvoltage category II
1000 V/6 kV/1 – Overvoltage category I

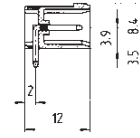
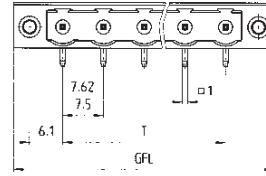
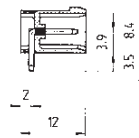
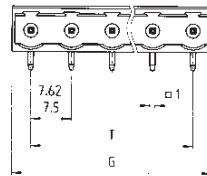

Solder pin 1 x 1 mm
Bore hole Ø 1.4 mm
closed version



Solder pin 1 x 1 mm
Bore hole Ø 1.4 mm

with screw flange

Type 8313 S/... W, 8413 S/... W
horizontal mount

Type 8313 S/... WF, 8413 S/... WF
horizontal mount

Rated voltages: VDE 0110
UL ratings
CSA ratings
Approvals

300 V 15 A
300 V 15 A

300 V 15 A
300 V 15 A



Std. pack	G	T	Poles	Part no.	Part no.	GFL	T	Part no.
Spacing: 7.50 mm				unmarked		unmarked		
100	14.40	7.50	2	25.372.3253.0		25.54	7.50	25.374.2253.0
100	21.90	15.00	3	25.372.3353.0		33.04	15.00	25.374.2353.0
50	29.40	22.50	4	25.372.3453.0		40.54	22.50	25.374.2453.0
50	36.90	30.00	5	25.372.3553.0		48.04	30.00	25.374.2553.0
50	44.40	37.50	6	25.372.3653.0		55.54	37.50	25.374.2653.0
50	51.90	45.00	7	25.372.3753.0		63.04	45.00	25.374.2753.0
50	59.40	52.50	8	25.372.3853.0		70.54	52.50	25.374.2853.0
50	66.90	60.00	9	25.372.3953.0		78.04	60.00	25.374.2953.0
50	74.40	67.50	10	25.372.4053.0		85.54	67.50	25.374.3053.0
50	81.90	75.00	11	25.372.4153.0		93.04	75.00	25.374.3153.0
50	89.40	82.50	12	25.372.4253.0		100.54	82.50	25.374.3253.0
Spacing: 7.62 mm				unmarked		unmarked		
100	14.52	7.62	2	25.392.3253.0		25.66	7.62	25.398.2253.0
100	22.14	15.24	3	25.392.3353.0		33.25	15.24	25.398.2353.0
50	29.76	22.86	4	25.392.3453.0		40.90	22.86	25.398.2453.0
50	37.38	30.48	5	25.392.3553.0		48.52	30.48	25.398.2553.0
50	45.00	38.10	6	25.392.3653.0		56.14	38.10	25.398.2653.0
50	52.62	45.72	7	25.392.3753.0		63.76	45.72	25.398.2753.0
50	60.24	53.34	8	25.392.3853.0		71.38	53.34	25.398.2853.0
50	67.86	60.64	9	25.392.3953.0		79.00	60.64	25.398.2953.0
50	75.48	68.58	10	25.392.4053.0		86.62	68.58	25.398.3053.0
50	83.10	76.20	11	25.392.4153.0		94.24	76.20	25.398.3153.0
50	90.72	83.82	12	25.392.4253.0		101.86	83.82	25.398.3253.0
Accessories:								
Coding piece (strip)	100			05.561.0053.0		05.561.0053.0		
Fixing device assembly - for screw flanges on both sides of the header	100			Z5.523.2453.0				



Insulated headers for PC boards

Spacings: 5.00/5.08 mm

wiecon PCB



Rated current:
12 A

250 V/4 kV/3 – Overvoltage category III
400 V/4 kV/2 – Overvoltage category II
1000 V/4 kV/1 – Overvoltage category I

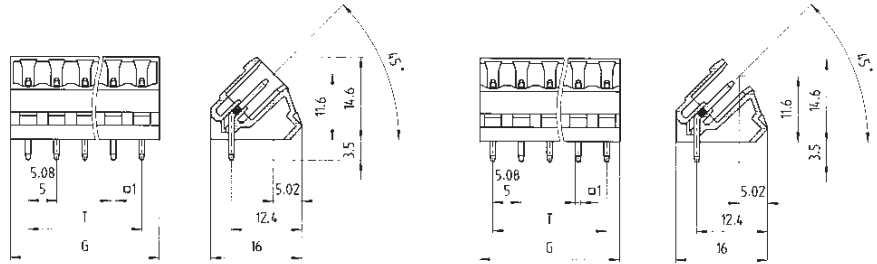

Solder pin 1 x 1 mm
Bore hole Ø 1.4 mm

closed version



Solder pin 1 x 1 mm
Bore hole Ø 1.4 mm

open version

Type 8113 S/... S, 8213 S/... S

plug-in 45° to PC board

Type 8113 S/... S1, 8213 S/... S1

plug-in 45° to PC board

Rated voltages: VDE 0110

UL ratings

CSA ratings

Approvals

300 V 15 A
300 V 15 A

300 V 15 A
300 V 15 A



Std. pack	G	T	Poles	Part no.	Part no.	G	T	Part no.
Spacing: 5.00 mm				unmarked		unmarked		
100	11.20	5	2	25.394.3253.0		9.60	5	25.395.3253.0
100	16.20	10	3	25.394.3353.0		14.60	10	25.395.3353.0
50	21.20	15	4	25.394.3453.0		19.60	15	25.395.3453.0
50	26.20	20	5	25.394.3553.0		24.60	20	25.395.3553.0
50	31.20	25	6	25.394.3653.0		29.60	25	25.395.3653.0
50	36.20	30	7	25.394.3753.0		34.60	30	25.395.3753.0
50	41.20	35	8	25.394.3853.0		39.60	35	25.395.3853.0
50	46.20	40	9	25.394.3953.0		44.60	40	25.395.3953.0
50	51.20	45	10	25.394.4053.0		49.60	45	25.395.4053.0
50	56.20	50	11	25.394.4153.0		54.60	50	25.395.4153.0
50	61.20	55	12	25.394.4253.0		59.60	55	25.395.4253.0
50	66.20	60	13	25.394.4353.0		64.60	60	25.395.4353.0
50	71.20	65	14	25.394.4453.0		69.60	65	25.395.4453.0
50	76.20	70	15	25.394.4553.0		74.60	70	25.395.4553.0
50	81.20	75	16	25.394.4653.0		79.60	75	25.395.4653.0
17 to 24pole upon request								
Spacing: 5.08 mm				unmarked		unmarked		
100	11.36	5.08	2	25.396.3253.0		9.76	5.08	25.397.3253.0
100	16.44	10.16	3	25.396.3353.0		14.84	10.16	25.397.3353.0
50	21.52	15.24	4	25.396.3453.0		19.92	15.24	25.397.3453.0
50	26.60	20.32	5	25.396.3553.0		25.00	20.32	25.397.3553.0
50	31.68	25.40	6	25.396.3653.0		30.08	25.40	25.397.3653.0
50	36.76	30.48	7	25.396.3753.0		35.16	30.48	25.397.3753.0
50	41.84	35.56	8	25.396.3853.0		40.24	35.56	25.397.3853.0
50	46.92	40.64	9	25.396.3953.0		45.32	40.64	25.397.3953.0
50	52.00	45.72	10	25.396.4053.0		50.40	45.72	25.397.4053.0
50	57.08	50.80	11	25.396.4153.0		55.48	50.80	25.397.4153.0
50	62.19	55.88	12	25.396.4253.0		60.56	55.88	25.397.4253.0
50	67.24	60.96	13	25.396.4353.0		65.64	60.96	25.397.4353.0
50	72.32	66.04	14	25.396.4453.0		70.72	66.04	25.397.4453.0
50	77.40	71.12	15	25.396.4553.0		75.80	71.12	25.397.4553.0
50	82.48	76.20	16	25.396.4653.0		80.88	76.20	25.397.4653.0
17 to 24pole upon request								
Accessories:								
Coding piece (strip)	100			05.561.0053.0		05.561.0053.0		

Two-tier insulated headers for PC boards

Spacings: 5.00/5.08 mm

Rated current:
10 A

250 V/4 kV/3 – Overvoltage category III
400 V/4 kV/2 – Overvoltage category II
1000 V/4 kV/1 – Overvoltage category I

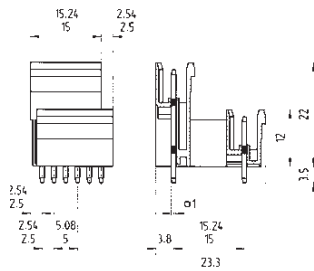

Solder pin 1 x 1 mm
Bore hole Ø 1.4 mm

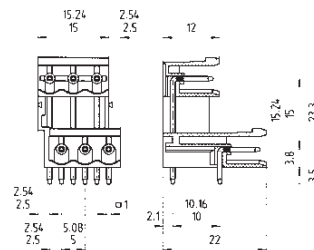

Solder pin 1 x 1 mm
Bore hole Ø 1.4 mm

Type 8113 SE/... G, 8213 SE/... G
vertical mount

Type 8113 SE/... W, 8213 SE/... W
horizontal mount

Rated voltages: VDE 0110
UL ratings
CSA ratings
Approvals

300 V 15 A
300 V 10 A

300 V 15 A
300 V 10 A



Std. pack	T	Poles	Part no.	Part no.	Part no.	Part no.
Spacing: 5.00 mm						
100	5	2 x 2	unmarked		unmarked	
100	10	2 x 3	25.334.3253.0		25.336.3253.0	
			25.334.3353.0		25.336.3353.0	
Slide together for larger pole configurations. Factory assembly available.						
Spacing: 5.08 mm						
100	5.08	2 x 2	unmarked		unmarked	
100	10.16	2 x 3	25.354.3253.0		25.356.3253.0	
			25.354.3353.0		25.356.3353.0	
Slide together for larger pole configurations. Factory assembly available.						
Accessories:						
End plate	50		07.310.9853.0		07.310.9853.0	
Fixing device assembly - for screw flanges on both sides of the header			upon request		only together with end plate 07.310.9853.0	Z5.523.2453.0



Insulated header

wiecon PCB

Rated current: 10 A

250 V/4 kV/3 – Overvoltage category III
 400 V/4 kV/2 – Overvoltage category III
 400 V/4 kV/2 – Overvoltage category II

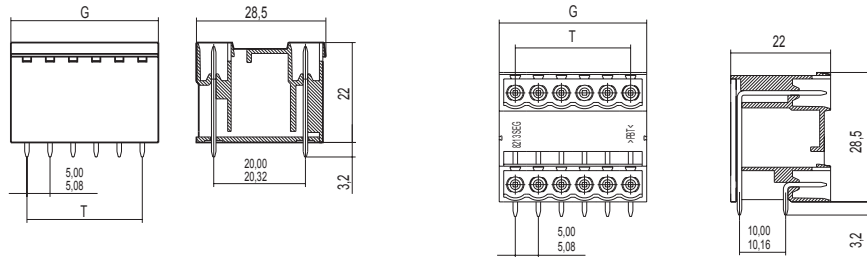

Solder pin 1 x 1 mm
 Bore hole Ø 1.3 mm



Solder pin 1 x 1 mm
 Bore hole Ø 1.3 mm

Type 81-8213 SEG .../G

Vertical mount

300 V 10 A
 300 V 10 A



Type 81-8213 SEG .../W

Horizontal mount

300 V 10 A
 300 V 10 A



Rated voltages: VDE 0110
 UL ratings
 CSA ratings
 Approvals

Std. pack	G	T	Poles	Part no.	Part no.	Part no.	Part no.
Spacing: 5.00 mm				unmarked		unmarked	
100	12	5	4	27.334.0253.0		27.336.0253.0	
100	17	10	6	27.334.0353.0		27.336.0353.0	
50	22	15	8	27.334.0453.0		27.336.0453.0	
50	27	20	10	27.334.0553.0		27.336.0553.0	
50	32	25	12	27.334.0653.0		27.336.0653.0	
50	37	30	14	27.334.0753.0		27.336.0753.0	
50	42	35	16	27.334.0853.0		27.336.0853.0	
50	47	40	18	27.334.0953.0		27.336.0953.0	
50	52	45	20	27.334.1053.0		27.336.1053.0	
50	57	50	22	27.334.1153.0		27.336.1153.0	
50	62	55	24	27.334.1253.0		27.336.1253.0	
50	67	60	26	27.334.1353.0		27.336.1353.0	
50	72	65	28	27.334.1453.0		27.336.1453.0	
50	77	70	30	27.334.1553.0		27.336.1553.0	
50	82	75	32	27.334.1653.0		27.336.1653.0	
17 to 24pole upon request							
Spacing: 5.08 mm				unmarked		unmarked	
100	12.16	5.08	4	27.354.0253.0		27.356.0253.0	
100	17.24	10.16	6	27.354.0353.0		27.356.0353.0	
50	22.32	15.24	8	27.354.0453.0		27.356.0453.0	
50	27.40	20.32	10	27.354.0553.0		27.356.0553.0	
50	32.48	25.40	12	27.354.0653.0		27.356.0653.0	
50	37.56	30.48	14	27.354.0753.0		27.356.0753.0	
50	42.64	35.56	16	27.354.0853.0		27.356.0853.0	
50	47.72	40.64	18	27.354.0953.0		27.356.0953.0	
50	52.80	45.72	20	27.354.1053.0		27.356.1053.0	
50	57.88	50.80	22	27.354.1153.0		27.356.1153.0	
50	62.96	55.88	24	27.354.1253.0		27.356.1253.0	
50	68.04	60.96	26	27.354.1353.0		27.356.1353.0	
50	73.12	66.04	28	27.354.1453.0		27.356.1453.0	
50	78.20	71.12	30	27.354.1553.0		27.356.1553.0	
50	83.28	76.20	32	27.354.1653.0		27.356.1653.0	
17 to 24pole upon request							
				Coding available on request		Coding available on request	

Insulated header for panel mount feed through, Spacing: 5.08 mm



Wire wrap connection 1 x 1
Max. pin diameter: 0.8 mm

Rated current: 6.5 A

Solder eyelets
Rated cross section:
1.5 mm² solid/
1.0 mm² fine stranded

Rated current: 12 A

Quick connect tabs 2.8 x 0.8 DIN 46249
Rated cross section:
1.0 mm² fine stranded

Rated current: 8 A

250 V/4 kV/3 – Overvoltage category III
400 V/4 kV/2 – Overvoltage category II
1000 V/4 kV/1 – Overvoltage category I

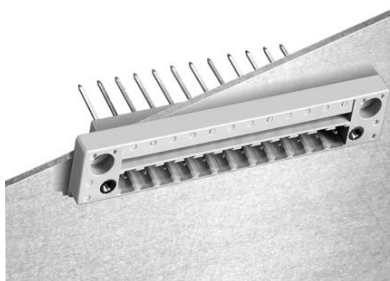
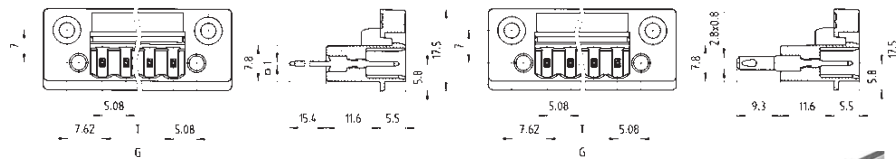

wire wrap

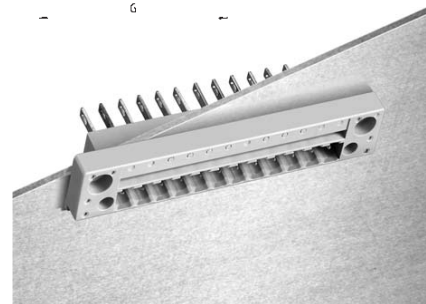

with solder eyelets / quick connect tabs

**Type 8213 S/... DFWW,
8213 S/... DFWW M**

**Type 8213 S/... DFSL,
8213 S/... DFSL M**

Rated voltages: VDE 0110
UL ratings
CSA ratings
Approvals

No. 22 – 12 AWG 300 V 6.5 A
No. 22 – 12 AWG 300 V 6.5 A

No. 22 – 12 AWG 300 V 12/8 A
No. 22 – 12 AWG 300 V 8 A

Std. pack	G	T	Poles	Part no.	Part no.	Part no.	Part no.
Spacing: 5.08 mm							
100	30.48	5.08	2	unmarked	unmarked	unmarked	unmarked
100	35.56	10.16	3	25.303.0253.0	25.313.0253.0	25.303.3253.0	25.313.3253.0
50	40.64	15.24	4	25.303.0353.0	25.313.0353.0	25.303.3353.0	25.313.3353.0
				25.303.0453.0	25.313.0453.0	25.303.3453.0	25.313.3453.0
50	45.72	20.32	5	25.303.0553.0	25.313.0553.0	25.303.3553.0	25.313.3553.0
50	50.80	25.40	6	25.303.0653.0	25.313.0653.0	25.303.3653.0	25.313.3653.0
50	55.88	30.48	7	25.303.0753.0	25.313.0753.0	25.303.3753.0	25.313.3753.0
50	60.96	35.56	8	25.303.0853.0	25.313.0853.0	25.303.3853.0	25.313.3853.0
50	66.04	40.64	9	25.303.0953.0	25.313.0953.0	25.303.3953.0	25.313.3953.0
50	71.12	45.72	10	25.303.1053.0	25.313.1053.0	25.303.4053.0	25.313.4053.0
50	76.20	50.80	11	25.303.1153.0	25.313.1153.0	25.303.4153.0	25.313.4153.0
50	81.28	55.88	12	25.303.1253.0	25.313.1253.0	25.303.4253.0	25.313.4253.0
50	86.36	60.96	13	25.303.1353.0	25.313.1353.0	25.303.4353.0	25.313.4353.0
50	91.44	66.04	14	25.303.1453.0	25.313.1453.0	25.303.4453.0	25.313.4453.0
50	96.52	71.12	15	25.303.1553.0	25.313.1553.0	25.303.4553.0	25.313.4553.0
50	101.60	76.20	16	25.303.1653.0	25.313.1653.0	25.303.4653.0	25.313.4653.0
17 to 22pole upon request				without screw flange	with screw flange	without screw flange	with screw flange
Mounting dimensions							
	a	b					
	13.18	20.32	2				
	18.26	25.40	3				
	23.34	30.48	4				
	28.42	35.56	5				
	33.50	40.64	6				
	38.58	45.72	7				
	43.66	50.80	8				
	48.74	55.08	9				
	53.82	60.96	10				
	58.90	66.04	11				
	68.98	71.12	12				
	69.06	76.20	13				
	74.14	81.28	14				
	79.22	86.36	15				
	84.30	91.44	16				
17 to 24pole upon request							
Accessories:							
Coding piece (strip)	100			05.561.0053.0		05.561.0053.0	
Set of screws	100			Z6.012.0812.0		Z6.012.0812.0	



Accessories for 8113 – 8413/8813 and 8213 BL

wiecon PCB

Bore hole plan for fixing brackets Z5.523.2453.0

Type 8113 SE/... and 8213 SE/...

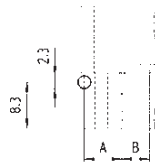

	A	B
8113	6.3	5.00
8213	6.8	5.08

Bore hole plan for fixing brackets Z5.523.2453.0

Type 81 – 8413 S/...

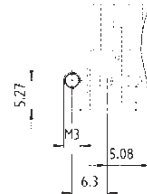
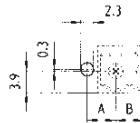

	A	B
8113	5.1	5.00
8213	5.2	5.08
8313	5.4	7.50
8413	5.4	7.62

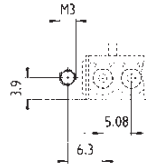

8113 – 8413/8813

	Part no.	Std. pack
<p>Fixing brackets (type 8113 – 8413)</p>	Z5.523.2453.0	100
<p>End plate for multi-tier header (type 8113 – 8213 SE)</p>	07.310.9853.0	50
<p>Coding strip for – header (type 8113 – 8413, type 8813)</p>	05.561.0053.0	100
<p>– plug (type 8113 – 8413)</p>	05.561.9153.0	100

8213 BL

	Part no.	Std. pack	
<p>Adhesive marking tag strips for plug connectors and insulated headers with 5/5.08 mm spacing</p>			
	1 – 12	04.007.4089.0	1
	13 – 24	04.007.4189.0	1
	25 – 36	04.007.4289.0	1
	37 – 68	04.007.4389.0	1
	49 – 60	04.007.4489.0	1
	61 – 72	04.007.4589.0	1
	73 – 84	04.007.4689.0	1
	85 – 96	04.007.4789.0	1
	97 – 108	04.007.4889.0	1
<p>Fixing brackets</p>			

Examples of fixing brackets assembly for insulated headers

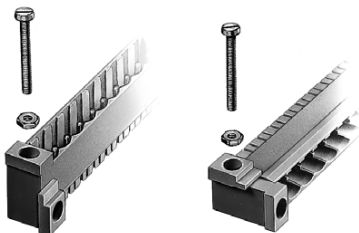

Assembly of fixing brackets with end plate for multi-tier headers

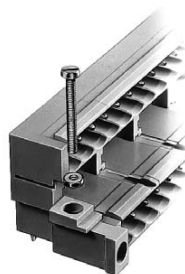

Z5.523.7753.0 100



Z5.523.7853.0 100

wiecon



wiecon

Pluggable PC board connectors Spring clamp / rising cage clamp Spacing: 5.00 mm

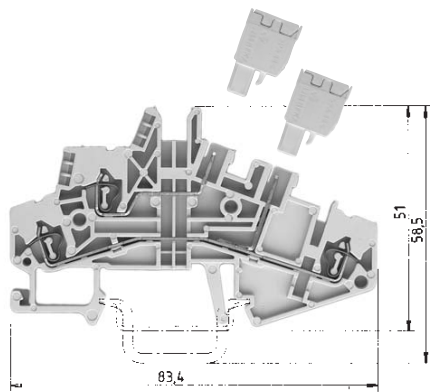

WKF 1.5 E/8113/35

fine stranded solid V A
 0.13 – 1.5 mm² 0.13 – 2.5 mm² 250 V/4 kV/3 16
 No. 22 – 14
 No. 24 – 14
 5 mm 11 mm
 Ⓢ pending

Rated current:
12 A

250 V/4 kV/3 – Overvoltage category III
 400 V/4 kV/2 – Overvoltage category II
 1000 V/4 kV/1 – Overvoltage category I

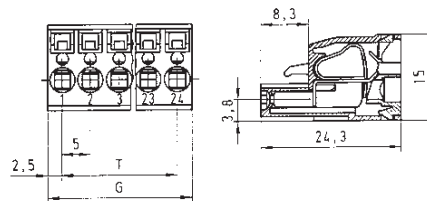

When using ferrules for conductor cross section of 2.5 mm², use only ferrule no. 05.596.6127.0.

See catalog section **facts & DATA** pages 796 - 797



Rated voltages: VDE 0110

EN 60 947-7-1/DIN VDE 0611 T1

Spacing: Wire strip length

UL ratings

CSA ratings

Approvals pending

Type 8113 BFK

0.13 – 2.5 mm² fine stranded 0.13 – 4 mm² solid
 11 mm 9 mm
 No. 22 – 12 AWG 300 V 12 A
 No. 22 – 12 AWG 300 V 12 A



Type	Part no.	Std. pack	Std. pack	G	T	Poles	Part no.	Part no.
			Spacing: 5.00 mm			unmarked		marked
			100	10	5	2	25.820.3253.0	25.820.0253.0
			100	15	10	3	25.820.3353.0	25.820.0353.0
			50	20	15	4	25.820.3453.0	25.820.0453.0
WKF 1,5 E/8113/35	56.702.2053.0	100						
			50	25	20	5	25.820.3553.0	25.820.0553.0
			50	30	25	6	25.820.3653.0	25.820.0653.0
			50	35	30	7	25.820.3753.0	25.820.0753.0
35x27x7,5 EN 50022	98.300.0000.0	1	50	40	35	8	25.820.3853.0	25.820.0853.0
35x24x15 EN 50022	98.360.0000.0	1	50	45	40	9	25.820.3953.0	25.820.0953.0
9708/2 S35	Z5.522.8553.0	100	50	50	45	10	25.820.4053.0	25.820.1053.0
WEF 1/35	Z5.523.9353.0	100	50	55	50	11	25.820.4153.0	25.820.1153.0
APF 1,5/E/8113	07.312.4753.0	10	50	60	55	12	25.820.4253.0	25.820.1253.0
			50	65	60	13	25.820.4353.0	25.820.1353.0
			50	70	65	14	25.820.4453.0	25.820.1453.0
			50	75	70	15	25.820.4553.0	25.820.1553.0
			50	80	75	16	25.820.4653.0	25.820.1653.0
			17 to 24pole upon request					
IVB WKF 2,5 – 2	Z7.280.6227.0	10						
IVB WKF 2,5 – 3	Z7.280.6327.0	10						
IVB WKF 2,5 – 4	Z7.280.6427.0	10						
IVB WKF 2,5 – 5	Z7.280.6527.0	10						
IVB WKF 2,5 – 6	Z7.280.6627.0	10						
IVB WKF 2,5 – 7	Z7.280.6727.0	20						
IVB WKF 2,5 – 8	Z7.280.6827.0	20						
IVB WKF 2,5 – 9	Z7.280.6927.0	20						
IVB WKF 2,5 – 10	Z7.280.7027.0	20						
LEL 1,5/1 WEISS	05.562.2453.0	100						
LEL 1,5/2 GRAU	05.562.2553.0	100						
LEL 1,5/3 SCHWARZ	05.562.2653.0	100						
ADF 2,5/4 GELB	04.343.6053.8	10						
AD 8113/4 GELB	04.343.6853.8	10						
DIN 5264 B 0,6x3,5	06.502.4000.0	5						
	05.561.0053.0	100						
See fasis page 37								
			Accessories:					
	Coding piece (strip)	100					05.561.9153.0	
	Screwdriver DIN 5264 B 0.6 x 3.5	5					06.502.4000.0	



Feed through DIN rail terminal blocks with connection for PC board pluggables

wiecon PCB

For PC board connectors:

- Type 8113 B
- Type 8113 BFK
- Type 8313 B
- Type 8113 B/ML
- Type 8113 B/VR
- Type 8113 B/Top

Indicator: R = 4.7 K; 0.5 W
Signal color: red

¹⁾ for blocks with indicator determined by LED

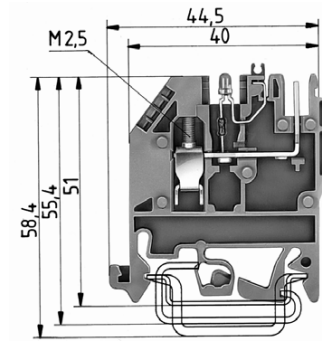
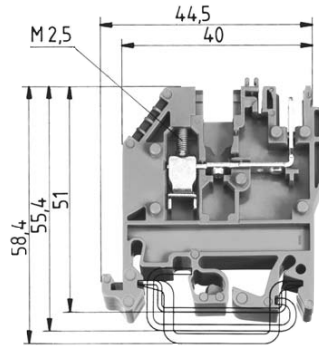

The part numbers marked with *** are supplied with UL 94-V0 insulating housings (flammability class).

WK 2.5 U / 8113 S/V

	fine stranded	solid	V	A
	0.5 – 2.5 mm ²	0.5 – 4 mm ²	250 V/4 kV/3	12
	No. 22 – 12 AWG		300 V	15
	No. 24 – 12 AWG		300 V	15
Width	5 mm		9 mm	



WK 2.5 U / 8113 S/V / LED 25

	fine stranded	solid	V	A
	0.5 – 2.5 mm ²	0.5 – 4 mm ²	¹⁾	12
	No. 22 – 12 AWG		300 V	15
	No. 24 – 12 AWG		25 V ¹⁾	15
Width	5 mm		9 mm	



EN 60 947-7-1/DIN VDE 0611 T1

UL ratings

CSA ratings

Width

Approvals

Wire strip length

		Type	Part no.	Std. pack	Type	Part no.	Std. pack
Feed through block	Color: gray	WK 2,5 U/8113 S/V...***)	57.503.2655.6	50			
Feed through block with LED 25 V	Color: gray				WK 2,5 U/8113 S/V/LED 25***)	57.503.2755.0	50
Feed-through block with LED 50 V	Color: gray						
Power supply block	Color: blue						
Feed through blocks with header connection							
For insulated headers type 8113 see page 297							
Accessories							
Mounting rail TS35 Din rail 7.5 mm high	L = 2 m						
Mounting rail TS 35, DIN rail, 15mm high	L = 2 m						
Mounting rail 32 G rail	L = 2 m						
End clamp with U foot	10 mm wide						
End clamp TS 35 with screw	8 mm wide						
End clamp TS 32 with screw	7.5 mm wide						
End plate for right side 2.5 mm thick	Color: gray	AP 2,5 U/8113 S/V ***)	07.312.1555.0	10	AP 2,5 U/8113 S/V ***)	07.312.1555.0	10
End plate for left side, 2.5 mm thick	Color: gray	AP 2,5 U/8113 ***)	07.312.4655.0	10	AP 2,5 U/8113 ***)	07.312.4655.0	10
End plate, 2.5 mm thick	Color: blue						
Partition, right side, 2.5 mm thick	Color: gray	ZP 2,5 U/8113 S/V	07.312.1655.0	10	ZP 2,5 U/8113 S/V	07.312.1655.0	10
Partition, 2.5 mm thick	Color: blue						
(for PC board headers in 7.5 mm spacing)							
Cross connector with screws, E-Cu	insulated						
	2pole	IVB WK 2,5-2	Z7.280.2227.0	10	IVB WK 2,5-2	Z7.280.2227.0	10
	3pole	IVB WK 2,5-3	Z7.280.2327.0	10	IVB WK 2,5-3	Z7.280.2327.0	10
	up to 12pole	IVB WK 2,5-12	Z7.280.3227.0	10	IVB WK 2,5-12	Z7.280.3227.0	10
Jumper rail, tin-plated brass	L = 0.4 m		05.561.4125.0	1		05.561.4125.0	1
Single cover for cross connector with marking capabil.		ADVB 2,5 GELB	04.326.2053.0		ADVB 2,5 GELB	04.326.2053.0	
Cover strip for header	24pole		04.343.9056.0			04.343.9056.0	
Cover for header with warning symbol			04.343.9156.0			04.343.9156.0	
Partition plate		TS 2,5 GELB	07.311.2053.0		TS 2,5 GELB	07.311.2053.0	
Coding piece (strip)			05.561.0053.0			05.561.0053.0	100
locking piece	10pole						
For marking accessories see page 394							

wiecon

Indicator: R = 10 K; 0.5 W
Signal color: red

¹⁾ for blocks with indicator determined by LED

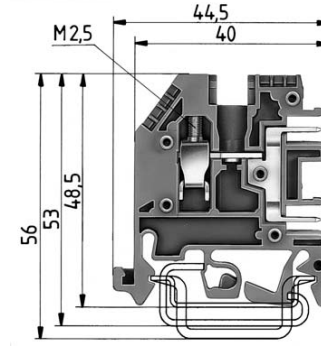
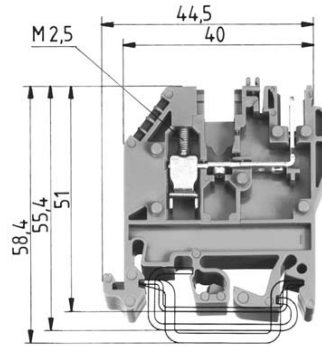
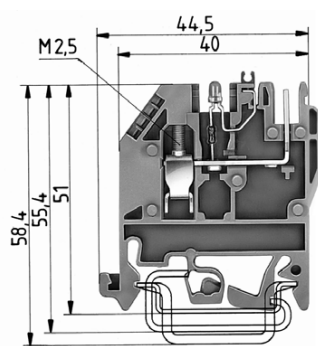

WK 2.5 U / 8113 S/V / LED 50

fine stranded	solid	V	A
0.5 – 2.5 mm ²	0.5 – 4 mm ²	¹⁾	12
No. 22 – 12 AWG		300 V	15
No. 24 – 12 AWG		50 V ¹⁾	15
5 mm			9 mm



WK 2.5 U / 8113 S/V /VK

fine stranded	solid	V	A
0.5 – 2.5 mm ²	0.5 – 4 mm ²	250 V/4 kV/3	12
No. 22 – 12 AWG		300 V	15
No. 24 – 12 AWG		300 V	15
5 mm			9 mm



WK 2.5 U / 8113 S/H

fine stranded	solid	V	A
0.5 – 2.5 mm ²	0.5 – 4 mm ²	250 V/4 kV/3	12
No. 22 – 12 AWG		300 V	20
No. 24 – 12 AWG		300 V	15
5 mm			9 mm



Type	Part no.	Std. pack	Type	Part no.	Std. pack	Type	Part no.	Std. pack
WK 2.5 U/8113 S/V/LED 50***)	57.503.2855.0	50	WK 2.5 U/8113 S/V/VK***)	57.503.3055.6	100	WK 2.5 U/8113 S/H***)	57.503.2055.0	100
AP 2,5 U/8113 S/V ***)	07.312.1555.0	10	AP 2,5 U/8113 ***)	07.312.4655.0	10	AP 2,5 U/8113 S/H ***)	07.311.9855.0	10
AP 2,5 U/8113 ***)	07.312.4655.0	10	AP 2,5 U/8113 S/V BL***)	07.312.1555.0	10			
ZP 2,5 U/8113 S/V	07.312.1655.0	10	ZP 2,5 U/8113 S/V	07.312.1655.0	10			
			ZP 2,5 U/8113 S/V BL	07.312.1655.6	10			
IVB WK 2,5-2	Z7.280.2227.0	10	IVB WK 2,5-2	Z7.280.2227.0	10	IVB WK 2,5-2	Z7.280.2227.0	10
IVB WK 2,5-3	Z7.280.2327.0	10	IVB WK 2,5-3	Z7.280.2327.0	10	IVB WK 2,5-3	Z7.280.2327.0	10
IVB WK 2,5-12	Z7.280.3227.0	10	IVB WK 2,5-12	Z7.280.3227.0	10	IVB WK 2,5-12	Z7.280.3227.0	10
	05.561.4125.0	1		05.561.4125.0	1		05.561.4125.0	1
ADVB 2,5 GELB	04.326.2053.0		ADVB 2,5 GELB	04.326.2053.0		ADVB 2,5 GELB	04.326.2053.0	
	04.343.9056.0			04.343.9056.0			04.343.9056.0	
	04.343.9156.0			04.343.9156.0			04.343.9156.0	
TS 2,5 GELB	07.311.2053.0		TS 2,5 GELB	07.311.2053.0		TS 2,5 GELB	07.311.2053.0	
	05.561.0053.0	100		05.561.0053.0	100		05.584.0053.0	100
							05.576.5853.0	25



Feed through DIN rail terminal blocks with connection for PC board pluggables

wiecon PCB

For PC board connectors:

- Type 8113 B
- Type 8113 BFK
- Type 8313 B
- Type 8113 B/VL
- Type 8113 B/VR
- Type 8113 B/Top

Indicator: R = 4.7 K; 0.5 W
Signal color: red

¹⁾ for blocks with indicator determined by LED

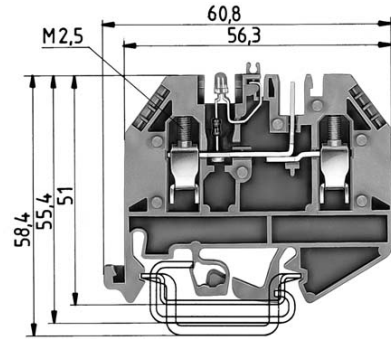
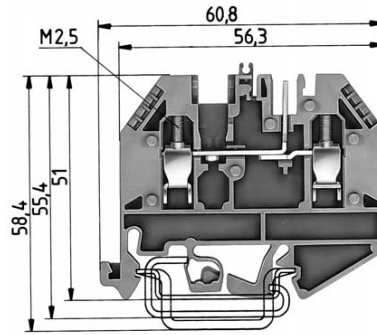

The part numbers marked with ***) are supplied with UL 94-V0 insulating housings (flammability class).

WK 2.5 U /D/ 8113 S/V

	fine stranded	solid	V	A
	0.5 – 2.5 mm ²	0.5 – 4 mm ²	250 V/4 kV/3	12
	No. 22 – 12 AWG		300 V	15
	No. 24 – 12 AWG		300 V	15
Width	5 mm		9 mm	



WK 2.5 U /D/ 8113 S/V / LED 25

	fine stranded	solid	V	A
	0.5 – 2.5 mm ²	0.5 – 4 mm ²	¹⁾	12
	No. 22 – 12 AWG		300 V	15
	No. 24 – 12 AWG		25 V ¹⁾	15
Width	5 mm		9 mm	



EN 60 947-7-1/DIN VDE 0611 T1

UL ratings

CSA ratings

Width

Approvals

Wire strip length

		Type	Part no.	Std. pack	Type	Part no.	Std. pack
Feed through block	Color: gray	WK 2.5 U/D/8113 S/V...***)	57.503.2155.0	50			
Feed through block with LED 25 V	Color: gray				WK 2.5 U/D/8113 S/V/LED 25***)	57.503.2255.0	50
Feed-through block with LED 50 V	Color: gray						
Power supply block	Color: blau						
Feed through block with header connection							
For insulated headers type 8113 see page 297							
Accessories							
Mounting rail TS 35 DIN rail 7.5 mm high	L = 2 m						
Mounting rail TS 35, DIN rail, 15mm high	L = 2 m						
Mounting rail 32 G rail	L = 2 m						
End clamp with U foot	10 mm wide						
End clamp TS 35 with screw	8 mm wide						
End clamp TS 32 with screw	7.5 mm wide						
End plate, 2.5 mm thick	Color: gray	AP 2,5 U/D/8113 S/V ***)	07.311.9055.0	10	AP 2,5 U/D/8113 S/V***)	07.311.9055.0	10
End plate, 2.5 mm thick	Color: blue						
Partition, 2.5 mm thick	Color: gray	ZP 2,5 U/D/8113 S/V	07.311.9155.0	10	ZP 2,5 U/D/8113 S/V	07.311.9155.0	10
Partition, 2.5 mm thick	Color: blue						
(for PC board headers in 7.5 mm spacing)							
Cross connector with screws, E-Cu	insulated						
	2pole	IVB WK 2,5-2	Z7.280.2227.0	10	IVB WK 2,5-2	Z7.280.2227.0	10
	3pole	IVB WK 2,5-3	Z7.280.2327.0	10	IVB WK 2,5-3	Z7.280.2327.0	10
	up to 12pole	IVB WK 2,5-12	Z7.280.3227.0	10	IVB WK 2,5-12	Z7.280.3227.0	10
Jumper rail, tin-plated brass	L = 0.4 m		05.561.4125.0	1		05.561.4125.0	1
Cover strip for LED (transparent)		ADVB 5/10 P	04.342.3556.8	10	ADVB 5/10 P	04.342.3556.8	10
Single cover for cross connector with marking capabil.		ADVB 2,5 GELB	04.326.2053.8	10	ADVB 2,5 GELB	04.326.2053.8	10
Cover strip for header	24pole		04.343.9056.8	10		04.343.9056.8	10
Cover strip for header with warning symbol	24pole		04.343.9156.8	10		04.343.9156.8	10
Partition plate		TS 2,5 GELB	07.311.2053.8	10	TS 2,5 GELB	07.311.2053.8	10
Coding piece (strip)			05.561.0053.0	100		05.561.0053.0	100
For marking accessories see page 394							

wiecon

Indicator: R = 10 K; 0.5 W
Signal color: red

¹⁾ for blocks with indicator determined by LED

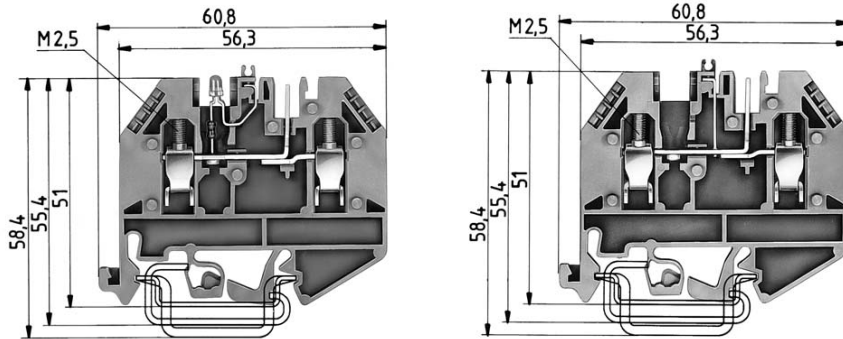

WK 2.5 U /D/ 8113 S/V / LED 50

fine stranded	solid	V	A
0.5 – 2.5 mm ²	0.5 – 4 mm ²	¹⁾	12
No. 22 – 12 AWG		300 V	15
No. 24 – 12 AWG		50 V ¹⁾	15
5 mm			9 mm



WK 2.5 U /D/ 8113 S/V /VK

fine stranded	solid	V	A
0.5 – 2.5 mm ²	0.5 – 4 mm ²	250 V/4 kV/3	12
No. 22 – 12 AWG		300 V	15
No. 24 – 12 AWG		300 V	15
5 mm			9 mm



Type	Part no.	Std. pack	Type	Part no.	Std. pack
WK 2.5 U/D/8113 S/V/LED 50***)	57.503.2355.0	50	WK 2.5 U/D/8113 S/V/VK***)	57.503.2555.6	50
AP 2.5 U/D/8113 S/V ***)	07.311.9055.0	10	AP 2.5 U/D/8113 S/V BL***)	07.311.9055.6	10
ZP 2.5 U/D/8113 S/V	07.311.9155.0	10	ZP 2.5 U/D/8113 S/V BL	07.311.9155.6	10
IVB WK 2,5-2	Z7.280.2227.0	10	IVB WK 2,5-2	Z7.280.2227.0	10
IVB WK 2,5-3	Z7.280.2327.0	10	IVB WK 2,5-3	Z7.280.2327.0	10
IVB WK 2,5-12	Z7.280.3227.0	10	IVB WK 2,5-12	Z7.280.3227.0	10
	05.561.4125.0	1		05.561.4125.0	1
ADVB 5/10 P	04.342.3556.8	10	ADVB 5/10 P	04.342.3556.8	10
ADVB 2,5 GELB	04.326.2053.8	10	ADVB 2,5 GELB	04.326.2053.8	10
	04.343.9056.8	10		04.343.9056.8	10
	04.343.9156.8	10		04.343.9156.8	10
TS 2,5 GELB	07.311.2053.8	10	TS 2,5 GELB	07.311.2053.8	10
	05.561.0053.0	100		05.561.0053.0	100

Pluggable PC board connectors with pin-strip headers

wiecon PCB

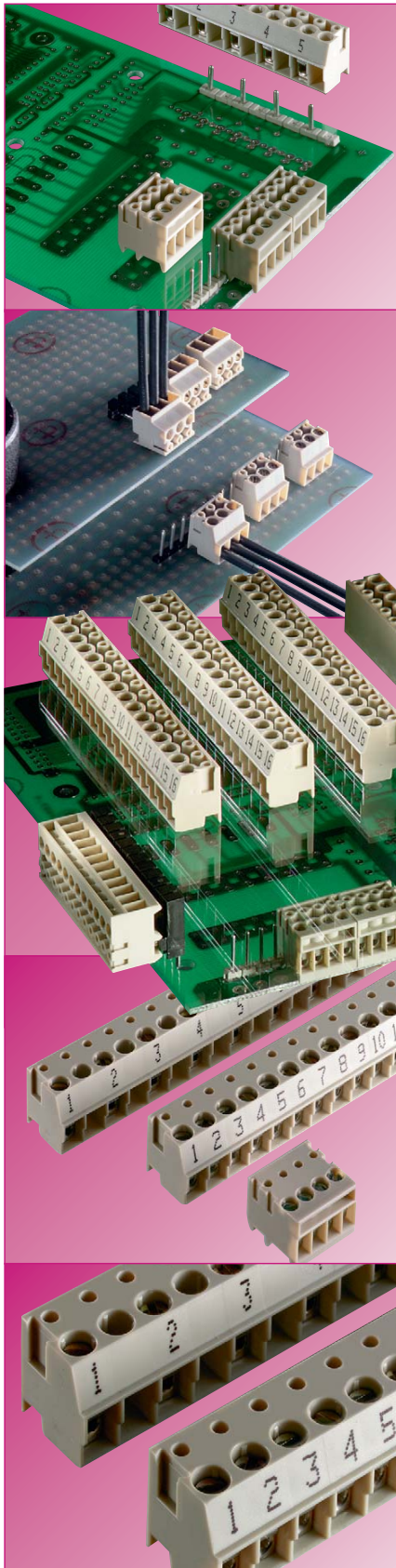

Pluggable connectors provide a simple 2-piece mateable connection between an external connector and the printed circuit board.

System features

- easy-to-operate screw termination
- installation and maintenance friendly
- quick disconnect
- pole configurations from 2 to 24 poles
- clear, straightforward connection
- mating in both horizontal and vertical orientations to the printed circuit board
- clamping body always with wire guard

Variety of types

- spacings: (3.5/7/5/10) mm
- 2 to 24 pole
- terminal strip headers with vertical or horizontal solder pins
- solder pin diameters available in: 0.8 mm, 1 mm and 1.3 mm others are on request

Marking

- smudge-proof inkjet marking directly on the plug
- clear, easily legible marking
- custom marking possible, consult factory
- cost-effective marking directly on the plug

Abbreviations for plastic materials:

PA 66/6 = Polyamide 66/6
 PC = Polycarbonate
 PBT = Polybutylenterephthalate

Material

Insulating housings:

- use of high-quality polycarbonate for its excellent electrical, mechanical and chemical characteristics (see **facts** & DATA)

Metal parts:

- made of special alloys and/or special surface platings
- minimum feed through resistance
- high corrosion resistance
- secure, consistent clamping function
- clamping body: nickel-plated brass
- clamping screw: steel, zinc-plated and dichromated
- plug contact of type 8142 and ST 29: tin-plated bronze
- plug contact of type 8543: nickel-plated brass
- wire guard: tin-plated bronze

Pin-strip headers:

- Insulating part: made from high-quality Polyamide 66/6
- glass-fibre reinforcement for dimensional stability
- Metal parts: contact pin: tin plated brass

Note:

The information regarding cross sectional areas and connection types pertains to connections without ferrules.

The indicated rated current pertains to the maximum load of the PC board connector with a connected wire of the indicated rated cross section.

The rated voltage is indicated as per DIN VDE 0110 part 1 (IEC 60 664-1) – insulation coordination for electrical material in low voltage application – and refers to the delivered state of the PC board connector.

Before the PC board is fitted with connectors, an appropriate PC board must be selected and dimensioned accordingly (e.g. regarding tracking resistance of the printed circuit board, distances of the leads and solder joints). Furthermore, the ambient conditions under which the device is to be used (pollution degree) must be considered.

The indicated rated voltages will be valid for the complete module only if the printed circuit board and its connectors are correctly and carefully matched to each other.

wiecon

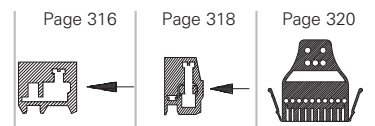

		Page 316	Page 318	Page 320
Type		8543	8142	ST 29
Spacing	mm	3.50/7.00	5.00/10.00	5.08
Cross section	mm²	1	2.5	1.5
Number of poles		2 – 24	2 – 24	10

wiecon



PC board connectors pluggable, spacings: 3.50/7.00 mm

wiecon PCB

Rated cross section:
1.0 mm²

Rated current:
6 A

Connection range:
0.14 – 1.5 mm² solid/
0.14 – 1.0 mm² fine stranded

160 V/2.5 kV/3 – Overvoltage category III
250 V/2.5 kV/2 – Overvoltage category II
*690 V/2.5 kV/1 – Overvoltage category I

* max. 600 V for ungrounded networks or expected
overvoltage ≤ 3 kV for $L \geq 2.0$ mm and
 ≤ 2.5 kV for 2.0 mm $> L \geq 1.5$ mm

Spacing: 3.50 mm

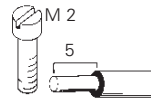
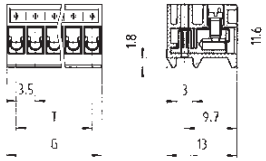

Spacing: 3.50 mm

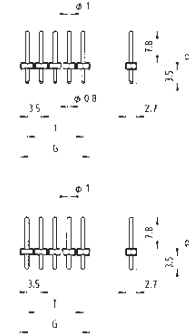

Color: gray Solder pin \varnothing 0.8 mm Bore hole \varnothing 1.0 mm
Color: black Solder pin \varnothing 1.0 mm Bore hole \varnothing 1.3 mm

Type 8543

plug-in 90° to wire entry

No. 22 – 16 AWG 300 V 10 A
No. 22 – 16 AWG 300 V 10 A



Terminal strip header

vertical mount



Rated voltages: VDE 0110 (spacing: 3.5 mm)
UL ratings
CSA ratings
Approvals

Std. pack	G	T	Poles	Part no.	Part no.	Part no.	Part no.
Spacing: 3.50 mm				unmarked	marked	Color: gray	Color: black
100	7.0	3.5	2	25.602.5253.0	25.600.5253.0	Z5.531.0225.0	Z5.531.3225.0
100	10.5	7.0	3	25.602.5353.0	25.600.5353.0	Z5.531.0325.0	Z5.531.3325.0
50	14.0	10.5	4	25.602.5453.0	25.600.5453.0	Z5.531.0425.0	Z5.531.3425.0
50	17.5	14.0	5	25.602.5553.0	25.600.5553.0	Z5.531.0525.0	Z5.531.3525.0
50	21.0	17.5	6	25.602.5653.0	25.600.5653.0	Z5.531.0625.0	Z5.531.3625.0
50	24.5	21.0	7	25.602.5753.0	25.600.5753.0	Z5.531.0725.0	Z5.531.3725.0
50	28.0	24.5	8	25.602.5853.0	25.600.5853.0	Z5.531.0825.0	Z5.531.3825.0
50	31.5	28.0	9	25.602.5953.0	25.600.5953.0	Z5.531.0925.0	Z5.531.3925.0
50	35.0	31.5	10	25.602.6053.0	25.600.6053.0	Z5.531.1025.0	Z5.531.4025.0
50	38.5	35.0	11	25.602.6153.0	25.600.6153.0	Z5.531.1125.0	Z5.531.4125.0
50	42.0	38.5	12	25.602.6253.0	25.600.6253.0	Z5.531.1225.0	Z5.531.4225.0
50	45.5	42.0	13	25.602.6353.0	25.600.6353.0	Z5.531.1325.0	Z5.531.4325.0
50	49.0	45.5	14	25.602.6453.0	25.600.6453.0	Z5.531.1425.0	Z5.531.4425.0
50	52.5	49.0	15	25.602.6553.0	25.600.6553.0	Z5.531.1525.0	Z5.531.4525.0
50	56.0	52.5	16	25.602.6653.0	25.600.6653.0	Z5.531.1625.0	Z5.531.4625.0
17 to 24pole upon request							
Spacing: 7.00 mm				upon request			
Rated voltages: (spacing: 7 mm): VDE 0110 400 V/6 kV/3 – Overvoltage category III 690 V/6 kV/2 – Overvoltage category II 1000 V/6 kV/1 – Overvoltage category I Material: PC board connectors Insulating housing: PC gray, UL 94-V-0 Clamping body with female contact: tin-plated brass Clamping screw: zinc-plated steel Wire protection: tin-plated bronze Terminal strip header Insulating part: PA 66/6, glass-fibre reinforced gray or black, UL 94-V-0 Contact pin: tin-plated brass							

wiecon

Spacing: 3.50 mm

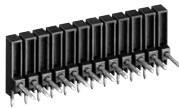
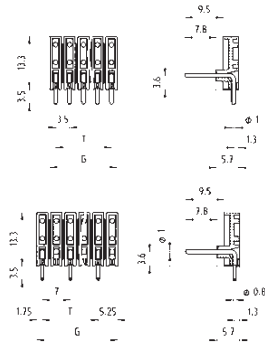

Color: black
Solder pin \varnothing 0.8 mm
Bore hole \varnothing 1.0 mm

Color: black
Solder pin \varnothing 1.0 mm
Bore hole \varnothing 1.3 mm

Terminal strip header

horizontal mount



Part no.	Part no.
Color: black	Color: black
Z5.532.0225.0	Z5.532.3225.0
Z5.532.0325.0	Z5.532.3325.0
Z5.532.0425.0	Z5.532.3425.0
Z5.532.0525.0	Z5.532.3525.0
Z5.532.0625.0	Z5.532.3625.0
Z5.532.0725.0	Z5.532.3725.0
Z5.532.0825.0	Z5.532.3825.0
Z5.532.0925.0	Z5.532.3925.0
Z5.532.1025.0	Z5.532.4025.0
Z5.532.1125.0	Z5.532.4125.0
Z5.532.1225.0	Z5.532.4225.0
Z5.532.1325.0	Z5.532.4325.0
Z5.532.1425.0	Z5.532.4425.0
Z5.532.1525.0	Z5.532.4525.0
Z5.532.1625.0	Z5.532.4625.0

PC board connectors pluggable, spacings: 5.00/10.00 mm

wiecon PCB

Rated cross section:
2.5 mm²

Rated current:
8 A

Connection range:
0.14 – 4.0 mm² solid/
0.14 – 2.5 mm² fine stranded

200 V/4 kV/3 – Overvoltage category III
250 V/4 kV/2 – Overvoltage category II
1000 V/4 kV/1 – Overvoltage category I

Rated voltages: VDE 0110 (spacing 5 mm)
UL ratings
CSA ratings
Approvals

Spacing: 5.00 mm

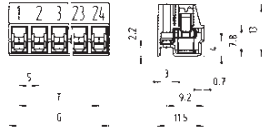

Spacing: 10.00 mm

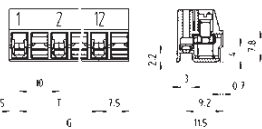

Type 8142

plug-in 90° to wire entry

No. 22 – 12 AWG 300 V 15 A
No. 22 – 12 AWG 300 V 15 A



Spacing: 5.00 mm

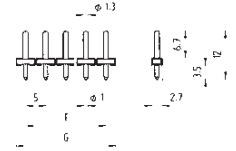

Spacing: 10.00 mm

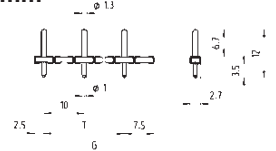

Color: gray Solder pin Ø 1.0 mm Bore hole Ø 1.3 mm
Color: black Solder pin Ø 1.3 mm Bore hole Ø 1.6 mm

Terminal strip header

vertical mount



Std. pack	G	T	Poles	Part no.	Part no.	Part no.	Part no.
Spacing: 5.00 mm				unmarked	marked	Color: gray	Color: black
100	10	5	2	25.602.2253.0	25.600.2253.0	Z5.530.0225.0	Z5.530.3225.0
100	15	10	3	25.602.2353.0	25.600.2353.0	Z5.530.0325.0	Z5.530.3325.0
50	20	15	4	25.602.2453.0	25.600.2453.0	Z5.530.0425.0	Z5.530.3425.0
50	25	20	5	25.602.2553.0	25.600.2553.0	Z5.530.0525.0	Z5.530.3525.0
50	30	25	6	25.602.2653.0	25.600.2653.0	Z5.530.0625.0	Z5.530.3625.0
50	35	30	7	25.602.2753.0	25.600.2753.0	Z5.530.0725.0	Z5.530.3725.0
50	40	35	8	25.602.2853.0	25.600.2853.0	Z5.530.0825.0	Z5.530.3825.0
50	45	40	9	25.602.2953.0	25.600.2953.0	Z5.530.0925.0	Z5.530.3925.0
50	50	45	10	25.602.3053.0	25.600.3053.0	Z5.530.1025.0	Z5.530.4025.0
50	55	50	11	25.602.3153.0	25.600.3153.0	Z5.530.1125.0	Z5.530.4125.0
50	60	55	12	25.602.3253.0	25.600.3253.0	Z5.530.1225.0	Z5.530.4225.0
50	65	60	13	25.602.3353.0	25.600.3353.0	Z5.530.1325.0	Z5.530.4325.0
50	70	65	14	25.602.3453.0	25.600.3453.0	Z5.530.1425.0	Z5.530.4425.0
50	75	70	15	25.602.3553.0	25.600.3553.0	Z5.530.1525.0	Z5.530.4525.0
50	80	75	16	25.602.3653.0	25.600.3653.0	Z5.530.1625.0	Z5.530.4625.0
17 to 24pole upon request							
Spacing: 10.00 mm				unmarked	marked		
50	20	10	2	25.603.1253.0	25.601.1253.0	Z5.530.6225.0	Z5.530.8225.0
50	30	20	3	25.603.1353.0	25.601.1353.0	Z5.530.6325.0	Z5.530.8325.0
50	40	30	4	25.603.1453.0	25.601.1453.0	Z5.530.6425.0	Z5.530.8425.0
50	50	40	5	25.603.1553.0	25.601.1553.0	Z5.530.6525.0	Z5.530.8525.0
50	60	50	6	25.603.1653.0	25.601.1653.0	Z5.530.6625.0	Z5.530.8625.0
50	70	60	7	25.603.1753.0	25.601.1753.0	Z5.530.6725.0	Z5.530.8725.0
50	80	70	8	25.603.1853.0	25.601.1853.0	Z5.530.6825.0	Z5.530.8825.0
9 to 12pole upon request							
Rated voltages: (spacing: 10.00 mm): VDE 0110 500 V/8 kV/3 – Overvoltage category III 800 V/8 kV/2 – Overvoltage category II 1000 V/8 kV/1 – Overvoltage category I				Material: PC board connectors Insulating housing: PC gray, UL 94-V-0 Clamping body: nickel-plated brass Clamping screws: zinc-plated steel Contact spring: tin-plated bronze			
				Terminal strip header Insulating part: PA 66/6, glass-fibre reinforced gray or black, UL 94-V-0 Contact pin: tin-plated brass			

wiecon

Accessories

Spacing: 5.00 mm

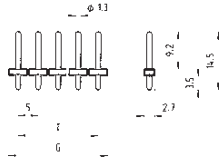

Spacing: 10.00 mm

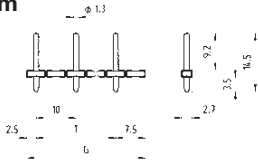

Color: black
Solder pin Ø 1.0 mm
Bore hole Ø 1.3 mm

Color: black
Solder pin Ø 1.3 mm
Bore hole Ø 1.6 mm

Terminal strip header

horizontal mount



Part no.	Part no.	Part no.	Std. pack	Part no.	Std. pack
Color: black	Color: black	Fixing brackets: Insulating material PA 66/6 gray, Screw M 3, zinc-plated steel			
Z5.540.0225.0	Z5.540.3225.0	Z5.523.7653.0	100	Z5.523.7653.0	100
Z5.540.0325.0	Z5.540.3325.0	Coding piece strip		Coding piece strip	
Z5.540.0425.0	Z5.540.3425.0	Color: white	05.561.9453.0 25	Color: white	05.561.9453.0 25
Z5.540.0525.0	Z5.540.3525.0	Color: white	05.561.9453.5 25	Color: orange	05.561.9453.5 25
Z5.540.0625.0	Z5.540.3625.0	Cover/markings strip 12 poles			
Z5.540.0725.0	Z5.540.3725.0				
Z5.540.0825.0	Z5.540.3825.0				
Z5.540.0925.0	Z5.540.3925.0				
Z5.540.1025.0	Z5.540.4025.0				
Z5.540.1125.0	Z5.540.4125.0				
Z5.540.1225.0	Z5.540.4225.0				
Z5.540.1325.0	Z5.540.4325.0				
Z5.540.1425.0	Z5.540.4425.0				
Z5.540.1525.0	Z5.540.4525.0				
Z5.540.1625.0	Z5.540.4625.0				
Z5.540.6225.0	Z5.540.8225.0				
Z5.540.6325.0	Z5.540.8325.0				
Z5.540.6425.0	Z5.540.8425.0				
Z5.540.6525.0	Z5.540.8525.0				
Z5.540.6625.0	Z5.540.8625.0				
Z5.540.6725.0	Z5.540.8725.0				
Z5.540.6825.0	Z5.540.8825.0				

vertical mount

horizontal mount

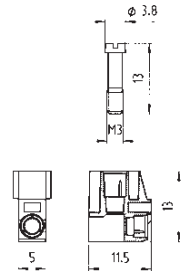

Bore hole plan for fixing brackets
vertical mount

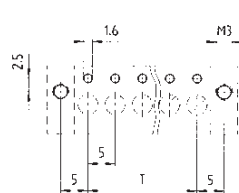

Bore hole plan for fixing brackets
horizontal mount

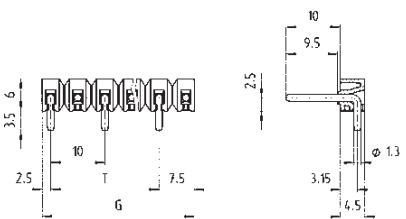
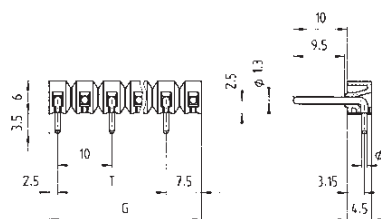
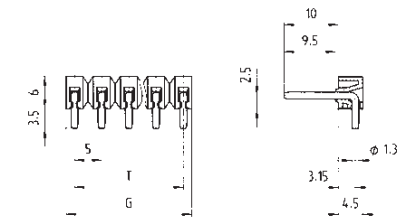
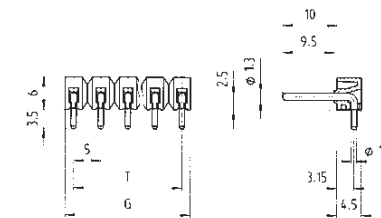
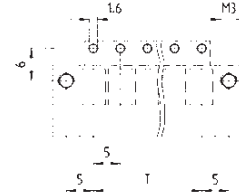

wiecon

**PC board connectors,
pluggable, spacing: 5.08 mm**

wiecon PCB

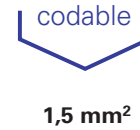

Rated cross section:
1.5 mm²

Rated current:
10 A

Connection range:
0.14 – 2.5 mm² solid/
0.14 – 1.5 mm² fine stranded

200 V/4 kV/3 – Overvoltage category III
250 V/4 kV/2 – Overvoltage category II
1000 V/4 kV/1 – Overvoltage category I

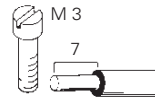

Solder pin Ø 1.3 mm
Bore hole Ø 1.6 mm

Statement of Conformity/CH

**TOP connector, 10pole
Type ST 29/10 BC**

plug-in 90° to wire entry
1.5 mm²

No. 22 – 14 AWG 300 V 5 A
No. 22 – 14 AWG 300 V 5 A



Terminal strip header

vertical mount

(if all terminals carry current) 250 V 10 A
300 V 5 A



Rated voltages: VDE 0110
EN 60 998-1, EN 60 998-2-1
UL ratings
CSA ratings
Approvals

	Poles	Type	Part no.	Std. pack	Type	Part no.	Std. pack
Spacing: 5.08 mm							
	10	ST 29/10 BC	93.101.2053.0	50		Z5.599.9025.0	50
Material: PC board connectors Insulating housing: PA 66/6 gray, UL 94-V-2 Clamping body: nickel-plated brass Clamping screws: zinc-plated steel Contact spring: tin-plated bronze							
Terminal strip header Insulating part: PBT, glass-fibre reinforced gray, UL 94-V-0 Contact pin: tin-plated brass							

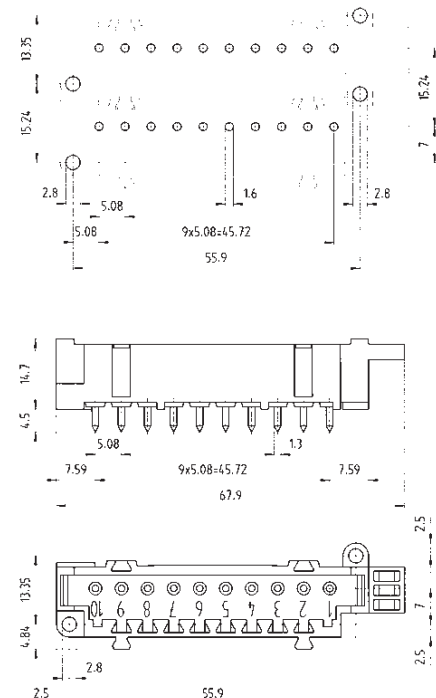
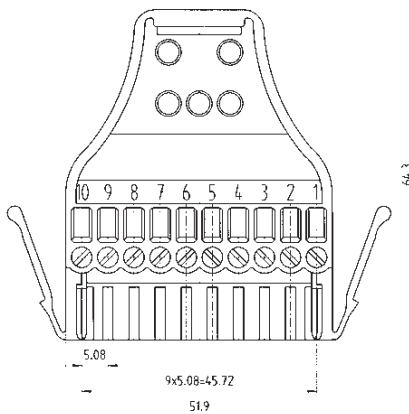

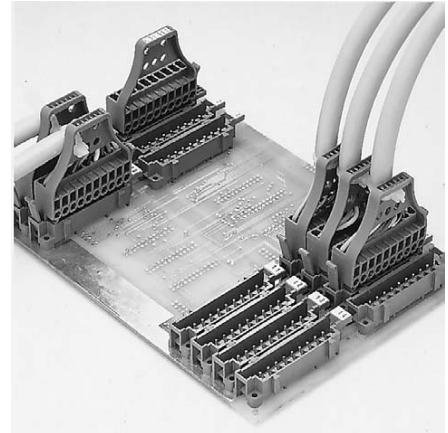

Pluggable terminal strip header with TOP connection

A special version of the TOP system is the 5.08 mm spaced terminal strip header which can be soldered into a PC board. Two mounting holes are available in order to fix the terminal strip header.

- Strain relief
- Locking device
- Marking capabilities

By means of dove-tail guides, several terminal strip headers can be snapped together, while only the outer headers of this group must be mechanically fixed on the printed circuit board. In order to guarantee the necessary stability on the printed circuit board, it is not recommended to exceed four terminal strip headers in a group.

The terminal TOP connector and terminal strip header each possess eight slots for coding to prevent mismatching the TOP plug-in system.

Accessories	Type	Part no.	Std. pack
Coding pieces, 10 codings each per strip		05.599.8053.0	100
Marking tag, unmarked	9705 A	04.242.0850.0	500
marked	9705 AB	04.842.0850.0	500
<p>Coding plan L = PC board connector S = terminal strip header</p> <p>Combination 01 S L L L L L L L S</p> <p>Combination 02 S L L L L L L S L</p> <p>Combination 03 S L L L L S L L L</p> <p>Combination 04 S L L L S L L L L</p> <p>Combination 05 S L L S L L L L L</p> <p>Combination 06 S L S L L L L L L</p> <p>Combination 07 S S L L L L L L L</p> <p>Combination 08 L S L L L L L L S</p> <p>Combination 09 L S L L L L L S L</p> <p>Combination 10 L S L L L S L L L</p> <p>Combination 11 L S L L S L L L L</p> <p>Combination 12 L S L S L L L L L</p> <p>Combination 13 L S S L L L L L L</p> <p>Combination 14 L L S L L L L L S</p> <p>etc.</p>			

Spring clamp connector for PC boards Type 8520 B, pluggable design

wiecon PCB

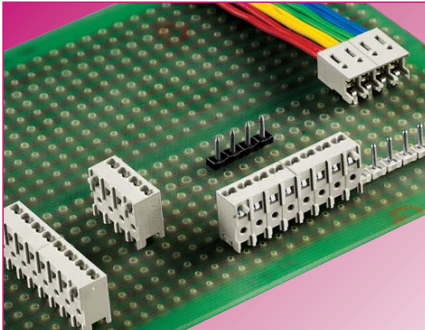

The advantage of a PC board connector with spring clamp termination is that connections to the PC board can be made in a fast and economical way. Based on this fact, Wieland Electric GmbH developed their new PC board connector type 8520.

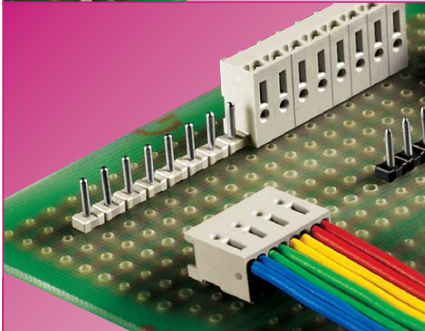

The main field of application for this PC board connector is in communication technology, a sector which demands fast connections.

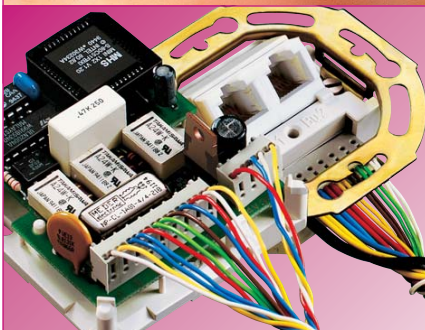
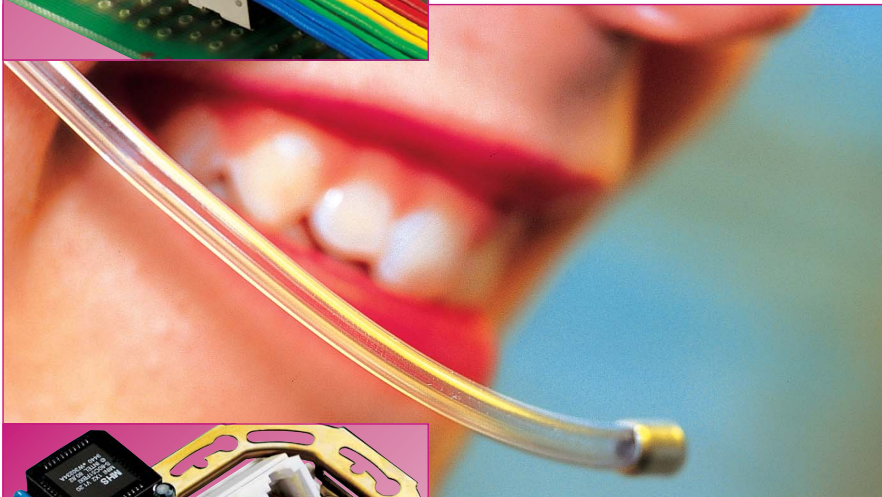

Further advantages:

- no clamping screws
- minimized wiring times
- permanent and continuous clamping forces
- vibration- and shock-proof
- maintenance-free

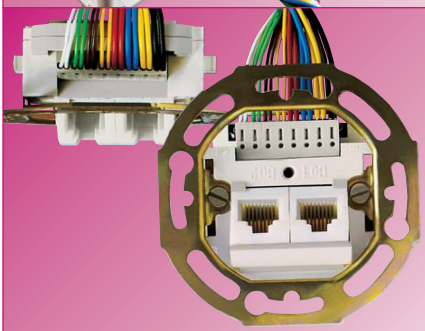

Different versions of type 8520 expand the spectrum of applications. It is available as a pluggable connector with matching pin strip, and in a direct mount solder version with vertical and horizontal solder pins. The rated cross section is 0.5 mm² solid, which makes the wiring process easy: simply push the solid conductor into the clamp, forcing it open, no tools required. The spring clamp tension will securely terminate the conductor. The spacing is 3.5 mm and the pole configurations vary between 2 and 16 poles.



wiecon

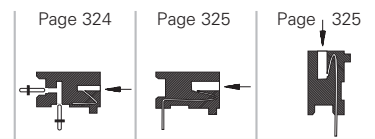

		Page 324	Page 325	Page 325
Type		8520 B	8520 BL/...W	8520 BL/...G
Spacing	mm	3.50/7.00	3.50/7.00	3.50/7.00
Cross section	mm²	0.25 – 0.50	0.25 – 0.50	0.25 – 0.50
Number of poles		2 – 16	2 – 16	2 – 16

wiecon



Spring clamp connector for PC boards, Type 8520, pluggable, spacings: 3.50/7.00 mm, 2 x 0.5 mm²

wiecon PCB

Rated cross section:
0.5 mm²

Rated current:
4 A

Connection range:
0.25 – 0.5 mm² solid
2 connections per pole

160 V/2.5 kV/3 – Overvoltage category III
250 V/2.5 kV/2 – Overvoltage category II
*690 V/2.5 kV/1 – Overvoltage category I

Spacing: 3.50 mm

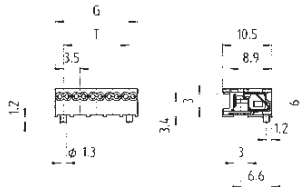

Spacing: 3.50 mm

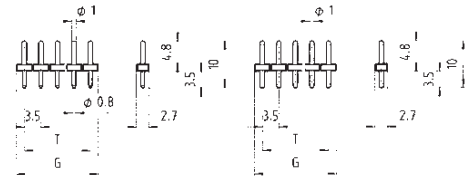

* max. 600 V for ungrounded networks or expected overvoltage ≤ 3 kV for L ≥ 2.0 mm and ≤ 2.5 kV for 2.0 mm > L ≥ 1.5 mm



Color: gray Solder pin Ø 0.8 mm Bore hole Ø 1.0 mm
Color: black Solder pin Ø 1.0 mm Bore hole Ø 1.2 mm

Type 8520 B

plug-in horizontal and vertical

No. 24 – 20 AWG 300 V 4 A
No. 24 – 20 AWG 300 V 4 A



Pin strip 8520 S

vertical mount

Rated voltages: VDE 0110 (Spacing: 3.5 mm)

UL ratings

CSA ratings

Approvals

Std. pack	G	T	Poles	Part no.	Part no.	Part no.	Part no.
Spacing: 3.50 mm				unmarked	marked	Color: gray	Color: black
1000	7.0	3.5	2	25.470.0253.0	25.470.3253.0	Z5.535.0225.0	Z5.535.3225.0
1000	10.5	7.0	3	25.470.0353.0	25.470.3353.0	Z5.535.0325.0	Z5.535.3325.0
1000	14.0	10.5	4	25.470.0453.0	25.470.3453.0	Z5.535.0425.0	Z5.535.3425.0
500	17.5	14.0	5	25.470.0553.0	25.470.3553.0	Z5.535.0525.0	Z5.535.3525.0
500	21.0	17.5	6	25.470.0653.0	25.470.3653.0	Z5.535.0625.0	Z5.535.3625.0
500	24.5	21.0	7	25.470.0753.0	25.470.3753.0	Z5.535.0725.0	Z5.535.3725.0
500	28.0	24.5	8	25.470.0853.0	25.470.3853.0	Z5.535.0825.0	Z5.535.3825.0
250	31.5	28.0	9	25.470.0953.0	25.470.3953.0	Z5.535.0925.0	Z5.535.3925.0
250	35.0	31.5	10	25.470.1053.0	25.470.4053.0	Z5.535.1025.0	Z5.535.4025.0
250	38.5	35.0	11	25.470.1153.0	25.470.4153.0	Z5.535.1125.0	Z5.535.4125.0
250	42.0	38.5	12	25.470.1253.0	25.470.4253.0	Z5.535.1225.0	Z5.535.4225.0
250	45.5	42.0	13	25.470.1353.0	25.470.4353.0	Z5.535.1325.0	Z5.535.4325.0
250	49.0	45.5	14	25.470.1453.0	25.470.4453.0	Z5.535.1425.0	Z5.535.4425.0
250	52.5	49.0	15	25.470.1553.0	25.470.4553.0	Z5.535.1525.0	Z5.535.4525.0
250	56.0	52.5	16	25.470.1653.0	25.470.4653.0	Z5.535.1625.0	Z5.535.4625.0
Spacing: 7.00 mm upon request							
Rated voltages: (spacing: 7.00 mm): VDE 0110 400 V/6 kV/3 – Overvoltage category III 690 V/6 kV/2 – Overvoltage category II 1000 V/6 kV/1 – Overvoltage category I Material: PC board connectors Insulating housing: PA 66/6, UL 94-V0 Clamping spring: special copper alloys tin-plated Pin strips Insulating part: PA 66/6, glass-fibre reinforced gray or black, UL 94-V-0 Contact pin: tin-plated brass							

Spring clamp connector for PC boards, Type 8520 BL, direct mount spring clamp Spacings: 3.50/7.00 mm, 2 x 0.5 mm²

Rated cross section:
0.5 mm²

Rated current:
4 A

Connection range:
0.25 – 0.5 mm² solid
2 connections per pole

160 V/2.5 kV/3 – Overvoltage category III
250 V/2.5 kV/2 – Overvoltage category II
*690 V/2.5 kV/1 – Overvoltage category I

* max. 600 V ungrounded networks or expected
overvoltage ≤ 3 kV for L ≥ 2.0 mm and
≤ 2.5 kV for 2.0 mm > L ≥ 1.5 mm

Rated voltages: VDE 0110
UL ratings
CSA ratings
Approvals pending

Spacing: 3.50 mm

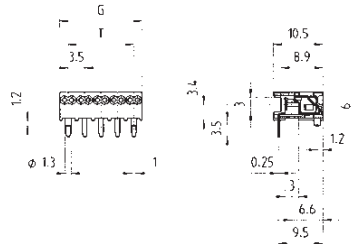

Spacing: 3.50 mm

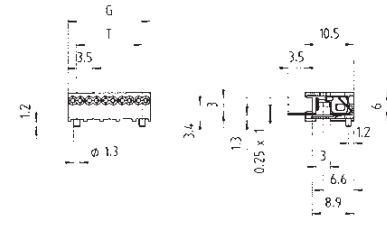

Solder pin 0.25 x 1.0 mm
Bore hole Ø 1.1 mm



Type 8520 BL/...W
Wire horizontal to PC board

No. 24 – 20 AWG 300 V 4 A
No. 24 – 20 AWG 300 V 4 A



Type 8520 BL/...G
Wire vertical to PC board

No. 24 – 20 AWG 300 V 4 A
No. 24 – 20 AWG 300 V 4 A

Std. pack	G	T	Poles	Part no. unmarked	Part no. marked	Part no. unmarked	Part no. marked
Spacing: 3.50 mm							
1000	7.0	3.5	2	25.471.0253.0	25.471.3253.0	25.472.0253.0	25.472.3253.0
1000	10.5	7.0	3	25.471.0353.0	25.471.3353.0	25.472.0353.0	25.472.3353.0
1000	14.0	10.5	4	25.471.0453.0	25.471.3453.0	25.472.0453.0	25.472.3453.0
500	17.5	14.0	5	25.471.0553.0	25.471.3553.0	25.472.0553.0	25.472.3553.0
500	21.0	17.5	6	25.471.0653.0	25.471.3653.0	25.472.0653.0	25.472.3653.0
500	24.5	21.0	7	25.471.0753.0	25.471.3753.0	25.472.0753.0	25.472.3753.0
500	28.0	24.5	8	25.471.0853.0	25.471.3853.0	25.472.0853.0	25.472.3853.0
250	31.5	28.0	9	25.471.0953.0	25.471.3953.0	25.472.0953.0	25.472.3953.0
250	35.0	31.5	10	25.471.1053.0	25.471.4053.0	25.472.1053.0	25.472.4053.0
250	38.5	35.0	11	25.471.1153.0	25.471.4153.0	25.472.1153.0	25.472.4153.0
250	42.0	38.5	12	25.471.1253.0	25.471.4253.0	25.472.1253.0	25.472.4253.0
250	45.5	42.0	13	25.471.1353.0	25.471.4353.0	25.472.1353.0	25.472.4353.0
250	49.0	45.5	14	25.471.1453.0	25.471.4453.0	25.472.1453.0	25.472.4453.0
250	52.5	49.0	15	25.471.1553.0	25.471.4553.0	25.472.1553.0	25.472.4553.0
250	56.0	52.5	16	25.471.1653.0	25.471.4653.0	25.472.1653.0	25.472.4653.0

Spacing: 7.00 mm upon request

Rated voltages:
(Spacing: 7.00 mm): VDE 0110

400 V/6 kV/3 – Overvoltage category III
690 V/6 kV/2 – Overvoltage category II
1000 V/6 kV/1 – Overvoltage category I

Bore hole plan, 3.50/7.00 mm spacing
with angled solder pin and fixing bolts:

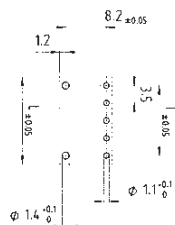

PC board connectors edge card pluggables

wiecon PCB

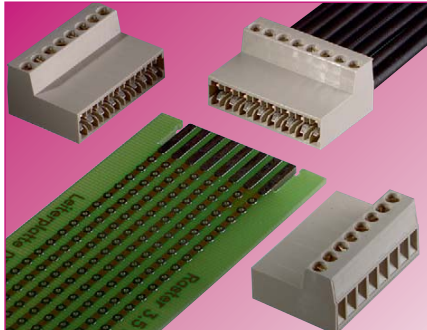

Edge card pluggables offer the advantages of standard pluggable connectors, but without the requirement of the mounting header.

System features

- installation and maintenance friendly
- easy-to-operate screw termination
- quick disconnect
- clear, organized wiring
- thickness of PC board: 1.4 mm to 1.8 mm
- floating contact springs
- secure, robust clamping mechanism

Coding

- coding without pole loss
- PC board with coding slots accept coding pieces inserted into the plug

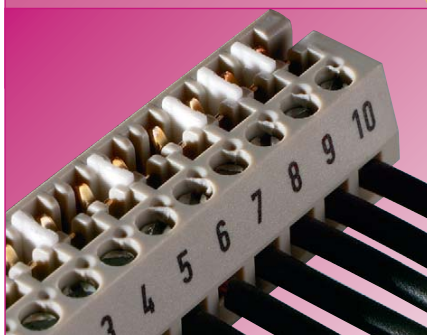
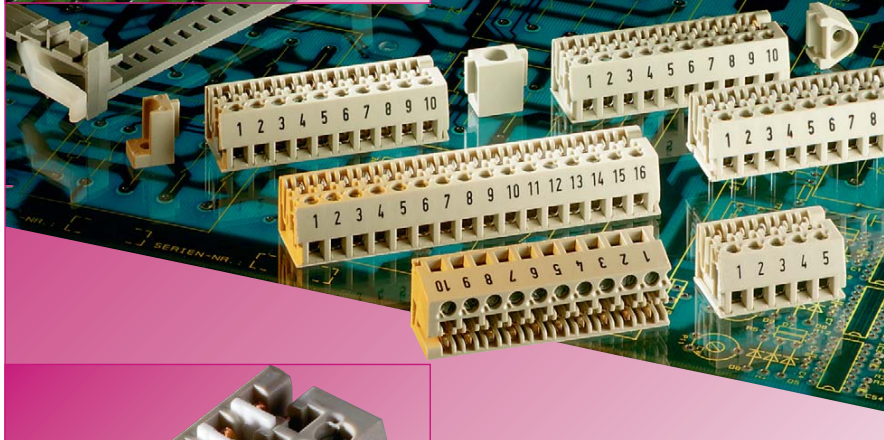
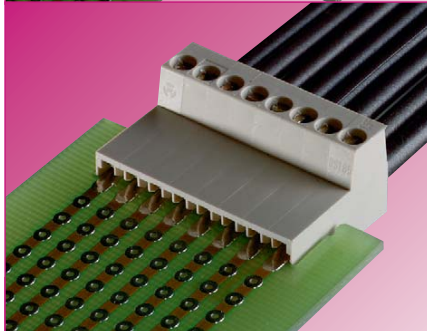

Marking

- smudge-proof inkjet marking directly on the connector
- custom marking possible, consult factory
- clear, easily legible marking

Variety of types

- in 3.5 mm and 5 mm spacing
- pole configurations from 2 to 24 poles
- cross sections up to 1.5 mm²
- with open side walls: snap together adjacently. or with closed side walls: prevent mis-mating
- with or without solder pins

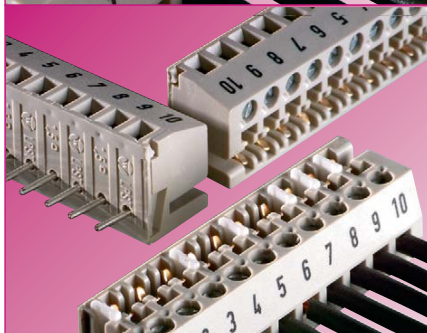

Fixing brackets

- for secure connection of printed circuit board and connector
- special fixing brackets as guides for large PC boards. With fixing bolts on the sides at the top and bottom which fix backing strips creating a stable guiding frame.

Material

Metal parts:

- made from special alloys and/or special surface treatments
- minimum feed through resistance
- high corrosion resistance

Insulating housings:

- use of high-quality polyamide for its excellent electrical, mechanical and chemical characteristics (see **facts & DATA**: Technical information)
- materials as per US standard UL 94-V-0
- colors: gray, similar to RAL 7032

Note:

The information regarding cross sectional areas and connection types pertains to connections without ferrules.

The indicated rated current corresponds to the maximum load for the PC board connector with a connected wire of the indicated rated cross section.

The rated voltage is indicated as per DIN VDE 0110 part 1 (IEC 60 664-1) – insulation coordinates for electrical material in low voltage application – and refers to the delivered state of the PC board connector.

Before the PC board is fitted with connectors, an appropriate PC board must be selected and dimensioned accordingly (e.g. regarding tracking resistance of the printed circuit board, distances of the leads and solder joints).



Furthermore, the ambient conditions under which the materials shall be used, must be considered.

The indicated rated voltages will be valid for the complete module only if the printed circuit board and its connectors are correctly and clearly adjusted to each other.

Abbreviations for plastic materials:

PA 66/6 = Polyamide 66/6
 PC = Polycarbonate
 PBT = Polybutylenterephthalate

wiecon

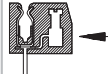
		Page 328	Page 328	Page 330	Page 330
					
Type		DST 85	DSTLF 85	LPST 1	LPSTL 1
Spacing	mm	3.50	3.50	5.00	5.00
Cross section	mm²	1.5	1.5	2.5	2.5
Number of poles		2 – 24	2 – 24	2 – 20	2 – 20

For all solderable PC board terminals it is important that recommended torque values are not exceeded.



PC board connectors edge card pluggables, spacing: 3.50 mm

wiecon PCB

Rated cross section:
1.5 mm²

Rated current:
6 A

Connection range:
0.14 – 1.5 mm² solid/fine stranded

125 V/2.5 kV/3 – Overvoltage category III
250 V/2.5 kV/2 – Overvoltage category II
*690 V/2.5 kV/1 – Overvoltage category I

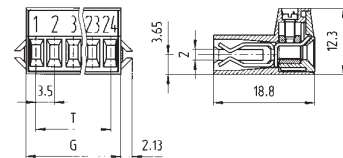
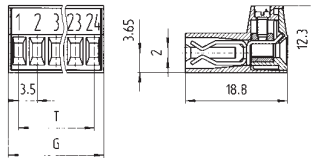

* max. 600 V for ungrounded networks or expected overvoltage ≤ 3 kV for L ≥ 2.0 mm and ≤ 2.5 kV for 2.0 mm > L ≥ 1.5 mm

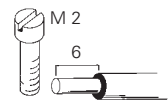
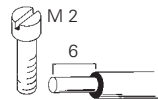

Type DST 85
plug-in 180° to wire entry

Type DST LF 85
plug-in 180° to wire entry

Rated voltages: VDE 0110
UL ratings
CSA ratings
Approvals

No. 30 – 14 AWG
No. 30 – 14 AWG

300 V 6 A
300 V 6 A

No. 30 – 14 AWG 300 V 6 A
No. 30 – 14 AWG 300 V 6 A

Std. pack	G	T	Poles	Part no.	Part no.	Part no.	Part no.
Spacing: 3.50 mm				unmarked	marked	unmarked	marked
100	7.1	3.4	2	25.003.0253.0	25.002.0253.0	25.005.0253.0	25.004.0253.0
100	10.5	6.8	3	25.003.0353.0	25.002.0353.0	25.005.0353.0	25.004.0353.0
50	14.0	10.3	4	25.003.0453.0	25.002.0453.0	25.005.0453.0	25.004.0453.0
50	17.5	13.8	5	25.003.0553.0	25.002.0553.0	25.005.0553.0	25.004.0553.0
50	21.0	17.3	6	25.003.0653.0	25.002.0653.0	25.005.0653.0	25.004.0653.0
50	24.5	20.8	7	25.003.0753.0	25.002.0753.0	25.005.0753.0	25.004.0753.0
50	28.0	24.3	8	25.003.0853.0	25.002.0853.0	25.005.0853.0	25.004.0853.0
50	31.5	27.8	9	25.003.0953.0	25.002.0953.0	25.005.0953.0	25.004.0953.0
50	35.0	31.3	10	25.003.1053.0	25.002.1053.0	25.005.1053.0	25.004.1053.0
50	38.5	34.8	11	25.003.1153.0	25.002.1153.0	25.005.1153.0	25.004.1153.0
50	42.0	38.3	12	25.003.1253.0	25.002.1253.0	25.005.1253.0	25.004.1253.0
only available up to 12pole							

Thickness of PC board: 1.4 mm – 1.8 mm

Material:
PC board connectors
Insulating housing: PA 66/6 gray, UL 94-V0
Clamping body: nickel-plated brass
Clamping screw: zinc-plated steel
Contact spring: tin-plated bronze

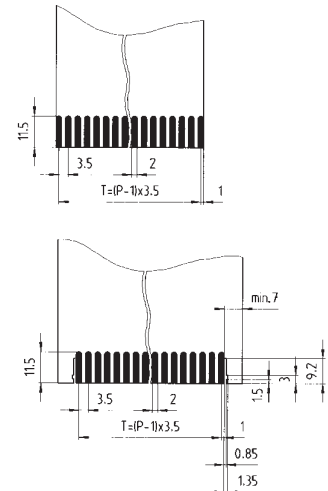

wiecon



PC board connector card edge design, spacing: 5.00 mm

wiecon PCB

Rated cross section:
2.5 mm²

Rated current:
5 A

Connection range:
0.14 – 4.0 mm² solid/
0.14 – 2.5 mm² fine stranded

200 V/4 kV/3 – Overvoltage category III
320 V/4 kV/2 – Overvoltage category II
1000 V/4 kV/1 – Overvoltage category I

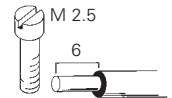
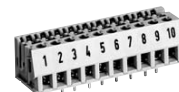
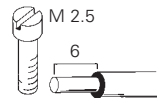
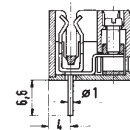
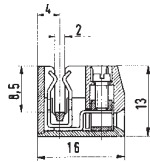

**without solder connection
for PC boards**

Type LPST 1

plug-in 90° to wire entry

No. 22 – 14 AWG

300 V

5 A

No. 22 – 14 AWG

300 V

5 A



**with solder connection
for PC boards**

Type LPSTL 1

plug-in 90° to wire entry

No. 22 – 14 AWG

300 V

5 A

No. 22 – 14 AWG

300 V

5 A



Rated voltages VDE 0110

UL ratings

CSA ratings

Approvals

Std. pack	U	G	T	Poles	Part no.	Part no.	Part no.
Spacing: 5.00 mm							
					marked	unmarked	marked
100	25	14	5	2	25.000.0256.0	25.010.0256.0	25.001.0256.0
100	30	19	10	3	25.000.0356.0	25.010.0356.0	25.001.0356.0
50	35	24	15	4	25.000.0456.0	25.010.0456.0	25.001.0456.0
50	40	29	20	5	25.000.0556.0	25.010.0556.0	25.001.0556.0
50	45	34	25	6	25.000.0656.0	25.010.0656.0	25.001.0656.0
50	50	39	30	7	25.000.0756.0	25.010.0756.0	25.001.0756.0
50	55	44	35	8	25.000.0856.0	25.010.0856.0	25.001.0856.0
50	60	49	40	9	25.000.0956.0	25.010.0956.0	25.001.0956.0
50	65	54	45	10	25.000.1056.0	25.010.1056.0	25.001.1056.0
50	70	59	50	11	25.000.1156.0	25.010.1156.0	25.001.1156.0
50	75	64	55	12	25.000.1256.0	25.010.1256.0	25.001.1256.0
50	80	69	60	13	25.000.1356.0	25.010.1356.0	25.001.1356.0
50	85	74	65	14	25.000.1456.0	25.010.1456.0	25.001.1456.0
50	90	79	70	15	25.000.1556.0	25.010.1556.0	25.001.1556.0
50	95	84	75	16	25.000.1656.0	25.010.1656.0	25.001.1656.0
17 to 20pole upon request							
Thickness of PC board: 1.4 mm – 1.8 mm							
Material: PC board connectors Insulating housing: PBT, glass-fibre reinforced gray, UL 94-V-2 Clamping body: nickel-plated brass Clamping screw: zinc-plated steel Contact spring: tin bronze – LPST 1: silver-plated – LPSTL 1: tin-plated							

PC board connectors

wiecon PCB

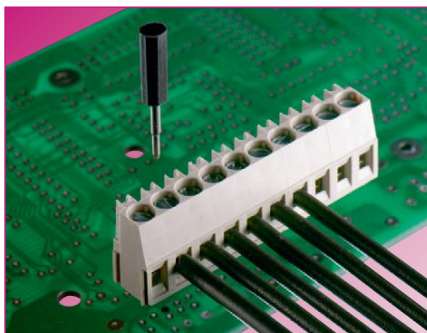

System features

- easy-to-operate application-specific connections
- connector soldered directly onto the printed circuit board
- low mechanical stress on the solder joint
- clear, open wire access
- individual wire entry as per application requirements
- multiple pole configurations
- accept solid and fine stranded wires from 0.14 mm² to 16 mm²
- in metric and inch spacing; inch spacing is indicated on the wire entry guide by means of a stud.
- wire clamping via rising cage clamp (elevator principle), clamping body with wire protection
- PC board connector with TOP connection

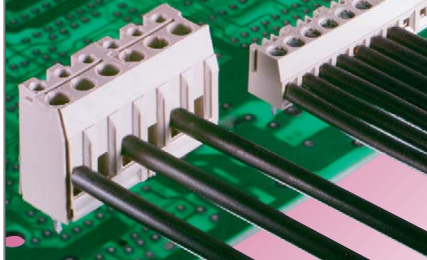
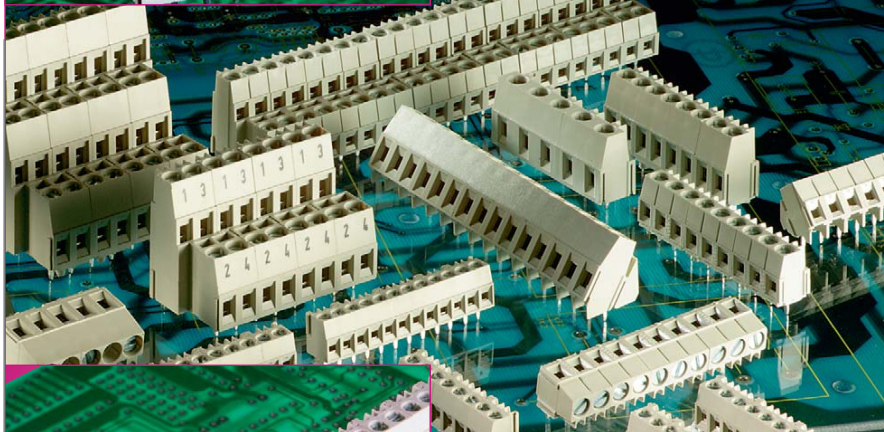
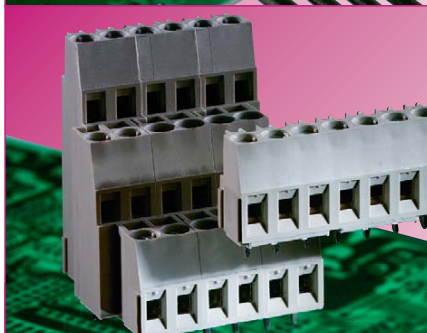

- PC board connector with spring clamp connection

Marking

- smudge-proof inkjet marking directly on the connector
- marking of individual poles with snap-on marking tag
- connectors with or without marking tag carriers
- custom marking possible, consult factory



Abbreviations for plastic materials:

PA 66/6 = Polyamide 66/6
PC = Polycarbonate
PBT = Polybutylenterephthalate

Variety of types

- pole configurations from 2 to 24 poles
- wiring horizontal and vertical to the printed circuit board
- wiring in 45° or 35° angle possible
- in metric spacing:
3.5/5/7.5/10) mm
or inch spacing:
3.81/5.08/7.62/10.16/20.32 mm
- individual connectors snap together
- multi-pole, single housing blocks
- with or without insulating plate
- with or without test fixture
- with or without fixing bolts

Material

Metal parts:

- made from special alloys and/or special surface treatments
- low feed through resistance
- high corrosion resistance
- secure, consistent clamping function

Insulating housings:

- use of high-quality Polyamide 66/6 for its excellent electrical, mechanical and chemical characteristics (for specifics, see individual connectors)

DQS certificates for all product families

- quality standard as per DIN ISO 9001
- in Development, Production, Assembly
- continued control of the quality standards by means of regular internal and external quality audits
- compatible with certificates of other countries:
 - BSI Certificate, Great Britain
 - SQS Certificate, Switzerland
 - Aib-Vincotte Certificate, Belgium
 - ÖQS Certificate, Austria

wiecon

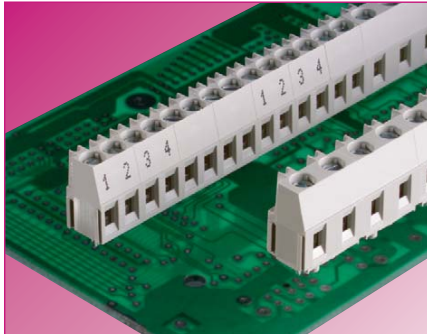

Insulating plate

- covers the clamping body with a plastic plate
- the safety values for air and creepage distances and clearances of the traces of the PC board connector are increased
- fixing bolts on the insulating plate of 2 and 3pole connectors reduce the mechanical stress on the solder joint

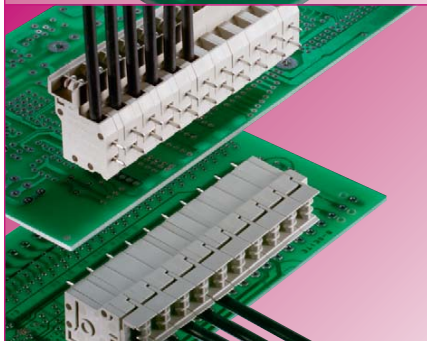

TOP connection

- screw termination in same plane as wire entry
- easy access for the user in narrow spaces
- snap-on marking tag carrier
- double solder tails per pole

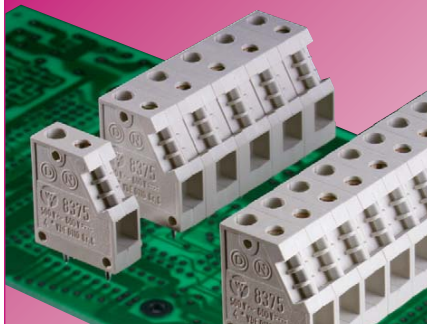

Single pole connectors

- single connectors snap together
- secure, tight locking pins
- the spacing can be expanded by means of spacer plates
- available spacings:
5.00/5.08/6.35/7.50/7.62/10.00/
10.16/20.32 mm
- with end plate
- two solder tails per pole

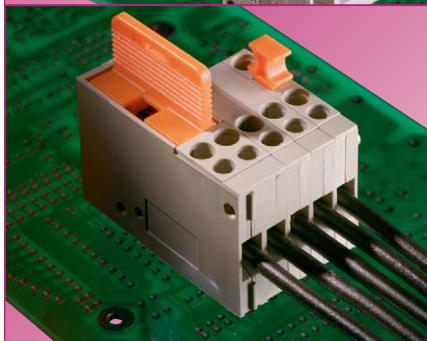

Special-purpose connectors

- snap together individually
- 5.08 mm spacing
- securely fixed to the printed circuit board by double solder tails
- feed through connector
- knife edge disconnect block
- fuse block with G fuse insert and integrated return conductor
- test plug for 2 mm or 3 mm test plug

Note:

The information regarding cross sectional areas and connection types pertains to connections without ferrules.

The indicated rated current corresponds to the maximum load for the PC board with connected wire of the indicated rated cross section.

The rated voltage is indicated as per DIN VDE 0110 part 1 (IEC 60 664-1) – insulation coordination for electrical material in low voltage application – and refers to the delivered state of the PC board connector.

Before the PC board is fitted with connectors, an appropriate PC board must be selected and dimensioned accordingly (e.g. regarding tracking resistance of the lines and solder joints).

Furthermore, the ambient conditions under which the materials shall be used, must be considered.

The indicated rated voltages will be valid for the complete module only if the printed circuit board and PC board connectors are correctly and clearly adjusted to each other.

PC board connectors



PC board connectors

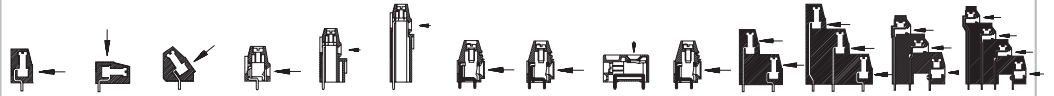

Cross section (fine stranded)	Spacing	Rising cage clamp																							
1 mm ²	3.50	8593 p. 336																							
	3.81	8893 p. 336																							
1.5 mm ²	5.00/ 10.00	8192 p. 338	8192 ZW p. 339	8134 p. 360																8192 E p. 364	8195 D p. 372	8195 V p. 375			
	5.08	8292 p. 338	8292 ZW p. 339	8234 p. 360	8292 H p. 341	8292 EH p. 340	8292 DH p. 340														8292 E p. 364				
	7.50																								
	7.62																								
2.5 mm ²	5.00/ 10.00	8190 p. 358 8191 p. 344	8191 ZW p. 345	8135 p. 362																	8190 E p. 368 8191 E p. 357	8191 D p. 357			
	5.00	8191 R p. 342	8191 p. 344																			8195 D p. 372	8195 V p. 373		
	5.08	8291 R p. 342 8291 p. 357	8291 ZW p. 357	8235 p. 357																		8291 E p. 357	8291 D p. 357		
	7.50	8390 p. 359 8491 p. 346	8391 ZW p. 347																						
	7.62	8491 p. 346	8491 ZW p. 347																						
4 mm ²	6.35																								
	7.50																								
	7.62																								
	10.00																								
10 mm ²	10.16																						7572 L2 p. 376	7572 L4 p. 376	7573 L2/W p. 375
	20.32																								7572 L2 p. 376

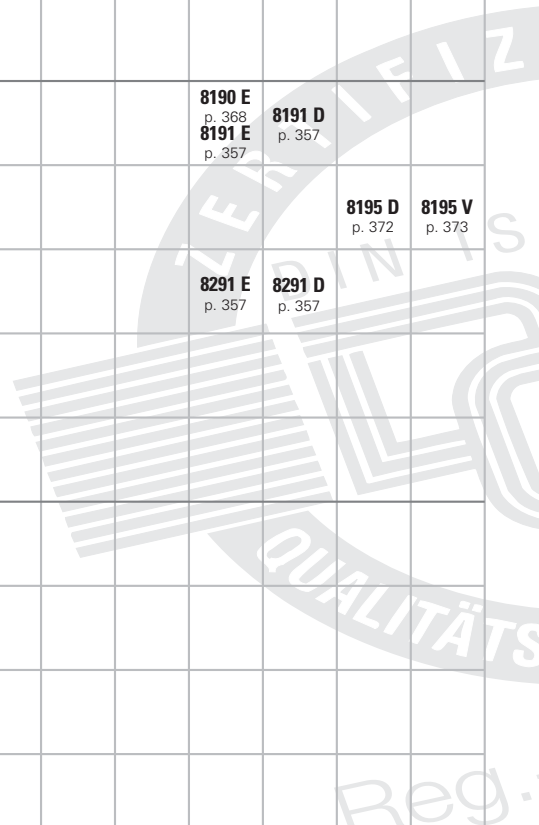

PC board connectors, rising cage clamp system

Spacing: 3.50/3.81 mm

wiecon PCB

Rated cross section:
1.0 mm²

Rated current:
10 A

Connection range:
0.14 – 1.5 mm² solid/
0.14 – 1.0 mm² fine stranded

160 V/2.5 kV/3 – Overvoltage category III
*250 V/2.5 kV/2 – Overvoltage category II
**690 V/2.5 kV/1 – Overvoltage category I

* up to 400 V in overvoltage category I
or expected overvoltage ≤ 3 kV
for L ≥ 2.0 mm and ≤ 2.5 kV für 2.0 mm > L ≥ 1.5 mm

** max. 600 V overvoltage expected
overvoltage ≤ 3 kV for L ≥ 2.0 mm and
≤ 2.5 kV for 2.0 mm > L ≥ 1.5 mm

Rated voltages VDE 0110
UL ratings
CSA ratings
Approvals

without insulating plate

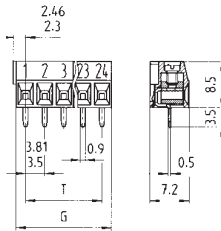

with insulating plate

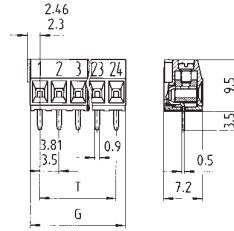

Solder pin 0.5 x 0.9 mm
Bore hole Ø 1.1 mm

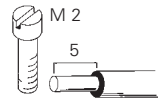

Type 8593/8893

wire horizontal to PC board

No. 30 – 16 AWG 300 V 10 A
No. 30 – 16 AWG 300 V 10 A



Material:
Insulating housing:
PA 66/6 gray, UL 94-V-2
Clamping body: nickel-plated brass
Contact clip with solder pin:
tin-plated bronze
Clamping screw: zinc-plated steel
Brass Nickel-plated
available upon request

Std. pack	L	T	Poles	Part no.	Part no.	Part no.	Part no.
				unmarked without insulating plate	marked without insulating plate	unmarked with insulating plate with fixing bolts	marked with insulating plate with fixing bolts
Spacing: 3.50 mm							
100	7.0	3.5	2	25.195.0253.0	25.194.0253.0	25.195.9253.0	25.194.9253.0
100	10.5	7.0	3	25.195.0353.0	25.194.0353.0	25.195.9353.0	25.194.9353.0
50	14.0	10.5	4	25.195.0453.0	25.194.0453.0		
50	17.5	14.0	5	25.195.0553.0	25.194.0553.0		
50	21.0	17.5	6	25.195.0653.0	25.194.0653.0		
50	24.5	21.0	7	25.195.0753.0	25.194.0753.0		
50	28.0	24.5	8	25.195.0853.0	25.194.0853.0		
50	31.5	28.0	9	25.195.0953.0	25.194.0953.0		
50	35.0	31.5	10	25.195.1053.0	25.194.1053.0		
50	38.5	35.0	11	25.195.1153.0	25.194.1153.0		
50	42.0	38.5	12	25.195.1253.0	25.194.1253.0		
50	45.5	42.0	13	25.195.1353.0	25.194.1353.0		
50	49.0	45.5	14	25.195.1453.0	25.194.1453.0		
50	52.5	49.0	15	25.195.1553.0	25.194.1553.0		
50	56.0	52.5	16	25.195.1653.0	25.194.1653.0		
17 to 24pole upon request							
				unmarked without insulating plate	marked without insulating plate	unmarked with insulating plate with fixing bolts	marked with insulating plate with fixing bolts
Spacing: 3.81 mm							
100	7.62	3.81	2	25.197.0253.0	25.196.0253.0	25.197.9253.0	25.196.9253.0
100	11.43	7.62	3	25.197.0353.0	25.196.0353.0	25.197.9353.0	25.196.9353.0
50	15.24	11.43	4	25.197.0453.0	25.196.0453.0		
50	19.50	15.24	5	25.197.0553.0	25.196.0553.0		
50	22.86	19.05	6	25.197.0653.0	25.196.0653.0		
50	26.67	22.86	7	25.197.0753.0	25.196.0753.0		
50	30.48	26.67	8	25.197.0853.0	25.196.0853.0		
50	34.29	30.48	9	25.197.0953.0	25.196.0953.0		
50	38.10	34.29	10	25.197.1053.0	25.196.1053.0		
50	41.91	38.10	11	25.197.1153.0	25.196.1153.0		
50	45.72	41.91	12	25.197.1253.0	25.196.1253.0		
50	49.53	45.72	13	25.197.1353.0	25.196.1353.0		
50	53.34	49.53	14	25.197.1453.0	25.196.1453.0		
50	57.15	53.34	15	25.197.1553.0	25.196.1553.0		
50	60.96	57.15	16	25.197.1653.0	25.196.1653.0		
17 to 24pole upon request							

wiecon

with insulating plate with fixing bolts

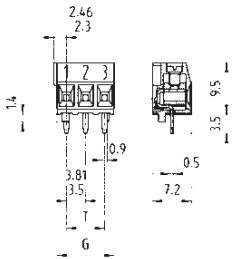

Bore hole plan for version with fixing bolts

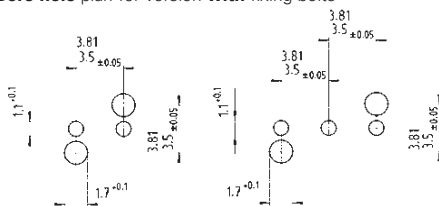

Part no.	Part no.
unmarked with insulating plate without fixing bolts upon request	marked with insulating plate without fixing bolts upon request
unmarked with insulating plate without fixing bolts upon request	marked with insulating plate without fixing bolts upon request



PC board connectors, rising cage clamp system

Spacing: 5.00/5.08 mm

wiecon PCB

Rated cross section:
1.5 mm²

Rated current:
10 A

Connection range:
0.14 – 2.5 mm² solid/
0.14 – 1.5 mm² fine stranded

250 V/4 kV/3 – Overvoltage category III
*690 V/4 kV/2 – Overvoltage category II
1000 V/4 kV/1 – Overvoltage category I

* max. 600 V for ungrounded networks or expected overvoltage ≤ 4 kV

Rated voltages VDE 0110
UL ratings
CSA ratings
Approvals

without insulating plate

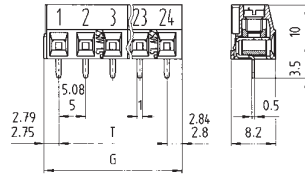

with insulating plate

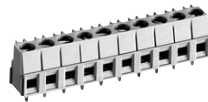
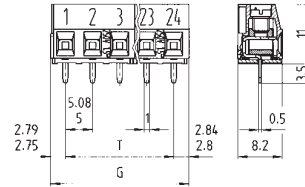

Type 8192/8292

wire horizontal to PC board

No. 30 – 14 AWG
No. 30 – 14 AWG

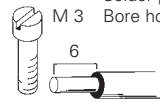

Solder pin 0.5 x 1 mm
M 3 Bore hole Ø 1.2 mm

Material:
Insulating housing:
PA 66/6 gray, UL 94-V0
Clamping body: nickel-plated brass
Contact clip with solder pin:
tin-plated bronze
Clamping screw: zinc-plated steel
Brass Nickel-plated
available upon request

300 V 15/16 A
300 V 15 A

Std. pack	G	T	Poles	Part no.	Part no.	Part no.	Part no.
Spacing: 5.00 mm				unmarked without insulating plate	marked without insulating plate	unmarked with insulating plate with fixing bolts	marked with insulating plate with fixing bolts
100	10.55	5	2	25.191.0253.0	25.190.0253.0	25.191.9253.0	25.190.9253.0
100	15.55	10	3	25.191.0353.0	25.190.0353.0	25.191.9353.0	25.190.9353.0
50	20.55	15	4	25.191.0453.0	25.190.0453.0		
50	25.55	20	5	25.191.0553.0	25.190.0553.0		
50	30.55	25	6	25.191.0653.0	25.190.0653.0		
50	35.55	30	7	25.191.0753.0	25.190.0753.0		
50	40.55	35	8	25.191.0853.0	25.190.0853.0		
50	45.55	40	9	25.191.0953.0	25.190.0953.0		
50	50.55	45	10	25.191.1053.0	25.190.1053.0		
50	55.55	50	11	25.191.1153.0	25.190.1153.0		
50	60.55	55	12	25.191.1253.0	25.190.1253.0		
50	65.55	60	13	25.191.1353.0	25.190.1353.0		
50	70.55	65	14	25.191.1453.0	25.190.1453.0		
50	75.55	70	15	25.191.1553.0	25.190.1553.0		
50	80.55	75	16	25.191.1653.0	25.190.1653.0		
17 to 24pole upon request							
Spacing: 5.08 mm				unmarked without insulating plate	marked without insulating plate	unmarked with insulating plate with fixing bolts	marked with insulating plate with fixing bolts
100	10.71	5.08	2	25.193.0253.0	25.192.0253.0	25.193.9253.0	25.192.9253.0
100	15.79	10.16	3	25.193.0353.0	25.192.0353.0	25.193.9353.0	25.192.9353.0
50	20.87	15.24	4	25.193.0453.0	25.192.0453.0		
50	25.95	20.32	5	25.193.0553.0	25.192.0553.0		
50	31.03	25.40	6	25.193.0653.0	25.192.0653.0		
50	36.11	30.48	7	25.193.0753.0	25.192.0753.0		
50	41.19	35.56	8	25.193.0853.0	25.192.0853.0		
50	46.27	40.64	9	25.193.0953.0	25.192.0953.0		
50	51.35	45.72	10	25.193.1053.0	25.192.1053.0		
50	56.43	50.80	11	25.193.1153.0	25.192.1153.0		
50	61.51	55.88	12	25.193.1253.0	25.192.1253.0		
50	66.59	60.96	13	25.193.1353.0	25.192.1353.0		
50	71.67	66.04	14	25.193.1453.0	25.192.1453.0		
50	76.75	71.12	15	25.193.1553.0	25.192.1553.0		
50	81.83	76.20	16	25.193.1653.0	25.192.1653.0		
17 to 24pole upon request							

wiecon

with insulating plate with fixing bolts

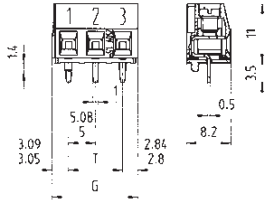

with insulating plate horizontal

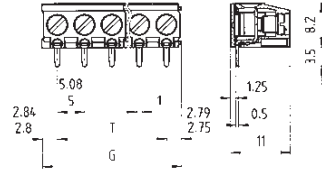

Bore hole plan for version with fixing bolts

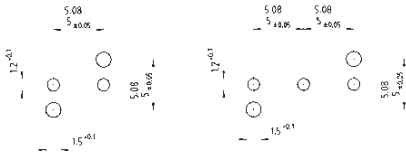

Solder pin 0.5 x 1 mm
Bore hole Ø 1.2 mm

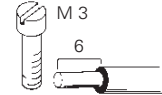
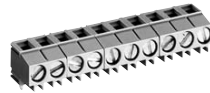

Type 8192 ZW/8292 ZW

Wire vertical to PC board

No. 30 – 14 AWG

300 V 15/16 A

No. 30 – 14 AWG

300 V 15 A



Part no.	Part no.	Part no.	Part no.
unmarked with insulating plate without fixing bolts	marked with insulating plate without fixing bolts	unmarked with insulating plate horizontal	marked with insulating plate horizontal
upon request	upon request	25.191.6253.0 25.191.6353.0 25.191.6453.0	upon request
		25.191.6553.0 25.191.6653.0 25.191.6753.0	
		25.191.6853.0 25.191.6953.0 25.191.7053.0	
		25.191.7153.0 25.191.7253.0 25.191.7353.0	
		25.191.7453.0 25.191.7553.0 25.191.7653.0	
unmarked with insulating plate without fixing bolts	marked with insulating plate without fixing bolts	unmarked with insulating plate horizontal	marked with insulating plate horizontal
upon request	upon request	25.193.6253.0 25.193.6353.0 25.193.6453.0	upon request
		25.193.6553.0 25.193.6653.0 25.193.6753.0	
		25.193.6853.0 25.193.6953.0 25.193.7053.0	
		25.193.7153.0 25.193.7253.0 25.193.7353.0	
		25.193.7453.0 25.193.7553.0 25.193.7653.0	

wiecon

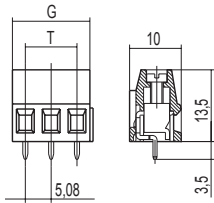

Solder pin 0.8 x 1 mm
Bore hole Ø 1.3 mm

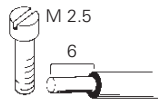

Type 8292 H

No. 24 – 14 AWG
No. 24 – 14 AWG

300 V 10 A
300 V 10 A



Part no.	Part no.
unmarked	
27.000.0253.0	
27.000.0353.0	



PC board connectors, rising cage clamp system

Spacing: 5.00/5.08 mm

wiecon PCB

Rated cross section:
2.5 mm²

Rated current:
16 A

Connection range:
0.14 – 4.0 mm² solid/
0.14 – 2.5 mm² fine stranded

250 V/4 kV/3 – Overvoltage category III
*690 V/4 kV/2 – Overvoltage category II
1000 V/4 kV/1 – Overvoltage category I

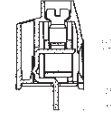
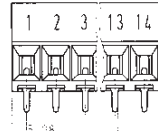

Material:
Insulating housing:
PA 66/6 gray, UL 94-V0
Clamping body: nickel-plated brass
Contact clip with solder pin:
tin-plated E copper
Clamping screw: zinc-plated steel

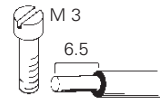
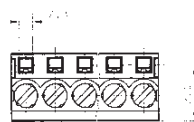

Solder pin 1 x 0.8 mm
Bore hole Ø 1.3 mm

Upon request also with Philips screw

* max. 600 V for ungrounded networks or expected overvoltage ≤ 4 kV

Type 81 – 8291 R

wire horizontal to PC board
(with integrated test point)

No. 22 – 12 AWG
No. 22 – 12 AWG

300 V 20/30 A
300 V 25 A



Rated voltages VDE 0110
UL ratings
CSA ratings
Approvals

Std. pack	G	T	Poles	Part no.	Part no.
Spacing: 5.00 mm				unmarked with insulating plate	marked with insulating plate
Type 8191 R					
500	10.85	5	2	25.155.0253.0	25.155.2253.0
500	15.85	10	3	25.155.0353.0	25.155.2353.0
250	20.85	15	4	25.155.0453.0	25.155.2453.0
250	25.85	20	5	25.155.0553.0	25.155.2553.0
200	30.85	25	6	25.155.0653.0	25.155.2653.0
200	35.85	30	7	25.155.0753.0	25.155.2753.0
100	40.85	35	8	25.155.0853.0	25.155.2853.0
100	45.85	40	9	25.155.0953.0	25.155.2953.0
100	50.85	45	10	25.155.1053.0	25.155.3053.0
50	55.85	50	11	25.155.1153.0	25.155.3153.0
50	60.85	55	12	25.155.1253.0	25.155.3253.0
50	66.85	60	13	25.155.1353.0	25.155.3353.0
50	70.85	65	14	25.155.1453.0	25.155.3453.0
Spacing: 5.08 mm				unmarked with insulating plate	marked with insulating plate
Type 8291 R					
500	11.01	5.08	2	25.156.0253.0	25.156.2253.0
500	16.09	10.16	3	25.156.0353.0	25.156.2353.0
250	21.17	15.24	4	25.156.0453.0	25.156.2453.0
250	26.25	20.32	5	25.156.0553.0	25.156.2553.0
200	31.33	25.40	6	25.156.0653.0	25.156.2653.0
200	36.41	30.48	7	25.156.0753.0	25.156.2753.0
100	41.49	35.56	8	25.156.0853.0	25.156.2853.0
100	46.57	40.64	9	25.156.0953.0	25.156.2953.0
100	51.56	45.72	10	25.156.1053.0	25.156.3053.0
50	56.73	50.80	11	25.156.1153.0	25.156.3153.0
50	61.81	55.88	12	25.156.1253.0	25.156.3253.0
50	66.89	60.96	13	25.156.1353.0	25.156.3353.0
50	71.97	66.04	14	25.156.1453.0	25.156.3453.0

PC board connectors, rising cage clamp system

Spacing: 10.00/10.16 mm

Rated cross section:
2.5 mm²

Rated current:
16 A

Connection range:
0.14 – 4.0 mm² solid/
0.14 – 2.5 mm² fine stranded

690 V/8 kV/3 – Overvoltage category III
1000 V/8 kV/2 – Overvoltage category II
1000 V/8 kV/1 – Overvoltage category I

Rated voltages VDE 0110
UL ratings
CSA ratings
Approvals

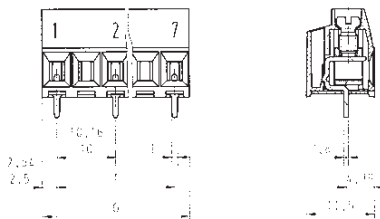

Material:
Insulating housing:
PA 66/6 gray, UL 94-V0
Clamping body: nickel-plated brass
Contact clip with solder pin:
tin-plated E copper
Clamping screw: zinc-plated steel

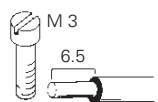
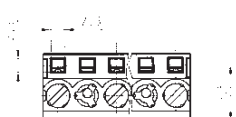

Solder pin 1 x 0.8 mm
Bore hole Ø 1.3 mm
Upon request also with Philips screw

Type 81 – 8291 R

wire horizontal to PC board
(with integrated test point, every second pole fitted)

No. 22 – 12 AWG 600 V 20/30 A
No. 22 – 12 AWG 600 V 25 A



Std. pack	G	T	Poles	Part no.	Part no.
Spacing: 10.00 mm Type 8191 R				unmarked with insulating plate	marked with insulating plate
500	15	10	2	25.157.0253.0	25.157.1253.0
250	25	20	3	25.157.0353.0	25.157.1353.0
200	35	30	4	25.157.0453.0	25.157.1453.0
100	45	40	5	25.157.0553.0	25.157.1553.0
50	55	50	6	25.157.0653.0	25.157.1653.0
50	65	60	7	25.157.0753.0	25.157.1753.0
Spacing: 10.16 mm Type 8291 R				unmarked with insulating plate	marked with insulating plate
500	15.24	10.16	2	25.157.4253.0	25.157.5253.0
250	25.40	20.32	3	25.157.4353.0	25.157.5353.0
200	35.56	30.48	4	25.157.4453.0	25.157.5453.0
100	45.72	40.64	5	25.157.4553.0	25.157.5553.0
50	55.88	50.80	6	25.157.4653.0	25.157.5653.0
50	66.04	60.96	7	25.157.4753.0	25.157.5753.0



PC board connectors, rising cage clamp system

Spacing: 5.00/5.08/10.00 mm

wiecon PCB

Rated cross section:
2.5 mm²

Rated current:
16 A

Connection range:
0.14 – 4.0 mm² solid/
0.14 – 2.5 mm² fine stranded

Rated voltages:
Spacing: 5.00/5.08 mm VDE 0110
250 V/4 kV/3 – Overvoltage category III
*690 V/4 kV/2 – Overvoltage category II
1000 V/4 kV/1 – Overvoltage category I

Rated voltages:
Spacing: 10.00 mm VDE 0110
690 V/8 kV/3 – Overvoltage category III
1000 V/8 kV/2 – Overvoltage category II
1000 V/8 kV/1 – Overvoltage category I

* max. 600 V for ungrounded networks or expected overvoltage ≤ 4 kV

Rated voltages VDE 0110
UL ratings field/factory wiring
CSA ratings
Approvals

Spacing: 5.00/5.08 mm, without insulating plate

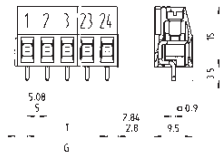

with insulating plate, without fixing bolts

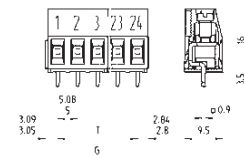

Spacing: 10.00 mm, without insulating plate

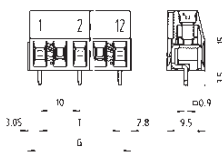

with insulating plate, without fixing bolts

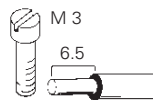
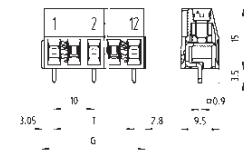

Solder pin 0.9 x 0.9 mm
Bore hole Ø 1.3 mm

Type 8191/8291

wire horizontal to PC board
(with exposed test point)

No. 22 – 12 AWG 300 V 20/30 A
No. 22 – 12 AWG 300 V 25 A



Std. pack	G	T	Poles	Part no.	Part no.	Part no.	Part no.	
				unmarked without insulating plate	marked without insulating plate	unmarked with insulating plate with fixing bolts	marked with insulating plate with fixing bolts	
Spacing: 5.00 mm								
100	10.85	5	2	25.161.0253.0	25.160.0253.0	25.171.0253.0	25.170.0253.0	
100	15.85	10	3	25.161.0353.0	25.160.0353.0	25.171.0353.0	25.170.0353.0	
50	20.85	15	4	25.161.0453.0	25.160.0453.0			
50	25.85	20	5	25.161.0553.0	25.160.0553.0			
50	30.85	25	6	25.161.0653.0	25.160.0653.0			
50	35.85	30	7	25.161.0753.0	25.160.0753.0			
50	40.85	35	8	25.161.0853.0	25.160.0853.0			
50	45.85	40	9	25.161.0953.0	25.160.0953.0			
50	50.85	45	10	25.161.1053.0	25.160.1053.0			
50	55.85	50	11	25.161.1153.0	25.160.1153.0			
50	60.85	55	12	25.161.1253.0	25.160.1253.0			
50	65.85	60	13	25.161.1353.0	25.160.1353.0			
50	70.85	65	14	25.161.1453.0	25.160.1453.0			
50	75.85	70	15	25.161.1553.0	25.160.1553.0			
50	80.85	75	16	25.161.1653.0	25.160.1653.0			
17 to 24pole upon request								
Spacing: 5.08 mm								
100	11.01	5.08	2	25.163.0253.0		25.173.0253.0	25.172.0253.0	
100	16.09	10.16	3	25.163.0353.0		25.173.0353.0	25.172.0353.0	
50	21.17	15.24	4	25.163.0453.0				
50	26.25	20.32	5	25.163.0553.0				
50	31.33	25.40	6	25.163.0653.0				
50	36.41	30.48	7	25.163.0753.0				
50	41.49	35.56	8	25.163.0853.0				
50	46.57	40.64	9	25.163.0953.0				
50	51.65	45.72	10	25.163.1053.0				
50	56.73	50.80	11	25.163.1153.0				
50	61.81	55.88	12	25.163.1253.0				
50	66.89	60.96	13	25.163.1353.0				
50	71.97	66.04	14	25.163.1453.0				
50	77.05	71.12	15	25.163.1553.0				
50	82.13	76.20	16	25.163.1653.0				
17 to 24pole upon request								
Spacing: 10.00 mm								
100	15.85	10	2	25.169.0253.0	25.168.0253.0	25.169.6253.0	25.168.6253.0	
4 to 12pole upon requ.	50	25.85	20	3	25.169.0353.0	25.168.0353.0	25.169.6353.0	25.168.6353.0

wiecon

with insulating plate with fixing bolts

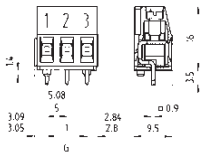

with insulating plate with fixing bolts

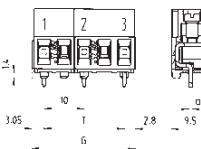

with insulating plate horizontal 5.00/5.08 mm

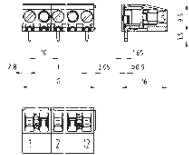

with insulating plate horizontal 10.00 mm

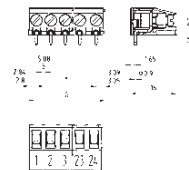

Bore hole plan for version with fixing bolts, spacing: 5.00/5.08 mm

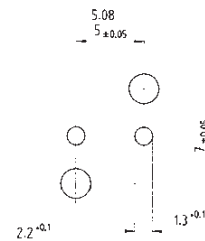

Solder pin 0.9 x 0.9 mm
Bore hole Ø 1.3 mm

Material:
Insulating housing:
PA 66/6 gray, UL 94-V0
Clamping body: nickel-plated brass
Contact clip with solder pin:
tin-plated E copper
Clamping screw: zinc-plated steel
Brass Nickel-plated
available upon request

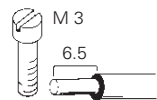
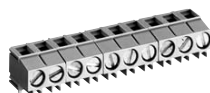

Type 8191 ZW/8291 ZW
wire vertical to PC board

No. 22 – 12 AWG 300 V 20/30 A
No. 22 – 12 AWG 300 V 25 A

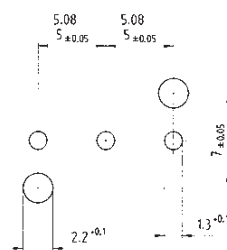

Bore hole plan for version with fixing bolts, spacing: 10.00 mm

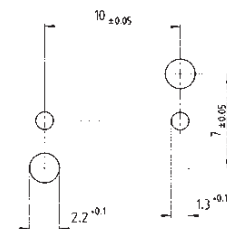
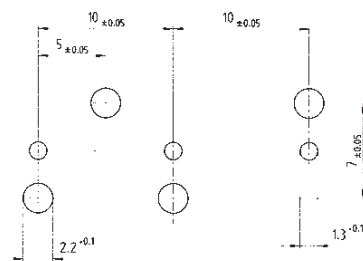

Part no.	Part no.	Part no.	Part no.
unmarked with insulating plate without fixing bolts	marked with insulating plate without fixing bolts	unmarked with insulating plate horizontal	marked with insulating plate horizontal
upon request	upon request	25.161.6253.0 25.161.6353.0 25.161.6453.0	25.160.6253.0 25.160.6353.0 25.160.6453.0
		25.161.6553.0 25.161.6653.0 25.161.6753.0	25.160.6553.0 25.160.6653.0 25.160.6753.0
		25.161.6853.0 25.161.6953.0 25.161.7053.0	25.160.6853.0 25.160.6953.0 25.160.7053.0
		25.161.7153.0 25.161.7253.0 25.161.7353.0	25.160.7153.0 25.160.7253.0 25.160.7353.0
		25.161.7453.0 25.161.7553.0 25.161.7653.0	25.160.7453.0 25.160.7553.0 25.160.7653.0
upon request	upon request	25.163.6253.0 25.163.6353.0 25.163.6453.0	25.162.6253.0 25.162.6353.0 25.162.6453.0
		25.163.6553.0 25.163.6653.0 25.163.6753.0	25.162.6553.0 25.162.6653.0 25.162.6753.0
		25.163.6853.0 25.163.6953.0 25.163.7053.0	25.162.6853.0 25.162.6953.0 25.162.7053.0
		25.163.7153.0 25.163.7253.0 25.163.7353.0	25.162.7153.0 25.162.7253.0 25.162.7353.0
		25.163.7453.0 25.163.7553.0 25.163.7653.0	25.162.7453.0 25.162.7553.0 25.162.7653.0
25.169.2253.0 25.169.2353.0	25.168.2253.0 25.168.2353.0	25.169.4253.0 25.169.4353.0	25.168.4253.0 25.168.4353.0



PC board connectors, rising cage clamp system

Spacing: 7.50/7.62 mm

wiecon PCB

Rated cross section:
2.5 mm²

Rated current:
16 A

Connection range:
0.14 – 4.0 mm² solid/
0.14 – 2.5 mm² fine stranded

400 V/6 kV/3 – Overvoltage category III
1000 V/6 kV/2 – Overvoltage category II
1000 V/6 kV/1 – Overvoltage category I

without insulating plate

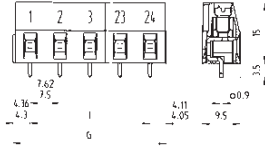

with insulating plate, without fixing bolts

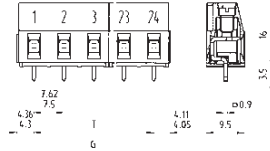

Type 8391/8491

wire horizontal to PC board

No. 22 – 12 AWG
No. 22 – 12 AWG

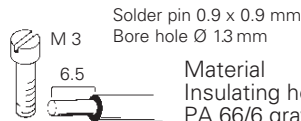

Solder pin 0.9 x 0.9 mm
Bore hole Ø 1.3 mm

Material
Insulating housing:
PA 66/6 gray, UL 94-V0
Clamping body: nickel-plated brass
Contact clip with solder pin:
tin-plated E copper
Clamping screw: zinc-plated steel
Brass Nickel-plated
available upon request

Rated voltages VDE 0110
UL ratings
CSA ratings
Approvals



Std. pack	G	T	Poles	Part no.	Part no.	Part no.	Part no.
Spacing: 7.50 mm				unmarked without insulating plate	unmarked with insulating plate without fixing bolts	unmarked with insulating plate with fixing bolts	marked without insulating plate
100	15.85	7.5	2	25.165.0253.0	25.165.3253.0	25.175.0253.0	25.164.0253.0
100	23.35	15.0	3	25.165.0353.0	25.165.3353.0	25.175.0353.0	25.164.0353.0
4 to 24pole upon request							
Spacing: 7.62 mm				unmarked without insulating plate	unmarked with insulating plate without fixing bolts	unmarked with insulating plate with fixing bolts	marked without insulating plate
100	16.09	7.62	2	25.167.0253.0	25.167.3253.0	25.177.0253.0	25.166.0253.0
100	23.71	15.24	3	25.167.0353.0	25.167.3353.0	25.177.0353.0	25.166.0353.0
4 to 24pole upon request							

wiecon PCB

Rated cross section:
1.5 mm²

Rated current:
16 A

(related to an ambient temperature of 20 °C,
the rated cross section and max. number of poles)

Connection range:
0.50 – 2.5 mm² solid/
0.50 – 1.5 mm² fine stranded

250 V/4 kV/3 – Overvoltage category III

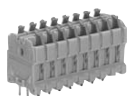
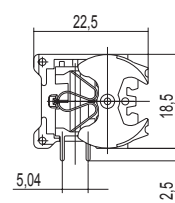
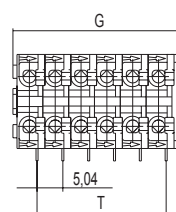
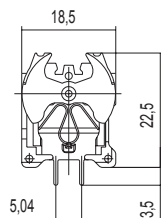
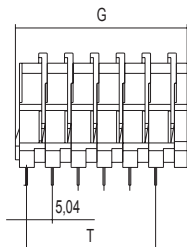

Solder pin 0.8 x 0.4 mm
Bore hole Ø 1.3 mm



Solder pin 0.8 x 0.4 mm
Bore hole Ø 1.3 mm

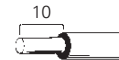
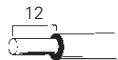

Type 8152 TOP V

Type 8152 TOP H

Rated voltages VDE 0110
UL ratings
CSA ratings
Approvals

field wiring

No. 26 – 14 AWG
No. 22 – 14 AWG

300 V 10 A
300 V 10 A

No. 26 – 14 AWG
No. 22 – 14 AWG

300 V 10 A
300 V 10 A



Std. pack	G	T	Poles	Part no.	Part no.
Spacing: 5.00 mm					
100	8.34	5.04	1	27.720.0153.0	27.730.0153.0
100	13.38	10.08	2	27.720.0253.0	27.730.0253.0
100	18.42	15.12	3	27.720.0353.0	27.730.0353.0
50	23.46	20.16	4	27.720.0453.0	27.730.0453.0
50	28.50	25.20	5	27.720.0553.0	27.730.0553.0
50	33.54	30.24	6	27.720.0653.0	27.730.0653.0
50	38.58	35.28	7	27.720.0753.0	27.730.0753.0
50	43.62	40.32	8	27.720.0853.0	27.730.0853.0
50	48.66	45.30	9	27.720.0953.0	27.730.0953.0
50	53.70	50.40	10	27.720.1053.0	27.730.1053.0

PC board connectors, TOP connection

Spacing: 5.00/5.08 mm

Rated cross section:
2.5 mm²

Rated current:
16 A

Connection range:
0.14 – 4.0 mm² solid/
0.14 – 2.5 mm² fine stranded

250 V/4 kV/3 – Overvoltage category III
*690 V/4 kV/2 – Overvoltage category II
1000 V/4 kV/1 – Overvoltage category I

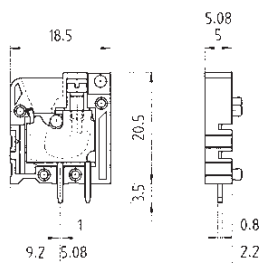

Material
Insulating housing:
PA 66/6 gray, UL 94-V0
Clamping body: zinc-plated steel
Contact clip with solder pin:
tin-plated E copper
Clamping piece: zinc-plated steel
Clamping screw: zinc-plated steel

* max. 600 V for ungrounded networks or expected overvoltage ≤ 4 kV

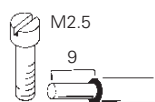

Solder pin 0.8 x 1.0 mm
Bore hole Ø 1.3 mm

Rated voltages VDE 0110
UL ratings field/factory wiring
CSA ratings
Approvals

Type 8185 TOP V

wire vertical to PC board
No. 22/30 – 12 AWG 300 V 20/25 A
No. 22 – 12 AWG 300 V 20 A



Type 8285 TOP V

No. 22/30 – 12 AWG 300 V 20/25 A
No. 22 – 12 AWG 300 V 20 A



Connector assemblies	Spacing: 5.00 mm			Spacing: 5.08 mm			
	Type	Part no.	Std. pack	Type	Part no.	Std. pack	
2-pole	8185 TOP V	25.741.0253.0	100	8285 TOP V	25.751.0253.0	100	
3-pole	8185 TOP V	25.741.0353.0	100	8285 TOP V	25.751.0353.0	100	
4-pole	8185 TOP V	25.741.0453.0	50	8285 TOP V	25.751.0453.0	50	
5-pole	8185 TOP V	25.741.0553.0	50	8285 TOP V	25.751.0553.0	50	
6-pole	8185 TOP V	25.741.0653.0	50	8285 TOP V	25.751.0653.0	50	
7-pole	8185 TOP V	25.741.0753.0	50	8285 TOP V	25.751.0753.0	50	
8-pole	8185 TOP V	25.741.0853.0	50	8285 TOP V	25.751.0853.0	50	
9-pole	8185 TOP V	25.741.0953.0	50	8285 TOP V	25.751.0953.0	50	
10-pole	8185 TOP V	25.741.1053.0	50	8285 TOP V	25.751.1053.0	50	
11-pole	8185 TOP V	25.741.1153.0	50	8285 TOP V	25.751.1153.0	50	
12-pole	8185 TOP V	25.741.1253.0	50	8285 TOP V	25.751.1253.0	50	
13-pole	8185 TOP V	25.741.1353.0	50	8285 TOP V	25.751.1353.0	50	
14-pole	8185 TOP V	25.741.1453.0	50	8285 TOP V	25.751.1453.0	50	
15-pole	8185 TOP V	25.741.1553.0	50	8285 TOP V	25.751.1553.0	50	
16-pole	8185 TOP V	25.741.1653.0	50	8285 TOP V	25.751.1653.0	50	
Single poles, snap together							
Spacings: 5.00 and 5.08 mm	1pole	8185 TOP V	25.741.0053.0	100	8285 TOP V	25.751.0053.0	100
End plate		AP 8385 TOP N	07.300.4753.0	50	AP 8385 TOP N	07.300.4753.0	50
Marking tag carrier, snap-on	1pole		04.242.4253.0	100		04.242.4253.0	100
Marking tag carrier, snap-on, for group marking, 5.00 mm wide		BZ 8185 TOP N	04.242.5853.0	50			
Marking tag strips	unmarked	9705 A/5/10	04.242.5053.0	25			
	¹⁾ marked	9705 A/5/10 B	04.842.5053.0	25			
Tear-off marking strip	marked 1, 2, 3 ... 0	9704 A/1-0 B	04.841.2150.0	25			
Single tag	unmarked	9705 A	04.242.0800.0				
	¹⁾ marked	9705 AB	04.842.0850.0	500			
Adhesive marking tag strip	1 – 12 (100 x)		04.007.4089.0	1			
	13 – 24 (100 x)		04.007.4189.0	1			
¹⁾ Marking upon request							



PC board connector, TOP system

Spacing: 5.00/5.08 mm

wiecon PCB

Rated cross section:
2.5 mm²

Rated current:
16 A

Connection range:
0.14 – 4.0 mm² solid/
0.14 – 2.5 mm² fine stranded

250 V/4 kV/3 – Overvoltage category III
*690 V/4 kV/2 – Overvoltage category II
1000 V/4 kV/1 – Overvoltage category I

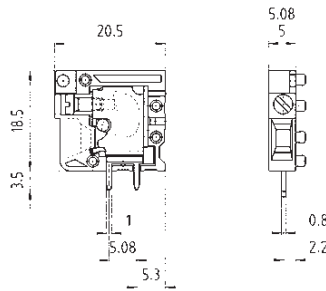

Material
Insulating housing:
PA 66/6 gray, UL 94-V0
Clamping body: zinc-plated steel
Contact clip with solder pin:
tin-plated E copper
Clamping piece: zinc-plated steel
Clamping screw: zinc-plated steel

* max. 600 V for ungrounded networks or expected overvoltage ≤ 4 kV

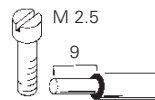

Solder pin 0.8 x 1.0 mm
Bore hole Ø 1.3 mm

Rated voltages VDE 0110
UL ratings
CSA ratings
Approvals

field/factory wiring

Type 8185 TOP H

wire horizontal to PC board

No. 22/30 – 12 AWG 300 V 20/25 A

No. 22 – 12 AWG 300 V 20 A



Type 8285 TOP H

No. 22/30 – 12 AWG 300 V 20/25 A

No. 22 – 12 AWG 300 V 20 A



Connector assemblies				Connector assemblies			
Type	Part no.	Std. pack	Spacing: 5.00 mm	Type	Part no.	Std. pack	Spacing: 5.08 mm
2-pole	8185 TOP H	25.741.3253.0	100	8285 TOP H	25.751.3253.0	100	
3-pole	8185 TOP H	25.741.3353.0	100	8285 TOP H	25.751.3353.0	100	
4-pole	8185 TOP H	25.741.3453.0	50	8285 TOP H	25.751.3453.0	50	
5-pole	8185 TOP H	25.741.3553.0	50	8285 TOP H	25.751.3553.0	50	
6-pole	8185 TOP H	25.741.3653.0	50	8285 TOP H	25.751.3653.0	50	
7-pole	8185 TOP H	25.741.3753.0	50	8285 TOP H	25.751.3753.0	50	
8-pole	8185 TOP H	25.741.3853.0	50	8285 TOP H	25.751.3853.0	50	
9-pole	8185 TOP H	25.741.3953.0	50	8285 TOP H	25.751.3953.0	50	
10-pole	8185 TOP H	25.741.4053.0	50	8285 TOP H	25.751.4053.0	50	
11-pole	8185 TOP H	25.741.4153.0	50	8285 TOP H	25.751.4153.0	50	
12-pole	8185 TOP H	25.741.4253.0	50	8285 TOP H	25.751.4253.0	50	
13-pole	8185 TOP H	25.741.4353.0	50	8285 TOP H	25.751.4353.0	50	
14-pole	8185 TOP H	25.741.4453.0	50	8285 TOP H	25.751.4453.0	50	
15-pole	8185 TOP H	25.741.4553.0	50	8285 TOP H	25.751.4553.0	50	
16-pole	8185 TOP H	25.741.4653.0	50	8285 TOP H	25.751.4653.0	50	
Single poles, snap together							
Spacings: 5.00 and 5.08 mm	1pole	8185 TOP H	25.741.0153.0	100	8285 TOP H	25.751.0153.0	100
End plate		AP 8385 TOP N	07.300.4753.0	50	AP 8385 TOP N	07.300.4753.0	50
Marking tag carrier, snap-on	1pole		04.242.4253.0	100		04.242.4253.0	100
Marking tag carrier, snap-on, for group marking, 5.00 mm wide		BZ 8185 TOP N	04.242.5853.0	50			
Marking tag strip	unmarked	9705 A/5/10	04.242.5053.0	25			
	¹⁾ marked	9705 A/5/10 B	04.842.5053.0	25			
Tear-off marking strip	marked 1, 2, 3 ... 0	9704 A/1-0 B	04.841.2150.0	25			
Single tag	unmarked	9705 A	04.242.0850.0	500			
	¹⁾ marked	9705 AB	04.842.0850.0	500			
Adhesive marking tag strip	1 – 12 (100 x)		04.007.4089.0	1			
	13 – 24 (100 x)		04.007.4189.0	1			
¹⁾ Marking upon request							

PC board connector, TOP connection

Spacing: 7.50/7.62 mm

Rated cross section:
2.5 mm²

Rated current:
16 A

Connection range:
0.14 – 4.0 mm² solid/
0.14 – 2.5 mm² fine stranded

400 V/6 kV/3 – Overvoltage category III
1000 V/6 kV/2 – Overvoltage category II
1000 V/6 kV/1 – Overvoltage category I

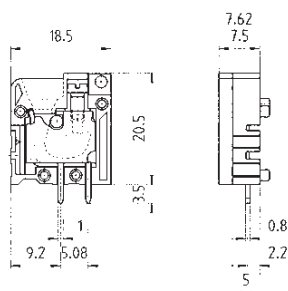

Material
Insulating housing:
PA 66/6 gray, UL 94-V0
Clamping body: zinc-plated steel
Contact clip with solder pin:
tin-plated E copper
Clamping piece: zinc-plated steel
Clamping screw: zinc-plated steel

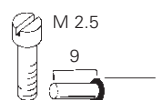
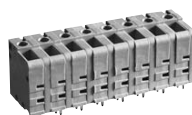

Solder pin 0.8 x 1.0 mm
Bore hole Ø 0.3 mm

Rated voltages VDE 0110
UL ratings
CSA ratings
Approvals

field/factory wiring

Type 8385 TOP V

wire vertical to PC board

No. 22/30 – 12 AWG
No. 22 – 12 AWG



300 V 20/25 A
300 V 20 A

Type 8485 TOP V

No. 22/30 – 12 AWG
No. 22 – 12 AWG



300 V 20/25 A
300 V 20 A

Connector assemblies	Type	Part no.	Std. pack	Type	Part no.	Std. pack
			Spacing: 7.50 mm		Spacing: 7.62 mm	
2-pole	8385 TOP V	25.761.0253.0	100	8485 TOP V	25.771.0253.0	100
3-pole	8385 TOP V	25.761.0353.0	100	8485 TOP V	25.771.0353.0	100
4-pole	8385 TOP V	25.761.0453.0	50	8485 TOP V	25.771.0453.0	50
5-pole	8385 TOP V	25.761.0553.0	50	8485 TOP V	25.771.0553.0	50
6-pole	8385 TOP V	25.761.0653.0	50	8485 TOP V	25.771.0653.0	50
7-pole	8385 TOP V	25.761.0753.0	50	8485 TOP V	25.771.0753.0	50
8-pole	8385 TOP V	25.761.0853.0	50	8485 TOP V	25.771.0853.0	50
Pre-assembled pole configurations upon request						
Single poles, snap together						
Spacings: 7.50 and 7.62 mm						
8385 TOP V 25.761.0053.0 100 8485 TOP V 25.771.0053.0 100						
End plate AP 8385 TOP N 07.300.4753.0 50 AP 8385 TOP N 07.300.4753.0 50						
Marking tag carrier, snap-on 04.242.4253.0 100 04.242.4253.0 100						
Marking tag carrier, snap-on, for group marking, 5.00 mm wide						
BZ 8185 TOP N 04.242.5853.0 50						
Marking tag strips						
9705 A/7,5/10 04.242.7553.0 25						
9705 A/7,5/10 B 04.842.7553.0 25						
Tear-off marking strips						
9704 A/1-0 B 04.841.2150.0 25						
Single tags						
9705 A 04.242.0850.0 500						
9705 AB 04.842.0850.0 500						
1) Marking upon request						



PC board connector, TOP connection

Spacing: 7.50/7.62 mm

wiecon PCB

Rated cross section:
2.5 mm²

Rated current:
16 A

Connection range:
0.14 – 4.0 mm² solid/
0.14 – 2.5 mm² fine stranded

400 V/6 kV/3 – Overvoltage category III
1000 V/6 kV/2 – Overvoltage category II
1000 V/6 kV/1 – Overvoltage category I

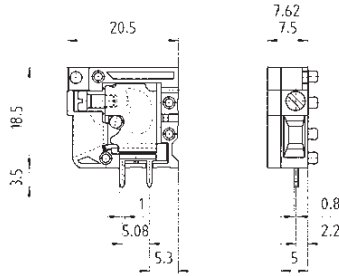

Material
Insulating housing:
PA 66/6 gray, UL 94-V0
Clamping body: zinc-plated steel
Contact clip with solder pin:
tin-plated E copper
Clamping piece: zinc-plated steel
Clamping screw: zinc-plated steel

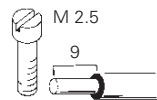

Solder pin 0.8 x 1.0 mm
Bore hole Ø 1.3 mm

Rated voltages VDE 0110
UL ratings
CSA ratings
Approvals

field/factory wiring

Type 8385 TOP H
wire horizontal to PC board
No. 22/30 – 12 AWG
No. 22 – 12 AWG

300 V 20/25 A
300 V 20 A



Type 8485 TOP H

No. 22/30 – 12 AWG 300 V 20/25 A
No. 22 – 12 AWG 300 V 20 A



Connector assemblies				Connector assemblies			
Type	Part no.	Std. pack	Spacing: 7.50 mm	Type	Part no.	Std. pack	Spacing: 7.62 mm
2pole	8385 TOP H	25.761.3253.0	100	8485 TOP H	25.771.3253.0	100	
3pole	8385 TOP H	25.761.3353.0	100	8485 TOP H	25.771.3353.0	100	
4pole	8385 TOP H	25.761.3453.0	50	8485 TOP H	25.771.3453.0	50	
5pole	8385 TOP H	25.761.3553.0	50	8485 TOP H	25.771.3553.0	50	
6pole	8385 TOP H	25.761.3653.0	50	8485 TOP H	25.771.3653.0	50	
7pole	8385 TOP H	25.761.3753.0	50	8485 TOP H	25.771.3753.0	50	
8pole	8385 TOP H	25.761.3853.0	50	8485 TOP H	25.771.3853.0	50	
Pre-assembled pole configurations upon request							
Single poles, snap together							
Spacings: 7.50 und 7.62 mm	1pole	8385 TOP H	25.761.0153.0	100	8485 TOP H	25.771.0153.0	100
End plate		AP 8385 TOP N	07.300.4753.0	50	AP 8385 TOP N	07.300.4753.0	50
Marking tag carrier, snap-on	1pole		04.242.4253.0	100		04.242.4253.0	100
Marking tag carrier, snap-on, for group marking, 5.00 mm wide		BZ 8185 TOP N	04.242.5853.0	50			
Marking tag strips	unmarked	9705 A/7,5/10	04.242.7553.0	25			
	¹⁾ marked	9705 A/7,5/10 B	04.842.7553.0	25			
Tear-off marking strip	marked 1, 2, 3 ... 0	9704 A/1-0 B	04.841.2150.0	25			
Single tags	unmarked	9705 A	04.242.0850.0	500			
	¹⁾ marked	9705 AB	04.842.0850.0	500			
¹⁾ Marking upon request							

PC board connector, spring clamp connection

Spacing: 5.00/5.08 mm

Rated cross section:
2.5 mm²

Rated current:
16 A

Connection range:
0.14 – 4.0 mm² solid/
0.14 – 2.5 mm² fine stranded

250 V/4 kV/3 – Overvoltage category III
*690 V/4 kV/2 – Overvoltage category II
1000 V/4 kV/1 – Overvoltage category I

Material:
Insulating housing: PA 66/6 gray, UL 94-V-0
Clamping body: spring clamp
Contact clips with solder pin:
tin-plated E copper

* max. 600 V for ungrounded networks or expected
overvoltage ≤ 4 kV

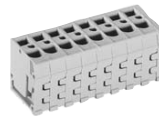
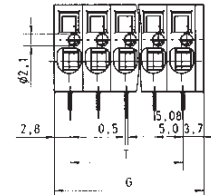
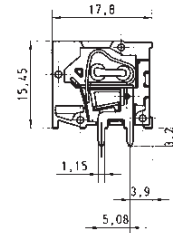
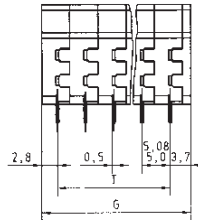
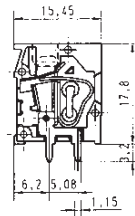

Solder pin 0.5 x 1.15 mm
Bore hole Ø 1.3 mm



Solder pin 0.5 x 1.15 mm
Bore hole Ø 1.3 mm



Rated voltages VDE 0110
UL ratings field/factory wiring
CSA ratings – pending
Approvals (UL + CSA pending)

Type 8158 TOP V
wire vertical to PC board
No. 22/30 – 12 AWG
No. 22 – 12 AWG

8258 TOP V

Type 8158 TOP H
wire horizontal to PC board
No. 22/30 – 12 AWG
No. 22 – 12 AWG

8258 TOP H

	Type	Part no.	Std. pack	Type	Part no.	Std. pack
Spacing: 5.00 mm						
2pole	8158 TOP V	25.780.0253.0	100	8158 TOP H	25.790.0253.0	100
3pole	8158 TOP V	25.780.0353.0	100	8158 TOP H	25.790.0353.0	100
4pole	8158 TOP V	25.780.0453.0	50	8158 TOP H	25.790.0453.0	50
5pole	8158 TOP V	25.780.0553.0	50	8158 TOP H	25.790.0553.0	50
6pole	8158 TOP V	25.780.0653.0	50	8158 TOP H	25.790.0653.0	50
7pole	8158 TOP V	25.780.0753.0	50	8158 TOP H	25.790.0753.0	50
8pole	8158 TOP V	25.780.0853.0	50	8158 TOP H	25.790.0853.0	50
9pole	8158 TOP V	25.780.0953.0	50	8158 TOP H	25.790.0953.0	50
10pole	8158 TOP V	25.780.1053.0	50	8158 TOP H	25.790.1053.0	50
11pole	8158 TOP V	25.780.1153.0	50	8158 TOP H	25.790.1153.0	50
12pole	8158 TOP V	25.780.1253.0	50	8158 TOP H	25.790.1253.0	50
13pole	8158 TOP V	25.780.1353.0	50	8158 TOP H	25.790.1353.0	50
14pole	8158 TOP V	25.780.1453.0	50	8158 TOP H	25.790.1453.0	50
15pole	8158 TOP V	25.780.1553.0	50	8158 TOP H	25.790.1553.0	50
16pole	8158 TOP V	25.780.1653.0	50	8158 TOP H	25.790.1653.0	50
further pole numbers upon request						
Spacing: 5.08 mm						
2pole	8258 TOP V	25.781.0253.0	100	8258 TOP H	25.791.0253.0	100
3pole	8258 TOP V	25.781.0353.0	100	8258 TOP H	25.791.0353.0	100
4pole	8258 TOP V	25.781.0453.0	50	8258 TOP H	25.791.0453.0	50
5pole	8258 TOP V	25.781.0553.0	50	8258 TOP H	25.791.0553.0	50
6pole	8258 TOP V	25.781.0653.0	50	8258 TOP H	25.791.0653.0	50
7pole	8258 TOP V	25.781.0753.0	50	8258 TOP H	25.791.0753.0	50
8pole	8258 TOP V	25.781.0853.0	50	8258 TOP H	25.791.0853.0	50
9pole	8258 TOP V	25.781.0953.0	50	8258 TOP H	25.791.0953.0	50
10pole	8258 TOP V	25.781.1053.0	50	8258 TOP H	25.791.1053.0	50
11pole	8258 TOP V	25.781.1153.0	50	8258 TOP H	25.791.1153.0	50
12pole	8258 TOP V	25.781.1253.0	50	8258 TOP H	25.791.1253.0	50
13pole	8258 TOP V	25.781.1353.0	50	8258 TOP H	25.791.1353.0	50
14pole	8258 TOP V	25.781.1453.0	50	8258 TOP H	25.791.1453.0	50
15pole	8258 TOP V	25.781.1553.0	50	8258 TOP H	25.791.1553.0	50
16pole	8258 TOP V	25.781.1653.0	50	8258 TOP H	25.791.1653.0	50
further pole numbers upon request						
Accessories						
Adhesive marking strips	1 – 12 (100 x)	04.007.4089.0	1		04.007.4089.0	1
	13 – 24 (100 x)	04.007.4189.0	1		04.007.4189.0	1
Marking upon request						
Test plug		Z5.553.2921.0	10		Z5.553.2921.0	10

PC board connectors, spring clamp connection

Spacing: 7.50/7.62 mm

wiecon PCB

Rated cross section:
2.5 mm²

Rated current:
16 A

Connection range:
0.14 – 4.0 mm² solid/
0.14 – 2.5 mm² fine stranded

400 V/6 kV/3 – Overvoltage category III
1000 V/6 kV/2 – Overvoltage category II
1000 V/6 kV/1 – Overvoltage category I

Material:
Insulating housings: PA 66/6 gray, UL 94-V-0
Clamping body: spring clamp
Contact clip with solder pin:
tin-plated E copper

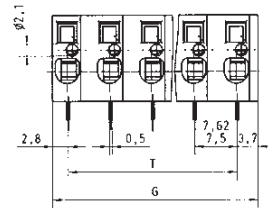
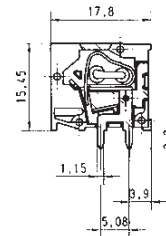
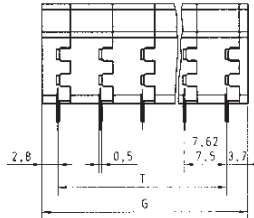
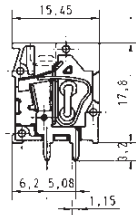

Solder pin 0.5 x 1.15 mm
Bore hole Ø 1.3 mm

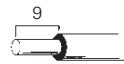

Solder pin 0.5 x 1.15 mm
Bore hole Ø 1.3 mm

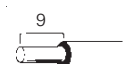

Type 8358 TOP V
wire vertical to PC board
No. 22/30 – 12 AWG
No. 22 – 12 AWG

8458 TOP V

Type 8358 TOP H
wire horizontal to PC board
No. 22/30 – 12 AWG
No. 22 – 12 AWG

8458 TOP H

Rated voltages VDE 0110
UL ratings field/factory wiring
CSA ratings
Approvals (UL + CSA pending)

	Type	Part no.	Std. pack	Type	Part no.	Std. pack
Spacing: 7.50 mm						
2pole	8358 TOP V	25.782.0253.0	100	8358 TOP H	25.792.0253.0	100
3pole	8358 TOP V	25.782.0353.0	100	8358 TOP H	25.792.0353.0	100
4pole	8358 TOP V	25.782.0453.0	50	8358 TOP H	25.792.0453.0	50
5pole	8358 TOP V	25.782.0553.0	50	8358 TOP H	25.792.0553.0	50
6pole	8358 TOP V	25.782.0653.0	50	8358 TOP H	25.792.0653.0	50
7pole	8358 TOP V	25.782.0753.0	50	8358 TOP H	25.792.0753.0	50
8pole	8358 TOP V	25.782.0853.0	50	8358 TOP H	25.792.0853.0	50
9pole	8358 TOP V	25.782.0953.0	50	8358 TOP H	25.792.0953.0	50
10pole	8358 TOP V	25.782.1053.0	50	8358 TOP H	25.792.1053.0	50
11pole	8358 TOP V	25.782.1153.0	50	8358 TOP H	25.792.1153.0	50
12pole	8358 TOP V	25.782.1253.0	50	8358 TOP H	25.792.1253.0	50
13pole	8358 TOP V	25.782.1353.0	50	8358 TOP H	25.792.1353.0	50
14pole	8358 TOP V	25.782.1453.0	50	8358 TOP H	25.792.1453.0	50
15pole	8358 TOP V	25.782.1553.0	50	8358 TOP H	25.792.1553.0	50
16pole	8358 TOP V	25.782.1653.0	50	8358 TOP H	25.792.1653.0	50
further number of poles upon request						
Spacing: 7.62 mm						
2pole	8458 TOP V	25.783.0253.0	100	8458 TOP H	25.793.0253.0	100
3pole	8458 TOP V	25.783.0353.0	100	8458 TOP H	25.793.0353.0	100
4pole	8458 TOP V	25.783.0453.0	50	8458 TOP H	25.793.0453.0	50
5pole	8458 TOP V	25.783.0553.0	50	8458 TOP H	25.793.0553.0	50
6pole	8458 TOP V	25.783.0653.0	50	8458 TOP H	25.793.0653.0	50
7pole	8458 TOP V	25.783.0753.0	50	8458 TOP H	25.793.0753.0	50
8pole	8458 TOP V	25.783.0853.0	50	8458 TOP H	25.793.0853.0	50
9pole	8458 TOP V	25.783.0953.0	50	8458 TOP H	25.793.0953.0	50
10pole	8458 TOP V	25.783.1053.0	50	8458 TOP H	25.793.1053.0	50
11pole	8458 TOP V	25.783.1153.0	50	8458 TOP H	25.793.1153.0	50
12pole	8458 TOP V	25.783.1253.0	50	8458 TOP H	25.793.1253.0	50
13pole	8458 TOP V	25.783.1353.0	50	8458 TOP H	25.793.1353.0	50
14pole	8458 TOP V	25.783.1453.0	50	8458 TOP H	25.793.1453.0	50
15pole	8458 TOP V	25.783.1553.0	50	8458 TOP H	25.793.1553.0	50
16pole	8458 TOP V	25.783.1653.0	50	8458 TOP H	25.793.1653.0	50
further number of poles upon request						
Accessories						
Marking upon request						
Test plug		Z5.553.2921.0	10		Z5.553.2921.0	10

Spacing: 6.35 mm *wiecon*

Rated cross section:
4.0 mm²

Rated current:
36 A
(related to an ambient temperature of 20 °C,
the rated cross section and max. number of poles)

Connection range:
0.5 – 6.0 mm² solid/
0.5 – 4.0 mm² fine stranded

320 V/4 kV/3 – Overvoltage category III
320 V/4 kV/2 – Overvoltage category II
320 V/4 kV/1 – Overvoltage category I

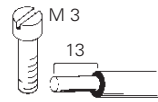
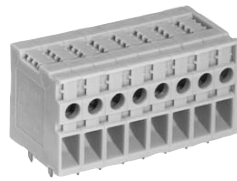
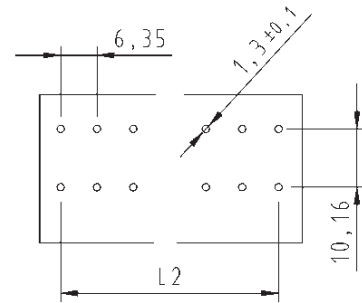
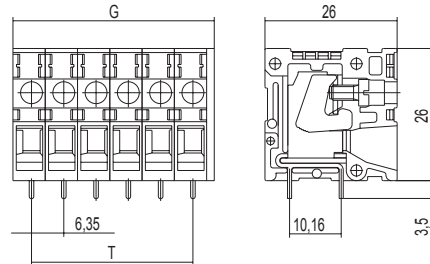

Solder pin Ø 0.8 x 0.9 mm
Bore hole Ø 1.3 mm

Type 7386 TOP H

Rated voltages VDE 0110
UL ratings
CSA ratings
Approvals

field/factory wiring

No. 22 – 10 AWG
No. 22 – 10 AWG

300 V 30 A
300 V 30 A

Std. pack	G	T	Poles	Part no.
Spacing: 6.35 mm				
50	14.20	6.35	2	27.714.0253.0
50	20.55	12.70	3	27.714.0353.0
50	26.90	19.05	4	27.714.0453.0
50	33.25	25.40	5	27.714.0553.0
50	39.60	31.75	6	27.714.0653.0
50	45.95	38.10	7	27.714.0753.0
50	52.30	44.45	8	27.714.0853.0

wiecon

wiecon PCB

Rated cross section:
4.0 mm²

Rated current:
36 A

(related to an ambient temperature of 20°C,
the rated cross section and max. number of poles)

Connection range:
0.5 – 6.0 mm² solid/
0.5 – 4.0 mm² fine stranded

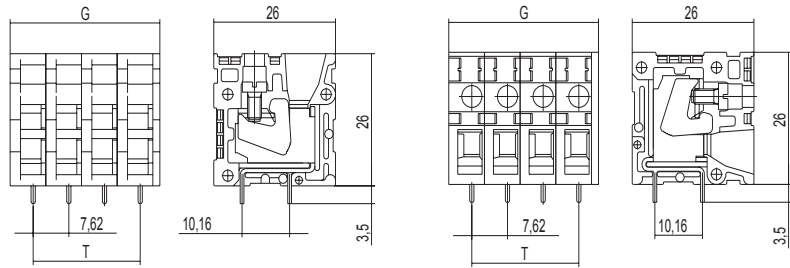

500 V/4 kV/3 – Overvoltage category III
630 V/4 kV/2 – Overvoltage category II
1000 V/4 kV/1 – Overvoltage category I



Solder pin 0.8 x 0.9 mm
Bore hole Ø 1.3 mm

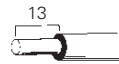

Solder pin 0.8 x 0.9 mm
Bore hole Ø 1.3 mm

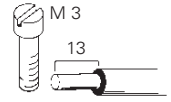

8486 TOP V

8486 TOP H

Rated voltages VDE 0110
UL ratings
CSA ratings
Approvals

field wiring

No. 22 – 10 AWG
No. 22 – 10 AWG

300 V 30 A
300 V 30 A

No. 22 – 10 AWG
No. 22 – 10 AWG

300 V 30 A
300 V 30 A



Std. pack	G	T	Poles	Part no.	Part no.
Spacing: 7.62 mm				unmarked	unmarked
50	16.74	7.62	2	27.703.0253.0	27.713.0253.0
50	24.36	15.24	3	27.703.0353.0	27.713.0353.0
50	31.98	22.86	4	27.703.0453.0	27.713.0453.0

Accessories

wiecon

Test plug and marking tag carrier for 8191 E / 8191 D / 8291 E / 8291 D can only be used in the upper tier.

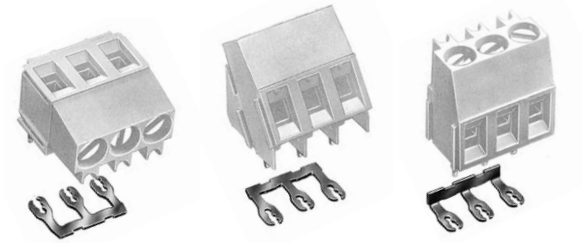

- Jumper bar 2 to 24pole for 5.00 and 5.08 mm spacing upon request
- PC board connector with assembled jumper bar upon request



Type 8191 / 8191 E / 8191 D / 8192 Type 8291 / 8291 E / 8291 D

Type 8391/8491

Type 8135 / 8235 Type 8191 ZW / 8291 ZW / 8192

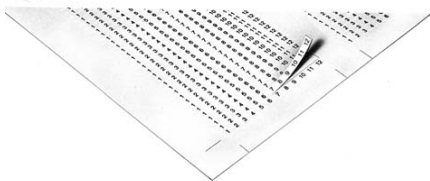
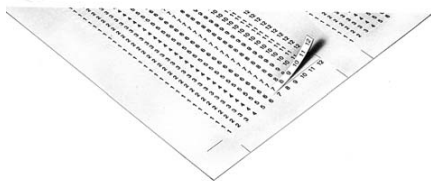
Poles	Part no.	Std. pack	Poles	Part no.	Std. pack	Poles	Part no.	Std. pack
1	Test plug Z5.533.7121.0	100	1	Test Plug Z5.533.7121.0	100	1	Test plug Z5.533.7121.0	100
2	Z5.533.7221.0	100	2	Z5.533.8221.0	50	2	Z5.533.7221.0	100
1	Test plug, 1pole, 10 mm spacing Z5.533.7121.0 Marking tag carrier for 12 poles, divisible for smaller pole configurations 04.242.4653.0	100 50				1	Test plug, 1pole, 10 mm spacing Z5.533.7121.0 Marking tag carrier for 12 poles, divisible for smaller pole configurations 04.242.4653.0	100 50
	Marking strips, unmarked 04.242.5053.0	25					Marking strips, unmarked 04.242.5053.0	25
	1 – 10, 11 – 20 etc. 991 – 999, marked 04.842.5053.0	25					1 – 10, 11 – 20 etc. 991 – 999, marked 04.842.5053.0	25
	Tear-off marking strip marked 1, 2, 3 ... 0 04.841.2150.0	25					Tear-off marking strip marked 1, 2, 3 ... 0 04.841.2150.0	25
	Single tag, unmarked 04.242.0850.0	500					Single tag, unmarked 04.242.0850.0	500
	marked 04.842.0850.0	500					marked 04.842.0850.0	500
								
	Adhesive marking strips (1 sheet = 100strips)			Adhesive marking strips (1 sheet = 100strips)			Adhesive marking strips (1 sheet = 100strips)	
	1 – 12	04.007.4089.0		1 – 12	04.007.4089.0		1 – 12	04.007.4089.0
	13 – 24	04.007.4189.0		13 – 24	04.007.4189.0		13 – 24	04.007.4189.0
	25 – 36	04.007.4289.0		25 – 36	04.007.4289.0		25 – 36	04.007.4289.0
	37 – 48	04.007.4389.0		37 – 48	04.007.4389.0		37 – 48	04.007.4389.0
	49 – 60	04.007.4489.0		49 – 60	04.007.4489.0		49 – 60	04.007.4489.0
	61 – 72	04.007.4589.0		61 – 72	04.007.4589.0		61 – 72	04.007.4589.0
	73 – 84	04.007.4689.0		73 – 84	04.007.4689.0		73 – 84	04.007.4689.0
	85 – 96	04.007.4789.0		85 – 96	04.007.4789.0		85 – 96	04.007.4789.0
	97 – 108	04.007.4889.0		97 – 108	04.007.4889.0		97 – 108	04.007.4889.0

PC board connectors, rising cage clamp system

Spacing: 5.00/10.00 mm

wiecon PCB

Rated cross section:
2.5 mm²

Rated current:
16 A

Connection range:
0.14 – 4.0 mm² solid/
0.14 – 2.5 mm² fine stranded

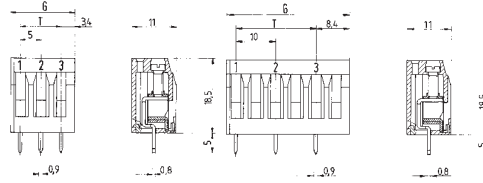

250 V/4 kV/3 – Overvoltage category III
*690 V/4 kV/2 – Overvoltage category II
1000 V/4 kV/1 – Overvoltage category I

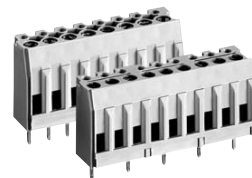

Solder pin 0.8 x 0.9 mm
Bore hole Ø 1.2 mm

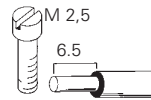

* max. 600 V for ungrounded networks or expected overvoltage ≤ 4 kV

Type 8190

wire horizontal to PC board

No. 22 – 12 AWG

300 V

15 A

No. 22 – 14 AWG

300 V

10 A



Accessories Type 8190

Rated voltages VDE 0110 (Spacing: 5 mm)
UL ratings
CSA ratings
Approvals

Std. pack	G	T	Poles	Part no.	Part no.	Poles	Part no.	Std. pack
Spacing: 5.00 mm				unmarked	marked			
100	10.86	5	2	25.131.0253.0	25.130.0253.0	1	Test plug, nominal current = 2A	
100	15.86	10	3	25.131.0353.0	25.130.0353.0	2	Z5.543.0153.0	100
50	20.86	15	4	25.131.0453.0	25.130.0453.0		Z5.543.0253.0	100
							Marking tag carrier for 12 poles, divisible for smaller pole configurations	
50	25.86	20	5	25.131.0553.0	25.130.0553.0		04.242.4653.0	50
50	30.86	25	6	25.131.0653.0	25.130.0653.0		Marking strips, unmarked	
50	35.86	30	7	25.131.0753.0	25.130.0753.0		04.242.5053.0	25
50	40.86	35	8	25.131.0853.0	25.130.0853.0		1 – 10, 11 – 20 etc. 991 – 999, marked	
50	45.86	40	9	25.131.0953.0	25.130.0953.0		04.842.5053.0	25
50	50.86	45	10	25.131.1053.0	25.130.1053.0		Tear-off marking strip marked 1, 2, 3 ... 0	
50	55.86	50	11	25.131.1153.0	25.130.1153.0		04.841.2150.0	25
50	60.86	55	12	25.131.1253.0	25.130.1253.0		Single tag, unmarked	
50	65.86	60	13	25.131.1353.0	25.130.1353.0		04.242.0850.0	500
50	70.86	65	14	25.131.1453.0	25.130.1453.0		marked	
50	75.86	70	15	25.131.1553.0	25.130.1553.0		04.842.0850.0	500
50	80.86	75	16	25.131.1653.0	25.130.1653.0			
17 to 24pole upon request								
Spacing: 10.00 mm				unmarked	marked			
50	20.86	10	2	25.133.0253.0	25.132.0253.0		Adhesive marking strips (1 sheet = 100strips)	
50	30.86	20	3	25.133.0353.0	25.132.0353.0		1 – 12	04.007.4089.0
50	40.86	30	4	25.133.0453.0	25.132.0453.0		13 – 24	04.007.4189.0
50	50.86	40	5	25.133.0553.0	25.132.0553.0		25 – 36	04.007.4289.0
50	60.86	50	6	25.133.0653.0	25.132.0653.0		37 – 48	04.007.4389.0
50	70.86	60	7	25.133.0753.0	25.132.0753.0		49 – 60	04.007.4489.0
50	80.86	70	8	25.133.0853.0	25.132.0853.0		61 – 72	04.007.4589.0
50	90.86	80	9	25.133.0953.0	25.132.0953.0		73 – 84	04.007.4689.0
50	100.86	90	10	25.133.1053.0	25.132.1053.0		85 – 96	04.007.4789.0
50	110.86	100	11	25.133.1153.0	25.132.1153.0		97 – 108	04.007.4889.0
50	120.86	110	12	25.133.1253.0	25.132.1253.0			
Rated voltages: (spacing: 10.00 mm): VDE 0110				Material: Insulating housing: PA 6/66, UL 94-V-0 Clamping body: zinc-plated steel Contact clip with solder pin: tin-plated E copper Clamping screw: zinc-plated steel				
690 V/8 kV/3 – Overvoltage category III 1000 V/8 kV/2 – Overvoltage category II 1000 V/8 kV/1 – Overvoltage category I								

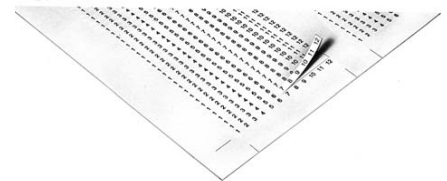

PC board connectors, rising cage clamp system

Spacing: 7.50 mm

Rated cross section:
2.5 mm²

Rated current:
16 A

Connection range:
0.14 – 4.0 mm² solid/
0.14 – 2.5 mm² fine stranded

500 V/6 kV/3 – Overvoltage category III
1000 V/6 kV/2 – Overvoltage category II
1000 V/6 kV/1 – Overvoltage category I

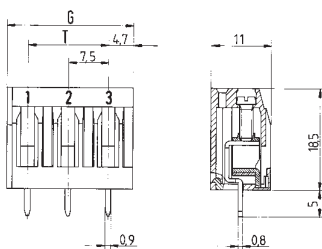

Solder pin 0.8 x 0.9 mm
Bore hole Ø 1.2 mm

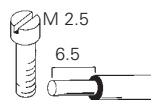

Type 8390

wire horizontal to PC board

Rated voltages VDE 0110
UL ratings
CSA ratings
Approvals

No. 22 – 12 AWG 300 V 15 A
No. 22 – 14 AWG 300 V 10 A



Accessories Type 8390

Std. pack	G	T	Poles	Part no.	Part no.	Poles	Part no.	Std. pack
Spacing: 7.50 mm								
				unmarked	marked			
100	15.86	7.5	2	25.151.0253.0	25.150.0253.0	1	Test plug / nominal current = 2 A	
100	23.36	15.0	3	25.151.0353.0	25.150.0353.0	2	Z5.543.0153.0	100
50	30.86	22.5	4	25.151.0453.0	25.150.0453.0		Z5.543.0253.0	100
50	38.36	30.0	5	25.151.0553.0	25.150.0553.0			
50	45.86	37.5	6	25.151.0653.0	25.150.0653.0			
50	53.36	45.0	7	25.151.0753.0	25.150.0753.0			
50	60.86	52.5	8	25.151.0853.0	25.150.0853.0			
50	68.36	60.0	9	25.151.0953.0	25.150.0953.0			
50	75.86	67.5	10	25.151.1053.0	25.150.1053.0			
50	83.36	75.0	11	25.151.1153.0	25.150.1153.0			
50	90.86	82.5	12	25.151.1253.0	25.150.1253.0			
				Material: Insulating housing: PA 6/66, UL 94-V-0 Clamping body: zinc-plated steel Contact clip with solder pin: tin-plated E copper Clamping screw: zinc-plated steel				



wiecon

Material:

Insulating housing: PA 66/6 gray, UL 94-V-0

Clamping body: nickel-plated brass

Contact clip with solder pin:

tin-plated bronze

Clamping screw: zinc-plated steel

Brass Nickel-plated

available upon request

Part no.	Part no.
unmarked with insulating plate without fixing bolts	marked with insulating plate with fixing bolts
upon request	upon request
upon request	upon request



PC board connectors, rising cage clamp system

Spacing: 5.00/5.08 mm

wiecon PCB

Rated cross section:
2.5 mm²

Rated current:
16 A

Connection range:
0.14 – 4.0 mm² solid/
0.14 – 2.5 mm² fine stranded

250 V/4 kV/3 – Overvoltage category III
*690 V/4 kV/2 – Overvoltage category II
1000 V/4 kV/1 – Overvoltage category I

* max. 600 V for ungrounded networks or expected overvoltage ≤ 4 kV

without insulating plate

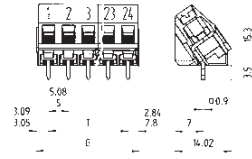

with insulating plate, without fixing bolts

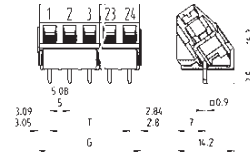

Bore hole plan for version with fixing bolts

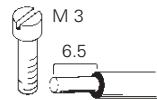
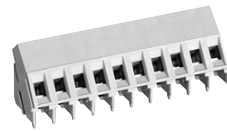
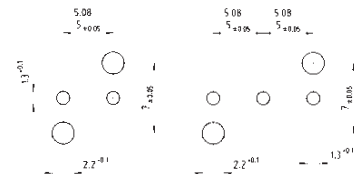

Solder pin 0.9 x 0.9 mm
Bore hole Ø 1.3 mm

Type 8135/8235

wire 35° to PC board

Rated voltages VDE 0110

UL ratings

CSA ratings

Approvals

field/factory wiring

No. 22 – 12 AWG

No. 22 – 12 AWG

300 V 20/30 A

300 V 25 A



Std. pack	G	T	Poles	Part no.	Part no.	Part no.	Part no.
				unmarked without insulating plate	marked without insulating plate	unmarked with insulating plate with fixing bolts	marked with insulating plate with fixing bolts
Spacing: 5.00 mm							
100	10.85	5	2	25.521.0253.0	25.520.0253.0	25.521.6253.0	25.520.6253.0
100	15.85	10	3	25.521.0353.0	25.520.0353.0	25.521.6353.0	25.520.6353.0
50	20.85	15	4	25.521.0453.0	25.520.0453.0		
50	25.85	20	5	25.521.0553.0	25.520.0553.0		
50	30.85	25	6	25.521.0653.0	25.520.0653.0		
50	35.85	30	7	25.521.0753.0	25.520.0753.0		
50	40.85	35	8	25.521.0853.0	25.520.0853.0		
50	45.85	40	9	25.521.0953.0	25.520.0953.0		
50	50.85	45	10	25.521.1053.0	25.520.1053.0		
50	55.85	50	11	25.521.1153.0	25.520.1153.0		
50	60.85	55	12	25.521.1253.0	25.520.1253.0		
50	65.85	60	13	25.521.1353.0	25.520.1353.0		
50	70.85	65	14	25.521.1453.0	25.520.1453.0		
50	75.85	70	15	25.521.1553.0	25.520.1553.0		
50	80.85	75	16	25.521.1653.0	25.520.1653.0		
17 to 24pole upon request							
Spacing: 5.08 mm							
100	11.01	5.08	2	25.523.0253.0	25.522.0253.0	25.523.6253.0	25.522.6253.0
100	16.09	10.16	3	25.523.0353.0	25.522.0353.0	25.523.6353.0	25.522.6353.0
50	21.17	15.24	4	25.523.0453.0	25.522.0453.0		
50	26.25	20.32	5	25.523.0553.0	25.522.0553.0		
50	31.33	25.40	6	25.523.0653.0	25.522.0653.0		
50	36.41	30.48	7	25.523.0753.0	25.522.0753.0		
50	41.49	35.56	8	25.523.0853.0	25.522.0853.0		
50	46.57	40.64	9	25.523.0953.0	25.522.0953.0		
50	51.65	45.72	10	25.523.1053.0	25.522.1053.0		
50	56.73	50.80	11	25.523.1153.0	25.522.1153.0		
50	61.81	55.88	12	25.523.1253.0	25.522.1253.0		
50	66.89	60.96	13	25.523.1353.0	25.522.1353.0		
50	71.97	66.04	14	25.523.1453.0	25.522.1453.0		
50	77.05	71.12	15	25.523.1553.0	25.522.1553.0		
50	82.13	76.20	16	25.523.1653.0	25.522.1653.0		
17 to 24pole upon request							

wiecon

with insulating plate, with fixing bolts

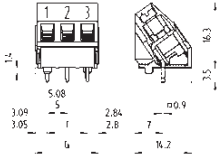

Material:

- Insulating housing: PA 66/6 gray, UL 94-V-0
- Clamping body: nickel-plated brass
- Contact clip with solder pin: tin-plated E copper
- Clamping screw: zinc-plated steel
- Brass Nickel-plated available upon request

Part no.	Part no.
unmarked with insulating plate without fixing bolts	marked with insulating plate without fixing bolts
upon request	upon request
upon request	upon request



PC board connectors, rising cage clamp system

Spacing: 5.00/5.08 mm

wiecon PCB

Rated cross section:
1.5 mm²

Rated current:
10 A

Connection range:
0.14 – 2.5 mm² solid/
0.14 – 1.5 mm² fine stranded

250 V/4 kV/3 – Overvoltage category III
*690 V/4 kV/2 – Overvoltage category II
1000 V/4 kV/1 – Overvoltage category I

without insulating plate

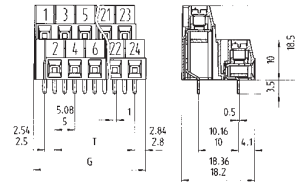

with insulating plate, without fixing bolts

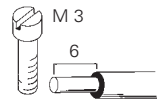
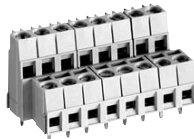
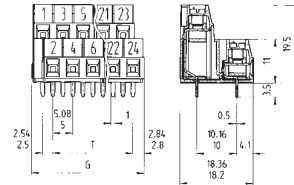

Solder pin 0.5 x 1.0 mm
Bore hole Ø 1.2 mm

* max. 600 V for ungrounded networks or expected overvoltage ≤ 4 kV

Type 8192 E/8292 E

wire horizontal to PC board

Rated voltages VDE 0110

UL ratings

CSA ratings

Approvals

field/factory wiring

No. 30 – 14 AWG

No. 30 – 14 AWG

300 V 15/16 A

300 V 15 A



Std. pack	G	T	Poles	Part no.	Part no.	Part no.	Part no.
				unmarked without insulating plate	marked without insulating plate	unmarked with insulating plate with fixing bolts	marked with insulating plate with fixing bolts
Spacing: 5.00 mm							
50	13.05	5	4	25.198.5253.0	25.198.0253.0	25.198.9253.0	25.198.4253.0
50	18.05	10	6	25.198.5353.0	25.198.0353.0	25.198.9353.0	25.198.4353.0
50	23.05	15	8	25.198.5453.0	25.198.0453.0		
50	28.05	20	10	25.198.5553.0	25.198.0553.0		
50	33.05	25	12	25.198.5653.0	25.198.0653.0		
50	38.05	30	14	25.198.5753.0	25.198.0753.0		
50	43.05	35	16	25.198.5853.0	25.198.0853.0		
50	48.05	40	18	25.198.5953.0	25.198.0953.0		
50	53.05	45	20	25.198.6053.0	25.198.1053.0		
50	58.05	50	22	25.198.6153.0	25.198.1153.0		
50	63.05	55	24	25.198.6253.0	25.198.1253.0		
Spacing: 5.08 mm							
50	13.25	5.08	4	25.199.5253.0	25.199.0253.0	25.199.9253.0	25.199.4253.0
50	18.33	10.16	6	25.199.5353.0	25.199.0353.0	25.199.9353.0	25.199.4353.0
50	23.41	15.24	8	25.199.5453.0	25.199.0453.0		
50	28.49	20.32	10	25.199.5553.0	25.199.0553.0		
50	33.57	25.40	12	25.199.5653.0	25.199.0653.0		
50	38.65	30.48	14	25.199.5753.0	25.199.0753.0		
50	43.73	35.56	16	25.199.5853.0	25.199.0853.0		
50	48.81	40.64	18	25.199.5953.0	25.199.0953.0		
50	53.89	45.72	20	25.199.6053.0	25.199.1053.0		
50	58.97	50.80	22	25.199.6153.0	25.199.1153.0		
50	64.05	55.88	24	25.199.6253.0	25.199.1253.0		

Tear-off marking strip with 10 marking tags

wiecon



Material: Polyamide 6/66 white/markings black	Marking per tree	Type	Part no.	Std. pack
unmarked		9704 A	04.241.1150.0	25
marked with the same number	1 1 1 1 1 1 1 1 1 1	9704 A/1 B	04.841.1150.0	25
	2 2 2 2 2 2 2 2 2 2	9704 A/2 B	04.841.1250.0	25
	3 3 3 3 3 3 3 3 3 3	9704 A/3 B	04.841.1350.0	25
	4 4 4 4 4 4 4 4 4 4	9704 A/4 B	04.841.1450.0	25
	5 5 5 5 5 5 5 5 5 5	9704 A/5 B	04.841.1550.0	25
	6 6 6 6 6 6 6 6 6 6	9704 A/6 B	04.841.1650.0	25
	7 7 7 7 7 7 7 7 7 7	9704 A/7 B	04.841.1750.0	25
	8 8 8 8 8 8 8 8 8 8	9704 A/8 B	04.841.1850.0	25
	9 9 9 9 9 9 9 9 9 9	9704 A/9 B	04.841.1950.0	25
	0 0 0 0 0 0 0 0 0 0	9704 A/0 B	04.841.2050.0	25
	marked with consecutive numbers	1 2 3 4 5 6 7 8 9 0	9704 A/1-0 B	04.841.2150.0
marked with the same capital letters	A A A A A A A A A A	9704 A/AG B	04.841.2250.0	25
	B B B B B B B B B B	9704 A/BG B	04.841.2350.0	25
	C C C C C C C C C C	9704 A/CG B	04.841.2450.0	25
	D D D D D D D D D D	9704 A/DG B	04.841.2550.0	25
	E E E E E E E E E E	9704 A/EG B	04.841.2650.0	25
	F F F F F F F F F F	9704 A/FG B	04.841.2750.0	25
	G G G G G G G G G G	9704 A/GG B	04.841.2850.0	25
	H H H H H H H H H H	9704 A/HG B	04.841.2950.0	25
	I I I I I I I I I I	9704 A/IG B	04.841.3050.0	25
	J J J J J J J J J J	9704 A/JG B	04.841.3150.0	25
	K K K K K K K K K K	9704 A/KG B	04.841.3250.0	25
	L L L L L L L L L L	9704 A/LG B	04.841.3350.0	25
	M M M M M M M M M M	9704 A/MG B	04.841.3450.0	25
	N N N N N N N N N N	9704 A/NG B	04.841.3550.0	25
	O O O O O O O O O O	9704 A/OG B	04.841.3650.0	25
	P P P P P P P P P P	9704 A/PG B	04.841.3750.0	25
	Q Q Q Q Q Q Q Q Q Q	9704 A/QG B	04.841.3850.0	25
	R R R R R R R R R R	9704 A/RG B	04.841.3950.0	25
	S S S S S S S S S S	9704 A/SG B	04.841.4050.0	25
	T T T T T T T T T T	9704 A/TG B	04.841.4150.0	25
	U U U U U U U U U U	9704 A/UG B	04.841.4250.0	25
	V V V V V V V V V V	9704 A/VG B	04.841.4350.0	25
	W W W W W W W W W W	9704 A/WG B	04.841.4450.0	25
	X X X X X X X X X X	9704 A/XG B	04.841.4550.0	25
	Y Y Y Y Y Y Y Y Y Y	9704 A/YG B	04.841.4650.0	25
	Z Z Z Z Z Z Z Z Z Z	9704 A/ZG B	04.841.4750.0	25
marked with the same lower case letters	a a a a a a a a a a	9704 A/AK B	04.841.4850.0	25
	b b b b b b b b b b	9704 A/BK B	04.841.4950.0	25
	c c c c c c c c c c	9704 A/CK B	04.841.5050.0	25
	d d d d d d d d d d	9704 A/DK B	04.841.5150.0	25
	e e e e e e e e e e	9704 A/EK B	04.841.5250.0	25
	f f f f f f f f f f	9704 A/FK B	04.841.5350.0	25
	g g g g g g g g g g	9704 A/GK B	04.841.5450.0	25
	h h h h h h h h h h	9704 A/HK B	04.841.5550.0	25
	i i i i i i i i i i	9704 A/IK B	04.841.5650.0	25
	j j j j j j j j j j	9704 A/JK B	04.841.5750.0	25
	k k k k k k k k k k	9704 A/KK B	04.841.5850.0	25
	l l l l l l l l l l	9704 A/LK B	04.841.5950.0	25
	m m m m m m m m m m	9704 A/MK B	04.841.6050.0	25
	n n n n n n n n n n	9704 A/NK B	04.841.6150.0	25
	o o o o o o o o o o	9704 A/OK B	04.841.6250.0	25
	p p p p p p p p p p	9704 A/PK B	04.841.6350.0	25
	q q q q q q q q q q	9704 A/QK B	04.841.6450.0	25
	r r r r r r r r r r	9704 A/RK B	04.841.6550.0	25
	s s s s s s s s s s	9704 A/SK B	04.841.6650.0	25
	t t t t t t t t t t	9704 A/TK B	04.841.6750.0	25
	u u u u u u u u u u	9704 A/UK B	04.841.6850.0	25
	v v v v v v v v v v	9704 A/VK B	04.841.6950.0	25
	w w w w w w w w w w	9704 A/WK B	04.841.7050.0	25
	x x x x x x x x x x	9704 A/XK B	04.841.7150.0	25
	y y y y y y y y y y	9704 A/YK B	04.841.7250.0	25
	z z z z z z z z z z	9704 A/ZK B	04.841.7350.0	25
marked with the same symbols	+ + + + + + + + + +	9704 A/+ B	04.841.7450.0	25
	- - - - - - - - - -	9704 A/- B	04.841.7550.0	25
	/ / / / / / / / / /	9704 A// B	04.841.7650.0	25
	9704 A/. B	04.841.7750.0	25
1 set of the same numbers = 10 x 25 strips = 2500 numbers	1 1 1 ... 0 0 0	111 to 000	04.841.9050.0	1
1 set of cap. letters = 26 x 25 strips = 6500 letters	A A A ... Z Z Z	A to Z GB	04.841.9150.0	1
1 set of lower case letters = 26 x 25 strips = 6500 letters	a a a ... z z z	a to z KB	04.841.9250.0	1



PC board connectors, rising cage clamp system

Spacing: 5.00/5.08 mm

wiecon PCB

Rated cross section:
2.5 mm²

Rated current:
16 A

Connection range:
0.14 – 4.0 mm² solid/
0.14 – 2.5 mm² fine stranded

250 V/4 kV/3 – Overvoltage category III
*690 V/4 kV/2 – Overvoltage category II
1000 V/4 kV/1 – Overvoltage category I

without insulating plate

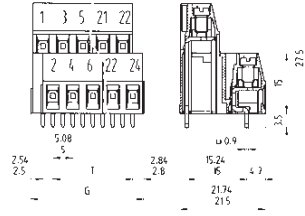

with insulating plate, without fixing bolts

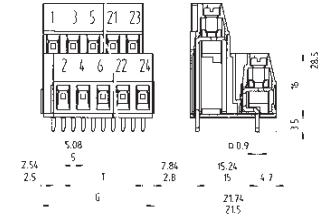

Solder pin 0.9 x 0.9 mm
Bore hole Ø 1.3 mm

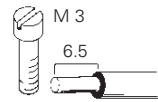

* max. 600 V for ungrounded networks or expected
overvoltage ≤ 4 kV

Type 8191 E/8291 E

wire horizontal to PC board

Rated voltages VDE 0110

UL ratings

CSA ratings

Approvals

field/factory wiring

No. 22 – 12 AWG

No. 22 – 12 AWG

300 V 20/30 A

300 V 25 A



Std. pack	G	T	Poles	Part no.	Part no.	Part no.	Part no.
				unmarked without insulating plate	marked without insulating plate	unmarked with insulating plate with fixing bolts	marked with insulating plate with fixing bolts
Spacing: 5.00 mm							
50	13.05	5	4	25.178.5253.0	25.178.0253.0	25.178.9253.0	25.178.4253.0
50	18.05	10	6	25.178.5353.0	25.178.0353.0	25.178.9353.0	25.178.4353.0
50	23.05	15	8	25.178.5453.0	25.178.0453.0		
50	28.05	20	10	25.178.5553.0	25.178.0553.0		
50	33.05	25	12	25.178.5653.0	25.178.0653.0		
50	38.05	30	14	25.178.5753.0	25.178.0753.0		
50	43.05	35	16	25.178.5853.0	25.178.0853.0		
50	48.05	40	18	25.178.5953.0	25.178.0953.0		
50	53.05	45	20	25.178.6053.0	25.178.1053.0		
50	58.05	50	22	25.178.6153.0	25.178.1153.0		
50	63.05	55	24	25.178.6253.0	25.178.1253.0		
Spacing: 5.08 mm							
50	13.25	5.08	4	25.179.5253.0	25.179.0253.0	25.179.9253.0	25.179.4253.0
50	18.33	10.16	6	25.179.5353.0	25.179.0353.0	25.179.9353.0	25.179.4353.0
50	23.41	15.24	8	25.179.5453.0	25.179.0453.0		
50	28.49	20.32	10	25.179.5553.0	25.179.0553.0		
50	33.57	25.40	12	25.179.5653.0	25.179.0653.0		
50	38.65	30.48	14	25.179.5753.0	25.179.0753.0		
50	43.73	35.56	16	25.179.5853.0	25.179.0853.0		
50	48.81	40.64	18	25.179.5953.0	25.179.0953.0		
50	53.89	45.72	20	25.179.6053.0	25.179.1053.0		
50	58.97	50.80	22	25.179.6153.0	25.179.1153.0		
50	64.05	55.88	24	25.179.6253.0	25.179.1253.0		

PC board connector, rising cage clamp system

Spacing: 5.00 mm

wiecon PCB

Rated cross section:
2.5 mm²

Rated current:
16 A

Connection range:
0.14 – 4.0 mm² solid/
0.14 – 2.5 mm² fine stranded

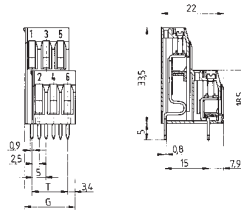

250 V/4 kV/3 – Overvoltage category III
*690 V/4 kV/2 – Overvoltage category II
1000 V/4 kV/1 – Overvoltage category I

* max. 600 V for ungrounded networks or expected overvoltage ≤ 4 kV

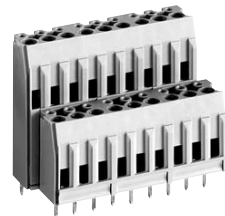

Solder pin 0.8 x 0.9 mm
Bore hole Ø 1.2 mm

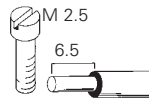

Type 8190 E
wire horizontal to PC board

No. 22 – 12 AWG 300 V 15 A
No. 22 – 14 AWG 300 V 10 A



Accessories Type 8190 E

Rated voltages VDE 0110
UL ratings
CSA ratings
Approvals

Std. pack	G	T	Poles	Part no.	Part no.	Poles	Part no.	Std. pack
Spacing: 5.00 mm				unmarked	marked			
50	13.36	5	4	25.131.3253.0	25.130.3253.0	1	Test plug, nominal current = 2A	100
50	18.36	10	6	25.131.3353.0	25.130.3353.0	2	Z5.543.0153.0	100
50	23.36	15	8	25.131.3453.0	25.130.3453.0		Z5.543.0253.0	100
							Marking tag carrier for 12 poles, divisible for smaller pole configurations	50
50	28.36	20	10	25.131.3553.0	25.130.3553.0		04.242.4653.0	50
50	33.36	25	12	25.131.3653.0	25.130.3653.0		Marking strips, unmarked	25
50	38.36	30	14	25.131.3753.0	25.130.3753.0		04.242.5053.0	25
50	43.36	35	16	25.131.3853.0	25.130.3853.0		1 – 10, 11 – 20 etc. 991 – 999, marked	25
50	48.36	40	18	25.131.3953.0	25.130.3953.0		04.842.5053.0	25
50	53.36	45	20	25.131.4053.0	25.130.4053.0		Tear-off marking strip marked 1, 2, 3 ... 0	25
50	58.36	50	22	25.131.4153.0	25.130.4153.0		04.841.2150.0	25
50	63.36	55	24	25.131.4253.0	25.130.4253.0		Single tag, unmarked	500
							04.242.0850.0	500
							marked	500
							04.842.0850.0	500
							Adhesive marking strips (1 sheet = 100strips)	
							1 – 12	04.007.4089.0 1
							13 – 24	04.007.4189.0 1
							25 – 36	04.007.4289.0 1
							37 – 48	04.007.4389.0 1
							49 – 60	04.007.4489.0 1
							61 – 72	04.007.4589.0 1
							73 – 84	04.007.4689.0 1
							85 – 96	04.007.4789.0 1
							97 – 108	04.007.4889.0 1

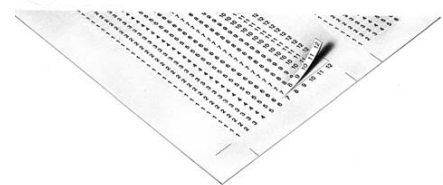

Material:
Insulating housing: PA 6/66, UL 94-V-0
Clamping body: zinc-plated steel
Contact clip with solder pin:
tin-plated E copper
Clamping screw: zinc-plated steel

wiecon



PC board connectors, rising cage clamp system

Spacing: 5.00/5.08 mm

wiecon PCB

Rated cross section:
2.5 mm²

Rated current:
16 A

Connection range:
0.14 – 4.0 mm² solid/
0.14 – 2.5 mm² fine stranded

250 V/4 kV/3 – Overvoltage category III
*690 V/4 kV/2 – Overvoltage category II
1000 V/4 kV/1 – Overvoltage category I



without insulating plate

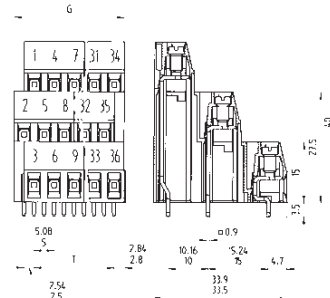

Solder pin 0.9 x 0.9 mm
Bore hole Ø 1.3 mm

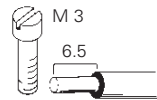

* max. 600 V for ungrounded networks or expected overvoltage ≤ 4 kV

Type 8191 D/8291 D

wire horizontal to PC board

Rated voltages VDE 0110

UL ratings

CSA ratings

Approvals

field/factory wiring

No. 22 – 12 AWG

No. 22 – 12 AWG

300 V 20/30 A

300 V 25 A



Std. pack	G	T	Poles	Part no.	Part no.	Part no.	Part no.
				unmarked without insulating plate	marked without insulating plate	unmarked with insulating plate with fixing bolts	marked with insulating plate with fixing bolts
Spacing: 5.00 mm							
50	12.8	5	6	25.180.5253.0	25.180.0253.0	25.180.9253.0	25.180.4253.0
50	17.8	10	9	25.180.5353.0	25.180.0353.0	25.180.9353.0	25.180.4353.0
50	22.8	15	12	25.180.5453.0	25.180.0453.0		
50	27.8	20	15	25.180.5553.0	25.180.0553.0		
50	32.8	25	18	25.180.5653.0	25.180.0653.0		
50	37.8	30	21	25.180.5753.0	25.180.0753.0		
50	42.8	35	24	25.180.5853.0	25.180.0853.0		
50	47.8	40	27	25.180.5953.0	25.180.0953.0		
20	52.8	45	30	25.180.6053.0	25.180.1053.0		
20	57.8	50	33	25.180.6153.0	25.180.1153.0		
20	62.8	55	36	25.180.6253.0	25.180.1253.0		
Spacing: 5.08 mm							
50	12.70	5.08	6	25.181.5253.0	25.181.0253.0	25.181.9253.0	25.181.4253.0
50	17.78	10.16	9	25.181.5353.0	25.181.0353.0	25.181.9353.0	25.181.4353.0
50	22.86	15.24	12	25.181.5453.0	25.181.0453.0		
50	27.94	20.32	15	25.181.5553.0	25.181.0553.0		
50	33.02	25.40	18	25.181.5653.0	25.181.0653.0		
50	38.10	30.48	21	25.181.5753.0	25.181.0753.0		
50	43.18	35.56	24	25.181.5853.0	25.181.0853.0		
50	48.26	40.64	27	25.181.5953.0	25.181.0953.0		
20	53.34	45.72	30	25.181.6053.0	25.181.1053.0		
20	58.42	50.80	33	25.181.6153.0	25.181.1153.0		
20	63.50	55.88	36	25.181.6253.0	25.181.1253.0		

wiecon

with insulating plate, **without** fixing bolts

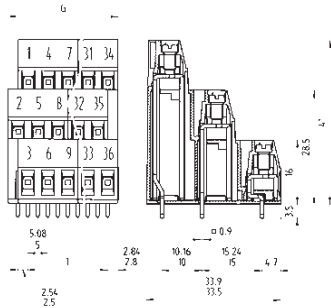

PC board connectors, rising cage clamp system

Spacing: 5.00 mm

wiecon PCB

Rated cross section:
1.5 mm², PE 2.5 mm²

Rated current:
10 A

Connection range:
0.5 – 2.5 mm² solid 0.5 – 4.0 mm² (PE)
0.5 – 1.5 mm² fine stranded 0.5 – 2.5 mm² (PE)

250 V/4 kV/3 – Overvoltage category III
*690 V/4 kV/2 – Overvoltage category II
1000 V/4 kV/1 – Overvoltage category I

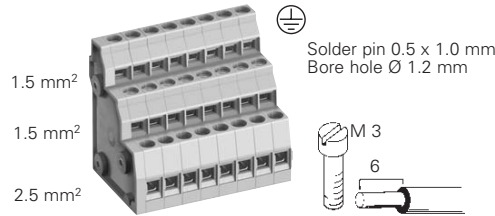
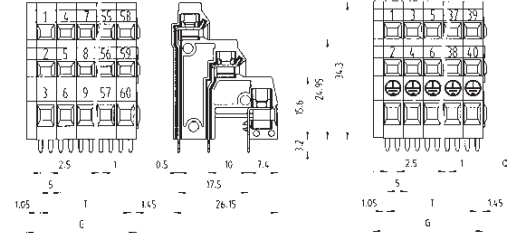

Material: **Type 8195 D/...** and
Type 8195 V/...
Insulating housing: PA 6/66, UL 94-V-0
Clamping body: tin-plated brass
Contact clip with solder pin: tin-plated
Clamping screw: zinc-plated steel

* max. 600 V for ungrounded networks or expected overvoltage ≤ 4 kV

Type 8195 D/...

wire horizontal to PC board

Rated voltages VDE 0110
UL ratings
CSA ratings
Approvals

field/factory wiring

No. 30 – 14 AWG 300 V 10 A No. 20 – 12 AWG for PE
No. 30 – 14 AWG 300 V 10 A No. 20 – 12 AWG for Ground



Std. pack	G	T	Poles	Part no. unmarked	Part no. marked
Spacing: 5.00 mm					
50	12.50	7.50	6	25.153.2253.0	25.153.0253.0
50	17.50	12.50	9	25.153.2353.0	25.153.0353.0
50	22.50	17.50	12	25.153.2453.0	25.153.0453.0
50	27.50	22.50	15	25.153.2553.0	25.153.0553.0
50	32.50	27.50	18	25.153.2653.0	25.153.0653.0
50	37.50	32.50	21	25.153.2753.0	25.153.0753.0
50	42.50	37.50	24	25.153.2853.0	25.153.0853.0
20	47.50	42.50	27	25.153.2953.0	25.153.0953.0
20	52.50	47.50	30	25.153.3053.0	25.153.1053.0
			33 to 60pole upon request		
Initiator connectors					
Spacing: 5.00 mm			jumpered	Type 8195 D/... VB1	
				unmarked	marked
50		2 PE + 4		25.153.6253.0	25.153.4253.0
50		3 PE + 6		25.153.6353.0	25.153.4353.0
50		4 PE + 8		25.153.6453.0	25.153.4453.0
50		5 PE + 10		25.153.6553.0	25.153.4553.0
50		6 PE + 12		25.153.6653.0	25.153.4653.0
50		7 PE + 14		25.153.6753.0	25.153.4753.0
50		8 PE + 16		25.153.6853.0	25.153.4853.0
50		9 PE + 18		25.153.6953.0	25.153.4953.0
20		10 PE + 20		25.153.7053.0	25.153.5053.0
		11 PE + 22 up to 20 PE + 40 upon request			

wiecon

Rated cross section:
1.5 mm², PE 2.5 mm²

Rated current:
10 A

Connection range:
0.5 – 2.5 mm² solid 0.5 – 4.0 mm² (PE)
0.5 – 1.5 mm² fine stranded 0.5 – 2.5 mm² (PE)

250 V/4 kV/3 – Overvoltage category III
*690 V/4 kV/2 – Overvoltage category II
1000 V/4 kV/1 – Overvoltage category I

* max. 600 V for ungrounded networks or expected overvoltage ≤ 4 kV

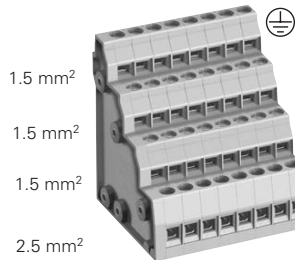
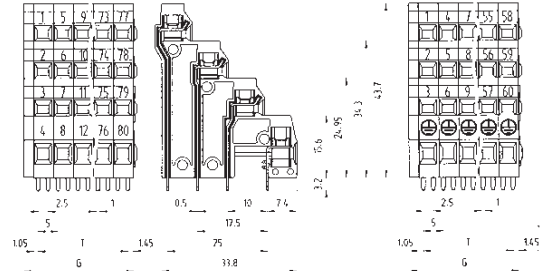

Solder pin 0.5 x 1.0 mm
Bore hole Ø 1.2 mm

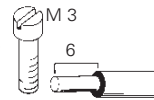

Type 8195 V/...

wire horizontal to PC board

Rated voltages VDE 0110
UL ratings
CSA ratings
Approvals

field/factory wiring

No. 30 – 14 AWG 300 V 10 A No. 20 – 12 AWG for PE
No. 30 – 14 AWG 300 V 10 A No. 20 – 12 AWG for Ground



Std. pack	G	T	Poles	Part no.	Part no.
Spacing: 5.00 mm					
				unmarked	marked
50	12.50	7.50	8	25.154.2253.0	25.154.0253.0
50	17.50	12.50	12	25.154.2353.0	25.154.0353.0
50	22.50	17.50	16	25.154.2453.0	25.154.0453.0
50	27.50	22.50	20	25.154.2553.0	25.154.0553.0
50	32.50	27.50	24	25.154.2653.0	25.154.0653.0
50	37.50	32.50	28	25.154.2753.0	25.154.0753.0
50	42.50	37.50	32	25.154.2853.0	25.154.0853.0
20	47.50	42.50	36	25.154.2953.0	25.154.0953.0
20	52.50	47.50	40	25.154.3053.0	25.154.1053.0
	44 to 80pole upon request				
Initiator connectors					
Spacing: 5.00 mm			jumpered	Type 8195 V/... VB1	
				unmarked	marked
50		2 PE + 6		25.154.6253.0	25.154.4253.0
50		3 PE + 9		25.154.6353.0	25.154.4353.0
50		4 PE + 12		25.154.6453.0	25.154.4453.0
50		5 PE + 15		25.154.6553.0	25.154.4553.0
50		6 PE + 18		25.154.6653.0	25.154.4653.0
50		7 PE + 21		25.154.6753.0	25.154.4753.0
50		8 PE + 24		25.154.6853.0	25.154.4853.0
50		9 PE + 27		25.154.6953.0	25.154.4953.0
20		10 PE + 30		25.154.7053.0	25.154.5053.0
	11 PE + 33 up to 20 PE + 60 upon request				
Bore hole plan Type 8195 D/... and Type 8195 V/...					



wiecon PCB

Rated cross section:
10 mm²

Rated current:
57 A

(related to an ambient temperature of 20°C,
the rated cross section and max. number of poles)

Connection range:
0.50 – 16.0 mm² solid/
0.50 – 10.0 mm² fine stranded

Rated voltages:

4 solder pins
250 V/4 kV/3 – Overvoltage category III
400 V/4 kV/2 – Overvoltage category III
630 V/4 kV/2 – Overvoltage category II

2 solder pins

630 V/8 kV/3 – Overvoltage category III
800 V/8 kV/2 – Overvoltage category III
1000 V/8 kV/2 – Overvoltage category II

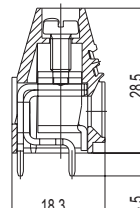
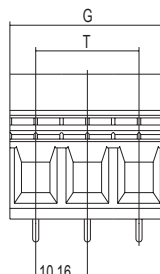
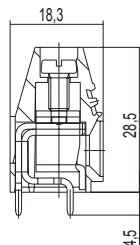
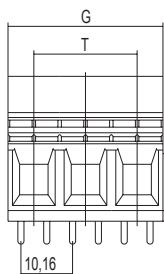

Solder pin 1.2 x 1.2 mm
Bore hole Ø 1.6 mm

Solder pin 1.2 x 1.2 mm
Bore hole Ø 1.6 mm

4 solder pins

2 solder pins

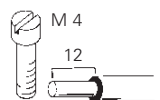

Type 7572 L4

Type 7572 L2

Rated voltages VDE 0110

UL ratings

field/factory wiring

CSA ratings

Approvals

No. 22 – 8 AWG

300/150 V 10/40 A

No. 22 – 8 AWG

300/150 V 10/40 A

No. 22 – 8 AWG

300 V 10 A

No. 22 – 8 AWG

300 V 10 A



Std. pack	G	T	Poles	Part no.	Part no.
Spacing: 10.16 mm					
50	20.32	10.16	2	27.002.0253.0	unmarked
50	30.48	20.32	3	27.002.0353.0	27.002.2253.0 27.002.2353.0

wiecon

Rated cross section:
10 mm²

Rated current:
57 A
(related to an ambient temperature of 20°C,
the rated cross section and max. number of poles)

Connection range:
0.50 – 16.0 mm² solid/
0.50 – 10.0 mm² fine stranded

Rated voltages:
1000 V/8 kV/3 – Overvoltage category III

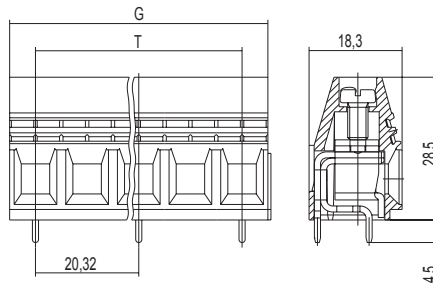

Solder pin 1.2 x 1.2 mm
Bore hole Ø 1.6 mm

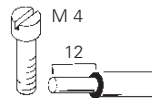

Type 7572 L2

Rated voltages VDE 0110

CSA
Approvals

No. 22 – 6 AWG

600 V 60 A

Std. pack	G	T	Poles	Part no.
Spacing: 20.32 mm				
50	30.48	20.32	2	unmarked
50	50.64	40.48	3	27.002.4253.0
				27.002.4353.0



PC board connectors, rising cage clamp system

Spacing: 5.08 mm

wiecon PCB

Rated cross section:
4.0 mm² solid/
2.5 mm² fine stranded

Rated current type 8276: 26 A
Rated current type 8276 TKS: 15 A

Connection range:
0.14 – 4.0 mm² solid/
0.14 – 2.5 mm² fine stranded

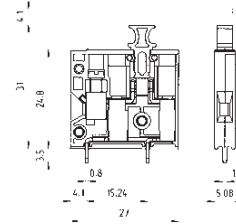
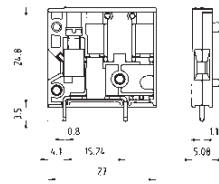

250 V/4 kV/3 – Overvoltage category III
400 V/4 kV/2 – Overvoltage category II
1000 V/4 kV/1 – Overvoltage category I

Solder pin 0.8 x 1.1 mm
Bore hole Ø 1.4 mm

Solder pin 0.8 x 1.1 mm
Bore hole Ø 1.4 mm

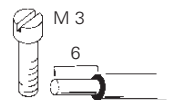
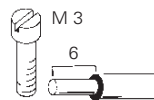

Rated voltages VDE 0110
UL ratings field/factory wiring
CSA ratings
Approvals

Type 8276
Feed through block
No. 30 – 14 AWG 300 V 15/23 A
No. 30 – 14 AWG 300 V 20 A

Type 8276 TKS
Plunger disconnect block
No. 30 – 14 AWG 300 V 15 A
No. 30 – 14 AWG 300 V 15 A

	Type	Part no.	Std. pack	Type	Part no.	Std. pack
Spacing: 5.08 mm						
Single poles, snap together 1pole Pre-assembled pole configurations upon request	8276	25.720.1353.0	100	8276 TKS	25.720.1453.0	100
Accessories						
Adhesive marking strips						
	1 – 12 13 – 24 25 – 36 37 – 48 49 – 60 61 – 72 73 – 84 85 – 96 97 – 108	04.007.4089.0 04.007.4189.0 04.007.4289.0 04.007.4389.0 04.007.4489.0 04.007.4589.0 04.007.4689.0 04.007.4789.0 04.007.4889.0	1 1 1 1 1 1 1 1 1	1 – 12 13 – 24 25 – 36 37 – 48 49 – 60 61 – 72 73 – 84 85 – 96 97 – 108	04.007.4089.0 04.007.4189.0 04.007.4289.0 04.007.4389.0 04.007.4489.0 04.007.4589.0 04.007.4689.0 04.007.4789.0 04.007.4889.0	1 1 1 1 1 1 1 1 1
Test plug, red	ST 2/2,3	Z5.553.2921.0		ST 2/2,3	Z5.553.2921.0	10
	Material: Type 8276 Insulating housing: PA 66/6 gray, UL 94-V-0 Clamping body: nickel-plated brass Contact clip with solder pin: tin-plated E copper Clamping screw: zinc-plated steel			Material: Type 8276 TKS Insulating housing: PA 66/6 gray, UL 94-V-0 Plunger: PA 66/6 orange, UL 94-V-0 Clamping body: nickel-plated brass Contact spring with solder pin: special copper alloy, tin-plated Clamping screw: zinc-plated steel Disconnect knife: tin-plated E copper		

PC board connectors, rising cage clamp system

Spacing: 5.08 mm

Rated cross section:
2.5 mm²

Rated current:
6.3 A**

Connection range:
0.14 – 4.0 mm² solid/
0.14 – 2.5 mm² fine stranded

250 V/4 kV/3 – Overvoltage category III
*690 V/4 kV/2 – Overvoltage category II
1000 V/4 kV/1 – Overvoltage category I

* max. 600 V for ungrounded networks or expected overvoltage ≤ 4 kV

** voltage and current ratings are determined by the inserted G fuse.
6.3 A up to a loss of 1.6 W

For the selection and use of G fuses follow IEC 60 127-2/DIN VDE 0820 T2.

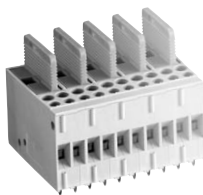
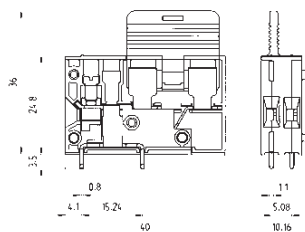

Solder pin 0.8 x 1.1 mm
and 0.5 x 1.1 mm
Bore hole Ø 1.4 mm

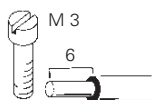

Rated voltages VDE 0110
UL ratings
CSA ratings
Approvals

Type 8276 Si-D

Ground feed through block (for 5 x 20 fuses)

No. 30 – 14 AWG 300 V 6,3 A

No. 30 – 14 AWG 300 V 6,3 A



	Type	Part no.	Std. pack	
Spacing: 5.08 mm				
Single poles, snap together	1pole	8276 Si-D	25.720.1653.0	100
Pre-assembled pole configurations upon request				
Accessories				
Adhesive marking strips				
unmarked for own marking	1 – 12	04.007.4089.0	1	
	13 – 24	04.007.4189.0	1	
	25 – 36	04.007.4289.0	1	
	37 – 48	04.007.4389.0	1	
	49 – 60	04.007.4489.0	1	
	61 – 72	04.007.4589.0	1	
	73 – 84	04.007.4689.0	1	
	85 – 96	04.007.4789.0	1	
	97 – 108	04.007.4889.0	1	
		04.007.3989.0	1	
Test plug, red	ST 2/2,3	Z5.553.2921.0	10	
Material: Type 8276 Si-D Insulating housing: PA 66/6 gray, UL 94-V-0 Fuse holder: PA 66/6 orange, UL 94-V-0 Clamping body: nickel-plated brass Contact clip with solder pin: special copper alloy, tin-plated Contact spring with solder pin: special copper alloy, tin-plated Clamping screw: zinc-plated steel				



Type 8105 B, RAST 5 connection,
PC board pluggables, tab connectors

wiecon PCB

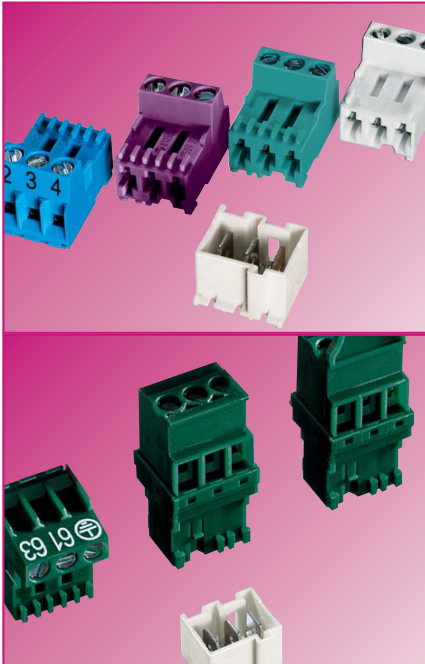

Technological advancements often appear first in electrical appliances. Printed circuit boards, which centralize and conduct signal and power to equipment, serve as a primary and essential function in this technology. Wieland Electric has designed advanced pluggable PC board screw connectors as an integral component to printed circuit boards. Using RAST 5 technology, a European standard for appliance wiring and component design, Wieland offers a wide selection of PC board connectors for the manufacture of advanced electrical appliances.

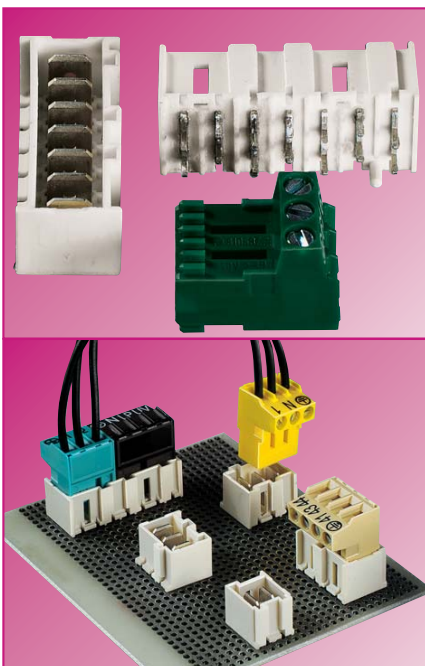
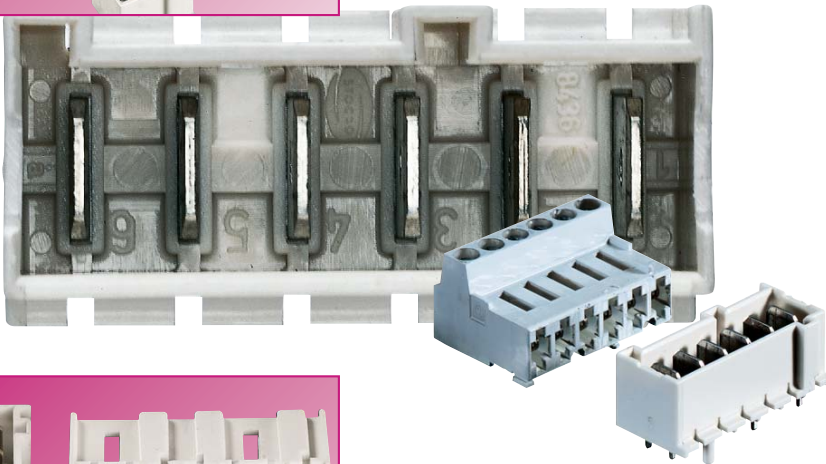

The fixed coding facilities (without coding strip) of the 8105 type are designed for the RAST 5 standard and meets all current requirements of "white goods". The same applies for the different versions, i.e. with vertical connection right and left in addition to the horizontal one, or flat blade connectors in straight design.

They are all based on a rated current of 10A. The pole configurations range from 2 to 7 poles. Both fine stranded wires of 0.14 mm² to 2.5 mm², with and without ferrules, and solid wires of 0.14 mm² to 4 mm² can be connected.



wiecon

		Page 382	Page 382	Page 383	Page 383	Page 383
Type		8105 B/... C...	8105 B/...C...VR	8105 B/...C...VL	8105 F/...GC...	8105 F/WC...
Spacing	mm	5.00	5.00	5.00	5.00	5.00
Cross section	mm²	2.5	2.5	2.5	-	-
Number of poles		2-7	2-7	2-7	2-7	2-7

wiecon

RAST 5 Coding plan

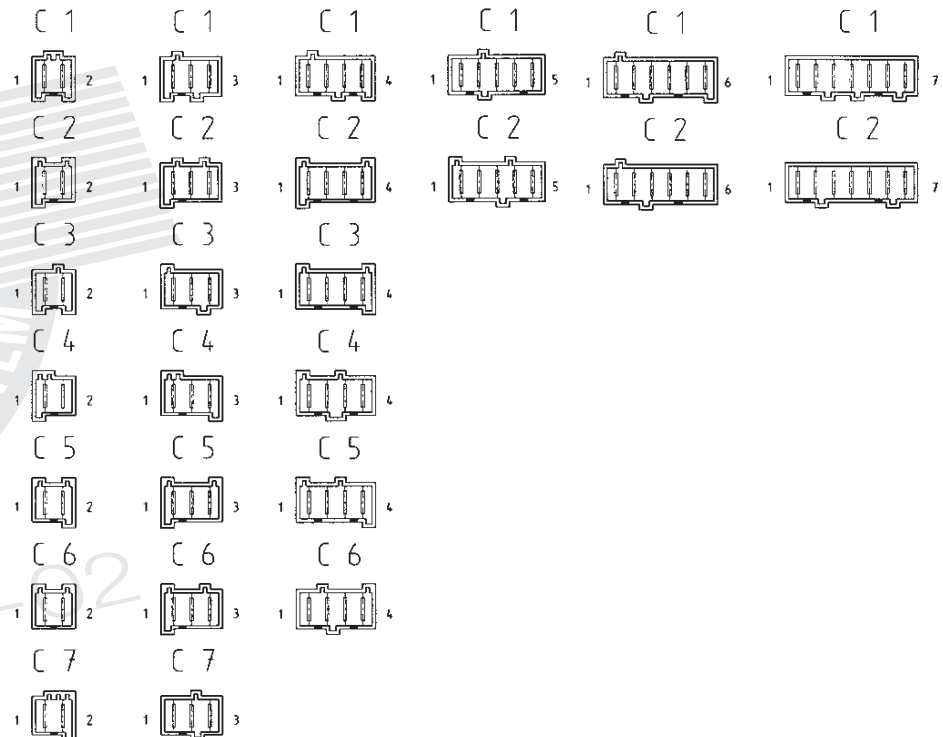
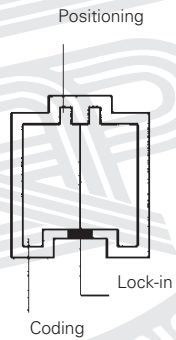

RAST 5

PC board pluggables, spacing: 5.00 mm

wiecon PCB

Rated cross section:
2.5 mm²

Rated current: 10 A

Connection range:
0.20 – 4.0 mm² solid/
0.14 – 2.5 mm² fine stranded

250 V/4 kV/3 – Overvoltage category III
400 V/4 kV/2 – Overvoltage category II
1000 V/4 kV/1 – Overvoltage category I

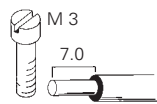
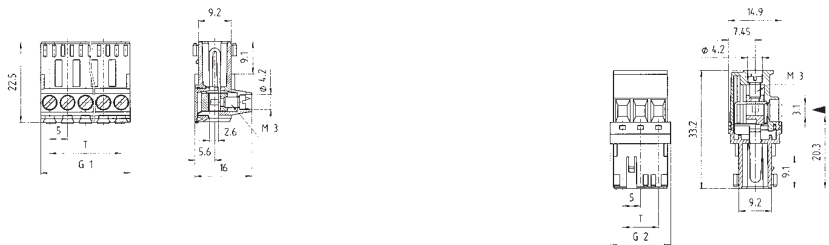

Type 8105 B/... C... OB

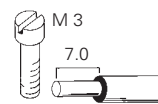

Type 8105 B/... C... VR OB

Rated voltages VDE 0110
UL ratings
CSA ratings
Approvals

No. 26 – 12 AWG
No. 26 – 12 AWG

300 V 10 A
300 V 10 A

No. 26 – 12 AWG
No. 26 – 12 AWG

300 V 10 A
300 V 10 A



Std. pack	Poles	Code	Part no.	Part no.
PC board pluggables / tab connectors			unmarked	unmarked
100	2	C0	15.000.0253.0	15.020.0253.0
100		C1	15.001.0253.0	15.021.0253.0
100		C2	15.002.0253.0	15.022.0253.0
100	3	C3	15.003.0253.0	15.023.0253.0
100		C4	15.004.0253.0	15.024.0253.0
100		C5	15.005.0253.0	15.025.0253.0
100	4	C6	15.006.0253.0	15.026.0253.0
100		C7	15.007.0253.0	15.027.0253.0
100	5	C0	15.000.0353.0	15.020.0353.0
100		C1	15.001.0353.0	15.021.0353.0
100		C2	15.002.0353.0	15.022.0353.0
100	6	C3	15.003.0353.0	15.023.0353.0
100		C4	15.004.0353.0	15.024.0353.0
100		C5	15.005.0353.0	15.025.0353.0
100	7	C6	15.006.0353.0	15.026.0353.0
100		C7	15.007.0353.0	15.027.0353.0
50	4	C0	15.000.0453.0	15.020.0453.0
50		C1	15.001.0453.0	15.021.0453.0
50		C2	15.002.0453.0	15.022.0453.0
50	5	C3	15.003.0453.0	15.023.0453.0
50		C4	15.004.0453.0	15.024.0453.0
50		C5	15.005.0453.0	15.025.0453.0
50	6	C6	15.006.0453.0	15.026.0453.0
50		C7	15.007.0453.0	15.027.0453.0
50	5	C0	15.000.0553.0	15.020.0553.0
50		C1	15.001.0553.0	15.021.0553.0
50		C2	15.002.0553.0	15.022.0553.0
50	6	C0	15.000.0653.0	15.020.0653.0
50		C1	15.001.0653.0	15.021.0653.0
50		C2	15.002.0653.0	15.022.0653.0
50	7	C0	15.000.0753.0	15.020.0753.0
50		C1	15.001.0753.0	15.021.0753.0
50		C2	15.002.0753.0	15.022.0753.0

wiecon

RAST 5 Tab connectors

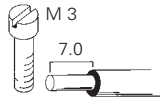
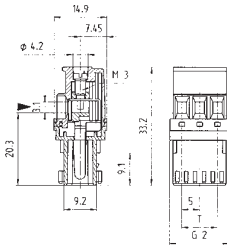

Type 8105 B/... C... VL OB

No. 26 – 12 AWG 300 V 10 A
 No. 26 – 12 AWG 300 V 10 A



Bore hole plan, side view

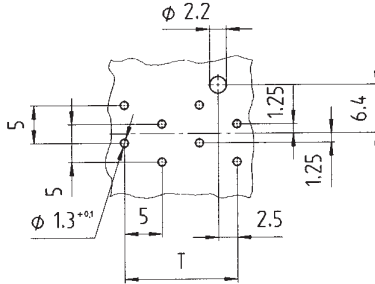

No positioning stud for version
 8105 F/... WC ...OB

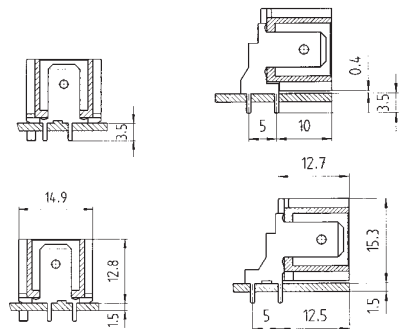

Type 8105 F/... GC ... OB / 8105 F/... WC... OB

No. 26 – 12 AWG 300 V 10 A
 No. 26 – 12 AWG 300 V 10 A



Rated voltages VDE 0110
 UL ratings
 CSA ratings
 Approvals

Part no.	Std. pack	G1	G2	G3	T	Part no.	Part no.
unmarked					RAST 5	unmarked	unmarked
15.010.0253.0	100	10	11.8		5	15.301.0258.9	15.311.0258.9
15.011.0253.0	100	10	11.8	12	5	15.302.0258.9	15.312.0258.9
15.012.0253.0	100	10	11.8	12	5		
15.013.0253.0	100	10	11.8	12	5	15.303.0258.9	15.313.0258.9
15.014.0253.0	100	10	11.8	12	5	15.304.0258.9	15.314.0258.9
15.015.0253.0	100	10	11.8	12	5	15.305.0258.9	15.315.0258.9
15.016.0253.0	100	10	11.8	12	5	15.306.0258.9	15.316.0258.9
15.017.0253.0	100	10	11.8	12	5	15.307.0258.9	15.317.0258.9
15.010.0353.0	100	15	16.8		10	15.301.0358.9	15.311.0358.9
15.011.0353.0	100	15	16.8	17	10	15.302.0358.9	15.312.0358.9
15.012.0353.0	100	15	16.8	17	10		
15.013.0353.0	100	15	16.8	17	10	15.303.0358.9	15.313.0358.9
15.014.0353.0	100	15	16.8	17	10	15.304.0358.9	15.314.0358.9
15.015.0353.0	100	15	16.8	17	10	15.305.0358.9	15.315.0358.9
15.016.0353.0	100	15	16.8	17	10	15.306.0358.9	15.316.0358.9
15.017.0353.0	100	15	16.8	17	10	15.307.0358.9	15.317.0358.9
15.010.0453.0	50	20	21.8		15	15.301.0458.9	15.311.0458.9
15.011.0453.0	50	20	21.8	22	15	15.302.0458.9	15.312.0458.9
15.012.0453.0	50	20	21.8	22	15		
15.013.0453.0	50	20	21.8	22	15	15.303.0458.9	15.313.0458.9
15.014.0453.0	50	20	21.8	22	15	15.304.0458.9	15.314.0458.9
15.015.0453.0	50	20	21.8	22	15	15.305.0458.9	15.315.0458.9
15.016.0453.0	50	20	21.8	22	15	15.306.0458.9	15.316.0458.9
15.010.0553.0	50	25	26.8		20		
15.011.0553.0	50	25	26.8	27	20	15.301.0558.9	15.311.0558.9
15.012.0553.0	50	25	26.8	27	20	15.302.0558.9	15.312.0558.9
15.010.0653.0	50	30	31.8		25		
15.011.0653.0	50	30	31.8	32	25	15.301.0658.9	15.311.0658.9
15.012.0653.0	50	30	31.8	32	25	15.302.0658.9	15.312.0658.9
15.010.0753.0	50	35	36.8		30		
15.011.0753.0	50	35	36.8	37	30	15.301.0758.9	15.311.0758.9
15.012.0753.0	50	35	36.8	37	30	15.302.0758.9	15.312.0758.9

RAST 5 connection

Potential distributor for PC board, spacing: 5.00 mm

wiecon PCB

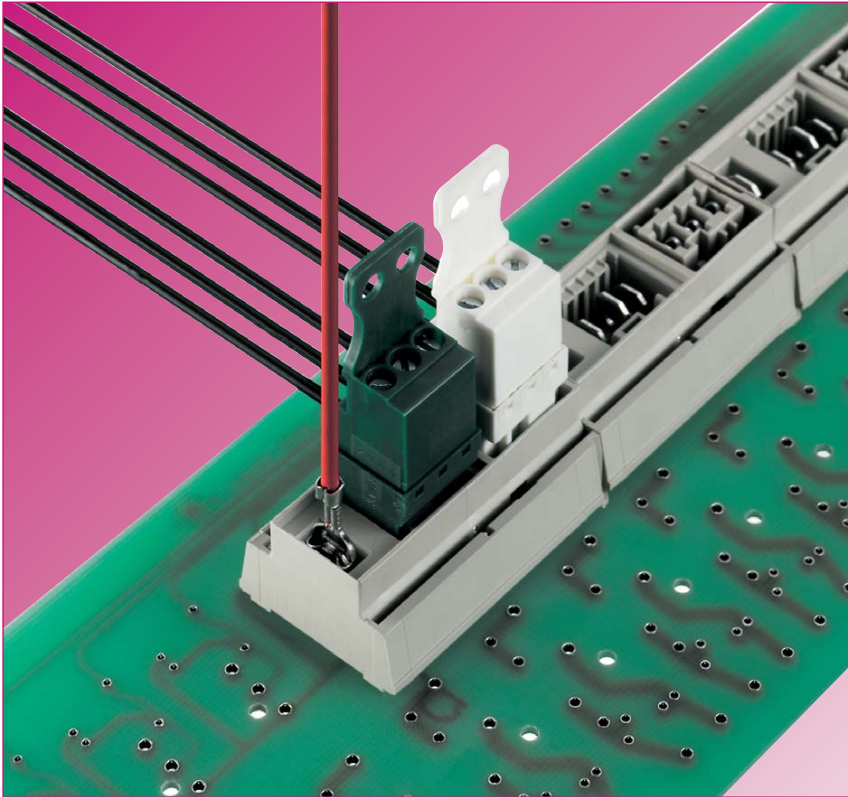

Custom connection modules in RAST 5 connection style

Main field of application:

RAST 5 connection style:
"white" and "red goods"

Major benefits of RAST 5:

- fixed integrated coding
- potential for mismating eliminated
- available in different colors
(benefit: plug connectors and headers are immediately and correctly assigned e. g. in assembly line mounting)
- ideal for off-site harness assembly

Wieland offers custom modifications e. g.

RAST 5 connection module units with

- integrated jumper
(e. g. ground connection)
- plug connectors and headers in the connection module for potential distribution (current-carrying part must always be the plug connector)
- any plug connector/header combination in different pole configurations
- different colors

wiecon

Rated cross section:
2.5 mm²

Rated current: 10 A

Connection range:
0.14 – 4.0 mm² solid/
0.14 – 2.5 mm² fine stranded

250 V/2.5 kV/3 – Overvoltage category III
*690 V/2.5 kV/2 – Overvoltage category II
1000 V/2.5 kV/1 – Overvoltage category I

Number of poles: 2 – 7

* max. 600 V for ungrounded networks or expected
overvoltage ≤ 4 kV

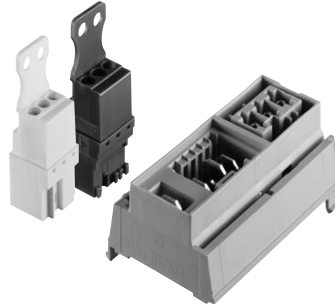

Type 8105 BF/3/4

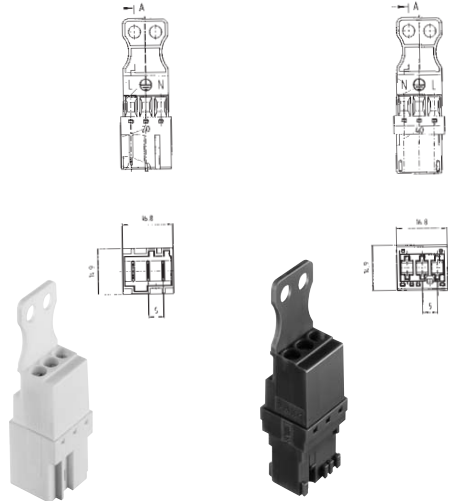

Header

Plug

Rated voltages VDE 0110
UL ratings
CSA ratings – pending
Approvals



Spacing: 5.00 mm						
Type	Part no.	Std. pack	Type	Part no.	Std. pack	
	99.243.3564.7	100	Header with handle, white	99.239.3564.7	100	
			Plug with handle, green	99.259.3564.7	100	



Termination module TM 6 / TM 12

wiecon TER

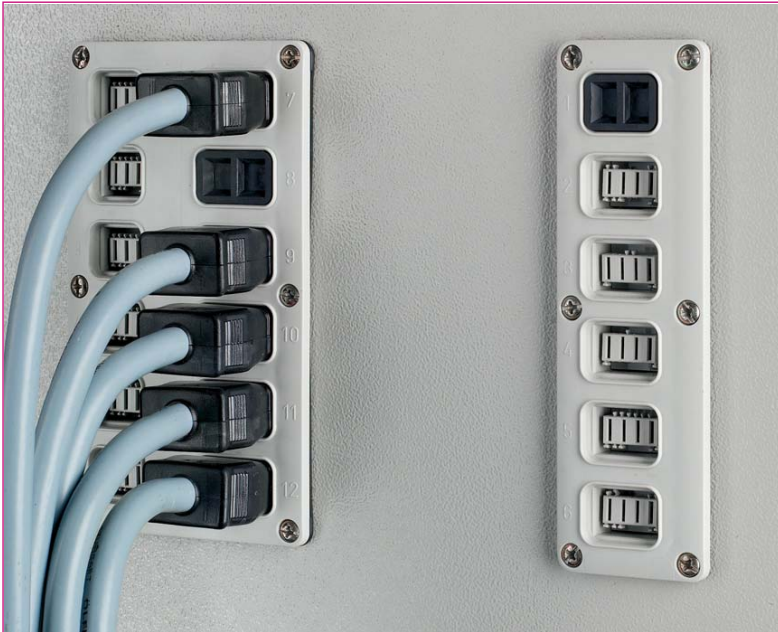

External wiring



Internal wiring

RAST 5 connection (IP 54 rated) Termination Modules for Industrial Plant Construction

The time consuming hard wiring cable connections to control cabinets can now be avoided. The modular *RAST 5* termination module by Wieland is a low cost and faster method to connect control cabinets for industrial plant construction.

This wiring system with its pre-assembled cable harness and coded connectors was developed to optimize the "start-up" of industrial plants.

Because the wires and codings are 100 percent tested, manufacturing is time and cost efficient and installation is vastly simplified.

The benefits compared to former PG gland wiring are obvious:

- installation times reduced by 80 % compared to traditional techniques
- time and cost saving pre-assembled cables
- Cable connections are IP 54 rated
- no errors as mismatching is impossible
- no specialists required to complete external wiring

wiecon

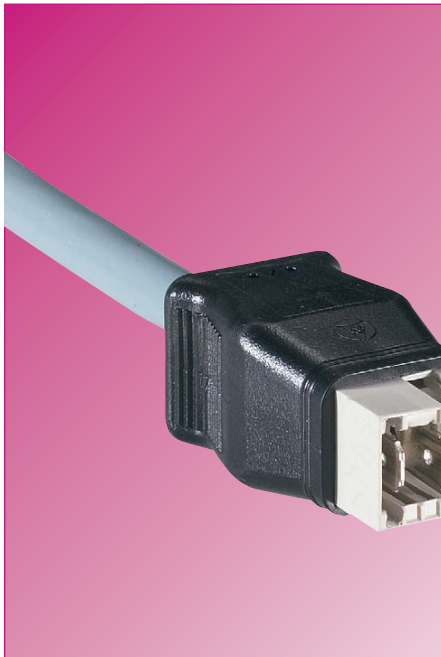

The external *RAST 5* connectors are available in 3 to 5 pole configurations. Their secure coding prevents mismatching. By means of marking labels the headers can be quickly assigned to the plug connectors in multi-pole modules.

External connection lines with special connectors, which provide sealing with IP 54 protection, are delivered with pre-assembled custom cables.

The other cable ends can also be fitted with further components such as DIN outlet boxes for temperature signal conditioners.

Internal wiring is completed either with insulated

- *RAST 5* tab connectors
- *RAST 5* screw connectors
- *RAST 5* crimp connectors

System design

- 2 basic modules are available
- module with 6 slots = TM 6
 - module with 12 slots = TM 12

All these versions are coded to prevent mismatching, meaning that the slots in the module are all different. Two different versions are available for each type.

Cable types for the external lines

The following standard cable types are available:

- Olflex Quattro 150 in 3, 4 and 5 pole configurations
- Olflex Quattro 150 CY (shielded version) in 3, 4, and 5 pole configurations

The system provides a large number of combinations of modules, codings and cables and enables various custom wiring solutions.

Depending on the order quantities, special module versions and cables are also possible.

To try out the variations, you can order the function set **TM 6-5** with cables.

Technical information on the TM modules and external cables:

Connector cross section:
1.5 mm² (standard)

Rated voltage:
250 V/4 kV/3 – Overvoltage category III

Rated current: 10 A

Approvals (pending):
UL, CSA and VDE



TM 6

The TM6 module is available in versions:

- 6 slots, 3pole = type **TM 6-3**
- 6 slots, 4pole = type **TM 6-4**
- 6 slots, 5pole = type **TM 6-5**

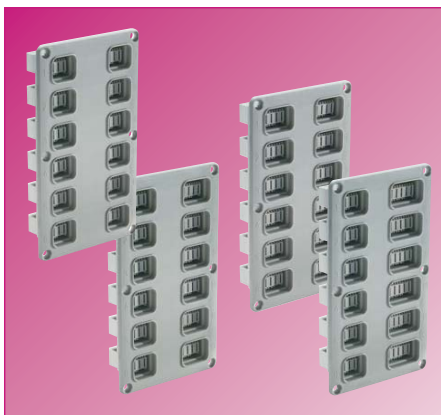

TM 12

The TM 12 module is available in versions:
12 slots in two rows of 6

- 3pole / 3pole = type **TM 12-33**
- 3pole / 4pole = type **TM 12-34**
- 4pole / 4pole = type **TM 12-44**
- 3pole / 5pole = type **TM 12-35**

Example of TM module 6/12 in a control cabinet

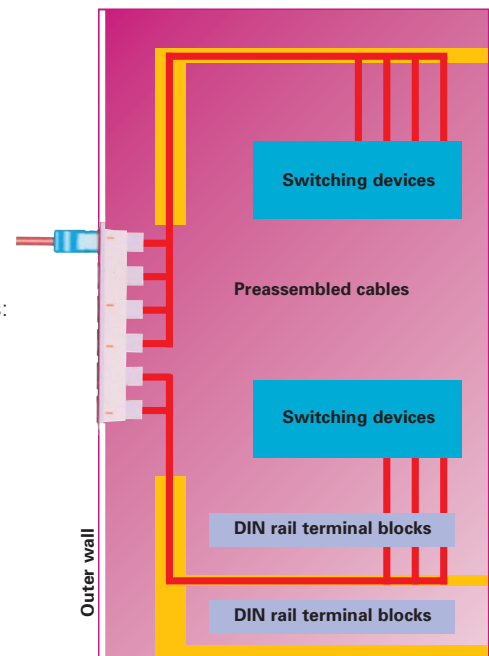

Function set TM 6

wiecon

Function set consisting of
 1 x TM 6-5, incl. cable set 6 x 10 m
 type Ölflex Quattro 5 x 1.5 mm²
 with one 5pole connector each in tab version

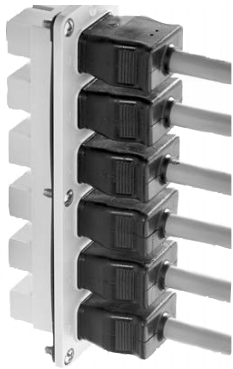

6 slots, 3pole =
type **TM 6-3**



6 slots, 4pole =
type **TM 6-4**

Typ TM 6-5 F

Typ TM 6-3

Typ TM 6-4

Type	Part no.	Std. pack	Type	Part no.	Std. pack	Type	Part no.	Std. pack
TM 6-5 F	99.483.0000.0		TM 6-3		upon request	TM 6-4		upon request
			coding upon request			coding upon request		

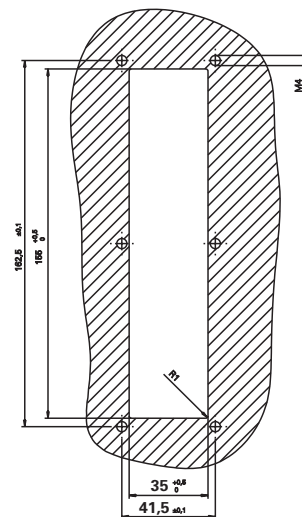

or bore hole
 D = 3.8 mm for
 self-tapping
 screw
 05.084.0212.0

Outer dimensions, cut-out and bore hole
 configuration are the same for all
 TM 6 versions

wiecon



6 slots, 5pole =
type **TM 6-5**



TM 6 cover
fits all pole configurations



Locking piece

Typ TM 6-5

Type	Part no.	Std. pack	Type	Part no.	Std. pack	Type	Part no.	Std. pack
TM 6-5		upon request	TM 6-X	15.800.9956.0		3pole	05.562.5957.1	
coding upon request		request				4pole	05.562.6557.1	
						5pole	05.562.8257.1	



Function set TM 12



12 slots,
in two rows of 6
3pole / 3pole =
type **TM 12-33**



12 slots,
in two rows of 6
3pole / 4pole =
type **TM 12-34**



12 slots,
in two rows of 6
4pole / 4pole =
type **TM 12-44**

Typ TM 12-33

Typ TM 12-34

Typ TM 12-44

Type	Part no.	Std. pack	Type	Part no.	Std. pack	Type	Part no.	Std. pack
TM 12-33		upon request	TM 12-34		upon request	TM 12-44		upon request
coding upon request			coding upon request			coding upon request		

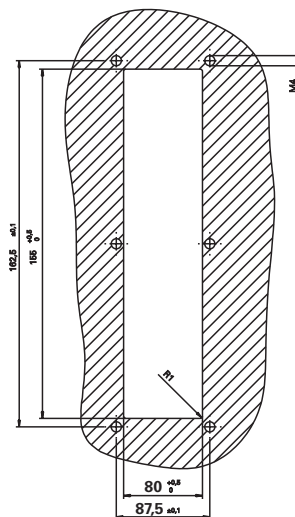

or bore hole
D = 3.8 mm for
self-tapping
screw
05.084.0212.0

Outer dimensions, cut-out and bore hole configuration are the same for all TM 6 versions

wiecon



12 slots,
in two rows of 6
3pole / 5pole =
type **TM 12-35**



TM 12 cover
fits all TM 12-XX pole configurations



Locking piece

Typ TM 12-55

Type	Part no.	Std. pack	Type	Part no.	Std. pack	Type	Part no.	Std. pack
TM 12-35 coding upon request		upon request	TM 12-XX	15.800.8856.0		3pole 4pole 5pole	05.562.5957.1 05.562.6557.1 05.562.8257.1	



In-line connector (insulation displacement connection)

Spacing: 5.00/5.08 mm

wiecon ASI

Rated cross section:
0.75 mm²

Rated current:
3 A

Connection range:
0.50 – 0.75 mm² fine stranded

250 V/4 kV/3 – Overvoltage category III
400 V/4 kV/2 – Overvoltage category II
1000 V/4 kV/1 – Overvoltage category I

Current range:
from 3 mA up to 3 A

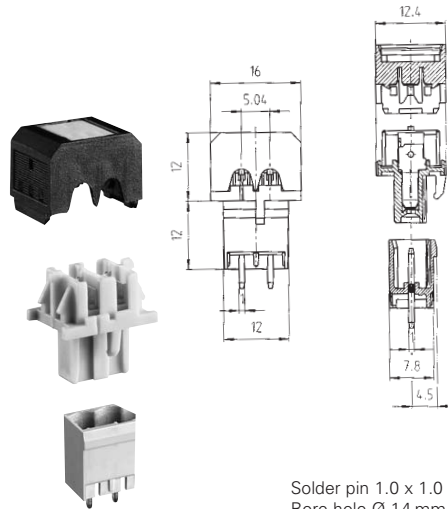

Typ 8113 BSK/2

Rated voltages VDE 0110

UL ratings field/factory wiring

CSA ratings

Approvals

No. 20 – 18 AWG

300 V

3 A

No. 20 – 18 AWG

300 V

3 A



	Type	Part no.	Std. pack
Spacing: 5.00/5.08 mm			
ASI in-line connector	2pole		
Cover	black	25.399.9853.0	100
Cover	yellow	25.399.9853.8	100
Cover	red	25.399.9853.5	100
	(color of plug housing: gray)		
Marking tag	green	04.240.0953.0	100

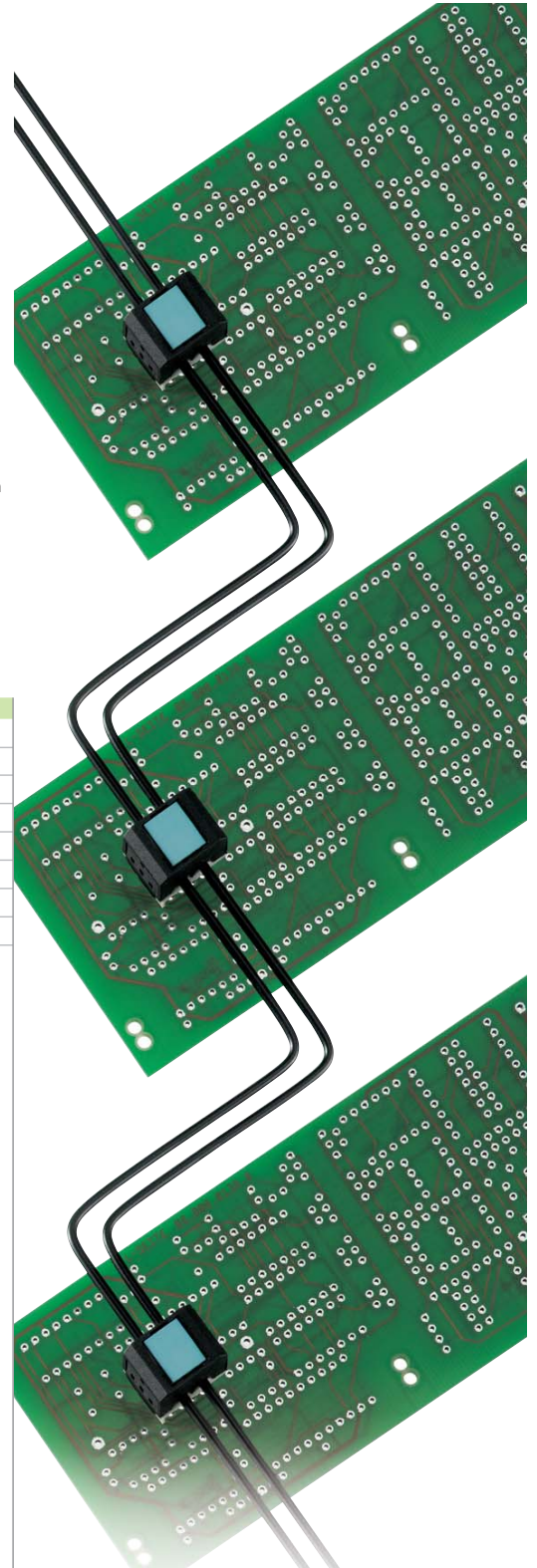

Cables with PVE- and PE-insulated wires can be connected. For others consult factory. The fine stranded copper conductor must have a minimum wire diameter of 0.2 mm. The wire design is based on DIN VDE 0295.

Insulated header for PC boards

Spacing: 5.00/5.08 mm



Rated current:
12 A

250 V/4 kV/3 – Overvoltage category III
400 V/4 kV/2 – Overvoltage category II
1000 V/4 kV/1 – Overvoltage category I

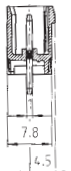

Solder pin 1.0 x 1.0 mm
Bore hole Ø 1.4 mm

Typ 8113 S/... G, 8213 S/... G

plug-in vertical to PC board

No. 22 – 12 AWG 250 V 15 A

No. 22 – 12 AWG 300 V 15 A



Rated voltages VDE 0110
UL ratings
CSA ratings
Approvals

Std. pack	G	T	Pole	Part no.
Spacing: 5.00 mm				
100	11.40	5	2	unmarked 25.330.3253.0
Spacing: 5.08 mm				
100	11.56	5.08	2	unmarked 25.350.3253.0

ASI in-line connector in insulation displacement technology

The ASI connector was developed for both ASI bus systems and LON and EIBA systems. In these systems, auxiliary supply and information are transferred via two wires of the bus line. The ASI in-line connector, a pluggable PC board connector with insulation displacement technology (IDC), facilitates the required signal tap-off from the actuator or sensor. Wiring of the ASI connector is both easy and effective. Both wires are inserted in the open clamping body of the connector and afterwards the cover is pressed on by means of a vertical closing tool. Connection to the printed circuit board is made by plugging it on to a 2 pole header.

Note:

Instead of the special ASI cable, much less expensive standard conductors are used.

Material:

Insulating housing: PA 66/6
CI-index: ≥ 600
Flammability class UL 94-V-0

Contact parts:

Plating: special copper alloy

Assembly:

Special tools for high-volume assembly upon request.



Marking accessories



Material:
Polyamide 66/6
Color: black numbers on white background





Marking strip Spacing: 10 mm

Marking tag 3-digit

Single tag

Marking strip Spacing: 10 mm

Type	Part no.	Std. pack	Type	Part no.	Std. pack	Type	Part no.	Std. pack
for 5 connectors, marked (every 2nd tag)			unmarked			unmarked		
9705 A/5/10/5 B	04.842.5553.0	25	9705 A	04.242.0850.0	500	9705 A/5/10	04.242.5053.0	25
			marked*			marked*		
			9705 AB	04.842.0850.0	500	9705 A/5/10 B	04.842.5053.0	25
						with extended marking surface		
						9705 AL/5/10	04.242.5153.0	25
			* Please indicate the required marking together with the part number!			* Please indicate the required marking together with the part number!		
			Standard pack = 500 tags			Standard pack = 25 strips = 250 tags		
								
Marking tag carrier for WEB empty housing			Marking tag 8 digits			Marking strip Spacing: 5 mm		
	04.242.1050.0	200	unmarked			9705 A/5/9 B		
			9705 AL	04.242.1553.0	500		04.842.4953.0	25
			marked*			Marking of the strips:		
			9705 ALB	04.842.1553.0	500	1 ... 9		
						1 ... 9		
			* Please indicate the required marking together with the part number!			Standard pack = 25 strips = 225 tags		
			Standard pack = 500 tags					

Tear-off marking strip with 10 marking tags

wiecon



Material: Polyamide 6/66 white/markings black	Marking per tree	Type	Part no.	Std. pack
unmarked		9704 A	04.241.1150.0	25
marked with the same number	1 1 1 1 1 1 1 1 1 1	9704 A/1 B	04.841.1150.0	25
	2 2 2 2 2 2 2 2 2 2	9704 A/2 B	04.841.1250.0	25
	3 3 3 3 3 3 3 3 3 3	9704 A/3 B	04.841.1350.0	25
	4 4 4 4 4 4 4 4 4 4	9704 A/4 B	04.841.1450.0	25
	5 5 5 5 5 5 5 5 5 5	9704 A/5 B	04.841.1550.0	25
	6 6 6 6 6 6 6 6 6 6	9704 A/6 B	04.841.1650.0	25
	7 7 7 7 7 7 7 7 7 7	9704 A/7 B	04.841.1750.0	25
	8 8 8 8 8 8 8 8 8 8	9704 A/8 B	04.841.1850.0	25
	9 9 9 9 9 9 9 9 9 9	9704 A/9 B	04.841.1950.0	25
	0 0 0 0 0 0 0 0 0 0	9704 A/0 B	04.841.2050.0	25
	marked with consecutive numbers	1 2 3 4 5 6 7 8 9 0	9704 A/1-0 B	04.841.2150.0
marked with the same capital letters	A A A A A A A A A A	9704 A/AG B	04.841.2250.0	25
	B B B B B B B B B B	9704 A/BG B	04.841.2350.0	25
	C C C C C C C C C C	9704 A/CG B	04.841.2450.0	25
	D D D D D D D D D D	9704 A/DG B	04.841.2550.0	25
	E E E E E E E E E E	9704 A/EG B	04.841.2650.0	25
	F F F F F F F F F F	9704 A/FG B	04.841.2750.0	25
	G G G G G G G G G G	9704 A/GG B	04.841.2850.0	25
	H H H H H H H H H H	9704 A/HG B	04.841.2950.0	25
	I I I I I I I I I I	9704 A/IG B	04.841.3050.0	25
	J J J J J J J J J J	9704 A/JG B	04.841.3150.0	25
	K K K K K K K K K K	9704 A/KG B	04.841.3250.0	25
	L L L L L L L L L L	9704 A/LG B	04.841.3350.0	25
	M M M M M M M M M M	9704 A/MG B	04.841.3450.0	25
	N N N N N N N N N N	9704 A/NG B	04.841.3550.0	25
	O O O O O O O O O O	9704 A/OG B	04.841.3650.0	25
	P P P P P P P P P P	9704 A/PG B	04.841.3750.0	25
	Q Q Q Q Q Q Q Q Q Q	9704 A/QG B	04.841.3850.0	25
	R R R R R R R R R R	9704 A/RG B	04.841.3950.0	25
	S S S S S S S S S S	9704 A/SG B	04.841.4050.0	25
	T T T T T T T T T T	9704 A/TG B	04.841.4150.0	25
	U U U U U U U U U U	9704 A/UG B	04.841.4250.0	25
	V V V V V V V V V V	9704 A/VG B	04.841.4350.0	25
	W W W W W W W W W W	9704 A/WG B	04.841.4450.0	25
	X X X X X X X X X X	9704 A/XG B	04.841.4550.0	25
	Y Y Y Y Y Y Y Y Y Y	9704 A/YG B	04.841.4650.0	25
	Z Z Z Z Z Z Z Z Z Z	9704 A/ZG B	04.841.4750.0	25
marked with the same lower case letters	a a a a a a a a a a	9704 A/AK B	04.841.4850.0	25
	b b b b b b b b b b	9704 A/BK B	04.841.4950.0	25
	c c c c c c c c c c	9704 A/CK B	04.841.5050.0	25
	d d d d d d d d d d	9704 A/DK B	04.841.5150.0	25
	e e e e e e e e e e	9704 A/EK B	04.841.5250.0	25
	f f f f f f f f f f	9704 A/FK B	04.841.5350.0	25
	g g g g g g g g g g	9704 A/GK B	04.841.5450.0	25
	h h h h h h h h h h	9704 A/HK B	04.841.5550.0	25
	i i i i i i i i i i	9704 A/IK B	04.841.5650.0	25
	j j j j j j j j j j	9704 A/JK B	04.841.5750.0	25
	k k k k k k k k k k	9704 A/KK B	04.841.5850.0	25
	l l l l l l l l l l	9704 A/LK B	04.841.5950.0	25
	m m m m m m m m m m	9704 A/MK B	04.841.6050.0	25
	n n n n n n n n n n	9704 A/NK B	04.841.6150.0	25
	o o o o o o o o o o	9704 A/OK B	04.841.6250.0	25
	p p p p p p p p p p	9704 A/PK B	04.841.6350.0	25
	q q q q q q q q q q	9704 A/QK B	04.841.6450.0	25
	r r r r r r r r r r	9704 A/RK B	04.841.6550.0	25
	s s s s s s s s s s	9704 A/SK B	04.841.6650.0	25
	t t t t t t t t t t	9704 A/TK B	04.841.6750.0	25
	u u u u u u u u u u	9704 A/UK B	04.841.6850.0	25
	v v v v v v v v v v	9704 A/VK B	04.841.6950.0	25
	w w w w w w w w w w	9704 A/WK B	04.841.7050.0	25
	x x x x x x x x x x	9704 A/XK B	04.841.7150.0	25
	y y y y y y y y y y	9704 A/YK B	04.841.7250.0	25
	z z z z z z z z z z	9704 A/ZK B	04.841.7350.0	25
marked with the same symbols	+ + + + + + + + + +	9704 A/+ B	04.841.7450.0	25
	- - - - - - - - - -	9704 A/- B	04.841.7550.0	25
	/ / / / / / / / / /	9704 A// B	04.841.7650.0	25
	9704 A/. B	04.841.7750.0	25
1 set of the same numbers = 10 x 25 strips = 2500 numbers	1 1 1 ... 0 0 0	111 to 000	04.841.9050.0	1
1 set of cap. letters = 26 x 25 strips = 6500 letters	A A A ... Z Z Z	A to Z GB	04.841.9150.0	1
1 set of lower case letters = 26 x 25 strips = 6500 letters	a a a ... z z z	a to z KB	04.841.9250.0	1



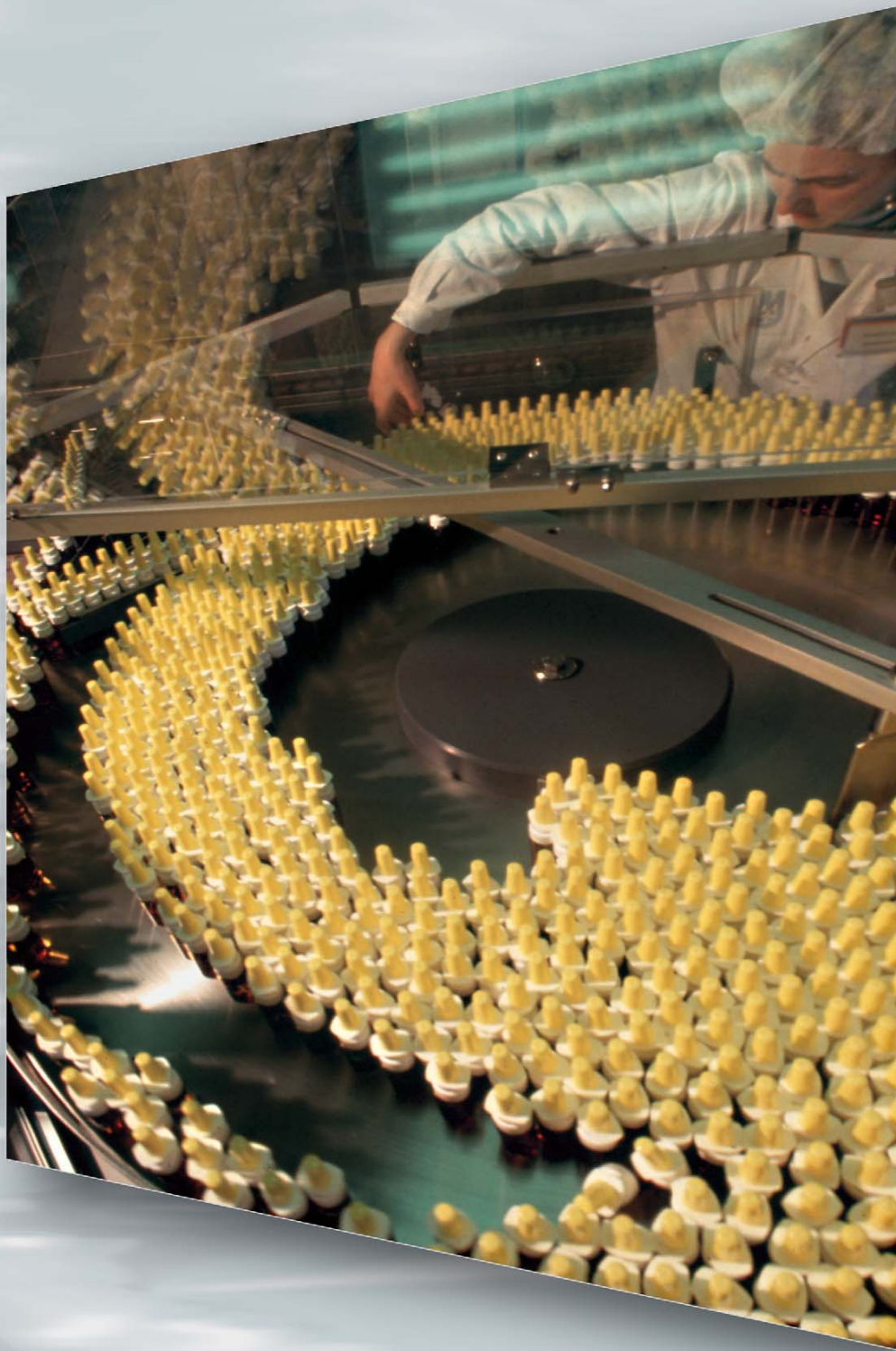



electronics

Electronic components

electronics

<p>Decentralised I/O module</p>	<p><i>ricos</i></p>	
<p>Relay module Terminal relay 6,2 mm</p> <p>Time relay</p> <p>Solid state relays</p>	<p><i>flare</i></p> <p>WEG RAB WR WRS</p> <p><i>flare</i> WRS</p> <p><i>flare</i> WRS M-PB</p>	
<p>Analog measurement technology Signal Conditioners</p> <p>Wieland Analog Systems</p>	<p><i>dipos</i></p> <p>cores AKB AKT UET UET-P KSQ / dipos^{KSQ}</p>	
<p>Wieland power Supply Switched mode power supply units</p>	<p><i>wipos</i> WPS NTU BGL FSR</p>	
<p>Wieland function module</p>	<p><i>cepos</i> TMS LPB / SBS SSM DNU / DSU DRA</p> <p>SSW</p>	
<p>Wieland interface system</p>	<p>D-SUB FLK S5</p>	
<p>Electronic empty housing</p>	<p><i>dipos</i> WEB WEB 1001/1002 WEG wieBOX</p> <p>Subject to change without prior notice</p>	

Content *electronics*

<ul style="list-style-type: none"> ● ● ricos ● ricos ● ricos ● ricos ● ricos ● ricos ● 	<ul style="list-style-type: none"> Introduction to field bus systems Field bus couplers Decentralised I/O module Binary I/O modules Function modules Analogue I/O- modules Compact modules General Data 	<ul style="list-style-type: none"> Page 404 Page 410 Page 412 Page 416 Page 422 Page 424 Page 428 Page 430
<ul style="list-style-type: none"> ● ● flare ● flare MOVE ● ● WEG ● RAB ● WR ● WRS ● ● flare ● WRS ● ● ● flare ● WRS ● M-PB ● 	<ul style="list-style-type: none"> Introduction to relay technology Mechanical terminal relay Plug-in terminal relay Single relay in enclosed housing Multipole relay modules 24 V Multipole relay modules 115 V / 230 V Wieland relay system Time relay 6,2 mm Time relay General data Introduction to solid state relay technology Solid state relay Solid state relay Multipole solid stat relay General data 	<ul style="list-style-type: none"> Page 438 Page 442 Page 444 Page 446 Page 454 Page 456 Page 460 Page 462 Page 463 Page 464 Page 477 Page 478 Page 479 Page 482 Page 488
<ul style="list-style-type: none"> ● ● dipos ● ● ● cores ● AKB ● AKT ● UET ● UET-P ● KSQ / dipos KSQ ● 	<ul style="list-style-type: none"> Introduction to analog measurement technology RTD/Pt100 / TC General data Instrument amplifier for RTD/Pt100 Analog conversion module Analog isolating module Isolating trip amplifier Isolating trip amplifier, isolated Constant voltage source General data 	<ul style="list-style-type: none"> Page 496 Page 498 Page 501 Page 502 Page 504 Page 505 Page 506 Page 507 Page 508 Page 510
<ul style="list-style-type: none"> ● ● wipos ● WPS ● NTU ● BGL ● FSR ● 	<ul style="list-style-type: none"> Introduction to <i>wipos</i> switch mode power supply units Single phase/three phase switched mode Power supply 24 V / 0,3-1 A Universal power transformer Rectifier module Fixed voltage regular General data 	<ul style="list-style-type: none"> Page 516 Page 518 Page 524 Page 525 Page 526 Page 528 Page 530
<ul style="list-style-type: none"> ● ● ceмос ● TMS ● LPB / SBS ● SSM ● DNU / DSU ● DRA ● ● ● SSW ● 	<ul style="list-style-type: none"> Introduction to <i>ceмос</i>/thermal overload/system monitoring Electronic contactors Thermistor overload relay Lamp test module/fuse module Centralised fault indication Three phase system monitoring / fuse monitoring Rotation indicator General data Introduction to SSW interface convertor Interface converter General data 	<ul style="list-style-type: none"> Page 536 Page 537 Page 539 Page 540 Page 541 Page 542 Page 543 Page 544 Page 552 Page 553 Page 555
<ul style="list-style-type: none"> ● ● D-SUB ● FLK ● S5 ● 	<ul style="list-style-type: none"> Introduction to interface modules D-SUB on screw terminal IDC header on screw terminal Interface modules and I/O plug system for Siemens S5 General data 	<ul style="list-style-type: none"> Page 559 Page 560 Page 561 Page 562 Page 570
<ul style="list-style-type: none"> ● ● dipos ● WEB ● WEB 1001/1002 ● WEG ● wieBOX ● Electronic empty housing ● 	<ul style="list-style-type: none"> Introduction to empty housing systems General data 	<ul style="list-style-type: none"> Page 578 Page 580 Page 584 Page 588 Page 592 Page 594 Page 596 Page 600

Decentralised I/O Modules

ricos

Introduction to field bus systems

Field bus couplers

Digital I/O's

Function modules

Analogue I/O's

Compact module

General data

ricos offers

- Field bus couplers for all major field bus systems
- Freely configurable modules for digital/analogue systems
- Modular assembly of field bus nodes
- Spring-clamp terminal for secure and rapid connection
- Economy bus couplers
- Components can be replaced without disconnecting the wiring
- High degree of EMC resistance due to integrated earth connection to the mounting rail
- Compact housing dimensions
- Universal labelling

All Wieland Components which require **CE** general certification are **CE** certified, and identified with the **CE** logo.

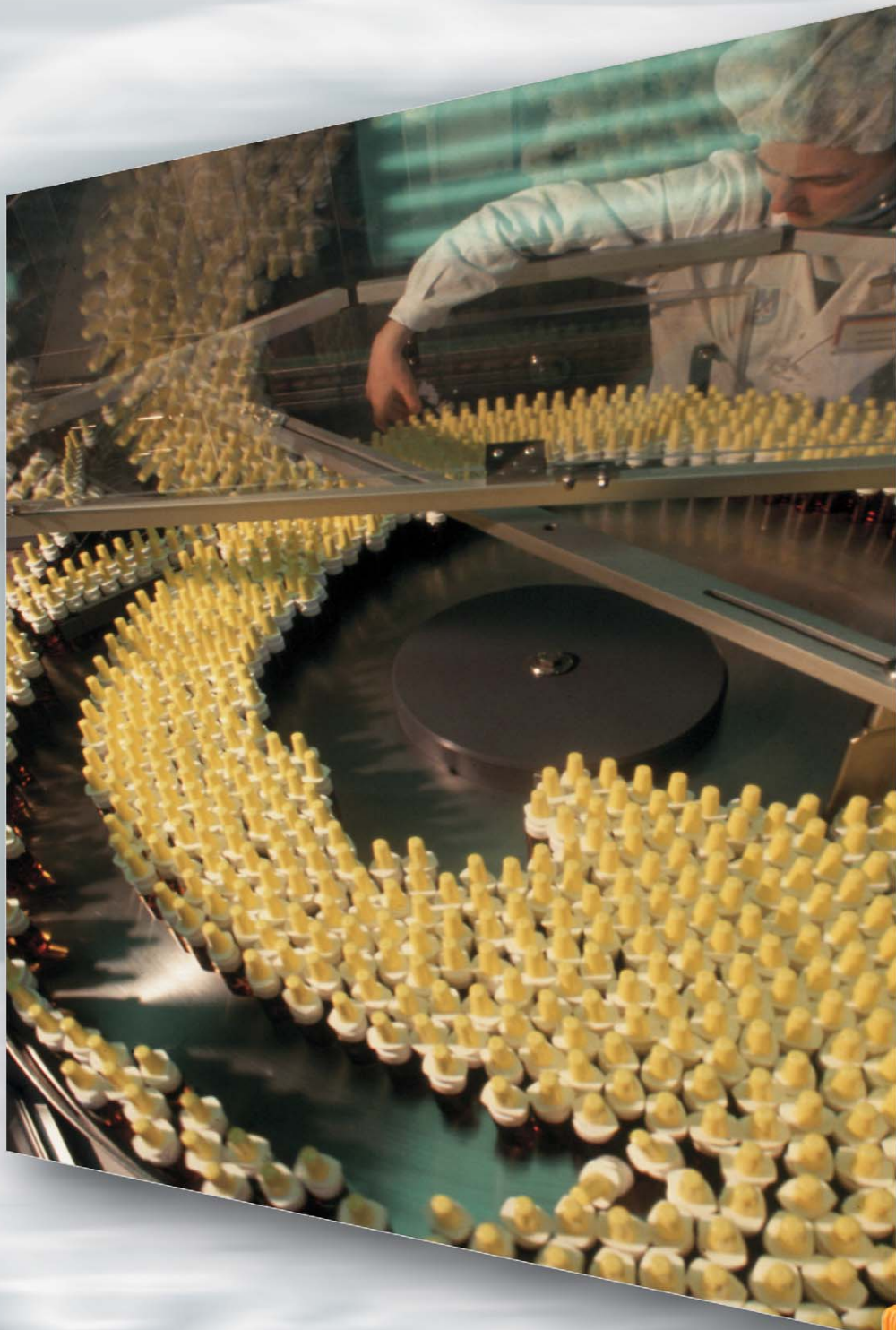

electronics



Electronic Components

Decentralised I/O module

Living with the variety and competition of the fieldbus systems

ricos

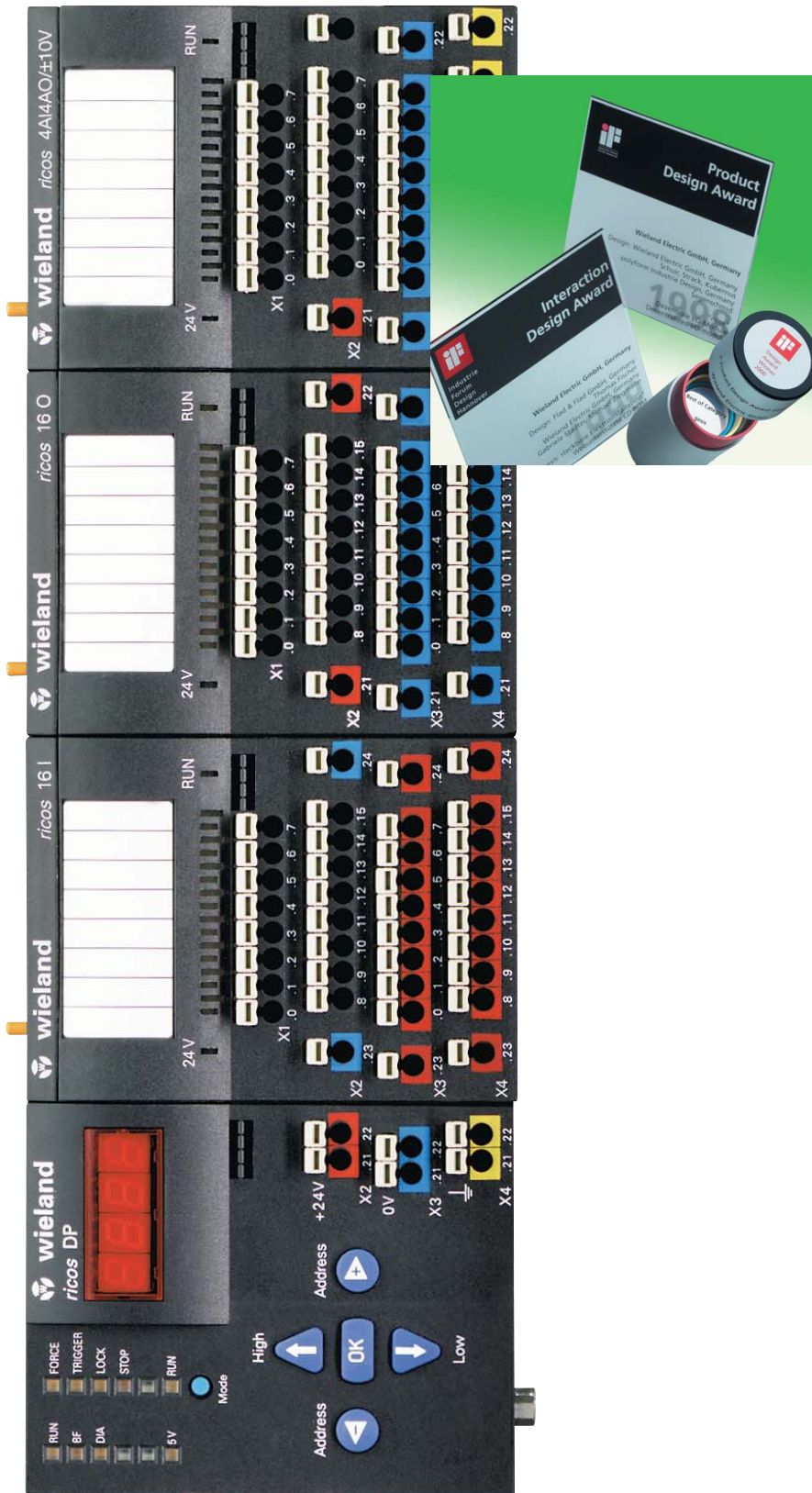

One of the remarkable features of a fieldbus system is its higher performance levels as compared to traditional wiring technology. A key advantage of fieldbus technology is that signal processing is possible in field devices, allowing intelligence to be distributed into the field.

A great number of functional and topological variations are available in today's market. This wide variety of hardware and protocols has formed due to the many different application requirements, company preferences, and the regulatory environment.

Wieland, as a globally active company, meets all fieldbus requirements and – with the **ricos** system – offers the user a universal system:

- Fieldbus couplers for all major fieldbus systems
- Freely configurable modules for binary and analog signals
- Modular-type combined fieldbus nodes
- The diagnosis tools integrated into the buscoupler provide start-up functions such as Force, Trigger and Lock without requiring further software
- Complete range of functionalities
- Spring cage clamp terminals for fast and safe connections
- Economy buscoupler to operate all functionalities
- Replacing function cards without disconnecting the wires
- High EMI resistance due to integrated diversion to the mounting rail
- Compact housing dimensions
- Consistent marking

ricos in use at Winkler+Dünnebier

ricos



Heathrow airport:
ricos insures proper luggage routing



Saving space and costs in paper manufacturing



Getting fit with **ricos** – fast and safe

A key feature of the **ricos** remote I/O system is its high level of reliability. This reliability level is the result of the quality of the electronic components used in the system, as well as the advanced techniques used during the manufacturing process. It is the combination of this reliability and resulting safety record which has convinced our customers to use the **ricos** system.

One such customer, Winkler+Dünnebier, manufactures special machinery for the production of envelopes and hygiene items. The company is the international market leader in these sectors. In paper manufacturing alone their marketshare is approximately two thirds of the global market. When developing their "hygiene" business division W+D were in unknown territory as most manufactures of this type product had traditionally built all of their own machinery. The way they were able to change this custom and gain their

international leadership position was through the revolutionary way they built their machines.

W+D decided to produce the machines for their hygiene division using a modular concept. This design allowed for a high degree of flexibility and individual end product options.

During one machine development project, W+D was searching for a distributed connection of actuator and sensor technology via PROFIBUS.

Using this system they wanted to bring their modular concepts to cover not only the mechanical aspects, but also the control technology of their machines. After comparing all available I/O systems, wieland's **ricos** system was chosen for use in the hygienes division. For a manufacturer of special purpose machines the block design of the **ricos**

modules is a better fit than the slice design. Since the exact number of inputs and outputs cannot be planned in advance it is necessary to plan on reserve channels. For this reason, **ricos** modules were of great interest, as its channels can be used both as inputs and outputs. The decisive factor for choosing the **ricos** system was its clear and easy to use wiring system.

Technical information on bus systems

ricos

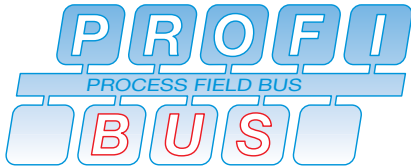

PROFIBUS DP (distributed I/Os), defined in DIN 19 245, part 3, and integrated in the European field bus standard EN 20 170, is a PROFIBUS variant with an optimized transmission rate to serve the needs of the object-oriented system sector and the sensor-actuator sector. It is designed to fit the requirements of the fast, efficient data exchange between the automation devices and the distributed devices such as binary or analog input/output modules and drives in timesensitive applications,

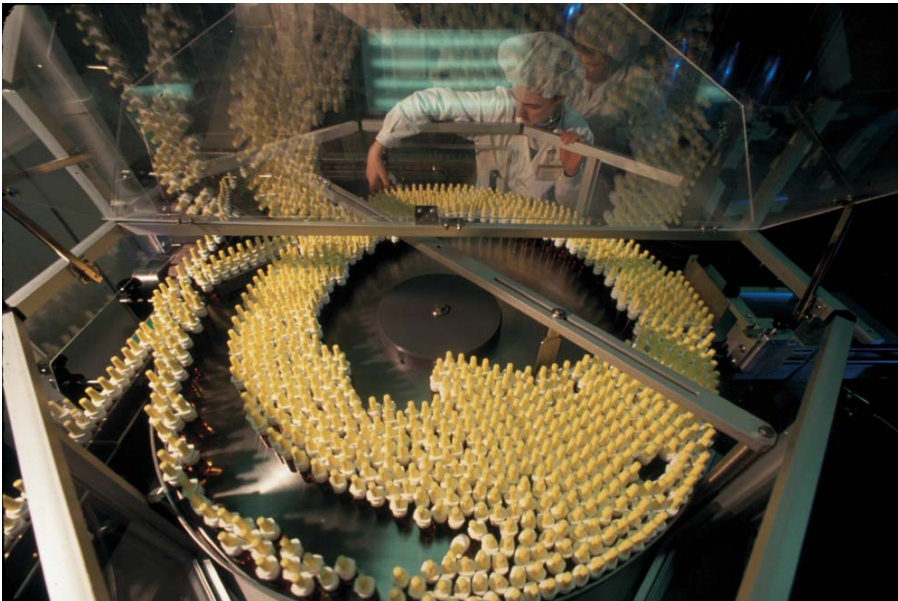

while the layer 7 service is not used. This shift of PROFIBUS DP into the field level enables cost savings in cabling. The field bus PROFIBUS DP is not new, but uses well-proven characteristics of the PROFIBUS transmission technology and the bus access protocol (DIN 19245, part 1 and 2). It is reduced by certain functions in order to meet the high requirements of the system responsetime in the field of distributed I/O devices.

It is also possible to operate PROFIBUS FMS and PROFIBUS DP in one single cable. And there are especially interesting options when using so-called combination devices which use the characteristics of both variants.

The remarkable features of PROFIBUS DP are:

- Short response times
- High immunity
- Replaces the cost-intensive measured value transmission by a 0(4) to 20mA technology

Data transfer via distributed devices (slaves) is mainly done cyclically in the master-slave procedure. The central control system (master) reads the input information of the slaves and writes the output data to the slaves. PROFIBUS DP V1 also supports, among others the acyclic data interchange PROFIBUS DP operates with a transmission rate of up to 12 Mbits/s and enables the transmission of 1024 bit input/output data distributed among 32 nodes in less than 2 ms.

Characteristics:

- Line structure (with passive bus coupling)
- Max. length of 9.6 km in an electrical installation; up to 90 km in an optical one
- Area-covering networking by subdividing the system in 5 bus segments (via repeater) of up to 1.5 Mbit/s
- Number of the repeaters used and therefore the transmission distance depending on the baud rate
- Max. 124 nodes (throughout all bus segments), max. 32 nodes per segment
- Bus access in the token passing procedure; normal operation only with a master and polling request
- High transmission rate (real-time capability of PLCs is the major motive for DP)
- Data transmission via two-wire cable or optical fibre (active bus coupling)
- Electrical installation with screened, twisted-pair cable and RS485 interface
- Bit coding in NRZ code (non return to zero)
- I/O and field devices can be coupled and uncoupled during operation
- Extensive diagnostic options
- Open system (DIN E 19 245; EN 50 170)

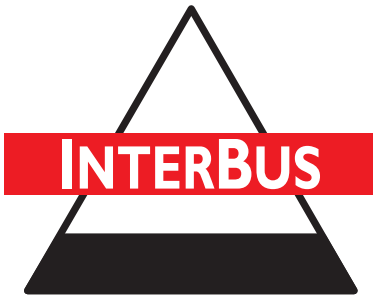

The INTERBUS system was developed especially for machine system applications and fast processes.

This fieldbus system is therefore mainly used in automated manufacturing on system level, and as object-oriented fieldbus used to connect sensors and actuators. Standard PLC applications and industrial PC applications are possible with a minimum of costs and effort [Phoe97] [BaMü98].



The INTERBUS is set up from point-to-point connections as actively coupled ring. The bus nodes use separate lines each in both directions. This avoids a return from the last to the first node as usually required in ring-connected systems. The forward and return lines are both carried in one cable. This makes the INTERBUS resemble a public service bus in terms of installation, as only one cable is drawn from node to node. A complete bus system is thus implemented with different bus nodes, called interface module, bus coupler, bus network devices and local bus devices.

An interface module (master) operates as central unit for data communication in the bus network. The interface module also connects the INTERBUS system with the higher-level control system. The remote bus network can be set up with max. 512 stations and max. 400 m distance

between 2 nodes with a data transmission rate of 500 kbit/s. The RS485 standard is used for data transmission on a two-wire line. The remote bus nodes are all equipped with a separate auxiliary power supply and function as repeaters due to their active couplings, thus enabling long distances. They are furthermore electrically isolated from the advancing INTERBUS segment. Remote bus nodes are both input/output devices and couplers of lower-level sub-rings. There are also mixed versions, the so-called I/O bus couplers.

As INTERBUS does not define any addresses for the nodes in the protocol, the max. number of bus nodes is determined by the master firmware. Implemented firmware allows up to 512 remote bus network nodes. In theory, a distance of 102 km is therefore possible for an INTERBUS system using copper wires. However, a max. system expansion of 13 km is currently guaranteed only. Longer distances can be achieved by using other transfer media such as fiber optic cables which currently allow total expansions of 100 km.

Characteristics:

- Ring-type structure with active node coupling
- Bus network with max. 512 nodes, max. distance of 400 m, max. total expansion of 13 km with copper cables, and 100 km with fiber optic cable
- Local bus with 8 nodes, max. distance of 1.5 m, max. total expansion of 10 m
- Node addressing according to their order assignment in the ring
- Transmission rate: Bus network with 500 kbit/s, local bus with 300 kbit/s
- Bus network using an interface based on RS485 two-wire technology
- Local bus using CMOS level, and 4 wire pairs for transmission
- Possible degree of protection up to IP 65
- High data security; several protection mechanisms (such as CRC)
- Open system (DIN E 19 258; EN 50 254)

Technical information on bus systems

revos BASIC

CAN

In 1983 the automotive industry phrased their demand for a bus system to be used in motor vehicles. An electrical two-wire bus was to replace the extensive cable harnesses used to connect electrical systems. This was absolutely necessary, as the classical cable harnesses in motor vehicles had already reached lengths of more than 2 km and a weight over 100 kg. Requirements came up that could not be met by the bus systems available at that time.

In 1985 the solution in form of the Controller Area Network (CAN) was presented. CAN was developed in a cooperation between Robert Bosch GmbH and INTEL Semiconductor. In the meantime, CAN has gained a wide field of applications, not only in the motor vehicle technology, but also in the automation technology. Nowadays we find CAN in mobile systems, as machine-internal or system-internal communication system, in production automation, in the bottom field segment of process automation, even in building instrumentation and control, and in many other applications.

Since 1992 the user organization CiA (CAN in automation) has existed. More than 200 manufacturers and users of automation devices, sensors, actuators, software and services are participating in it [Trum95]. CAN is internationally standardized in ISO 11898 and is therefore an open bus system.

The reason for the widespread acceptance of CAN lies not only in the mentioned performance features, but especially also in the availability of very low-cost circuits due to the high quantities guaranteed in the automotive industry [Law2/97]. Characteristics:

- Line structure (with passive bus coupling)
- Number of nodes limited by the performance of the driver modules only
- Expansion depending on the transmission rate 40 m at 1 Mbit/s; 1000 m at 50 kbit/s
- Twisted-pair cables with terminating resistors and optical fibre
- Object-oriented messages, broadcasting and multicasting with acceptance check
- Multi-master network
- Bus access via bit-by-bit arbitration according to the CSMA/CA procedure; real-time capable for high-priority messages
- Max. transmission rate of 1 Mbit/s
- Very high data security (HD = 6); error detection and error signaling; automatic power-off of defect stations (node guarding)
- Different chips and micro-controllers support the protocol
- Open system (ISO 11898 and CiA DS 301)



The major requirements:

- High protection against electromagnetic interference
- Real-time capability for fast procedures such as ignition and ABS
- High reliability
- Favorable price for large batch applications

Preferred areas of application

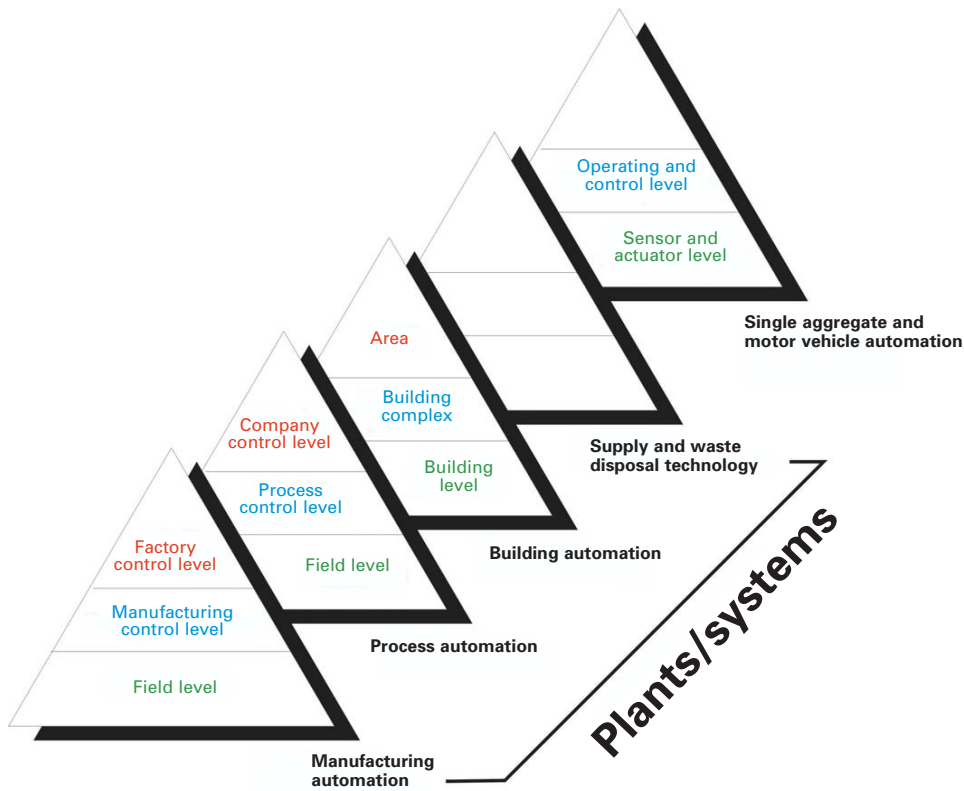

electronics

	Plant – (System) Automation					Stand-alone automation	
Communication levels	Production (solid goods)	Process (gas, fluid, steam...)	Building	Supply and waste disposal	Environment monitoring	Machines devices aggregates	vehicles, means of transport
WAN Wide Area Network	high-speed glass fibre (FDDI), Internet (www)						
LAN Local Area Network	Industry-Ethernet						
	MMS-Companion Standard: Robot, NC, PLC	MMS-Companion Standard: Process, Control					
FAN (Field bus)-system level	PROFIBUS (FMS) FP INTERBUS MODBUS FF (IEC NORM)	PROFIBUS (FMS) FP P-NET ARCNET FF (IEC NORM)	PROFIBUS (FMS) LON	PROFIBUS (FMS) DIN MESSBUS	PROFIBUS (FMS) DIN MESSBUS		
Object-oriented system level	PROFIBUS (DP) INTERBUS CAN SERCOS	PROFIBUS (DP) HART (BUS) BITBUS CAN	LON EIB CAN	DIN MESSBUS	DIN MESSBUS	PROFIBUS (DP) INTERBUS SERCOS	CAN P NET
Sensor/actuator-system level	AS-INTERFACE INTERBUS-LOOS	HART (PKT/PKT) PROFIBUS PA	EIB M-BUS Ebus	DIN MESSBUS M-BUS	DIN MESSBUS	AS-INTERFACE INTERBUS-LOOS M-BUS Ebus	

Operating and display functions

ricos

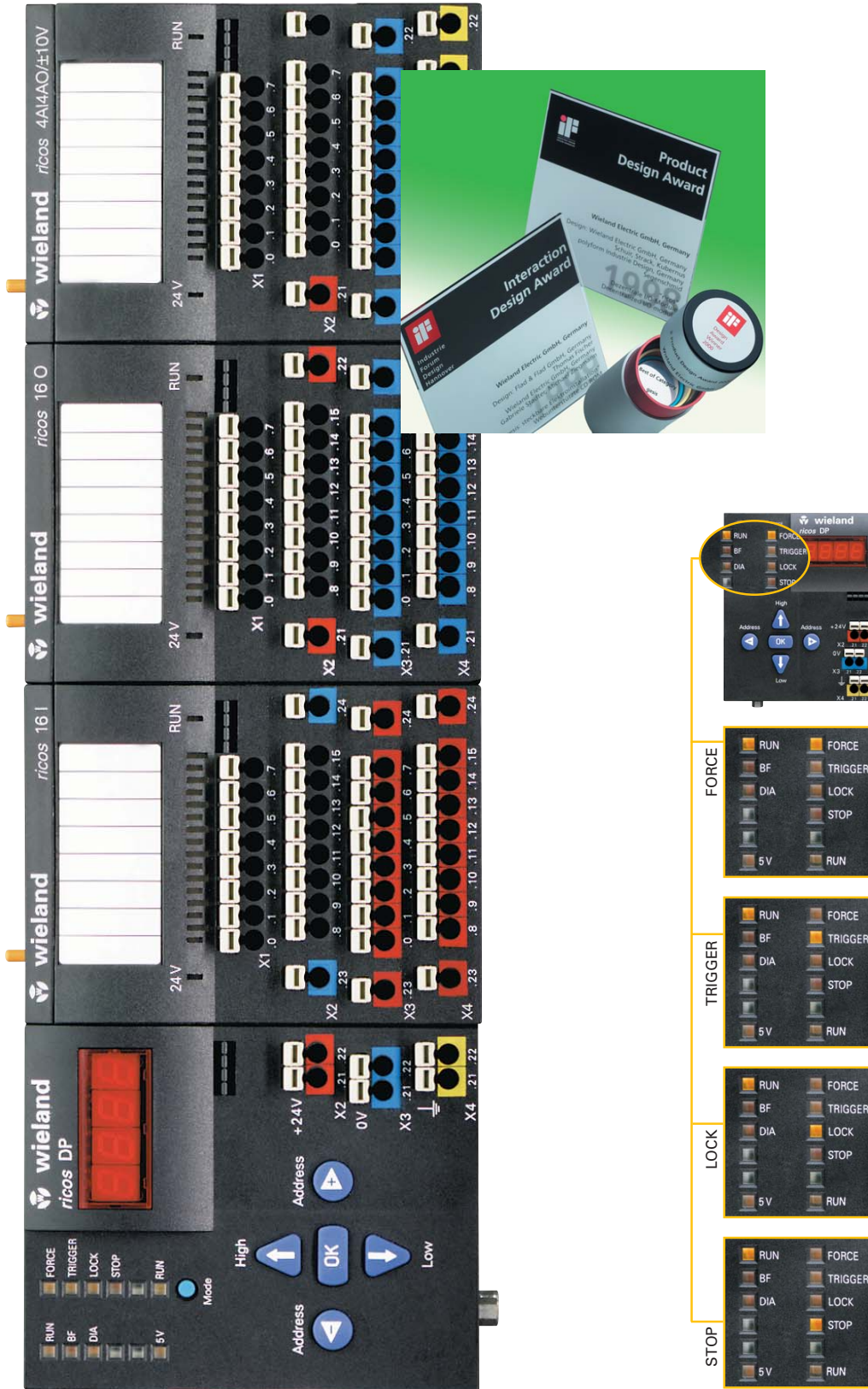

With or without a fieldbus being connected (offline), binary and analog I/O channels can be operated manually.
 → in the FORCE mode

The last 20 process images of the node can be recorded and displayed
 → in the TRIGGER mode

Analog and binary I/O channels can be freely chosen and “frozen” to a defined switching status in order to simulate certain elements of the system.
 → in the LOCK mode

The outputs are switched off and the inputs are faded out.
 → STOP mode.

Economy buscoupler compact modules

ricos

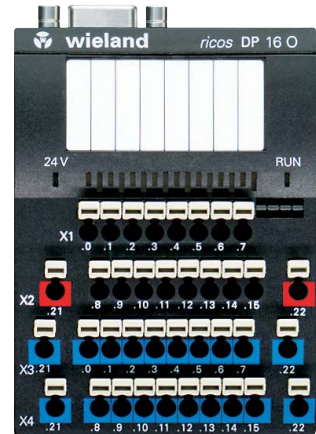

Would you like to ...

- ...use more than one fieldbus?
- ...reduce your start-up times?
- ...simulate signals offline – on site without programming unit?
- ...set I/Os without PLC?
- ...read analog values on site?
- Start-up without field bus connection
- Troubleshooting on site
- Displaying signal states of all inputs and outputs for binary and analog values

... then use the **ricos** bus coupler with operating and display functionality!

The **ricos** buscoupler provides you with:

- Connection to the most common fieldbus systems such as PROFIBUS DP, Interbus, CANopen and DeviceNet
- Modules for fast mounting to DIN rails or panel mount
- Wiring with spring connectors
- Supplied with open clamping body
- Module wiring at the front
- Pluggable potential distributors on the module
- Compact module dimensions
- Up to 8 modules can be connected to a bus coupler in line, enabling up to 128 I/O signals per bus node
- Electronics can be replaced without disconnecting the wiring

If you do not require the operating and display functionality of the standard **ricos** buscoupler ...

... then we recommend our **ricos** economy buscoupler.

If your control requirements are more complex ...

... then we can offer you our **ricos** compact modules.

ricos compact modules

- 4 compact module types each used for digital signal sensing in the fieldbus systems:
- PROFIBUS DP
 - Interbus
 - CANopen
 - DeviceNet
- All modules are slaves with buscoupler functionality
- Efficient and space-saving extension for only a few I/Os

Distributed I/O Modules

Buscoupler

ricos

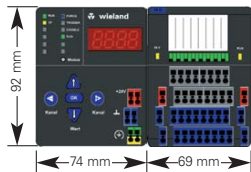

Depth: 51 mm
(incl. mounting rail TS 35/7.5 mm)

Dimensions (mm): W x H x D
74 x 92 x 51



Modular buscoupler PROFIBUS DP

CE; Approvals: UL, Profibus certification



Modular bus coupler Interbus

CE; Approvals: UL, Interbus certification

Description	Type	Part no.	Std. pack	Type	Part no.	Std. pack
Buscoupler with diagnosis function	BC DP	83.030.0000.1	1	BC S	83.031.0000.1	1
	Mode display:			Mode display:		
	FORCE mode: LED yellow			FORCE mode: LED yellow		
	TRIGGER mode: LED yellow			TRIGGER mode: LED yellow		
	LOCK mode: LED yellow			LOCK mode: LED yellow		
	STOP mode: LED yellow			STOP mode: LED yellow		
	RUN mode: LED green			RUN mode: LED green		
Wiring diagrams, derating curves	see page 430			see page 430		
System data						
Max. number of nodes	126			256		
Transmission medium	screened copper cable 2 x 0.25 mm ² /AWG 23			screened copper cable 5 x 0.25 mm ² /AWG 23		
Max. network expansion	100 m–1200 m (depending on baud rate/cable)			400 m (remote bus)		
Baud rate	9.6 kBaud...12 Mbaud			500 kBaud		
Internal bus refresh	2 ms			2 ms		
Bus connection	1 x D-SUB 9, screened female connector			2 x D-SUB 9, screened female and male connectors		
Technical information						
Max. number of I/O bytes	64 E-Byte/64 A-Byte			64 E-Byte/64 A-Byte		
Number of I/O modules per node	8			8		
Number of digital I/O points per node	128			128		
Number of analog I/O points per node	32			32		
Address setting	3...126 (via keyboard)			automatically as per system		
Stet	PC or PLC			PC or PLC		
Operating voltage	24 V DC, ±20%, max. 5% residual ripple			24 V DC, ±20%, max. 5% residual ripple		
Current input	< 125 mA (at 24 V and without I/O modules) < 500 mA (at 24 V with I/O modules)			< 125 mA (at 24 V and without I/O modules) < 500 mA (at 24 V with I/O modules)		
Insulation voltage	350 V AC, 50 Hz (system / supply)			350 V AC, 50 Hz (system / supply)		
Creepage distances and clearances	DIN EN 61131-2; DIN EN 50178			DIN EN 61131-2; DIN EN 50178		
Electrostatic discharge	EN 61000-4-2; 8 kV air; 4 kV contact			EN 61000-4-2; 8 kV air; 4 kV contact		
Electromagnetic fields	ENV 50140; 10 V/m; 30...1000 MHz			ENV 50140; 10 V/m; 30...1000 MHz		
Immunity / emitted interference	EN 61000-6-2/EN 55011, limit value class A, group 1			EN 61000-6-2/EN 55011, limit value class A, group 1		
Burst	2 kV accord. to DIN EN 61000-4-4			2 kV accord. to DIN EN 61000-4-4		
Connection style	spring connection			spring connection		
Cross-sectional area- fine stranded / solid	26 –14 AWG / 26 –16 AWG			26 –14 AWG / 26 –16 AWG		
Ambient temperature	0 °C...+55 °C (accord. to DIN 40040)			0 °C...+55 °C (accord. to DIN 40040)		
Storage temperature	–25 °C...+75 °C (accord. to DIN 40040)			–25 °C...+75 °C (accord. to DIN 40040)		
Bus-specific status display	RUN LED green		RUN	RUN LED green		RUN
	bus error LED red		BF	remote bus disabled LED red		RD
	diagnosis LED red		DIA	remote bus connected LED green		RC
	operating voltage LED green		5 V	bus access LED green		BA
				operating voltage LED green		5 V
Accessories						
Bus connector, vertical	83.030.0010.0 (node)			83.031.0010.0 (input line)		
Bus connector, vertical	83.030.0011.0 (termination)			83.031.0010.0 (output line)		
Bus connector, horizontal (pending)	83.030.0012.0 (switch)					
Manual, German	05.591.3389.0			05.591.3389.0		
Manual, English	05.562.1389.0			05.562.1389.0		
GSD file and Word template for labels	05.591.3255.0			05.591.3255.0		
Marking tag, 8-digit, unmarked	04.242.1553.0			04.242.1553.0		
Marking tag, 8-digit, marked (upon request)						
End clamp for DIN rail	Z5.522.8553.0			Z5.522.8553.0		

ricos



**Modular buscoupler
DeviceNet**
CE; Approvals:



**Modular buscoupler
CANopen**
CE; Approvals: in preparation

Dimensions (mm): W x H x D
74 x 92 x 51

Description	Type	Part no.	Std. pack	Type	Part no.	Std. pack
Buscoupler with diagnosis function	BC-DEVICENET	83.032.0000.1	1	BC-CANOPEN	83.033.0000.1	1
Mode display:	incl. 1 busconnector			incl. 1 busconnector		
	FORCE mode: LED yellow			FORCE mode: LED yellow		
	TRIGGER mode: LED yellow			TRIGGER mode: LED yellow		
	LOCK mode: LED yellow			LOCK mode: LED yellow		
	STOP mode: LED yellow			STOP mode: LED yellow		
	RUN mode: LED green			RUN mode: LED green		
Wiring diagrams, derating curves	see page 430			see page 430		
System data						
Max. number of nodes	64 with repeater			256		
Transmission medium	screened copper cable trunk line AWG 15, 18 screened copper cable drop line AWG 22, 24			screened copper cable 3 x 0.25 mm ² /AWG 23		
Max. network expansion	100 m–500 m (depending on baud rate / cable)			100 m–500 m (depending on baud rate / cable)		
Baud rate	125/250/500 kBaud (setting via keyboard)			10 kBaud...1 MBaud (setting via keyboard)		
Internal bus refresh	2 ms			2 ms		
Bus connection	5pole connector, screw			5pole connector, screw		
Technical information						
Max. number of I/O bytes	64 E-Byte/64 A-Byte			9 R-PDOs; 9 T-PDOs		
Number of I/O modules per node	8			6		
Number of digital I/O points per node	128			96		
Number of analog I/O points per node	32			24		
Address setting (MAC ID)	1...63 (via keyboard)			1...126 (via keyboard)		
Stet	PC or PLC			PC or PLC		
Operating voltage	24 V DC, ±20%, max. 5% residual ripple			24 V DC, ±20%, max. 5% residual ripple		
Current input	< 125 mA (at 24 V and without I/O modules) < 500 mA (at 24 V with I/O modules)			< 125 mA (at 24 V and without I/O modules) < 500 mA (at 24 V with I/O modules)		
Insulation voltage	350 V AC, 50 Hz (system/supply)			350 V AC, 50 Hz (system / supply)		
Creepage distances and clearances	DIN EN 61131-2; DIN EN 50178			DIN EN 61131-2; DIN EN 50178		
Electrostatic discharge	EN 61000-4-2; 8 kV air; 4 kV contact			EN 61000-4-2; 8 kV air; 4 kV contact		
Electromagnetic fields	ENV 50140; 10 V/m; 30...1000 MHz			ENV 50140; 10 V/m; 30...1000 MHz		
Immunity / emitted interference	EN 61000-6-2/EN 55011, limit value class A, group 1			EN 61000-6-2/EN 55011, limit value class A, group 1		
Burst	2 kV accord. to DIN EN 61000-4-4			2 kV accord. to DIN EN 61000-4-4		
Connection style	spring connection			spring connection		
Cross-sectional area-fine stranded / solid	26 – 14 AWG / 26 – 16 AWG			26 – 14 AWG / 26 – 16 AWG		
Ambient temperature	0 °C...+55 °C (accord. to DIN 40040)			0 °C...+55 °C (accord. to DIN 40040)		
Storage temperature	–25 °C...+75 °C (accord. to DIN 40040)			–25 °C...+75 °C (accord. to DIN 40040)		
Bus-specific status display	RUN LED green			RUN LED green		
	status to master LED green/red			network status LED green/red		
	ready for operation LED green/red			module status LED green/red		
	operating voltage LED green			operating voltage LED green		
Accessories						
Bus connector	25.323.3501.0			25.323.3501.0		
Manual, German	05.591.3389.0			05.591.3389.0		
Manual, English	05.562.1389.0			05.562.1389.0		
EDS file and Word template for labels	05.591.3255.0			05.591.3255.0		
Marking tag, 8-digit, unmarked	04.242.1553.0			04.242.1553.0		
Marking tag, 8-digit, marked (upon request)						
End clamp for DIN rail	Z5.522.8553.0			Z5.522.8553.0		

Ethernet Buscoupler Module

ricos

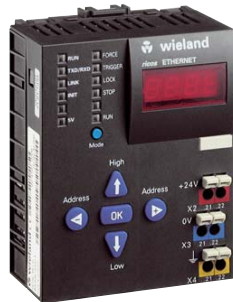

Modular Buscoupler Ethernet TCP/IP

CE; Approvals: CE, cUL_{US} pending

Dimensions (mm): W x H x D 74 x 92 x 51
(incl. mounting rail TS 35; DIN EN 60715)

Description	Type	Part no.	Std. pack	Type	Part no.	Std. pack
Buscoupler with diagnostic features	BC-Ethernet	83.034.0000.1	1			
Mode display:						
	FORCE mode: LED yellow					
	TRIGGER mode: LED yellow					
	LOCK mode: LED yellow					
	STOP mode: LED yellow					
	RUN mode: LED green					
System Data						
Max. number of nodes	limited by Ethernet specifications					
Transmission medium	CAT5 twisted pair 10/100 base T					
Protocols	MODBUS/TCP, HTTP, Boot-P					
Baud rate	10/100 Mbit/Autodetection					
Internal Bus Refresh	2 ms					
Bus connection	RJ 45					
Technical Information						
Max. number of I/O Bytes	64 E-Byte/64 A-Byte					
Max. number of I/O modules per node	8					
Max. number of digital I/O points per node	128					
Max. number of analog I/O points per node	32					
Address setting	keypad & Boot P					
Configuration	PC/PLC					
Power Input	24 V DC ±20%, max 5% residual ripple					
Power Consumption	<3.5 W (without I/O module)					
Isolation voltage	350 V AC, 50 Hz (system/supply)					
Creepage distances and clearances	DIN EN 61131-2; DIN EN 50178					
Electrostatic discharge	EN 61000-4-2; 8 KV air; KV contact					
Electromagnetic fields	ENV 50140; 10 V/m; 30 ... 1000 MHz					
Immunity/emittedinterference	EN 50082-2/EN 55011, limit value class A, group 1					
Burst	2 kV accord. to DIN EN 61000-4-4					
Connection Style	spring connection					
Cross-section area fine stranded/solid	0.14 – 1.5 mm ² / 26-14 AWG / 0,5 – 2,5 mm ² / 26-16 AWG					
Ambient temperature	0° C ... +55° C					
Storage temperature	-25° C ... +70° C					
Bus-specific status display	RUN	LED yellow	RUN			
	Operating voltage	LED green	TxD/RxD			
	Net Available	LED green	LINK			
	Operating voltage	LED yellow	5 V			
	Fieldbus not initiated	LED red	INIT			
Accessories						
Bus connector, vertical						
Bus connector, vertical						
Bus connector, horizontal (pending)						
Manual, German		05.591.3389.0				
Manual, English		05.562.1389.0				
GSD file and Word template for labels		05.591.3255.0				
Marking tag, 8-digit, unmarked		04.242.1553.0				
Marking tag, 8-digit, marked (upon request)						
End Clamp for DIN rail		Z5.522.8553.0				

ricos

electronics

Distributed I/O Modules

Buscoupler

ricos

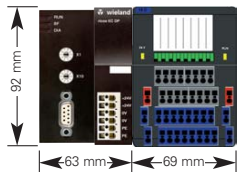

Depth: 51 mm
(incl. mounting rail TS 35/7.5 mm)

Dimensions (mm): W x H x D
63 x 92 x 51



Modular economy buscoupler PROFIBUS DP

CE; Approvals: US, Profibus certification in preparation



Modular economy buscoupler Interbus

CE; Approvals: US, Interbus certification in preparation

Description	Type	Part no.	Std. pack	Type	Part no.	Std. pack
Economy buscoupler	EC DP	83.030.0001.1	1	EC S	83.031.0001.1	1
Mode display	RUN – processor operating LED yellow BF – no bus connected (bus fail): LED red DIA – diagnosis message sent off: LED red			RUN – processor operating LED yellow RD - remote bus disabled LED red RC - remote bus connected LED green BA – bus access LED green		
Wiring diagrams, derating curves	see page 430			see page 430		
System data						
Max. number of nodes	126			256		
Transmission medium	screened copper cable 2 x 0.25 mm ² /AWG 23			screened copper cable 5 x 0.25 mm ² /AWG 23		
Max. network expansion	100 m–1200 m (depending on baud rate / cable)			400 m (remote bus)		
Baud rate	9.6 kBaud...12 Mbaud			500 kBaud		
Internal bus refresh	2 ms			2 ms		
Bus connection	1 x D-SUB 9, screened female connector			2 x D-SUB 9, screened female and male connectors		
Technical information						
Max. number of I/O bytes	64 E-Byte/64 A-Byte			64 E-Byte/64 A-Byte		
Number of I/O modules per node	8			8		
Number of digital I/O points per node	128			128		
Number of analog I/O points per node	32			32		
Address setting	3...126 (switch)			automatically as per system		
Stet	PC or PLC			PC or PLC		
Operating voltage	24 V DC, ±20%, max. 5% residual ripple			24 V DC, ±20%, max. 5% residual ripple		
Current input	< 125 mA (at 24 V and without I/O modules) < 500 mA (at 24 V with I/O modules)			< 125 mA (at 24 V and without I/O modules) < 500 mA (at 24 V with I/O modules)		
Insulation voltage	350 V AC, 50 Hz (system / supply)			350 V AC, 50 Hz (system / supply)		
Creepage distances and clearances	DIN EN 61131-2; DIN EN 50178			DIN EN 61131-2; DIN EN 50178		
Electrostatic discharge	EN 61000-4-2; 8 kV air; 4 kV contact			EN 61000-4-2; 8 kV air; 4 kV contact		
Electromagnetic fields	ENV 50140; 10 V/m; 30...1000 MHz			ENV 50140; 10 V/m; 30...1000 MHz		
Immunity / emitted interference	EN 61000-6-2/EN 55011, limit value class A, group 1			EN 61000-6-2/EN 55011, limit value class A, group 1		
Burst	2 kV accord. to DIN EN 61000-4-4			2 kV accord. to DIN EN 61000-4-4		
Connection style	spring connection			spring connection		
Cross-sectional area-fine stranded / solid	26 – 14 AWG / 26 – 16 AWG			26 – 14 AWG / 26 – 16 AWG		
Ambient temperature	0 °C...+55 °C (accord. to DIN 40040)			0 °C...+55 °C (accord. to DIN 40040)		
Storage temperature	–25 °C...+75 °C (accord. to DIN 40040)			–25 °C...+75 °C (accord. to DIN 40040)		
Accessories						
Bus connector, vertical	83.030.0010.0 (node)			83.031.0010.0 (input line)		
Bus connector, vertical	83.030.0011.0 (termination)			83.031.0010.0 (output line)		
Bus connector, horizontal (pending)	83.030.0012.0 (switch)					
Manual, German	05.591.3389.0			05.591.3389.0		
Manual, English	05.562.1389.0			05.562.1389.0		
GSD file and Word template for labels	05.591.3255.0			05.591.3255.0		
Marking tag, 8-digit, unmarked	04.242.1553.0			04.242.1553.0		
Marking tag, 8-digit, marked (upon request)						
End clamp for DIN rail	Z5.522.8553.0			Z5.522.8553.0		

ricos



Modular economy buscoupler DeviceNet

CE; Approvals: in preparation

Modular economy buscoupler CANopen

CE; Approvals: in preparation

Dimensions (mm): W x H x D
63 x 92 x 51

Description	Type	Part no.	Std. pack	Type	Part no.	Std. pack
Buscoupler with diagnosis function	EC-DEVICENET	83.032.0001.1	1	EC-CANOPEN	83.033.0001.1	1
	incl. 1 busconnector			incl. 1 busconnector		
Mode display:	RUN – processor operating LED yellow			RUN – processor operating LED yellow		
	NET - status display to master LED green/red			NET - status display to master LED green/red		
	MOD – ready for operation LED green/red			MOD – ready for operation LED green/red		
Wiring diagrams, derating curves	see page 430			see page 430		
System data						
Max. number of nodes	64 with repeater			256		
Transmission medium	screened copper cable trunk line AWG 15, 18 screened copper cable drop line AWG 22, 24			screened copper cable 3 x 0.25 mm ² /AWG 23		
Max. network expansion	100 m–500 m (depending on baud rate / cable)			100 m–500 m (depending on baud rate / cable)		
Baud rate	125/250/500 kBaud (DIP switch)			10 kBaud...1 MBaud (DIP switch)		
Internal bus refresh	2 ms			2 ms		
Bus connection	5pole connector, screw			5pole connector, screw		
Technical information						
Max. number of I/O bytes	64 E-Byte/64 A-Byte			9 R-PDOs; 9 T-PDOs		
Number of I/O modules per node	8			6		
Number of digital I/O points per node	128			96		
Number of analog I/O points per node	32			24		
Address setting (MAC ID)	1...63 (via keyboard)			1...126 (via keyboard)		
Stet	PC or PLC			PC or PLC		
Operating voltage	24 V DC, ±20 %, max. 5 % residual ripple			24 V DC, ±20 %, max. 5 % residual ripple		
Current input	< 125 mA (at 24 V and without I/O modules) < 500 mA (at 24 V with I/O modules)			< 125 mA (at 24 V and without I/O modules) < 500 mA (at 24 V with I/O modules)		
Insulation voltage	350 V AC, 50 Hz (system / supply)			350 V AC, 50 Hz (system / supply)		
Creepage distances and clearances	DIN EN 61131-2; DIN EN 50178			DIN EN 61131-2; DIN EN 50178		
Electrostatic discharge	EN 61000-4-2; 8 kV air; 4 kV contact			EN 61000-4-2; 8 kV air; 4 kV contact		
Electromagnetic fields	ENV 50140; 10 V/m; 30...1000 MHz			ENV 50140; 10 V/m; 30...1000 MHz		
Immunity / emitted interference	EN 61000-6-2/EN 55011, limit value class A, group 1			EN 61000-6-2/EN 55011, limit value class A, group 1		
Burst	2 kV accord. to DIN EN 61000-4-4			2 kV accord. to DIN EN 61000-4-4		
Connection style	spring connection			spring connection		
Cross-sectional area-fine stranded / solid	26 – 14 AWG / 26 – 16 AWG			26 – 14 AWG / 26 – 16 AWG		
Ambient temperature	0 °C...+55 °C (accord. to DIN 40040)			0 °C...+55 °C (accord. to DIN 40040)		
Storage temperature	–25 °C...+75 °C (accord. to DIN 40040)			–25 °C...+75 °C (accord. to DIN 40040)		
Accessories						
Bus connector	25.323.3501.0			25.323.3501.0		
Manual, German	05.591.3389.0			05.591.3389.0		
Manual, English	05.562.1389.0			05.562.1389.0		
EDS file and Word template for labels	05.591.3255.0			05.591.3255.0		
Marking tag, 8-digit, unmarked	04.242.1553.0			04.242.1553.0		
Marking tag, 8-digit, marked (upon request)						
End clamp for DIN rail	Z5.522.8553.0			Z5.522.8553.0		

Specifications are subject to change without notice

Distributed I/O Modules

ricos

Binary I/O modules

Configurable as input or output,
for 2-wire, 3-wire and 4-wire connections
Electronic components can be replaced
without disconnecting the wiring



**Binary I/O module 24 V DC
8 inputs or 8 outputs**
CE; Approvals: UL is



**Binary I/O module 24 V DC
16 inputs**
CE; Approvals: UL is

Dimensions (mm): W x H x D
69 x 92 x 51

Description	Type	Part no.	Std. pack	Type	Part no.	Std. pack
	ricos 8 I/O	83.035.3100.1	1	ricos 16 I	83.035.3000.1	1
Mode display:						
	24 V – supply voltage connected: LED yellow			24 V – supply voltage connected: LED yellow		
	RUN – internal data transmission in progress: LED yellow			RUN – internal data transmission in progress: LED yellow		
	channel LED – switching status: LED green			channel LED – switching status: LED green		
	channel LED – channel cursor: LED yellow			channel LED – channel cursor: LED yellow		
Wiring diagrams, derating curves	see pages 431 – 434			see pages 431 – 434		
Module data						
Number of inputs	max. 8			16		
Number of outputs	max. 8			0		
Operating voltage	24 V DC, $\pm 20\%$, max. 5% residual ripple			24 V DC, $\pm 20\%$, max. 5% residual ripple		
Power input	< 0.5 W			< 0.5 W		
Stet	not required			not required		
Required space on control side	1 input byte/1output byte			2 input byte		
Input data						
Switching level "0" (EN 61131-2)	-30 V...+5 V DC			-30 V...+5 V DC		
Switching level "1" (EN 61131-2)	+15 V...+30 V DC			+15 V...+30 V DC		
Input current/channel (at 24 V DC)	6.1 mA			4.5 mA		
Status display	LED green			LED green		
Output data						
Output voltage	operating voltage - 0.5 V DC					
Output current per channel	1000 mA DC					
Max. total current per module	8 A DC					
Simultaneity	100%					
Load types	resistive, inductive					
Status display	LED green					
Output response	resistant to overload and short-circuit					
General						
Signal delay per I/O channel	< 100 μ s			< 100 μ s		
Max. voltage power contacts	30 V DC			30 V DC		
Max. current power contacts	8 A DC			8 A DC		
Insulation voltage	350 V AC, 50 Hz (system/supply)			350 V AC, 50 Hz (system/supply)		
Creepage distances and clearances	DIN EN 61131-2; DIN EN 50178			DIN EN 61131-2; DIN EN 50178		
Electrostatic discharge	EN 61000-4-2; 8 KV air; 4 KV contact			EN 61000-4-2; 8 KV air; 4 KV contact		
Electromagnetic fields	ENV 50140; 10 V/m; 30...1000 MHz			ENV 50140; 10 V/m; 30...1000 MHz		
Immunity / emitted interference	EN 61000-6-2/EN 55011, limit value class A, group 1			EN 61000-6-2/EN 55011, limit value class A, group 1		
Burst	accord. to EN 61000-4-4			accord. to EN 61000-4-4		
Connection style	spring connection			spring connection		
Cross-sectional area-fine stranded / solid	26 – 14 AWG / 26 – 16 AWG			26 – 14 AWG / 26 – 16 AWG		
Ambient temperature	0 °C...+55 °C (accord. to DIN 40040)			0 °C...+55 °C (accord. to DIN 40040)		
Storage temperature	-25 °C...+75 °C (accord. to DIN 40040)			-25 °C...+75 °C (accord. to DIN 40040)		
Accessories						
Snap-on potential distributor for 3-wire and 4-wire operation	83.039.0000.1			83.039.0000.1		
Adhesive labels, DIN A4 sheet	05.591.3255.0			05.591.3255.0		
2pole jumper for parallel output switching	Z7.258.1225.0			Z7.258.1225.0		
Marking tag, 8-digit, unmarked	04.242.1553.0			04.242.1553.0		
Marking tag, 8-digit, marked (upon request)						
End clamp for DIN rail	Z5.522.8553.0			Z5.522.8553.0		
Manual, English	05.562.1389.0			05.562.1389.0		

ricos



**Binary I/O module 115 V AC
4 inputs**

CE; Approvals: cULus in preparation



**Binary I/O module 230 V AC
4 inputs**

CE; Approvals: cULus in preparation

Dimensions (mm): W x H x D
69 x 92 x 51

Description	Type	Part no.	Std. pack	Type	Part no.	Std. pack
	ricos 4I 115 V	83.035.5000.1	1	ricos 4I 230 V	83.035.5005.1	1
Mode display:						
	24 V – supply voltage connected: LED yellow			24 V – supply voltage connected: LED yellow		
	RUN – internal data transmission in progress: LED yellow			RUN – internal data transmission in progress: LED yellow		
	channel LED – switching status: LED green			Channel LED – switching status: LED green		
	channel LED – channel cursor: LED yellow			Channel LED – channel cursor: LED yellow		
Wiring diagrams, derating curves	see pages 431 – 434			see pages 431 – 434		
Module data						
Number of inputs	4			4		
Number of outputs	0			0		
Operating voltage	115 V AC, $\pm 10\%$			230 V AC, $\pm 10\%$		
Power input	< 0.5 W			< 0.5 W		
Stet	not required			not required		
Required space on control side	1 input byte			1 input byte		
Input data						
Switching level "0" (EN 61131-2)	0 V...20 V AC			0 V...40 V AC		
Switching level "1" (EN 61131-2)	79 V...130 V AC			164 V...250 V AC		
Input current / channel (at 24 V DC)	typically 5 mA			typically 5 mA		
Status display	LED green			LED green		
Output data:						
Output voltage						
Output current per channel						
Max. total current per module						
Simultaneity						
Load types						
Status display						
Output response						
General						
Signal delay per I/O channel	max. 10 ms			max. 10 ms		
Max. voltage power contacts	250 V AC			250 V AC		
Max. current power contacts	8 A AC			8 A AC		
Insulation voltage	350 V AC, 50 Hz (system / supply)			350 V AC, 50 Hz (system / supply)		
Creepage distances and clearances	DIN EN 61131-2; DIN EN 50178			DIN EN 61131-2; DIN EN 50178		
Electrostatic discharge	EN 61000-4-2; 8 KV air; 4 KV contact			EN 61000-4-2; 8 KV air; 4 KV contact		
Electromagnetic fields	ENV 50140; 10 V/m; 30...1000 MHz			ENV 50140; 10 V/m; 30...1000 MHz		
Immunity / emitted interference	EN 61000-6-2/EN 55011, limit value class A, group 1			EN 61000-6-2/EN 55011, limit value class A, group 1		
Burst	accord. to EN 61000-4-4			accord. to EN 61000-4-4		
Connection style	spring connection			spring connection		
Cross-sectional area-fine stranded / solid	26 – 14 AWG / 26 – 16 AWG			26 – 14 AWG / 26 – 16 AWG		
Ambient temperature	0 °C...+55 °C (accord. to DIN 40040)			0 °C...+55 °C (accord. to DIN 40040)		
Storage temperature	-25 °C...+75 °C (accord. to DIN 40040)			-25 °C...+75 °C (accord. to DIN 40040)		
Accessories						
Snap-on potential distributor for 3-wire and 4-wire operation	83.039.0000.1			83.039.0000.1		
Adhesive labels, DIN A4 sheet	05.591.3255.0			05.591.3255.0		
2pole jumper for parallel output switching	Z7.258.1225.0			Z7.258.1225.0		
Marking tag, 8-digit, unmarked	04.242.1553.0			04.242.1553.0		
Marking tag, 8-digit, marked (upon request)						
End clamp for DIN rail	Z5.522.8553.0			Z5.522.8553.0		
Manual, English	05.562.1389.0			05.562.1389.0		

Specifications are subject to change without notice

Distributed I/O Modules

ricos

Binary I/O modules

for 2-wire, 3-wire and 4-wire connections

Electronic components can be replaced
without disconnecting the wiring



Binary I/O module, 4 relay outputs

CE; Approvals: in preparation

Dimensions (mm): W x H x D
69 x 92 x 51

Description	Type	Part no.	Std. pack
	ricos 4O RELAY	83.035.5200.1	1
Mode display:			
	24 V – supply voltage connected: LED yellow		
	RUN – internal data transmission in progress: LED yellow		
	channel LED – switching status: LED green		
	channel LED – channel cursor: LED yellow		
Wiring diagrams, derating curves	see pages 431 – 434		
Module data			
Number of inputs	0		
Number of outputs	4		
Operating voltage	24 V DC, ±20 %, max. 5 % residual ripple		
Power input	< 1 W		
Stet	not required		
Required space on control side	1 output byte		
Input data			
Switching level "0" (EN 61131-2)			
Switching level "1" (EN 61131-2)			
Input current/channel (at 24 V DC)			
Status display			
Output data:			
Output voltage	250 V AC, 30 V DC		
Output current per channel	5 A AC/DC		
Max. total current per module	12 A AC/DC		
Simultaneity	100 %		
Load types	resistive / inductive		
Status display	LED green		
Output response			
General			
Signal delay per I/O channel	< 10 ms		
Max. voltage power contacts	250 V AC/DC		
Max. current power contacts	8 A AC/DC		
Insulation voltage	350 V AC, 50 Hz (system / supply)		
Creepage distances and clearances	DIN EN 61131-2; DIN EN 50178		
Electrostatic discharge	EN 61000-4-2; 8 KV air; 4 KV contact		
Electromagnetic fields	ENV 50140; 10 V/m; 30...1000 MHz		
Immunity / emitted interference	EN 61000-6-2/EN 55011, limit value class A, group 1		
Burst	accord. to EN 61000-4-4		
Connection style	spring connection		
Cross-sectional area-fine stranded / solid	26 – 14 AWG / 26 – 16 AWG		
Ambient temperature	0 °C...+55 °C (accord. to DIN 40040)		
Storage temperature	-25 °C...+75 °C (accord. to DIN 40040)		
Accessories			
Snap-on potential distributor for 3-wire and 4-wire operation	83.039.0000.1		
Adhesive labels, DIN A4 sheet	05.591.3255.0		
2pole jumper for parallel output switching	Z7.258.1225.0		
Marking tag, 8-digit, unmarked	04.242.1553.0		
Marking tag, 8-digit, marked (upon request)			
End clamp for DIN rail	Z5.522.8553.0		
Manual, English	05.562.1389.0		

ricos

Binary I/O modules

Configurable as input or output,
for 2-wire, 3-wire and 4-wire connections

Electronic components can be replaced
without disconnecting the wiring



**Binary module
16 outputs**
CE; Approvals:



**Binary I/O module 8 inputs and
8 inputs/outputs**
CE; Approvals:

Dimensions (mm): W x H x D
69 x 92 x 51

Description	Type	Part no.	Std. pack	Type	Part no.	Std. pack
	ricos 16O	83.035.3200.1	1	ricos 8I 8/O	83.035.3300.1	1
Mode display:						
	24 V – supply voltage connected: LED yellow			24 V – supply voltage connected: LED yellow		
	RUN – internal data transmission in progress: LED yellow			RUN – internal data transmission in progress: LED yellow		
	channel LED – switching status: LED green			channel LED – switching status: LED green		
	channel LED – channel cursor: LED yellow			channel LED – channel cursor: LED yellow		
Wiring diagrams, derating curves	see pages 431 – 434			see pages 431 – 434		
Module data						
Number of inputs	0			8 + max. 8		
Number of outputs	16			max. 8		
Operating voltage	24 V DC, ±20%, max. 5% residual ripple			24 V DC, ±20%, max. 5% residual ripple		
Power input	< 0.5 W			< 0.5 W		
Stet	not required			not required		
Required space on control side	2 output byte			2 input byte and 1 output byte		
Input data						
Switching level "0" (EN 61131-2)				-30 V...+5 V DC		
Switching level "1" (EN 61131-2)				+15 V...+30 V DC		
Input current / channel (at 24 V DC)				4.5 mA/6.5 mA (combin. I/O)		
Status display				LED green		
Output data:						
Output voltage	operating voltage – 0.5 V DC			operating voltage – 0.5 V DC		
Output current per channel	1000 mA DC			1000 mA DC		
Max. total current per module	8 A DC			8 A DC		
Simultaneity	50%			100%		
Load types	resistive, inductive			resistive, inductive		
Status display	LED green			LED green		
Output response	resistant to overload and short-circuit			resistant to overload and short-circuit		
General						
Signal delay per I/O channel	< 100 µs			< 100 µs		
Max. voltage power contacts	30 V DC			30 V DC		
Max. current power contacts	8 A DC			8 A DC		
Insulation voltage	350 V AC, 50 Hz (system / supply)			350 V AC, 50 Hz (system / supply)		
Creepage distances and clearances	DIN EN 61131-2; DIN EN 50178			DIN EN 61131-2; DIN EN 50178		
Electrostatic discharge	EN 61000-4-2; 8 KV air; 4 KV contact			EN 61000-4-2; 8 KV air; 4 KV contact		
Electromagnetic fields	ENV 50140; 10 V/m; 30...1000 MHz			ENV 50140; 10 V/m; 30...1000 MHz		
Immunity / emitted interference	EN 61000-6-2/EN 55011, limit value class A, group 1			EN 61000-6-2/EN 55011, limit value class A, group 1		
Burst	accord. to EN 61000-4-4			accord. to EN 61000-4-4		
Connection style	spring connection			spring connection		
Cross-sectional area-fine stranded / solid	26 – 14 AWG / 26 – 16 AWG			26 – 14 AWG / 26 – 16 AWG		
Ambient temperature	0 °C...+55 °C (accord. to DIN 40040)			0 °C...+55 °C (accord. to DIN 40040)		
Storage temperature	-25 °C...+75 °C (accord. to DIN 40040)			-25 °C...+75 °C (accord. to DIN 40040)		
Accessories						
Snap-on potential distributor for 3-wire and 4-wire operation	83.039.0000.1			83.039.0000.1		
Adhesive labels, DIN A4 sheet	05.591.3255.0			05.591.3255.0		
2pole jumper for parallel output switching	Z7.258.1225.0			Z7.258.1225.0		
Marking tag, 8-digit, unmarked	04.242.1553.0			04.242.1553.0		
Marking tag, 8-digit, marked (upon request)						
End clamp for DIN rail	Z5.522.8553.0			Z5.522.8553.0		
Manual, English	05.562.1389.0			05.562.1389.0		

Specifications are subject to change without notice

Distributed I/O Modules

ricos

Binary I/O modules

for 2-wire, 3-wire and 4-wire connections

Electronic components can be replaced without disconnecting the wiring



**Binary I/O module 24 V DC
4 outputs 2 A DC**

CE; Approvals: in preparation



**Binary I/O module 24 V DC
8 outputs, negative switching**

CE; Approvals: in preparation

Dimensions (mm): W x H x D
69 x 92 x 51

Description	Type	Part no.	Std. pack	Type	Part no.	Std. pack
	ricos 4O DC 2A	83.035.3005.1	1	ricos 8O NEG	83.035.3210.1	1
Mode display:						
	24 V – supply voltage connected: LED yellow			24 V – supply voltage connected: LED yellow		
	RUN – internal data transmission in progress: LED yellow			RUN – internal data transmission in progress: LED yellow		
	channel LED – switching status: LED green			channel LED – switching status: LED green		
	channel LED – channel cursor: LED yellow			channel LED – channel cursor: LED yellow		
Wiring diagrams, derating curves	see pages 431 – 434			see pages 431 – 434		
Module data						
Number of inputs	0			0		
Number of outputs	4			8		
Operating voltage	24 V DC, ±20 %, max. 5 % residual ripple			24 V DC, ±20 %, max. 5 % residual ripple		
Power input	< 0.5 W			< 0.5 W		
Stet	not required			not required		
Required space on control side	1 output byte			1 output byte		
Input data						
Switching level "0" (EN 61131-2)						
Switching level "1" (EN 61131-2)						
Input current / channel (at 24 V DC)						
Status display						
Output data						
Output voltage	operating voltage –0.5 V DC			operating voltage –0.5 V DC		
Output current per channel	2 A DC			1000 mA DC		
Max. total current per module	8 A DC			8 A DC		
Simultaneity	100 %			100 %		
Load types	resistive, inductive			resistive, inductive		
Status display	LED green			LED green		
Output response	resistant to overload and short-circuit			resistant to overload and short-circuit		
General						
Signal delay per I/O channel	< 100 µs			< 100 µs		
Max. voltage power contacts	30 V DC			30 V DC		
Max. current power contacts	8 A DC			8 A DC		
Insulation voltage	350 V AC, 50 Hz (system / supply)			350 V AC, 50 Hz (system / supply)		
Creepage distances and clearances	DIN EN 61131-2; DIN EN 50178			DIN EN 61131-2; DIN EN 50178		
Electrostatic discharge	EN 61000-4-2; 8 KV air; 4 KV contact			EN 61000-4-2; 8 KV air; 4 KV contact		
Electromagnetic fields	ENV 50140; 10 V/m; 30...1000 MHz			ENV 50140; 10 V/m; 30...1000 MHz		
Immunity / emitted interference	EN 61000-6-2/EN 55011, limit value class A, group 1			EN 61000-6-2/EN 55011, limit value class A, group 1		
Burst	accord. to EN 61000-4-4			accord. to EN 61000-4-4		
Connection style	spring connection			spring connection		
Cross-sectional area-fine stranded / solid	26 – 14 AWG / 26 – 16 AWG			26 – 14 AWG / 26 – 16 AWG		
Ambient temperature	0 °C...+55 °C (accord. to DIN 40040)			0 °C...+55 °C (accord. to DIN 40040)		
Storage temperature	–25 °C...+75 °C (accord. to DIN 40040)			–25 °C...+75 °C (accord. to DIN 40040)		
Accessories						
Snap-on potential distributor for 3-wire and 4-wire operation	83.039.0000.1			83.039.0000.1		
Adhesive labels, DIN A4 sheet	05.591.3255.0			05.591.3255.0		
2pole jumper for parallel output switching	Z7.258.1225.0			Z7.258.1225.0		
Marking tag, 8-digit, unmarked	04.242.1553.0			04.242.1553.0		
Marking tag, 8-digit, marked (upon request)						
End clamp for DIN rail	Z5.522.8553.0			Z5.522.8553.0		
Manual, English	05.562.1389.0			05.562.1389.0		

Distributed I/O Modules

ricos

Counter/positioning modules

2 or 4 counters per module
up to 2 threshold values can be set

Positioning module for 2 axes

Electronic components can be replaced
without disconnecting the wiring



Binary I/O module
2–32 bit / 4–16 bit counter
CE; Approvals: UL in preparation



Binary I/O module,
positioning module
CE; Approvals: UL in preparation

Dimensions (mm): W x H x D
69 x 92 x 51

Description	Type	Part no.	Std. pack	Type	Part no.	Std. pack
	ricos COUNTER	83.035.5400.1	1	ricos POSITION	83.035.5410.1	1
Mode display:						
	24 V – supply voltage connected: LED yellow			24 V – supply voltage connected: LED yellow		
	RUN – internal data transmission in progress: LED yellow			RUN – internal data transmission in progress: LED yellow		
	channel LED – switching status: LED green			channel LED – switching status: LED green		
	channel LED – channel cursor: LED yellow			channel LED – channel cursor: LED yellow		
Wiring diagrams, derating curves	see page 434			see page 434		
Module data						
Number of ...	counters: 4 x 16 Bit or 2 x 32 Bit			controllable axes: 2		
Counting range	0 to 2 ¹⁶ or 0 to 2 ³²			–2 ³¹ up to 2 ³¹ –1		
Number of inputs/outputs	12/4 or 6/4			10/6		
Counting frequency	200 Hz, 2 kHz, 20 kHz, 200 kHz configurable			max. 200 kHz		
Configurable	via PC or PLC			via PC or PLC		
Required space on control side	3 to 5 words			5 words		
Input data						
Switching level "0" (EN 61131-2)	–30 V...+5 V DC			–30 V...+5 V DC		
Switching level "1" (EN 61131-2)	+15 V...+30 V DC			+15 V...+30 V DC		
Input current / channel (at 24 V DC)	7.5 mA			7.5 mA		
Status display	LED green			LED green		
Output data:						
Output voltage	operating voltage –0.5 V DC			operating voltage –0.5 V DC		
Output current per channel	1000 mA DC			1000 mA DC		
Max. total current per module	4 A DC			6 A DC		
Simultaneity	100 %			100 %		
Load types	resistive, inductive			resistive, inductive		
Status display	LED green			LED green		
Output response	resistant to overload and short-circuit			resistant to overload and short-circuit		
Operating voltage / power input	24 V DC, ±20 %, max. 5 % residual ripple/< 3 W			24 V DC, ±20 %, max. 5 % residual ripple/< 3 W		
General						
Signal delay input/output	< 1 us/< 300 µs			< 100 µs		
Max. voltage power contacts	30 V DC			30 V DC		
Max. current power contacts	8 A DC			8 A DC		
Insulation voltage	350 V AC, 50 Hz (system / supply)			350 V AC, 50 Hz (system / supply)		
Creepage distances and clearances	DIN EN 61131-2; DIN EN 50178			DIN EN 61131-2; DIN EN 50178		
Electrostatic discharge	EN 61000-4-2; 8 KV air; 4 KV contact			EN 61000-4-2; 8 KV air; 4 KV contact		
Electromagnetic fields	ENV 50140; 10 V/m; 30...1000 MHz			ENV 50140; 10 V/m; 30...1000 MHz		
Immunity / emitted interference	EN 61000-6-2/EN 55011, limit value class A, group 1			EN 61000-6-2/EN 55011, limit value class A, group 1		
Burst	accord. to EN 61000-4-4			accord. to EN 61000-4-4		
Connection style	spring connection			spring connection		
Cross-sectional area-fine stranded / solid	26 – 14 AWG / 26 – 16 AWG			26 – 14 AWG / 26 – 16 AWG		
Ambient temperature	0 °C...+55 °C (accord. to DIN 40040)			0 °C...+55 °C (accord. to DIN 40040)		
Storage temperature	–25 °C...+75 °C (accord. to DIN 40040)			–25 °C...+75 °C (accord. to DIN 40040)		
Accessories						
Snap-on potential distributor for 3-wire and 4-wire operation	83.039.0000.1			83.039.0000.1		
Adhesive labels, DIN A4 sheet	05.591.3255.0			05.591.3255.0		
2pole jumper for parallel output switching	Z7.258.1225.0			Z7.258.1225.0		
Marking tag, 8-digit, unmarked	04.242.1553.0			04.242.1553.0		
Marking tag, 8-digit, marked (upon request)						
End clamp for DIN rail	Z5.522.8553.0			Z5.522.8553.0		
Manual, English	05.562.1389.0			05.562.1389.0		

Distributed I/O Modules

ricos

Analog I/O modules

for default signals of 0...10 V or ± 10 V
for 2-wire, 3-wire and 4-wire connection
Electronic components can be replaced
without disconnecting the wiring



**Analog I/O module
4 inputs 0 to 10 V**
CE; Approvals: in preparation



**Analog I/O module
4 inputs ± 10 V**
CE; Approvals:

Dimensions (mm): W x H x D
69 x 92 x 51

Description	Type	Part no.	Std. pack	Type	Part no.	Std. pack
	ricos 4AI/0...10 V	83.035.4001.1	1	ricos 4AI/ ± 10 V	83.035.4000.1	1
Mode display:	24 V – supply voltage connected: LED yellow			24 V – supply voltage connected: LED yellow		
	RUN – internal data transmission in progress: LED yellow			RUN – internal data transmission in progress: LED yellow		
	channel LED – switching status: LED green			channel LED – switching status: LED green		
	channel LED – channel cursor: LED yellow			channel LED – channel cursor: LED yellow		
Wiring diagrams, derating curves	see page 433			see page 433		
Module data						
Number of inputs	4			4		
Number of outputs	0			0		
Operating voltage	24 V DC, $\pm 20\%$, max. 5% residual ripple			24 V DC, $\pm 20\%$, max. 5% residual ripple		
Power input	< 2.5 W			< 2.5 W		
Configurable	PC, PLC, diagnosis code 9 bus coupler			PC, PLC, diagnosis code 9 bus coupler		
Required space on control side	1 to 4 input words (depending on configuration)			1 to 4 input words (depending on configuration)		
Technical information						
Measuring range	0...+9.995 V			-10...+9.995 V		
Resolution	12 Bit			12 Bit		
Sampling frequency	< 2 ms			< 2 ms		
Offset error	typ. 0.5 LSB; max. 1 LSB			typ. 0.5 LSB; max. 1 LSB		
Channel crosstalk	-74 dB (f < 100 Hz)			-74 dB (f < 100 Hz)		
Gain error	typ. 0.08% FSR; max. 0.2% FSR			typ. 0.08% FSR; max. 0.2% FSR		
Noise voltage	typ. 0.5 LSB; max. 2 LSB			typ. 0.5 LSB; max. 2 LSB		
Offset error due to source impedance	+3 LSB/kOhm (Uinput = 0 V)			+3 LSB/kOhm (Uinput = 0 V)		
Galvanic isolation	75 V (AGND/shield)			75 V (AGND/shield)		
Common mode range	+12.8 V DC			-12.8 V/+12.8 V DC		
Input resistance	1 MOhm			1 MOhm		
Input current	typ. 15 μ A			typ. 15 μ A		
Short-circuit current / short-circuit duration	-			-		
Ripple	-			-		
Voltage range for open-circuit recognition on both sides	9.9 V (floating source)			-10V/9.9 V (floating source)		
Common mode rejection	87 dB (f = DC); 70 dB (f = 50 Hz); 60 dB (f = 1 kHz)			87 dB (f = DC); 70 dB (f = 50 Hz); 60 dB (f = 1 kHz)		
Common mode input resistance	500 kOhm (inputs short-circuited against AGND)			500 kOhm (inputs short-circuited against AGND)		
Capacitive common mode input resistance	4.4 nF (inputs short-circuited against AGND)			4.4 nF (inputs short-circuited against AGND)		
Dynamic common mode input resistance	1.1 kOhm (f > 100 kHz)			1.1 kOhm (f > 100 kHz)		
Insulation voltage	350 V AC, 50 Hz (system / supply)			350 V AC, 50 Hz (system / supply)		
Creepage distances and clearances	DIN EN 61131-2; DIN EN 50178			DIN EN 61131-2; DIN EN 50178		
Electrostatic discharge	EN 61000-4-2; 8 KV air; 4 KV contact			EN 61000-4-2; 8 KV air; 4 KV contact		
Electromagnetic fields	ENV 50140; 10 V/m; 30...1000 MHz			ENV 50140; 10 V/m; 30...1000 MHz		
Immunity/emitted interference	EN 61000-6-2/EN 55011, limit value class A, group 1			EN 61000-6-2/EN 55011, limit value class A, group 1		
Burst	accord. to EN 61000-4-4			accord. to EN 61000-4-4		
Connection style	spring connection			spring connection		
Cross-sectional area-fine stranded / solid	26 – 14 AWG / 26 – 16 AWG			26 – 14 AWG / 26 – 16 AWG		
Ambient temperature	0 °C...+55 °C (accord. to DIN 40040)			0 °C...+55 °C (accord. to DIN 40040)		
Storage temperature	-25 °C...+75 °C (accord. to DIN 40040)			-25 °C...+75 °C (accord. to DIN 40040)		
Accessories						
Snap-on potential distributor for 3-wire and 4-wire operation	83.039.0000.1			83.039.0000.1		
Adhesive labels, DIN A4 sheet	05.591.3255.0			05.591.3255.0		
2pole jumper for parallel output switching	Z7.258.1225.0			Z7.258.1225.0		
Marking tag, 8-digit, unmarked	04.242.1553.0			04.242.1553.0		
Marking tag, 8-digit, marked (upon request)						
End clamp for DIN rail	Z5.522.8553.0			Z5.522.8553.0		
Manual, English	05.562.1389.0			05.562.1389.0		

ricos

Analog I/O modules
for default signals of 0...10 V or ± 10 V
for 2-wire, 3-wire and 4-wire connection
Electronic components can be replaced
without disconnecting the wiring



Analog I/O module
4 inputs and 4 outputs 0 to 10 V
 CE; Approvals: in preparation



Analog I/O module
4 inputs and 4 outputs ± 10 V
 CE; Approvals:

Dimensions (mm): W x H x D
 69 x 92 x 51

Description	Type	Part no.	Std. pack	Type	Part no.	Std. pack
	ricos 4AI4AO/0...10 V	83.035.4100.1	1	ricos 4AI4AO/ ± 10 V	83.035.4100.1	1
Mode display:	24 V – supply voltage connected: LED yellow			24 V – supply voltage connected: LED yellow		
	RUN – internal data transmission in progress: LED yellow			RUN – internal data transmission in progress: LED yellow		
	channel LED – switching status: LED green			channel LED – switching status: LED green		
	channel LED – channel cursor: LED yellow			channel LED – channel cursor: LED yellow		
Wiring diagrams, derating curves	see page 433			see page 433		
Module data						
Number of inputs	4			4		
Number of outputs	4			4		
Operating voltage	24 V DC, $\pm 20\%$, max. 5% residual ripple			24 V DC, $\pm 20\%$, max. 5% residual ripple		
Power input	< 2.5 W			< 2.5 W		
Configurable	PC, PLC, diagnosis code 9 bus coupler			PC, PLC, diagnosis code 9 bus coupler		
Required space on control side	1 to 4 input / output words (depending on configuration)			1 to 4 input / output words (depending on configuration)		
Technical information						
Measuring range	0...+9.995 V			-10...+9.995 V		
Resolution	12 Bit			12 Bit		
Sampling frequency	< 2 ms			< 2 ms		
Offset error	typ. 0.5 LSB; max. 1 LSB			typ. 0.5 LSB; max. 1 LSB		
Channel crosstalk	-74 dB (f < 100 Hz)			-74 dB (f < 100 Hz)		
Gain error	Input: max. 0.2% FSR; output: max. 0.12% FSR			typ. 0.08% FSR; max. 0.2% FSR		
Noise voltage	typ. 0.5 LSB; max. 2 LSB			typ. 0.5 LSB; max. 2 LSB		
Offset error	Input: +3 LSB/kOhm (Uinput = 0 V); output: max. 10 mV			+3 LSB/kOhm (Uinput = 0 V)		
Galvanic isolation	75 V (AGND/shield)			75 V (AGND/shield)		
Common mode range	+12.8 V DC			-12.8 V/+12.8 V DC		
Input resistance	1 MOhm			1 MOhm		
Input current/output current	typ. 15 μ A/10 mA			typ. 15 μ A		
Short-circuit current / short-circuit duration	20 mA/100% ON			20 mA/100% ON		
Ripple	5 mV			5 mV		
Voltage range for open-circuit recognition on both sides	9.9 V (floating source)			-10V/9.9 V (floating source)		
Common mode rejection	87 dB (f = DC); 70 dB (f = 50 Hz); 60 dB (f = 1 kHz)			87 dB (f = DC); 70 dB (f = 50 Hz); 60 dB (f = 1 kHz)		
Common mode input resistance	500 kOhm (inputs short-circuited against AGND)			500 kOhm (inputs short-circuited against AGND)		
Capacitive common mode input resistance	4.4 nF (inputs short-circuited against AGND)			4.4 nF (inputs short-circuited against AGND)		
Dynamic common mode input resistance	1.1 kOhm (f > 100 kHz)			1.1 kOhm (f > 100 kHz)		
Insulation voltage	350 V AC, 50 Hz (system / supply)			350 V AC, 50 Hz (system / supply)		
Creepage distances and clearances	DIN EN 61131-2; DIN EN 50178			DIN EN 61131-2; DIN EN 50178		
Electrostatic discharge	EN 61000-4-2; 8 KV air; 4 KV contact			EN 61000-4-2; 8 KV air; 4 KV contact		
Electromagnetic fields	ENV 50140; 10 V/m; 30...1000 MHz			ENV 50140; 10 V/m; 30...1000 MHz		
Immunity / emitted interference	EN 61000-6-2/EN 55011, limit value class A, group 1			EN 61000-6-2/EN 55011, limit value class A, group 1		
Burst	accord. to EN 61000-4-4			accord. to EN 61000-4-4		
Connection style	spring connection			spring connection		
Cross-sectional area-fine stranded / solid	26 – 14 AWG / 26 – 16 AWG			26 – 14 AWG / 26 – 16 AWG		
Ambient temperature	0 °C...+55 °C (accord. to DIN 40040)			0 °C...+55 °C (accord. to DIN 40040)		
Storage temperature	-25 °C...+75 °C (accord. to DIN 40040)			-25 °C...+75 °C (accord. to DIN 40040)		
Accessories						
Snap-on potential distributor for 3-wire and 4-wire operation	83.039.0000.1			83.039.0000.1		
Adhesive labels, DIN A4 sheet	05.591.3255.0			05.591.3255.0		
2pole jumper for parallel output switching	Z7.258.1225.0			Z7.258.1225.0		
Marking tag, 8-digit, unmarked	04.242.1553.0			04.242.1553.0		
Marking tag, 8-digit, marked (upon request)						
End clamp for DIN rail	Z5.522.8553.0			Z5.522.8553.0		
Manual, English	05.562.1389.0			05.562.1389.0		

Specifications are subject to change without notice

Distributed I/O Modules

ricos

Analog

I/O modules

for default signals of 0...20 mA

for 2-wire, 3-wire and 4-wire connection

Electronic components can be replaced
without disconnecting the wiring



Analog I/O module 4 inputs 0 to 20 mA

CE; Approvals:

Dimensions (mm): W x H x D
69 x 92 x 51

Description	Type	Part no.	Std. pack
	ricos 4AI/0–20 mA	83.035.4010.1	1
Mode display:			
	24 V – supply voltage connected: LED yellow		
	RUN – internal data transmission in progress: LED yellow		
	channel LED – switching status: LED green		
	channel LED – channel cursor: LED yellow		
Wiring diagrams, derating curves	see page 433		
Module data			
Number of inputs	4		
Number of outputs	0		
Operating voltage	24 V DC, ±20 %, max. 5 % residual ripple		
Power input	< 2.5 W		
Configurable	PC, PLC, diagnosis code 9 bus coupler		
Required space on control side	1 to 4 input words (depending on configuration)		
Technical information			
Measuring range	0...+19.995 mA		
Resolution	12 Bit		
Sampling frequency	2 ms		
Offset error	typ. 0.5 LSB; max. 1 LSB		
Channel crosstalk	-74 dB (f < 100 Hz)		
Gain error	max. 0.45 % FSR		
Noise voltage	typ. 0.5 LSB; max. 2 LSB		
Drift rate	-		
Galvanic isolation	75 V (AGND/shield)		
Output load	max. 100.1 Ohm		
Continuous input current	40 mA bei 100 % ON		
Continuous input voltage	4 V bei 100 % ON		
Short-circuit current / short-circuit duration	-		
Ripple	-		
Dynamic common mode input resistance	1.1 kOhm (f > 100 kHz)		
Insulation voltage	350 V AC, 50 Hz (system / supply)		
Creepage distances and clearances	DIN EN 61131-2; DIN EN 50178		
Electrostatic discharge	EN 61000-4-2; 8 KV air; 4 KV contact		
Electromagnetic fields	ENV 50140; 10 V/m; 30...1.000 MHz		
Immunity / emitted interference	EN 61000-6-2/EN 55011, limit value class A, group 1		
Burst	accord. to EN 61000-4-4		
Connection style	spring connection		
Cross-sectional area-fine stranded / solid	26 – 14 AWG / 26 – 16 AWG		
Ambient temperature	0 °C...+55 °C (accord. to DIN 40040)		
Storage temperature	-25 °C...+75 °C (accord. to DIN 40040)		
Accessories			
Snap-on potential distributor for 3-wire and 4-wire operation	83.039.0000.1		
Adhesive labels, DIN A4 sheet	05.591.3255.0		
2pole jumper for parallel output switching	Z7.258.1225.0		
Marking tag, 8-digit, unmarked	04.242.1553.0		
Marking tag, 8-digit, marked (upon request)			
End clamp for DIN rail	Z5.522.8553.0		
Manual, English	05.562.1389.0		

ricos

Analog I/O modules

for default signals of 0...20 mA or 4...20 mA

for 2-wire, 3-wire and 4-wire connection

Electronic components can be replaced
without disconnecting the wiring



Analog I/O module
4 inputs and 4 outputs 0 to 20 mA
CE; Approvals:



Analog I/O module
4 inputs and 4 outputs 4–20 mA
CE; Approvals: in preparation

Dimensions (mm): W x H x D
69 x 92 x 51

Description	Type	Part no.	Std. pack	Type	Part no.	Std. pack
	ricos 4AIAO/0–20 mA	83.035.4110.1	1	ricos 4AIAO/4–20 mA	83.035.4111.1	1
Mode display:	24 V – supply voltage connected: LED yellow			24 V – supply voltage connected: LED yellow		
	RUN – internal data transmission in progress: LED yellow			RUN – internal data transmission in progress: LED yellow		
	channel LED – switching status: LED green			channel LED – switching status: LED green		
	channel LED – channel cursor: LED yellow			channel LED – channel cursor: LED yellow		
Wiring diagrams, derating curves	see page 433			see page 433		
Module data						
Number of inputs	4			4		
Number of outputs	4			4		
Operating voltage	24 V DC, ±20%, max. 5% residual ripple			24 V DC, ±20%, max. 5% residual ripple		
Power input	< 2.5 W			< 2.5 W		
Configurable	PC, PLC, diagnosis code 9 bus coupler			PC, PLC, diagnosis code 9 bus coupler		
Required space on control side	1 to 4 input / output words (depending on configuration)			1 to 4 input / output words (depending on configuration)		
Technical information						
Measuring range	0...+19.995 mA			4...+19.995 mA		
Resolution	12 Bit			12 Bit		
Sampling frequency	2 ms			2 ms		
Offset error	Input: max. 1 LSB; output: max. 4 uA			Input: max. 1 LSB; output: max. 4 uA		
Channel crosstalk	–74 dB (f < 100 Hz)			–74 dB (f < 100 Hz)		
Gain Error	Input: max. 0.45% FSR; output: max. 0.5% FSR			Input: max. 0.45% FSR; output: max. 0.5% FSR		
Noise voltage	typ. 0.5 LSB; max. 2 LSB			typ. 0.5 LSB; max. 2 LSB		
Drift rate	4 µA/ms			4 µA/ms		
Galvanic isolation	75 V (AGND/shield)			75 V (AGND/shield)		
Output load	Input: max. 100.1 Ohm; output: 500 Ohm			Input: max. 100.1 Ohm; output: 500 Ohm		
Continuous input current	40 mA bei 100% ON			40 mA bei 100% ON		
Continuous input voltage	4 V bei 100% ON			4 V bei 100% ON		
Short-circuit current / short-circuit duration	20 mA; 100% ON			20 mA; 100% ON		
Ripple	10 µA			10 µA		
Dynamic common mode input resistance	1.1 kOhm (f > 100 kHz)			1.1 kOhm (f > 100 kHz)		
Insulation voltage	350 V AC, 50 Hz (system / supply)			350 V AC, 50 Hz (system / supply)		
Creepage distances and clearances	DIN EN 61131-2; DIN EN 50178			DIN EN 61131-2; DIN EN 50178		
Electrostatic discharge	EN 61000-4-2; 8 KV air; 4 KV contact			EN 61000-4-2; 8 KV air; 4 KV contact		
Electromagnetic fields	ENV 50140; 10 V/m; 30...1000 MHz			ENV 50140; 10 V/m; 30...1000 MHz		
Immunity / emitted interference	EN 61000-6-2/EN 55011, limit value class A, group 1			EN 61000-6-2/EN 55011, limit value class A, group 1		
Burst	accord. to EN 61000-4-4			accord. to EN 61000-4-4		
Connection style	spring connection			spring connection		
Cross-sectional area-fine stranded / solid	26 – 14 AWG / 26 – 16 AWG			26 – 14 AWG / 26 – 16 AWG		
Ambient temperature	0 °C...+55 °C (accord. to DIN 40040)			0 °C...+55 °C (accord. to DIN 40040)		
Storage temperature	–25 °C...+75 °C (accord. to DIN 40040)			–25 °C...+75 °C (accord. to DIN 40040)		
Accessories						
Snap-on potential distributor for 3-wire and 4-wire operation	83.039.0000.1			83.039.0000.1		
Adhesive labels, DIN A4 sheet	05.591.3255.0			05.591.3255.0		
2pole jumper for parallel output switching	Z7.258.1225.0			Z7.258.1225.0		
Marking tag, 8-digit, unmarked	04.242.1553.0			04.242.1553.0		
Marking tag, 8-digit, marked (upon request)						
End clamp for DIN rail	Z5.522.8553.0			Z5.522.8553.0		
Manual, English	05.562.1389.0			05.562.1389.0		

Distributed I/O Modules

ricos

Field bus coupler including DI/DO channels
Compact modules configurable as input or output for 2-wire, 3-wire and 4-wire connection
Electronic components can be replaced without disconnecting the wiring



Compact modules PROFIBUS DP
 €€; Approvals: cULus, Profibus certification



Compact modules Interbus
 €€; Approvals: cULus, Interbus certification

Dimensions (mm): W x H x D
 69 x 92 x 51

8 DI or 8 DO (configurable)	ricos com-dp 8I/O	83.030.1100.1	1	ricos com-s 8I/O	83.031.1100.1	1
16 DI	ricos com-dp 16I	83.030.1000.1	1	ricos com-s 16I	83.031.1000.1	1
16 DO	ricos com-dp 16O	83.030.1200.1	1	ricos com-s 16O	83.031.1200.1	1
8 DI and 8 DI/8 DO configurable*	ricos com-dp 8I 8I/O	83.030.1300.1	1	ricos com-s 8I 8I/O	83.031.1300.1	1
Mode display:	24 V – supply voltage connected: LED yellow		24 V – supply voltage connected: LED yellow		24 V – supply voltage connected: LED yellow	
	RUN – internal data transmission in progress: LED yellow		RUN – internal data transmission in progress: LED yellow		RUN – internal data transmission in progress: LED yellow	
	channel LED – switching status: LED green		channel LED – switching status: LED green		channel LED – switching status: LED green	
	channel LED – channel cursor: LED yellow		channel LED – channel cursor: LED yellow		channel LED – channel cursor: LED yellow	
Wiring diagrams, derating curves	see page 431		see page 431		see page 431	
System data						
Max. number of nodes	126		256			
Transmission medium	screened copper cable 2 x 0.25 mm ² /AWG 23		screened copper cable 5 x 0.25 mm ² /AWG 23			
Max. network expansion	100 m–1200 m (depending on baud rate / cable)		400 m (remote bus)			
Baud rate	9.6 kBaud...12 Mbaud		500 kBaud			
Internal bus refresh	2 ms		2 ms			
Bus connection	1 x D-SUB 9, screened female connector		2 x D-SUB 9, screened female and male connectors			
Input data						
Switching level "0" (EN 61131-2)	–30 V...+5 V DC		–30 V...+5 V DC			
Switching level "1" (EN 61131-2)	+15 V...+30 V DC		+15 V...+30 V DC			
Input current / channel (at 24 V DC)	4.5 mA/6.5 mA (combin. I/O)		4.5 mA/6.5 mA (combin. I/O)			
Status display	LED green		LED green			
Output data:						
Output voltage	operating voltage –0.5 V DC		operating voltage –0.5 V DC			
Output current per channel	1000 mA DC		1000 mA DC			
Max. total current per module	8 A DC		8 A DC			
Simultaneity	100% at max. 500 mA per channel		100% at max. 500 mA per channel			
Load types	resistive, inductive		resistive, inductive			
Status display	LED green		LED green			
Output response	resistant to overload and short-circuit		resistant to overload and short-circuit			
General						
Signal delay per I/O channel	< 100 µs		< 100 µs			
Max. voltage power contacts	30 V DC		30 V DC			
Max. current power contacts	8 A DC		8 A DC			
Insulation voltage	350 V AC, 50 Hz (system / supply)		350 V AC, 50 Hz (system / supply)			
Creepage distances and clearances	DIN EN 61131-2; DIN EN 50178		DIN EN 61131-2; DIN EN 50178			
Electrostatic discharge	EN 61000-4-2; 8 KV air; 4 KV contact		EN 61000-4-2; 8 KV air; 4 KV contact			
Electromagnetic fields	ENV 50140; 10 V/m; 30...1000 MHz		ENV 50140; 10 V/m; 30...1000 MHz			
Immunity / emitted interference	EN 61000-6-2/EN 55011, limit value class A, group 1		EN 61000-6-2/EN 55011, limit value class A, group 1			
Burst	accord. to EN 61000-4-4		accord. to EN 61000-4-4			
Connection style	spring connection		spring connection			
Cross-sectional area-fine stranded / solid	26 – 14 AWG / 26 – 16 AWG		26 – 14 AWG / 26 – 16 AWG			
Ambient temperature	0 °C...+55 °C (accord. to DIN 40040)		0 °C...+55 °C (accord. to DIN 40040)			
Storage temperature	–25 °C...+75 °C (accord. to DIN 40040)		–25 °C...+75 °C (accord. to DIN 40040)			
Accessories						
Snap-on potential distributor for 3-wire and 4-wire operation	83.039.0000.1		83.039.0000.1			
Adhesive labels, DIN A4 sheet	05.591.3255.0		05.591.3255.0			
2pole jumper for parallel output switching	Z7.258.1225.0		Z7.258.1225.0			
Marking tag, 8-digit, unmarked	04.242.1553.0		04.242.1553.0			
Marking tag, 8-digit, marked (upon request)						
End clamp for DIN rail	Z5.522.8553.0		Z5.522.8553.0			
GSD file and Word template for labels	05.591.3255.0		05.591.3255.0			
Manual, English	05.562.1389.0		05.562.1389.0			

ricos

Field bus coupler including DI/DO channels
Compact modules
Configurable as input or output for 2-wire, 3-wire and 4-wire connection

Electronic components can be replaced without disconnecting the wiring



Compact modules DeviceNet
 CE; Approvals:



Compact modules CANopen
 CE; Approvals: in preparation

Dimensions (mm): W x H x D
 69 x 92 x 51

Description	Type	Part no.	Std. pack	Type	Part no.	Std. pack
8 DI or 8 DO (configurable)	ricos com-dn 8I/O	83.032.1100.1	1	ricos com-co 8I/O	83.033.1100.1	1
16 DI	ricos com-dn 16I	83.032.1000.1	1	ricos com-co 16I	83.033.1000.1	1
16 DO	ricos com-dn 16O	83.032.1200.1	1	ricos com-co 16O	83.033.1200.1	1
8 DI and 8 DI/8 DO configurable	ricos com-dn 8I 8I/O	83.032.1300.1	1	ricos com-co 8I 8I/O	83.033.1300.1	1
Mode display:	24 V – supply voltage connected: LED yellow RUN – internal data transmission in progress: LED yellow channel LED – switching status: LED green channel LED – channel cursor: LED yellow			24 V – supply voltage connected: LED yellow RUN – internal data transmission in progress: LED yellow channel LED – switching status: LED green channel LED – channel cursor: LED yellow		
Wiring diagrams, derating curves	see page 431			see page 431		
System data						
Max. number of nodes	64 with repeater			256		
Transmission medium	screened copper cable trunk line AWG 15.18 screened copper cable drop line AWG 22.24			screened copper cable 3 x 0.25 mm ² /AWG 23		
Max. network expansion	100 m–500 m (depending on baud rate / cable)			100 m–500 m (depending on baud rate / cable)		
Baud rate	125/250/500 kBaud (setting via keyboard)			10 kBaud...1 MBaud (setting via keyboard)		
Internal bus refresh	2 ms			2 ms		
Bus connection	5pole connector, screw			5pole connector, screw		
Input data						
Switching level "0" (EN 61131-2)	–30 V...+5 V DC			–30 V...+5 V DC		
Switching level "1" (EN 61131-2)	+15 V...+30 V DC			+15 V...+30 V DC		
Input current / channel (at 24 V DC)	4.5 mA/6.5 mA (combin. I/O)			4.5 mA/6.5 mA (combin. I/O)		
Status display	LED green			LED green		
Output data:						
Output voltage	operating voltage –0.5 V DC			operating voltage –0.5 V DC		
Output current per channel	1000 mA DC			1000 mA DC		
Max. total current per module	8 A DC			8 A DC		
Simultaneity	100 % at max. 500 mA per channel			100 % at max. 500 mA per channel		
Load types	resistive, inductive			resistive, inductive		
Status display	LED green			LED green		
Output response	resistant to overload and short-circuit			resistant to overload and short-circuit		
General						
Signal delay per I/O channel	< 100 us			< 100 us		
Max. voltage power contacts	30 V DC			30 V DC		
Max. current power contacts	8 A DC			8 A DC		
Insulation voltage	350 V AC, 50 Hz (system / supply)			350 V AC, 50 Hz (system / supply)		
Creepage distances and clearances	DIN EN 61131-2; DIN EN 50178			DIN EN 61131-2; DIN EN 50178		
Electrostatic discharge	EN 61000-4-2; 8 KV air; 4 KV contact			EN 61000-4-2; 8 KV air; 4 KV contact		
Electromagnetic fields	ENV 50140; 10 V/m; 30...1000 MHz			ENV 50140; 10 V/m; 30...1000 MHz		
Immunity/emitted interference	EN 61000-6-2/EN 55011, limit value class A, group 1			EN 61000-6-2/EN 55011, limit value class A, group 1		
Burst	accord. to EN 61000-4-4			accord. to EN 61000-4-4		
Connection style	spring connection			spring connection		
Cross-sectional area-fine stranded / solid	26 – 14 AWG / 26 – 16 AWG			26 – 14 AWG / 26 – 16 AWG		
Ambient temperature	0 °C...+55 °C (accord. to DIN 40040)			0 °C...+55 °C (accord. to DIN 40040)		
Storage temperature	–25 °C...+75 °C (accord. to DIN 40040)			–25 °C...+75 °C (accord. to DIN 40040)		
Accessories						
Snap-on potential distributor for 3-wire and 4-wire operation	83.039.0000.1			83.039.0000.1		
Adhesive labels, DIN A4 sheet	05.591.3255.0			05.591.3255.0		
2pole jumper for parallel output switching	Z7.258.1225.0			Z7.258.1225.0		
Marking tag, 8-digit, unmarked	04.242.1553.0			04.242.1553.0		
Marking tag, 8-digit, marked (upon request)						
End clamp for DIN rail	Z5.522.8553.0			Z5.522.8553.0		
EDS file and Word template for labels	05.591.3255.0			05.591.3255.0		
Manual, English	05.562.1389.0			05.562.1389.0		

electronics

Distributed I/O Modules



Wiring diagrams of the Buscoupler

PROFIBUS DP

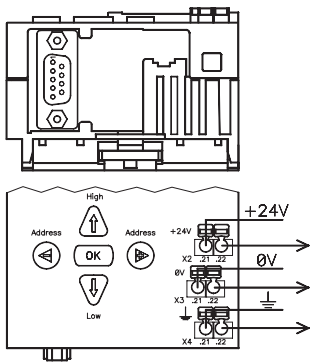

Interbus

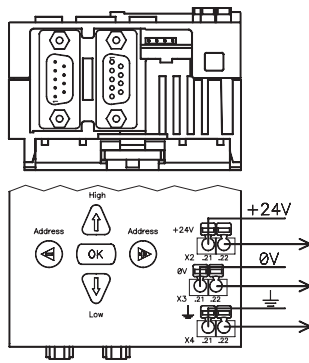

DeviceNet and CANopen

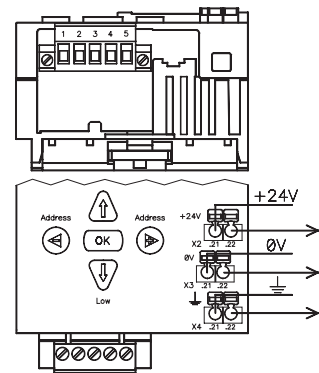

Ethernet

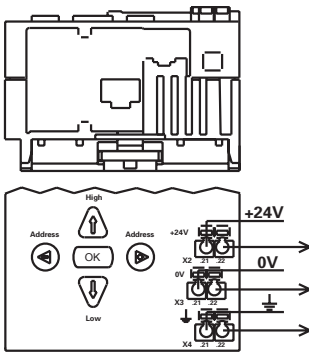

Wiring diagrams of economy Buscoupler

PROFIBUS DP

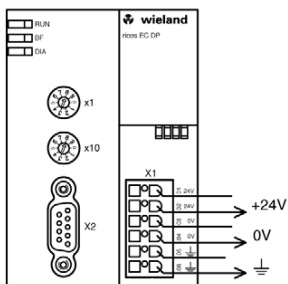

Interbus

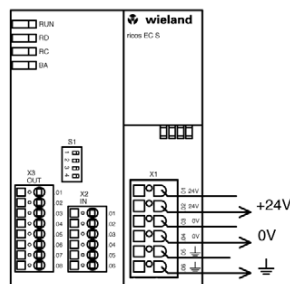

DeviceNet and CANopen

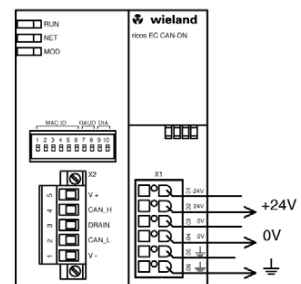

Wiring diagrams of binary and compact modules

ricos 8I/O and ricos COM 8I/O

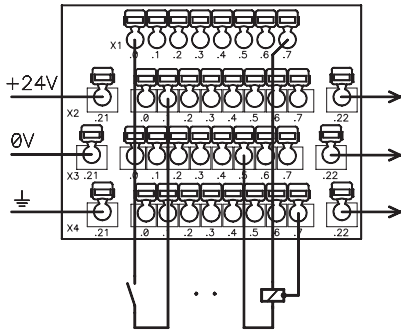

ricos 16I and ricos COM 16I

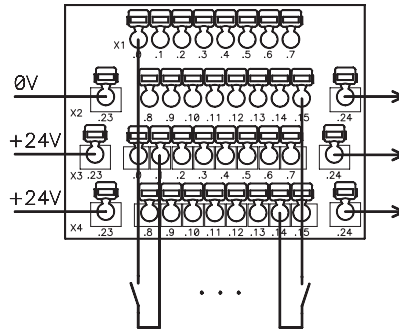

ricos COM-DP

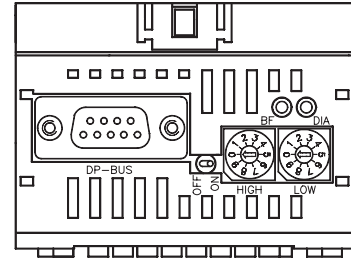

ricos 16O and ricos COM 16O

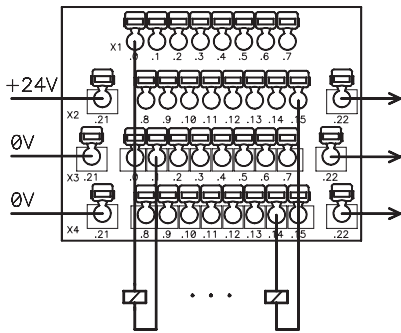

ricos 8I 8I/O and ricos COM 8I 8I/O

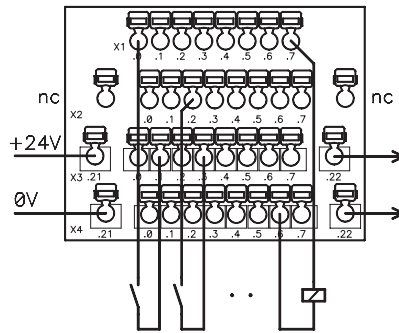

ricos COM-S

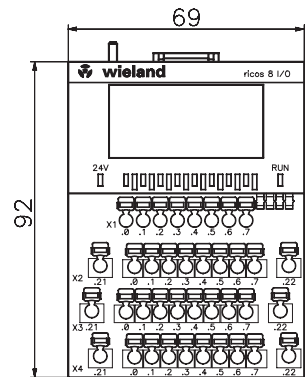
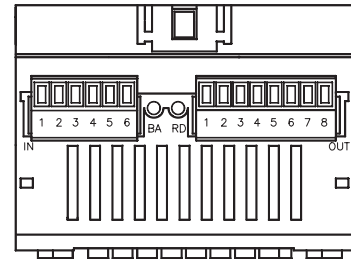

Derating

Total current

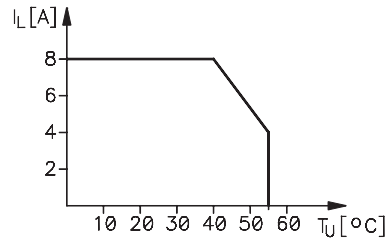

ricos COM CAN DN
ricos COM CANopen

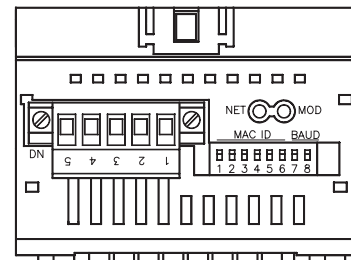

Distributed I/O Modules



Wiring diagrams of binary modules

ricos 4I 115 V

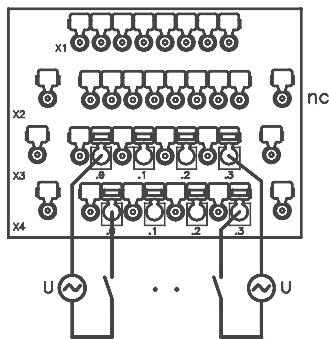

ricos 4I 230 V

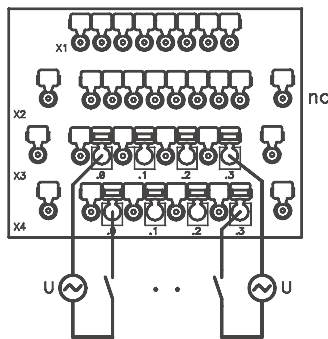

ricos 4O RELAY

ricos 8O DC 2 A

ricos 8O NEG

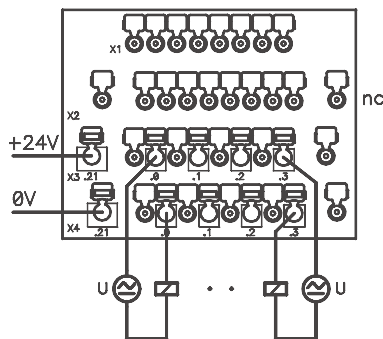

in preparation

in preparation

Wiring diagrams of analog modules

ricos 4AI/0...10 V
ricos 4 AI/±10 V
ricos 4AI/0...20 mA

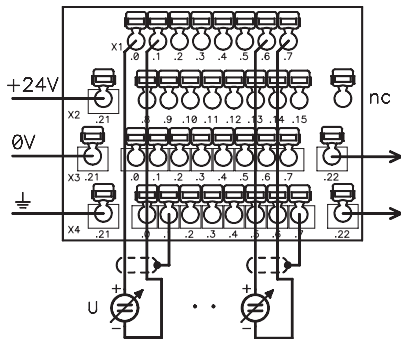

ricos 4AI4AO/0...10 V
ricos 4AI4AO/±10 V
ricos 4AI4AO/0...20 mA
ricos 4AI4AO/4...20 mA

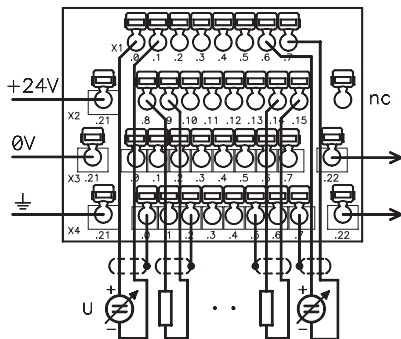

Distributed I/O Modules



Wiring diagrams of the counter and positioning modules

ricos COUNTER

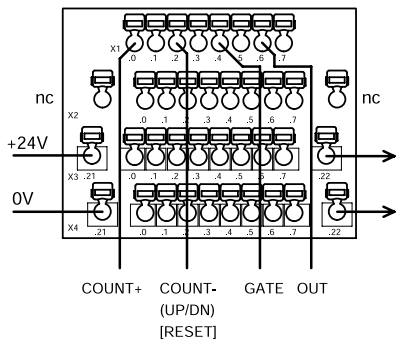

ricos POSITION

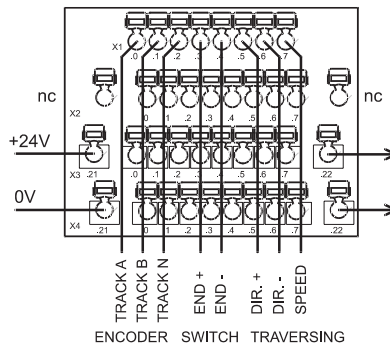

Wiring diagrams of the PT100 and TC modules

ricos 4AI Pt100

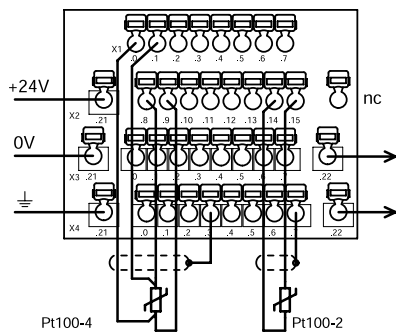

ricos 4AI TC

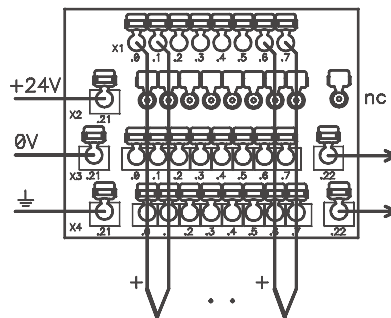

ricos housing data

Material	Makrolon 2805, Lexan 161R, Polyamid 6.0 GF20
Colour	black
Flammability class	in accordance DIN VDE 0304 T3 (IEC 707) in accordance UL 94-V-2
Resistance to creepage	in accordance DIN VDE 0303 T1/06.84 CTI = 600
Thermal stability	in accordance DIN VDE 0304 20.000 h/5.000 h 100/115 °C
Electric strength	in accordance DIN VDE 0303 T2 (DIN 53481/>15 kV/mm)
Protection class	Class I in accordance IEC 536
Type of protection	IP20 in accordance EN 60529
Drop test	Height of fall (DIN IEC 68-2-32), with packaging
Shock resistance	in accordance IEC 68 Section 2, see "Drop test"
Relative humidity	10...95%, no moisture condensation
Air pressure during operation	860...1060 hPa
Insulation strip length of cables	10 mm
Opening in terminal compartment	2.4 x 1.5 mm in accordance IEC 999
Mounting rail	TS35
Weight	approx.190 g

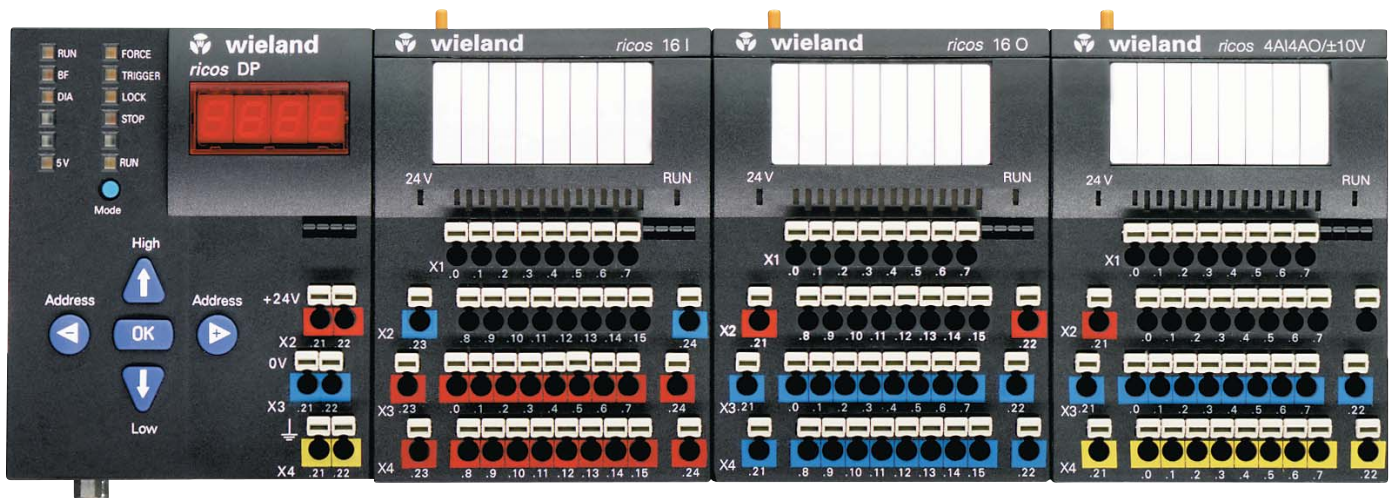

Relay modules

relais

Introduction to relay technology

Modular DIN rail mounted relays

Plug-in DIN rail mounted relays

Multiple chassis mounted relays

Timer relays

The relay modules offer features such as

- Overall width of 6,2 mm
- Screw or spring-clamp connection
- Separation into input or output relays
- Multipole relay modules
- 4 kV isolation at a creepage and clearance distance of 8 mm
- Timer relay with ON delay
- Multi function time relay
- Solid state relays

All Wieland Components which require **CE** general certification are **CE** certified, and identified with the **CE** logo.



electronics



Electronic components

Relay modules

Relay modules

flare

Wieland relay modules – the reliable way to implement an application-related interface

In the microchip age, many believed that electromechanical relays would no longer play a role. This is however far from the truth. Switching relays have reliably carried out important tasks for many years, working in a "symbiotic relationship" with the electronics. Relays have demonstrated a high degree of flexibility over the years. The core characteristics have been maintained or even improved such as:

- Overload capability without costly protection measures
- Contact rating of μA up to $>10\text{ A}$
- Various types and number of the contacts
- High level of insensitivity to electrical interference
- Switching without dependence on the direction of current (AC/DC) up to the GHz range
- Low level of switching power loss
- Electrical isolation between all contacts and the coil

Wieland offers a complete range of relay modules with a combination of properties outlined above. Depending on the required applications, relay modules are available with various operating voltages, contact arrangements, contact materials and housing designs. Timer relays or HAND-0-AUTO relays can be supplied in addition to relays with pure monostable functionality.

Product range:

flare MOVE, Plug-in, process interface relay with an overall width of 6.2 mm

flare, Process interface relay / time relay with an overall width of 6.2 mm

WEG, Switching relay modules with an overall width up to 22.5 mm

WR, WRS, RAB, Multiple switching relay modules with mounting base

Overview of the technical data

Control side – operating voltage

Wieland relay modules can be controlled within a defined temperature range, given operating voltage and relevant tolerance

band to a 100% duty cycle.

Control side – Suppression circuit

AC/DC relay modules are available. DC relays are equipped with a polarised diode and a free-wheeling diode in the input. These functions are taken over by a power rectifier in the case of AC or AC/DC modules. All relay modules have an LED for status display in the input circuit.

Suppression circuit of input for DC operation

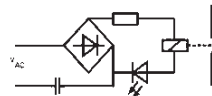
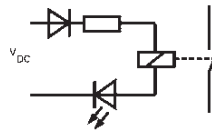

Suppression circuit of input for AC operation

Control side – residual voltage

To ensure the safe operation of the relay the residual voltage in the coil circuits must not exceed 5% DC and 15% AC of the operating voltage in accordance with VDE 0435. Values above this will result in the relay remaining closed after switch off.

Residual voltages can occur from semiconductor devices in circuit, induced voltages from high current cabling or other inductive or capacitive interference factors.

Corrective measures may involve the re-routing of cables away from interference or the parallel connection of RC elements.

Load side – contact material

The contacts are used to route control signals in a power range of mW up to more than 1000 VA. The contact material

that is used is largely determined by the load expected during operation (particularly with regard to current carrying capacity, switching frequency, operating speed as well as any corrosive environmental influences). Wieland uses the universally accepted AgSnO contacts for power ranges up to 1500 VA. In the lower power range, the same material is used but with a gold-plated finish.

Modules with gold-flashed AgCu contacts, AgCdO or gold-plated AgNi contacts are

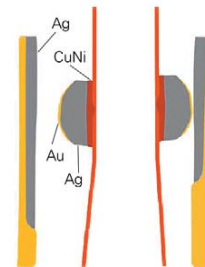

also available. Table 1 gives an overview of other contact materials.

Cut-out of a 3-layer welded contact with a linear contact closure

flare

Contact material	Attacked by		Typical properties	Typical applications	Scope
	Sulphur	Oxidisation			
Gold silver AuAg10	no	no	Low and constant contact resistance at minimum switching capacity	Dry switching circuits, measuring circuits, unfiltered communication routes	mV...60 V mA...300 mA
Gold nickel AuNi5	no	slightly	Free of material transfer in broad loading ranges, small contact resistance, slight electric arcs occur at low switching capacities, higher number of operations and greater contact follow-through, interference possible due to friction oxides	Used in low and medium voltage and current ranges	100 mV...60 V 1 mA...300 mA
Fine grained silver AgNi0,15	yes	no	Higher mechanical strength, low welding tendency and higher arc resistance than Ag, relatively smaller contact resistance	Universal use in medium-sized loads at higher voltage than gold nickel	>12 V 1 mA...1 A
Hard silver AgCu3	yes	when switching	Higher mechanical strength, low welding tendency and higher arc resistance than fine silver but a greater contact resistance	Used in medium-sized loads	>12 V 10 mA...10 A
Silver nickel AgNi10	yes	no	Higher arc resistance, low welding tendency, greater contact resistance	Switching circuits for medium to high loads, d.c. circuit	>17 V >5 mA
Silver cadmium Oxid AgCd010	yes	no	Low welding tendency, high arc resistance at greater switching capacities	Particularly suitable for switching inductive loads	>12 V >100 mA
Silver tin oxide AgSn010	yes	no	Low welding tendency, very high arc resistance at high switching capacities, low rate of material transfer	Switching circuits with high loads during opening and closing, d.c. circuits	>17 V >5 mA
AgNi0,15+ 5 µ Au	no	yes	Good corrosion properties, good contact resistance	Small switching capacities for dry circuits	µV...30 V µA...200 mA
AuAg10 over AgNi+Au	no	yes	Behaves as 5 m gold contact but its resistance to wear is five times greater	Switching capacity: 10 ⁻⁶ W / VA up to 100 W / 1 kVA	> 100 mV > 10 µA

Table 1: Overview of contact materials

Contact side – reduction of arcs

When the arc limit voltage (see diagram) which is dependent on the switching current and contact material is exceeded, discharge processes take place on the relay contact. Material transfer occurs which damages the contact. To achieve a long service life and a high level of reliability despite this type of contact loading, circuit elements are required for arc suppression. Several options are available.

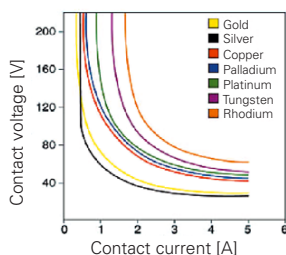

Arc limit of pure contact metals

D.C. circuits with a resistive load

An RC element which is connected in parallel to the contact can be used for arc suppression.

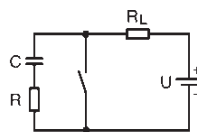

RC element parallel

At the point of disconnection, the voltage U_c at the contact jumps from zero to the value $U \times R / (R + R_L)$ and then rises according to the function $U_c = U (1 - e^{-t/\tau})$ whereby $\tau = (R + R_L) \times C$. The resistance R must be high enough so that the combined total of the condenser discharge current and the switching current at start-up is less than the maximum permitted starting current.

$$R > U / (I_{zul} U / R)$$

At a switching frequency $1/T$, the capacitor should have discharged its load again before the contact is reopened. This is essentially guaranteed if $C < T/2R$ has been selected.

D.C. circuits with an inductive load

While the maximum switching voltage U is applied when a resistive load is present at the contact, voltage peaks that are approximately 10 times as high can occur in the case of an inductive load.

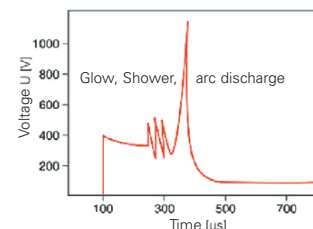

Voltage characteristics at the relay contact for inductive loads

Relay modules



To avoid harmful discharge processes, it is necessary to prevent a sudden disruption in the flow of current and simultaneously ensure that the voltage rise at the contact, which is limited by the degradation of the magnetic field, takes place at a slower rate than the opening of the contact. This counteracts the occurrence of a discharge process and an air gap is therefore created as quickly as possible after the opening of the contact whose igniting voltage far exceeds the voltage building up at the contacts. An RC element which lies parallel to the contact can also be used for this purpose.

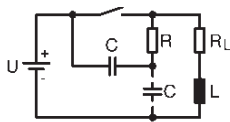

RC element for inductive load

When the contact opens, a charging current which is subsiding after an e function, flows into the capacitor. This slows down the absorption of the current that is flowing through the inductor and the peak value of the voltage at the contact is simultaneously reduced. The following serves as a practical, approximate value for the rating of the capacitor

$$C (\mu F) \cong I^2 / 10 (A)$$

where **I** represents the respective switching current. The resistance must be rated so that the combined total of the capacitor discharge current and the switching current is again less than the permitted starting current.

Another possibility is the parallel connection of an RC element to the load itself (see diagram above). This protective measure is equally effective. The disadvantage of both arrangements is the use of relatively large and therefore expensive capacitors.

RC circuit for a.c. load

A VDR resistor (Voltage Dependent Resistor) or varistor can be connected in parallel to the load in this application in order to protect the contact. The resistance of this component is low for high voltage levels and high for low voltage levels. Varistors are therefore extremely suitable for the suppression of arcs in a.c. circuits. Table 2 gives an overview of further possibilities for arc suppression.

Protective circuit for load	Additional dropout delay	Defined limit for induced voltage	Bipolar attenuation	Benefits / Disadvantages
Diode	long	yes (U_D)	no	Benefits: Simple implementation Cost effective Reliable Non-critical dimensioning Small induced voltage Disadvantages: Attenuation only via load resistance Long dropout delay
Series-connected diode / Zener diode	medium to short	yes (U_{ZD})	no	Benefit: Non-critical dimensioning Disadvantage: Attenuation only above U_{ZD}
Suppressor diode	medium to short	yes (U_{ZD})	yes	Benefits: Cost effective Non-critical dimensioning Suitable for AC voltage Limit of positive peaks Disadvantage: Attenuation only above U_{ZD}
Varistor	medium to short	yes (U_{VDR})	yes	Benefits: High absorption of energy Non-critical dimensioning Suitable for AC voltage Disadvantage: Attenuation only above U_{VDR}
RC Combination	medium to short	no	yes	Benefits: HF attenuation of stored energy Suitable for AC voltage Attenuation is not dependent on the level Disadvantages: Exact values required High inrush current Sensitive to harmonic waves

Table 2: Overview of protective measures on the switch output

Diode:

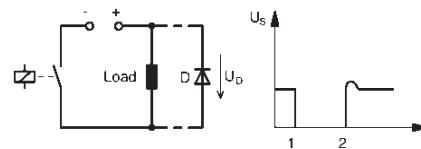

Benefit: Can be used for all capacities, low overvoltage, compact, cost-effective

Disadvantage: Very high resetting time

Varistor:

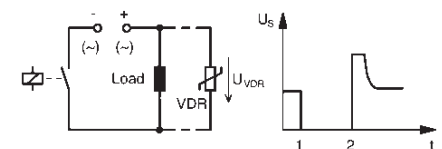

Benefit: Low resetting time, cost-effective

Disadvantage: Cannot be used for all operating voltages and capacities

Diode and Zener diode:

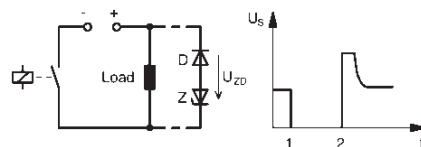

Benefit: Low overvoltage (defined by Zener diode), low resetting time

Disadvantage: Cannot be used for large capacities

RC combination:

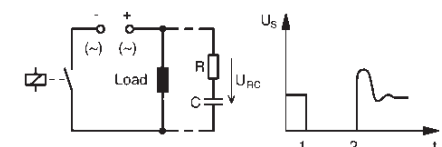

Benefit: Low overvoltage, low resetting time

Disadvantage: High current loading of the contacts at start-up, more costly and time-consuming with increased capacity

flare

Endurance

A distinction is made in relay modules between mechanical and electrical endurance. The mechanical endurance defines the maximum number of operating cycles without contact loading while the electrical endurance describes the switching frequency at a maximum switching capacity for resistive load. A low switching capacity increases these values considerably. The following diagram indicates the typical waveform between the switching current and endurance of a relay. Figures for each relay module is shown on the relevant catalogue data page.

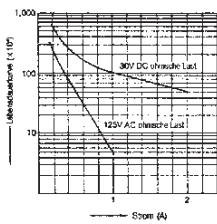

Typical endurance curve of a relay

Safety separation – VDE 0106

The safety separation of coupled switching circuits in the relay modules means that the isolating voltage between the control and load circuit is retained even in the event of a mechanical failure (bent soldered pin, broken coil winding or spring). When using solid-state relays or electronic relays, this requirement is met using double or reinforced insulation. The norms DIN 50178, VDE 0106 and 109 form the basis for safety separation. VDE 0884 also applies to solid-state relays.

All Wieland modules meet these requirements.

Timer relay modules

Wieland timer relays are electromechanical relays with an integrated time response. The time response is defined according to VDE 0435 section 201/5.83. The respective time range is either fixed or set via a DIP switch depending on the type. Fine-tuning within the time range can also be carried out via a potentiometer. An integrated LED indicates the switching state of the relay.

Definition of the time response

On delay

Operating voltage is applied; the relay switches to operating position after a set delay.

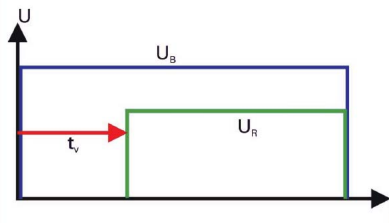

Operating voltage is applied; the relay remains in normal position

Off delay with control voltage

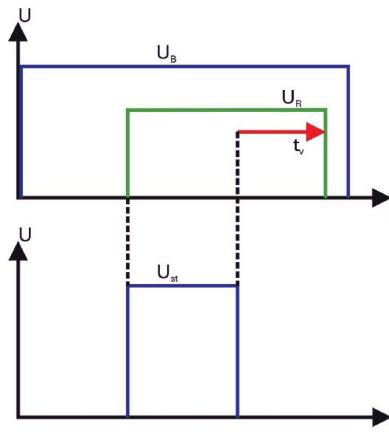

Control voltage is applied; the relay switches to operating position

Control voltage is interrupted; time delay is activated; the relay drops out after the period has elapsed.

Single Shot

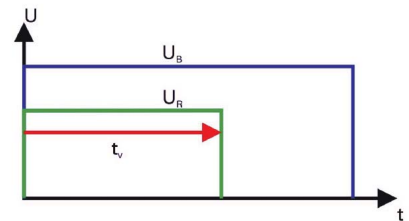

Operating voltage is applied; the relay switches to operating position and drops out after the set period

Cycle On – “pulsing”

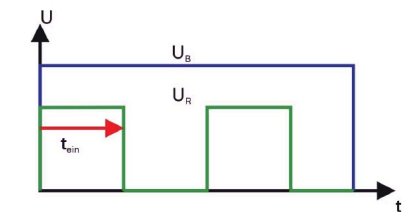

Operating voltage is applied; relay starts clock pulse operation over the set period; relationship between pulse and pause is 1:1

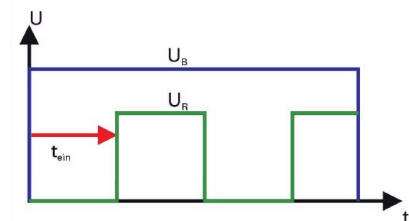

Cycle Off – “pulsing delay”

Operating voltage is applied; relay starts clock pause operation over the set period; relationship between pulse and pause is 1:1

Relay modules

flare



**250 V AC / 300 V DC, 6 A
1 Changeover contact (SPDT)**

Approvals: , CSA



**48 V DC, 20 mA
1 Changeover contact (SPDT)**

Approvals: , CSA

Overall width 6.2 mm
Screw or spring clamp terminal
can be selected
Dimensions (mm): W x H x D
6.2 x 89 x 70

Operating voltage	Screw terminal			Spring-clamp			Std. pack			
12 V DC				80.010.4106.0			10			
24 V DC	80.010.4000.0			80.010.4100.0			10			
12 V AC/DC										
24 V AC/DC							80.010.4005.0 80.010.4105.0 10			
115 V AC				80.010.4131.0			10			
230 V AC				80.010.4141.0			10			
Wiring diagram, derating curve, limit curve	See pages 464-465						See pages 464-465			
Coil circuit										
Operating voltage	12 V DC				24 V DC				115 V DC	230 V DC
Range of voltage					UB +25 %/-20 %					UB +25 %/-20 %
Nominal input current	18 mA				ca. 14 mA				3.9 mA	3 mA
Nominal input capacity	0.22 W				ca. 0.35 W				0.48 W	0.65 W
Holding current at 20 °C	≥ 2.3 mA				> 1.2 mA				≥ 0.6 mA	≥ 0.3 mA
Connectable via plug-in jumper	Up to 50 modules									Up to 50 modules
Status display	LED Green									LED Green
Switching characteristics										
Maximum switching voltage	250 V AC / 300 V DC									48 V DC
Maximum switching current	6 A AC / 2 A DC									20 mA
Maximum switching capacity	1500 VA / 48 W									1 W
Maximum starting current	10 A; 4 sec.									
Pickup/dropout delay	8 ms / 10 ms									8 ms / 10 ms
Chatter time	2 ms									2 ms
Maximum switching frequency	20 Hz									20 Hz
Contact material	AgSnO ₂									AgSnO ₂ + 3μ Au
Minimum switchable voltage	12 V									5 V
Minimum switchable current	5 mA									1 mA
Mechanical endurance	2 x 10 ⁷									2 x 10 ⁷
Electrical endurance 24 V DC / 2 A	6 x 10 ⁵									6 x 10 ⁵
Electrical endurance 230 V AC / 6 A	8 x 10 ⁴									8 x 10 ⁴
Rated voltage										
Isolation voltage of input/output	4 kV _{eff}									4 kV _{eff}
Overvoltage category	III (according to HD 625.1S1)									III (according to HD 625.1S1)
Degree of pollution	2 (according to HD 625.1S1)									2 (according to HD 625.1S1)
Ambient temperature	0 °C...+50 °C									0 °C...+50 °C
Storage temperature	-40 °C...+55 °C									-40 °C...+55 °C
Protection type/mounting rail	IP 20 / TS35									IP 20 / TS35
Norms/specifications	VDE 0160; VDE 0106 T101									VDE 0160; VDE 0106 T101
Emitted interference/interference immunity	EN 61000-6-3; EN 61000-6-2									EN 61000-6-3; EN 61000-6-2
Wire range of screw terminal/spring clamp terminal	24 – 10 AWG / 24 – 12 AWG									24 – 10 AWG / 24 – 12 AWG
finely stranded	0.14 mm ² – 1.5 mm ²									0.14 mm ² – 1.5 mm ²
single core	0.5 mm ² – 2.5 mm ²									0.5 mm ² – 2.5 mm ²
CSA EX approval	Class I, Division 2, Groups A, B, C and D, T6									Class I, Division 2, Groups A, B, C and D, T6
Accessories										
Plug-in jumper (U _{max} = 50 V, I _{max} = 2 A)					Z8.000.0200.8				Z8.000.0200.8	
8 digit marker tag, unmarked, 60 off					Z4.242.5153.0				Z4.242.5153.0	
Comb for potential distribution, red/blue*					Z8.000.0202.3 / Z8.000.0202.4				Z8.000.0202.3 / Z8.000.0202.4	
End caps for comb red/blue					Z8.000.0202.1 / Z8.000.0202.2				Z8.000.0202.1 / Z8.000.0202.2	
* for screw terminals only										

flare



Overall width 12.4 mm

Spring clamp

Dimensions (mm): W x H x D

6.2 x 89 x 70

**250 V AC / 300 V DC, 6 A (DPDT)
2 Changeover contacts**

Approvals: , CSA

Operating voltage	Screw terminal	Spring-clamp	Std. pack
12 V DC			
24 V DC		80.010.4103.0	10
12 V AC/DC			
24 V AC/DC			
115 V AC			
230 V AC			
Wiring diagram, derating curve, limit curve	See pages 464-465		
Coil circuit			
Operating voltage	UB +25 %/-20 %		
Nominal input current	ca. 14 mA		
Nominal input capacity	ca. 0.35 W		
Holding current at 20 °C	> 1.2 mA		
Connectable via plug-in jumper	Up to 50 modules		
Status display	LED Green		
Switching characteristics			
Maximum switching voltage	250 V AC / 300 V DC		
Maximum switching current	6 A AC / 2 A DC		
Maximum switching capacity	1500 VA / 48 W		
Maximum starting current	10 A; 4 sec.		
Pickup/dropout delay	8 ms / 10 ms		
Chatter time	2 ms		
Maximum switching frequency	20 Hz		
Contact material	AgSnO ₂		
Minimum switchable voltage	24 V		
Minimum switchable current	5 mA		
Mechanical endurance	2 x 10 ⁷		
Electrical endurance 24 V DC / 2 A	6 x 10 ⁵		
Electrical endurance 230 V AC / 6 A	8 x 10 ⁴		
Rated voltage			
Isolation voltage of input/output	4 kV _{eff.}		
overvoltage category	III (according to HD 625.1S1)		
Degree of pollution	2 (according to HD 625.1S1)		
Ambient temperature	0 °C...+50 °C		
Storage temperature	-40 °C...+55 °C		
Protection type/mounting rail	IP 20 / TS35		
Norms/specifications	VDE 0160; VDE 0106 T101		
Emitted interference/interference immunity	EN 61000-6-3; EN 61000-6-2		
Wire range of screw terminal/spring clamp terminal	24 – 10 AWG / 24 – 12 AWG		
finely stranded	0.14 mm ² – 1.5 mm ²		
single core	0.5 mm ² – 2.5 mm ²		
Accessories			
Plug-in jumper (U _{max} = 50 V, I _{max} = 2 A)	Z8.000.0200.8		
8 digit marker tag, unmarked, 60 off	Z4.242.5153.0		

Relay modules

Plug-in relays

flare MOVE



Overall width: 6.2 mm
plug-in relay, screw clamp

Dimensions (mm): W x H x D
6.2 x 88 x 76

**Coil voltage 12 V DC / Output
250 V AC / 6 A / 1 Changeover contact
(SPDT)**

**Coil voltage 24 V DC / Output
250 V AC / 6 A/1 Changeover contact
(SPDT)**

Operating voltage	AgSnO ₂	AgSnO ₂ + Au (5 μ)VPE	AgSnO ₂	AgSnO ₂ + Au (5 μ) VPE		
12 V DC Relays c/w Base	80.010.4501.0	80.010.4501.1 10				
24 V DC Relays c/w Base			80.010.4502.0	80.010.4502.1 10		
Coil circuit (identical for both types of contact material)						
Nominal operating voltage	12 V DC	12 V AC/DC	24 V DC	24 V AC/DC		
Maximum operating voltage	16.8 V DC	16.8 V DC	33.6 V DC	33.6 V DC		
Minimum operating voltage	8.4 V DC	9.1 V DC	16.8 V DC	18.2 V DC		
Nominal input current	15.2 mA	15.2 mA	9.4 mA	9.4 mA		
Nominal input capacity AC/DC	0.2 W	0.25 VA	0.23 W	0.3 VA		
Operating range	(0.7...2.2) U _N	(0.85...1.1) U _N	(0.7...2.2) U _N	(0.85...1.1) U _N		
Connectable via plug-in jumper	Up to 20 modules		Up to 20 modules			
Status display	LED Green		LED Green			
Switching characteristics	AgSnO₂	AgSnO₂ + Au (5 μ)	AgSnO₂	AgSnO₂ + Au (5 μ)		
Maximum switching voltage	400 V AC		400 V AC			
Nominal switching voltage	250 V AC		250 V AC			
Maximum switching current	6 A AC/DC		6 A AC/DC			
Maximum switching capacity	1500 VA / 150 W		1500 VA / 150 W			
Maximum starting current	30 A (0.5 sec.)		30 A (0.5 sec.)			
Pickup/dropout delay (including chatter)	7 ms / 11 ms		7 ms / 11 ms			
Maximum switching frequency	20 Hz (without load); 0.1 Hz (at full load)		20 Hz (without load); 0.1 Hz (at full load)			
Contact material	AgSnO ₂	AgSnO ₂ + Au (5 μm)	AgSnO ₂	AgSnO ₂ + Au (5 μm)		
Minimum switchable voltage	12 V AC/DC	5 V AC/DC	12 V AC/DC	5 V AC/DC		
Minimum switchable current	10 mA AC/DC	2 mA AC/DC	10 mA AC/DC	2 mA AC/DC		
Minimum switching capacity	500 mW	50 mW	500 mW	50 mW		
Mechanical endurance	1 x 10 ⁷		1 x 10 ⁷			
Electrical endurance 230 V AC / 6 A	6 x 10 ⁴		6 x 10 ⁴			
Rated voltage	250 V		250 V			
Isolation voltage of input/output	4 kV _{eff.}		4 kV _{eff.}			
Overvoltage category	III (according to HD 625.1S1)		III (according to HD 625.1S1)			
Degree of pollution	2 (according to HD 625.1S1)		2 (according to HD 625.1S1)			
Ambient temperature	0 °C...+50 °C		0 °C...+50 °C			
Storage temperature	-40 °C...+55 °C		-40 °C...+55 °C			
Protection type/mounting rail	IP 20 / TS35		IP 20 / TS35			
Norms/specifications						
Wire range of screw terminal: finely stranded/single core	24 – 12 AWG 0.14 mm ² –1.5 mm ² / 0.5 mm ² –2.5 mm ²		24 – 12 AWG 0.14 mm ² –1.5 mm ² / 0.5 mm ² –2.5 mm ²			
Accessories	Relay type	Part no.	Std. pack	Relay-Type	Part no.	Std. pack
Relay 12 V DC	AgSnO ₂	80.063.4031.0	10	AgSnO ₂	80.063.4031.0	10
Relay 12 V DC	AgSnO ₂ + Au (5 μ)	80.063.4031.1	10	AgSnO ₂ + Au (5 μ)	80.063.4031.1	10
Relay 24 V DC	AgSnO ₂	80.063.4032.0	10	AgSnO ₂	80.063.4032.0	10
Relay 24 V DC	AgSnO ₂ + Au (5 μ)	80.063.4032.1	10	AgSnO ₂ + Au (5 μ)	80.063.4032.1	10
Insulating plate	IP SF38	80.063.4009.1		IP SF38	80.063.4009.1	
Comb-shaped jumper, continuous current 36 A	KB SF38	80.063.4029.3		KB SF38	80.063.4029.3	
Marker tag (plastic, white)	BZ SF38	80.063.4029.3		BZ SF38	80.063.4029.3	
Labelling mat	BM SF38	80.063.4129.3		BM SF38	80.063.4129.3	

flare MOVE



Overall width: 6.2 mm
plug-in relay, screw clamp

Dimensions (mm): W x H x D
6.2 x 88 x 76

**Coil voltage 110 V AC/DC / Output
250 V AC / 6 A / 1 Changeover contact
(SPDT)**

**Coil voltage 230 V AC/DC/Output
250 V AC / 6 A/1 Changeover contact
(SPDT)**

Operating voltage	AgSnO ₂	AgSnO ₂ + Au (5 μ)	AgSnO ₂	AgSnO ₂ + Au (5 μ)		
110 V AC/DC Relay c/w Base	80.010.4525.0	80.010.4525.1				
230 V AC/DC Relay c/w Base			80.010.4526.0	80.010.4526.1		
Coil circuit						
Nominal operating voltage	110 V AC/DC (50/60 Hz)		230 V AC/DC (50/60 Hz)			
Maximum operating voltage	132 V AC		255 V AC			
Minimum operating voltage	83.5 V AC		175 V AC			
Nominal input current	3.1 mA		3.1 mA			
Nominal input capacity AC/DC	0.6 VA		0.9 VA			
Operating range	(0.85...1.1) U _N		(0.85...1.1) U _N			
Connectable via a plug-in jumper	Up to 20 modules		Up to 20 modules			
Status display	LED Green		LED Green			
Switching characteristics						
	AgSnO ₂	AgSnO ₂ + Au (5 μ)	AgSnO ₂	AgSnO ₂ + Au (5 μ)		
Maximum switching voltage	400 V AC		400 V AC			
Nominal switching voltage	250 V AC		250 V AC			
Maximum switching current	6 A AC/DC		6 A AC/DC			
Maximum switching capacity	1500 VA / 150 W		1500 VA / 150 W			
Maximum starting current	30 A (0.5 sec.)		30 A (0.5 sec.)			
Pickup/dropout delay (including chatter)	7 ms / 11 ms		7 ms / 11 ms			
Maximum switching frequency	20 Hz (without load); 0.1 Hz (at full load)		20 Hz (without load); 0.1 Hz (at full load)			
Contact material	AgSnO ₂	AgSnO ₂ + Au (5 μm)	AgSnO ₂	AgSnO ₂ + Au (5 μm)		
Minimum switchable voltage	12 V AC/DC	5 V AC/DC	12 V AC/DC	5 V AC/DC		
Minimum switchable current	10 mA AC/DC	2 mA AC/DC	10 mA AC/DC	2 mA AC/DC		
Minimum switching capacity	500 mW	50 mW	500 mW	50 mW		
Mechanical endurance	1 x 10 ⁷		1 x 10 ⁷			
Electrical endurance 230 V AC / 6 A	6 x 10 ⁴		6 x 10 ⁴			
Rated voltage	250 V		250 V			
Isolation voltage of input/output	4 kV _{eff}		4 kV _{eff}			
Overvoltage category	III (according to HD 625.1S1)		III (according to HD 625.1S1)			
Degree of pollution	2 (according to HD 625.1S1)		2 (according to HD 625.1S1)			
Ambient temperature	0 °C...+50 °C		0 °C...+50 °C			
Storage temperature	-40 °C...+55 °C		-40 °C...+55 °C			
Protection type/mounting rail	IP 20 / TS35		IP 20 / TS35			
Norms/specifications						
Wire range of screw terminal:						
finely stranded/single core	0.14 mm ² – 1.5 mm ² / 0.5 mm ² – 2.5 mm ² 24 – 12 AWG		0.14 mm ² – 1.5 mm ² / 0.5 mm ² – 2.5 mm ² 24 – 12 AWG			
Accessories						
	Relay-Type	Part no.	Std. pack	Relay-Type	Part no.	Std. pack
Relay 110 V AC/DC	AgSnO ₂	80.063.4034.0	10	AgSnO ₂	80.063.4034.0	10
Relay 110 V AC/DC	AgSnO ₂ + Au (5 μ)	80.063.4034.1	10	AgSnO ₂ + Au (5 μ)	80.063.4034.1	10
Relay 230 V AC/DC	AgSnO ₂	80.063.4026.0	10	AgSnO ₂	80.063.4026.0	10
Relay 230 V AC/DC	AgSnO ₂ + Au (5 μ)	80.063.4026.1	10	AgSnO ₂ + Au (5 μ)	80.063.4026.1	10
Insulating plate	IP SF38	80.063.4009.1		IP SF38	80.063.4009.1	
Comb-shaped jumper, continuous current 36 A	KB SF38	80.063.4029.3		KB SF38	80.063.4029.3	
Marker tag (plastic, white)	BZ SF38	80.063.4029.3		BZ SF38	80.063.4029.3	
Labelling mat	BM SF38	80.063.4129.3		BM SF38	80.063.4129.3	

Relay modules

flare



Overall width 6.2 mm
For input/output separation

Dimensions (mm): W x H x D
6.2 x 89 x 70

**Isolating blade terminal relay (SPDT)
Change over 1 contact**
Approvals: , CSA

**Hand-O-Auto relay (SPDT)
1 make contact**
Approvals: , CSA

Operating voltage	Screw terminal	Spring-clamp Std. pack	Screw terminal	Spring-clamp Std. pack
12 V DC				
24 V DC				
12 V AC/DC				
24 V AC/DC		80.010.4120.0 10		80.010.4101.0 10
115 V AC				
230 V AC				
Wiring diagram, derating curve, limit curve	See pages 464-465		See pages 464-465	
Coil circuit				
Operating voltage	UB +25 %/-20 %		UB +25 %/-20 %	
Nominal input current	ca. 14 mA		ca. 14 mA	
Nominal input capacity	ca. 0.35 W		ca. 0.35 W	
Holding current at 20 °C	> 1.2 mA		> 1.2 mA	
Connectable via plug-in jumper	Up to 50 modules		Up to 50 modules	
Status display	LED Green		LED Green	
Switching characteristics				
Maximum switching voltage	250 V AC / 300 V DC		250 V AC / 300 V DC	
Maximum switching current	6 A AC / 2 A DC		6 A AC / 2 A DC	
Maximum switching capacity	1500 VA / 48 W		1500 VA / 48 W	
Maximum starting current	10 A; 4 sec.		10 A; 4 sec.	
Pickup/dropout delay	8 ms / 10 ms		8 ms / 10 ms	
Chatter time	2 ms		2 ms	
Maximum switching frequency	20 Hz		20 Hz	
Contact material	AgSnO ₂		AgSnO ₂	
Minimum switchable voltage	12 V		12 V	
Minimum switchable current	5 mA		5 mA	
Mechanical endurance	2 x 10 ⁷		2 x 10 ⁷	
Electrical endurance 24 V DC / 2 A	6 x 10 ⁵		6 x 10 ⁵	
Electrical endurance 230 V AC / 6 A	8 x 10 ⁴		8 x 10 ⁴	
Rated voltage				
Isolation voltage of input/output	4 kV _{eff}		4 kV _{eff}	
Overvoltage category	III (according to HD 625.1S1)		III (according to HD 625.1S1)	
Degree of pollution	2 (according to HD 625.1S1)		2 (according to HD 625.1S1)	
Ambient temperature	0 °C...+50 °C		0 °C...+50 °C	
Storage temperature	-40 °C...+55 °C		-40 °C...+55 °C	
Protection type/mounting rail	IP 20 / TS35		IP 20 / TS35	
Norms/specifications	VDE 0160; VDE 0106 T101		VDE 0160; VDE 0106 T101	
Emitted interference/interference immunity	EN 61000-6-3; EN 61000-6-2		EN 61000-6-3; EN 61000-6-2	
Wire range of screw terminal	-		-	
Wire range of spring clamp terminal	24 - 12 AWG		24 - 12 AWG	
finely stranded	0.14 mm ² - 1.5 mm ²		0.14 mm ² - 1.5 mm ²	
single core	0.5 mm ² - 2.5 mm ²		0.5 mm ² - 2.5 mm ²	
CSA EX approval in range	Class I, Division 2, Groups A, B, C and D, T6		Class I, Division 2, Groups A, B, C and D, T6	
Accessories				
Plug-in jumper (U _{max.} = 50 V, I _{max.} = 2 A)	Z8.000.0200.8		Z8.000.0200.8	
8 digit marker tag, unmarked, 60 off	Z4.242.5153.0		Z4.242.5153.0	
Comb for potential distribution, red/blue	Z8.000.0202.3 / Z8.000.0202.4		Z8.000.0202.3 / Z8.000.0202.4	
End caps for comb, red/blue	Z8.000.0202.1 / Z8.000.0202.2		Z8.000.0202.1 / Z8.000.0202.2	

Relay modules



Relay output modules

- 1 relay
- 4 relay
- 8 relay
- 16 relay



**250 V AC / 24 V DC 5 A (SPDT)
1 Changeover contact**

Approvals:
12.5 x 80 x 58.3

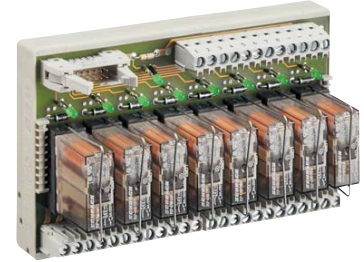

**250 V AC / 24 V DC 5 A (SPDT)
1 Changeover contact**

Approvals:
70/128/280 x 80 x 71

Dimensions (mm): W x H x D

Description	Type	Part no.	Std. pack	Type	Part no.	Std. pack
1 relay	R12-12V-1W-250V5A	87.220.7553.0	10			
4 relay positive switching				RAB-SS 4	87.220.1853.0	1
8 relay positive switching				RAB-FSS 8	87.220.1953.3	1
16 relay positive switching				RAB-FSS 16	87.220.2253.3	1
4 relay negative switching				RAB-SS 4 M	87.221.5553.0	1
Wiring diagram, derating curve, limit curve	See page 469			See page 469		
Coil circuit						
Operating voltage	12 V AC/DC ±10%			24 V DC +10%/−15%		
Nominal input current per input	34 mA			25 mA		
Nominal power consumption	0.4 W			0.6 W		
Holding current at 20 °C	> 3.5 mA			> 2 mA		
Status display	LED Green			LED Green		
Switching characteristics						
Maximum switching voltage	250 V AC / ¹⁾ 1V DC			250 V AC / ¹⁾ 1V DC		
Maximum switching current	8 A AC/ ¹⁾ A DC			8 A AC/ ¹⁾ A DC		
Maximum switching capacity	2000 VA / 120 W			2000 VA / 120 W		
Maximum continuous current	5 A AC/DC ¹⁾			5 A AC/DC ¹⁾		
Pickup/dropout delay approx	9 ms / 12 ms			9 ms / 12 ms		
Chatter time	4 ms			4 ms		
Maximum switching frequency	40 Hz			40 Hz		
Contact material	AgCdO			AgCdO		
Minimum switchable voltage	12 V			12 V		
Minimum switchable current	100 mA			100 mA		
Mechanical endurance	3 x 10 ⁷			3 x 10 ⁷		
Electrical endurance at 24 V DC / 5 A	6 x 10 ⁵			6 x 10 ⁵		
Electrical endurance at 230 V AC / 5 A	6 x 10 ⁵			6 x 10 ⁵		
Rated voltage						
Isolation voltage of input/output	4 kV _{eff.}			4 kV _{eff.}		
Overvoltage category						
Degree of pollution						
Ambient temperature	−25 °C...Derating			−25 °C...Derating		
Storage temperature	−40 °C...+85 °C			−40 °C...+85 °C		
Mounting rail	TS 32 or TS 35			TS 32 or TS 35		
Norms/specifications						
Emitted interference/interference immunity						
Wire range, finely stranded/single core	0.5 mm ² – 2.5 mm ² / 0.5 mm ² – 4 mm ² / 22 – 12 AWG			0.5 mm ² – 2.5 mm ² / 0.5 mm ² – 4 mm ² / 22 – 12 AWG		
Location of mounting rail	horizontal			horizontal		
Accessories						
Replacement relay				Z8.000.0056.9 10		
¹⁾ See limit curve on page 465						

Relay output modules

- 1 relay
- 4 relay
- 8 relay
- 16 relay

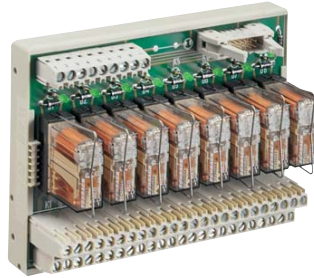

Important note for user:

In the case of multiple modules (1 changeover contact/2 changeover contacts), the outputs must be supplied from the same phase (e.g. L1)

250 V AC / 24 V DC, 5 A (DPDT) 2 Changeover contacts

Approvals:

70/128 x 80 x 71

Dimensions (mm): W x H x D

Description	Type	Part no.	Std. pack
1 relay			
4 relay positive switching	RAB-SS 4/2	87.220.4753.3	1
8 relay positive switching	RAB-SS 8/2	87.220.4853.3	1
6 relay positive switching			
4 relay negative switching			
Wiring diagram, derating curve, limit curve	See page 469		
Coil circuit			
Operating voltage	24 V DC + 10 %/- 15 %		
Nominal input current	25 mA		
Nominal power consumption	0.6 W		
Holding current at 20 °C	> 2 mA		
Status display	LED Green		
Switching characteristics			
Maximum switching voltage	250 V AC / ¹⁾ 1V DC		
Maximum switching current	8 A AC/ ¹⁾ A DC		
Maximum switching capacity	2000 VA / 120 W		
Maximum continuous current	5 A AC/DC ¹⁾		
Pickup/dropout delay approx.	9 ms / 12 ms		
Chatter time	4 ms		
Maximum switching frequency	40 Hz		
Contact material	AgCdO		
Minimum switchable voltage	12 V		
Minimum switchable current	100 mA		
Mechanical endurance	3 x 10 ⁷		
Electrical endurance at 24 V DC / 5 A	6 x 10 ⁵		
Electrical endurance at 230 V AC / 5 A	6 x 10 ⁵		
Rated voltage			
Isolation voltage of input/output	4 kV _{eff.}		
Overvoltage category			
Degree of pollution			
Ambient temperature	-25 °C...Derating		
Storage temperature	-40 °C...+85 °C		
Mounting rail	TS 32 or TS 35		
Norms/specifications			
Emitted interference/interference immunity			
Wire range, finely stranded/single-core	0.5 mm ² – 2.5 mm ² / 0.5 mm ² – 4 mm ² / 22 – 12 AWG		
Location of mounting rail	horizontal		
Accessories			
Replacement relay		Z8.000.0035.5	10
¹⁾ See limit curve on page 465			

Relay modules



Relay modules input/output

- 1 relay
- 4 relay
- 8 relay



**250 V AC / 24 V DC 4 A (SPDT)
1 Changeover contact**

Approvals:
12.5 x 80 x 70

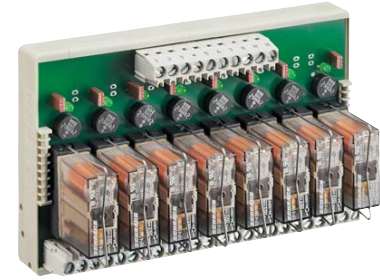

**250 V AC / 24 V DC 4 A (SPDT)
1 Changeover contact**

Approvals:
70/128 x 80 x 71

Dimensions (mm): W x H x D

Description	Type	Part no.	Std. pack	Type	Part no.	Std. pack
1 relay		WR1-230-1W-250V4A	80.010.0011.0	10		
4 relay					WR4-115-1W-250V4A	80.010.1102.0
8 relay					WR8-115-1W-250V4A	80.010.1110.0
						1
						1
Wiring diagram, derating curve, limit curve	See pages 470-471			See pages 470-471		
Coil circuit						
Operating voltage	230 V AC +6% / -10%			115 V AC +6% / -10%		
Nominal input current per input	ca. 4.5 mA AC			ca. 8.5 mA AC/DC		
Nominal power consumption	ca. 1.0 VA			ca. 0.95 VA/W		
Holding current at 20 °C	> 0.9 mA AC			> 1.3 mA AC / > 1.0 mA DC		
Suppression circuit for input	polarised diode, suppressor diode			polarised diode, suppressor diode		
Status display	LED Green			LED Green		
Switching characteristics						
Maximum switching voltage	250 V AC / ¹⁾ V DC			250 V AC / ¹⁾ V DC		
Maximum switching current	8 A AC/ ¹⁾ A DC			8 A AC/ ¹⁾ A DC		
Maximum switching capacity	2000 VA / 192 W			2000 VA / 192 W		
Maximum continuous current	4 A AC/DC			4 A AC/DC		
Pickup/dropout delay approx.	10 ms / 15 ms			12 ms / 13 ms		
Chatter time	4 ms			4,5 ms		
Maximum switching frequency	40 Hz			40 Hz		
Contact material	AgNi + 4...6 µ Au			AgNi 0.15 + 0.2 µ Au		
Minimum switchable voltage	µV			5 V		
Minimum switchable current	µA			10 mA		
Mechanical endurance	3 x 10 ⁷			3 x 10 ⁷		
Electrical endurance at 24 V DC / 4 A	3 x 10 ⁵			3 x 10 ⁵		
Electrical endurance at 230 V AC / 4 A	3 x 10 ⁵			3 x 10 ⁵		
Rated voltage						
Isolation voltage of input/output	4 kV _{eff.}			4 kV _{eff.}		
Overvoltage category						
Degree of pollution						
Ambient temperature	-25 °C...Derating			-25 °C...+50 °C		
Storage temperature	-40 °C...+80 °C			-40 °C...+80 °C		
Mounting rail	TS 32 or TS 35			TS 32 or TS 35		
Norms/specifications						
Emitted interference/interference immunity						
Wire range, finely stranded/single-core	0.5 mm ² - 2.5 mm ² / 0.5 mm ² - 4 mm ² / 22 - 12 AWG			0.5 mm ² - 2.5 mm ² / 0.5 mm ² - 4 mm ² / 22 - 12 AWG		
Location of mounting rail	horizontal			horizontal		
Accessories						
Replacement relay				Z8.000.0181.0		
				10		
¹⁾ See limit curve on page 465						

Relay module input/output

- 1 relay
- 4 relay
- 8 relay

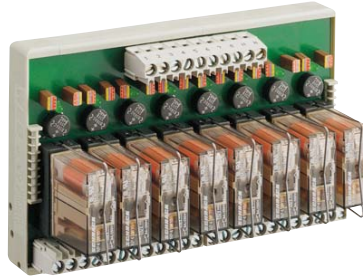

**250 V AC / 24 V DC 4 A (SPDT)
1 Changeover contact**

Approvals:
70/128 x 80 x71

Dimensions (mm): W x H x D

Description	Type	Part no.	Std. pack
1 relay			
4 relay	WR4-230-1W-250V4A	80.010.1106.0	1
8 relay	WR8-230-1W-250V4A	80.010.1114.0	1
Wiring diagram, derating curve, limit curve See pages 470-471			
Coil circuit			
Operating voltage	230 V AC/DC +6%/-10%		
Nominal input current per input	approx. 4.5 mA AC/DC		
Nominal power consumption	approx. 1.0 VA/W		
Holding current at 20 °C	> 0.7 mA AC / > 0.5 mA DC		
Suppression circuit for input	polarised diode, suppressor diode		
Status display	LED Green		
Switching characteristics			
Maximum switching voltage	250 V AC / ¹⁾ V DC		
Maximum switching current	8 A AC / ¹⁾ A DC		
Maximum switching capacity	2000 VA / 192 W		
Maximum continuous current	4 A AC/DC		
Pickup/dropout delay approx.	12 ms / 13 ms		
Chatter time	4.5 ms		
Maximum switching frequency	40 Hz		
Contact material	AgNi 0.15 + 0.2 µ Au		
Minimum switchable voltage	5 V		
Minimum switchable current	10 mA		
Mechanical endurance	3 x 10 ⁷		
Electrical endurance at 24 V DC / 4 A	3 x 10 ⁶		
Electrical endurance at 230 V AC / 4 A	3 x 10 ⁶		
Rated voltage			
Isolation voltage of input/output	4 kV _{eff.}		
Overvoltage category			
Degree of pollution			
Ambient temperature	-25 °C...+50 °C		
Storage temperature	-40 °C...+80 °C		
Mounting rail	TS 32 or TS 35		
Norms/specifications			
Emitted interference/interference immunity			
Wire range, finely stranded/single-core	0,5 mm ² – 2,5 mm ² / 0,5 mm ² – 4 mm ² / 22 – 12 AWG		
Location of mounting rail	horizontal		
Accessories			
Replacement relay		Z8.000.0181.0	10
¹⁾ See limit curve on page 465			

Relay modules input/output

- 1 relay
- 4 relay
- 8 relay

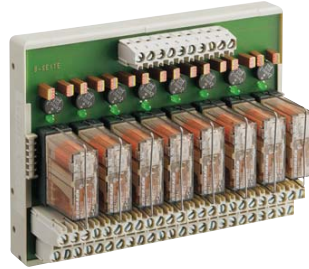

250 V AC / 24 V DC 4 A (DPDT) 2 Changeover contacts

Approvals of the relays:

70/128 x 80 x 71

Dimensions (mm): W x H x D

Description	Type	Part no.	Std. pack	Type	Part no.	Std. pack
1 relay						
4 relay	WR4-230-2W-250V4A	80.010.1108.0	1			
8 relay	WR8-230-2W-250V4A	80.010.1116.0	1			
Wiring diagram, derating curve, limit curve	See pages 468-469					
Coil circuit						
Operating voltage	230 V AC/DC +6%/-10%					
Nominal input current per input	ca. 4.5 mA AC/DC					
Nominal input capacity	ca. 1.0 VA/W					
Holding current at 20 °C	> 0.7 mA AC / > 0.5 mA DC					
Suppression circuit for input	polarised diode, suppressor diode					
Status display	LED Green					
Switching characteristics						
Maximum switching voltage	0250 V AC / ¹⁾ V DC					
Maximum continuous current	6 A AC / ¹⁾ A DC					
Maximum switching capacity	1500 VA / 192 W					
Maximum switching current	4 A AC/DC (Derating beachten)					
Pickup/dropout delay approx.	< 13 ms / < 16 ms					
Chatter time	< 4,5 ms					
Maximum switching frequency						
Contact material	AgNi 0,15 + 0,2 µ Au					
Minimum switchable voltage	5 V					
Minimum switchable current	10 mA					
Mechanical endurance	3 x 10 ⁷					
Electrical endurance at 24 V DC / 5 A	1.5 x 10 ⁵					
Electrical endurance at 230 V AC / 5 A	1.5 x 10 ⁵					
Rated voltage						
Isolation voltage of input/output	4 kV _{eff.}					
Overvoltage category						
Degree of pollution						
Ambient temperature	-25 °C...Derating					
Storage temperature	-40°C...+80 °C					
Mounting rail	TS 32 or TS 35					
Norms/specifications						
Emitted interference/interference immunity						
Wire range, finely stranded/single-core	0.5 mm ² - 2.5 mm ² / 0.5 mm ² - 4 mm ² / 22 -12 AWG					
Location of mounting rail	horizontal					
Accessories						
Replacement relay		Z8.000.0176.2	10			
¹⁾ See limit curve on page 465						

Relay modules

Wieland Relay System

WRS

- 24 V input signal
- 4 kV separation between I/O at a creepage and clearance distance of 8 mm



250 V AC/DC 5 A 48 V DC 20 mA
1 Make contact (SPST, N.O.)

Approvals: CSA,
12.5 x 80 x 58.3



250 V AC/DC 5 A 48 V DC 20 mA
1 Changeover contact (SPDT)

Approvals: CSA,
12.5 x 80 x 60

Dimensions (mm): W x H x D

Description	Type	Part no.	Std. pack	Type	Part no.	Std. pack
WRS Relay system	WRS-REL-1S-250V5A	80.010.0005.0	10	WRS-REL-1W-250V5A	80.010.0008.0	10
WRS Relay system	WRS-REL-1S-48V20M	80.010.0007.0	10	WRS-REL-1W-48V20M	80.010.0009.0	10
WRS high-current relays						
Wiring diagram, derating curve, limit curve	See pages 472-473			See pages 472-473		
Coil circuit						
Operating voltage	24 V AC/DC +10%/-15%			24 V DC +10%/-15%		
Nominal input current	25 mA			25 mA		
Nominal power consumption	ca. 0.6 W/VA			ca. 0.6 W/VA		
Holding current at 20 °C	≥ 2 mA			≥ 2 mA		
Parallel connection of max.	20 Relays			20 Relays		
Suppression circuit of input	polarised diode, suppressor diode			polarised diode, suppressor diode		
Status display	LED Green			LED Green		
Switching characteristics	Output	Input		Output	Input	
Maximum switching voltage	250 V AC/DC ²⁾	48 V DC		250 V AC/DC ²⁾	48 V DC	
Maximum switching current	8 A AC/DC ²⁾	20 mA		8 A AC/DC ²⁾	20 mA	
Maximum switching capacity	2000 VA / 192 W	1.2 W		2000 VA / 192 W	1.2 W	
Maximum continuous current	5 A AC/DC			5 A AC/DC		
Pickup/dropout delay approx	8 ms / 8 ms	10 ms / 10 ms		8 ms / 8 ms	10 ms / 10 ms	
Chatter time	3 ms	3 ms		3 ms	3 ms	
Contact material	AgCdO	AgNi 0.15 + 10 µ Au		AgCdO	AgNi 0,15 + 10 µ Au	
Minimum switchable voltage	12 V	µV		12 V	µV	
Minimum switchable current	100 mA	µA		100 mA	µA	
Mechanical endurance	3 x 10 ⁷	3 x 10 ⁷		3 x 10 ⁷	3 x 10 ⁷	
Electrical endurance at 26 V DC / 15 mA		3 x 10 ⁵			3 x 10 ⁵	
Electrical endurance at 24 V DC / 5 A	2.5 x 10 ⁵			2.5 x 10 ⁵		
Electrical endurance at 230 V AC / 5 A	2.5 x 10 ⁵			2.5 x 10 ⁵		
Rated voltage						
Isolation voltage of input/output	4 kV _{eff}	4 kV _{eff}		4 kV _{eff}	4 kV _{eff}	
Overvoltage category						
Degree of pollution						
Ambient temperature	-25°C...Derating	-25 °C...+50 °C		-25 °C...Derating	-25 °C...+50 °C	
Storage temperature	-40 °C...+85 °C	-40 °C...+85 °C		-40 °C...+85 °C	-40 °C...+85 °C	
Mounting rail	TS 32 or TS 35			TS 32 or TS 35		
Norms/specifications						
Emitted interference/interference immunity						
Wire range, finely stranded/single-core	0.5 mm ² - 2.5 mm ² / 0.5 mm ² - 4 mm ² / 22 - 12 AWG			0.5 mm ² - 2.5 mm ² / 0.5 mm ² - 4 mm ² / 22 - 12 AWG		
Location of mounting rail	horizontal			horizontal		
Accessories						
Plug-in jumper (I _{max} = 0.5 A AC/DC)		Z8.000.0103.4	10		Z8.000.0103.4	10
²⁾ See d.c. limit curve on page 471						

Relay modules

Timer relay

flare

- Multifunction timer relay
- on delay
 - Single Shot
 - Cycle Off - pulsing
 - Cycle On - pulsing
 - off delay
 - timer range 0.1 sec - 300 sec

- Timer relay on delay
- timer range 1 - 100 sec, 1 - 100 min

Dimensions (mm): W x H x D
6.2 x 89 x 70



Multifunction / On delay/off delay, Single Shot, cycle / 1 make contact (SPST N.O.)

Approvals: CSA

Timer on delay relay

Approvals: CSA

Time range	Screw terminal		Spring-clampStd. pack		Screw terminal		Spring-clampStd. pack	
0.1 - 300 sec			81.020.4100.0	10				
1 - 100 sec					81.020.4101.0		10	
1 - 100 min					81.020.4102.0		10	
Wiring diagram, derating curve, limit curve	See pages 474				See pages 474			
Coil circuit								
Operating voltage	24 V DC +10%/-15%				24 V DC +10%/-15%			
Control voltage (TRIGGER)	24 V DC +10%/-15%				24 V DC +10%/-15%			
Nominal current	ca. 10 mA				ca. 10 mA			
Time setting	At the front (behind the hinged identification plate holder)				At the front (behind the hinged identification plate holder)			
Setting of function	DIP switch S1-S5/potentiometer				Potentiometer			
Status display	LED Green				Green LED			
Repeat accuracy	± 1% of selected range				± 1% of selected range			
Switching characteristics								
Maximum switching voltage	250 V AC / 300 V DC				250 V AC / 300 V DC			
Maximum switching current	6 A AC / 2 A DC				6 A AC / 2 A DC			
Maximum switching capacity	1500 VA / 48 W				1500 VA / 48 W			
Maximum starting current	10 A; 4 sec.				10 A; 4 sec.			
Pickup/dropout delay	1 ms / 5 ms				1 ms / 5 ms			
Chatter time	2 ms				2 ms			
Maximum switching frequency	20 Hz				20 Hz			
Contact material	AgSnO ₂				AgSnO ₂			
Minimum switchable voltage	12 V				12 V			
Minimum switchable current	8 mA				8 mA			
Mechanical endurance	2 x 10 ⁷				2 x 10 ⁷			
Electrical endurance 24 V DC / 2 A	6 x 10 ⁵				6 x 10 ⁵			
Electrical endurance 230 V AC / 6 A	8 x 10 ⁴				8 x 10 ⁴			
Rated voltage								
Isolation voltage of input/output	4 kV _{eff.}				4 kV _{eff.}			
Overvoltage category	III (according to HD 625.1S1)				III (according to HD 625.1S1)			
Degree of pollution	2 (according to HD 625.1S1)				2 (according to HD 625.1S1)			
Ambient temperature	0 °C...+50 °C				0 °C...+50 °C			
Storage temperature	-40 °C...+80 °C				-40 °C...+80 °C			
Protection type/mounting rail	IP 20 / TS35				IP 20 / TS35			
Norms/specifications	VDE 0160; VDE 0106 T101				VDE 0160; VDE 0106 T101			
Emitted interference/interference immunity	EN 61000-6-3; EN 61000-6-2				EN 61000-6-3; EN 61000-6-2			
Wire range of screw terminals	-				-			
Wire range of spring clamp terminals	24 - 12 AWG				24 - 12 AWG			
finely stranded	0.14 mm ² - 1.5 mm ²				0.14 mm ² - 1.5 mm ²			
single core	0.5 mm ² - 2.5 mm ²				0.5 mm ² - 2.5 mm ²			
CSA EX	Class I, Division 2, Groups A, B, C and D, T6				Class I, Division 2, Groups A, B, C and D, T6			
Accessories								
Plug-in jumper (U _{max.} = 50 V, I _{max.} = 2 A)	Z8.000.0200.8				Z8.000.0200.8			
8 digit marker tag, unmarked, 60 off	Z4.242.5153.0				Z4.242.5153.0			
Comb for potential distribution, red/blue	Z8.000.0202.3 / Z8.000.0202.4				Z8.000.0202.3 / Z8.000.0202.4			
End caps for comb, red/blue	Z8.000.0202.1 / Z8.000.0202.2				Z8.000.0202.1 / Z8.000.0202.2			

WRS

- Multifunction time relay
- on delay
 - Single Shot
 - Cycle on, pulsing
 - off delay
 - timer range 0.1 sec – 255 sec



WRS Multifunction timer relay / 1 Changeover contact (SPDT)

Approvals: CSA,

Dimensions (mm): W x H x D
38.7 x 80 x 60

Multi function	Screw terminal	Spring-clamp	Std. pack
0.10 – 255.0 sec	WRS-TIMER-250V5A	81.020.3000.0	10
Wiring diagram, derating curve, limit curve	See pages 475		
Coil circuit			
Operating voltage	24 V DC +10%/-15%		
Nominal input current	8.2/29 mA inactive/active		
Suppression circuit of input	Polarised diode		
Status display			
	Input	LED Green	
	Output	LED red	
Time setting	Potentiometer		
Parallel connection of max	20 Relays		
Switching characteristics			
Maximum switching voltage	250 V AC / V DC ¹⁾		
Maximum switching current	6 A AC / V DC ¹⁾		
Maximum switching capacity	1500 VA / 192 W ¹⁾		
Maximum continuous current	5 A AC / DC ¹⁾		
Pickup/dropout delay approx.	10 ms / 5 ms		
Chatter time	3 ms		
Contact material	AgNi 0.15 + 0.2 µ Au		
Minimum switchable voltage	5 V		
Minimum switchable current	10 mA		
Mechanical endurance	3 x 10 ⁷		
Electrical endurance at 24 V DC / continuous current	1.5 x 10 ⁵		
Electrical endurance at 230 V AC / continuous current	1.5 x 10 ⁵		
Insulation voltage of input/output	4 kV _{eff.}		
Ambient temperature	-25 °C...+50 °C		
Storage temperature	-40 °C...+85 °C		
Wire range	22 - 12 AWG		
finely stranded	0.5 mm ² – 2.5 mm ²		
single core	0.5 mm ² – 4 mm ²		
Mounting rail	TS 32 or TS 35		
Location of mounting rail	horizontal		
Accessories			
Plug-in jumper (I _{max} = 0.5 A AC/DC)	Z8.000.0103.4		10
¹⁾ See limit curve on page 471			

Wiring diagrams: *flare* – Mechanical relay modules

12-V-/24-V-Relay
1 Changeover contact (SPDT)

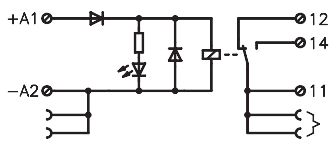

110-V-/230-V-Relay
1 Changeover contact (SPDT)

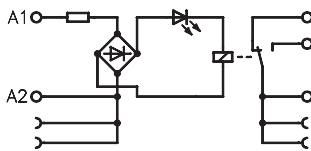

24-V-Relay
2 Changeover contact (DPDT)

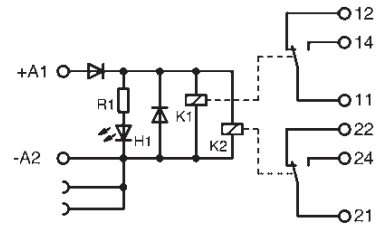

Isolating blade terminal relay
(SPDT)

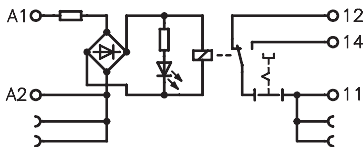

Hand-0-Auto-Relay
(SPST, N.O.)

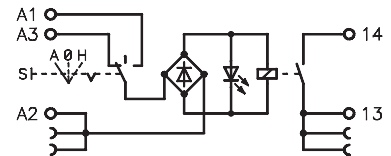

Housing with spring clamp terminals

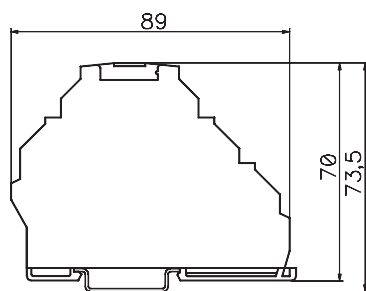

Housing with screw terminals

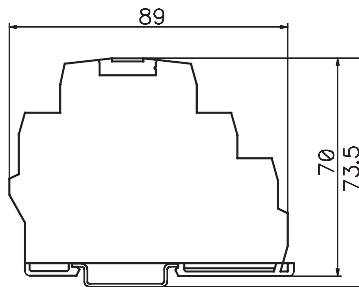

Connection of isolating blade terminal relay

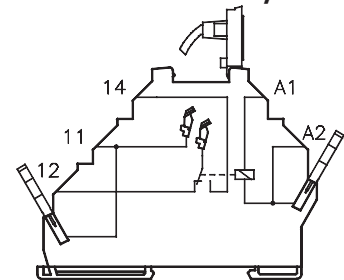

Derating: *flare* – Mechanical relay modules

24-V-Relay
 1/2 Changeover contact (SPDT/DPDT)
 12-V-Relay 1 Changeover contact (SPDT)
 Isolating blade terminal relay (SPDT)
 HAND-0-AUTO-Relay (SPST, N.O.)
 Time relay (SPST, N.O.)

110-V-Relay 1 Changeover contact (SPDT)

230 V-Relay
 1 Changeover contact (SPDT)

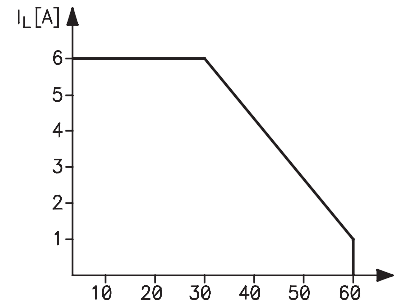
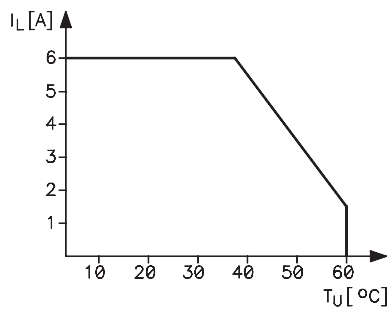
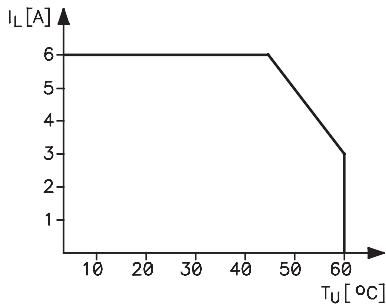

Derating curve for d.c. loads

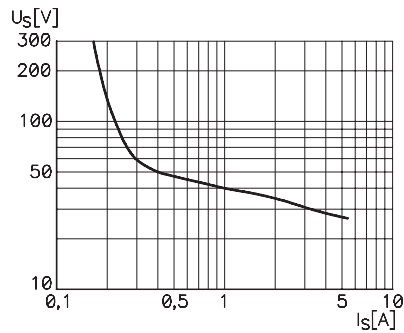

Switching capacity according to 60947-5.1

V	resistive		inductive	
	AC 12	AC 15	DC 13	
24	6 A	3 A	1 A	
110	6 A	3 A	0.2 A	
230	6 A	3 A	0.1 A	

Relay modules



Wiring diagrams

Derating

WEG-REL-1S 250 V 3 A

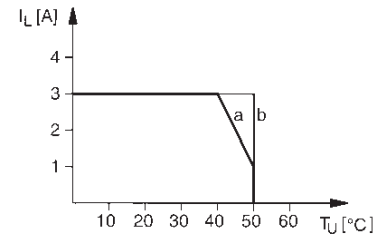
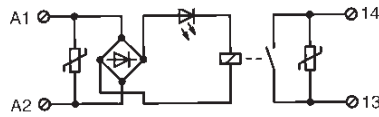

WEG-REL-1W 250 V 5 A

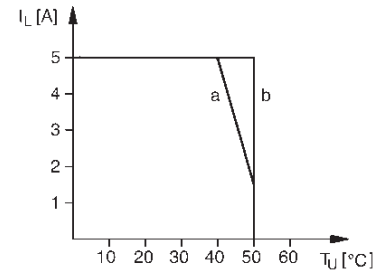
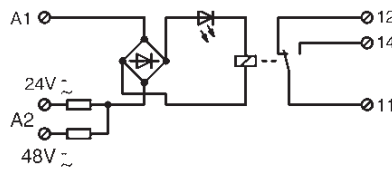

WEG-REL-2W 250 V 4 A

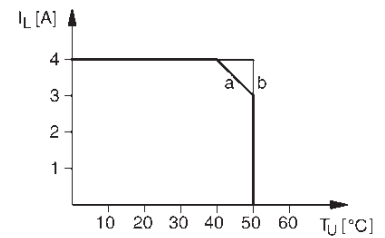
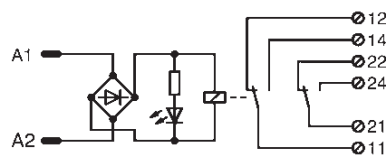

a = side by side without spacing
 b = side by side with spacing > 20 mm

Wiring diagrams

Derating

WEG-230-1S 250 V 1 A

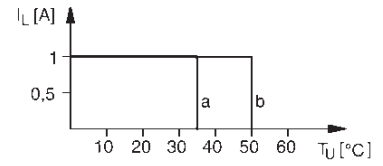
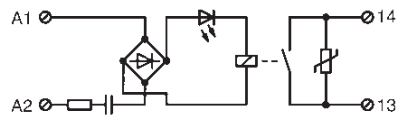

a = side by side without spacing
b = side by side with spacing > 20 mm

WEG-DUO-1W 250 V 3 A

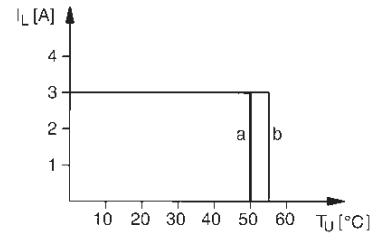
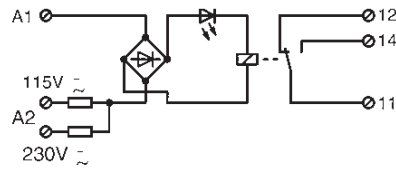

Limit curve (for resistive load)

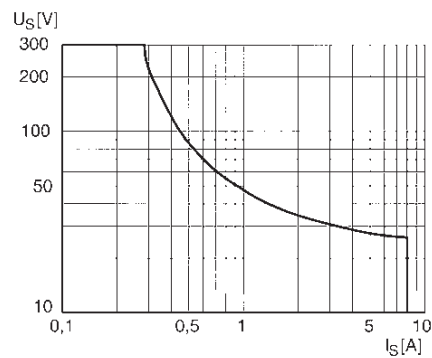

Relay modules



Dimensions

WEG-REL-1S 250 V 3 A

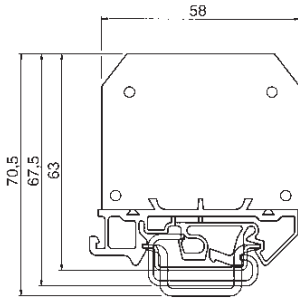

**WEG-REL-1W 250 V 5 A and
WEG-REL-2W 250 V 4 A**

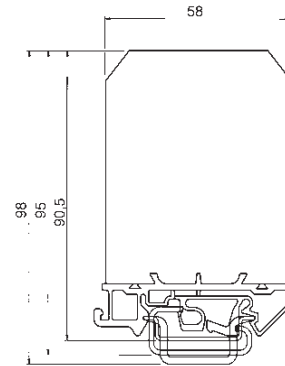

WEG-230-1S 250 V 1 A

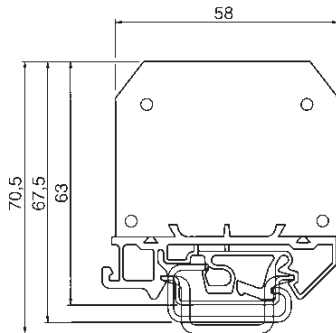

**WEG-DUO-1W 250 V 3 A
Current relay SR 4...20mA**

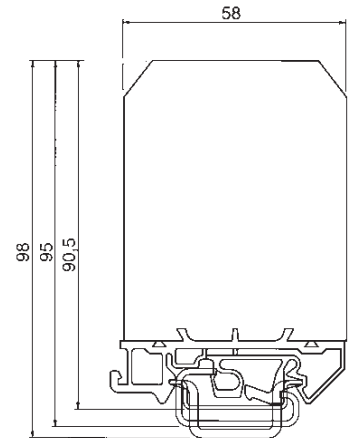

**Wiring diagram
Current relay
SR 4...20 mA**

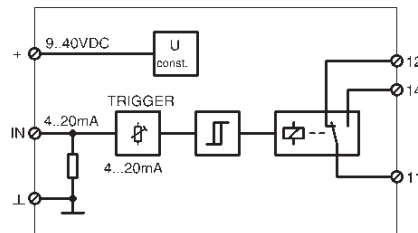

Wiring diagrams

R12-12V-1W 250 V 5 A

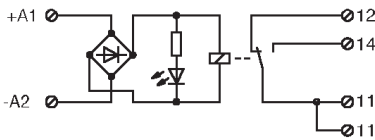

RAB – 1 Changeover contact (SPDT)

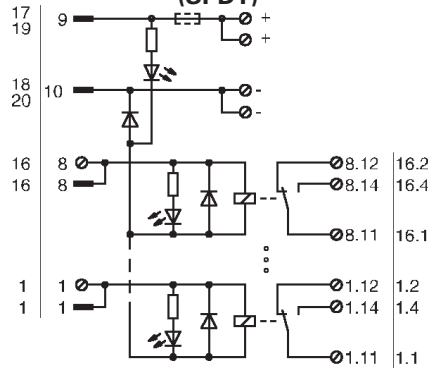

RAB – 2 Changeover contact (DPDT)

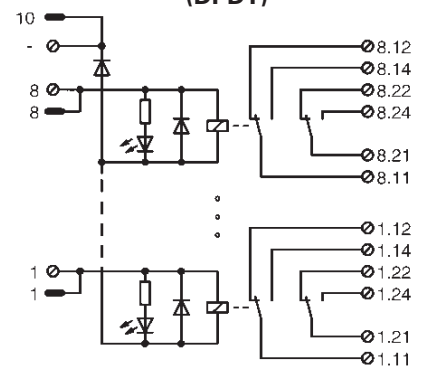

Derating

R12-12V-1W 250 V 5 A

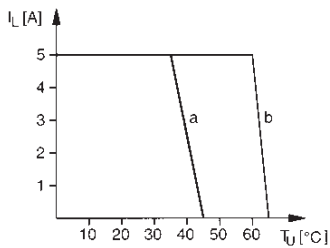

a = continuous operation
b = switching operation 50% duty cycle

RAB-FSS and RAB-SS

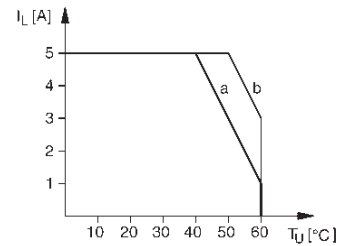

Dimensions

R12-12V-1W 250 V 5 A

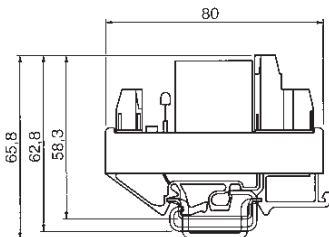

RAB – 1 Changeover contact (SPDT)

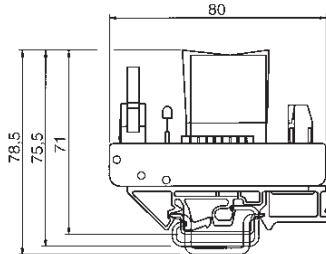

RAB – 2 Changeover contact (DPDT)

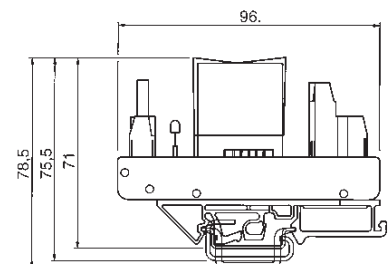

Relay modules



Wiring diagrams

WR1-230-1W 250 V 4 A

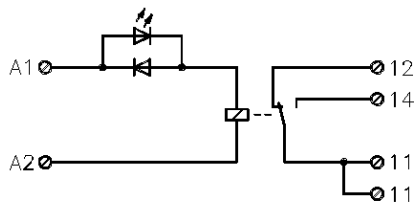

WR4/8-115-1W 250 V 4 A

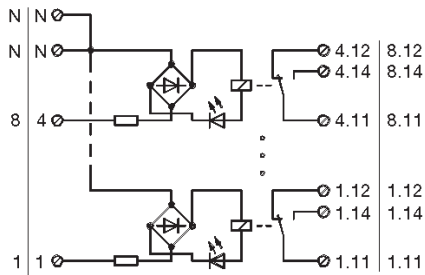

WR4/8-230-1W 250 V 4 A

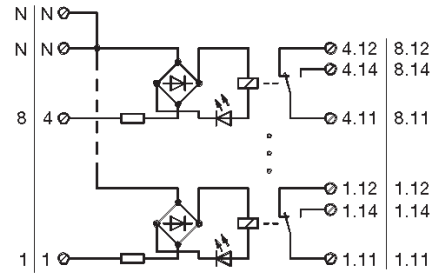

WR1-DUO-2W 250 V 5 A

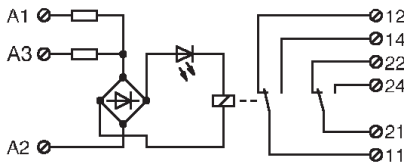

WR4/8-115-2W 250 V 4 A

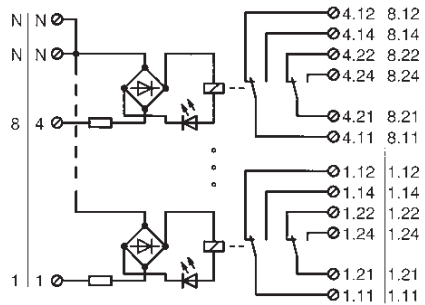

WR4/8-230-2W 250 V 4 A

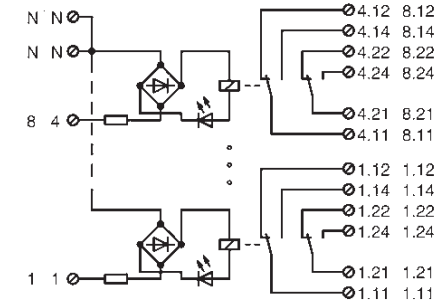

Derating

WR1 – 1 Changeover contact (SPDT)

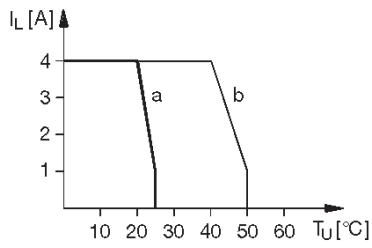

a = side by side without spacing
b = side by side with spacing of 5 mm

WR1 – DUO

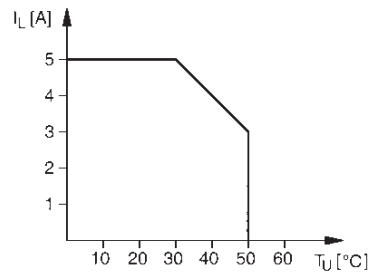

WR4/WR8 – 2 Changeover contact (DPDT)

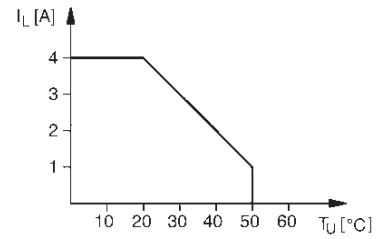

Dimensions

WR1 – 1 Changeover contact (SPDT)

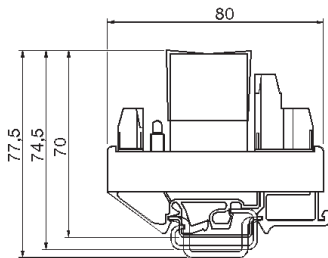

WR4/WR8 – 1 Changeover contact (SPDT)

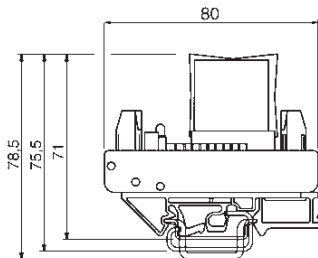

WR1 – DUO

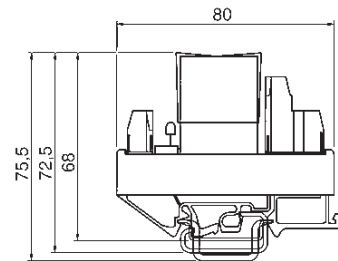

WR4/WR8 – 2 Changeover contact (DPDT)

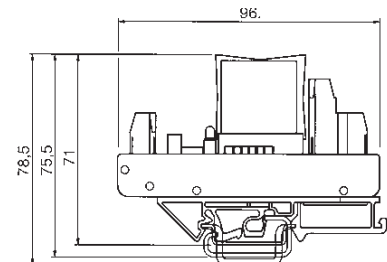

Relay modules



Wiring diagrams of relay couplers

WRS-REL-1S 250 V 5 A

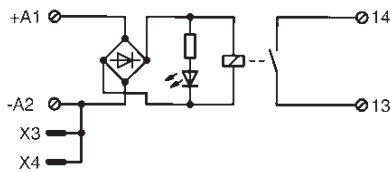

WRS-REL-1W 250 V 5 A

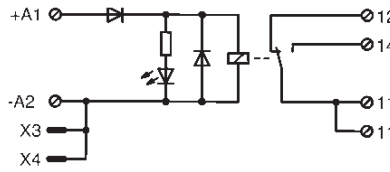

WRS-REL-2W 250 V 5 A

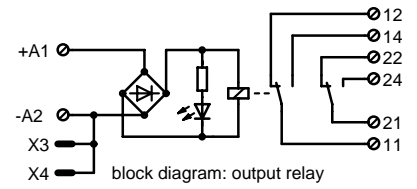

WRS-REL-1W 250 V 16 A

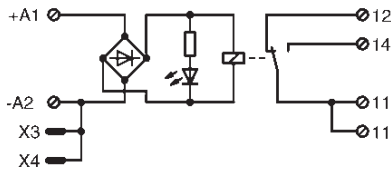

Dimensions

WRS-REL-1S 250 V 5 A
WRS-REL-1W 250 V 16 A

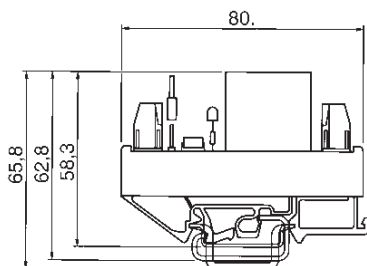

WRS-REL-1W 250 V 5 A
WRS-REL-2W 250 V 5 A

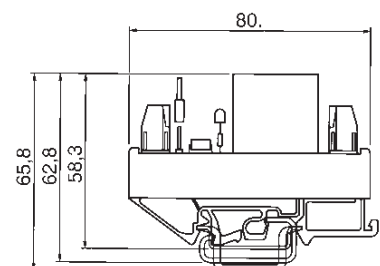

Derating

WRS-REL-1S 250 V 5 A
WRS-REL-1W 250 V 5 A

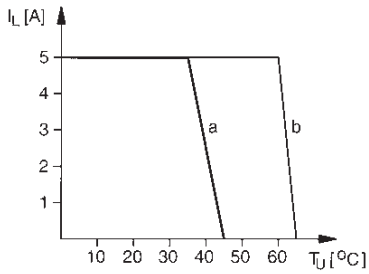

a = side by side without spacing
 b = side by side with spacing > 20 mm

Contact loading:
WRS-REL-1S 250 V 5 A
WRS-REL-1W 250 V 5 A
WRS-REL-2W 250 V 5 A

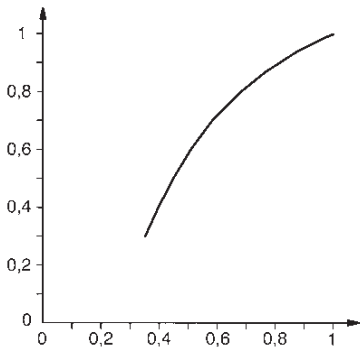

Limit curve:

WRS-REL-1S 250 V 5 A
WRS-REL-1W 250 V 5 A
WRS-REL-2W 250 V 5 A

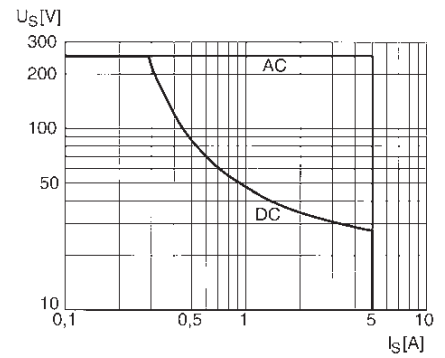

D.C. limit curve and derating curve:
WRS-REL-1W 250 V 16 A

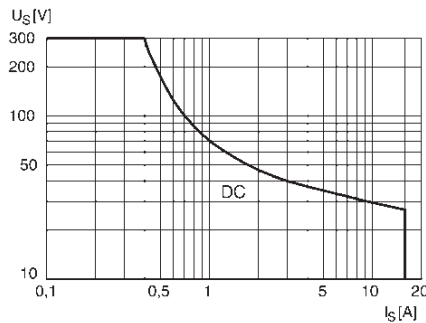

a = side by side without spacing
 b = side by side with spacing of 5 mm

Block diagrams of *flare* timer relays

Multifunction

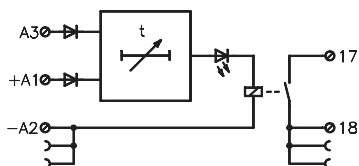

On delay

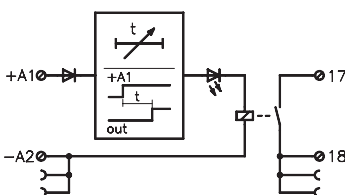

Derating: Timer relays

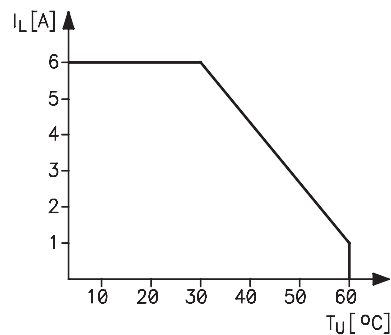

Setting the type of function

Function	DIP-Switch		
	1	2	3
on delay	on	on	on
Single Shot	on	off	on
Cycle on pulsing	on	on	off
Cycle off pulsing	on	off	off
off delay	off	off	off

Setting the time ranges

timer range $\pm 20\%$	DIP-Switch		
		4	5
t min	t max		
0.1	1.2 sec	off	on
0.4	5 sec	on	off
3.5	40 sec	on	on
30	300 sec	off	off

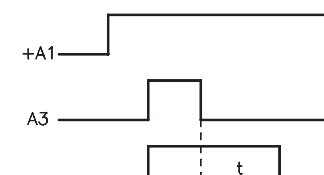
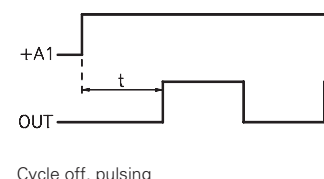
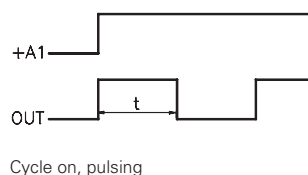
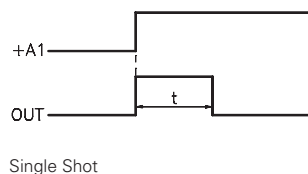
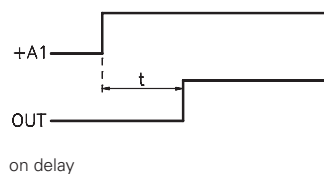

off delay

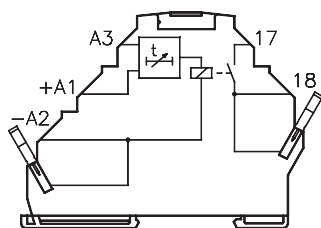

Terminal assignment: Timer relay

Block diagram of multi function WRS timer relays

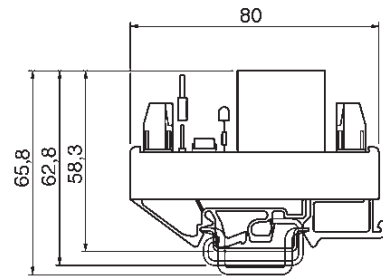
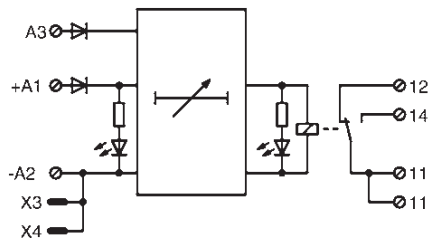

Setting the type of function

Function	DIP-switch		
	1	2	3
on delay	on	on	on
Single Shot	on	on	on
Cycle on, pulsing	off	on	off
off delay	off	off	off

Setting the time ranges

timer range $\pm 20\%$	t min	t max	DIP-switch	
			4	5
0.1	1 sec		off	on
0.4	4 sec		on	off
3	30 sec		on	on
25	255 sec		off	off

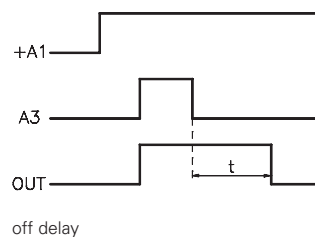
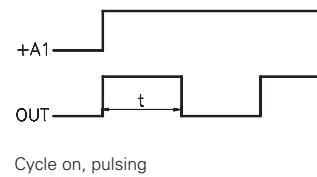
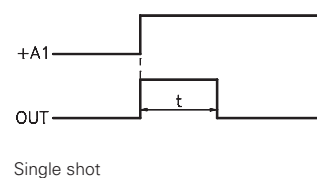
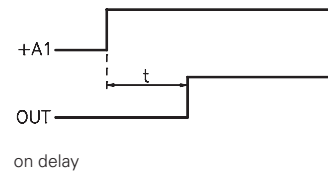

Relay modules

Solid state relays

flare

Wieland solid-state relay modules, the powerful addition

Solid-state relays are used in the same way as electromechanical relays as a connecting element between field devices and electronic control and signalling equipment. These modules can offer additional functionalities to the switching tasks that are required during processing. The core characteristics of the solid-state relays are:

- High switching frequencies up to several kHz
- Almost unlimited service life due to lack of mechanics
- Insensitive to vibrations and impulse loads
- Bounce-free and noise-free switching
- Control power in the lower mW range

Wieland offers a full range of solid state relay modules with the properties outlined above. Depending on the required applications, a superior selection of relay modules are available with various operating voltages, output arrangements and housings.

Product ranges:

flare, Solid-state relays with an overall width of 6.2 mm with input voltages of 24 V DC up to 230 V AC and switching currents up to 2 A.

WRS, Solid-state relays in a mounting base with input voltages of 24 V DC up to 230 V AC and switching currents up to 6 A.

M-PB, Plug-in, one- to eight-channel solid-state relays in a mounting base with input voltage voltages of 24 V DC up to 230 V AC and switching currents up to 3 A.

Overview of the technical data

Input circuit/control side

Wieland solid-state relays can be controlled with direct or alternating voltage, depending on their type. Each of the modules contains a suppression circuit against polarity reversal and an LED for status display in the input circuit.

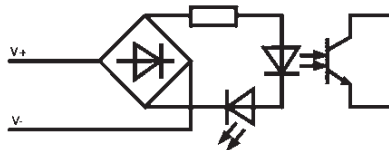

Block diagram of DC input

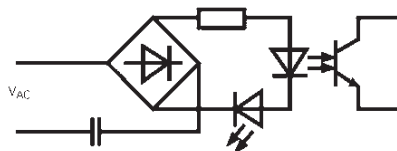

Block diagram of AC input

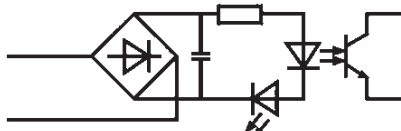

Block diagram of AC/DC input

To ensure safe operation of the relay the residual voltage in the control circuit must not exceed 5% DC or 15% AC of this operating voltage as specified in VDE 0435.

Output circuit/loadside

A solid-state relay for either DC or AC loads can be selected depending on the application. Also with DC outputs there are 2 types of connection available.

- 2 wire output
- 3 wire output, with negative switching

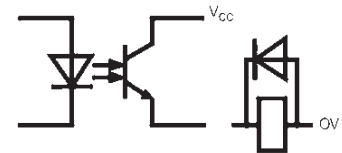

Block diagram of 2 wire output

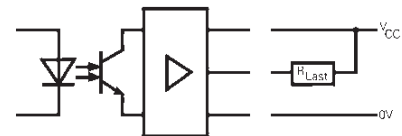

Block diagram of 3 wire output

To guarantee error-free operation it is important to select a relay with a rating that meets the voltage and current requirement and also to add a protective circuit to the output as shown in the block diagram above - such as a varistor or RC element.

If a solid-state relay is operated with an inductive load, the load must be equipped with a protective suppression circuit such as a free-wheeling diode. In all cases, it must be ensured that the protection level of the protective device lies below the respective off-state voltage of the relay.

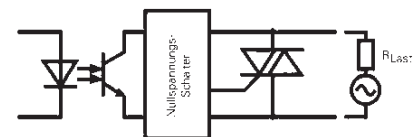

Block diagram of AC output

Solid state relays for the AC loads incorporate a triac as the switching element. A triac is a zero voltage switch and is used to avoid high inrush and back EMF peaks by connecting the load at zero voltage and disconnecting the load at zero current.

As for D.C. loads, care should be taken that the protection level of the protective measures lies below the off-state voltage of the Triac.

Relay modules Solid state relays

flare

Overall width: 6.2 mm



24 V DC / 48 V DC; 500 mA; 2 A
2 wire input/output

Approvals: , CSA



115 V AC/DC / 48 V DC; 500 mA
2 wire input

Approvals: , CSA

Dimensions (mm): W x H x D
6.2 x 89 x 70

Description	24 V DC / 48 V DC; 500 mA; 2 A			115 V AC/DC / 48 V DC; 500 mA		
	Screw terminal	Spring clamp terminal	Std. pack	Screw terminal	Spring clamp terminal	Std. pack
24 V DC, 500 mA		80.020.4100.0	10			
24 V DC, 2 A		80.020.4101.0	10			
115 V AC/DC				80.020.4102.0	10	
230 V AC						
Wiring diagram, derating curve, limit curve	See page 488-489			See page 488-489		
Control side	Input	Output				
Nominal input voltage	24 V DC	24 V DC		115 V AC/DC		
Voltage range "ON"	10 V...53 V DC	10 V...53 V DC		70 V...122 V AC/DC		
Voltage range "OFF"	0 V...5 V DC	0 V...5 V DC		0 V...30 V AC / 40 V DC		
Power consumption	ca. 6 mA	ca. 7 mA		ca. 3 mA		
Status display	LED Green	LED Green		LED Green		
Load side						
Nominal output voltage	48 V DC	48 V DC		48 V DC		
Min. switching voltage	4.4 V DC	4.4 V DC		4.4 V DC		
Max. switching voltage	53 V DC	53 V DC		53 V DC		
Min. switching current	1 mA	1 mA		0.1 mA		
Max. switching current	500 mA	2 A		500 mA		
On-state voltage	1.2 V DC	0.3 V DC		1.2 V DC		
Pickup delay	0.05 ms	4 ms		30 ms		
Dropout delay	0.2 ms	8 ms		20 ms		
Switching frequency (resistive load)	500 Hz	10 Hz		10 Hz		
Suppression circuit	Suppressor diode	Suppressor diode		Suppressor diode		
General data						
Rated voltage						
Isolation voltage of input/output	3.75 kV	2.5 kV		3.75 kV		
Overvoltage category		III		III		
Degree of pollution		2		2		
Ambient temperature		0 °C up to 50 °C		0 °C up to 50 °C		
Storage temperature		-40 °C up to +55 °C		-40 °C up to +55 °C		
Protection type/mounting rail		IP 20 / TS 35		IP 20 / TS 35		
Norms/specifications		VDE 0160; VDE 0106 T101		VDE 0160; VDE 0106 T101		
Emitted interference/interference immunity		EN 61000-6-3; EN 61000-6-2		EN 61000-6-3; EN 61000-6-2		
Wire range of screw terminal		-		-		
Wire range of spring-clamp terminal		24 - 12 AWG		24 - 12 AWG		
finely stranded		0.14 mm ² - 1.5 mm ²		0.14 mm ² - 1.5 mm ²		
single core		0.5 mm ² - 2.5 mm ²		0.5 mm ² - 2.5 mm ²		
CSA Ex approval		Class I, Division 2, Groups A, B, C and D, T6		Class I, Division 2, Groups A, B, C and D, T6		
Accessories		Part no.		Part no.		
Plug-in jumper (U _{max} = 50 V, I _{max} = 2 A)		Z8.000.0200.8		Z8.000.0200.8		
8 digit marker tag, unmarked, 60 off		Z4.242.5153.0		Z4.242.5153.0		

flare

Overall width: 6.2 mm



230 V AC / 48 V DC; 500 mA
2 wire input
Approvals: , CSA



24 V DC / 230 V AC; 500 mA
2 wire output triac
Approvals: , CSA

Dimensions (mm): W x H x D
6.2 x 89 x 70

Description	Screw terminal		Spring clamp terminal		Std. pack	
24 V DC, 500 mA						
24 V DC, 2 A						
115 V AC/DC						
230 V AC			80.020.4103.0		10	
Wiring diagram, derating curve, limit curve	See page 488–489			See page 488–489		
Control side						
Nominal input voltage	230 V AC			24 V DC		
Voltage range "ON"	90...250 V AC			10 V...53 V DC		
Voltage range "OFF"	0...40 V AC			0 V...5 V DC		
Power consumption	ca. 7.5 mA			ca. 6 mA		
Status display	LED Green			LED Green		
Load side						
Nominal output voltage	48 V DC			230 V AC		
Min. switching voltage	4.4 V DC			12 V AC		
Max. switching voltage	53 V DC			250 V AC		
Min. switching current	0.1 mA			0.1 mA		
Max. switching current	500 mA			500 mA		
On-state voltage	1.2 V DC			1.4 V AC		
Pickup delay	30 ms			10 ms		
Dropout delay	20 ms			10 ms		
Switching frequency (resistive load)	10 Hz			20 Hz		
Minimum switchable voltage	Suppressordiode			Suppressordiode		
Suppression circuit	Suppressor diode			Suppressor diode		
General data						
Rated voltage						
Isolation voltage of input/output	3.75 kV			2,5 kV		
Overvoltage category	III			III		
Degree of pollution	2			2		
Ambient temperature	0 °C up to 50 °C			0 °C up to 50 °C		
Storage temperature	-40 °C up to +55 °C			-40 °C bis +55 °C -40 °C up to +55 °C		
Protection type/mounting rail	IP 20 / TS 35			IP 20 / TS 35		
Norms/specifications	VDE 0160; VDE 0106 T101			VDE 0160; VDE 0106 T101		
Emitted interference/interference immunity	EN 61000-6-3; EN 61000-6-2			EN 61000-6-3; EN 61000-6-2		
Wire range of screw terminal	-			-		
Wire range of spring-clamp terminal	24 – 12 AWG			24 – 12 AWG		
finely stranded	0.14 mm ² – 1.5 mm ²			0.14 mm ² – 1.5 mm ²		
single core	0.5 mm ² – 2.5 mm ²			0.5 mm ² – 2.5 mm ²		
CSA Ex approval in range	Class I, Division 2, Groups A, B, C and D, T6			Class I, Division 2, Groups A, B, C and D, T6		
Accessories						
Plug-in jumper (U _{max} = 50 V, I _{max} = 2 A)			Part no.			Part no.
			Z8.000.0200.8			Z8.000.0200.8
8 digit marker tag, unmarked, 60 off			Z4.242.5153.0			Z4.242.5153.0

Relay modules

Solid state relays



- 24 V Input signals
- 2.5-kV separation between I/O at a creepage and clearance distance of 8mm



**24 V / 60 V DC / 3 A
2 wire output**

Approvals: eURis, CSA
12.5 x 80 x 64



**24 V / 60 V DC / 5 A
2 wire output**

Approvals: eURis, CSA
12.5 x 80 x 59

Dimensions (mm): W x H x D

Description	Type	Part no.	Std. pack	Type	Part no.	Std. pack
Wieland relay system	WRS-SSDC-60V3A	80.020.2003.0	10	WRS-SSDC-60V5A	80.020.2004.0	10
Wiring diagram, derating curve, limit curve	See page 490			See page 490		
Control side						
Operating voltage	24 V DC +10%/−15%			24 V DC +10%/−15%		
Nominal input current per input	16 mA			16 mA		
Power consumption	0.4 W			0.4 W		
Parallel connection of max	20 Relays			20 Relays		
Load side						
Nominal switching voltage	24 V DC			24 V DC		
Maximum switching voltage	60 V DC			60 V DC		
Minimum switching voltage	3 V DC			3 V DC		
Effective on-state voltage	1.5 V DC at I_{Nenn}			0.5 V DC		
Maximum effective current	3 A DC (Derating)			5 A DC		
Minimum effective current	20 mA			0 mA		
Maximum impulse current	5 A DC (1 sec.)			60 A DC (10 ms)		
Maximum residual current	1 mA at 60 V DC			1 μA DC		
Fusing, note I ² t value	–			FF		
Internal Suppression circuit	Z-Diode 68 V / 5 W			–		
Maximum pickup/dropout delay	100 μs			1 ms		
Maximum switching frequency	1 kHz			100 Hz		
Isolation voltage of input/output	4 k V _{eff}			2.5 kV _{eff}		
Capacity of input/output	8 pF			15 pF		
Overvoltage category						
Degree of pollution						
Ambient temperature	−25 °C...Derating			−20 °C...Derating		
Storage temperature	−25 °C...+85°C			−25 °C...+85°C		
Mounting rail	TS 32 or TS 35			TS 32 or TS 35		
Norms/specifications						
Emitted interference/interference immunity						
Wire range, finely stranded/single core	0.5 mm ² – 2.5 mm ² / 0.5 mm ² – 4 mm ² / 22 – 12 AWG			0.5 mm ² – 2.5 mm ² / 0.5 mm ² – 4 mm ² / 22 – 12 AWG		
Location of mounting rail	horizontal			horizontal		
Accessories						
Plug-in jumper		Z8.000.0103.4	10		Z8.000.0103.4	10

- 24 V DL Input Signal



**24 V DC / 250 V AC / 4 A
2 wire output**

Approvals:
12.5 x 80 x 56



**24 V DC / 250 V AC / 6 A
2 wire output**

Approvals: CSA
25.6 x 80 x 70

Dimensions (mm): W x H x D

Description	Type	Part no.	Std. pack	Type	Part no.	Std. pack
Wieland relay system	WRS-SSAC1-250 V4A	80.020.2001.0	10	WRS-SSAC1-250 V6A	80.020.0004.0	5
Wiring diagram, derating curve, limit curve	See page 490–491			See page 490–491		
Control side						
Operating voltage	24 V DC +10%/–15%			24 V DC +15%/–15%		
Nominal input current per input	20 mA			15 mA		
Power consumption	0,5 W			0,4 W		
Parallel connection of max	20 Relays			20 Relays		
Load side						
Nominal switching voltage	250 V AC			24 V–250 V AC		
Maximum switching voltage	280 V AC					
Minimum switching voltage	48 V AC					
Peak off-state voltage	1200 Vs			600 Vs		
Critical rate of rise of voltage	500 V/μs			500 V/μs		
Effective on-state voltage	1,4 V			1,6 V		
Maximum effective current	4 A AC			6 A AC		
Minimum effective current	60 mA			60 mA		
Maximum impulse current	250 A AC (20ms)			10 A AC		
Maximum residual current	0,1 mA			0,1 mA _{eff}		
Power factor φ	> 0,5			> 0,5		
Zero sequence voltage switch	yes			yes		
I ² t value	260 A ² s			260 A ² s		
Fusing, note I ² t value	FF			FF		
Suppression circuit				Varistor		
Maximum pickup/dropout delay	10 ms			100 ms		
Maximum switching frequency	15 Hz			15 Hz		
Isolation voltage of input/output	4 kV _{eff}			4 kV _{eff}		
Capacity of input/output	10 pF			10 pF		
Overvoltage category						
Degree of pollution						
Ambient temperature	–25 °C...Derating			–25 °C...Derating		
Storage temperature	–25 °C...+85°C			–25 °C...+85°C		
Mounting rail	TS 32 or TS 35			TS 32 or TS 35		
Norms/specifications						
Emitted interference/interference immunity						
Wire range, finely stranded/single core	0,5 mm ² – 2,5 mm ² / 0,5 mm ² – 4 mm ² / 22 – 12 AWG			0,5 mm ² – 2,5 mm ² / 0,5 mm ² – 4 mm ² / 22 – 12 AWG		
Location of mounting rail	horizontal			horizontal		
Accessories						
Plug-in jumper		Z8.000.0103.4	10		Z8.000.0103.4	10

Relay modules

Module boards

M-PB

Relay module boards

- 1 relay
- 4 relay
- 8 relay

The module boards are supplied without solid-state relays or miniature fuses



Module board 1 relay

26 x 96 x 70,3

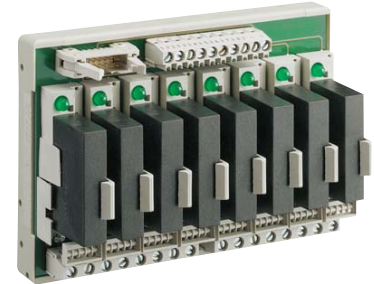

Module board 4/8 relays

70/138 x 96 x 70,3

Dimensions (mm): W x H x D

Description	Type	Part no.	Std. pack	Type	Part no.	Std. pack
1 relay module boards	M-PB 1 SR	87.220.1353.3	2			
4 relay module boards				M-PB 4 SP	87.220.0753.3	1
8 relay module boards				M-PB 8 SP	87.220.0853.3	1
Wiring diagram, derating curve, limit curve	See page 492–493			See page 492–493		
Switching variations						
Input without positive/negative switching	+ / -					
Output with positive/negative switching	+ / -			+		
Caution: Please allow for the voltage drop at the LED						
Switching behaviour						
See technical data of input/output relays on pages 478 to 481						
General data						
Voltage drop at the LED	2 V			2 V		
Ambient temperature	-30 °C...+40 °C			-30 °C...+40 °C		
Storage temperature	-25 °C...+85 °C			-25 °C...+85 °C		
IDC header DIN 41651	-			8 relay, 10 pole		
Miniature fuse holder	5 x 20 mm			5 x 20 mm		
Wire diameter of solid state relay connection	max 1.05 mm			max 1.05 mm		
Wire range, finely stranded/single core	0.5 mm ² – 2.5 mm ² / 0.5 mm ² – 4 mm ² / 22 – 12 AWG			0.5 mm ² – 2.5 mm ² / 0.5 mm ² – 4 mm ² / 22 – 12 AWG		
Mounting rail	TS 32 or TS 35					
Location of mounting rail	horizontal			horizontal		
Accessories						
Solid state relay input (See page 478)	M-IDC24	Z5.580.8100.0	10			
Solid state relay input (See page 478)	M-IAC24	Z5.580.7800.0	10			
Solid state relay output (See page 480)	ODC 3-32 V / 3-60 V	Z8.000.0169.8	10	ODC 3-32 V / 3-60 V	Z8.000.0169.8	10
Solid state relay output (See page 481)	ODC 3-32 V / 3-200 V	Z8.000.0169.9	10	ODC 3-32 V / 3-200 V	Z8.000.0169.9	10
Solid state relay output (See page 480)	OAC 3-32 V / 24-280 V	Z8.000.0156.9	10	OAC 3-32 V / 24-280 V	Z8.000.0156.9	10

Relay modules

Solid state relays

M-PB

For use with M-PB relay module boards



240 V AC / 5 mA
3 wire input AC



32 V DC / 32 mA
3 wire input DC

Dimensions (mm): W x H x D
10.2 x 26.3 x 43.2

Description	Type	Part no.	Std. pack	Type	Part no.	Std. pack
Solid state relay	M-AC 24	Z5.580.7800.0	10	M-IDC 24	Z5.580.8100.0	10
Pin base input	See page 483			See page 483		
Pin base output	See page 483			See page 483		
Wiring diagram, derating curve, limit curve	See page 492-493			See page 492-493		
Control side						
Nominal operating voltage	240 V AC			32 V DC		
Maximum operating voltage	280 V AC/DC			3,3 V DC		
Minimum operating voltage	180 V AC/DC			32 mA DC		
Nominal input current	5 mA AC			1 mA DC		
Breaking current	1.5 mA AC			1 kΩ		
Resistance	75 kΩ					
Maximum voltage without reaction at output	50 V AC			2 V DC		
Maximum current without reaction at output	2 mA AC			1,5 mA DC		
Load side						
Nominal switching voltage	24 V DC			24 V DC		
Maximum switching voltage	30 V DC			30 V DC		
Minimum switching voltage	20 V DC			20 V DC		
Maximum current	16 mA DC			16 mA DC		
Leakage current	10 μA DC			10 μA DC		
Logic voltage	30 V DC			30 V DC		
Logic current	50 mA DC			50 mA DC		
Logic leakage current	10 μA DC			10 μA DC		
Logic voltage drop	200 mV DC			100 mV DC		
Maximum pickup/dropout delay	20 ms / 30 ms			1 ms / 1 ms		
Maximum switching frequency	10 Hz			1 kHz		
Mains frequency	47-63 Hz			-		
Isolation voltage of input/output	4 kV _{eff.} (1 sec.)			4 kV _{eff.} (1sec.)		
Capacity of input/output	8 pF			8 pF		
Overvoltage category						
Degree of pollution						
Ambient temperature	-30 °C...+40 °C			-30 °C...+40 °C		
Storage temperature	-40 °C...+100 °C			-40 °C...+100 °C		
Norms/specifications						
Emitted interference/interference immunity						
Accessories						
Pin base	See pin base on page 485			See pin base on page 485		

Relay modules

Solid state relays

M-PB

For use with M-PB relay module boards



230 V AC / 3 A
2 wire output
10.2 x 25.9 x 43.2



60 V DC / 3 A
2 wire output
10.2 x 26.3 x 43.2

Dimensions (mm): W x H x D

Description	Type	Part no.	Std. pack	Type	Part no.	Std. pack
Solid state relay	OAC 3-32 V/24-280 V	Z8.000.0156.9	10	ODC 3-32 V/3-60 V	Z8.000.0169.8	10
Wiring diagram, derating curve, limit curve	See pages 492-493			See pages 492-493		
Coil circuit						
Operating voltage	3 – 32 V DC			3 – 32 V DC		
Nominal input current	1 – 22 mA			3 – 32 mA		
Minimum closing voltage	3 V DC			3 V DC		
Maximum opening voltage	1 V DC					
Maximum reverse voltage	6 V DC			6 V DC		
Resistance	1.5 kΩ			1 kΩ		
Switching behaviour						
Switching voltage	24 – 280 V AC			3 – 60 V DC		
Peak off-state voltage	600 Vs			60 V DC		
Critical rate of rise of voltage	100 V/μs			–		
Maximum effective on-state voltage	1.6 V			1,5 V		
Maximum effective current	3 A			3 A (5 A / 1 sec.)		
Minimum effective current	50 mA			–		
Maximum impulse current (20 ms)	90 Amp			–		
Maximum leakage current	5 mA			1 mA		
Power factor φ	≥ 0.5			–		
Zero sequence voltage switch	yes			–		
I ² t value	42 A ² s			–		
Fusing of solid state relay	FF 2.5 A			FF 2,5 A		
Fusing of load circuit	F 3.15 A			F 3,15 A		
Maximum pickup/dropout delay	11 ms			100 μs / 1 ms		
Maximum switching frequency	–			1 kHz		
Isolation voltage of input/output	4 kV _{eff.}			4 kV _{eff.}		
Capacity of input/output	8 pF			8 pF		
Overvoltage category						
Degree of pollution						
Ambient temperature	–20 °C...Derating			–40 °C...Derating		
Storage temperature	–40 °C...+100 °C			–40 °C...+100 °C		
Norms/specifications						
Emitted interference/interference immunity						
Accessories						
Pin base	See pin base on page 485			See pin base on page 485		

M-PB



Dimensions (mm): W x H x D
10.2 x 26.3 x 43.2

200 V DC / 1 A
2 wire output

Description	Type	Part no.	Std. pack
Solid state relay	ODC 3-32 V/3-200 V	Z8.000.0169.9	10
Wiring diagram, derating curve, limit curve			
Coil circuit	See pages 492-493		
Operating voltage	3-32 V DC		
Nominal input current per input	3-32 mA		
Minimum closing voltage	3 V DC		
Maximum opening voltage	1 V DC		
Maximum reverse voltage	6 V DC		
Resistance	1 kΩ		
Switching behaviour			
Nominal switching voltage	3-200 V DC		
Peak off-state voltage	200 V DC		
Critical rate of rise of voltage	-		
Maximum effective on-state voltage	1.5 V		
Maximum effective current	1 A (2 A / 1 sec.)		
Minimum effective current	-		
Maximum impulse current	-		
Maximum residual current	1 mA		
Power factor φ	-		
Zero sequence voltage switch	-		
I ² t value	-		
Fusing, note I ² t value	FF 2.5 A		
	F 1.25 A		
Maximum pickup/dropout delay	100 μs / 1 ms		
Maximum switching frequency	1 kHz		
Isolation voltage of input/output	4 kV _{eff.}		
Capacity of input/output	8 pF		
Overvoltage category			
Degree of pollution			
Ambient temperature	-40 °C...Derating		
Storage temperature	-40 °C...+100 °C		
Norms/specifications			
Emitted interference/interference immunity			
Accessories			
Pin base	See pin base on page 485		

Wiring diagrams: flare – Solid state relays

24 V/48 V DC; 500 mA; 2 A

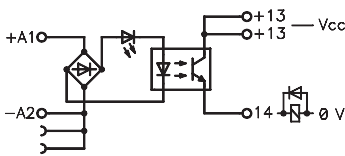

115 V AC/DC / 48 V DC; 500 mA

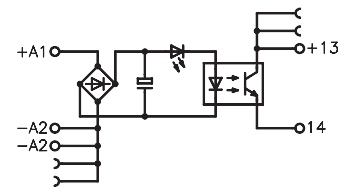

230 V AC / 48 V DC; 500 mA

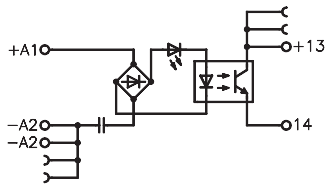

24 V DC / 230 V AC; 500 mA

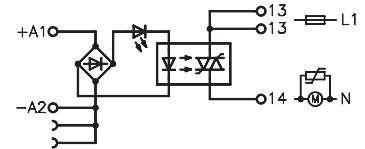

Derating: Solid State Relais

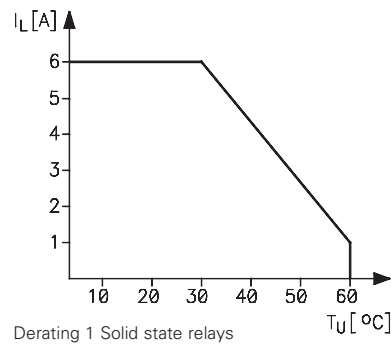

Dimensions of *flare* – Relays

Housing with spring clamp terminals

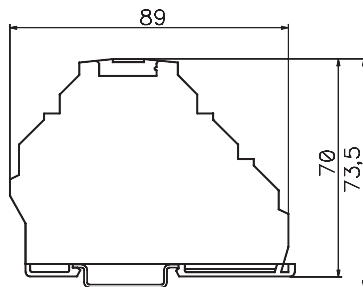

WRS Solid state relays

Wiring diagram

WRS-SSDC-60 V 3 A

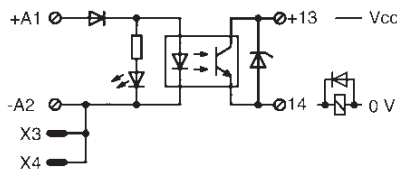

WRS-SSDC-60 V 5 A

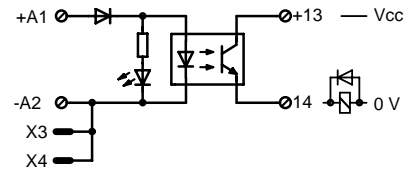

Derating

Derating
Solid state relay WRS-SSDC 60V 3A

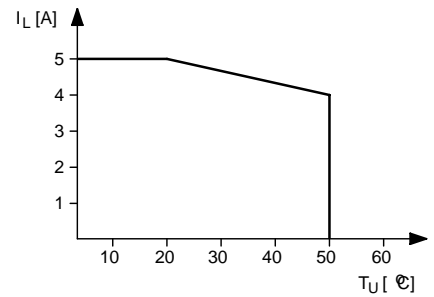
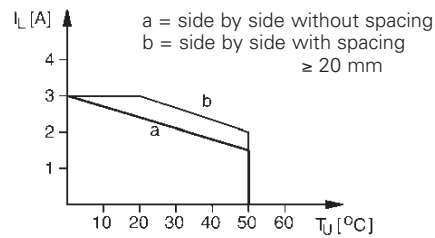

Dimensions

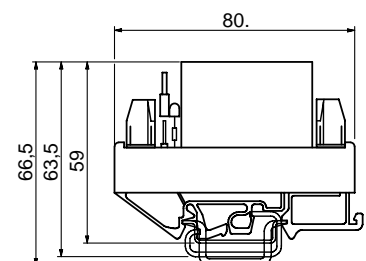
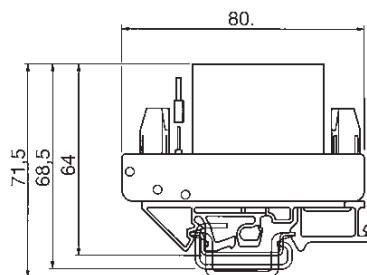

Wiring diagram

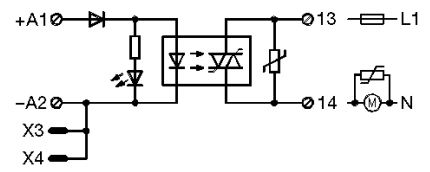
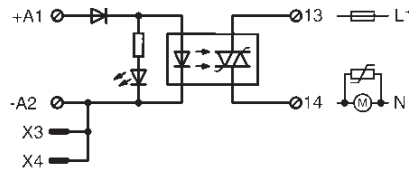

Derating

WRS-SSAC1-250 V 4 A

Derating
AC 1-phase

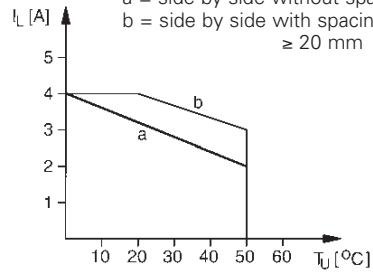

WRS-SSAC1-250 V 6 A

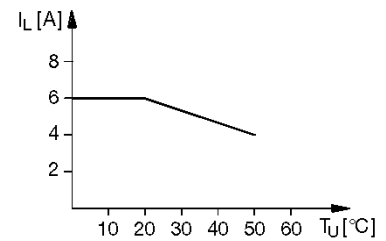

Dimensions

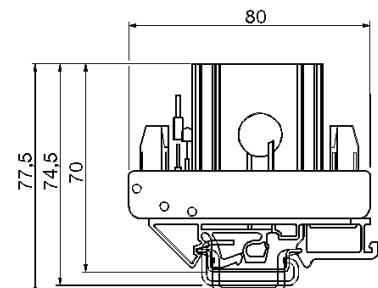
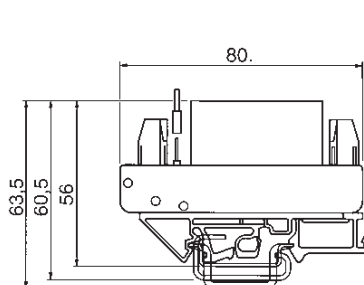

Relay modules Solid state relays



Wiring diagrams: M-PB module boards

M-PB 1SR

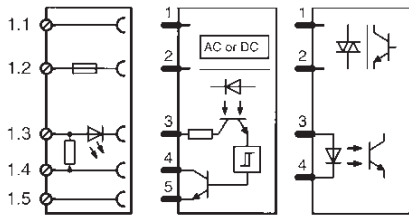

M-PB 4/8 SP

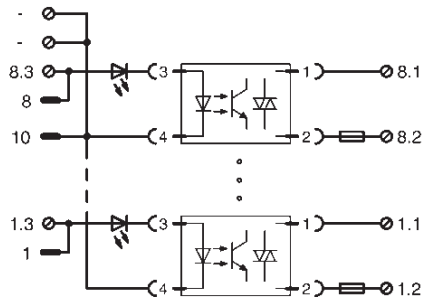

M-PB 4/8 SG

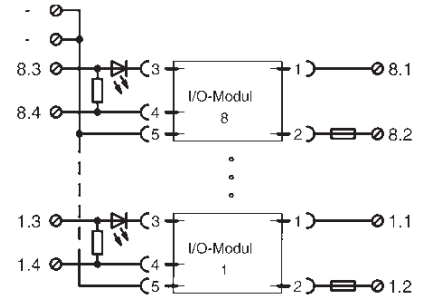

Dimensions of module boards

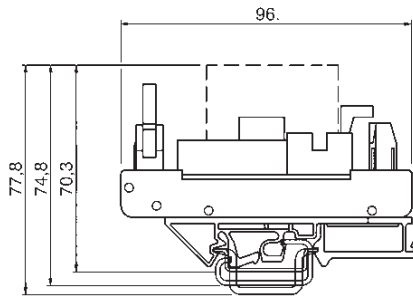

Wiring diagrams: M-PB Solid state relays

M-IAC 24

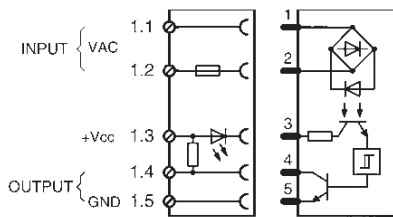

M-IDC 24

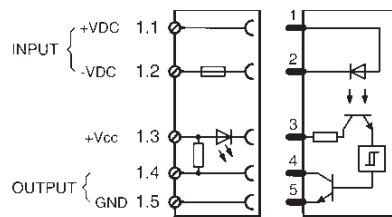

Dimensions

M-IAC 24 / M-IDC 24

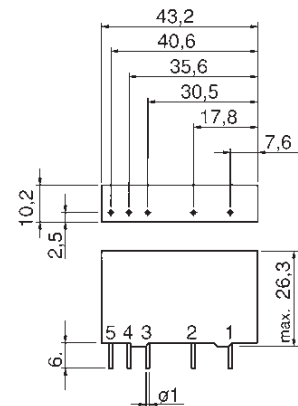

Wiring diagrams + Derating: M-PB Solid state relays

OAC 3-32 V/24-280 V

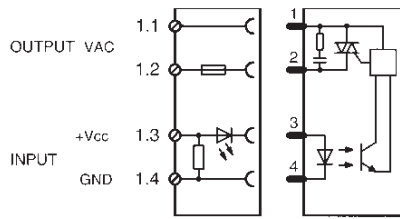

ODC 3-32 V/3-60 V

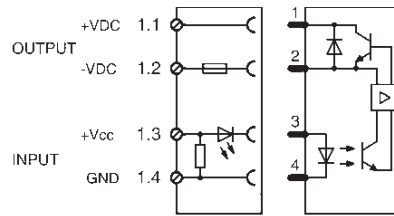

ODC 3-32 V/3-200 V

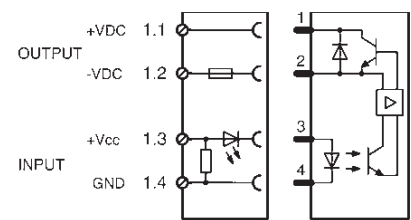

Derating

Output 230 V AC

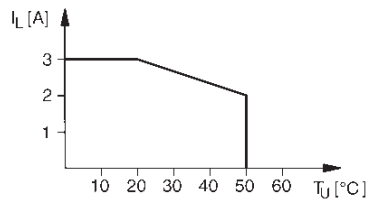

Output 60 V DC

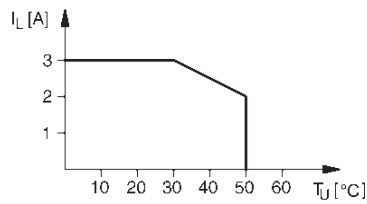

Output 200 V DC

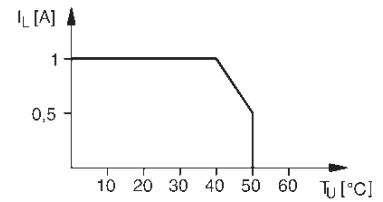

Dimensions

OAC 3-32 V/24-280 V

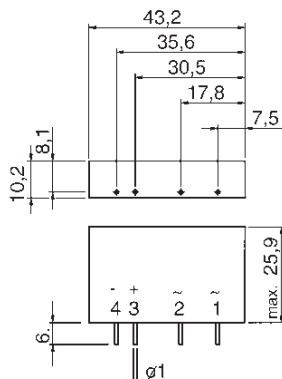

**ODC 3-32 V/3-60 V
ODC 3-32 V/3-200 V**

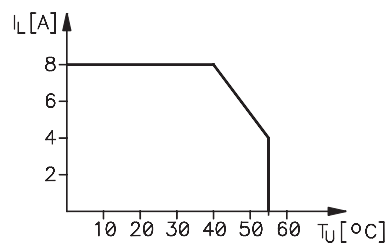

Pin base

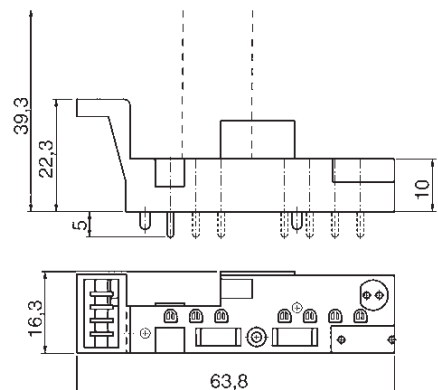

Analog measurement technology

analog

Pt100 (RTD)/TC

Sensor Amplifiers

Analog conversion module

Analog isolating module

Multifunctional signal conditioning

Measuring transducer with 3 way isolation

Isolating set point amplifiers

Isolating set point amplifiers – potential free

Constant voltage source

Analog measurement technology offers

- overall modules widths from 12,5 mm
- one modular system
- modules with screw and spring clamp terminals
- Isolating modules with 3 way isolation
- freely configurable modules
- freely adjustable input ranges for RTD Pt100/Pt1000
- modules with CJC compensation
- modules with “Smart Sense” function

All Wieland Components which require general certification are certified, and identified with the logo.



electronics



Electronic components

Analog measurement technology

Measurement and control technology

dipos

Wieland signal conditioners for measurement and control technology.

The basis of modern automation is the preparation and transfer of physical variables such as temperature, pressure, speed or humidity. These variables are recorded by sensors which use interfaces to simultaneously convert them into electrically measurable, standardised signals. The most frequently used signals are 1-5 V, 0 – 10 V, ± 10 V, 0–20 mA and 4–20 mA. In the reverse, controller modules or control systems supply these standardised signals as variables for actuators and indicators. There is often a distance between the recording and processing sites, whereby the transmission link invariably lies in a hostile industrial environment.

Wieland signal conditioners offer a reliable solution for the transmission of these relatively weak signals. Resistive, inductive or capacitive interference or earth loops are ruled out due to advanced technology. They ensure that the analog standard signals are electrically isolated. The signal input and output are supplied by integrated DC/DC transformers which are electrically isolated from the mains.

Apart from isolation for standardised signals, temperature input modules for Pt100/RTD sensors and thermocouples are also available, with or without electrical isolation. All the modules are intended for installation on standard DIN rail.



dipos signal conditioners offer the following benefits:

- Overall widths from 12,5 mm
- Modular system
- Permanent wiring via plug-in modules
- Settings can be secured against unauthorised access via a sealed cover
- 4 kV insulation voltage
- 100% earth connection if required
- Signals or supply voltages can be jumpered
- Screw or spring-clamp terminals
- Labelling of individual channels as well as groups

Product ranges

AKB, AKT

Signal conditioners for standardised signals that can be mounted on TS 35 rails, electrically isolated or with 3-way isolation.

UET, dipos UET

Isolating set point amplifiers for generating threshold-dependent switching points. The respective threshold value is represented via an LC display, depending on the module. The measured input value is potential-free.

cores, dipos Pt

RTD Signal conditioner modules for Pt100, Pt1000 and Ni temperature sensors.

The following types are available:

- One temperature input range/one standard signal output
- Two defined temperature input ranges/two standard signal outputs, input and output characteristics can be freely selected
- Four freely selectable temperature input ranges/two standard signals output with or without detection of wire breakage
- Freely adjustable temperature input ranges via DIP switches and standard signal outputs
- Software configurable module for temperature input ranges and standard signals outputs

dipos TC

Temperature transformer isolator modules for thermocouple elements sensors of type J and K.

The following types are available:

- One temperature input range/one standard signal output
- Two defined temperature input ranges/two standard signal outputs, input and output characteristics can be freely selected

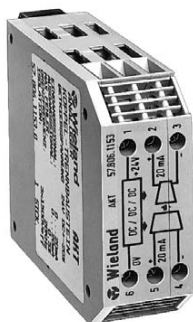

2, 3 or 4 wire connection technology for RTD/Pt sensors

The range provided by Wieland offers devices for all connection technologies. The appropriate technique is used, depending on the accuracy requirement. The individual measurement types are described in detail as follows.

The obvious benefit of a 2-wire connection lies in the minimum wiring costs. It should however be noted that greater errors can occur during measurement using this method. In the case of a Pt100 sensor, an additional resistance of only one ohm is sufficient for an error of 2.5°C. This error acts as an offset (zero displacement). This type of increase in resistance can be caused by cable resistances, contact resistances, soldered connections, plugs etc. In order to compensate for these errors, the Wieland modules offer a zero balance. This does not however prevent errors from occurring during operation that are caused by variations in the ambient temperature.

In practice, a 2-wire connection is only recommended if the application does not

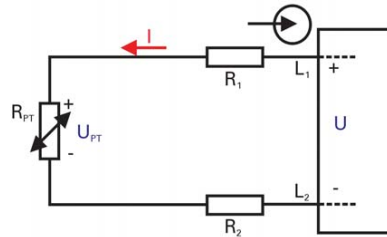

require a high level of accuracy.

In the case of a 3-wire connection, one of the sensor cables is used for measuring the cable and contact resistances. The influence of the additional resistances can thus be largely eliminated. This however only applies under one condition which is

often not observed:

The resistances of the three cables and the respective connectors must match exactly.

A differential of 0.39 ohm already causes an error of 1 degree (Pt100). Only the respective state can be equalized by carrying out an adjustment during commissioning. It is not possible to

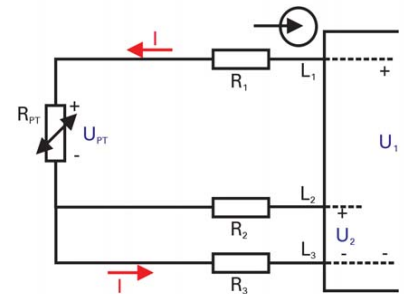

remedy the sources of error that are caused by temperature.

In the case of 4-wire technology, two cables take over the temperature measurement and two further cables measure at high resistance the voltage drop that arises via the resistance-type sensor.

All the effects caused by contact or cable resistances are fully eliminated.

The error is maximum 0.004% per ohm. There is practically no influence produced on the output variable. It is irrelevant if the resistances have different values and are subjected to different conditions due

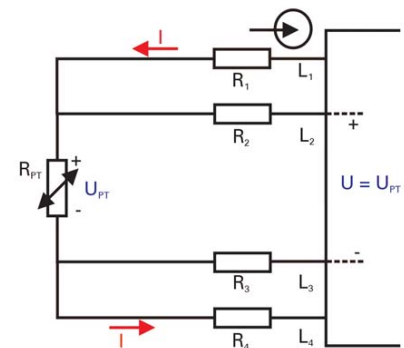

to the application.

Analog measurement technology

RTD (Pt100)/TC



The influence of the insulation resistance on the temperature measurement

The design of RTD sensors can lead to measuring errors. This is independent of the type and manufacturer. One of the most frequent sources of error is the insulation in the sensor. If it is not sufficient, it can seriously impair the measurement. Causes of a low-resistance insulation can be heat, vibration, physical, chemical or radioactive influences.

Measurement with Pt100

The Pt100 element is a low-resistance sensor. If the insulation resistance is too low, the measurement is influenced.

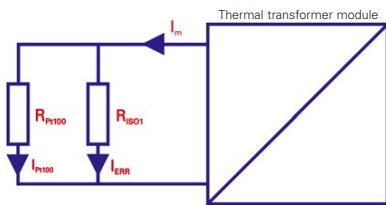

The diagram shows the electrical circuit diagram of the Pt100, connected to a RTD signal conditioner. Apart from the current flowing over the sensor, a minor current normally also flows over the insulation resistance R_{ISO1} . If the insulation resistance falls, the proportion that flows over the insulation resistance also naturally rises. Due to the constant current that is supplied by the RTD signal conditioner, the voltage drop is also reduced. This produces a measured temperature value that is too low, regardless of whether the RTD signal conditioner is operated with or without electrical isolation. During operation without electrical isolation, leakage current can however be caused between the sensor and earth if the insulation resistance is too low. This also leads to a lower temperature display. An isolated RTD signal conditioner rules this out.

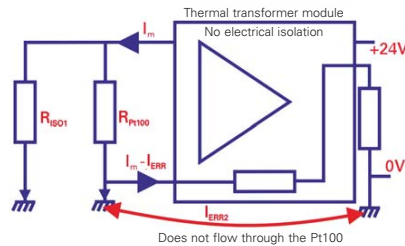

Measurement via thermocouples

Limited by the principle of the thermocouples, other errors arise due to the extremely small insulation resistances. The EMF (electromotive force) of thermocouples is not particularly susceptible in the event of a low insulation resistance. The problem lies in the fact that a new measuring point occurs due to the low insulation resistance. If this measuring point is found in the vicinity of the existing point, the influence is negligible. However, if it is located where there is a temperature differential to the measuring point, the measuring error can be considerable. As a

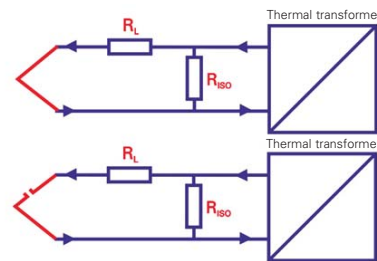

result, it is almost impossible to diagnose a break in the sensor. The thermocouple signal conditioner **dipos** PROG is microprocessor-controlled and carries out measurements and checks beyond the standard. One of these checks is the display of the insulation resistance of the connected sensor. This function is called "Smart Sense". To implement this function, the sensor must be provided with an additional conductor. In the case of TC sensors, a special sensor is required which contains an additional conductor

that is not used for temperature measurement.

Under certain conditions, it is possible to

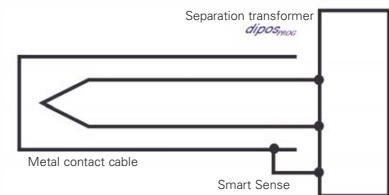

use the shield of the cable as the following diagram indicates:

An excessively low insulation resistance is indicated with a flashing LED at the module and the output signal is set to a preselected value. Smart sense not only monitors the sensor state but also the connections from the sensor to the thermal transformer module. This guarantees the complete control of the measuring point up to the thermocouple signal conditioner.

dipos



- Mounting width 12,5 mm
- 3 and 4 wire technology
- Current output can be toggled (0...20 mA and 4...20 mA)
- Adjustable zero/span
- Detection of wire breakage
- Overload signal at the output, red LED

Dimensions (mm) W x H x D
12.5 x 100 x 100

RTD Signal Conditioner for Pt100 sensors

Approvals: , CSA in preparation

Description	Output signal	Type	Part no.	Std. pack	Part no. key for input temperature range
dipos Pt100 RTD measuring transducer					
in 3 and 4 wire technology for Pt100 Sensors					
	0...10 V	3 wire	82.011.30XX.0	1	01 0...100 °C**
	0...10 V	4 wire	82.011.40XX.0	1	02 0...200 °C
	0(4(*)...20 mA	3 wire	82.011.37XX.0	1	03 0...300 °C
	0(4(*)...20 mA	4 wire	82.011.47XX.0	1	04 0...400 °C
	0...10 V / 0(4(*)...20 mA	3 wire	82.011.38XX.0*	1	05 0...500 °C**
	0...10 V / 0(4(*)...20 mA	4 wire	82.011.48XX.0*	1	20 -50...+50 °C**
	(*) Supplied state				21 -100...+100 °C**
					31 0...150 °C
					40 -50...+50 °C(*) / -100...+100 °C
					41 0...100 °C(*) / 0...500 °C
Wiring diagram, dimensions		See page 501			
Technical data		Ordering example:			
Measured input		Pt100 3 wire, Input 0...400 °C, Output 0...10 V			
Input		Part no. 82.011.3004.0			
Temperature ranges		-100...+100 °C / -50...+50 °C			
Supply current (Pt100)		0...100 °C / 150 °C / 200 °C / 300 °C / 400 °C / 500 °C			
		ca. 1 mA			
Measured output					
Output signal		0...10 V, 0(4)...20 mA			
Maximum load for voltage signal		5 mA			
Load for current signal		0...500 Ω (no load error)			
Output signal in event of wire breakage					
Voltage output:		ca. 13 V			
Current output:		ca. 26 mA			
Measuring accuracy					
Transmission error		≤ 0.2% of final value (at 20 °C ambient temperature)			
Max. temperature co-efficient		100 ppm/K (ref. final value)			
Load error (deviation at 100 Ω load)		< 0.02%/100 Ω			
Zero/span adjustment range		ca. 3% Approx. of scope of measuring range			
General data					
Supply data		24 V DC +25% / -20%, polarised			
Power consumption		ca. 15 mA + output current			
Ambient temperature range		0...60 °C (100% capacity utilisation of device, series connected)			
Norms, specifications		DIN EN 50178, EMC guideline 89/336/EWG			
Isolation					
EMC					
Emitted interference		EN 60715/KI. B, EN 61000-6-1, CISPR 22/KI. B			
Interference immunity		EN 61000-4-2/3/4/5/6			
Accessories					
Module board, overall width of 12.5mm, 4 connections per side					
	Screw terminal		80.060.0010.1	1	
	Spring clamp terminal		80.060.0011.1	1	
	Coding branch		Z5.563.0453.0	25	
	Plug-in jumper		Z8.000.0229.5	50	
	Large marker tag, white, blank		04.249.4053.0	500	
	Small marker tag				
	red, blank		04.249.1053.0	500	
	blue, blank		04.249.1553.0	500	
	white, blank		04.249.2053.0	500	

Analog measurement technology

TC

dipos



- Mounting width 12.5 mm
- CJC incorporated
- Current output can be toggled (0...20 mA and 4...20 mA)
- Adjustable zero/span
- Detection of wire breakage
- Overload signal at the output, red LED

Thermocouple Signal Conditioner Type J, K

Approvals: , CSA in preparation

Dimensions (mm) W x H x D
12.5 x 100 x 100

Description	Output signal	Type	Part no.	Std. pack	Part no. key for input temperature range
dipos Signal Conditioner TC					
for Type J and K thermocouples					
	0...10 V / 0(4(*)...20 mA	Type J	82.021.08XX.0	1	XX = 03 0...300 °C 06 0...600 °C
	0...10 V / 0(4(*)...20 mA	Type K	82.021.18XX.0	1	12 0...1200 °C 31 0...150 °C
Wiring diagram, dimensions		See page 501			
Technical data		Ordering example:			
Measured input		TC Type K, Input 0...100 °C			
Input		Type J (Fe-CuNi) or Type K (NiCr-Ni) in accordance with		Part no.	82.021.1812.0
Temperature ranges		0...150/300/600/1200 °C			
Measured output					
Output signal		0...10 V, 0(4)...20 mA			
Maximum load for voltage signal		5 mA			
Load for current signal		0...500 Ω (no load error)			
Output signal in event of wire breakage					
Voltage output:		ca. 13 V			
Current output:		ca. 26 mA			
Measuring accuracy					
Transmission error		≤ 1 % of final value (at 20 °C ambient temperature)			
Transmission error for measuring range span ≤ 200K		≤ 2 % of final value (at 20 °C ambient temperature)			
Max. temperature co-efficient		200 ppm/K (ref. final value)			
Load error (deviation at 100 Ω load)		< 0,02 %/100 Ω			
CJC compensation		directly at the TC terminal			
Zero/span adjustment range		approx. 5 % Approx. of scope of measuring range			
General data					
Supply data		24 V DC +25 % / -20 %, polarised			
Power consumption		ca. 25 mA + output current			
Ambient temperature range		0...60 °C (100 % capacity utilisation of device, series connected)			
Norms, specifications		DIN EN 50178, EMC guideline 89/336/EWG			
EMV					
Emitted interference		EN 60715/Kl. B, EN 61000-6-1, CISPR 222/Kl. B			
Interference immunity		EN 61000-4-2/3/4/5/6			
Accessories					
Module board, overall width of 12.5mm, 4 connections per side					
Screw terminal			80.060.0030.1	1	
Spring clamp terminal			80.060.0031.1	1	
Coding branch			Z5.563.0453.0	25	
Plug-in jumper			Z8.000.0229.5	50	
Large marker tag, white, blank			04.249.4053.0	500	
Small marker tag					
red, blank			04.249.1053.0	500	
blue, blank			04.249.1553.0	500	
white, blank			04.249.2053.0	500	

dipos

RTD/Pt100

Block diagram

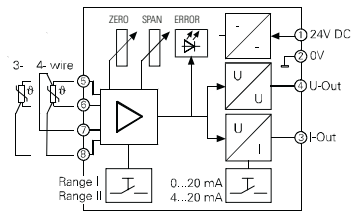

Dimension drawing

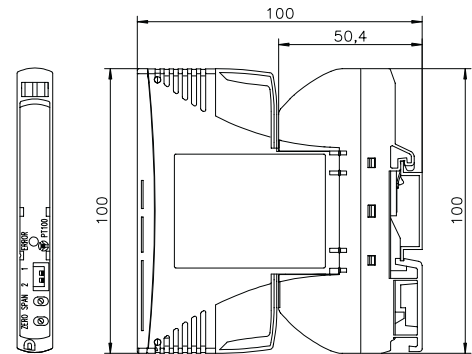

TC

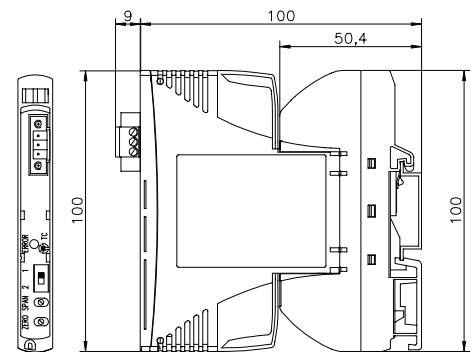
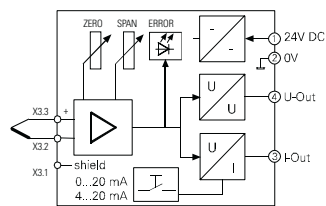

cores

Temperature measuring range	S1	S2	S8
-50...+50 °C	off	off	on
0...100 °C	off	off	off
0...150 °C	on	off	off
0...200 °C	on	on	off
Current output	S3	S4	
0...20 mA	on	off	
4...20 mA	off	on	
Input	S5	S6	S7
2 wire	off	on	on
3 wire	on	on	off
4 wire	off	off	off

Reference key for **cores** Pt100
82.010.XXXX.0

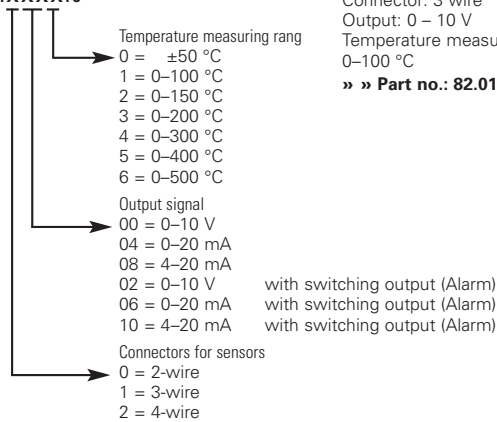

Example of how to order:

Connector: 3 wire
 Output: 0 – 10 V
 Temperature measuring range:
 0-100 °C

» » **Part no.: 82.010.1001.0** « «

Caution: The part number determines the setting of the DIP switches within a variant.

They can be subsequently altered. But, care should be taken to ensure that the adjustment is within the parameters of the particular variant.

Functional overview

	Variant 1	Variant 2	Variant 3	Variant 4	Variant 5	Variant 6	Variant 7	Variant 8
Temperature ranges	± 50 °C 0-100 °C 0-150 °C 0-200 °C	± 50 °C 0-100 °C 0-150 °C 0-200 °C	0-300 °C 0-400 °C 0-500 °C	0-300 °C 0-400 °C 0-500 °C	± 50 °C 0-100 °C 0-150 °C 0-200 °C	± 50 °C 0-100 °C 0-150 °C 0-200 °C	0-300 °C 0-400 °C 0-500 °C	0-300 °C 0-400 °C 0-500 °C
Analog signal	0-10 V	0-20 mA 4-20 mA	0-10 V	0-20 mA 4-20 mA	0-10 V	0-20 mA 4-20 mA	0-10 V	0-20 mA 4-20 mA
Alarm output					yes	yes	yes	yes

Caution: Adjustment of the zero and span is required after every change of the DIP switches!

Analog measurement technology

Analog interface module



without electrical isolation



Application:

The Wieland interface modules AKB and AKT are used to transfer an analog measured value from one signal format to another.

Dimensions (mm) W x H x D
16.5 x 60.5 x 90.5

Analog interface module without electrical isolation

Approvals: , CSA

Std. pack	Part no.	Part no.	Part no.	Part no.
1	-10...+10 V	-	-	-
1	0...10 V	-	-	57806.0053.0
1	0...20 mA	-	57806.0253.0	-
1	4...20 mA	-	57806.0353.0	-
	Output	-10...10 V	0...10 V	0...20 mA
Other signals on request		Ordering example:		
		AKB 20 mA / 10 V		
		57806.0253.0		
Wiring diagram, sample application		See page 510		
Technical data				
Operating voltage		24 V DC ± 20%, polarised		
Typical power consumption (Output signal 20 mA)				
at 19 V DC				
at 24 V DC		ca. 12 mA + output current		
at 29 V DC				
Input				
Input resistance:				
for standard voltage		> 1 MΩ		
for standard current		49.9 Ω		
Maximum permitted input signal				
for standard voltage		60 V		
for standard current		70 mA (3,5 V)		
Voltage drop at 20 mA		1 V		
Input protection against voltage peaks		LC-Filter		
Output				
Output load:				
for maximum standard voltage		5 mA (RL ≥ 100 kΩ, see R _i)		
for standard current		0...500 Ω (load)		
Maximum load error (adjustment at 100 Ω)		0.02 % / 100 Ω		
Output protection against external voltage		Z-Diode		
Transfer procedure				
Static transmission error at 20 °C		< 0.2 % v. E.		
Temperature coefficient		< 0.015 %/K		
Effect of load impedance at current output		0.02 % / 100 Ω		
Limit frequency: (sinus 100%)				
at sinus 100%		20 kHz		
at ± 10 V		10 kHz		
Typical effect of frequency on transfer		1 % / kHz; 2°el / kHz		
Isolation				
All terminals to earth		2 kV _{eff}		
Temperature range				
Operating temperature range for 24 V				
vertical installation without space		0...50 °C		
vertical installation with spacing of 20 mm		0...60 °C		
Storage temperature		-40...+85 °C		
Wire range		20 – 10 AWG		

with signal and supply isolation



Analog interface module with electrical isolation

Approvals: , CSA

Dimensions (mm) W x H x D
22.5 x 60.5 x 90.5

Std. pack		Part no.	Part no.	Part no.	Part no.
1	-10...+10 V	57806.1053.0*	57806.2253.0	57806.5653.0	57806.2153.0
1	0...10 V	57806.2653.0	57806.1053.0	57806.0653.0	57806.0953.0
1	0...20 mA	57806.2753.0	57806.0753.0***	57806.1153.0**	57806.1253.0
1	4...20 mA	57806.5553.0	57806.0853.0	57806.1353.0	57806.1153.0'
	Output	-10...10 V	0...10 V	0...20 mA	4...20 mA
Other signals on request		Ordering example: AKT ±10 V / ±10 V 57806.1053.0		* contains transfer 0...10 V / 0...10 V	** contains transfer 4...20 mA / 4...20 mA
Wiring diagram, sample application				*** can also be used for -20...+20 mA / -10 V...+10 V	
Technical data		See page 510			
Operating voltage		24 V DC ± 20%, polarised			
Typical power consumption (Output signal 20 mA)					
at 19 V DC		117 mA			
at 24 V DC		88 mA			
at 29 V DC		72 mA			
Input					
Input resistance:					
for standard voltage		1 MΩ			
for standard current		49.9 Ω			
Maximum permitted input signal					
for standard voltage		60 V			
for standard current		70 mA (3.5 V)			
Voltage drop at 20 mA		1 V			
Input protection against voltage peaks		LC-Filter			
Output					
Output load:					
for standard voltage maximum		5 mA (RL ≥ 100 kΩ, see Ri)			
for standard current		0...500 Ω (load)			
Maximum load error (adjustment at 100 Ω)		0.02 % / 100 Ω			
Maximum output ripple (2 output filters)		30 mV _s (40 kHz)			
Output protection against external voltage		Z-Diode(n)			
Transfer procedure					
Static transmission error at 20 °C		< 0.1 % v. E.			
Temperature coefficient		< 0.02 % / K			
Effect of load impedance at current output		0.02 % / 100 Ω			
Limit frequency: (Sinus 100%)		20 kHz			
at ± 10 V		10 kHz			
Typical effect of frequency on transfer		1 % / kHz; -2°el / kHz			
Isolation					
Input / Output / Supply		3 x 1,5 kV _{eff} 1 min.			
Input / Output / Supply		3 x 2,5 kV _{eff} 10 sec.			
Input / Output / Supply		3 x 4 kV _{eff} 1,2/50 μs			
All terminals to earth		2 kV _{eff}			
Temperature range					
Operating temperature range for 24 V					
vertical installation without space		0...50 °C			
vertical installation with spacing of 20 mm		0...60 °C			
Storage temperature		40...+85 °C			
Wire range		20 – 10 AWG			

Analog measurement technology

Isolating set point amplifier

UET

with 2 contact outputs

Important note for user:

The relay outputs must be supplied from the same phase (e.g. L1).

Caution:

Can only be mounted vertically due to the internal relays

Dimensions (mm) W x H x D
22,5 x 60,6 x 90,5

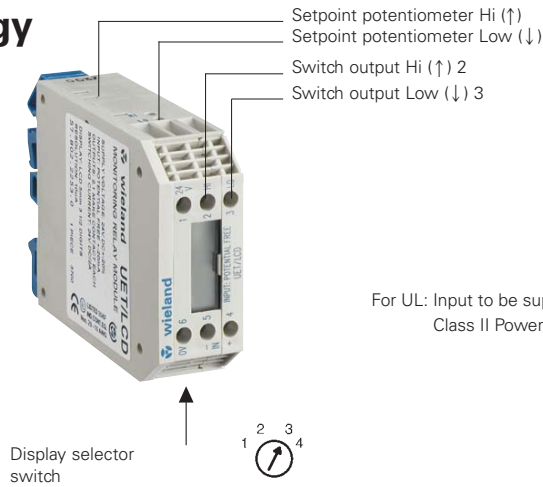

For UL: Input to be supplied from Listed Class II Power Supply

Isolating set point amplifier with LCD display or measuring points

Approvals: , CSA

Description	Type	Part no.	Std. pack	Type	Part no.	Std. pack
with measuring points	UET ±10 V*	57.802.1053.0	1	UET 20 mA**	57.806.1253.0	1
with LCD display	UET/LCD ±10 V*	57.802.2053.0	1	UET/LCD 20 mA**	57.802.2253.0	1
Versions with other input data available on request	* contains standard signal 0...10 V			** contains standard signal 4...20 mA		
Wiring diagram	See page 513			See page 513		
Technical data	UET ±10 V			UET 20 mA		
Operating voltage	24 V DC ±20%, polarised			24 V DC ±20%, polarised		
Power consumption at 24 V, 2 active relays	ca. 40 mA + output currents			ca. 40 mA + output currents		
Potential free input						
Measured input	±19.99 V			±19.99 mA		
Input resistance	1 MΩ			100 Ω		
Maximum permitted input signal	±50 V			±50 mA (±5 V)		
Input protection (interference suppression)	LC-filter			LC-filter		
Measuring points for external multimeter on measured input potential (for UET)	±1.99 V (acc. ±19,9 ±1.99 measured signal)			±1.99 V (acc. ±19.9 V Measured signal)		
Digital display, LCD 3 1/2 digit	with sign and dimension			with sign and dimension		
Character height	5 mm			5 mm		
Accuracy of display at 20 °C	±2 digit			±2 digit		
at 0...60 °C	±5 digit			±5 digit		
Display of range	±19.99 V			±19.99 mA		
Resolution	10 mV			10 µA		
Setpoint adjustment range	±19.99 V			±19.99 mA		
Switch outputs						
Switching voltage	24 V DC			24 V DC		
Maximum switching current	2 A			2 A		
Switching hysteresis	ca. ±20 mV			ca. ±20 µA		
Reproducibility of switching points	ca. ±10 mV			ca. ±10 µA		
Reaction time Pickup delay	7 ms			7 ms		
Dropout delay	5 ms			5 ms		
Contact	2 x 1 make contact (SPST, N. O.)			2 x 1 make contact (SPST, N. O.)		
Contact material	AgCdO + 1 µ Au			AgCdO + 1 µ Au		
Isolation						
input and supply	500 V DC			500 V DC		
contact and input	500 V DC			500 V DC		
contact and supply	-			-		
open contact	750 V _{eff.}			750 V _{eff.}		
Isolation against mounting rail	2 kV _{eff.}			2 kV _{eff.}		
Temperature range						
Operating temperature range, series connected at Vertical installation without spacing	0 ...50 °C			0 ...50 °C		
Vertical installation with spacing of 20 mm	0...60 °C			0...60 °C		
Storage temperature	-40...+85 °C			-40...+85 °C		

UET UET-P

with 2 potential free contact outputs



View from underneath

Caution:

It is permitted to install the device vertically due to the relays

Dimensions (mm) W x H x D
29 x 60,6 x 90,5

Position 1+4: Measured value/
actual value
Position 2: Setpoint "LO" (↓)
Position 3: Setpoint "HI" (↑)

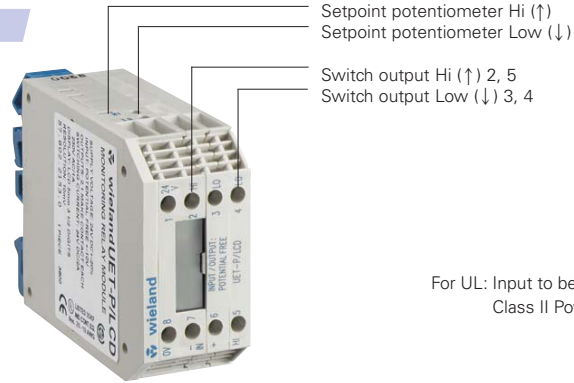

For UL: Input to be supplied from Listed Class II Power Supply

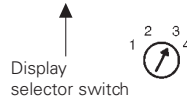

Display selector switch

with LCD display or measuring points
Approvals , CSA

Isolating set point amplifier, potential free

Description	Part no.	Std. pack	Part no.	Std. pack	Part no.	Std. pack
with measuring points	UET-P ±199 mV	57802.1453.0	1			
	UET-P ±10 V*			57802.1153.0	1	
	UET-P 20 mA**					57802.1353.0
with LCD display	UET-P/LCD ±10 V*			57802.2153.0	1	
	UET-P/LCD 20 mA**					57802.2353.0
Versions with other input data available on request				* contains standard signal 0...10 V		** contains standard signal 4...20 mA
Wiring diagram	See page 513		See page 513		See page 5/111	
Technical data	UET-P ±199 mV		UET-P ±10 V		UET-P 20 mA	
Operating voltage	24 V DC ±20%, polarised		24 V DC ±20%, polarised		24 V DC ±20%, polarised	
Power consumption at 24 V, 2 active relays	ca. 40 mA + output currents		ca. 40 mA + output currents		ca. 40 mA + output currents	
Potential free input						
Measured input	±19.99 mA		±19.99 mA		±19.99 mA	
Input resistance:	1 MΩ		1 MΩ		100 Ω	
Maximum permitted input signal	±50 V		±50 V		±50 mA (±5 V)	
Input protection (interference suppression)	LC-Filter		LC-Filter		LC-Filter	
Measuring points for external multimeter						
on measured input potential (for UET)	±1.99 V (acc. ±19.9 V measured signal)		±1.99 V (acc. ±19.9 V measured signal)		±1.99 V (acc. ±19.9 V measured signal)	
Digital display, LCD 3 1/2 digit			with sign and dimension		with sign and dimension	
Character height			5 mm		5 mm	
Accuracy of display						
at 20 °C			±2 digit		±2 digit	
at 0...60 °C			±5 digit		±5 digit	
Display of range	±199,9 mV		±19.99 V		±19.99 mA	
Resolution	100 µV		10 mV		10 µA	
Setpoint adjustment range	±199,9 mV		±19.99 V		±19.99 mA	
Switch outputs						
Switching voltage	24 V DC / 230 V AC		24 V DC / 230 V AC		24 V DC / 230 V AC	
Maximum switching current	2 A DC / 1 A AC		2 A DC / 1 A AC		2 A DC / 1 A AC	
Switching hysteresis	ca. 200 µV		ca. 20 mV		ca. ±20 µA	
Reproducibility of switching points	±100 µV		±10 mV		ca. ±10 µA	
Reaction time						
Pickup delay	7 ms		7 ms		7 ms	
Dropout delay	5 ms		5 ms		5 ms	
Contact	2 x 1 make contact (SPST, N. O.)		2 x 1 make contact (SPST, N. O.)		2 x 1 make contact (SPST, N. O.)	
Contact material	AgCdO + 1 µ Au		AgCdO + 1 µ Au		AgCdO + 1 µ Au	
Isolation						
Input and supply	500 V DC		500 V DC		500 V DC	
Contact and input	1.5 kV _{eff}		1.5 kV _{eff}		1.5 kV _{eff}	
Contact and supply	1.5 kV _{eff}		1.5 kV _{eff}		1.5 kV _{eff}	
open contacts	750 V _{eff}		750 V _{eff}		750 V _{eff}	
Isolation against mounting rail	2 kV _{eff}		2 kV _{eff}		2 kV _{eff}	
Temperature range						
Operating temperature range, series connected at						
Vertical installation without spacing	0 ...50 °C		0 ...50 °C		0 ...50 °C	
Vertical installation with spacing of	0...60 °C		0...60 °C		0...60 °C	
Storage temperature	-40...+85 °C		-40...+85 °C		-40...+85 °C	

Analog measurement technology

Constant voltage source 10 V

dipos KSO



- Overall width 12.5 mm
- Output voltage can be set between 9.5 V and 10.5 V
- Detection of wire breakage
Overload signal at the output, red LED

Dimensions (mm) W x H x D
12.5 x 100 x 100

Constant voltage source dipos_{KSO} 10 V

Approvals: , CSA in preparation

Description	Output signal	Type	Part no.	Std. pack
dipos KSO 10 V Constant voltage source		dipos KSO 10 V	82.081.0000.0	1
Wiring diagram, dimensions siehe Seite 513				
Technical data				
Measured input				
Operating voltage U_V		24 V DC (16...30 V DC), polarised		
Power consumption at $U_V = 24$ V		approx. 10 mA + output current		
Measured output				
Output voltage		10 V DC constant, short circuit proof		
Setting range		9.5 V...10.5 V DC		
Permitted output load		0...30 mA		
Short-circuit current		approx. 50 mA		
Maximum residual ripple		10 mV _{SS}		
Output protection		Protective diodes		
Measuring accuracy				
Intrinsic error		± 0.1% of final value (at $U_V = 24$ V, and 20 °C ambient temperature)		
Maximum temperature coefficient		150 ppm/K of final value		
General data				
Isolation				
		2 kV _{eff} (terminals to mounting rail)		
Ambient temperature range		0 °C...+60 °C (at $U_V = 24$ V)		
Storage temperature		-25 °C...+60 °C		
Transport temperature		-25 °C...+70 °C		
EMC				
Emitted interference		EN 55022/Kl. B, EN 61000-6-1, CISPR 22/Kl. B		
Interference immunity		EN 61000-4-2/3/4/5/6		
Accessories				
Module board, overall width of 12.5mm, 4 connections per side				
Screw terminal		80.060.0020.1		1
Spring clamp terminal		80.060.0021.1		1
Coding branch		Z5.563.0453.0		25
Plug-in jumper		Z8.000.0229.5		50
Large marker tag, white, blank		04.249.4053.0		500
Small marker tag		04.249.1053.0		500
red, blank		04.249.1553.0		500
blue, blank		04.249.2053.0		500
white, blank		04.249.2053.0		500

Analog measurement technology

cores, AKT+AKB

cores dimensions

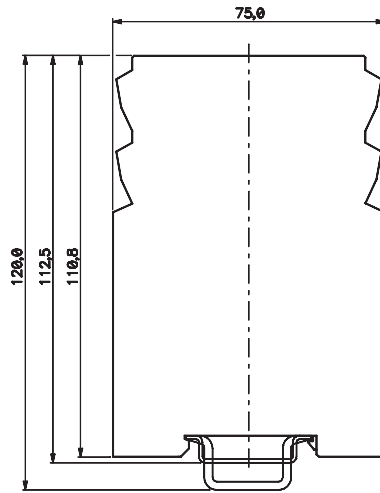

AKB Analog interface module

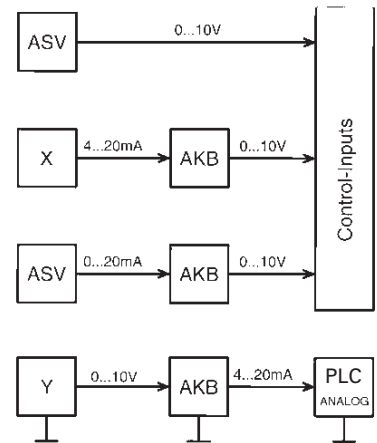
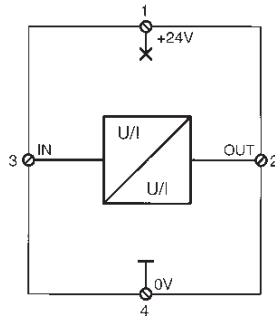

AKT Analog isolating module

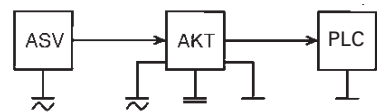
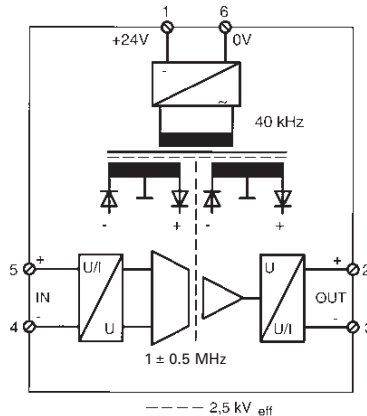

UET, UET-P, dipos_{KSQ}, KSQ, dipos_{KSQ}, KSQ

UET/UET-P Isolating set point amplifiers

UET

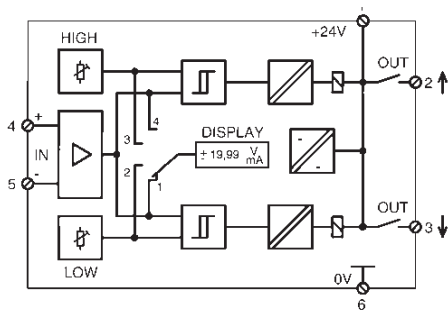

UET-P

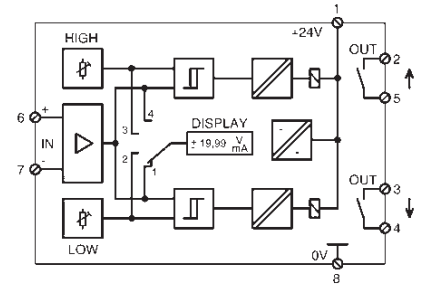

KSQ
Constant voltage source

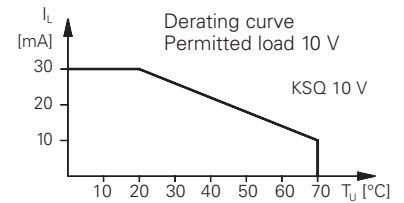
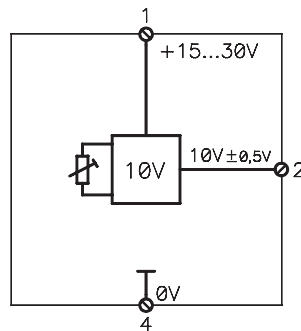

electronics

dipos
Constant voltage source

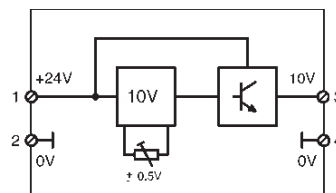
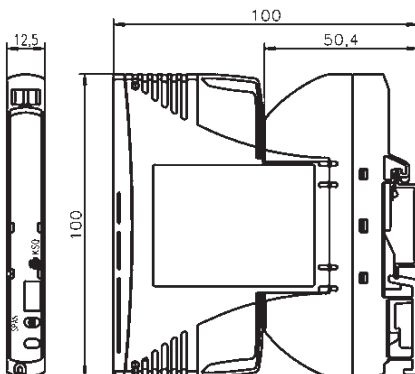

Power-Supply

power

Single phase/three phase switched mode power supply units

Power supply units 24 V/0.3 – 40 A

Universal power transformer

Rectifier module

Fixed voltage regulator

power offers

- Temperature controlled power limit
- Efficiency < 90 %
- Modules with current limiter
- Overload indication
- Compact designs
- Short circuit protection
- Broad band output

All Wieland Components which require **CE** general certification are **CE** certified, and identified with the **CE** logo.



electronics

Electronic Components Power-Supply



Explanation of important technical terms



Output characteristic

Response characteristic of the power supply when exceeding the specified output values.

The output characteristics are:

Constant current mode

When exceeding the nominal current, the device supplies a constant current independent of the voltage.

Fold-back mode

When exceeding the nominal current, the output voltage decreases to zero while the current subsides.

Hiccup mode

The device switches off when the nominal current is exceeded, but switches on again periodically and checks whether the overload is still applied. When the overload has diminished, the device switches on automatically.

Over-current switch-off mode

When exceeding the nominal current, the device switches off and must be manually switched on again after the overload is removed.

Response time

The period of time required after a defined load change until the output voltage is again within the tolerance range.

Operating temperature

The temperature range that an operating device must not exceed.

Drift

Output voltage changing over time or the temperature.

DC/DC transducer

Device that converts a given direct voltage into a different direct voltage by means of a switching regulator.

Inrush current

The peak current caused during switch-on of a power supply by the charging current of the filter capacitors. It is limited by the input impedance but can also be limited further by special components.

Radio interference, electromagnetic interference

Unwanted high-frequency disturbance variables caused by switching processes within the power supply. We distinguish between conducted and radiated radio interference. Conducted interferences are reduced to permitted values by means of filters, while radiated interferences can be kept within the permitted limits by means of optimized PCB creation and screening.

Insulation voltage

Insulation voltage is the maximum voltage that can be applied between two isolated circuits.

Cooling

Heat transfer from components that are producing power loss. We distinguish between thermal radiation, convection (natural and forced convection with fan), and thermal conduction to an external heat exchanger.

Short-circuit protected

Protection of the power supply against overload and short circuit.

See the output characteristic for various options.

Storage temperature

The temperature range at which a device can be stored (not operated) without being damaged.

Load regulation

Change of output voltage at a defined load change.

Power reduction, derating

Reduction of output power required under certain circumstances such as when exceeding a defined temperature.

Power factor

Ratio between real power and apparent power. In a switch-mode power supply, the power factor normally becomes smaller than 1 due to a non-sinusoidal current input.

Hold-up time

The period of time in which the output voltage is still controlled after the mains voltage has dropped completely.

Line regulation

Change of output voltage at a defined mains voltage change while all the other parameters (load) are kept constant.

Nominal output voltage

Output voltage specified for the device. The voltage can be increased or decreased within specified limits below and above the nominal value.

Temperature coefficient

Output voltage change depending on the temperature.

Ambient temperature

Temperature of the steady air around the device. It is normally measured within a radius of approx. 10 mm around the operating device.

Overshoot

Increase of the output voltage exceeding the specific value due to a rapid load change.

Overcurrent limitation

Protective mechanism against overload of the power supply due to excessive output current. Also see short-circuit current.

Efficiency

Relation between output power and input power, normally indicated at full load and nominal input voltage. Efficiency is one of the most important features when evaluating a power supply.

The difference between input power and output power is converted into heat. Any increase in efficiency therefore results in the heat load on the components being reduced and the service life of the device being increased. Even small improvements in efficiency will result in drastic changes in the service life.

wipos

wipos switch-mode power supplies – Power competence for any control cabinet

Power supplies are the heart of any control cabinet. They safeguard the life of any connected electrical and electronic component. In addition to providing a reliable supply to units under different load cases, the devices themselves must also be safe for the user.

Narrow, but powerful

Knowing that rail space is a key concern for our customers, we designed our new **wipos** power supplies with a very narrow footprint, enabling optimal space utilization in the control cabinet. Our single-phase, rail-mountable devices range from 50 to 480 W and require only 45 mm to 86 mm of rail space.

Your life is important to us

The vertical **wipos** device series, provides a hinged cover for the primary-side connection points. It safely covers all connection points with hazardous contact voltage. Wire entries are clearly marked for safe and easy installation.

Overload problems – non-existent for wipos

wipos incorporates a temperature-controlled power limitation function as protection against overload caused by excessive ambient temperatures or unfavorable installation conditions. The output voltage is reduced causing the output power to decrease before the semi-conductors can reach an impermissibly high temperature.

Parallel operation – whatever you want

For special balancing of the output current during parallel operation of several **wipos** devices, the output can be changed. It is set by default in a way that the output voltage is as constant as possible, independent of the load.

The control precision is $\pm 1\%$ of the nominal current. For parallel operation, the output is changed in a way that an approximately uniform load distribution is achieved even when considering manufacturing tolerances and slightly different output voltages. The overall residual ripple is very low at < 50 mV.

Further features of the **wipos** switch mode power supply series:

- Power factor correction (PFC, vertical versions) according to EN 61000-3-2
- Temperature-prompted power limitation
- Efficiency up to 90%
- Extended output voltage range of 23 V – 30 V
- Output characteristic selectable for output current balancing during parallel operation
- Change of current limitation via internal potentiometer
- Reduced ripple on the output (< 50 mV)
- Reduced ramp-up time < 1 s
- Protection against battery discharge in OFF state during parallel loading operation
- Red LED to signal overloads
- Convenient DIN rail mounting, even for 40 A, 3-phase devices
- Hiccup Mode
- Optional features; remote ON/OFF, overload signal, power failure signal, and output characteristic switchover
- UL-pending, CSA approvals
- Standards
VDE 0805, EN 60950, IEC 950, UL 1950, safety extra-low voltage (SELV) EN 60950, EN 55011, EN 61000-6-1/-2, EN 55022 class B

Custom devices and solutions also available.

Single-phase switch-mode power supplies vertical design

wipos



24 V / 2 A
Primary switch-mode regulator
 CE; Approvals: , CSA and pending
 45 x 72 x 105



24 V / 5 A
Primary switch-mode regulator
 CE; Approvals: , and CSA pending
 70 x 138 x 139

Dimensions (mm): W x H x D

Description	Type	Part no.	Type	Part no.
48 W	power supply, 24 V / 2 A	81.000.6010.0		
120 W			power supply, 24 V / 5 A	81.000.6030.0
240 W				
480 W				
Output power, current limitation characteristic	see graphs on page 530		see graphs on page 530	
Input				
Nominal input voltage	110–230 V _{AC} , 47–63 Hz (universal input)		115/230 V _{AC} , 47–63 Hz (selectable input)	
Input voltage range	94–265 V _{AC}		93–132 V _{AC} , 187–265 V _{AC}	
Nominal input current	0.6 A at 230 V _{AC} /1.1 A at 115 V _{AC}		0.9 A at 230 V _{AC} /2.2 A at 115 V _{AC}	
Input current peak	I/t < 1.5 A/s		< 30 A	
Power factor cos φ	0.45 capacitive at 230 V _{AC} /0.5 capacitive at 115 V _{AC}		0.5 capacitive at 230 V _{AC} /0.58 capacitive at 115 V _{AC}	
PFC standard (harmonics)	–		EN 61000-3-2	
Output				
Output voltage	24 V ±3%		24 V ±1%	
Typical output setting range	–		22–30 V DC	
Output direct current	0–2 A		0–5 A	
Max. power output	–		120 W (when set to 30 V max. 4 A)	
Ripple	< 50 mV		< 50 mV	
Typical current limitation	2.5 A		6 A	
Parallel operation	yes		yes	
Efficiency, typical	89%		89%	
Hold-up time	> 70 ms / 230 V _{AC} ; > 10 ms / 115 V _{AC}		> 20 ms / 230 V _{AC} ; > 15 ms / 115 V _{AC}	
Line regulation	< 0.2% at UON ±15%		< 0.2% at UON ±15%	
Load regulation	< 1% at 0 A -> >I _{nominal}		< 1% at 0 A -> >I _{nominal}	
Dynamics	< 2 ms at 10 ↔ 90% I _{nominal}		< 2 ms at 10 ↔ 90% I _{nominal}	
Current limitation	permanently short-circuit proof (see graphs on page 530)		permanently short-circuit proof (see graphs on page 530)	
Overrun-proof/open-circuit proof	yes		yes	
Output overcurrent switch-off	yes		yes	
Output security	VDE 0805/EN 60950/IEC 950/UL 1959		VDE 0805/EN 60950/IEC 950/UL 1959	
Class of Protection	safety extra-low voltage (SELV) EN 60950		safety extra-low voltage (SELV) EN 60950	
Degree of protection	class I at 149002-31001/149002-21001		class I at 149002-31001/149002-21001	
Additional data, standards	IP 20		IP 20	
Leakage current	< 0.25 mA (47–63 Hz mains frequency)		< 0.75 mA (47–63 Hz mains frequency)	
Ambient temperature	–10 °C...+70 °C at free convection		–10 °C...+70 °C at free convection	
Power derating	2.5%/K from +60 °C (see graphs on page 530)		2.5%/K from +60 °C (see graphs on page 530)	
Storage temperature	–25 °C...+85 °C		–25 °C...+85 °C	
EMC CE-certified	EN 55011, EN 61000-6-1/-2 EN 55011/EN 55022 class B		EN 55011, EN 61000-6-1/-2 EN 55011/EN 55022 class B	
	8 kV contact discharge, 15 kV air discharge		8 kV contact discharge, 15 kV air discharge	
	10 V/m		10 V/m	
	4 kV input, 2 kV output / capacitive coupling		4 kV input, 2 kV output / capacitive coupling	
	4 kV unbalanced, 4 kV balanced		4 kV unbalanced, 4 kV balanced	
	10 V, 150 kHz...80 MHz		10 V, 150 kHz...80 MHz	
Weight	approx. 0.2 kg		approx. 0.9 kg	
Installation	slide for mounting to DIN rail DIN EN 60715		slide for mounting to DIN rail DIN EN 60715	
Installation position	panel-mounted; input connectors on top, output conn. at the bottom		panel-mounted; input connectors on top, output conn. at the bottom	

wipos



24 V / 10 A
Primary switch-mode regulator
 CE; Approvals: , CSA and pending
 70 x 153.5 x 164



24 V / 20 A
Primary switch-mode regulator
 CE; Approvals: , CSA and pending
 86 x 233 x 173

Dimensions (mm): W x H x D

Description	Type	Part no.	Std. pack	Type	Part no.	Std. pack
48 W						
120 W						
240 W	mains power supply 24 V / 10A	81.000.6040.0	1			
480 W				power supply 24 V / 20 A	81.000.6050.0	1
Output power, current limitation characteristic	see page 10			see page 10		
Input						
Nominal input voltage	115/230 V _{AC} , 47–63 Hz (selectable input)			230 V _{AC} , 47–63 Hz		
Input voltage range	93–132 V _{AC} , 187–265 V _{AC}			190–265 V _{AC}		
Nominal input current	1.8 A at 230 V _{AC} /4.2 A at 115 V _{AC}			3.0 A at 230 V _{AC}		
Input current peak	< 30 A			< 30 A		
Power factor cos φ	0.5 capacitive at 230 V _{AC} /0.58 capacitive at 115 V _{AC}			0.82 capacitive at 230 V _{AC}		
PFC standard (harmonics)	EN 61000-3-2			EN 61000-3-2		
Output						
Output voltage	24 V ±1%			24 V ±1%		
Typical setting range	22–30 V DC			23–29 V DC		
Output direct current	0–10 A			0–20 A		
Max. power output	240 W (when set to 30 V max. 8 A)			480 W (when set to 29 V max. 16 A)		
Ripple	< 50 mV			< 50 mV		
Typical current limitation	12 A			22 A		
Parallel operation	yes			yes		
Efficiency, typical	90%			89%		
Hold-up time	> 35 ms / 230 V _{AC} ; > 30 ms / 115 V _{AC}			> 20 ms / 230 V _{AC}		
Line regulation	< 0.2% at U _{ON} ±15%			< 0.2% at U _{ON} ±15%		
Load regulation	< 1% at 0 A -> > I _{nominal}			< 1% at 0 A -> > I _{nominal}		
Dynamics	< 2 ms at 10 <-> 90% I _{nominal}			< 2 ms at 10 <-> 90% I _{nominal}		
Current limitation	permanently short-circuit proof (see graph on page 10)			permanently short-circuit proof (see graph on page 10)		
Overrun-proof/open-circuit proof	yes			yes		
Output overcurrent switch-off	yes			yes		
Output security	VDE 0805/EN 60950/IEC 950/UL 1959 safety extra-low voltage (SELV) EN 60950			VDE 0805/EN 60950/IEC 950/UL 1959 safety extra-low voltage (SELV) EN 60950		
Class of protection	class I at 149002-31001/149002-21001			class I at 149002-31001/149002-21001		
Degree of protection	IP 20			IP 20		
Leakage current	< 0.75 mA (47–63 Hz mains frequency)			< 3.50 mA (47–63 Hz mains frequency)		
Ambient temperature	–10 °C...+70 °C at free convection			–10 °C...+70 °C at free convection		
Power derating	2.5%/K from +60 °C (see graph on page 10)			2.5%/K from +60 °C (see graph on page 10)		
Storage temperature	–25 °C...+85 °C			–25 °C...+85 °C		
EMC CE-certified	EN 55011, EN 61000-6-1/-2			EN 55011, EN 61000-6-1/-2		
Radio interference suppression	EN 55011/EN 55022 class B			EN 55011/EN 55022 class B		
Static discharge ESD (IEC 1000-4-2)	8 kV contact discharge, 15 kV air discharge			8 kV contact discharge, 15 kV air discharge		
Electromagnetic fields (IEC 1000-4-3)	10 V/m			10 V/m		
Burst (IEC 1000-4-4)	4 kV input, 2 kV output / capacitive coupling			4 kV input, 2 kV output / capacitive coupling		
Surge (IEC 1000-4-5)	4 kV unbalanced, 4 kV balanced			4 kV unbalanced, 4 kV balanced		
Conducted interference type (ENV 50141, IEC 1000-4-6)	10 V, 150 kHz...80 MHz			10 V, 150 kHz...80 MHz		
Weight	approx. 1.1 kg			approx. 2.0 kg		
Installation	slide for DIN rail mounting DIN EN 60715			slide for DIN rail mounting DIN EN 60715		
Mounting position	panel-mounted; input connectors on top, output conn. at the bottom			panel-mounted; input connectors on top, output conn. at the bottom		

Single-phase switch-mode power supplies horizontal design

wipos



24 V / 5 A
Single-phase primary switch-mode regulator
 CE; Approvals: and CSA pending
 147 x 105 x 86

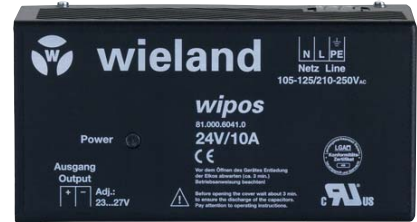

24 V / 10 A
Single-phase primary switch-mode regulator
 CE; Approvals: and CSA pending
 205 x 105 x 86

Dimensions (mm): W x H x D

Description	Type	Part no.	Std. pack	Type	Part no.	Std. pack
120 W	mains power supply 24 V / 5 A	81.000.6031.0	1			
240 W				mains power supply 24 V / 10 A	81.000.6041.0	1
480 W						
Output power, current limitation characteristic	see graphs on page 530			see graphs on page 530		
Input						
Nominal input voltage	105-250 V _{AC} , 47-63 Hz (universal input)			105-125 V _{AC} / 210-250 V _{AC} , 47-63 Hz		
Input voltage range	97-265 V _{AC} , 47-63 Hz			97-132 V _{AC} / 195-265 V _{AC} , 47-63 Hz, can switched over to solder bridge		
Nominal input current	1.23 A at 230 V _{AC}			4.0 A at 115/230 V _{AC} / 2.2 A at 230 V _{AC}		
Input current peak	< 30 A			< 30 A		
Power factor cos φ	0.52 capacitive at 230 V _{AC}			0.52 capacitive at 230 V _{AC}		
Fuse	5 x 20 mm, T 3,15 A / 250 V internal			5 x 20mm, T 6.3 A / 250 V internal		
Output						
Output voltage	24 V DC ±1%			24 V DC ±1%		
Typical setting range	22.5-27.5 V DC			22.5-27.5 V DC		
Output direct current	0-5 A			0-10 A		
Ripple	< 100 mV			< 100 mV		
Typical current limitation	6 A			12.5 A		
Parallel operation	yes			yes		
Efficiency, typical	86%			89%		
Hold-up time	> 80 ms / 230 V _{AC} ; > 15 ms / 115 V _{AC}			> 15 ms / 230 V _{AC}		
Line regulation	< 0.2% at U _{ON} ±15%			< 0.2% at U _{ON} ±15%		
Regulation	< 1% at 0 A -> >I _{nominal}			< 1% at 0 A -> >I _{nominal}		
Dynamics	< 2 ms at 10 <-> 90% I _{nominal} , overshoot < 2%			< 2 ms at 10 <-> 90% I _{nominal} , overshoot < 2%		
Current limitation	permanently short-circuit proof (see graphs on page 530)			permanently short-circuit proof (see graphs on page 530)		
Overrun-proof/open-circuit proof	yes			yes		
Output overcurrent switch-off	yes			yes		
Output security	VDE 0805/EN 60950/IEC 950/UL 1959 safety extra-low voltage (SELV) EN 60950			VDE 0805/EN 60950/IEC 950/UL 1959 safety extra-low voltage (SELV) EN 60950		
Class of protection	class I			class I		
Degree of protection	IP 20			IP 20		
Leakage current	< 0.75 mA (47-63 Hz mains frequency)			< 0.75 mA (47-63 Hz mains frequency)		
Ambient temperature	0 °C...+70 °C at free convection			0 °C...+70 °C at free convection		
Power derating	2.5%/K from +60 °C (see graph on page 10)			2.5%/K from +60 °C (see graph on page 10)		
Storage temperature	-25 °C...+85 °C			-25 °C...+85 °C		
EMC CE-certified	EN 61000-6-3/-4, EN 61000-6-1/-2			EN 61000-6-3/-4, EN 61000-6-1/-2		
Radio interference suppression	EN 55011/EN 55022 class B			EN 55011/EN 55022 class B		
Static discharge ESD (IEC 1000-4-2)	8 kV contact discharge, 15 kV air discharge			8 kV contact discharge, 15 kV air discharge		
Electromagnetic fields (IEC 1000-4-3)	10 V/m			10 V/m		
Burst (IEC 1000-4-4)	4 kV input, 2 kV output / capacitive coupling			4 kV input, 2 kV output / capacitive coupling		
Surge (IEC 1000-4-5)	4 kV unbalanced, 4 kV balanced			4 kV unbalanced, 4 kV balanced		
Conducted interference type (ENV 50141, IEC 1000-4-6)	10 V, 150 kHz...80 MHz			10 V, 150 kHz...80 MHz		
Weight	approx. 0.8 kg			approx. 1.2 kg		
Installation	snap-on DIN rail fixation DIN EN 60715			snap-on DIN rail fixation DIN EN 60715		
Installation position	panel-mounted; input connectors on top, output conn. at the bottom			panell-mounted; input connectors on top, output conn. at the bottom		

wipos



24 V / 20 A Single-phase primary switch-mode regulator

CE; Approvals: and CSA pending

Dimensions (mm): W x H x D
240 x 130 x 86

Description	Type	Part no.	Std. pack
120 W			
240 W			
480 W	mains power supply 24 V / 20 A	81.000.6051.0	1
output power, current limitation characteristic	see graphs on page 530		
Input			
Nominal input voltage	210–250 V _{AC} , 47–63 Hz (universal input)		
Input voltage range	195–265 V _{AC} , 47–63 Hz		
Nominal input current	4.2 A at 230 V _{AC}		
Input current peak	< 30 A		
Power factor cos φ	0.53 capacitive at 230 V _{AC}		
Fuse	5 x 20mm, T 10 A / 250 V internal		
Output			
Output voltage	24 V DC ±1%		
Typical setting range	22.5-275 V DC		
Output direct current	0-20 A		
Ripple	< 100 mV		
Typical current limitation	25 A		
Parallel operation	yes		
Efficiency, typical	88%		
Hold-up time	> 15 ms / 115 V _{AC}		
Line regulation	< 0.2% at U _{ON} ±15%		
Load regulation	< 1% at 0 A -> >I _{nominal}		
Dynamics	< 2 ms at 10 <-> 90% I _{nominal} , overshoot < 2%		
Current limitation	permanently short-circuit proof (see graphs on page 530)		
Overrun-proof/open-circuit proof	yes		
Output overvoltage switch-off	yes		
Output security	VDE 0805/EN 60950/IEC 950/UL 1959 safety extra-low voltage (SELV) EN 60950		
Class of protection	class I		
Degree of protection	IP 20		
Leakage current	< 3.50 mA (47–63 Hz mains frequency)		
Ambient temperature	0 °C...+70 °C at free convection		
Power derating	2.5%/K from +60 °C (see graphs on page 530)		
Storage temperature	-25 °C...+85 °C		
EMC CE-certified	EN 61000-6-3/-4, EN 61000-6-1/-2		
Radio interference suppression	EN 55011/EN 55022 class B		
Static discharge ESD (IEC 1000-4-2)	8 kV contact discharge, 15 kV air discharge		
Electromagnetic fields (IEC 1000-4-3)	10 V/m burst (IEC 1000-4-4) 4 kV input, 2 kV output / capacitive coupling		
Surge (IEC 1000-4-5)	4 kV unbalanced, 4 kV balanced		
Conducted interference type (ENV 50141, IEC 1000-4-6)	10 V, 150 kHz...80 MHz		
Weight	approx. 1.9 kg		
Installation	snap-on DIN rail fixation DIN EN 60715		
Mounting position	panel-mounted; input connectors on top, output conn. at the bottom		

Three-phase switch-mode power supplies – horizontal design

wipos



24 V / 20 A
Three-phase primary switch-mode regulator

CE; Approvals: and CSA pending
 240 x 130 x 86



24 V / 40 A
Three-phase primary switch-mode regulator

CE; Approvals: and CSA pending
 296 x 176 x 86

Dimensions (mm): W x H x D

Description	Type	Part no.	Std. pack	Type	Part no.	Std. pack
480 W	mains power supply 24 V / 20 A	81.000.6053.0	1			
960 W				mains power supply 24 V / 40 A	81.000.6063.0	1
Output power, current limitation characteristic	see graphs on page 530			see graphs on page 530		
Input						
Nominal input voltage	3 x 360–500 V _{AC} , 47–63 Hz			3 x 360–500 V _{AC} , 47–63 Hz		
Input voltage range	3 x 340–550 V _{AC} , 47–63 Hz			3 x 340–550 V _{AC} , 47–63 Hz		
Nominal input current	3 x 1.5 A at 3 x 400 V _{AC}			3 x 3 A at 3 x 400 V _{AC}		
Input current peak	< 50 A			< 50 A		
Power factor cos φ	0.53 capacitive at 400 V _{AC}			0.53 capacitive at 400 V _{AC}		
Output						
Output voltage	24 V DC ±1%			24 V DC ±1%		
Typical setting range	22.5–27.5 V DC			22.5–27.5 V DC		
Output direct current	0–20 A			0–40 A		
Ripple	< 100 mV			< 100 mV		
Typical current limitation	25 A			45 A		
Parallel operation	yes			yes		
Efficiency, typical	90%			90%		
Hold-up time	> 5 ms / 400 V _{AC}			> 5 ms / 400 V _{AC}		
Line regulation	< 0.2% at U _{ON} ±15%			< 0.2% at U _{ON} ±15%		
Load regulation	< 1% at 0 A → >I _{nominal}			< 1% at 0 A → >I _{nominal}		
Dynamics	< 2 ms at 10 A → 90% I _{nominal} , overshoot < 2%			< 2 ms at 10 A → 90% I _{nominal} , overshoot < 2%		
Current limitation	permanently short-circuit proof (see graphs on page 530)			permanently short-circuit proof (see graphs on page 530)		
Overrun-proof/open-circuit proof	yes			yes		
Output overvoltage switch-off	yes			yes		
Output security	VDE 0805/EN 60950/IEC 950/UL 1959			VDE 0805/EN 60950/IEC 950/UL 1959		
Class of protection	safety extra-low voltage (SELV) EN 60950			safety extra-low voltage (SELV) EN 60950		
Degree of protection	class I			class I		
Leakage current	IP 20			IP 20		
Leakage current	< 3.50 mA (47–63 Hz mains frequency)			< 3.50 mA (47–63 Hz mains frequency)		
Ambient temperature	0 °C...+70 °C at free convection			0 °C...+70 °C at free convection		
Power derating	2.5%/K from +60 °C (see graphs on page 530)			2.5%/K from +60 °C (see graphs on page 530)		
Storage temperature	–25 °C...+85 °C			–25 °C...+85 °C		
EMC CE-certified	EN 61000-6-3/4, EN 61000-6-1/2			EN 61000-6-3/4, EN 61000-6-1/2		
Radio interference suppression	EN 55011/EN 55022 class B			EN 55011/EN 55022 class B		
Static discharge ESD (IEC 1000-4-2)	8 kV contact discharge, 15 kV air discharge			8 kV contact discharge, 15 kV air discharge		
Electromagnetic fields (IEC 1000-4-3)	10 V/m			10 V/m		
Burst (IEC 1000-4-4)	4 kV input, 2 kV output / capacitive coupling			4 kV input, 2 kV output / capacitive coupling		
Surge (IEC 1000-4-5)	4 kV unbalanced, 4 kV balanced			4 kV unbalanced, 4 kV balanced		
Conducted interference type (ENV 50141, IEC 1000-4-6)	10 V, 150 kHz...80 MHz			10 V, 150 kHz...80 MHz		
Weight	approx. 1.9 kg			approx. 3.6 kg		
Installation	snap-on DIN rail fixation DIN EN 60715			snap-on DIN rail fixation DIN EN 60715		
Installation position	panel-mounted; input connectors on top, output conn. at the bottom			panel-mounted; input connectors on top, output conn. at the bottom		

Power Supply with overload protection and short circuit protection

power supply



Power supply unit 24 V / 0,3 A unregulated

Approvals: CSA
70.5 x 80 x 66



Power supply unit 24 V / 1 A regulated

138 x 80 x 95

Dimensions (mm): W x H x D

Description	Type	Part No.	Box Qty	Type	Part No.	Box Qty
	WRS-T115/230-399M	81.000.3000.0	1	WPS-115/230-24 V1A	81.000.3010.0	1
Note for user:						
Before commissioning the power supply units, an external wire jumper (1 mm ²) must be inserted by the user to select to the input voltage!						
Wiring diagram, dimensions, diagram	See page 531			See page 531		
Input data						
Input voltage (U _E)	115/230 V AC +6%/–10%, 50–60 Hz			115/230 V AC +6%/–10%, 50–60 Hz		
115 V AC**	Insert external jumper between 1–3, 2–4			Insert external jumper between 1–3, 2–4		
230 V AC**	Insert external jumper between 2–3			Insert external jumper between 2–3		
Input current						
at U _E = 115 V AC	ca. 100 mA			ca. 450 mA		
at U _E = 230 V AC	ca. 50 mA			ca. 225 mA		
Power consumption	ca. 8 VA			ca. 52 VA		
Input fuse						
F1 (5 x 20 mm at U _E = 115 V AC)**	160 mA T			500 mA T		
F1 (5 x 20 mm at U _E = 230 V AC)	80 mA T			250 mA T		
** carried out by the user						
Output data						
Nominal voltage (U _N)	24 V DC (note voltage/current diagram page 531)			24 V DC ±5%		
Nominal current	300 mA (note voltage/current diagram page 531)			1 A		
Ripple voltage (load dependent)	< 2 V _{SS}			type 20 mV		
(at full load operation and min. input voltage)	–			maximum 1,5 V		
Output fuse F2 (5 x 20 mm)	315 mA T			short circuit proof		
Bridging facility using jumper	Negative pole			Negative pole		
(Jumper not included with supply)						
Maximum jumper current	0.5 A			1 A		
Status display	LED			LED		
General data						
Isolation voltage between input/output	4 kV, 50 Hz, 1min			4 kV		
Nominal operating mode	100% ED			100% ED		
Ambient temperature	–25 °C...+50 °C			0 °C...+40 °C		
Storage temperature	–40 °C...+85 °C			–40 °C...+85 °C		
Type of connection	Screw terminal			Screw terminal		
Wire range	22 – 12 AWG			22 – 12 AWG		
Finely stranded	0.5 – 2.5 mm ²			0.5 – 2.5 mm ²		
Single core	0.5 – 4 mm ²			0.5 – 4 mm ²		
Safety transformer according to	VDE 0551 (EN 60742)			VDE 0551 (EN 60742)		
Installation on DIN rail	TS 35			TS 35		
Mounting position	horizontal			horizontal		
Accessories						
Jumper (for bridging facility)		Z8.000.0103.4	10		Z8.000.0103.4	10

Power Supply **wipos**

Derating: output power

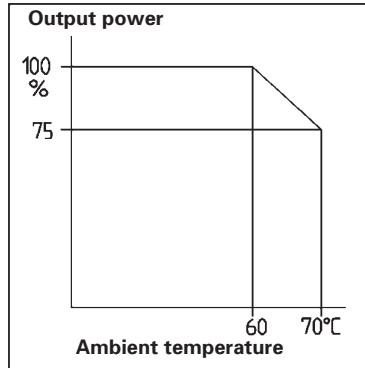

Current limitation characteristic:
Single-phase power supply,
vertical design:
2 A

Single-phase power supply,
horizontal design:
5 A

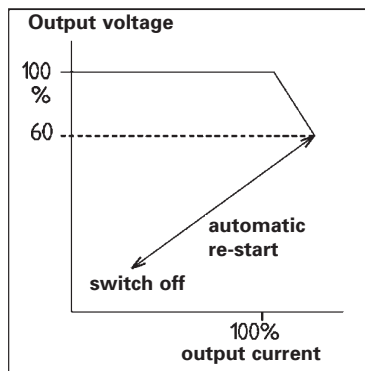

Current limitation characteristic:

Single-phase power supply,
vertical design:
5 A / 10 A / 20 A

Single-phase/three-phase power supply,
horizontal design: 10 A / 20 A / 40 A

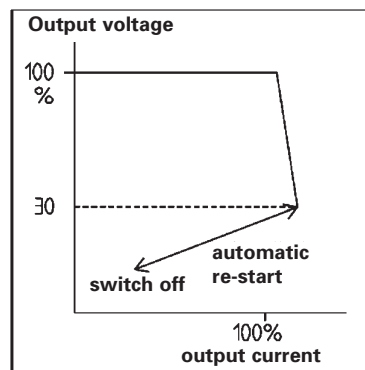

power supply

Power supply unit 24 V/0,3 A

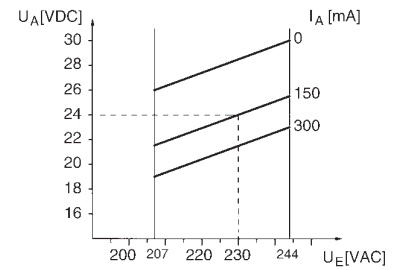
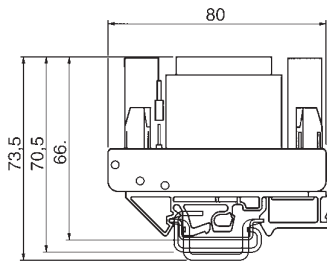
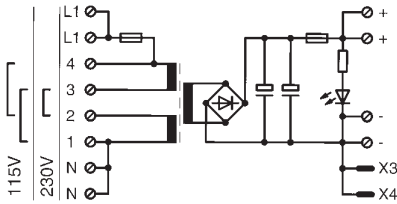

Power supply unit 24 V/1 A

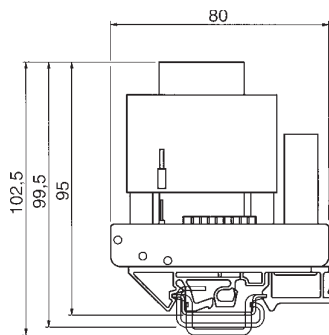
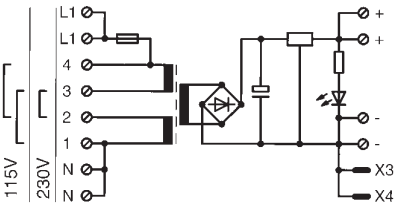

NTU Universal power transformer

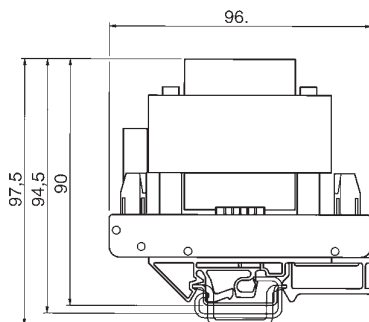
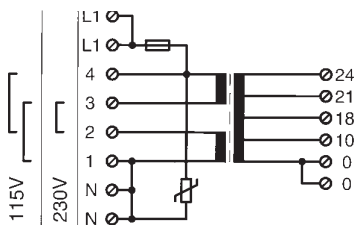

Power Supply

BGL

Rectifier modules

BGL 2,5 A

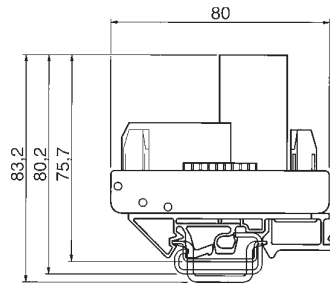
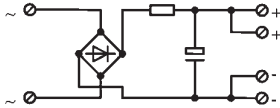

BGL 3 A

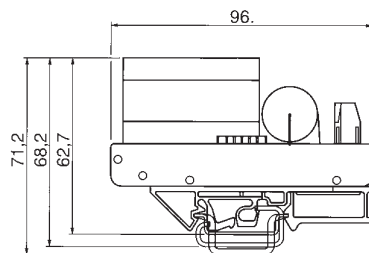
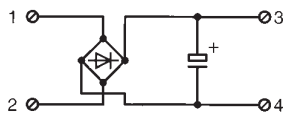

Fixed voltage

FSR 1 A

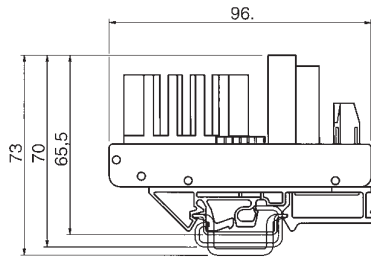
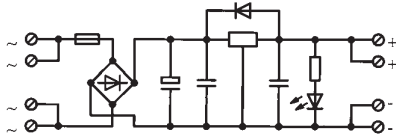

Derating curves

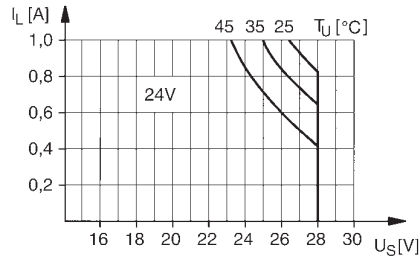
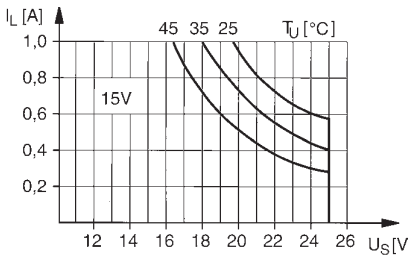
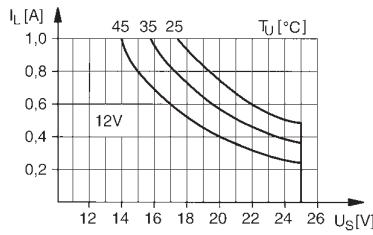
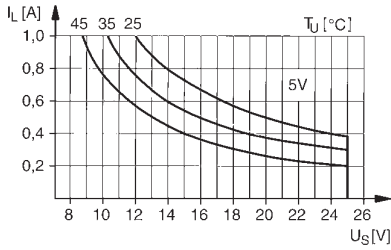

FSR 3 A

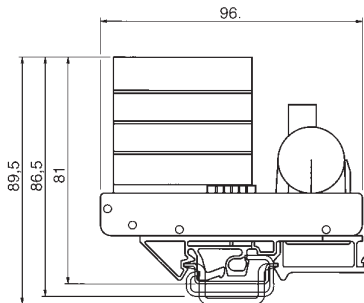
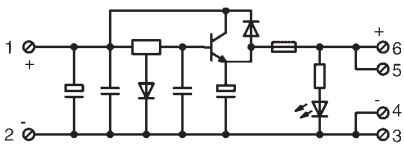

Wieland Function Modules

function

Electronic contactors

Thermistor overload relay

Lamp test module/fuse module

Centralised fault indication

Three phase system monitoring/fuse monitoring

Rotation indicator

Introduction to SSW RS 232 interface converter

Interface converter

function offers

- Electronic load relay
- Machine protection via temperature monitoring
- Detection of wire breakage
- Phase failure
- Various test and monitoring modules
- Compact SSW RS 232 (for V.11 and V.24)

All Wieland Components which require **CE** general certification are **CE** certified, and identified with the **CE** logo.



electronics



Electronic components Wieland Function Modules

Function module General information

ceamos

General information

ceamos

- Electronic three phase contactor
- Electronic reversing contactor
- DC motor-driven relay

General

As opposed to mechanical contactors, electronic load relays offer the benefit of a practically unlimited service life and a high operating speed for functions.

Optocoupler technology enables a non-contacting, bounce-free and wear-resistant switching of phase loads. With a switching frequency up to 10 Hz, a considerable increase in economic efficiency can already be seen compared to conventional, electromechanical components. Electronic relays are primarily used as output elements by programmable controllers.

An additional RCV protective circuit of the outputs enables a continuously reliable operation.

Electronic three-phase contactor

The solid-state relays can switch inductive loads such as motors on and off during zero voltage operation.

Electronic reversing contactor and DC motor driven relay

Apart from switching on and off, the reversing contactor allows a change in the direction of travel for three-phase inductive motors. The DC motor-driven relay performs the same function for DC motors.

Further characteristics include a reciprocal closing lockout as well as a fixed minimum changeover time between anti-clockwise and clockwise rotation.

Thermistor overload relay TMS 101

General

The electronic thermistor overload relay monitors the windings of electrical machines in connection with PTC thermistor detectors. During usage, reliable protection against thermal overload is guaranteed. A bimetal overload trip unit is not required.

The areas of application are:

- Monitoring of motor temperature using short circuit current methodology
- Overload start-up (overload)
- Impeded cooling
- Excessive duty rating
- High ambient temperature
- Locked rotors
- Detection of wire breakage
- Phase failure

Function and structure

The thermistor overload relay TMS 101 evaluates up to six series-connected PTC resistors.

Three-phase inductive motors are usually fitted with three sensors. Pole-changing three-phase inductive motors with separate winding require six sensors. The relay is energised in normal operation i.e. the permitted temperature level has not been exceeded. If the temperature rises above the defined value, which occurs in conjunction with an increase in resistance, the relay drops out. The motor is simultaneously disconnected and the fault indicator lights up.

Due to an internal memory circuit, the motor remains switched off until the reset resistance is reached and the 'reset' button (internal or external) is pressed. Only then is it possible to start up the motor again. To detect a wire breakage, the sensor cables operate using a closed circuit current methodology.

Monitoring modules

General

The increasing automation and centralisation of electrical installations requires more feedback information from the process to guarantee an error-free functional sequence.

Three-phase system monitoring

The most simple and effective way to monitor a three-phase network is to measure the under-voltage. The process involves recording each phase so that a voltage drop is immediately detected. A signal is generated if the voltage falls below 85% of the mains voltage (according to VDE 0108).

Three-phase fuse monitoring

Three-phase induction motors are particularly at risk when a phase fails. The three-phase fuse monitoring is specially designed for monitoring supply leads of three-phase induction motors for which system monitoring is not suitable.

Rotation indicator

The rotation indicator monitors the phase sequence L1-L2-L3 which determines the direction of rotation for three-phase induction motors. If the phase sequence of the monitored three-phase network is incorrect, the relay of the rotation indicator remains open.

Lamp test module

The test module is designed for 14 indicator lights.

It is used for:

- Checking LED + lamp displays
- Avoiding undetected faults
- Preventing incorrect diagnosis

Fuse module

The module has been designed for 4 miniature fuses for control circuits. The fuse module can be used for 12 to 24 V (with LED failure indicator) or 110 to 220 V (with neon lamps failure indicator).

ceMos

Electronic contactors

On/off/reverse switching functions for loads and motors

Zero-sequence voltage switch

Short closing/opening times

High switching frequency



400 V AC / 2A
Electronic three phase contactor

Approvals:



400 V AC / 2,5A
Electronic reversing contactor

Approvals:

Dimensions (mm): W x H x D

Description	Type	Part no.	Std. pack	Type	Part no.	Std. pack
Electronic three phase contactor		80.020.6000.0	1			
Electronic reversing contactor					80.020.6003.0	1
DC motor contactor						
Wiring diagrams, derating curve, limit curve	See pages 544-545			See pages 544-545		
Input						
Operating voltage		24 V AC/DC +10%/-15%			24 V DC +10%/-15%	
Nominal input current AC/DC		ca. 44/21 mA			ca. 23 mA	
Nominal input power		ca. 1 VA/0,5 W			ca. 0.6 W	
Voltage range for "OFF"		0...10 V AC/DC			0...10 V DC	
Interlocking of control inputs					yes	
Reversing time (delay) left/right					ca. 100 ms	
Protection circuit of input		Overvoltage protection			Overvoltage protection, polarity reverse protection	
Status display		Green LED			Green LED	
Output						
Nominal switching voltage		400 V AC			400 V AC	
Maximum switching voltage		500 V AC			500 V AC	
Minimum switching voltage		100 V AC			100 V AC	
Peak reverse voltage		1200 Vs			1200 Vs	
Critical rate of rise voltage		500 V/μs			500 V/μs	
Critical on-state voltage		1.1 V			1.1 V	
Maximum current		2 A			2.5 A	
Minimum current		150 mA			150 mA	
Maximum peak current (10 ms)		230 A			230 A	
Typical residual current		6 mA			6 mA	
Power factor cos φ		≥ 0.5			≥ 0.5	
Zero-sequence voltage switch		yes			yes	
I ² t value		265 A ² s			265 A ² s	
Semiconductor fuse		FF			FF	
Maximum motor power		0.75 W			1.1 kW	
Protection circuit of output		RCV-circuit			RCV-circuit	
Maximum pickup delay		10 ms			10 ms	
Maximum dropout delay		10 ms			10 ms	
Maximum switching frequency, resistive		10 Hz			10 Hz	
Maximum switching frequency, inductive		5 Hz			2 kHz	
Isolation voltage between input/output		4 kV _{eff}			4 kV _{eff}	
Ambient temperature		0 °C...+50 °C			0 °C...+50 °C	
Storage temperature		-25 °C...+55 °C			-25 °C...+55 °C	
Type of protection/mounting rail		IP 20 / TS 35			IP 20 / TS 35	
Wire range		20 – 12 AWG			22 – 12 AWG	
finely stranded		0.5 mm ² – 2.5 mm ²			0.5 mm ² – 2.5 mm ²	
single core		0.5 mm ² – 4 mm ²			0.5 mm ² – 4 mm ²	
Location of mounting rail		horizontal			horizontal	
Norms/specifications		VDE 0160			VDE 0160	
Emitted interference		EN 61000			EN 61000	
Interference immunity		EN 61000			EN 61000	

Thermistor overload relay



- with detection of wire breakage
- for onerous start up
- for high duty rating
- for high ambient temperature
- for locked rotors
- for phase failure



Thermistor overload relay with reset

Dimensions (mm): w x H x D
48 x 96 x 60

Description	Type	Part no.	Std. pack
	TMS-101-250V5A	87.110.6253.0	1
Wiring diagram, dimensions	See pages 546		
Input data			
Nominal voltage	230 V AC +6% / -10%, 50-60 Hz		
Power consumption	ca. 2 VA		
Disconnection resistance RA	$3\text{ k}\Omega \leq R_A \leq 4\text{ k}\Omega$		
Reset resistance RE	$1.75\text{ k}\Omega \pm 10\%$		
Maximum number of detectors	6 pieces		
External reset button	1 make contact		
Status display	Red LED		
Output data			
Maximum switching voltage	250 V AC/DC		
Maximum switching current	5 A AC/DC		
Maximum total current (2 simultaneous contacts)	7.5 A AC/DC		
Switching capacity (resistive load)			
at 24 V DC, maximum	120 W		
at 250 V AC, maximum	1250 VA		
Contact arrangements	2 Changeover contacts (SPDT)		
General data			
Ambient temperature	0 °C...+40 °C		
Storage temperature	-25 °C...+55 °C		
Transport temperature	-25 °C...+70 °C		
Wire range	22 - 12 AWG		
finely stranded	0.14 - 2.5 mm ²		
single core	0.14 - 4 mm ²		
Installation on mounting rail	TS 35 or TS 32		

Connection example + function of TMS 101

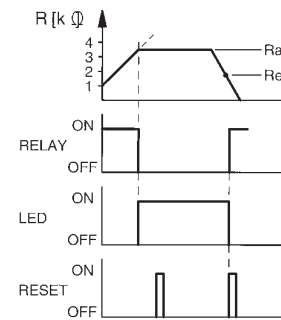

Important note for user:

The relay outputs must be supplied by the same phase (e.g. L1)

Function modules

Lamp test module/fuse module

LPB/SBS

Lamp test module

Checking LED displays
Avoiding undetected faults
Preventing incorrect diagnosis

Fuse module

4 miniature fuses for control circuits
with operation indicator
For restricted spaces



Lamp test module

Approvals:
48 x 96 x 92



Fuse module

Approvals:
48 x 96 x 92

Dimensions (mm): W x H x D

Description	Type	Part no.	Std. pack	Type	Part no.	Std. pack
	LPB-14L-250V1A	87.040.3053.0	1	SBS-4SI-24V6,3A	87.010.7653.0	2
				SBS-4SI-230V6,3A	87.010.7453.0	2
Wiring diagram, dimensions	See pages 547			See pages 547		
Technical data						
Maximum nominal voltage	250 V			250 V		
Diode type	1N4007					
Maximum diode current	1 A					
Diode reverse voltage	1000 V					
Typical voltage in forward direction per diode	0.7 V					
Lamp test at terminal	P					
Lamp connection at terminal	L					
Switching operation at terminal	B					
Number of test lamps (can be bridge via P-P)	2 x 7					
				87.010.7653.0	87.010.7453.0	
Nominal voltage				12-24 V AC/DC	115-230 V AC/DC +6%/-10%	
Maximum nominal current per fuse				6.3 A	6.3 A	
Maximum total current over 4 fuses				18 A	18 A	
Maximum fuse capacity				1.6 W*	1.6 W*	
Maximum fuse capacity over 4 fuses				4.8 W	4.8 W	
Maximum current for disrupted fuse				15 mA	0.5 A	
Number of fuse holders				4	4	
Dimensions of fuse holders				5 x 20 mm	5 x 20 mm	
Touching voltage of fuse holders				IEC 257, DIN 0820	IEC 257, DIN 0820	
Status display				LED 24V (red)	Neon lamp 110 V	
				*Note derating!		
				Fuses not included		
General data						
Ambient temperature	-25 °C...+50 °C			-25 °C...+50 °C		
Storage temperature	-40 °C...+55 °C			-40 °C...+55 °C		
Wire range	22 - 12 AWG			22 - 12 AWG		
finely stranded	0.14 - 2.5 mm ²			0.14 - 2.5 mm ²		
single core	0.14 - 4 mm ²			0.14 - 4 mm ²		
Installation on mounting rail	TS 35 or TS 32			TS 35 or TS 32		

Centralised fault indication



For monitoring control systems
Possible to locate and eliminate faults rapidly



Centralised fault indication relay

Approvals:
48 x 96 x 60



Expansion module for centralised fault indication relay

Approvals:
27 x 96 x 60

Dimensions (mm): W x H x D

Description	Type	Part no.	Std. pack	Type	Part no.	Std. pack
	SSM-7E230V-250V5A	87.030.1053.0	1	SSM-7E230V	87.010.2053.0	1
Wiring diagrams, dimensions	See pages 548			See pages 548		
Input data						
Nominal voltage	230 V AC +6%/-10%, 50-60 Hz					
Input current	approx. 1 mA			approx. 1 mA		
Power consumption	approx. 1 VA					
Fault inputs	terminals, 230 V AC +6%/- 10%			terminals (Kl. 1...7), 230 V AC +6%/-10%		
Series-connected inputs	terminals			terminals		
Output data						
Maximum switching voltage	250 V AC/DC					
Maximum switching current	5 A AC/DC					
Switching capacity (resistive load)						
at 24V DC, maximum	120 W					
at 230V AC, maximum	1250 VA					
Contact arrangement	1 Changeover (SPDT)					
General data						
Ambient temperature	-25 °C...+50 °C			-25 °C...+50 °C		
Storage temperature	-40 °C...+85 °C			-40 °C...+85 °C		
Wire range	22 - 12 AWG			22 - 12 AWG		
finely stranded	0.14 - 2.5 mm ²			0.14 - 2.5 mm ²		
single core	0.14 - 4 mm ²			0.14 - 4 mm ²		
Installation on mounting rail	TS 35 or TS 32			TS 35 or TS 32		
Note				Expansion module for 87.030.1053.0:		
Terminals N and B ₂ must be bridge prior to commissioning				Up to 91 further fault inputs can be connected to the basic module		
Impulses <100ms are not detected						

electronics

Rotation indicator



For monitoring the phase sequence of three-phase inductive motors



Rotation indicator 3 x 400V / 50Hz

Approvals:

Dimensions (mm): W x H x D
48 x 96 x 63

Description	Type	Part no.	Std. pack
	DRA-400V-250V3A	81.010.1000.0	1
Wiring diagram	See pages 551		
Input data			
Nominal voltage	approx 3 x 400 V AC +6%/-10%, 50 Hz		
Power consumption	ca. 2.5 VA		
Dropout voltage	≤ 3 x 100 V AC / 50 Hz		
Pickup delay	< 25 ms		
Dropout delay	< 30 ms		
Switching logic of the relay			
Clockwise	Relay picked up		
Anticlockwise	Relay dropped out		
Output data			
Maximum switching voltage	250 V AC		
Maximum switching current	3 A AC / DC		
Switching capacity (resistive load)			
at 24 V DC, maximum	70 W		
at 250 V AC, maximum	750 VA		
Contact arrangement	2 Changeover contacts (SPDT)		
General data			
Pickup delay	< 25 ms		
Dropout delay	< 30 ms		
Contact material	AgNi		
Endurance			
Mechanical	2 x 10 ⁷ switching operations		
Electrical	1 x 10 ⁶ switching operations at full load		
Test voltage of input/output	2 kV _{eff}		
Ambient temperature	0 °C...+40 °C		
Storage temperature	-40 °C...+85 °C		
Wire range	22 - 12 AWG		
finely stranded	0.5 - 2.5 mm ²		
single core	0.5 - 4 mm ²		
Installation on mounting rail	TS 35 or TS 32		

Function modules



Electronic contactors

Wiring diagrams and Derating curves

Electronic three phase contactor

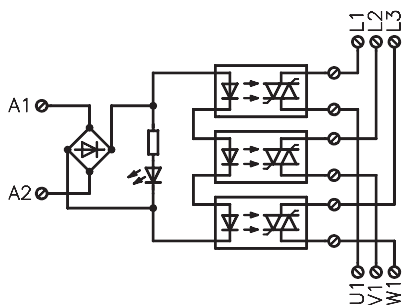

Electronic reversing contactor

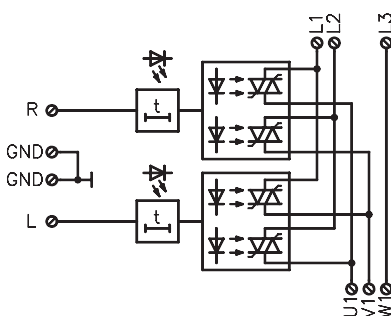

DC motor-reversing contactor

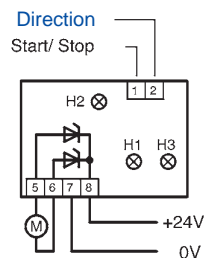

Derating of three phase contactor

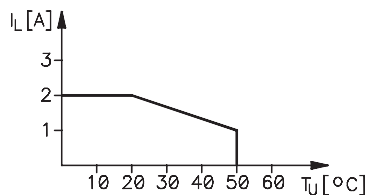

Reversing contactor in static mode

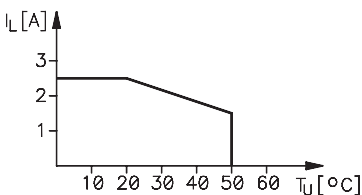

Derating curve:

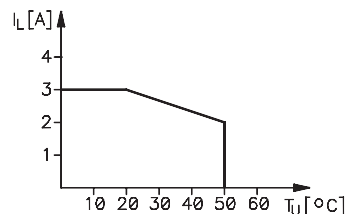

Reversing contactor in dynamic mode

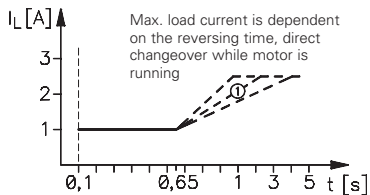

Ⓢ Curve dependent on motor torque

Timing diagram for DC motor-reversing contactor

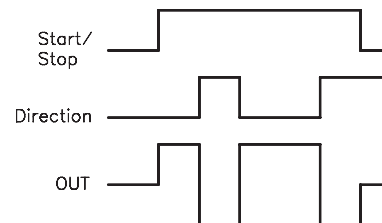

Electronic contactors

Dimensions

Electronic three phase contactor
and Electronic reversing contactor

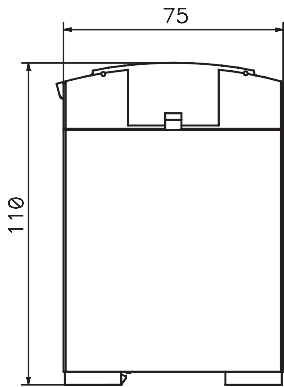

DC motor-reversing contactor

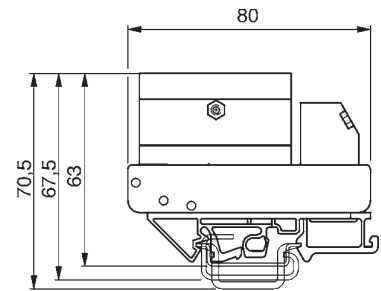

Function modules



Thermistor overload relay TMS 101

Wiring diagram

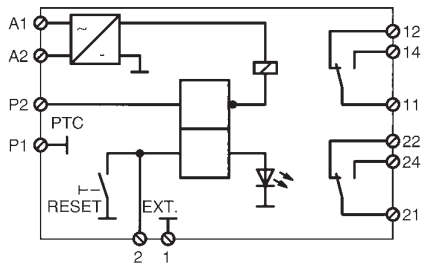

Dimensions

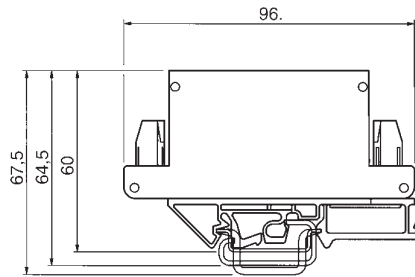

LPB/SBS

Lamp test module + Fuse module

Wiring diagram

Lamp test module

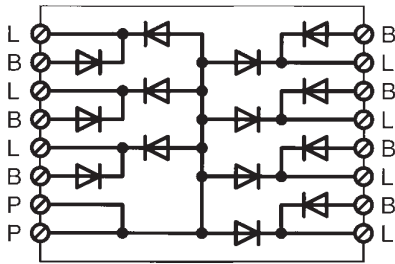

Fuse module

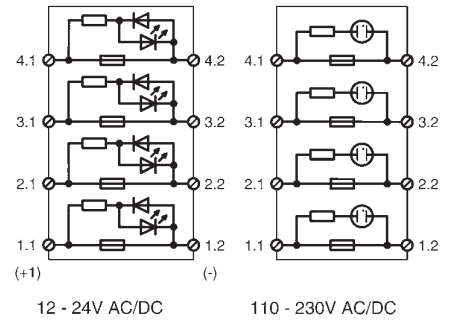

Dimensions

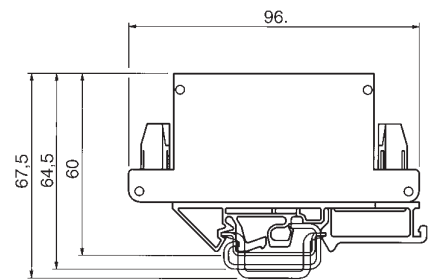
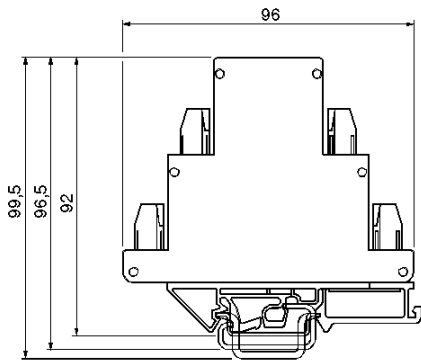

electronics

Function modules



Centralized fault indication and expansion module

Wiring diagram

Centralized fault indication

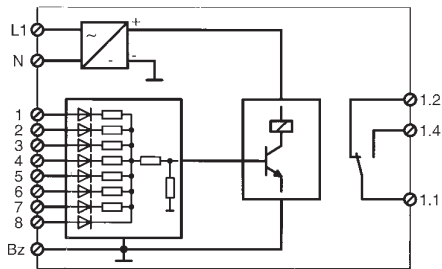

Expansion module to basic module

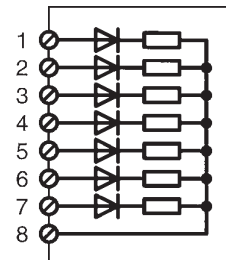

Dimensions

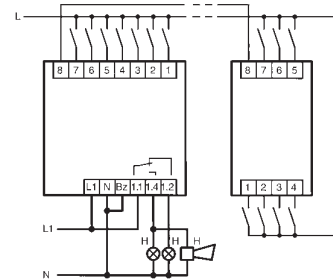
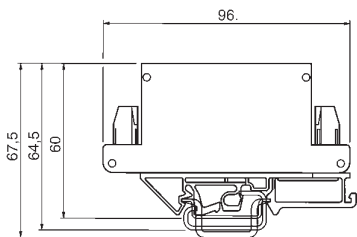

Three-phase system monitoring

Wiring diagram

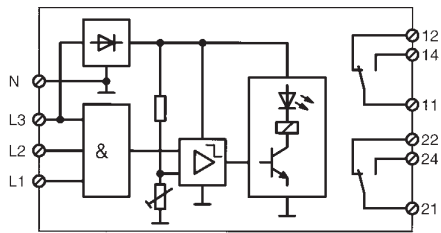

Dimensions

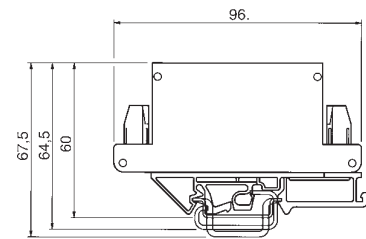

With TS35 mounting foot, the depth is 49,5 mm (including rail)

Connection example: Centralized fault indication with expansion module

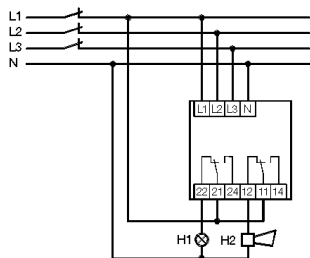

Function modules



Three-phase fuse monitoring

Wiring diagram

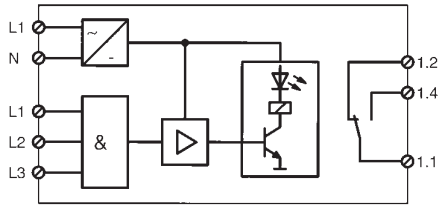

Dimensions

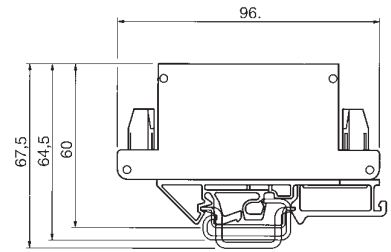

Connection example

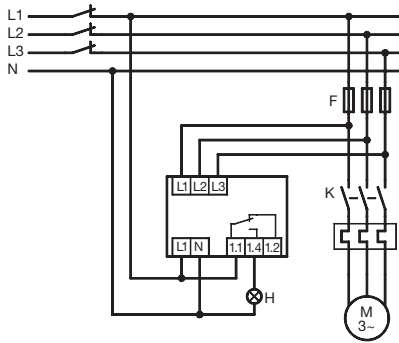



Rotation indicator

Wiring diagram

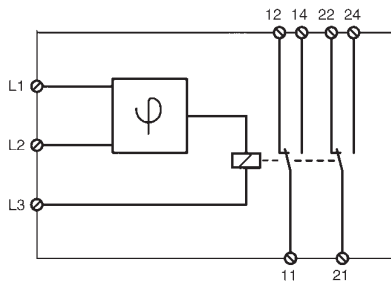

Dimensions

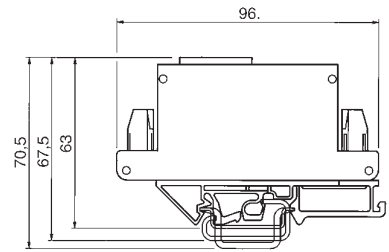

Function modules

Interface converter



Principles of serial interfaces

The increasing use of a variety of automation techniques in all areas of industry requires the processing of an increasing amount of information. The most important transmission media is serial data cables which are used to control complex processes and record process data. Further transmission media are optical fibres and infrared transmission.

A wide variety of serial interfaces are used which are not compatible with each other and frequently do not fulfil the increasing demands as regards to interference immunity, range and speed.

The Wieland SSW product range has tackled this problem and guarantees a noise-free and high-capacity data transmission in hostile industrial conditions.

RS 232 (V.24) interface

One of the most widely used serial interfaces is defined in the American norm EIA-232 and in the international standard CCITT V.24.

The data interface realises data exchange between two data processing devices (point-to-point connection) up to a maximum of 15 m in full duplex mode.

In the simplest configuration, three conductors TxD (sending data), RxD (receiving data) and GND (common signal ground) are required for this connection. The data transmission is controlled by the so-called XON/XOFF protocol (software handshake). If the transmission co-ordination should be controlled via hardware handshake, further control, signal and timing cables are available.

TTY current loop interface

The TTY current loop interface is a very well-known remote transmission interface which has its origins in telegraphy. They can be found nowadays in programmable controllers (PLC), visual display units and printers. A pair of conductors are required for both the sending and receiving of data.

The data transmission is carried out via software handshake in full duplex mode.

A loop current of 20 mA represents the state of logical "1". If the circuit is interrupted, this is evaluated as logical "0". A current-driven source is required in each loop which must either be coupled on the sending or receiving side.

RS-422(V.11) interface

Data communication with intelligent machines requires particularly rapid and high-capacity communication interfaces.

The RS 422 standard fulfils these requirements. It carries out the serial transmission of data in full duplex mode between two devices at a transmission rate up to 10 Mbit/s and a maximum distance of 1000 m.

The interface is operated at minimum with a "Sending" data channel (TxD) and a "Receiving" data channel (RXD). The sending and receiving co-ordination is implemented via software handshake.

The high rate of transmission reliability is achieved by the evaluation of the differential voltage between a twisted core pair. Interference voltages towards the zero potential are not evaluated. The electrical levels of the data cables are defined as

- 0,3 V to -6 V for logical "1" and
- +0,3 V to +6 V for logical "0".

RS-485(2 wire) interface

This serial interface type offers the possibility of multipoint connections of up to 32 devices as well as performance.

The electrical levels and their logical assignment are identical to the RS 422 standard

Limited by the 2-wire technology, the data transmission can however only take place according to half duplex mode i.e. the sending and receiving of data takes place alternately and must be controlled via an appropriate software program. In contrast to pure point-to-point communication, it must be possible to address and identify all the devices of a multipoint connection via an address using a corresponding software protocol. Only one device may send at the same time. All the other devices are meanwhile in listening mode.

The 2-wire bus cable can be up to 500 m long and must be terminated at both ends with an EOL resistor (100-200 ohm). The individual devices can be sent via spur lines up to 5 m from the bus cable.

The maximum transmission rate is 10 Mbit/s when using data cable that is twisted and shielded in pairs.

SSW-V.24 // TTY

The V.24 // interface converters are used to convert an RS 232 interface into a 20 mA current loop interface TTY or vice versa (e.g. between a PC and a PLC).

Due to the low capacity of RS 232 interfaces (15 m), the converters are installed as closely as possible to these interfaces. It is possible to bridge up to 1000 m via a cable that is twisted and shielded in pairs with the insulated and noise-free TTY signal.

SSW-V.24 // RS 422

The V.24 // RS-422-interface converters are used to convert an RS 232 interface into an RS 422 interface or vice versa. With the high-capacity and noise-free RS 422 interface, it is possible to bridge distances up to 1000 m using a cable that is twisted and shielded in pairs.

SSW-V.24 // RS 485

The RS-485-standard is used when more than two devices should communicate with each other. By converting the point-to-point RS 232 interface into the RS 485 standard with bus capability, up to 32 devices can be interconnected via a 2-wire cable.

The V.24 // RS-485-interface converters are used to convert an RS 232 interface into an RS 485 2-wire bus interface with multipoint capability or vice versa.

The interface converters operate independently of the protocol and code i.e. all the bus devices must support the same transmission protocol and the same speed.



Subject to change without further notice

SSW

SSW-V.24//TTY

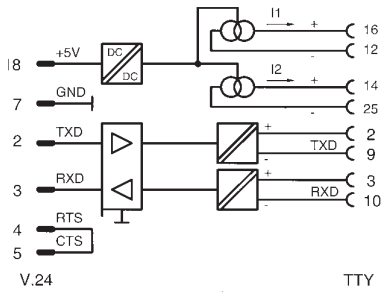

SSW-V.24//RS422

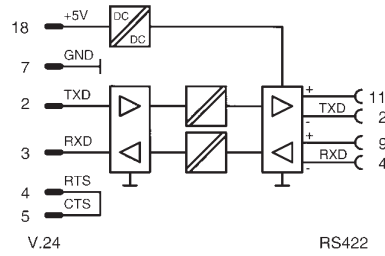

SSW-V.24//RS485

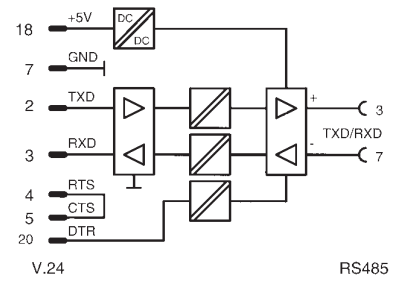

Dimensions

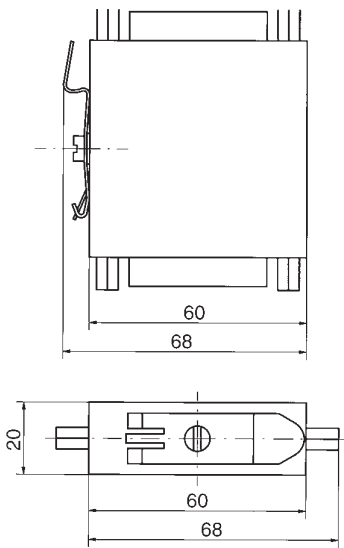

Connection examples

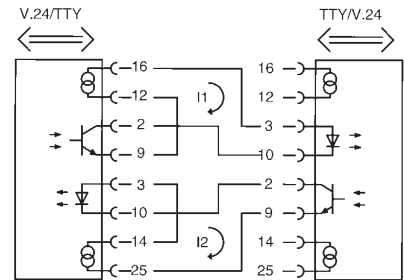

PC ↔ SSW-V.24//TTY ↔ S5-AG

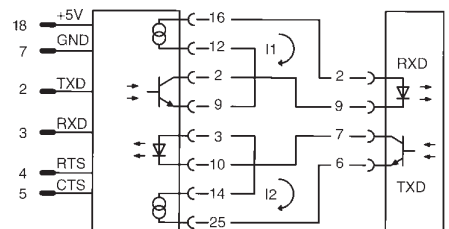

electronics

Interface systems

interface

D-Sub to screw terminal

IDC header to screw terminal

Interface modules and I/O plug systems for Siemens S5

interface offers

- Rapid wiring
- Rapid commissioning
- Clear cabling
- Reduction of wiring errors
- High packing density
- Time and cost savings

CE In general all Wieland components which are obliged to have the CE identification are provided with the CE mark

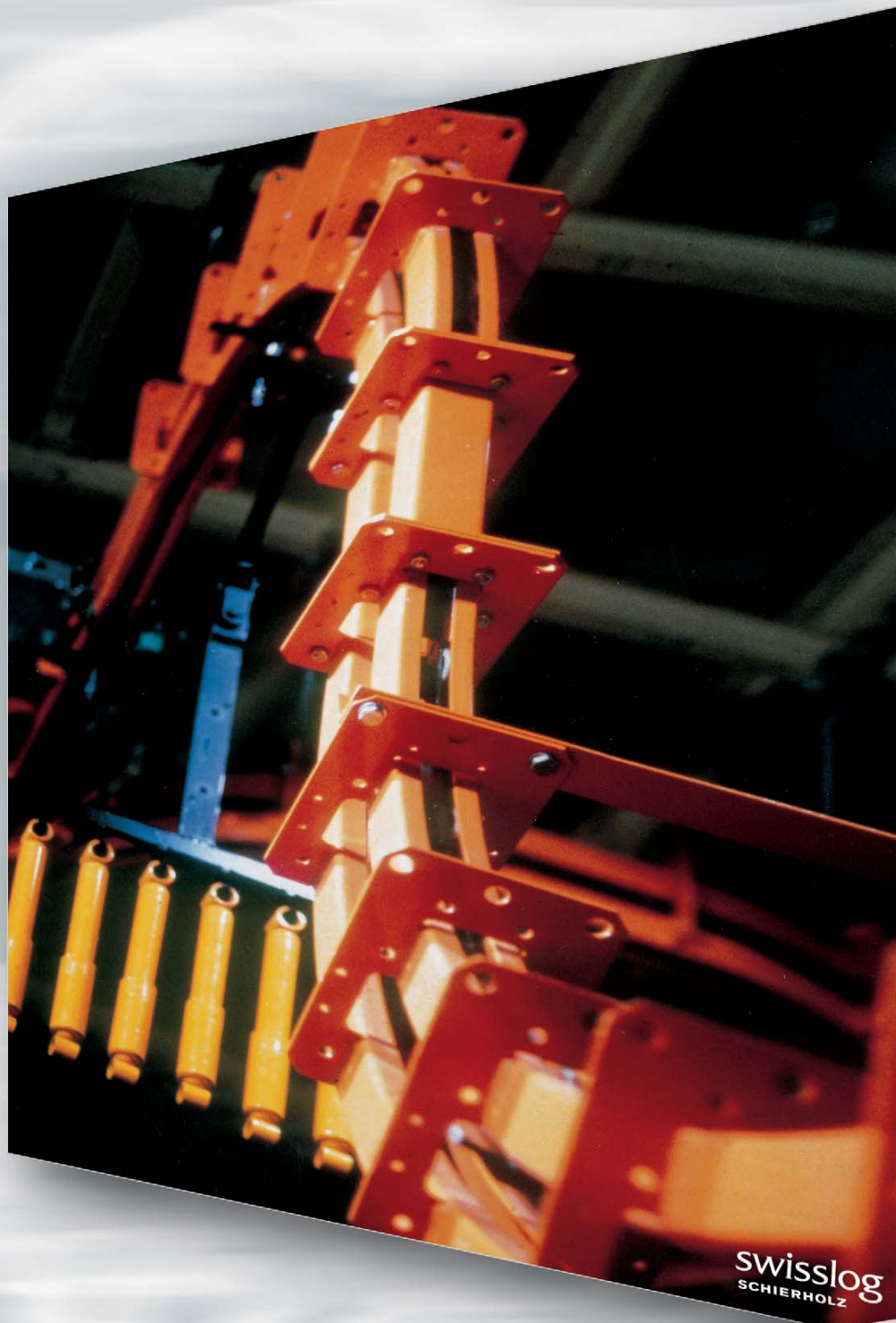

electronics

Electronic components Interface systems

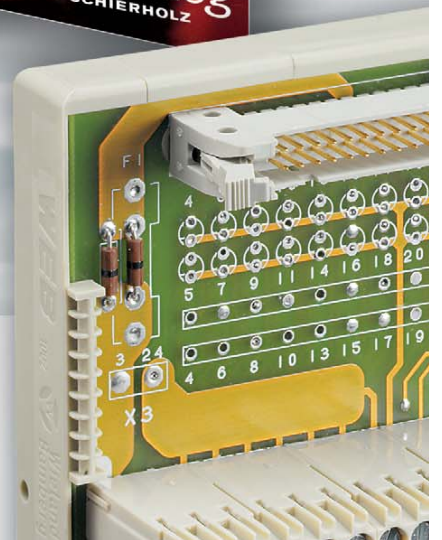

Interface System

passive interfaces

Interface modules

Interface modules make the connection between electronic and electrical components within the control panel.

The control signals from prefabricated plug connections are converted into terminal connections.

The use of Wieland interface modules provides the following benefits for system wiring:

- Simple process which saves time during design and costing
- Rapid wiring, commissioning and fault elimination due to clear cabling and pole designations
- Reduction of wiring errors
- Compact due to high packing density

The interface modules are fitted as standard with a mounting foot for DIN / EN mounting rails TS 35 or TS 32.

Available interface modules:

Subminiature D-SUB connector in accordance with DIN 41652

Subminiature connectors are increasingly used in telecommunications engineering, text and data processing as well as in measuring and control engineering.

The typical trapezoidal metal protective shrouds (galvanised and yellow passivated steel) that are used for this range of connectors guarantee that poles are connected correctly.

The metal shroud is fed onto a terminal to ensure a reliable looping through of the earth.

IDC header in accordance with DIN 41651

The flat ribbon connectors are used more frequently at the interface between the electronics and conventional electrical components.

The use of locking brackets in various lengths stops the socket connector from being separated from the plug connector due to vibration.

Central polarisation prevents any incorrect connections.

Interface modules for S5

These interface modules have been specially designed for the Siemens range of programmable controllers SIMATIC™ S5-115U to 155U. The interface modules take the place of the current I/O connection technology (screw or crimp connection) by implementing the transition from the I/O card to a multipole ribbon connector in accordance with DIN 41651.

Special interface modules are used to connect the sensors and actuators directly to the I/O plug system. An optimum adaptation to the respective PLC module is thereby achieved.

Universal modules for a variety of applications complete this system range.

Overview of interface modules for SIMATIC®

S5-115U

- Digital input/output module for 32 channels
- Input/output plug system, 46 pole front plug
- Universal module for digital and analogue modules with 46 pole front plug connection

S5-135U to 155U

- Digital input/output module for 32 channels
- Input/output plug system, 42 pole front plug
- Universal module for digital and analogue modules with 42 pole front plug connection
- Relay output modules with master and expansion modules
- Initiator module for three-conductor initiators

Flat round cable with/without shielding, 50 pole, prefabricated in various lengths for connecting the front plug to the interface modules.

Further customer-specific interface modules are available on request.

Interface System

passive interfaces

for S5-115U

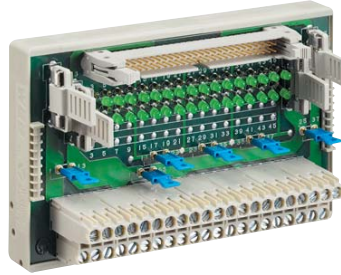

Digital I/O

Dimensions (mm): W x H x D
128.5 x 80 x 61

Approvals:

Description	Type	Part No.	Box Qty
Digital I/O with LED	EAS-UE/D-L-115	87.221.6053.0	1
Digital I/O without LED	EAS-UE/D-115	87.221.5953.0	1
Wiring diagrams, dimensions			
		See page 571	
Technical data			
Nominal voltage with LED	24 V DC		
Nominal voltage without LED	75 V DC / 60 V AC		
Nominal current per LED	5 mA		
Nominal current:			
connections 1, 13, 25, 37 maximum	4 x 2.5 A oder 1 x 10 A		
all remaining connections, maximum	0.5 A		
Ambient temperature	0...+60 °C		
Storage temperature	-40...+70 °C		
Wire range (X8)	22 – 12 AWG		
finely stranded	0.5 – 2.5 mm ²		
single core	0.5 – 4 mm ²		
Installation of mounting rail	TS 35 or TS 32		
Terminal strip X8	Type 8191E		
Accessories			
Suitable 46 pole front plug (115U)		87.221.5853.0	4
Notes for application			
Application (digital I/O with LED)			
Digital output modules	6ES5 441-7LA11	Fa. Siemens	
	6ES5 451-7LA11	Fa. Siemens	
Digital input modules	6ES5 420-7LA11	Fa. Siemens	
	6ES5 430-7LA11	Fa. Siemens	
Application (digital I/O without LED)			
Digital output modules	6ES5 441-7LA11	Fa. Siemens	
	6ES5 451-7LA11	Fa. Siemens	
	6ES5 457-7LA11	Fa. Siemens	
	6ES5 458-7LA11	Fa. Siemens	
	6ES5 482-7LA11	Fa. Siemens	

passive interfaces

for S5-135U to 155U

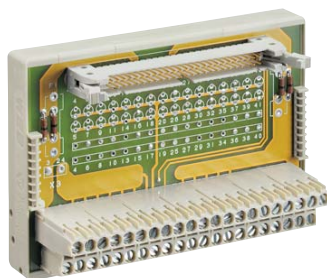

Universal module Profibus DP

Approvals:

Dimensions (mm): W x H x D
115.5 x 80 x 61

Description	Type	Part No..	Box Qty
Universal module	UNIVERSAL-S5	87.222.6353.0	1
Wiring diagrams, dimensions			
See page 572			
Technical data			
Nominal voltage	24 V DC		
Nominal current:			
Screw terminals 3 and 24, maximum	5 A		
all remaining connections, maximum	0,5 A		
Ambient temperature	0...+60 °C		
Storage temperature	-40...+70 °C		
Wire range (X8)	22 – 12 AWG		
finely stranded	0,5 – 2,5 mm ²		
single core	0,5 – 4 mm ²		
Installation of mounting rail	TS 35 or TS 32		
Terminal strip X2	Type 8191E		
Accessories			
Suitable 42 pole front plug (135U/155U)	87.222.5853.0	5	

Interface System

passive interfaces

for S5-115U to 155U

Important note for users:

The relay outputs must be supplied from the same phase (e.g. L1).



Both modules (main module and expansion module) are linked with a flat ribbon cable which is supplied with the expansion module.

Dimensions (mm): W x H x D
250 x 80 x 71

Main module

Expansion module

Description	Type	Part No..	Box Qty	Type	Part No..	Box Qty
	RAB-FS16 W A-S5	87.221.6653.0	1	RSB-FS16 W B-S5	87.221.6753.0	1
Wiring diagrams, dimensions, Limit curve	See page 573			See page 573		
Technical data						
Input data						
Operating voltage	24 V DC +10% / -15%			24 V DC +10% / -15%		
Nominal current per input	25 mA			25 mA		
Nominal capacity	0.6 W			0.6 W		
Status display	Green LED			Green LED		
Output data						
Maximum switching voltage	250 V AC/DC ⁽²⁾			250 V AC/DC ⁽²⁾		
Maximum switching current	8 A AC/DC ⁽²⁾			8 A AC/DC ⁽²⁾		
Maximum continuous current	5 V AC/DC ⁽²⁾			5 V AC/DC ⁽²⁾		
Maximum switching capacity (resistive load)	2000 VA/192W ⁽²⁾			2000 VA/192W ⁽²⁾		
Minimum switching voltage	12 V			12 V		
Minimum switching current	100 mA			100 mA		
General data						
Pickup delay	ca. 8 ms			ca. 8 ms		
Dropout delay	ca. 8 ms			ca. 8 ms		
Contact material	AgCdO			AgCdO		
Electrical endurance (resistive load)						
24 V DC / 2 A	5 x 10 ⁶ Switching cycles			5 x 10 ⁶ Switching cycles		
24 V DC / 5 A	2,5 x 10 ⁶ Switching cycles			2,5 x 10 ⁶ Switching cycles		
220 V AC / 1 A	1 x 10 ⁶ Switching cycles			1 x 10 ⁶ Switching cycles		
220 V AC / 5 A	2,5 x 10 ⁵ Switching cycles			2,5 x 10 ⁵ Switching cycles		
Isolation voltage between input/output	4 kV			4 kV		
Ambient temperature	0 °C...+1) °C			0 °C...+1) °C		
Storage temperature	-40...+70 °C			-40...+70 °C		
Wire range	22 – 12 AWG			22 – 12 AWG		
finely stranded	0.5 – 2.5 mm ²			0.5 – 2.5 mm ²		
single core	0.5 – 4 mm ²			0.5 – 4 mm ²		
Installation of mounting rail	TS 35 and TS 32			TS 35 and TS 32		
Accessories						
Suitable 46 pole front plug (115U)		87.221.5853.0	4		87.221.5853.0	4
Suitable 42 pole front plug (135U/155U)		87.222.5853.0	5		87.222.5853.0	5
Notes for application						
Digital output modules	6ES5 441-7LA11	Fa. Siemens		6ES5 441-7LA11	Fa. Siemens	
	6ES5 451-7LA11	Fa. Siemens		6ES5 451-7LA11	Fa. Siemens	
	6ES5 441-4UA12	Fa. Siemens		6ES5 441-4UA12	Fa. Siemens	
	6ES5 451-4UA12	Fa. Siemens		6ES5 451-4UA12	Fa. Siemens	

Interface System

passive interfaces

D-Sub connector to screw terminal

Wiring diagram

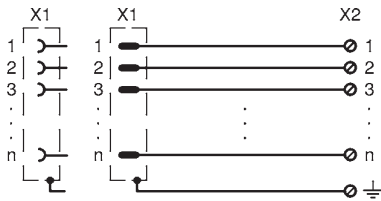

Dimensions

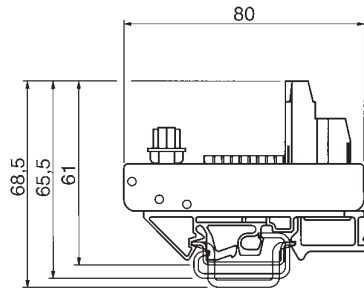

IDC connector to screw terminal

Wiring diagram

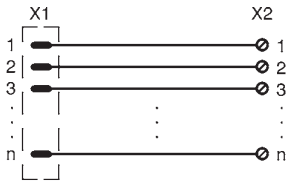

Dimensions

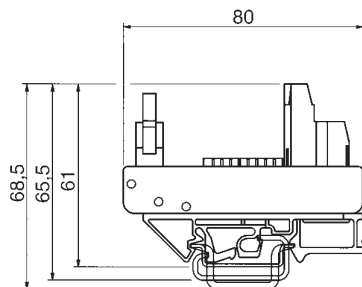

passive interfaces

Interface module for S5-115U Digital I/O

Wiring diagram

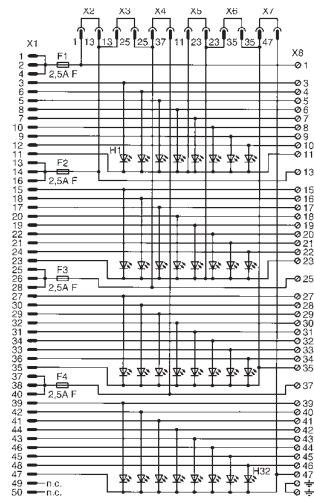

Dimensions

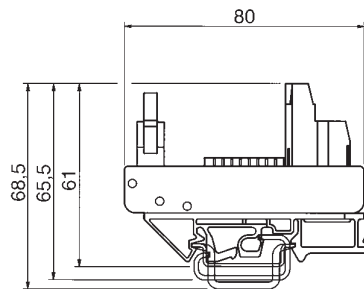

Interface module for S5-115U Universal module

Wiring diagram

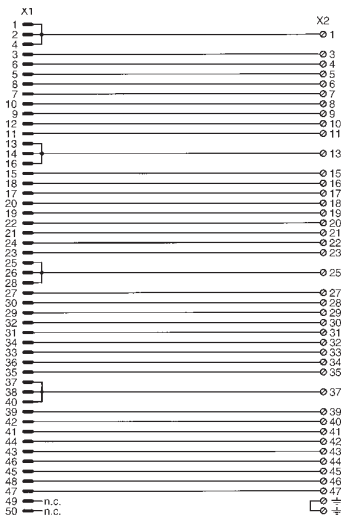

Dimensions

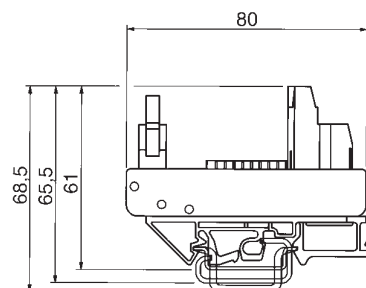

Interface System

passive interfaces

Interface module for S5-135U to 155U Digital I/O

Wiring diagram

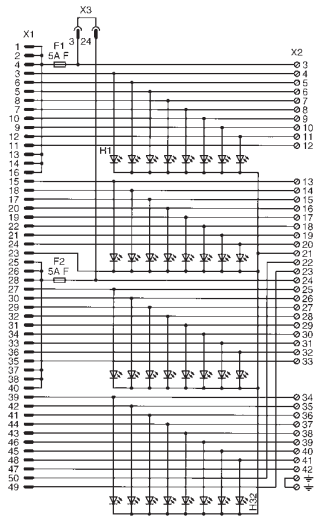

Dimensions

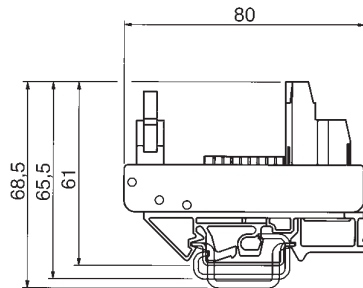

Interface module for S5-135U to 155U Universal module

Wiring diagram

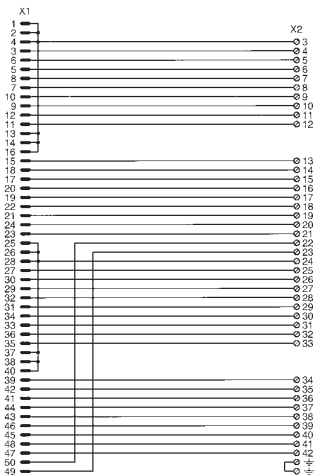

Dimensions

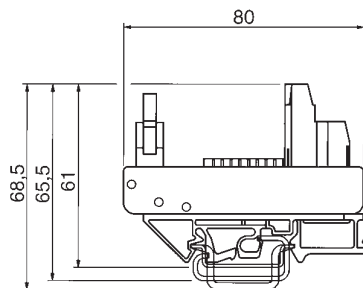

passive interfaces

Wiring diagram

Relay output module for S5-115U to 155U Main module

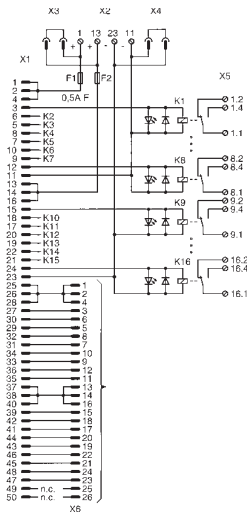

Relay output module for S5-115U to 155U Expansion module

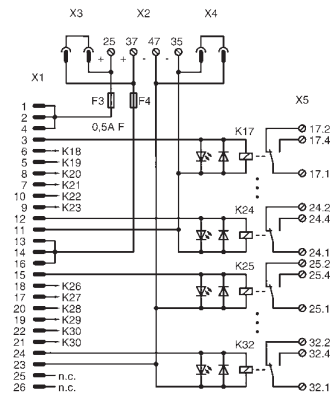

Derating¹⁾

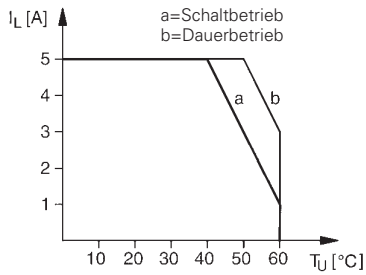

Direct voltage limit curve²⁾

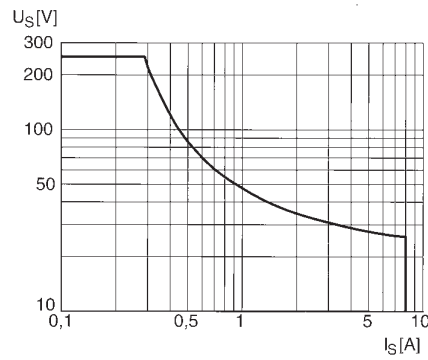

Reduction of the contact rating in function of the $\cos \varphi$

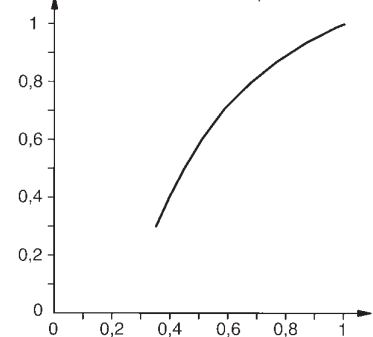

Dimensions

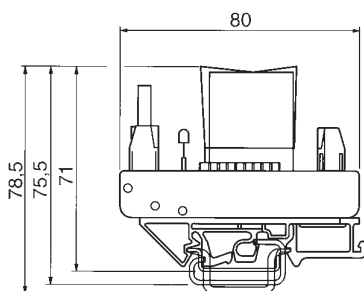

Interface System

interface for S5 for S5

I/O plug system for S5-135U to 155U

S42 pole front plug

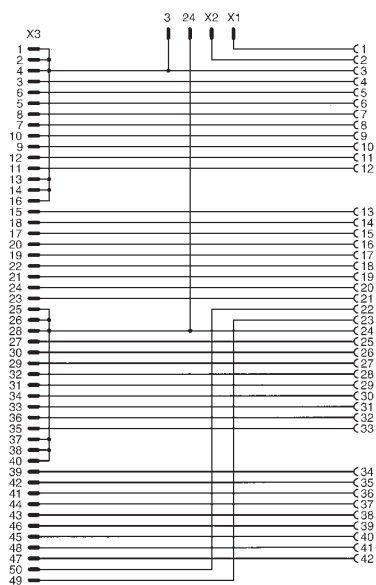

Empty housings

housing system

dipos

WEB

WEB 1001/1002

WEG

wieBOX

Labelling systems

Wieland's empty housings offer:

- Universal application
- Individual modules
- Ranges that can be fitted together
- Complete housing systems
- Connectable housing
- Potentials can be bridged
- Screw or spring-clamp terminal
- Sealable
- Possibility of group labelling

CE In general all Wieland components which are obliged to have the CE identification are provided with the CE mark

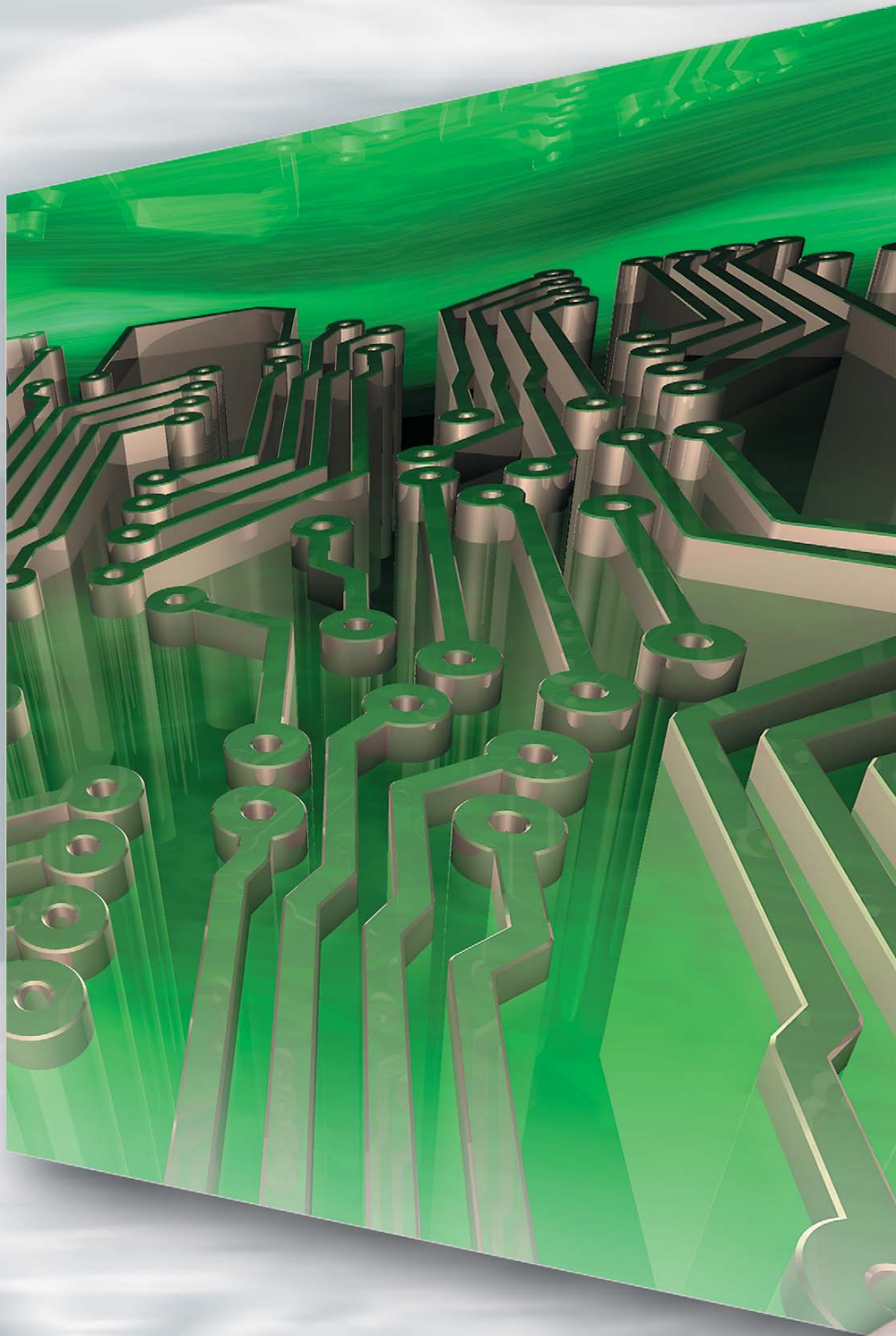

Electronic components

Empty housings



Electronic empty housings

housing system

Empty housing features

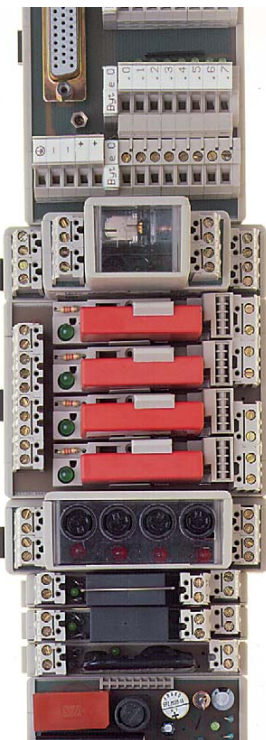

WEB-Range

- installation housings, suitable for a variety of uses
- series of housings can be fitted together
- as individual modules
- or can be fitted together as a complete system
- mounting foot for all common mounting rails TS 35/TS 32
- to house fully equipped PCBs with various connection systems
- Can be used in such areas as:
 - device and control systems for consumer electronics
 - industrial electronics
 - control engineering
 - data systems engineer
 - suitable for universal applications
- design available with/without components fitted (see "Electronic components" for designs with components)
- distribution of electronic components to take up minimum space
- WEB housing provides protection for sensitive components
- Wieland's system solution: Safety and functionality with field tested connection systems + high quality compact designs

- Width of the design:
 - from an overall housing height of 42 mm and PCB size (92,3 x 22,3 mm) up to 68 mixed connections in multi-tier design
- closed design provides protection for the electronic components
- with transparent cover for checking displays etc.
- Marker facility on the housing

WEB 1001 WEB 1002 open housing

- height of this series only 15,8 mm (without U-Foot)
- open modules can be assembled using the 3 different elements to form any length
- complete sets of special components can be fitted
- numerous facilities for connecting external conductors, screw, pluggable, two part and push on terminals
- system advantages:
 - can be assembled quickly due to the plug-in modular system principle
 - high torsional rigidity due to the firm interconnection of the individual elements
 - can be fitted to all DIN EN mounting rails 32/35 using the universal foot

wieBox CN range

- for assembling electronic components
- housing designed with twin shell casing
- in three different designs widths 19 mm, 22,5 mm and 26 mm
- can be fitted with 2 or 3 pole terminals which are provided with a left or right angled soldering pins
- insertion of the 2 pole supply terminals in 19mm housing possible up to a maximum of 8 poles
- 3 pole terminals up to a maximum of 12 poles can be used for the design widths 22,5 mm and 26 mm
- housing can be selected with or without ventilation slots
- mounting foot for TS 35 mounting rail
- with solid or removable front panels:
 - for plugging in or latching in



- its advantages:
 - long service life, even under extreme conditions
 - technical design perfection
 - reliability
 - low costs
 - problem-free application
 - many housing variations

WEB 1001 closed design

- construction of upto 9 housing configurations without tools and using just a few individual parts
- connection system
 - PCB terminals
 - direct and two part pluggable connectors
 - push-on terminals
 - etc.
- PCB can be fitted with components and soldered independently of the housing



housing system

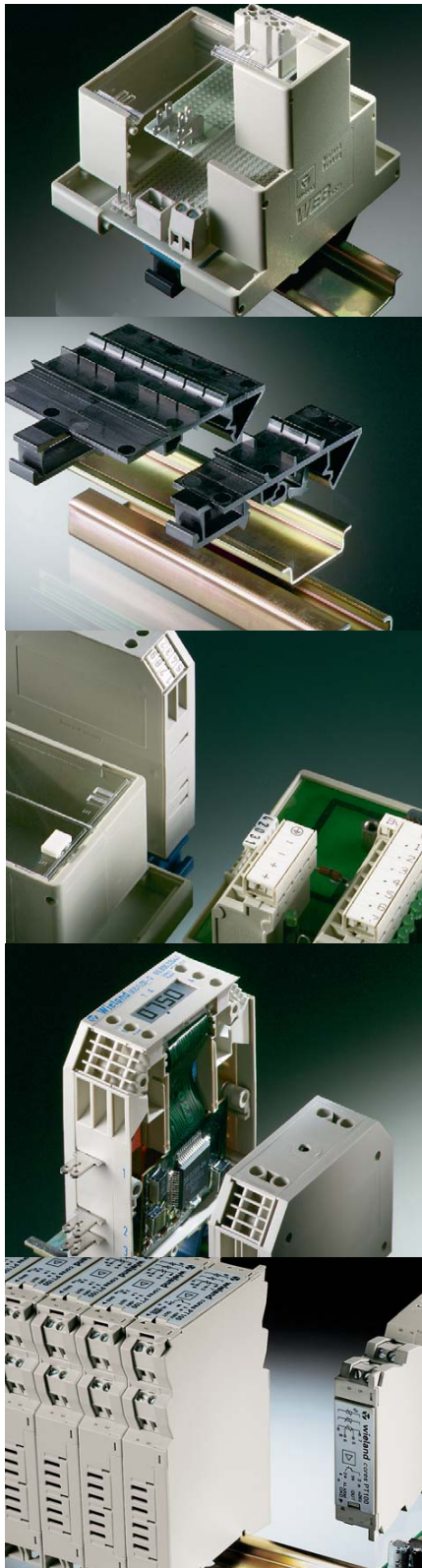

WEB connection system

- independent of the housing component
- up to 68 connections per housing
- no type of connection prescribed therefore screw, puggable, two-part terminals or even mixed systems can be used

Handling

- PCBs can be fitted with components independantly of the housing
- mechanical soldering of the PCB to the terminals and components, also regard less of the housing.
- horizontal (WEB) or vertical (WEG) arrangement of the PCB's on several levels within the housing
- housing components can be fitted together

Attachment to the mounting rail

- by means of a slot mounting facility for one or more mounting feet
- U-foot for TS 32 and TS 35

WEG-Empty housings

- compact housing made from high quality material
- closed housing available in four different sizes
- distribution of electronic components to take up minimum space
- WEG-Empty housings provide protection for sensitive components
- design widths: between 16,5 mm and 28,5 mm
- design height: either 70,5 mm or 98 mm
- modules of various lengths can be mounted side by side using the U-foot which snaps into place on the DIN rail
- space saving arrangement of electronic components both on DIN rail and on G rail (U-foot)
- connection by screw terminal
- supplied:
 - pre-assembled
 - connecting terminal plates supplied
- connection of single core and finely stranded conductors from 0,14 mm² to 6 mm², stranded conductors from 0,14 mm² to 4 mm²

Labelling systems

- clip-in terminal and housing markers
- multi digit marker tags
- single tag, marker strips

- marker branch

- individual labelling possible using figures or symbols

WEB closed housing

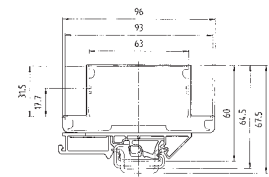

WEB closed housing

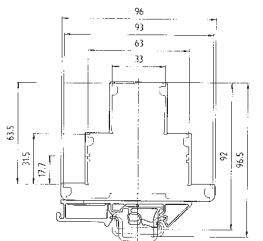

WEB open housing



WEB open housing

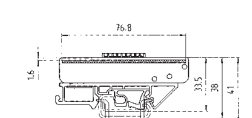

WEG

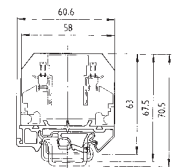

WEG

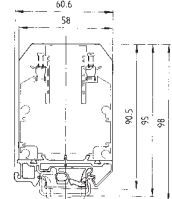

wieBOX

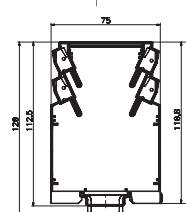

Electronic empty housings

dipos



Typical applications

- relay modules
- timer relay modules
- optocoupler (solid state) modules
- compact power supply units
- converter for standard analogue signals
- signal conditioning for RTD's and thermocouples
- programmable signal conditioning
- potential monitors
- overvoltage protection
- low cost I/O system
- fieldbus interfacing

Possible applications and markets

- mechanical and system engineering
- electrical/electronics industry, device manufacturer
- chemical industry and process automation
- power engineering and power stations
- building technology, heating, ventilation and air conditioning technology (HVAC)
- car industry, aircraft, ships
- consumer goods
- foodstuffs
- utilities
- monitoring of environmental pollutions
- traffic control

dipos

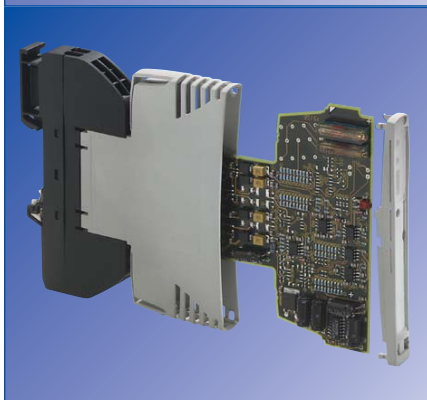
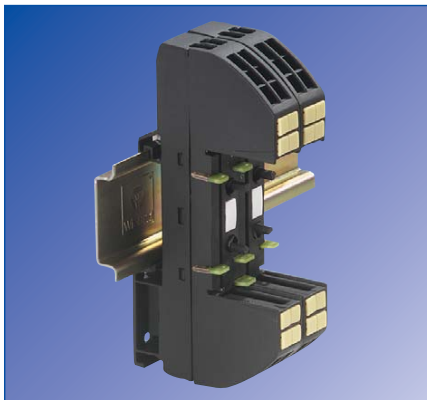

Properties of the housing

- variety of housings for industrial process and building automation
- connectable housing consisting of module boards and modular top sections
- housing can be extended in the future in 5 mm intervals
- 4 (at an overall width of 12.5 mm) or 6 (at an overall width of 17.5 mm) potentials can be bridged between modules
- 8 connections in an overall width of 12.5 mm
- type of connection can be freely selected: screw or spring-clamp terminal
- integral connection
- labelling not covered by wiring
- each connection can be marked with its own marker tag
- coloured marker tags available
- group labelling in the base and on cover of housing
- Locking cover – to prevent unwanted changes
- ventilation slots
- PCB is terminal free
- module board for TS 32 and TS 35 mounting rails

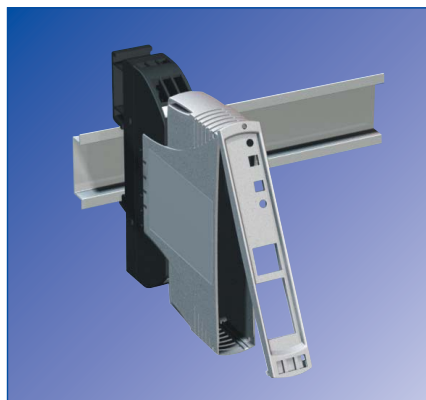

Electronic empty housing

Modular housing system

dipos

Housing properties:

- connectable housing
- various design widths
- potential bridging between housings
- at least 8 connections
- connection type: screw or spring clamp



Dimensions (mm): W x H x D

Approvals: , CSA in preparation
12.5 x 100 x 100 (Standard)

Approvals: , CSA in preparation
17.5 x 100 x 100 (Standard)

Description	Type	Part No.	Box Qty	Type	Part No.	Box Qty
Module board dipos UMC						
with screw terminals (screw thread M3)		80.060.0000.1			80.060.1000.1	
with spring clamp		80.060.0001.1			80.060.1001.1	
Empty housings		80.061.0010.3			80.061.1010.3	
Dimensions of housing and module board	See page 600			See page 600		
Technical data						
Rated voltage	Type	Part No.	Box Qty	Type	Part No.	Box Qty
	230/400 V AC			230/400 V AC		
Maximum rated current	10 A per contact			10 A pro kontakt		
Total current	10 A			10 A		
Overvoltage category	III			III		
Degree of pollution	2			2		
Connections per side	4 Klemmen, 4 Potenziale pro Seite			6 Klemmen, 6 Potenziale pro Seite		
Wire range of screw terminals						
finely stranded/stranded	0.2 mm ² – 2.5 mm ²			0.2 mm ² – 2.5 mm ²		
single core	0.2 mm ² – 4 mm ²			0.2 mm ² – 4 mm ²		
flexible with AE with/without plastic sleeve	0.25 mm ² – 2.5 mm ² / 0.25 mm ² – 1.5 mm ²			0.25 mm ² – 2.5 mm ² / 0.25 mm ² – 1.5 mm ²		
AWG	24 – 12			24 – 12		
Tightening torque	0.5 – 0,6 Nm			0.5 – 0,6 Nm		
Wire range of spring-clamp terminal	0.08 mm ² – 2.5 mm ²			0.08 mm ² – 2.5 mm ²		
with AE	0.08 mm ² – 1.5 mm ²			0.08 mm ² – 1.5 mm ²		
AWG	28 – 12			28 – 12		
Maximum number of bridge to flanking unit	4			6		
Fire protection	V2			V2		
Type of protection	IP 20			IP 20		
Ambient temperature	-25 °C...+100 °C			-25 °C...+100 °C		
Storage temperature	-40 °C...+100 °C			-40 °C...+100 °C		
Regulations, norms	EN 60947-1			EN 60947-1		
	DIN EN 50178			DIN EN 50178		
	DIN VDE 0611 T1			DIN VDE 0611 T1		
	VDE 0110			VDE 0110		
	VDE 106			VDE 106		
Accessories						
Coding branch		Z5.563.0453.0	25		Z5.563.0453.0	25
Plug-in jumper		Z8.000.0229.5	50		Z8.000.0229.5	50
Large marker tag, white, blank		04.249.4053.0	500		04.249.4053.0	500
Small marker tag						
unmarked, red		04.249.1053.0	500		04.249.1053.0	500
unmarked, blue		04.249.1553.0	500		04.249.1553.0	500
unmarked, white		04.249.2053.0	500		04.249.2053.0	500

dipos

Housing properties:

- connectable housing
- various design widths
- potential bridging between housings
- at least 8 connections
- connection type: screw or spring clamp



Approvals: , CSA in preparation
22.5 x 100 x 100 (Standard)

Dimensions (mm): W x H x D

Description	Type	Part No.	Box Qty
Module board dipos UMC			
with screw terminals (screw thread M3)		80.060.2000.1	
with spring clamp		80.060.2001.1	
Empty housings		80.061.2010.3	
Dimensions of housing and module board	See page 600		
Technical data			
	Type	Part No.	Box Qty
Rated voltage	230/400 V AC		
Maximum rated current	10 A per contact		
Total current	10 A		
Overvoltage category	III		
Degree of pollution	2		
Connections per side	8 Klemmen, 6 Potenziale pro Seite		
Wire range of screw terminals			
finely stranded/stranded	0.2 mm ² – 2.5 mm ²		
single core	0.2 mm ² – 4 mm ²		
flexible with AE with/without plastic sleeve	0.25 mm ² – 2.5 mm ² / 0.25 mm ² – 1.5 mm ²		
AWG	24 – 12		
Tightening torque	0.5 – 0.6 Nm		
Wire range of spring-clamp terminal	0.08 mm ² – 2.5 mm ²		
with AE	0.08 mm ² – 1.5 mm ²		
AWG	28 – 12		
Maximum number of bridge to flanking unit	6		
Fire protection	V2		
Type of protection	IP 20		
Ambient temperature	–25 °C...+100 °C		
Storage temperature	–40 °C...+100 °C		
Regulations, norms	EN 60947-1		
	DIN EN 50178		
	DIN VDE 0611 T1		
	VDE 0110		
	VDE 106		
Accessories			
Coding branch		Z5.563.0453.0	25
Plug-in jumper		Z8.000.0229.5	50
Large marker tag, white, blank		04.249.4053.0	500
Small marker tag			
unmarked, red		04.249.1053.0	500
unmarked, blue		04.249.1553.0	500
unmarked, white		04.249.2053.0	500

Possible areas of application:

- devices and controllers for consumer electronics
- industrial electronics
- control technology
- data technology

Material:

Housing: PA 6 UL 94-HB
 Foot: PA 66 UL 94-V2
 Cover: PC UL 94-HB



Size 3

93 x 42 x 96 / for PCB 93 x 45

Size 4

70.5 x 74 x 96 / for PCB 93/63 x 45

Dimensions (mm): W x H x D / for PCB

Description	Part No.	Box Qty	Part No.	Box Qty
Empty housings, complete with U-Foot, without PCB	87.030.0053.0	10	87.040.0053.0	10
Empty housings, complete with Foot TS 35, without PCB	86.030.0053.0	10	86.040.0053.0	10
(The empty housings are supplied unassembled and without PCBs)				
Housing dimensions	See page 601		See page 601	
Individual parts				
1. Housing	2 x	01.001.5153.0 50	2 x	01.001.5053.0
2. Cover with marking facility	2 x	04.312.0654.0 50	2 x	04.312.0554.0 50
Cover without marking facility	1 x	04.312.3054.0 10	1 x	04.312.3354.0 50
3. Cover plate				
4. Universal foot		05.583.0053.0 50		05.583.0053.0 50
Foot TS 35		Z5.595.2153.0 50		Z5.595.2153.0 50
Connection technique				
PCB terminals with 5 mm pitch	Type 8180, 8181, 8182, 8190, 8191, 8192, 8113, 8142		Type 8180, 8181, 8182, 8190, 8191, 8192, 8113, 8142	
PCB terminals with 5.08 mm pitch	Type 8213, 8281, 8291, 8292		Type 8213, 8281, 8291, 8292	
PCB terminals with 7.5 mm pitch	Type 8313, 8390, 8391		Type 8313, 8390, 8391	
PCB terminals with 7.62 mm pitch	Type 8413, 8491		Type 8413, 8491	
PCB terminals with 3.5 mm pitch	Type 8543, 8593		Type 8543, 8593	
PCB terminals with 3.81 mm pitch	Type 8813, 8893		Type 8813, 8893	
Accessories				
Flat connector	6.3 mm, straight	05.555.8521.0 50	6.3 mm, straight	05.555.8521.0 50
Flat connector	6.3 mm, angled	05.555.8721.0 50	6.3 mm, angled	05.555.8721.0 50
Flat connector	2 x 2.8 mm, straight	05.555.9121.0 50	2 x 2.8 mm, straight	05.555.9121.0 50
Flat connector	2 x 2.8 mm, angled	05.555.8921.0 50	2 x 2.8 mm, angled	05.555.8921.0 50
Flat connector	2.8 mm, straight	05.555.8621.0 50	2.8 mm, straight	05.555.8621.0 50
Flat connector	2.8 mm, angled	05.555.8821.0 50	2.8 mm, angled	05.555.8821.0 50
Flat connector: Materials	Ms tin plated		Ms tin plated	
Mounting rail: diameter	1.3 -1.4 mm		1.3 -1.4 mm	
Mounting rail: spacing	5 mm		5 mm	
Mounting rail 35, DIN rail 7.5 high	L = 2 m	35 x 27 x 7,5 EN 60715 98.300.0000.0 1	35 x 27 x 7,5 EN 60715 98.300.0000.0 1	
Mounting rail 35, DIN rail 15 high	L = 2 m	35 x 24 x 15 EN 60715 98.360.0000.0 1	35 x 24 x 15 EN 60715 98.360.0000.0 1	
Mounting rail 32, G-rail	L = 2 m	9006 EN 60715 G-32 98.190.0000.0 1	9006 EN 60715 G-32 98.190.0000.0 1	
End clamp, Polyamide	8 mm wide TS 35	9708/2 S 35 Z5.522.8553.0 100	9708/2 S 35 Z5.522.8553.0 100	
End clamp, Polyamide	10 mm wide U-Foot	WE 1/U Z5.523.5753.0 100	WE 1/U Z5.523.5753.0 100	
Marker tag holder		9003 C/4 04.242.1050.0 200	9003 C/4 04.242.1050.0 200	
Marker tag, unmarked		9003 C 04.241.0651.0 500	9003 C 04.241.0651.0 500	
Marker tag, marked		9003 CB 04.841.0651.0 500	9003 CB 04.841.0651.0 500	
See pages 582-585 for further labelling systems				

Possible areas of application:

- Devices and controllers for consumers electronics
- industrial electronics
- control technology
- data technology

Material:

Housing: PA 6 UL 94-HB
 Foot: PA 66 UL 94-V2
 Cover: PC UL 94-HB



Size 8

Dimensions (mm): W x H x D / for PCB

93 x 42 x 96 / for PCB 93 x 89,6

Size 9

93 x 74 x 96 / for PCB 93/63 x 89,6

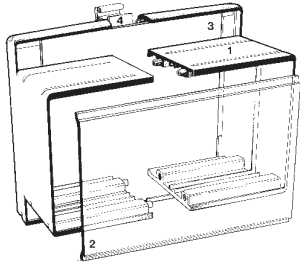
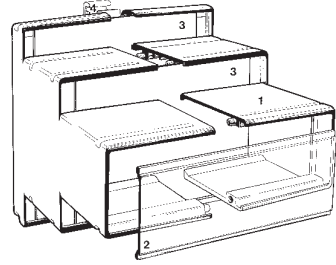
Description	Part No.	Box Qty	Part No.	Box Qty
Empty housings, complete with U-Foot, without PCB	87.080.0053.0	10	87.090.0053.0	10
(The empty housings are supplied unassembled and without PCBs)				
Housing dimensions	See page 601		See page 601	
Individual parts				
1. Housing	01.001.5453.0	50	01.001.5353.0	10
Housing	01.001.5453.0	50	01.001.5353.0	10
2. Cover	04.312.3254.0	50	04.312.3554.0	50
3. Universal foot	05.583.0153.0	50	05.583.0153.0	50
Connection technique				
PCB terminals with 5 mm pitch	Type 8180, 8181, 8182, 8190, 8191, 8192, 8113, 8142		Type 8180, 8181, 8182, 8190, 8191, 8192, 8113, 8142	
PCB terminals with 5.08 mm pitch	Type 8213, 8281, 8291, 8292		Type 8213, 8281, 8291, 8292	
PCB terminals with 7.5 mm pitch	Type 8313, 8390, 8391		Type 8313, 8390, 8391	
PCB terminals with 7.62 mm pitch	Type 8413, 8491		Type 8413, 8491	
PCB terminals with 3.5 mm pitch	Type 8543, 8593		Type 8543, 8593	
PCB terminals with 3.81 mm pitch	Type 8813, 8893		Type 8813, 8893	
Technical data				
Materials	Ms tin plated		Ms tin plated	
Mounting rail: diameter	1.3 – 1.4 mm		1.3 – 1.4 mm	
Mounting rail: spacing	5 mm		5 mm	
Accessories				
Flat connector	6.3 mm, straight	05.555.8521.0 50	6.3 mm, straight	05.555.8521.0 50
Flat connector	6.3 mm, angled	05.555.8721.0 50	6.3 mm, angled	05.555.8721.0 50
Flat connector	2 x 2.8 mm, straight	05.555.9121.0 50	2 x 2.8 mm, straight	05.555.9121.0 50
Flat connector	2 x 2.8 mm, angled	05.555.8921.0 50	2 x 2.8 mm, angled	05.555.8921.0 50
Flat connector	2.8 mm, straight	05.555.8621.0 50	2.8 mm, straight	05.555.8621.0 50
Flat connector	2.8 mm, angled	05.555.8821.0 50	2.8 mm, angled	05.555.8821.0 50
Mounting rail 35, DIN rail 7.5 high L = 2 m	35 x 27 x 7.5 EN 60715	98.300.0000.0 1	35 x 27 x 7.5 EN 60715	98.300.0000.0 1
Mounting rail 35, DIN rail 15 high L = 2 m	35 x 24 x 15 EN 60715	98.360.0000.0 1	35 x 24 x 15 EN 60715	98.360.0000.0 1
Mounting rail 32, G rail L = 2 m	9006 EN 60715 G-32	98.190.0000.0 1	9006 EN 60715 G-32	98.190.0000.0 1
End clamp, Polyamide 8 mm wide TS 35	9708/2 S 35	Z5.522.8553.0 100	9708/2 S 35	Z5.522.8553.0 100
End clamp, Polyamide 10 mm wide U-Foot	WE 1/U	Z5.523.5753.0 100	WE 1/U	Z5.523.5753.0 100
Marker tag holder	9003 C/4	04.242.1050.0 200	9003 C/4	04.242.1050.0 200
Marker tag, unmarked	9003 C	04.241.0651.0 500	9003 C	04.241.0651.0 500
Marker tag, marked	9003 CB	04.841.0651.0 500	9003 CB	04.841.0651.0 500
See pages 582–585 for further labelling systems				

Electronic empty housings

WEB 1002

System benefits

- can be assembled to any length
- possible to have complete custom-made design
- can be assembled together quickly due to the plug-in modular principle
- high torsional rigidity due to the firm interconnection of the individual elements
- can be latched onto all DIN EN mounting rail 32/35 using the universal foot

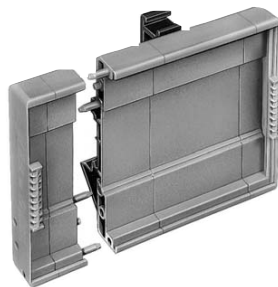

Material:

Housing: PA 6 GU30 UL 94-HB

Foot: PA 66 UL 94-V2

WEB 1002

Dimensions (mm): W x H x D

Variable x 80 x 33.5

Individual parts				Type	Part No.	Box Qty
1. End cover with label holder				Width 12.8 mm	01.001.6493.0	50
2. Middle section of housing				Width 12.8 mm	01.001.6553.0	50
3. Middle section of housing				Width 22.5 mm	01.001.6653.0	50
4. Middle section of housing				Width 44.8 mm	01.001.6753.0	50
5. Universal foot				Width 23 mm	05.584.8853.0	50
5. Universal foot (overall width from 70.4 mm)				Width 68 mm	05.584.8953.0	50
Accessories						
Mounting rail 35, DIN rail 7.5 mm high	L = 2 m	35 x 27 x 7.5 EN 60715	98.300.0000.0	1		
Mounting rail 35, DIN rail 15 mm high	L = 2 m	35 x 24 x 15 EN 60715	98.360.0000.0	1		
Mounting rail 32, G-rail	L = 2 m	9006 EN 60715 G-32	98.190.0000.0	1		
PCB (not included)				see drawing for dimensions		
End clamp, Polyamide	8 mm wide TS 35	9708/2 S 35	Z5.522.8553.0	100		
End clamp, Polyamide	10 mm wide U-Foot	WE 1/U	Z5.523.5753.0	100		
Marker tag, unmarked				9003 C	04.242.0850.0	500
Marker tag, marked				9003 CB	04.842.0850.0	500
See pages 582–585 for further labelling systems						

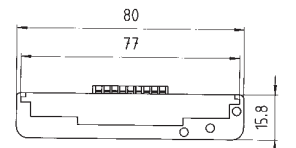
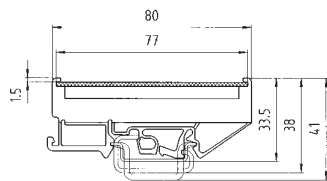

Width 12.8 mm 01.001.6493.0 50

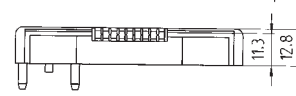

Width 12.8 mm 01.001.6553.0 50

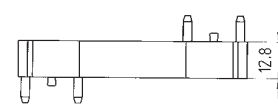

Width 22.5 mm 01.001.6653.0 50

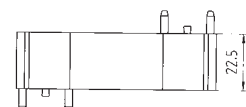

Width 44.8 mm 01.001.6753.0 50

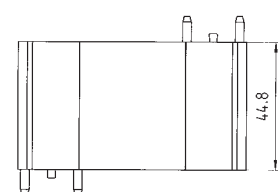

01.001.6493.0 50

Universal foot

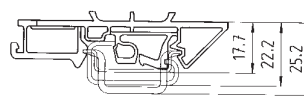

Width 23 mm 05.584.8853.0 50
Width 68 mm 05.584.8953.0 50
(overall width from 70.4 mm)

Electronic empty housings



System benefits

- closed housing available in four different sizes
- parallel connection of the modules in various lengths possible via the latchable U-foot
- compact housing made from high quality material
- UL 94-V-0 polyamide 66/6



No. 22–10 AWG/600 V
No. 20–10 AWG
UL
20 x 60.6 x 63



No. 22–10 AWG/600 V
No. 20–10 AWG
UL
16.5 x 60.6 x 90.5

UL-Data

CSA-Data

Approvals

Dimensions (mm): W x H x D

Description	Part No.	Box Qty	
Empty housing, complete with U-Foot, without PCB	57.801.0053.0	10	57.801.5053.0 10
Housing dimensions, PCB dimensions	See page 602		See page 602
Technical data			
Rated cross-section	4 mm ²		4 mm ²
Wire range single core	0.14–6 mm ² (EN 60 947-7-1 / DIN VDE 0611 T1)		0.14–6 mm ² (EN 60 947-7-1 / DIN VDE 0611 T1)
Wire range finely stranded	0.14–4 mm ² (EN 60 947-7-1 / DIN VDE 0611 T1)		0.14–4 mm ² (EN 60 947-7-1 / DIN VDE 0611 T1)
Rated voltage	400 V/4 kV/3		400 V/4 kV/3
Rated current	max. 10 A		max. 10 A
Type of protection	IP 20		IP 20
Insulation strip length	7 mm		7 mm
Regulations, norms	DIN VDE 0611 Part 1 (11.77) EN 60947-7-1: 1991/DIN VDE 0611 T1/08.92		DIN VDE 0611 Part 1 (11.77) EN 60947-7-1: 1991/DIN VDE 0611 T1/08.92
Accessories			
Mounting rail 35, DIN rail 7.5 mm high L = 2 m	35 x 27 x 7,5 EN 60715	98.300.0000.0 1	35 x 27 x 7,5 EN 60715 98.300.0000.0 1
Mounting rail 35, DIN rail 15 mm high L = 2 m	35 x 24 x 15 EN 60715	98.360.0000.0 1	35 x 24 x 15 EN 60715 98.360.0000.0 1
Mounting rail 32, G-rail L = 2 m	9006 EN 60715 G-32	98.190.0000.0 1	9006 EN 60715 G-32 98.190.0000.0 1
PCB (see drawing for dimensions) (hole grid)		Z8.000.0123.1 10	
End clamp, Polyamide 8 mm wide TS 35	9708/2 S 35	Z5.522.8553.0 100	9708/2 S 35 Z5.522.8553.0 100
End clamp, Polyamide 10 mm wide U-Foot	WE 1/U	Z5.523.5753.0 100	WE 1/U Z5.523.5753.0 100
Marker tag, unmarked	9003 C	04.242.0651.0 500	9003 C 04.241.0651.0 500
Marker tag, marked	9003 CB	04.842.0651.0 500	9003 CB 04.841.0651.0 500
See pages 582–585 for further labelling systems			

WEG

System benefits

- closed housing available in four different sizes
- parallel connection of the modules in various lengths possible via the latchable U-foot
- Compact housing made from high quality material
- UL 94-V-0 polyamide 66/6



No. 22-10 AWG/600 V
No. 20-10 AWG
UL
22.5 x 60.6 x 90.5



No. 28.5-10 AWG/600 V
No. 20-10 AWG
UL
28.5 x 60.6 x 90.5

UL-Data
CSA-Data
Approvals
Dimensions (mm): W x H x D

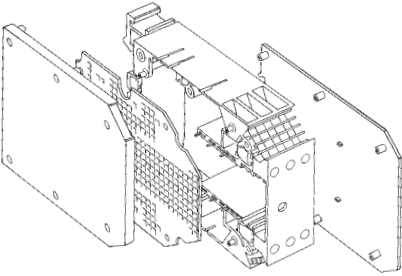
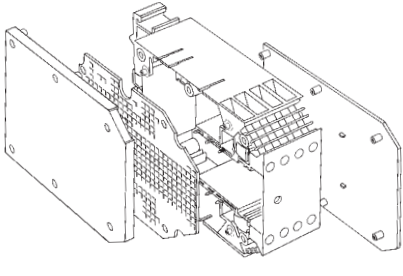
Description	Part No.	Box Qty	Part No.	Box Qty
Empty housings, complete with U-Foot, without PCB	57.801.5153.0	10	57.801.5253.0	10
				
Housing dimensions, PCB dimensions	See page 602		See page 602	
Technical data				
Rated cross-section	4 mm ²		4 mm ²	
Wire range single core	0.14–6 mm ² (EN 60 947-7-1 / DIN VDE 0611 T1)		0.14–6 mm ² (EN 60 947-7-1 / DIN VDE 0611 T1)	
Wire range finely stranded	0.14–4 mm ² (EN 60 947-7-1 / DIN VDE 0611 T1)		0.14–4 mm ² (EN 60 947-7-1 / DIN VDE 0611 T1)	
Rated voltage	400 V/4 kV/3		400 V/4 kV/3	
Rated current	max. 10 A		max. 10 A	
Type of protection	IP 20		IP 20	
Insulation strip length	7 mm		7 mm	
Regulations, norms	DIN VDE 0611 Part 1 (11.77) EN 60947-7-1: 1991/DIN VDE 0611 T1/08.92		DIN VDE 0611 Part 1 (11.77) EN 60947-7-1: 1991/DIN VDE 0611 T1/08.92	
Accessories				
Mounting rail 35, DIN rail 7.5 mm high L = 2 m	35 x 27 x 7,5 EN 60715	98.300.0000.0 1	35 x 27 x 7,5 EN 60715	98.300.0000.0 1
Mounting rail 35, DIN rail 15 mm high L = 2 m	35 x 24 x 15 EN 60715	98.360.0000.0 1	35 x 24 x 15 EN 60715	98.360.0000.0 1
Mounting rail 32, G-rail L = 2 m	9006 EN 60715 G-32	98.190.0000.0 1	9006 EN 60715 G-32	98.190.0000.0 1
End clamp, Polyamide 8 mm wide TS 35	9708/2 S 35	Z5.522.8553.0 100	9708/2 S 35	Z5.522.8553.0 100
End clamp, Polyamide 10 mm wide U-Foot	WE 1/U	Z5.523.5753.0 100	WE 1/U	Z5.523.5753.0 100
Marker tag, unmarked	9003 C	04.241.0651.0 500	9003 C	04.241.0651.0 500
Marker tag, marked	9003 CB	04.841.0651.0 500	9003 CB	04.841.0651.0 500
See pages 582–585 for further labelling systems				

Electronic empty housings

wieBox

System benefits

- housing design in twin shell technology
- housing with or without ventilation slots
- installation of the 2 pole supply terminal in the 19mm housing
- 8 poles possible
- solid or removable front panels



UL-Data

CSA-Data

Approvals

Overall width (mm): W x H x D

No. 22-12 AWG 300 V UG: B, D 20 A/30 A

No. 22-12 AWG 300 V Gr. B 25 A

UL, CSA

width 19 x 75 x 110,8

No. 22-12 AWG 300 V UG: B, D 20 A/30 A

No. 22-12 AWG 300 V Gr. B 25 A

UL, CSA

width 22.5 x 75 x 110,8

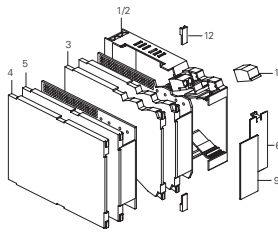
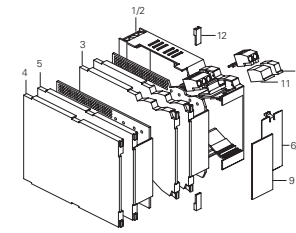
Individual parts	Type	Part No.	Box Qty	Type	Part No.	Box Qty
Housing base, general with contour, without PCB						
1. Housing base, with mounting foot, with ventilation slots	wieBox CN 19 GKL	Z1.296.3453.0	25	wieBox CN 22 GKL	Z1.296.3853.0	25
2. Housing base, with mounting foot, without ventilation slots	wieBox CN 19 GK	Z1.296.3553.0	25	wieBox CN 22 GK	Z1.296.3953.0	25
3. Lid, without integral front panel, with contour	wieBox CN DK	07.416.5153.0	25	wieBox CN DK	07.416.5153.0	25
4. Lid, without integral front panel, without contour	wieBox CN DU	07.416.5253.0	25	wieBox CN DU	07.416.5253.0	25
5. Lid, with integral front panel, without contour	wieBox CN 19 DK	07.416.5353.0	25	wieBox CN 22 DK	07.416.5653.0	25
6. Lid, without integral front panel, without contour	wieBox CN 19 DU	07.416.5453.0	25	wieBox CN 22 DU	07.416.5753.0	25
7. Front panel, transparent	wieBox CN 19 FKG	07.416.4856.0	50	wieBox CN 22 FKG	07.416.4956.0	50
8. Front panel, gray	wieBox CN 19 FK	07.416.4853.0	50	wieBox CN 22 FK	07.416.4953.0	50
						
Housing dimensions, PCB dimensions	See page 603			See page 603		
Technical data						
Rated cross-section	2.5 mm ²			2.5 mm ²		
Wire range single core/finely stranded	0.14 – 4 mm ² /0.14 – 2.5 mm ²			0.14 – 4 mm ² / 0.14 – 2.5 mm ²		
Insulation strip length	6.5 mm			6.5 mm		
Rated voltage: 5mm pitch	250 V/4 kV/3 – overvoltage category III			250 V/4 kV/3 – overvoltage category III		
(in accordance with VDE 0110/01.89)	690 V/4 kV/2 – overvoltage category II (max. 600 V for non-earthed systems or expected ≤4 kV)			690 V/4 kV/2 – overvoltage category II (max. 600 V for systems or expected ≤ 4 kV)		
	1000 V/4 kV/1 – overvoltage category I			1000 V/4 kV/1 – overvoltage category I		
Rated current	16 A			16 A		
Regulations, norms	DIN EN 50178 (VDE 0160), DIN EN 699-1 (VDE 0609 T.1)			DIN EN 50178 (VDE 0160), DIN EN 699-1 (VDE 0609 T.1)		
Housing material: Complete housing	PA 66/6 gray, similar to RAL 7032			PA 66/6 gray, similar to RAL 7032		
Front panel, transparent	PC 940 A			PC 940 A		
Mounting foot	PA 66/6 black			PA 66/6 black		
Flammability	UL94-V0			UL94-V0		
Type of protection	IP 40			IP 40		
Material of PCB terminal: Terminal screw	Galvanised steel			Galvanised steel		
Insulation component	PA 66/6 gray, similar to RAL 7032, UL94-V0			PA 66/6 gray, similar to RAL 7032, UL94-V0		
Clamping parts	Brass with nickel plating			Brass with nickel plating		
Contact bridge with soldering parts	Tin plated copper			Tin plated copper		
Soldering pin/bore hole	0.9 x 0.9 mm / Ø 1.3 mm			0.9 x 0.9 mm / Ø 1.3 mm		
Accessories						
9. Snap-in plate, gray	wieBox CN 19 EP	07.416.4553.0	50	wieBox CN 22 EP	07.416.4653.0	50
10. Blanking plate, 1 pole	wieBox CN BL 1	05.561.9553.0	100	wieBox CN BL 1	05.561.9553.0	100
11. Blanking plate, 2 pole	wieBox CN BL 2	05.561.9653.0	100	wieBox CN BL 2	05.561.9653.0	100
12. Marker tag	wieBox CN BZ	04.244.1853.0	100	wieBox CN BZ	04.244.1853.0	100
PCB terminal, right	8191/2- pole WVR OB	25.161.2553.0	100	8191/3- pole WVR OB	25.161.2653.0	100
PCB terminal, left	8191/2- pole WV L OB	25.161.2853.0	100	8191/3- pole WV L OB	25.161.2953.0	100
Mounting rail 35, DIN rail 7,5 mm high L = 2 m	35 x 27 x 7.5 EN 60715	98.300.0000.0	1	35 x 27 x 7.5 EN 60715	98.300.0000.0	1
Mounting rail 35, DIN rail 15 mm high L = 2 m	9708/2 S 35	Z5.522.8553.0	100	9708/2 S 35	Z5.522.8553.0	100
End clamp, Polyamide, for TS 35 8 mm wide	WE 1/U	Z5.523.5753.0	100	WE 1/U	Z5.523.5753.0	100
End clamp, Polyamide, for U-Foot 10 mm wide						
See pages 582-583 for further labelling systems						

wieBox



System benefits

- housing design in twin shell technology
- housing with or without ventilation slots
- installation of the 2 pole supply terminal in the 19mm housing
- 8 poles possible
- with front plates for insertion or latching into position

No. 22-12 AWG 300 V UG: B, D 20 A/30 A

No. 22-12 AWG 300 V Gr. B 25 A

UL, CSA

width 26 x 75 x 110.8

Approvals:

Overall width (mm) : B x H x T

Description	Type	Part No.	Box Qty
Housing base, general with contour, without PCB			
1. Housing base, with mounting foot, with ventilation slots	wieBox CN 26 GKL	Z1.296.4253.0	25
2. Housing base, with mounting foot, without ventilation slots	wieBox CN 26 GK	Z1.296.4353.0	25
3. Lid, without integral front panel, with contour	wieBox CN DK	07.416.5153.0	25
4. Lid, without integral front panel, without contour	wieBox CN DU	07.416.5253.0	25
5. Lid, with integral front panel, without contour	wieBox CN 26 DK	07.416.5853.0	25
6. Lid, without integral front panel, without contour	wieBox CN 26 DU	07.416.5953.0	25
7. Front panel, transparent	wieBox CN 26 FKG	07.416.5056.0	50
8. Front panel, gray	wieBox CN 26 FK	07.416.5053.0	50
Housing dimensions, PCB dimensions	See page 589		
Technical data			
Rated cross-section	2,5 mm ²		
Wire range single core/finely stranded	0,14 – 4 mm ² /0,14 – 2,5 mm ²		
Insulation strip length	6,5 mm		
Rated voltage: 5mm pitch	250 V/4 kV/3 – overvoltage category III		
(in accordance with VDE 0110/01.89)	690 V/4 kV/2 – overvoltage category II (max. 600V for for non-earthed systems or expected ≤ 4 kV)		
	1000 V/4 kV/1 – overvoltage category I		
Rated current	16 A		
Regulations, norms	DIN EN 50178 (VDE 0160), DIN EN 699-1 (VDE 0609 T.1)		
Housing material: Complete housing	PA 6.6 gray, similar to RAL 7032		
Front panel, transparent	PC 940 A		
Mounting foot	PA 6.6 black		
Flammability	UL94-V0		
Type of protection	IP 40		
Material of PCB terminal: Terminal screw	Galvanised steel		
Insulation component	PA 6.6 gray, similar to RAL 7032, UL94-V0		
Clamping parts	Brass with nickel plating		
Contact bridge with soldering parts	Tin plated copper		
Soldering pin/bore hole	0,9 x 0,9 mm/Ø 1,3 mm		
Accessories	Type	Part No.	Box Qty
9. Snap-in plate, gray	wieBox CN 26 EP	07.416.4753.0	50
10. Blanking plate, 1 pole	wieBox CN BL 1	05.561.9553.0	100
11. Blanking plate, 2 pole	wieBox CN BL 2	05.561.9653.0	100
12. Marker tag	wieBox CN BZ	04.244.1853.0	100
PCB terminal, right	8191/3- pole WVR OB	25.161.2653.0	100
PCB terminal, left	8191/3- pole WWL OB	25.161.2953.0	100
Mounting rail 35, DIN rail 7,5 mm high L = 2m	35 x 27 x 7,5 EN 60715	98.300.0000.0	1
Mounting rail 35, DIN rail 15 mm high L = 2m	35 x 24 x 15 EN 60715	98.360.0000.0	1
End clamp, Polyamide, for TS 35 8 mm wide	9708/2 S 35	Z5.522.8553.0	100
End clamp, Polyamide, for U-Foot 10 mm wide	WE 1/U	Z5.523.5753.0	100
See pages 582–585 for further labelling systems			

Electronic empty housings Marking material **Labelling System** System

Terminal markings, snap-in
Housing markings, snap-in
Marker tags with multiple digits
Individual marker, marker strips, marker branch
Individual labelling possible (numbers, symbols)





Description	Type	Part No.	Box Qty	Type	Part No.	Box Qty
Individual marker, without inscription	3 digit, 9705 A	04.242.0850.0	500	8 digit, 9705 AL	04.242.1553.0	500
Individual marker, with inscription (specify marking required in addition to part number)	3 digit, 9705 AB	04.842.0850.0	500	8 digit, 9705 ALB	04.842.1553.0	500
Marker strips with 5mm pitch:						
Marker strips, unmarked	9705 A/5/10	04.242.5053.0	25			
Marker strips, unmarked, with enlarged text area	9705 AL/5/10	04.242.5153.0	25			
Marker strips, marked (specify marker required in addition to Part no.)	9705 A/5/10 B	04.842.5053.0	25			
Marker strips, marked (marking for strips: 1...9)	9705 A/5/9 B	04.842.4953.0	25			
Note:						
Pack unit = 25 strips = 250 tags						
Marker strips with 10 mm pitch:						
Marker strips, marked (as above, but only every other tag is printed)	9705 A/5/10/5 B	04.842.5553.0	25			
Note:						
Pack unit = 25 strips = 250 tags						
Marker tag holder						
for WEB-Empty housings		04.242.1050.0	200			
Technical data						
Materials	Polyamide 66/6					
Colour	Black numbers on white background					

Electronic empty housings Marking branch with 10 marker tags **Labelling System**

System

Snap-in terminal and housing markings
Marker tags with multiple digits
Individual marker, marker strips, marker branch
Individual labelling possible (numbers, symbols)

Materials:
Polyamide 66/6 white, black printing

Unmarked		Type	Part No.	Box Qty
		9704 A	04.241.1150.0	25
with row of same numbers	marked, per branch			
	1 1 1 1 1 1 1 1 1 1	9704 A/1 B	04.841.1150.0	25
	2 2 2 2 2 2 2 2 2 2	9704 A/2 B	04.841.1250.0	25
	3 3 3 3 3 3 3 3 3 3	9704 A/3 B	04.841.1350.0	25
	4 4 4 4 4 4 4 4 4 4	9704 A/4 B	04.841.1450.0	25
	5 5 5 5 5 5 5 5 5 5	9704 A/5 B	04.841.1550.0	25
	6 6 6 6 6 6 6 6 6 6	9704 A/6 B	04.841.1650.0	25
	7 7 7 7 7 7 7 7 7 7	9704 A/7 B	04.841.1750.0	25
	8 8 8 8 8 8 8 8 8 8	9704 A/8 B	04.841.1850.0	25
	9 9 9 9 9 9 9 9 9 9	9704 A/9 B	04.841.1950.0	25
	0 0 0 0 0 0 0 0 0 0	9704 A/0 B	04.841.2050.0	25
1 set of same numbers = 10 x 25 branches = 2500 numbers				
with numbers in sequence	marked, per branch			
	1 2 3 4 5 6 7 8 9 0	9704 A/1-0 B	04.841.2150.0	25
with row of same letters in upper case	marked, per branch			
	A A A A A A A A A A	9704 A/AG B	04.841.2250.0	25
	B B B B B B B B B B	9704 A/BG B	04.841.2350.0	25
	C C C C C C C C C C	9704 A/CG B	04.841.2450.0	25
	D D D D D D D D D D	9704 A/DG B	04.841.2550.0	25
	E E E E E E E E E E	9704 A/EG B	04.841.2650.0	25
	F F F F F F F F F F	9704 A/FG B	04.841.2750.0	25
	G G G G G G G G G G	9704 A/GG B	04.841.2850.0	25
	H H H H H H H H H H	9704 A/HG B	04.841.2950.0	25
	I I I I I I I I I I	9704 A/IG B	04.841.3050.0	25
	J J J J J J J J J J	9704 A/JG B	04.841.3150.0	25
	K K K K K K K K K K	9704 A/KG B	04.841.3250.0	25
	L L L L L L L L L L	9704 A/LG B	04.841.3350.0	25
	M M M M M M M M M M	9704 A/MG B	04.841.3450.0	25
	N N N N N N N N N N	9704 A/NG B	04.841.3550.0	25
	O O O O O O O O O O	9704 A/OG B	04.841.3650.0	25
	P P P P P P P P P P	9704 A/PG B	04.841.3750.0	25
	Q Q Q Q Q Q Q Q Q Q	9704 A/QG B	04.841.3850.0	25
	R R R R R R R R R R	9704 A/RG B	04.841.3950.0	25
	S S S S S S S S S S	9704 A/SG B	04.841.4050.0	25
	T T T T T T T T T T	9704 A/TG B	04.841.4150.0	25
	U U U U U U U U U U	9704 A/UG B	04.841.4250.0	25
	V V V V V V V V V V	9704 A/VG B	04.841.4350.0	25
	W W W W W W W W W W	9704 A/WG B	04.841.4450.0	25
	X X X X X X X X X X	9704 A/XG B	04.841.4550.0	25
	Y Y Y Y Y Y Y Y Y Y	9704 A/YG B	04.841.4650.0	25
1 set of upper case letters = 26 x 25 branches = 6500 letters	Z Z Z Z Z Z Z Z Z Z	9704 A/ZG B	04.841.4750.0	2

Labelling System

Snap-in terminal and housing markings
 Marker tags with multiple digits
 Individual marker, marker strips, marker branch
 Individual labelling possible (numbers, symbols)

		Type	Part No.	Box Qty
with row of same symbols	marked, per branch			
	+ + + + + + + + + +	9704 A/+B	04.841.7450.0	25
	- - - - - - - - - -	9704 A/-B	04.841.7550.0	25
	/ / / / / / / / / /	9704 A//B	04.841.7650.0	25
	9704 A/.B	04.841.750.0	25
1 set of same symbols = 10 x 25 branches = 2500 characters				
with row of same letters in lower case	marked, per branch			
	a a a a a a a a a a	9704 A/AK B	04.841.4850.0	25
	b b b b b b b b b b	9704 A/BK B	04.841.4950.0	25
	c c c c c c c c c c	9704 A/CK B	04.841.5050.0	25
	d d d d d d d d d d	9704 A/DK B	04.841.5150.0	25
	e e e e e e e e e e	9704 A/EK B	04.841.5250.0	25
	f f f f f f f f f f	9704 A/FK B	04.841.5350.0	25
	g g g g g g g g g g	9704 A/GK B	04.841.5450.0	25
	h h h h h h h h h h	9704 A/HK B	04.841.5550.0	25
	i i i i i i i i i i	9704 A/IK B	04.841.5650.0	25
	j j j j j j j j j j	9704 A/JK B	04.841.6750.0	25
	k k k k k k k k k k	9704 A/KK B	04.841.6850.0	25
	l l l l l l l l l l	9704 A/LK B	04.841.6950.0	25
	m m m m m m m m m m	9704 A/MK B	04.841.6050.0	25
	n n n n n n n n n n	9704 A/NK B	04.841.6150.0	25
	o o o o o o o o o o	9704 A/OK B	04.841.6250.0	25
	p p p p p p p p p p	9704 A/PK B	04.841.6350.0	25
	q q q q q q q q q q	9704 A/QK B	04.841.6450.0	25
	r r r r r r r r r r	9704 A/RK B	04.841.6550.0	25
	s s s s s s s s s s	9704 A/SK B	04.841.6650.0	25
	t t t t t t t t t t	9704 A/TK B	04.841.6750.0	25
	u u u u u u u u u u	9704 A/UK B	04.841.6850.0	25
	v v v v v v v v v v	9704 A/VK B	04.841.6950.0	25
	w w w w w w w w w w	9704 A/WK B	04.841.7050.0	25
	x x x x x x x x x x	9704 A/XK B	04.841.7150.0	25
	y y y y y y y y y y	9704 A/YK B	04.841.7250.0	25
	z z z z z z z z z z	9704 A/ZK B	04.841.7350.0	25
1 set of lower case letters = 26 x 25 branches = 6500 letters				



electronics

Subject to change without further notice

Electronic empty housings



Plan view

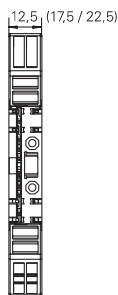

Housing

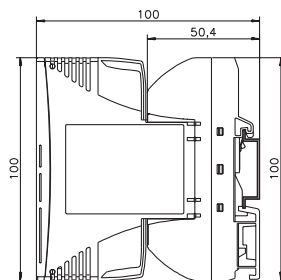

Module board

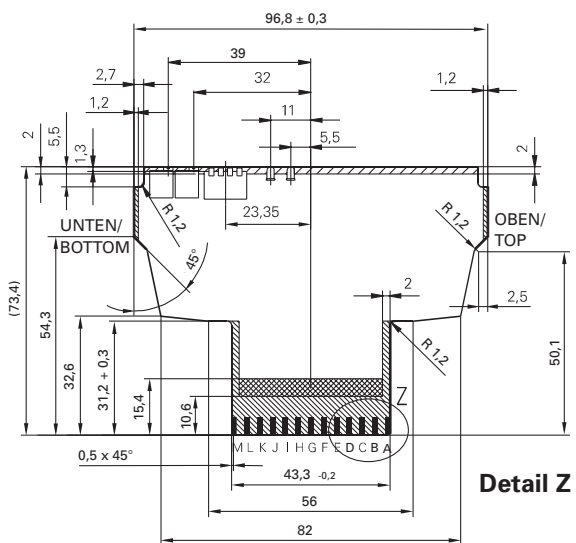
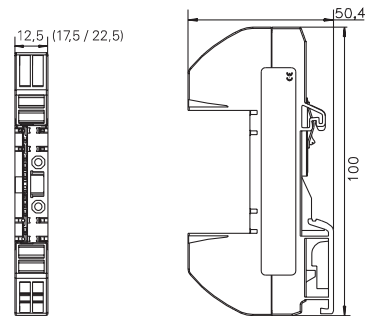

Detail Z

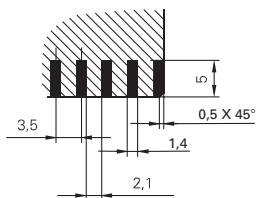

Version (mm width)	12.5	17.5	22.5
Component height	7.15	10.35	15.35
Endurance	2.35	4.15	4.15
Max.component height	6.25	8.7	13.7
Max.endurance	1.4	2.7	2.7
Max.component height	1.05	0.95	5.95
Blocking zones			

Note: Contact is made on both sides of the terminal faces. Components that generate heat should always be placed in the vicinity of the ventilation slots (upper section of the PCB)

PCB: FR4

Thickness: 1.0 mm

Copper support: $\geq 35 \mu\text{m}$ ($I \leq 3 \text{ A}$)

$\geq 70 \mu\text{m}$ ($I > 3 \text{ A}$)



Dimensions for WEB empty housing for sizes 1, 3, 6 and 8 with foot TS 35

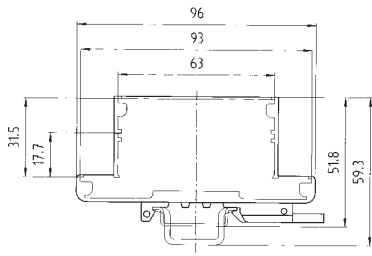

Dimensions for WEB empty housing for sizes 1, 3, 6 and 8 with universal foot

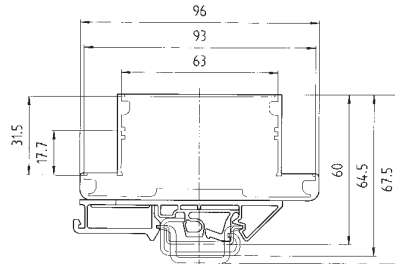

Dimensions of universal foot

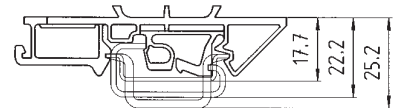

Dimensions for WEB empty housing for sizes 2, 4, 7 and 9 with foot TS 35

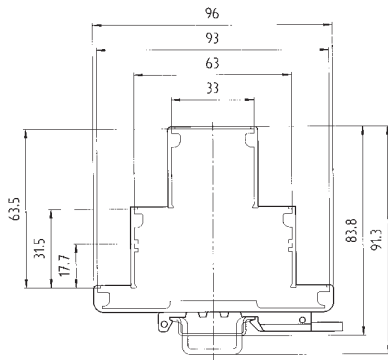

Dimensions for WEB empty housing for sizes 2, 4, 7 and 9 with universal foot

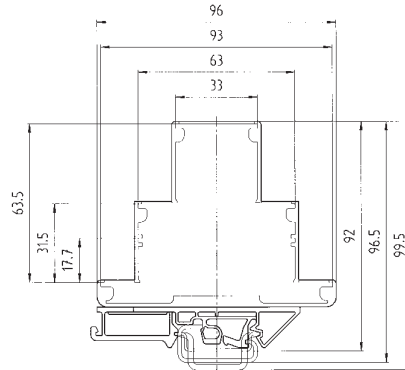

Electronic empty housings



Dimensions of **WEG**
overall width: 20 mm

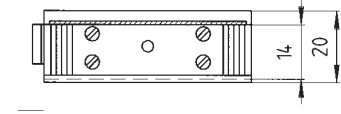
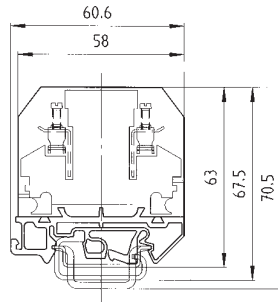

Dimensions of **WEG**
overall width: 16.5 mm
overall width: 22.5 mm
overall width: 28.5 mm

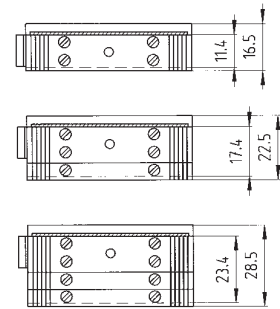
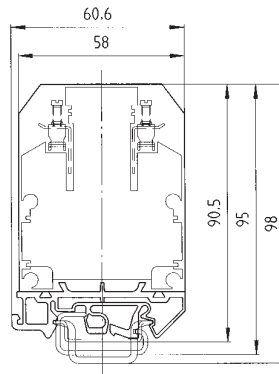

Dimensions of **WEG**
PCB sizes

Overall depth: 63 mm

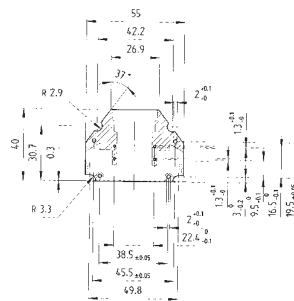

Overall depth: 90.5 mm

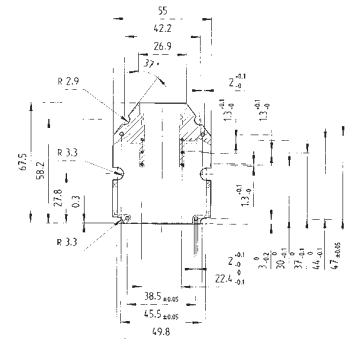

wieBox

Dimension of *wieBox* housing

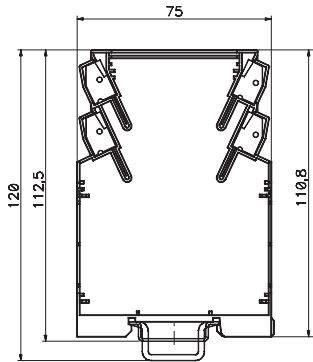

Drawing dimensions

	Dim A	Dim B	Dim C	Dim D
CN 19	19	17	18	18
CN 22	22.5	20.5	21.5	21.5
CN 26	26	24	25	25

(3/4) Lid

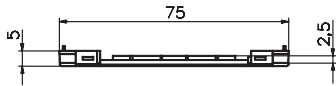

(6/7) Front flap

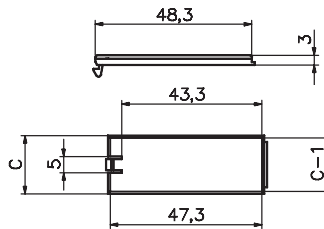

(9) Snap-in plate

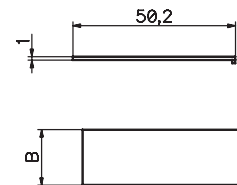

(5/8) Lid

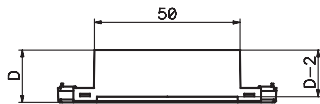

Dimensions of *wieBOX* PCB size

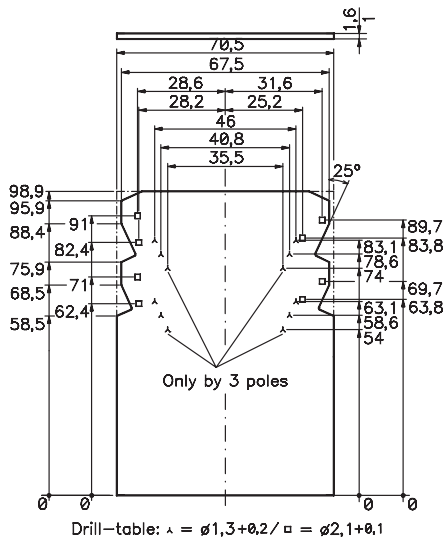

Subject to change without further notice

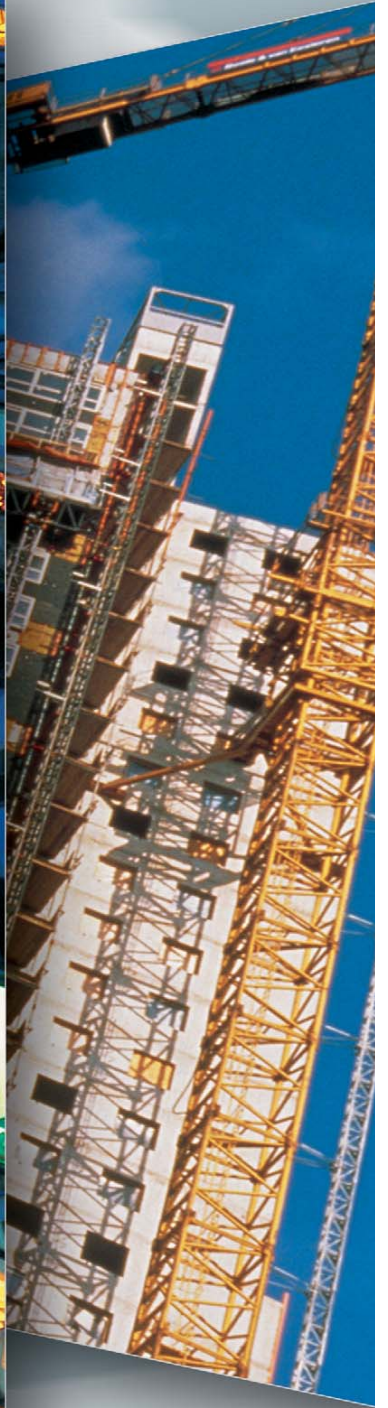



gesis



Pluggable Electrical Installation System

Electrical installation today: plug in and go

gesis® EIB

GST18

The components of the product line GST 18 are certified according to DIN VDE 0628 and are suited for installation of lighting systems, switches and outlets. They are available in 3 pole, 4 pole, 5 pole and 6 pole configurations and are rated up to 250V or 250/400V, 16A.

BST / EST

You can choose among three product series for the transmission of 2 pole EIB signals. Depending upon your application, you can select either the BST bus connector or the compact connector of the EST line. Wherever you require both power and signal at the same time, these twin connectors have proven extremely practical. All products of this line are marked with a green EIB coding.

Flat cable systems

The flat cable technology can, without a doubt, be called a revolution in the field of electrical installation. The system is based upon a flat cable which combines five insulated wires for electrical network applications and, in parallel, a 2 pole screened signal line – all in one cable. For applications requiring only one version, we also provide the flat cables separately. Connectivity is

Components in 2 pole, 3 pole, 4 pole, 5 pole and 6 pole configuration

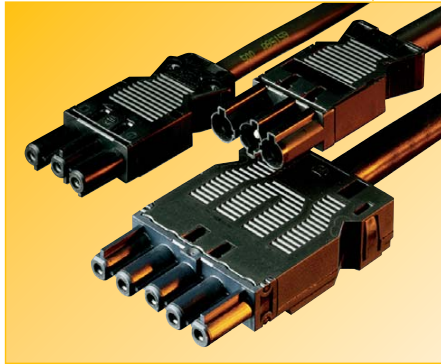

Compact connector for power and signals

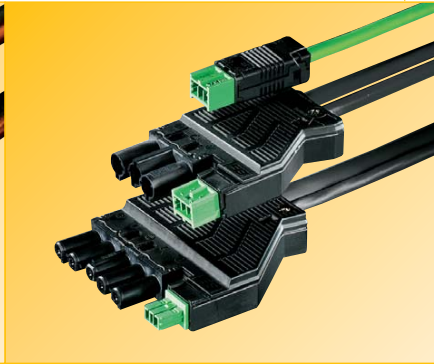

Connection to the flexible cable



A special variation – mechanically not compatible of course – allows for the transmission of bus, control or loud-speaker signals.

achieved by means of an insulation piercing connection technique which is possible at any point on the main line. Without having to interrupt the main line, you can add a required branch line by means of plug-in connectors.

gesis

Low voltage systems

The **gesis** system also allows for low voltage systems as well. Using pluggable electrical transformers, you can change directly to the two low voltage lines ST16 or ST17.

EIB systems

Distributed EIB switching devices can be easily integrated into the installation system as required due to its pluggable design. These EIB switching devices are available in two basic versions: EIB-V, which is characterized by its flat and compact design. And EIB-M, a highly flexible solution which is comprised of individual modules.

Stacking coordinates

The stacking coordinates provide an individual solution for each application. The coordinates are made of zinc-plated sheet steel and are equipped with TS 35 mounting rails. They accept both terminal blocks and modular devices in any configuration. The **gesis** connector system functions as an interface over the entire network leading to the end devices.

Pluggable low voltage systems

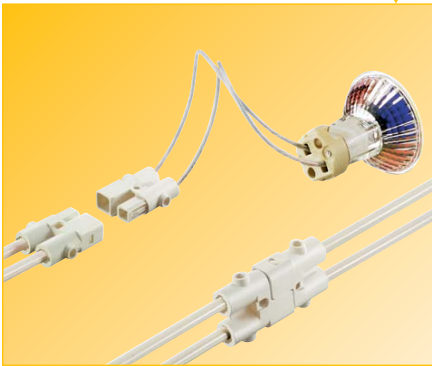

Distributed EIB switching devices can be integrated

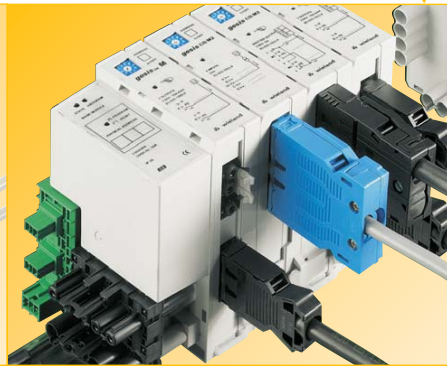

Stacking coordinates



Please contact **Wieland Electric Inc.**
for your **gesis** systems catalog.



gesis

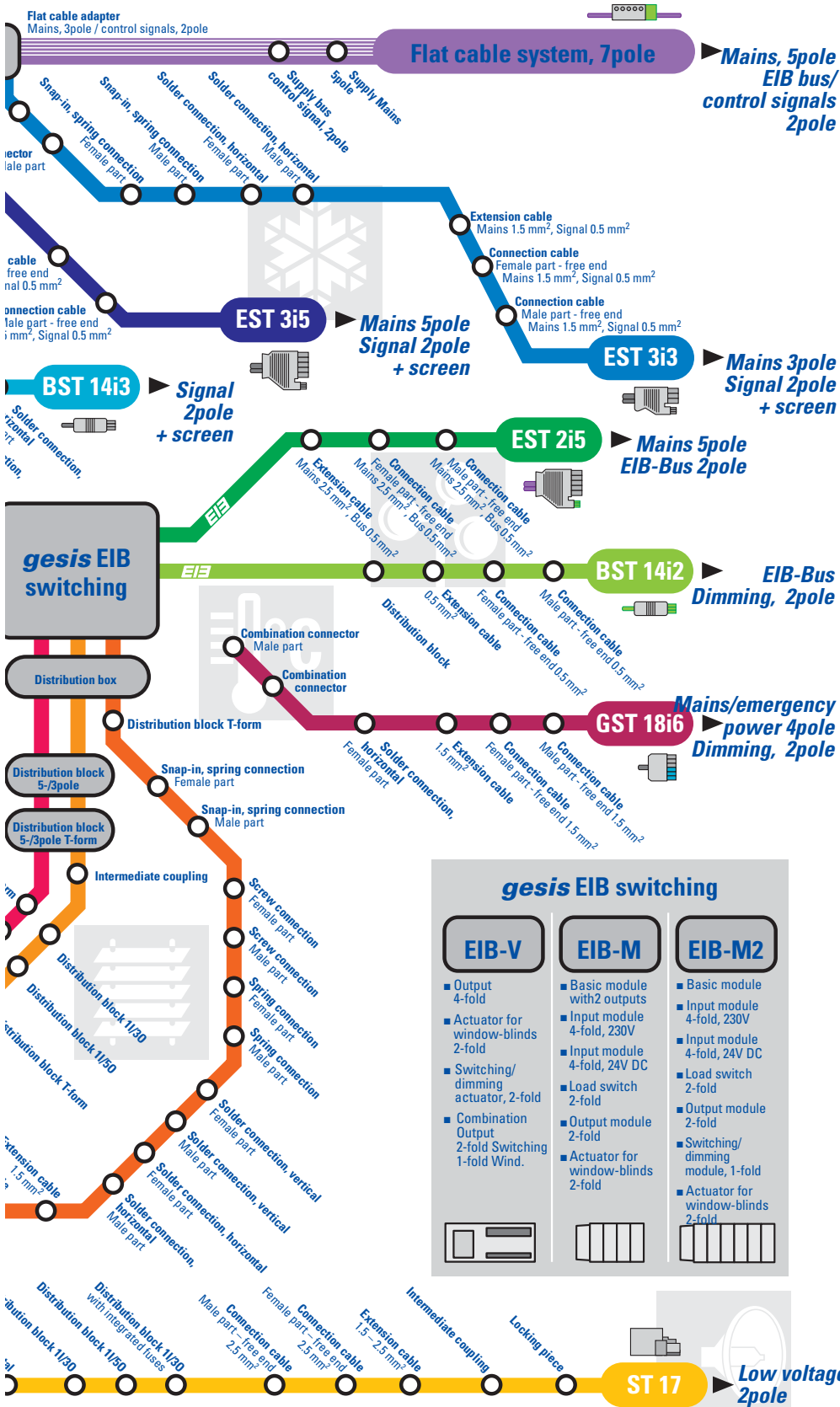

Contents

	GST 18i3 Mains, 3pole	
	GST 18i4 Mains, 4pole	
	GST 18i5 Mains, 5pole	
	GST 18i6 Mains/emergency power supply 4pole Dimming, 2pole	
	BST 14i2 EIB bus Dimming, 2pole	
	EST 2i3 Mains, 3pole EIB bus, 2pole	
	EST 2i5 Mains, 5pole EIB bus, 2pole	
	BST 14i3 Signal, 2pole + screen	
	EST 3i3 Mains, 3pole Signal, 2pole + screen	
	EST 3i5 Mains, 5pole Signal, 2pole + screen	
	Flat cable system, 5pole Mains, 5pole	
	Flat cable system, 2pole EIB bus/control signals, 2pole	
	Flat cable system, 7pole Mains, 5pole EIB bus/control signals, 2pole	
	ST 16 Low voltage, 2pole	
	ST 17 Low voltage, 2pole	
	gesis EIB switching devices EIB-V EIB-M EIB-M2	
	Distributor	
	Accessories	
	Technical information	

gesis

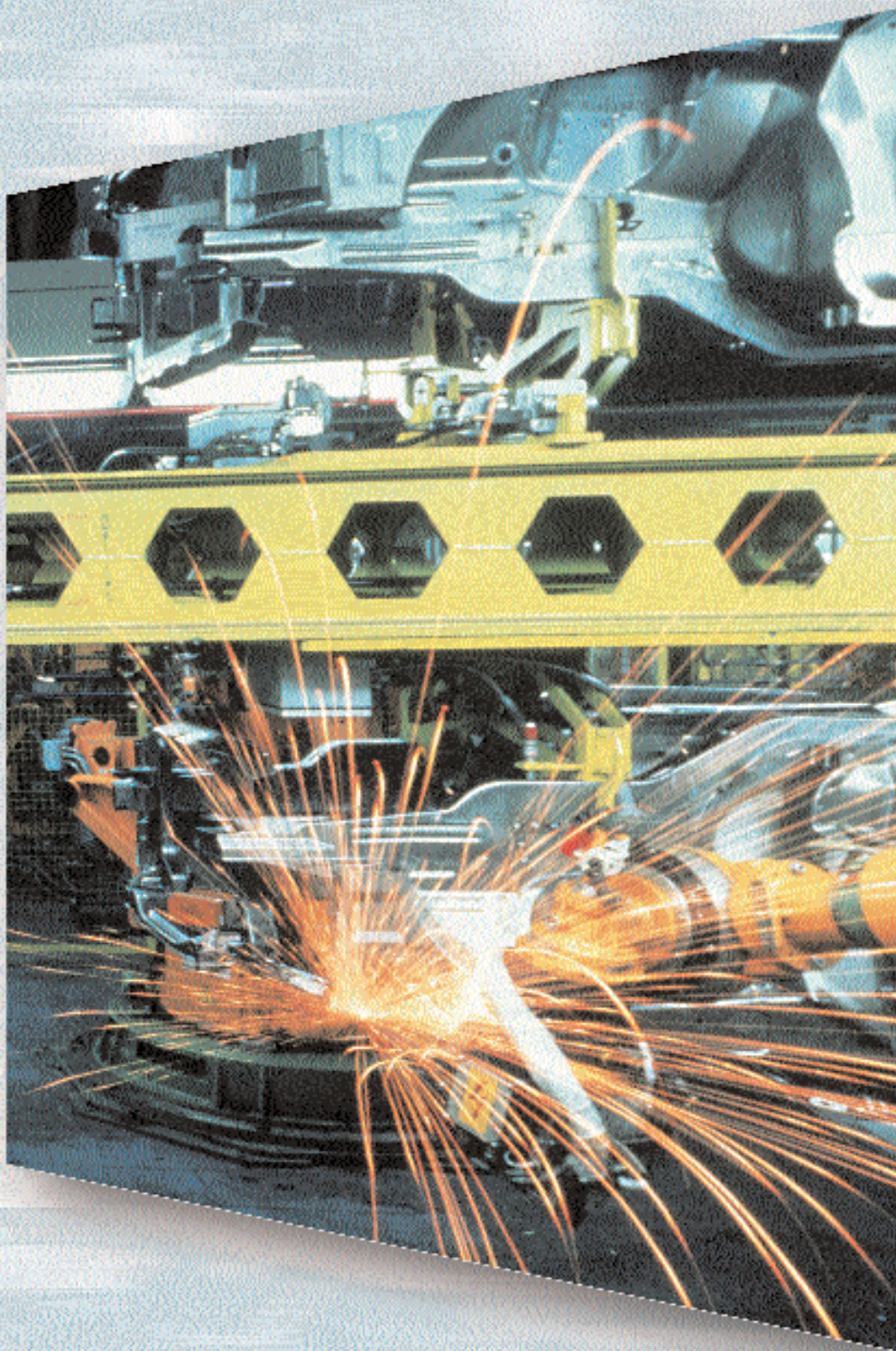

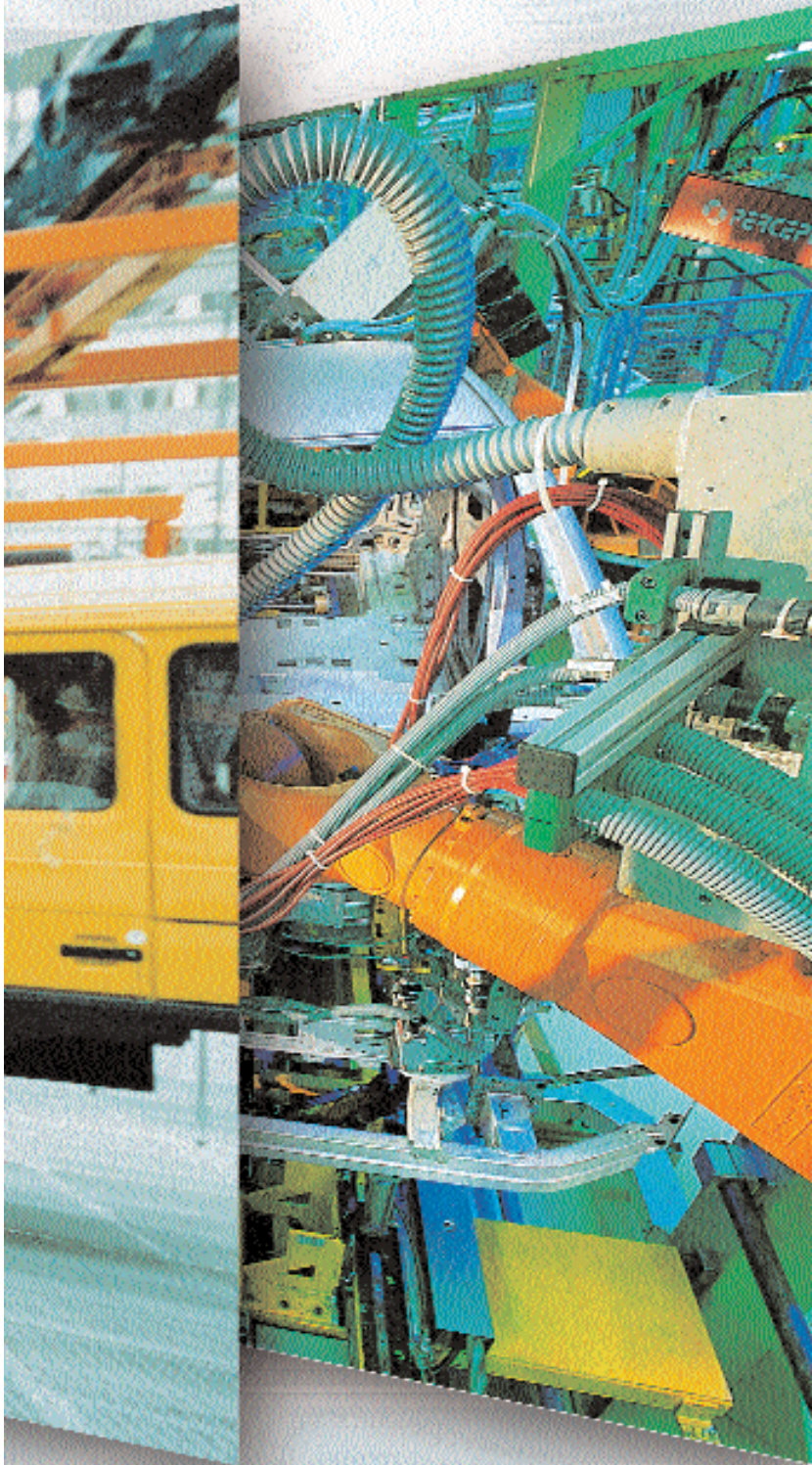

revos

Industrial Multipole Connectors

revos

Series		Rated voltage		Rated current
Introduction	Industrial multipole connectors	VDE	UL/CSA	
revos BASIC	Inserts/hoods and housings	500 V	600 V	16 A
	Multipole adapters	500 V	600 V	16 A
	Inserts/hoods and housings	690 V/400 V	600 V	16 A
	Multipole adapters	500 V	600 V	16 A
	Inserts/hoods and housings	690 V	600 V	16 A
	Multipole adapters	500 V	600 V	16 A
	Multiple multipole connectors	500 V	600 V	16 A
	Sets with 2 components			
	– Multipole adapters	500 V	600 V	16 A
	– Multipole adapters	500 V	600 V	16 A
	– Multipole adapters	690 V/400 V	600 V	16 A
	Sets with 4 components	500 V	600 V	16 A
	Strain relief frames	500 V	600 V	16 A
		690 V	600 V	16 A
		250 V	600 V	10 A
	EMC			
revos POWER		400 V	600 V	35 A
		690 V	600 V	35 A
		690 V/400 V	600 V	82 A
		690 V	600 V	35 A/16 A
		690 V/400 V 400 V/230 V	600 V	40 A/16 A
		690 V/400 V	600 V	100 A/40 A/16 A
		690 V/400 V	600 V	82 A/16 A CSA 70 A/16 A
revos MINI		250 V + 400 V	600 V	10 A
		50 V + 250 V	42 V + 600 V	10 A
revos HD	Inserts/hoods and housings	250 V	600 V	10 A
	Multipole adapters	250 V	600 V	10 A
revos FLEX	Cable to cable couplings	100 V to 1000 V	60 V – 600 V	CSA 5 A – 35 A 5 A to 40 A
revos IT	Data cable feed-through D-SUB			
revos MOT		690 V		16 A
revos SLIDE		250 V		10 A
revos EEx i	Special version	90 V		16 A
revos	Accessories			

revos

CONTENTS

Number of poles + ground	Connection style	
		Page 614
6, 10, 16, 24, 32, 48	Screw, crimp, spring connection	Page 630
6, 10, 16, 24, 32, 48	Screw and spring connection	Page 630
3, 6, 10, 16, 20, 26, 32	Screw connection	Page 642
3, 6, 10	Screw and spring connection	Page 642
6, 10, 16, 24, 32, 48	Screw and crimp connection	Page 654
6, 10, 16, 24	Screw and spring connection	Page 654
16, 24	Screw connection	Page 664
6, 10, 16, 24	Screw connection	Page 666
6, 10, 16, 24	Screw connection	Page 668
3, 6, 10	Screw connection	Page 670
6, 10, 16, 24	Screw connection	Page 672
6, 10, 16, 24	Screw and crimp connection	Page 674
6, 10, 16, 24	Screw and crimp connection	Page 678
40, 64	Screw and crimp connection	Page 682
6, 10, 16, 24	Screw and crimp connection	Page 684
6	Screw connection	Page 688
6	Screw connection	Page 692
4	Screw connection	Page 696
4- / 6	Screw connection	Page 698
6- / 6	Screw connection	Page 702
3- / 3- / 6	Screw connection	Page 704
4- / 2	Screw connection	Page 706
3, 4	Screw connection	Page 712
7, 8	Crimp connection	Page 712
15, 25, 40, 64	Crimp connection	Page 718
		Page 732 Page 740
9 to 100	Solder connection	Page 754 Page 756
10	Crimp connection	Page 758
24	Crimp connection	Page 760
6, 10, 16, 24, 48	Screw connection	Page 766
		Page 774

Industrial multipole connectors









General

revos

Industrial multipole connectors are specially designed for applications under extreme external conditions. The main areas of application are the automotive industry, machine construction and industrial system building, and I&C technology.

They make the installation of machines and industrial systems easier and help to save time. The units or components can be put to in-house quality checks and make the start-up of industrial systems much easier and faster.

Industrial multipole connectors by Wieland have existed in their proven quality for centuries. Today, they are integrated into new product families:

-  **revos BASIC** the proven robust multipole connectors in a comprehensive and versatile product range
-  **revos POWER** for rated currents higher than 16 A, also available with mixed contacts
-  **revos MINI** our robust small connectors in 3pole through 8pole configurations
-  **revos HD** high-density connector family 15pole through 64pole configurations accord. to DIN EN 175301-801
-  **revos FLEX** modular system for an efficient, intelligent mixture of contacts in industrial multipole connectors
combinations of 4 frame sizes,
5 different inserts,
17 contact variants and 306 hood/housing varieties meet all possible requirements
-  **revos IT** data cable feedthrough – the ideal solution for cable entries into closed-bottom housings. They provide a tight connection with strain relief, without disconnecting
-  **revos MOT** the new generation of multipole connectors with a plastic housing made from UV and salt water resistant Polyamide
easy handling due to the unique locking lever. 10pole version for rated voltages of 690 V AC and rated currents of 16 A
-  **revos SLIDE** the new 24pole multipole connector with floating connections for applications in the control cabinet. Safe and automatic connection for applications with the EX slide-in technique are guaranteed by the available guiding pins.
-  **revos Ex** EEx ia connectors for applications in explosion hazardous areas such as in mining and oil refineries
zone 1 applications are only possible with robust hoods and housings made from zinc die cast aluminum with blue finish



revos class I, Zone 2 multipole kits are available certified to CSA standard C 22.2 182.3, E-79-15-95.

revos



revos

Industrial multipole connectors

Hoods and housings

revos



revos BASIC

Areas of application

For most demanding requirements such as in the automotive industry, in machine construction, in industrial system building, and for the I&C technology

Identification

Hoods and housings with silicon-free finish in silver gray (similar to RAL 7001)

Material

die cast aluminum alloy

Locking levers

zinc-plated steel

Cable glands

special cable glands for hoods with strain relief and/or protection against bending



revos MOT- Hoods and housings for demanding environmental conditions

Areas of application

For aggressive environments and extreme climatic conditions in all types of applications

Identification

Hoods and housings in black (RAL 9005)

Material

Polyamide

Locking spring

stainless steel

Cable glands

special cable glands made from plastic material with strain relief and protection against bending



revos BASIC- Hoods and housings for extreme environmental conditions

Areas of application

For electrical interfaces in exterior applications, for extreme climatic conditions or wet zones, and for exterior railway applications

Identification

gray coloring, internal gaskets

Material

corrosion-resistant die cast aluminum alloy

Locking levers

galvanically zinc-plated steel

Cable glands

special cable glands (not part of the standard scope of supply)

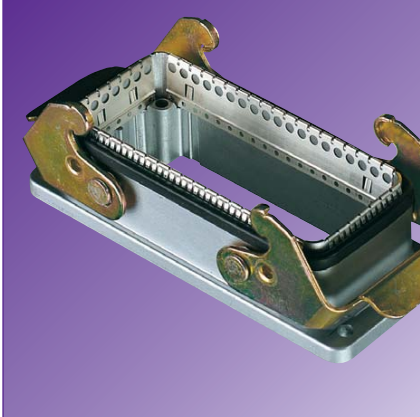

revos BASIC - Hoods and housings with high EMI shielding

Areas of application

For all applications in which protection against electric, magnetic or electro-magnetic fields is required for the safety of the industrial system

Identification

conductive surface, silver-plated contact zone

Material

die cast aluminum alloy

Locking levers

zinc-plated steel

Cable glands

EMC cable glands

revos

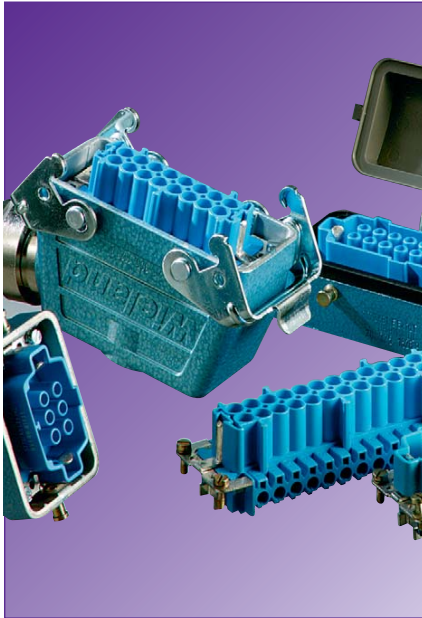

revos EEx ia

Areas of application

Applications in mining, in machine construction, in control system and switchgear building, especially in intrinsically safe electrical systems

Identification

hoods and housings with light blue finish

Material

die cast aluminum alloy

Locking levers

zinc-plated steel

Cable glands

EEx ia cable glands

Please contact us for Class I, Zone 2
Multipole Kits, certified to CSA standard:
C 22.2 182.3, E-79-15-95



revos MINI - small design

Areas of application

Applications in machine construction, in control system and switchgear building, inside of lighting systems and small motors

Identification

plastic: gray

metal: silicon-free finish in gray

Material

thermoplastic material

zinc die cast aluminum alloy

Locking levers

zinc-plated steel

Cable glands

standard cable glands



revos

Industrial multipole connectors

Female and male connector inserts

revos

- Mounted in the direction of the power flow (female insert is live)
- No mismatching due to the special design of the female and male inserts
- Consecutive numbers both on the contact and on the connection sides
- Mixed contacts possible



with screw connection

- Captive hardware
- Screws are protected against accidental loosening
- Delivered with open clamping body
- Versions with and without wire guard
- Wire guards prevent stranded wires from being damaged
- Due to an integrated screwdriver guide, both electric and pneumatic screwdrivers can be used

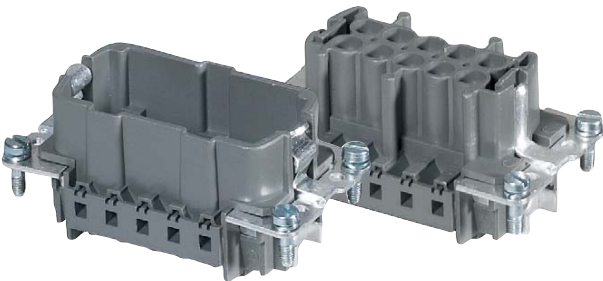

with crimp connection

- Corrosion-resistant due to gas-tight connections (cold welding)
- Constant feed through resistance
- Rapid mounting
- Crimp contacts safely latch into the female and male inserts
- Female and male contacts in various cross sections
- The cross sections are represented by ID rings on the contacts:

0.50	mm ²	- ring	20 AWG
0.75 - 1	mm ²	1 ring	18 AWG
1.50	mm ²	2 rings	16 AWG
2.50	mm ²	3 rings	14 AWG
4.00	mm ²	- ring	12 AWG

For crimping tools see **facts & DATA**

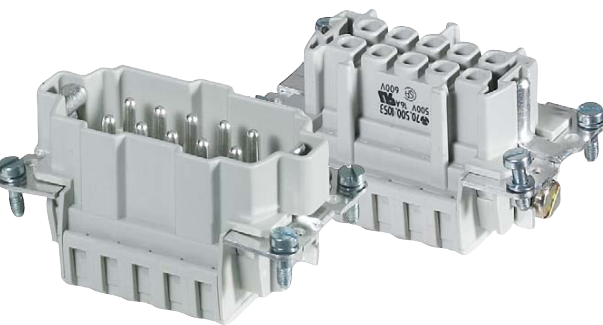

with spring connection

- Vibration and shock proof connections
- Low feed through resistance
- Connection style: 0.14 - 2.5 mm²
26 - 12 AWG, solid and fine stranded
- High installation comfort due to TOP connections
- Wire entry in parallel to the screwdriver
- Screwdriver blade: 3.5 mm x 0.5 mm
- Plug together with the screw and crimp connectors

Materials

revos



for screw connection

- Contact parts: Brass with surface treatment
- Wire guard: phosphor bronze
- Clamping screws: galvanically refined steel



for crimp connection

- Female and male contacts: brass, galvanic surface treatment

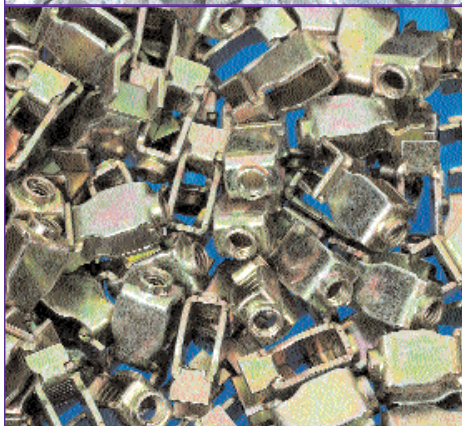

for spring connections

- Spring: refined spring steel
- Current carrying bar: copper alloy, with galvanic surface treatment



for female and male connector inserts

- Insulating parts from fiberglass reinforced Polyamide (for technical information see **facts & DATA**)

for multipole adapters

- Insulating part: Polyamide
- Contact parts: tin-plated brass



Industrial multipole connectors

revos

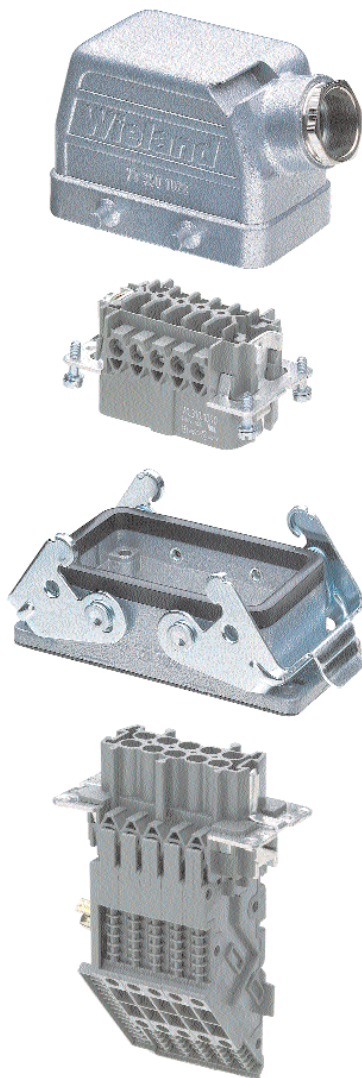

Technical information:

Material:

Hoods and housing:	die cast aluminum alloy
Surface:	silver gray, silicon-free finish
Mounting plates for female and male connector inserts:	nickel-plated brass
Ground contact screw connection:	nickel-plated brass
Male pins and female contacts:	Brass with surface treatment
Clamping screws:	galvanically zinc-plated steel
Locking levers:	galvanically zinc-plated and dichromated steel
Pressure screw:	nickel-plated brass
Pressure screw with strain relief and flared cable entry:	nickel-plated brass
Gaskets:	Neoprene (oil-resistant and anti-aging)
Hinged cover:	Polyamide
Temperature range:	-40° C – +110° C
Insulating parts for:	70.3; 70.5; 70.7; Polyamide, fiberglass reinforced
Multipole adapters:	
Female and male connector inserts:	Polyamide, fiberglass reinforced
Adapter	
Insulating part:	Polyamide
Contact parts:	tin-plated brass
Wire strip length for the multipole adapters:	9 – 12 mm
Degree of protection accord. to DIN 60 529:	IP 55

revos

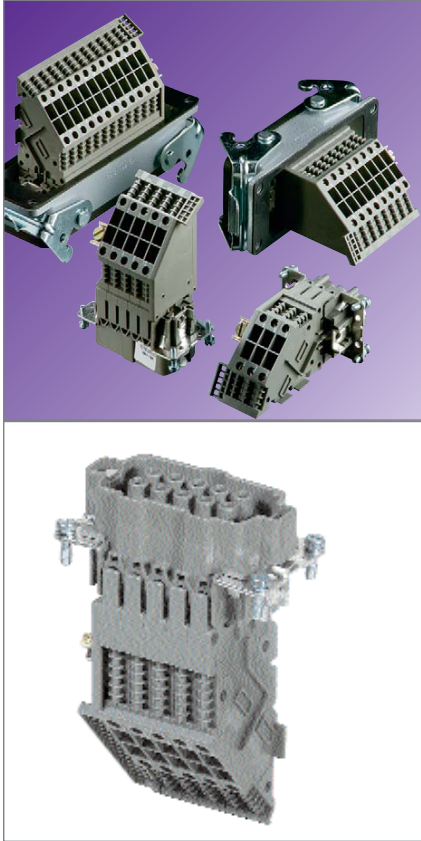

Multipole adapters

- Space-saving connection element for industrial multipole connectors consisting of: connector contact insert with snap-onconnector
- Multipole adapters are available with female or male connector inserts
- Preassembled unit complete with male housing for mounting to the control cabinet wall
- Easy handling:
slide the multipole adapter to the housing and fix it with screws
- TOP connection design
- Testing possible when connected, i.e. no power interruption necessary
- Clearly identified and easily accessible clamping points
- 4digit or 6digit marking fields
- Safe and time-saving wiring
- Reduced control cabinet space due to the small design
- Potential commoning due to an insulated jumper bar

Industrial multipole connectors

revos

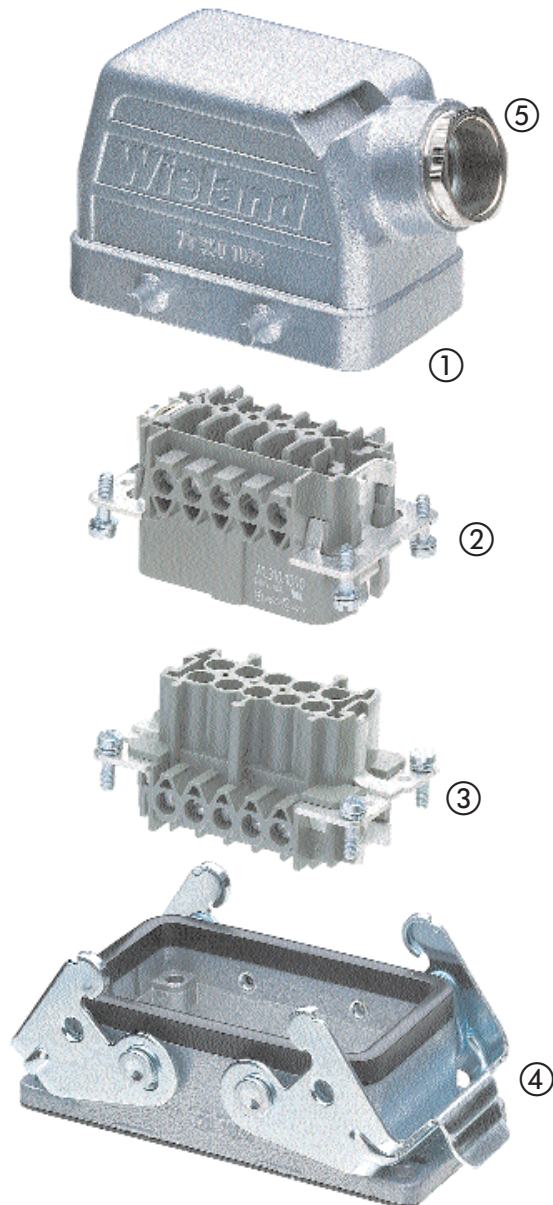

A complete industrial multipole connector consists of the following components:

- ① **Hood**
 - low and high designs
 - narrow-side, wide-side and top cable entries
 - Single or double locking levers with cable glands
 - version 7x.xxx.xxxx.0
 - version 7x.xxx.xxxx.3
 - ② **Female and**
 - ③ **male inserts**
 - screw connection
 - crimp connection (contacts supplied separately)
 - spring connection
 - ④ **Housing**
 - open-bottom housing
 - with or without plastic cover
 - single or double locking lever
 - closed-bottom housing
 - with cable glands
 - low or high designs
 - one or two locking levers
 - with cable glands
 - version 7x.xxx.xxxx.0
 - cable to cable coupling
 - ⑤ **Cable gland**
 - cable glands in IP 65 made from plastic or nickel plated-brass
 - special cable glands with strain relief and protection against bending
 - EMC cable gland
 - EX cable gland
 - Large range of accessories
- Accessories**
- coding pins
 - marking tags

The following versions of multipole connector hoods are available:



Version A

Hood with narrow-side entry cable gland on the right



Version B

Hood with wide-side entry cable gland in the front

revos

Available hoods and housings:

Hoods

- | | |
|---|---------------|
| <input type="checkbox"/> with cable gland, without strain relief | 7x.xxx.xxxx.0 |
| <input type="checkbox"/> with metric thread | 7x.xxx.xxxx.1 |
| <input type="checkbox"/> with integrally cast or screwed in metric intermediate support | 7x.xxx.xxxx.2 |
| <input type="checkbox"/> with strain relief | 7x.xxx.xxxx.3 |



7x.xxx.xxxx.0



7x.xxx.xxxx.1

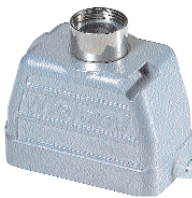

7x.xxx.xxxx.2



7x.xxx.xxxx.3

The cable glands are delivered together with sealing gaskets. The gaskets have different cuts for the various cable diameters and can be cut out as required.

By using the suited cable glands (see the accessories) you will achieve IP 65 degree of protection.



Version C

Hood with top entry cable gland

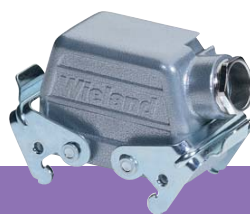

Version D

Hood with narrow-side entry cable gland on the right and locking levers

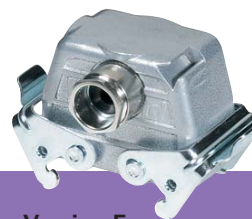

Version E

Hood with wide-side entry cable gland in the front and locking levers



Version F

Hood with top entry cable gland and locking levers

revos

Industrial multipole connectors

Housings

revos

Housings

- open-bottom design (versions a and e)
- closed-bottom design (versions b, c, d, f, g, h and i)

Open-bottom housings

These housings are open at the bottom for panel mounting. They are equipped with two gaskets.

- one gasket at the bottom
- another gasket between housing and hood

The main area of application is the connection of control and line signals to the control cabinet. The mating hood is mounted to the housing on the control cabinet wall.

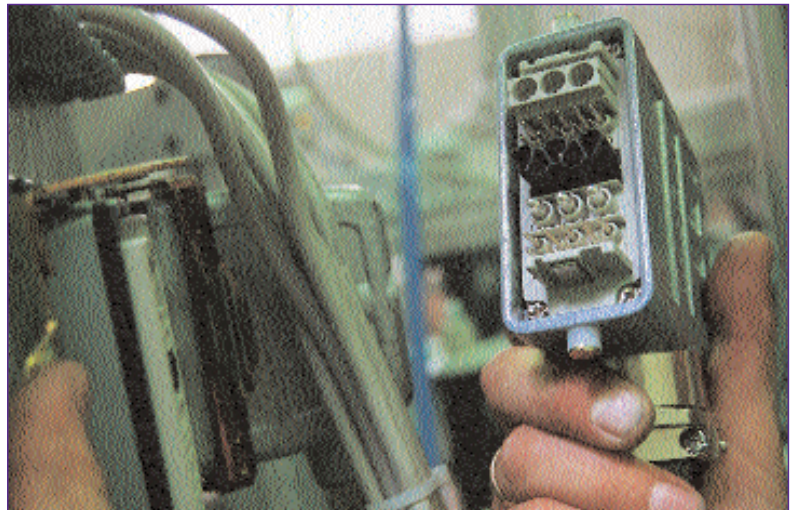

Version a

Open-bottom housing

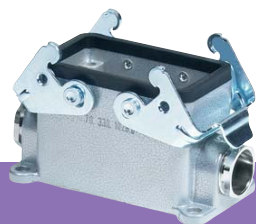

Version b

Closed-bottom housing with two cable glands



Version c

Closed-bottom housing with one narrow-side entry cable gland at the left



Version d

Closed-bottom housing with one bottom entry cable gland

revos

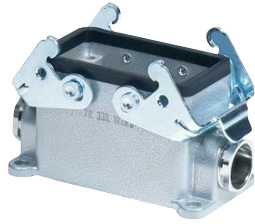

Closed-bottom housings

- with metric cable gland, without strain relief
7x.xxx.xxxx.0

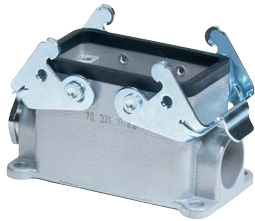

- with metric thread
7x.xxx.xxxx.1

These housings usually have one or two cable entries. They are sealed by means of an appropriate cable gland. Additionally, the cable glands function as reliable strain reliefs for the clamping points.



Version e

Open-bottom housing with protective cover



Version f

Closed-bottom housing with protective cover and two cable glands



Version g

Closed-bottom housing with protective cover and one narrow-side entry cable gland at the left



Version h

Closed-bottom housing with protective cover and one narrow-side entry cable gland at the right



Version i

Closed-bottom housing with protective cover and one bottom entry cable gland

Information on how to change over from Pg to metric threads

revos BASIC

Pg threads are available upon request!

1. Basic legal conditions

The European standard EN 50 262 "Metric Cable Glands for Electrical Installation" was ratified on April 01, 1989 by CENELEC (European Committee for Electrotechnical Standardization) and put into force.

A corresponding German standard DIN EN 50 262 published in March 1999 will then replace the national standards: VDE security standard 0619 quoting standards DIN 46 319 and DIN 46 320, with a transition period until March 01, 2001.

EN 50 262 is valid in all EC countries and countries not belonging to the EC and cooperating in CENELEC will accept the standard.

The big difference in the new EN standard is its character as a security standard. As a building standard it only defines the metric thread and its lead.

2. Effects of the change

The changeover will affect all manufacturers of cable glands, cable entries and housings for rectangular connectors.

The ten Pg sizes :

Pg 7 / 9 / 11 / 13.5 / 16 / 21 / 29 / 36 / 42 and 48

are replaced by eight metric sizes :

M 12 / 16 / 20 / 25 / 32 / 40 / 50 and 63

3. Comparison of the Pg/metric cable gland sizes

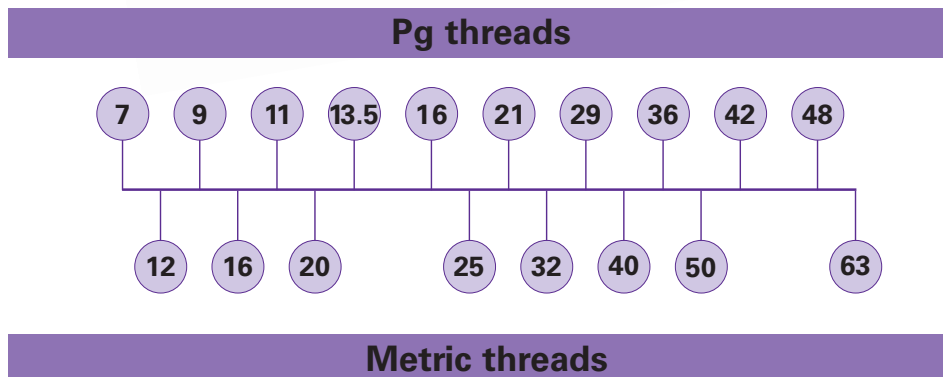

4. Assigning the Pg/metric cable glands

As the ten Pg sizes are replaced by eight metric threads, the users have to reassign the connection ranges of the cables to the thread sizes and housings.

The cable gland manufacturers have different assignments because the new standard is not a construction standard and does not specify any standardization.

revos

5. Conversion

5.1 Comparison between Pg thread and metric thread

Pg thread	Metric thread	Preferred types
Pg 7	M 12	
Pg 9	M 16	
Pg 11	M 20	X
Pg 13.5	M 20	X
Pg 16	M 20	X
Pg 21	M 25	X
Pg 29	M 32	X
Pg 36	M 40	
Pg 42	M 50	

Hoods of the revos BASIC series with Pg thread 13.5 and 16 are also available with M 25, while PG thread 21 is also available with M 32 thread.

If you require the Pg 16 and 24 housings in M 32, you will have to use the housings of high design.

5.2 Connection range for housing versions 7x.xxx.xxxx.0

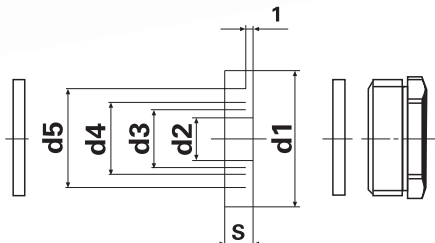

For more information visit us on the internet under www.wieland-electric.com

Please see the following table for the connection ranges of cable glands without strain relief:

Metric thread	d1	d2	Connection range in mm	d3	Connection range in mm	d4	Connection range in mm	d5	Connection range in mm
M 16	13.8	3	2 – 4.5	6	5 – 7.5	9	8 – 10.5		
M 20	17.6	4	3 – 5.5	7	6 – 8.5	10	9 – 11.5	13	12 – 14.5
M 25	22.6	8.5	7.5 – 10	11.5	10.5 – 13	14.5	13.5 – 16	17.5	16.5 – 19
M 32	29.6	16	15 – 17.5	19	18 – 20.5	22	21 – 23.5	25	24 – 26.5

5.3 Connection ranges for housing versions with flared gland 7x.xxx.xxxx.3

Metric thread	Connection range in mm
M 16	6 – 9
M 20	9 – 13.5
M 25	14 – 20
M 32	19 – 29

Information on hazardous location approval : Class I, Zone 2 Multipole Kits are available certified to CSA standard C22.2 182.3, E-79-15-95.

Please contact us to discuss your applications.

Industrial multipole connectors

revos BASIC

Technical information

■ Approvals	UL, CSA, SEV
■ Applicable standards	IEC 61 984
■ Contact inserts	
Rated current	16 A
Rated voltage	500 V
Nominal voltage accord. to UL	600 V
Nominal voltage accord. to CSA	600 V
Pole configurations	6, 10, 16, 24, 32 (2x16), 48 (2x24), + ground
Screw connection	0.5 – 2.5 mm ² / 20 – 12 AWG
Crimp connection	0.5 – 4.0 mm ² / 20 – 12 AWG
Spring connection	0.14 – 2.5 mm ² / 26 – 12 AWG
Degree of pollution	3
Temperature range	–40 to +110 °C
■ Multipole adapter	
Rated current	16 A
Rated voltage	500 V
Nominal voltage accord. to UL	600 V
Nominal voltage accord. to CSA	600 V
Pole configurations	6, 10, 16, 24, + ground
Screw connection	0.5 – 4.0 mm ² / 20 – 12 AWG
Spring connection	0.5 – 2.5 mm ² / 20 – 12 AWG
Degree of pollution	3
Temperature range	–40 to +110 °C
■ Contacts	
Material	copper alloy
Surface (screw, crimp, multipole adapter contacts)	tin-plated
Surface (crimp, screw contacts)	gold-plated
Surface (crimp, spring contacts)	silver-plated
■ Hoods and housings	
Material	die cast aluminum alloy
Surface	silver gray, silicon-free finish
Locking levers	zinc-plated steel
Gaskets	NBR
Temperature range	–40 to +110 °C
Degree of protection accord. to DIN EN 60 529	
with latched locking levers	IP 55
with appropriate cable gland	IP 65

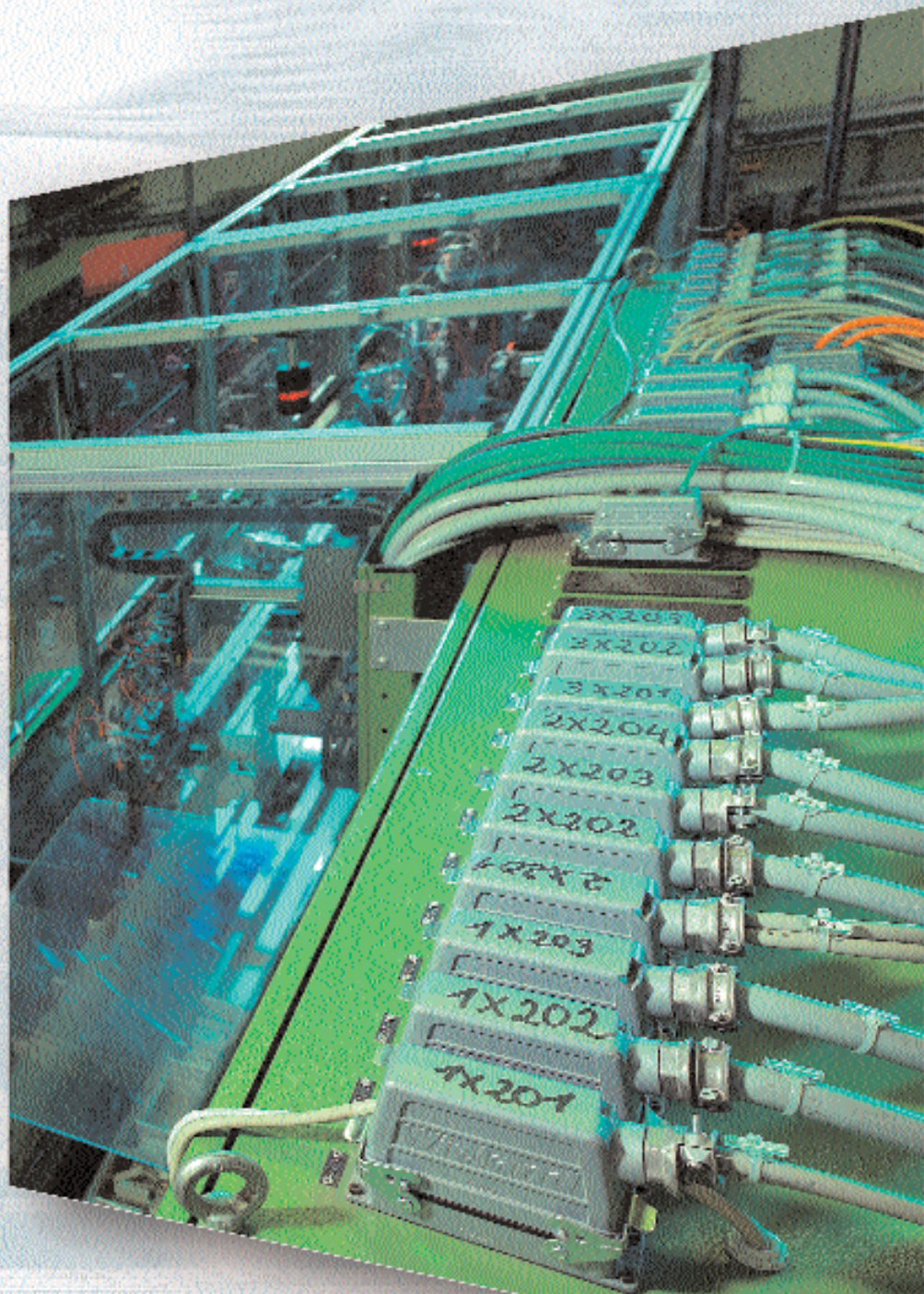

revos

Industrial Multipole Connectors

Industrial Multipole Connectors

Female/male inserts and multipole adapter

revos BASIC

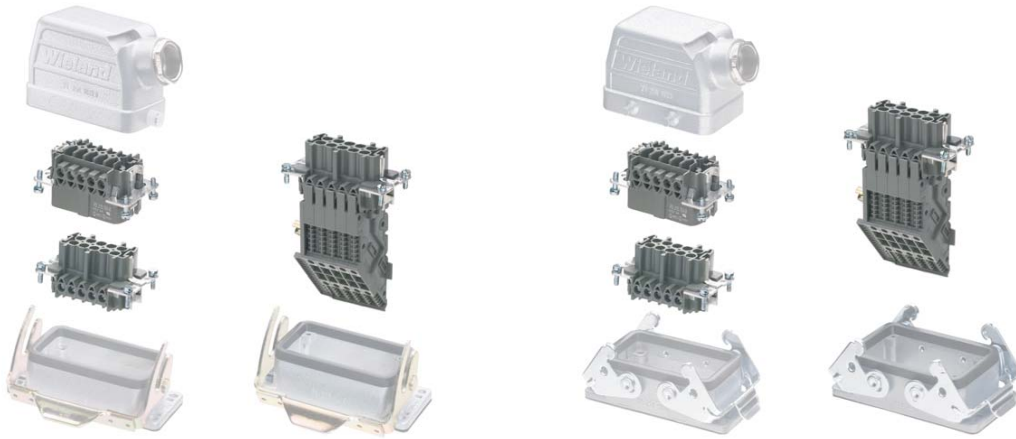

500 V, 16 A IEC 61 984

600 V UL/CSA

		Rated current	Cross section	Approvals	Wire strip length	Contacts	Std. pack
 <p>Screw connection</p>	Female insert	16 A	0.25 – 2.5 mm ² 22 – 12 AWG		7 mm	tin-plated	10
						7 mm	gold-plated
	Male insert	16 A	0.25 – 2.5 mm ² 22 – 12 AWG		7 mm	tin-plated	10
						7 mm	gold-plated
 <p>Crimp connection</p>	Female insert without crimp contacts	16 A	0.5 – 4.0 mm ² 20 – 12 AWG		7 mm	tin-plated	10
							5
	Male insert without crimp contacts	16 A	0.5 – 4.0 mm ² 20 – 12 AWG		7 mm	tin-plated	10
							5
 <p>Spring connection</p>	Female insert 500 V / IEC 61 989	16 A	0.14 – 2.5 mm ² 26 – 12 AWG		7 mm	silver-plated	10
							5
	Male insert 500 V / IEC 61 989	16 A	0.14 – 2.5 mm ² 26 – 12 AWG		7 mm	silver-plated	10
							5
 <p>Screw connection Multipole adapter long design (6 marking fields)</p>	Female insert, ground right	16 A	0.5 – 4.0 mm ² 20 – 12 AWG		12 mm	tin-plated	10
	Female insert, ground left	16 A	0.5 – 4.0 mm ² 20 – 12 AWG		12 mm	tin-plated	10
	Male insert, ground right	16 A	0.5 – 4.0 mm ² 20 – 12 AWG		12 mm	tin-plated	10
	Male insert, ground left	16 A	0.5 – 4.0 mm ² 20 – 12 AWG		12 mm	tin-plated	10
 <p>Screw connection Multipole adapter short design (4 marking fields)</p>	Female insert, ground right	16 A	0.5 – 4.0 mm ² 20 – 12 AWG		12 mm	tin-plated	10
	Female insert, ground left	16 A	0.5 – 4.0 mm ² 20 – 12 AWG		12 mm	tin-plated	10
	Male insert, ground right	16 A	0.5 – 4.0 mm ² 20 – 12 AWG		12 mm	tin-plated	10
	Male insert, ground left	16 A	0.5 – 4.0 mm ² 20 – 12 AWG		12 mm	tin-plated	10
 <p>Spring connection Multipole adapter short design (6 marking fields)</p>	Female insert, ground right	16 A	0.5 – 2.5 mm ² 20 – 12 AWG		9 mm	tin-plated	10
	Female insert, ground left	16 A	0.5 – 2.5 mm ² 20 – 12 AWG		9 mm	tin-plated	10
	Male insert, ground right	16 A	0.5 – 2.5 mm ² 20 – 12 AWG		9 mm	tin-plated	10
	Male insert, ground left	16 A	0.5 – 2.5 mm ² 20 – 12 AWG		9 mm	tin-plated	10

revos

Contacts for crimp version

Female contacts



Male contacts



Crimping tool
Crimping die „B“
Contact positioner „3“
Extraction tool

Cross section mm ²	Part no.	Std. pack	Cross section mm ²	Part no.	Std. pack
	tin-plated			gold-plated	
0.5	20 AWG 02.123.7021.0	200	0.5	20 AWG 02.123.7001.0	
0.75 - 1	18 AWG 02.123.7121.0	200	0.75 - 1	18 AWG 02.123.7101.0	
1.5	16 AWG 02.123.7221.0	200	1.5	16 AWG 02.123.7201.0	200
2.5	14 AWG 02.123.7321.0	200	2.5	14 AWG 02.123.7301.0	
4	12 AWG 02.123.7421.0	200	4	12 AWG 02.123.7401.0	
0.5	20 AWG 05.543.7021.0	200	0.5	20 AWG 05.543.7001.0	
0.75 - 1	18 AWG 05.543.7121.0	200	0.75 - 1	18 AWG 05.543.7101.0	
1.5	16 AWG 05.543.7221.0	200	1.5	16 AWG 05.543.7201.0	200
2.5	14 AWG 05.543.7321.0	200	2.5	14 AWG 05.543.7301.0	
4	12 AWG 05.543.7421.0	200	4	12 AWG 05.543.7401.0	
	95.101.0800.0	1		silver-plated	
	05.502.2100.0	1		upon request	
	05.502.3300.0	1			
	05.502.3500.0	1			

6pole + ground	10pole + ground	16pole + ground	24pole + ground	32pole + ground	48pole + ground
				2 insert 1 - 16 poles 17 - 32 poles	2 inserts 1 - 24 poles 25 - 48 poles
Part no.	Part no.	Part no.	Part no.	Part no.	Part no.
70.300.0640.0	70.300.1040.0	70.300.1640.0	70.300.2440.0	70.300.3253.0	70.300.4840.0
70.301.0640.0	70.301.1040.0	70.301.1640.0	70.301.2440.0		
70.310.0640.0	70.310.1040.0	70.310.1640.0	70.310.2440.0	70.310.3253.0	70.310.4840.0
70.311.0640.0	70.311.1040.0	70.311.1640.0	70.311.2440.0		
70.700.0658.0	70.700.1058.0	70.700.1658.0	70.700.2458.0	70.700.3253.0	70.700.4858.0
70.710.0658.0	70.710.1058.0	70.710.1658.0	70.710.2458.0	70.710.3253.0	70.710.4858.0
70.500.0653.0	70.500.1053.0	70.500.1653.0	70.500.2453.0	70.500.3253.0	70.500.4853.0
70.510.0653.0	70.510.1053.0	70.510.1653.0	70.510.2453.0	70.510.3253.0	70.510.4853.0
70.105.0653.3	70.105.1053.3	70.105.1653.3	70.105.2453.3		
70.100.0653.3	70.100.1053.3	70.100.1653.3	70.100.2453.3		
70.115.0653.3	70.115.1053.3	70.115.1653.3	70.115.2453.3		
70.110.0653.3	70.110.1053.3	70.110.1653.3	70.110.2453.3		
70.105.0653.4	70.105.1053.4	70.105.1653.4	70.105.2453.4		
70.100.0653.4	70.100.1053.4	70.100.1653.4	70.100.2453.4		
70.115.0653.4	70.115.1053.4	70.115.1653.4	70.115.2453.4		
70.110.0653.4	70.110.1053.4	70.110.1653.4	70.110.2453.4		
70.106.0653.0	70.106.1053.0	70.106.1653.0	70.106.2453.0		
70.101.0653.0	70.101.1053.0	70.101.1653.0	70.101.2453.0		
70.116.0653.0	70.116.1053.0	70.116.1653.0	70.116.2453.0		
70.111.0653.0	70.111.1053.0	70.111.1653.0	70.111.2453.0		

Industrial Multipole Connectors Hoods with a single locking lever

revos BASIC

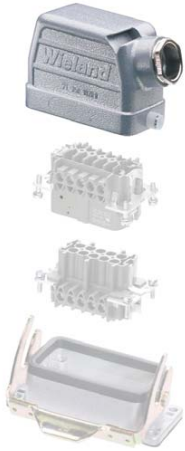

Hood type A

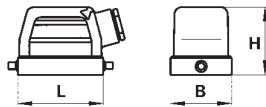

Hood type B

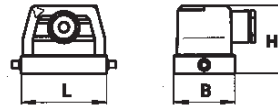

Hood type C

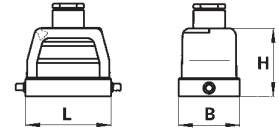

Degree of protection IP 55

Degree of protection IP 65 with matching cable glands (see accessories)

For inserts: **600 V** UL/CSA

For inserts: **500 V** IEC 61 984

Number of poles	Thread	Gland type	Dimensions in mm	L	W	H	Std. pack
Size 6 for connector 6pole + ground	M 20	0 with cable gland 1 with threaded collar 2 with intermediate support 3 with strain relief		60	43	47.5	1
	M 25	0 with cable gland 1 with threaded collar 2 with intermediate support 3 with strain relief		60	43	47.5	1
Size 10 for connector 10pole + ground	M 20	0 with cable gland 1 with threaded collar 2 with intermediate support 3 with strain relief		73	43	53	1
	M 25	0 with cable gland 1 with threaded collar 2 with intermediate support 3 with strain relief		73	43	53	1
Size 16 for connector 16pole + ground	M 25	0 with cable gland 1 with threaded collar 2 with intermediate support 3 with strain relief		93.5	43	60	1
	M 32	0 with cable gland 1 with threaded collar 2 with intermediate support 3 with strain relief		93.5	43	60	1
Size 24 for connector 24pole + ground	M 25	0 with cable gland 1 with threaded collar 2 with intermediate support 3 with strain relief		120	43	70	1
	M 32	0 with cable gland 1 with threaded collar 2 with intermediate support 3 with strain relief		120	43	70	1
Size 48 for connector 48pole + ground	M 32	0 with cable gland 1 with threaded collar 2 with intermediate support 3 with strain relief		132	90	107	1
	M 40	1 with threaded collar 2 with intermediate support		132	90	107	1

revos

Hood	Hood (not suited for female/male inserts with spring connection) for 24pole = 2 x M 25	Hood
Hood type A	Hood type B	Hood type C
		
Part no.	Part no.	Part no.
70.350.0635.0 70.350.0635.1 70.350.0635.2 70.350.0635.3	70.351.0635.0 70.351.0635.1 70.351.0635.2 70.351.0635.3	70.352.0635.0 70.352.0635.1 70.352.0635.2 70.352.0635.3
70.353.0635.0 70.353.0635.1 70.353.0635.2 70.353.0635.3		70.354.0635.0 70.354.0635.1 70.354.0635.2 70.354.0635.3
71.350.1035.0 71.350.1035.1 71.350.1035.2 71.350.1035.3	71.351.1035.0 71.351.1035.1 71.351.1035.2 71.351.1035.3	71.352.1035.0 71.352.1035.1 71.352.1035.2 71.352.1035.3
71.353.1035.0 71.353.1035.1 71.353.1035.2 71.353.1035.3		71.354.1035.0 71.354.1035.1 71.354.1035.2 71.354.1035.3
71.350.1635.0 71.350.1635.1 71.350.1635.2 71.350.1635.3	71.351.1635.0 71.351.1635.1 71.351.1635.2 71.351.1635.3	71.352.1635.0 71.352.1635.1 71.352.1635.2 71.352.1635.3
71.353.1635.0 71.353.1635.1 71.353.1635.2 71.353.1635.3		71.354.1635.0 71.354.1635.1 71.354.1635.2 71.354.1635.3
71.350.2435.0 71.350.2435.1 71.350.2435.2 71.350.2435.3	71.351.2435.0 71.351.2435.1 71.351.2435.2 71.351.2435.3	71.352.2435.0 71.352.2435.1 71.352.2435.2 71.352.2435.3
71.353.2435.0 71.353.2435.1 71.353.2435.2 71.353.2435.3		71.354.2435.0 71.354.2435.1 71.354.2435.2 71.354.2435.3
70.350.4835.0 70.350.4835.1 70.350.4835.2 70.350.4835.3		70.352.4835.0 70.352.4835.1 70.352.4835.2 70.352.4835.3
70.353.4835.1 70.353.4835.2		70.354.4835.1 70.354.4835.2

Industrial Multipole Connectors

Housings with a single locking lever

revos BASIC

Housing type a

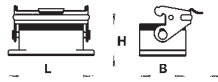

Housing type b

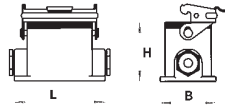

Housing type c



Housing type d

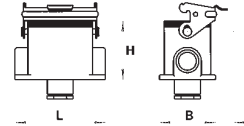

Housing type i

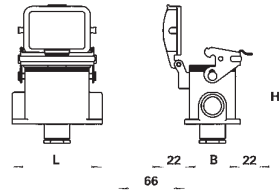

Housing open bottom

Housing type a



Housing closed bottom with two cable glands

Housing type b



Housing closed bottom with one cable gland on the left

Housing type c



Degree of protection IP 55

Degree of protection IP 65 with matching cable glands (see accessories)

For inserts: **600 V** UL/CSA

For inserts: **500 V** IEC 61 984

Number of poles	Thread	Gland type	L	W	H	Std. pack	Part no.	Part no.	Part no.		
Size 6 for connector 6pole + ground	M 20	0 with cable gland	80	43	28	1	70.320.0628.0	70.330.0635.0	70.331.0635.0		
		1 with threaded collar	84	52	54.5	1				70.330.0635.1	70.331.0635.1
Size 10 for connector 10pole + ground	M 20	0 with cable gland	93	43	28	1	71.320.1028.0	71.330.1035.0	71.331.1035.0		
		1 with threaded collar	94	52	54.5	1				71.330.1035.1	71.331.1035.1
Size 16 for connector 16pole + ground	M 25	0 with cable gland	113	43	28	1	71.320.1628.0	71.330.1635.0	71.331.1635.0		
		1 with threaded collar	117	52	56.5	1				71.330.1635.1	71.331.1635.1
Size 16 high design for connector 16pole + ground	M 32	0 with cable gland	117	52	76.5	1	71.320.2428.0	76.334.4035.0	76.335.4035.0		
		1 with threaded collar	117	52	76.5	1				76.334.4035.1	76.335.4035.1
Size 24 for connector 24pole + ground	M 25	0 with cable gland	140	43	28	1	71.320.2428.0	71.330.2435.0	71.331.2435.0		
		1 with threaded collar	144	52	56.5	1				71.330.2435.1	71.331.2435.1
Size 24 high design for connector, 24pole + ground	M 32	0 with cable gland	144	52	76.5	1	71.320.2428.0	76.334.6435.0	76.335.6435.0		
		1 with threaded collar	144	52	76.5	1				76.334.6435.1	76.335.6435.1
Size 48 for connector 48pole + ground	M 32	0 with cable gland	124	84	35	1	70.320.4828.0		70.331.4835.0		
		1 with threaded collar	146	120	99	1				70.331.4835.1	70.331.4835.3
		3 with strain relief	146	120	99	1					
	M 40	1 with threaded collar	146	120	99	1					

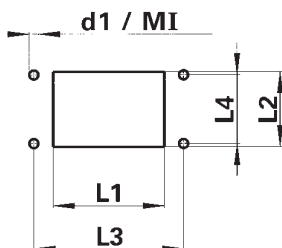

Mounting dimensions for open bottom housings

Housing size	Cut-out (mm)		Mounting holes (mm)		d1 (mm)	MI
	L1	L2	L3	L4		
6	52	35	70	32	4.3	M 4
10	65	35	83	32	4.3	M 4
16	85.5	35	103	32	4.3	M 4
24	112	35	130	32	4.3	M 4
48	117	81	148	70	6.4	M 6

revos

Housing type e

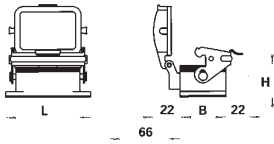

Housing type f

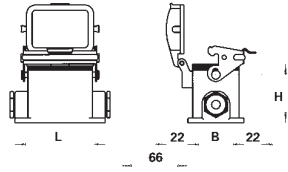

Housing type g

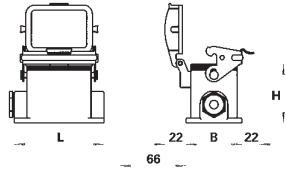

Housing type h

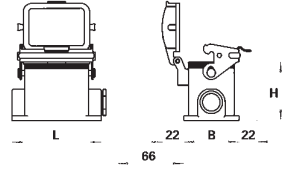

Housing closed bottom with cable gland at the bottom

Housing type d



Housing open bottom with protective cover

Housing type e



Housing closed bottom with two cable glands and protective cover

Housing type f



Housing closed bottom with cable gland on the left and protective cover

Housing type g



Housing closed bottom with cable gland on the right and protective cover

Housing type h



Housing closed bottom with cable gland at the bottom and protective cover

Housing type i



Part no.	Part no.	Part no.	Part no.	Part no.	Part no.
70.333.0635.0 70.333.0635.1	70.325.0628.0	70.340.0635.0 70.340.0635.1	70.341.0635.0 70.341.0635.1	70.342.0635.0 70.342.0635.1	70.343.0635.0 70.343.0635.1
71.333.1035.0 71.333.1035.1	71.325.1028.0	71.340.1035.0 71.340.1035.1	71.341.1035.0 71.341.1035.1	71.342.1035.0 71.342.1035.1	71.343.1035.0 71.343.1035.1
71.333.1635.0 71.333.1635.1	71.325.1628.0	71.340.1635.0 71.340.1635.1	71.341.1635.0 71.341.1635.1	71.342.1635.0 71.342.1635.1	71.343.1635.0 71.343.1635.1
76.337.4035.0 76.337.4035.1		76.344.4035.0 76.344.4035.1	76.345.4035.0 76.345.4035.1	76.346.4035.0 76.346.4035.1	76.347.4035.0 76.347.4035.1
71.333.2435.0 71.333.2435.1	71.325.2428.0	71.340.2435.0 71.340.2435.1	71.341.2435.0 71.341.2435.1	71.342.2435.0 71.342.2435.1	71.343.2435.0 71.343.2435.1
76.337.6435.0 76.337.6435.1		76.344.6435.0 76.344.6435.1	76.345.6435.0 76.345.6435.1	76.346.6435.0 76.346.6435.1	76.347.6435.0 76.347.6435.1
	70.325.4828.0		70.341.4835.1 70.341.4835.3		
			70.344.4835.1		

Housing size	L5 (mm)	L6 (mm)	d2 (mm)	MII
6	70	40	5.5	M 5
10	82	40	5.5	M 5
16	105	45	5.5	M 5
24	132	45	5.5	M 5
48	111	106	6.5	M 6

Mounting dimensions for closed-bottom housings

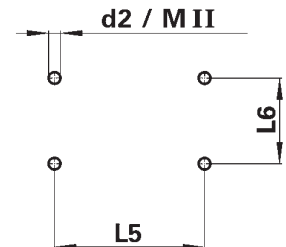

Industrial Multipole Connectors Hoods with double locking levers

revos BASIC

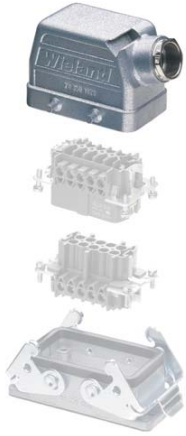

Hood type A

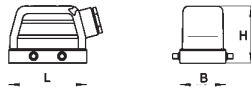

Hood type B



Hood type C

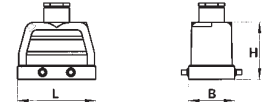

Degree of protection IP 55

Degree of protection IP 65 with matching cable glands (see accessories)

For inserts: **600 V** UL/CSA

For inserts: **500 V** IEC 61 984

Number of poles	Thread	Gland type	Dimensions in mm	L	W	H	Std. pack
Size 10 for connector 10pole + ground	M 20	0 with cable gland 1 with threaded collar 2 with intermediate support 3 with strain relief		73	43	53	1
	M 25	0 with cable gland 1 with threaded collar 2 with intermediate support 3 with strain relief		73	43	53	1
Size 16 for connector 16pole + ground	M 25	0 with cable gland 1 with threaded collar 2 with intermediate support 3 with strain relief		93.5	43	60	1
	M 32	0 with cable gland 1 with threaded collar 2 with intermediate support 3 with strain relief		93.5	43	60	1
Size 24 for connector 24pole + ground	M 25	0 with cable gland 1 with threaded collar 2 with intermediate support 3 with strain relief		120	43	70	1
	M 32	0 with cable gland 1 with threaded collar 2 with intermediate support 3 with strain relief		120	43	70	1
Size 32 for connector 32pole + ground	M 32	0 with cable gland 1 with threaded collar 2 with intermediate support 3 with strain relief		93.5	82.5	94	1
	M 40	1 with threaded collar 2 with intermediate support		93.5	82.5	94	1

revos

Hood type D

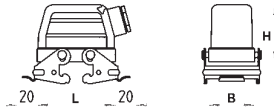

Hood type E

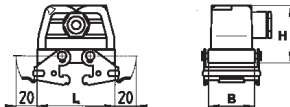

Hood type F

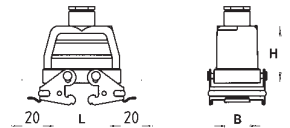

Hood	Hood (not suited for female/male inserts with spring connection) for 24pole = 2 x M 25	Hood	Hood with locking levers	Hood with locking levers (not suited for female/male inserts with spring connection) for 24pole = 2 x M 25	Hood with locking levers
Hood type A	Hood type B	Hood type C	Hood type D	Hood type E	Hood type F
					
Part no.	Part no.	Part no.	Part no.	Part no.	Part no.
70.350.1035.0 70.350.1035.1 70.350.1035.2 70.350.1035.3	70.351.1035.0 70.351.1035.1 70.351.1035.2 70.351.1035.3	70.352.1035.0 70.352.1035.1 70.352.1035.2 70.352.1035.3	70.355.1035.0 70.355.1035.1 70.355.1035.2 70.355.1035.3	70.356.1035.0 70.356.1035.1 70.356.1035.2 70.356.1035.3	70.357.1035.0 70.357.1035.1 70.357.1035.2 70.357.1035.3
70.353.1035.0 70.353.1035.1 70.353.1035.2 70.353.1035.3		70.354.1035.0 70.354.1035.1 70.354.1035.2 70.354.1035.3	70.358.1035.0 70.358.1035.1 70.358.1035.2 70.358.1035.3		70.359.1035.0 70.359.1035.1 70.359.1035.2 70.359.1035.3
70.350.1635.0 70.350.1635.1 70.350.1635.2 70.350.1635.3	70.351.1635.0 70.351.1635.1 70.351.1635.2 70.351.1635.3	70.352.1635.0 70.352.1635.1 70.352.1635.2 70.352.1635.3	70.355.1635.0 70.355.1635.1 70.355.1635.2 70.355.1635.3	70.356.1635.0 70.356.1635.1 70.356.1635.2 70.356.1635.3	70.357.1635.0 70.357.1635.1 70.357.1635.2 70.357.1635.3
70.353.1635.0 70.353.1635.1 70.353.1635.2 70.353.1635.3		70.354.1635.0 70.354.1635.1 70.354.1635.2 70.354.1635.3	70.358.1635.0 70.358.1635.1 70.358.1635.2 70.358.1635.3		70.359.1635.0 70.359.1635.1 70.359.1635.2 70.359.1635.3
70.350.2435.0 70.350.2435.1 70.350.2435.2 70.350.2435.3	70.351.2435.0 70.351.2435.1 70.351.2435.2 70.351.2435.3	70.352.2435.0 70.352.2435.1 70.352.2435.2 70.352.2435.3	70.355.2435.0 70.355.2435.1 70.355.2435.2 70.355.2435.3	70.356.2435.0 70.356.2435.1 70.356.2435.2 70.356.2435.3	70.357.2435.0 70.357.2435.1 70.357.2435.2 70.357.2435.3
70.353.2435.0 70.353.2435.1 70.353.2435.2 70.353.2435.3		70.354.2435.0 70.354.2435.1 70.354.2435.2 70.354.2435.3	70.358.2435.0 70.358.2435.1 70.358.2435.2 70.358.2435.3		70.359.2435.0 70.359.2435.1 70.359.2435.2 70.359.2435.3
70.350.3235.0 70.350.3235.1 70.350.3235.2 70.350.3235.3		70.352.3235.0 70.352.3235.1 70.352.3235.2 70.352.3235.3			
70.353.3235.1 70.353.3235.2		70.354.3235.1 70.354.3235.2			

Industrial Multipole Connectors

Housings with double locking levers

revos BASIC

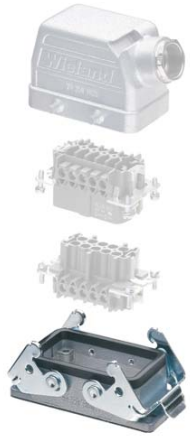

Housing type a

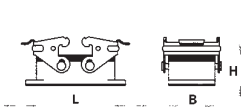

Housing type b

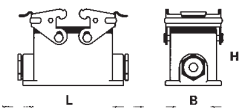

Housing type c

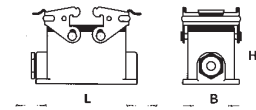

Housing type d

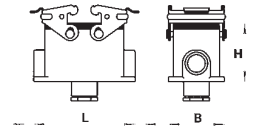

Housing type i

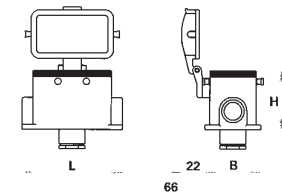

Housing open bottom

Housing type a



Housing closed bottom with two cable glands

Housing type b



Housing closed bottom with one cable gland on the left

Housing type c



Degree of protection IP 55
Degree of protection IP 65 with matching cable glands (see accessories)

For inserts: **600 V** UL/CSA

For inserts: **500 V** IEC 61 984

Number of poles	Thread	Gland type	L	W	H	Std. pack	Part no.	Part no.	Part no.
Size 10 for connector 10pole + ground	M 20	0 with cable gland	93	43	28	1	70.320.1028.0	70.330.1035.0	70.331.1035.0
		1 with threaded collar	94	52	54.5	1			
Size 16 for connector 16pole + ground	M 25	0 with cable gland	113	43	28	1	70.320.1628.0	70.330.1635.0	70.331.1635.0
		1 with threaded collar	117	52	56.5	1			
Size 16 for connector high design 16pole + ground	M 32	0 with cable gland	117	52	76.5	1	70.320.1628.0	73.334.4035.0	73.335.4035.0
		1 with threaded collar	117	52	76.5	1			
Size 24 for connector 24pole + ground	M 25	0 with cable gland	140	43	28	1	70.320.2428.0	70.330.2435.0	70.331.2435.0
		1 with threaded collar	144	52	56.5	1			
Size 24 for connector high design 24pole + ground	M 32	0 with cable gland	144	52	76.5	1	70.320.2428.0	73.334.6435.0	73.335.6435.0
		1 with threaded collar	144	52	76.5	1			
Size 32 for connector 32pole + ground			124	84	35	1	70.320.3228.0		

Mounting dimensions for open-bottom housings

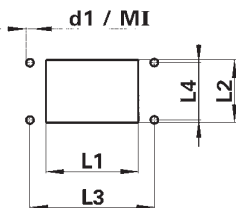

Housing size	Cut-out (mm)		Mounting holes (mm)		d1 (mm)	MI
	L1	L2	L3	L4		
10	65	35	83	32	4.3	M 4
16	85.5	35	103	32	4.3	M 4
24	112	35	130	32	4.3	M 4
32	117	81	148	70	6.4	M 6

revos

Housing type e

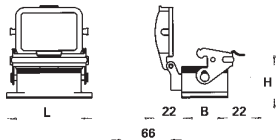

Housing type f

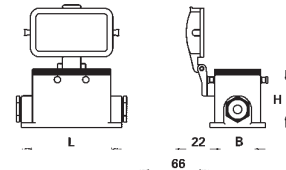

Housing type g

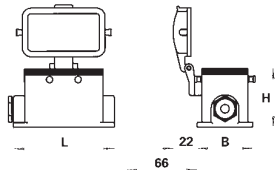

Housing type h

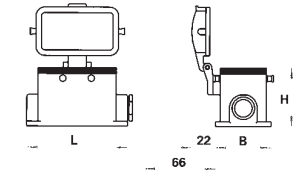

Housing closed bottom with cable gland at the bottom

Housing type d



Housing open bottom with protective cover

Housing type e



Housing closed bottom with two cable glands and protective cover

Housing type f



Housing closed bottom with cable gland on the left and protective cover

Housing type g



Housing closed bottom with cable gland on the right and protective cover

Housing type h



Housing closed bottom with cable gland at the bottom and protective cover

Housing type i



Part no.

70.333.1035.0
70.333.1035.1

Part no.

70.325.1028.0

Part no.

70.340.1035.0
70.340.1035.1

Part no.

70.341.1035.0
70.341.1035.1

Part no.

70.342.1035.0
70.342.1035.1

Part no.

70.343.1035.0
70.343.1035.1

70.333.1635.0
70.333.1635.1

70.325.1628.0

70.340.1635.0
70.340.1635.1

70.341.1635.0
70.341.1635.1

70.342.1635.0
70.342.1635.1

70.343.1635.0
70.343.1635.1

73.337.4035.0
73.337.4035.1

73.344.4035.0
73.344.4035.1

73.345.4035.0
73.345.4035.1

73.346.4035.0
73.346.4035.1

73.347.4035.0
73.347.4035.1

70.333.2435.0
70.333.2435.1

70.325.2428.0

70.340.2435.0
70.340.2435.1

70.341.2435.0
70.341.2435.1

70.342.2435.0
70.342.2435.1

70.343.2435.0
70.343.2435.1

73.337.6435.0
73.337.6435.1

73.344.6435.0
73.344.6435.1

73.345.6435.0
73.345.6435.1

73.346.6435.0
73.346.6435.1

73.347.6435.0
73.347.6435.1

Mounting dimensions
for closed-bottom
 housings

Housing size	L5 (mm)	L6 (mm)
10	82	40
16	105	45
24	132	45

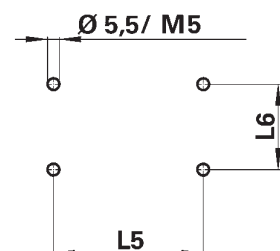

Industrial multipole connectors

revos BASIC

Technical information

■ Approvals	UL, CSA, MEEI, SEV
■ Applicable standards	IEC 61 984
■ Contact inserts	
Rated current	16 A
Rated voltage	690/400 V
Nominal voltage accord. to UL	600 V
Nominal voltage accord. to CSA	600 V
Pole configurations	3, 6, 10, 16, 20 (2x10), 26 (10/16), 32 (2x16) + ground
Screw connection	0.5 – 2.5 mm ² / 20 – 12 AWG
Degree of pollution	3
Temperature range	–40 to +110 °C
■ Multipole adapter	
Rated current	16 A
Rated voltage	500 V
Nominal voltage accord. to UL	600 V
Nominal voltage accord. to CSA	600 V
Pole configurations	3, 6, 10 + ground
Screw connection	0.5 – 4.0 mm ² / 20 – 12 AWG
Degree of pollution	3
Temperature range	–40 to +110 °C
■ Contacts	
Material	copper alloy
Surface	tin-plated
■ Hoods and housings	
Material	die cast aluminum alloy
Surface	silver gray, silicon-free finish
Locking levers	zinc-plated steel
Gaskets	NBR
Temperature range	–40 to +110 °C
Degree of protection accord. to DIN EN 60 529	
with latched locking levers	IP 55
with appropriate cable gland	IP 65



Industrial Multipole Connectors

Industrial Multipole Connectors

Female/male inserts and multipole adapter

revos BASIC

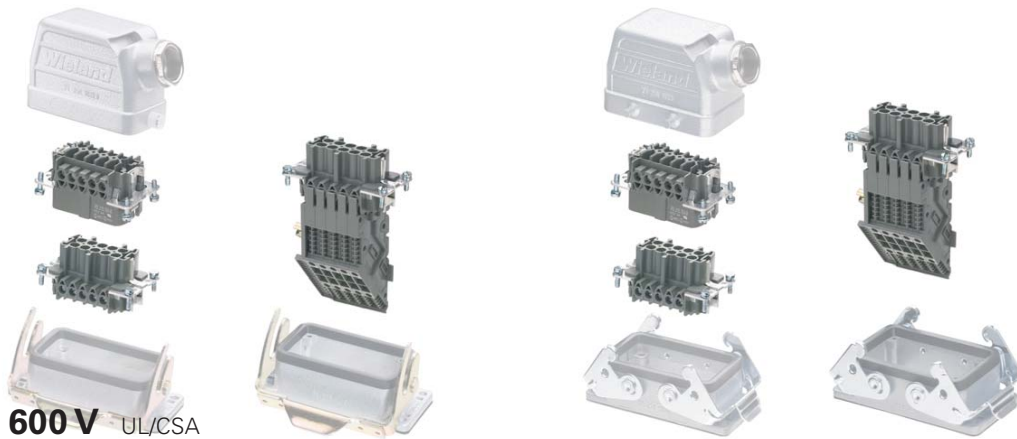

600 V UL/CSA

690/400 V, 16 A IEC 61 984

		Rated current	Cross section	Approvals	Wire strip length	Contacts	Std. pack
 <p>Screw connection</p>	Female insert	16 A	0.5 – 2.5 mm ² 20 – 12 AWG		7 mm	tin-plated	10
	Male insert	16 A	0.5 – 2.5 mm ² 20 – 12 AWG		7 mm	tin-plated	10
 <p>Screw connection Multipole adapter long design (6 marking fields)</p>	Female insert, ground right 500 V IEC 61 984	16 A	0.5 – 4 mm ² 20 – 12 AWG		12 mm	tin-plated	10
	Female insert, ground left	16 A	0.5 – 4 mm ² 20 – 12 AWG		12 mm	tin-plated	10
	Male insert, ground right 500 V IEC 61 984	16 A	0.5 – 4 mm ² 20 – 12 AWG		12 mm	tin-plated	10
	Male insert, ground left	16 A	0.5 – 4 mm ² 20 – 12 AWG		12 mm	tin-plated	10
 <p>Screw connection Multipole adapter short design (4 marking fields)</p>	Female insert, ground right 500 V IEC 61 984	16 A	0.5 – 4 mm ² 20 – 12 AWG		12 mm	tin-plated	10
	Female insert, ground left	16 A	0.5 – 4 mm ² 20 – 12 AWG		12 mm	tin-plated	10
	Male insert, ground right 500 V IEC 61 984	16 A	0.5 – 4 mm ² 20 – 12 AWG		12 mm	tin-plated	10
	Male insert, ground left	16 A	0.5 – 4 mm ² 20 – 12 AWG		12 mm	tin-plated	10
 <p>Spring connection Multipole adapter short design (6 marking fields)</p>	Female insert, ground right 500 V IEC 61 984	16 A	0.5 – 2.5 mm ² 20 – 12 AWG		9 mm	tin-plated	10
	Female insert, ground left	16 A	0.5 – 2.5 mm ² 20 – 12 AWG		9 mm	tin-plated	10
	Male insert, ground right 500 V IEC 61 984	16 A	0.5 – 2.5 mm ² 20 – 12 AWG		9 mm	tin-plated	10
	Male insert, ground left	16 A	0.5 – 2.5 mm ² 20 – 12 AWG		9 mm	tin-plated	10

revos

3pole + ground	6pole + ground	10pole + ground	16pole + ground	20pole + ground 2 x 10pole + ground	26pole + ground 1 x 10pole + ground 1 x 16pole + ground	32pole + ground 2 x 16pole + ground
Part no.	Part no.	Part no.	Part no.	Part no.	Part no.	Part no.
70.400.0340.0	70.400.0640.0	70.400.1040.0	70.400.1640.0	70.400.2040.0	70.400.2640.0	70.400.3240.0
70.410.0340.0	70.410.0640.0	70.410.1040.0	70.410.1640.0	70.410.2040.0	70.410.2640.0	70.410.3240.0

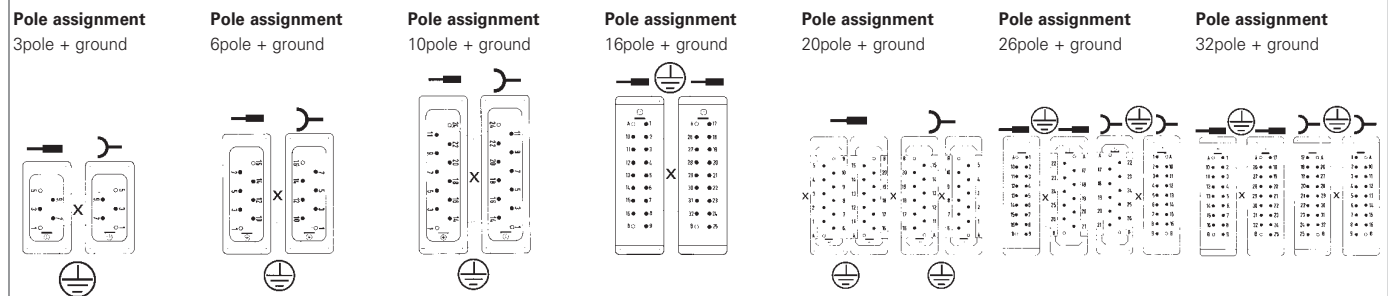

X = switching contacts (2 shortened male pins)

70.125.0353.3	70.125.0653.3	70.125.1053.3	
70.120.0353.3	70.120.0653.3	70.120.1053.3	
70.135.0353.3	70.135.0653.3	70.135.1053.3	
70.130.0353.3	70.130.0653.3	70.130.1053.3	
70.125.0353.4	70.125.0653.4	70.125.1053.4	
70.120.0353.4	70.120.0653.4	70.120.1053.4	
70.135.0353.4	70.135.0653.4	70.135.1053.4	
70.130.0353.4	70.130.0653.4	70.130.1053.4	
70.126.0353.0	70.126.0653.0	70.126.1053.0	
70.121.0353.0	70.121.0653.0	70.121.1053.0	
70.136.0353.0	70.136.0653.0	70.136.1053.0	
70.131.0353.0	70.131.0653.0	70.131.1053.0	



Industrial Multipole Connectors Hoods with a single locking lever

revos BASIC

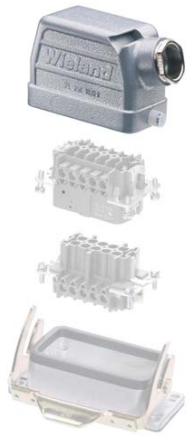

Hood type A

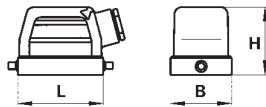

Hood type B

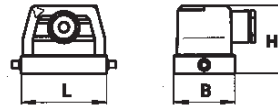

Hood type C

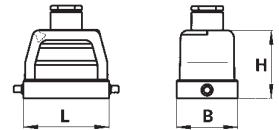

Degree of protection IP 55

Degree of protection IP 65 with matching cable glands (see accessories)

For inserts: **600 V** UL/CSA

For inserts: **690/400 V** IEC 61 984

Number of poles	Thread	Gland type	Dimensions in mm	L	W	H	Std. pack
Size 10 for connector 3pole + ground	M 20	0 with cable gland 1 with threaded collar 2 with intermediate support 3 with strain relief		73	43	53	1
	M 25	0 with cable gland 1 with threaded collar 2 with intermediate support 3 with strain relief		73	43	53	
Size 16 for connector 6pole + ground	M 25	0 with cable gland 1 with threaded collar 2 with intermediate support 3 with strain relief		93.5	43	60	1
	M 32	0 with cable gland 1 with threaded collar 2 with intermediate support 3 with strain relief		93.5	43	60	
Size 24 for connector 10-/ 16pole + ground	M 25	0 with cable gland 1 with threaded collar 2 with intermediate support 3 with strain relief		120	43	70	1
	M 32	0 with cable gland 1 with threaded collar 2 with intermediate support 3 with strain relief		120	43	70	
Size 48 for connector 20-/26-/ 32pole + ground	M 32	0 with cable gland 1 with threaded collar 2 with intermediate support 3 with strain relief		132	90	107	1
	M 40	1 with threaded collar 2 with intermediate support		132	90	107	1

revos

Hood	Hood for 24pole = 2 x M 25	Hood	
Hood type A	Hood type B	Hood type C	
			
Part no.	Part no.	Part no.	
77.350.1035.0 77.350.1035.1 77.350.1035.2 77.350.1035.3	77.351.1035.0 77.351.1035.1 77.351.1035.2 77.351.1035.3	77.352.1035.0 77.352.1035.1 77.352.1035.2 77.352.1035.3	
77.353.1035.0 77.353.1035.1 77.353.1035.2 77.353.1035.3		77.354.1035.0 77.354.1035.1 77.354.1035.2 77.354.1035.3	
77.350.1635.0 77.350.1635.1 77.350.1635.2 77.350.1635.3	77.351.1635.0 77.351.1635.1 77.351.1635.2 77.351.1635.3	77.352.1635.0 77.352.1635.1 77.352.1635.2 77.352.1635.3	
77.353.1635.0 77.353.1635.1 77.353.1635.2 77.353.1635.3		77.354.1635.0 77.354.1635.1 77.354.1635.2 77.354.1635.3	
77.350.2435.0 77.350.2435.1 77.350.2435.2 77.350.2435.3	77.351.2435.0 77.351.2435.1 77.351.2435.2 77.351.2435.3	77.352.2435.0 77.352.2435.1 77.352.2435.2 77.352.2435.3	
77.353.2435.0 77.353.2435.1 77.353.2435.2 77.353.2435.3		77.354.2435.0 77.354.2435.1 77.354.2435.2 77.354.2435.3	
70.350.4835.0 70.350.4835.1 70.350.4835.2 70.350.4835.3		70.352.4835.0 70.352.4835.1 70.352.4835.2 70.352.4835.3	
70.353.4835.1 70.353.4835.2		70.354.4835.1 70.354.4835.2	

Industrial Multipole Connectors

Housings with a single locking lever

revos BASIC

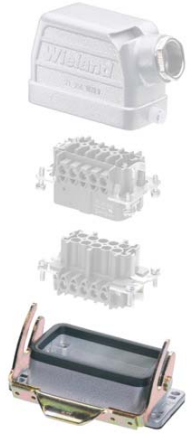

Housing type a

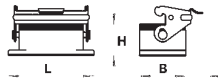

Housing type b

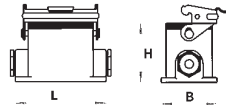

Housing type c

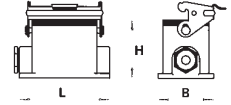

Housing type d

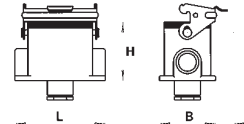

Housing type i

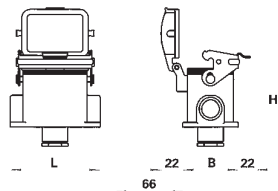

Housing open bottom

Housing type a



Housing closed bottom with two cable glands

Housing type b



Housing closed bottom with one cable gland on the left

Housing type c



Degree of protection IP 55

Degree of protection IP 65 with matching cable glands (see accessories)

For inserts: **600 V** UL/CSA

For inserts: **690/400 V** IEC 61 984

Number of poles	Thread	Gland type	L	W	H	Std. pack	Part no.	Part no.	Part no.
Size 10 for connector 3pole + ground	M 20	0 with cable gland	93	43	28	1	77.320.1028.0	77.330.1035.0	77.331.1035.0
		1 with threaded collar	94	52	54.5	1			
Size 16 for connector 6pole + ground	M 25	0 with cable gland	113	43	28	1	77.320.1628.0	77.330.1635.0	77.331.1635.0
		1 with threaded collar	117	52	56.5	1			
Size 24 for connector 10pole + ground/ 16pole + ground	M 25	0 with cable gland	140	43	28	1	77.320.2428.0	77.330.2435.0	77.331.2435.0
		1 with threaded collar	144	52	56.5	1			
Size 48 for connector 20-/26-/ 32pole + ground	M32	0 with cable gland	165	90	44	1	70.320.4828.0		70.331.4835.0
		1 with threaded collar	146	120	99	1			
	M40	1 with threaded collar	146	120	99	1			70.331.4835.3

Mounting dimensions for open-bottom housings

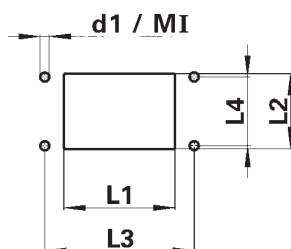

Housing size	Cut-out (mm)		Mounting holes (mm)		d1 (mm)	MI
	L1	L2	L3	L4		
10	65	35	83	32	4.3	M 4
16	85.5	35	103	32	4.3	M 4
24	112	35	130	32	4.3	M 4
48	117	81	148	70	6.4	M 6

revos

Housing type e

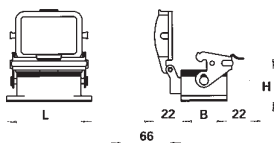

Housing type f

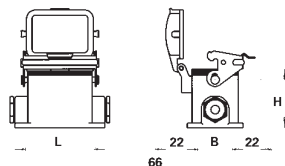

Housing type g

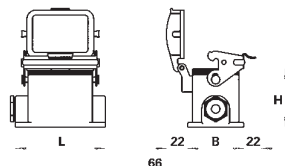

Housing type h

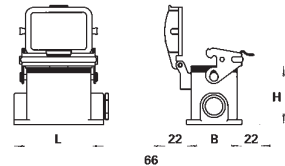

Housing closed bottom with cable gland at the bottom

Housing type d



Housing open bottom with protective cover

Housing type e



Housing closed bottom with two cable glands and protective cover

Housing type f



Housing closed bottom with cable gland on the left and protective cover

Housing type g



Housing closed bottom with cable gland on the right and protective cover

Housing type h



Housing closed bottom with cable gland at the bottom and protective cover

Housing type i



Part no.	Part no.	Part no.	Part no.	Part no.	Part no.
77.333.1035.0 77.333.1035.1	77.325.1028.0	77.340.1035.0 77.340.1035.1	77.341.1035.0 77.341.1035.1	77.342.1035.0 77.342.1035.1	77.343.1035.0 77.343.1035.1
77.333.1635.0 77.333.1635.1	77.325.1628.0	77.340.1635.0 77.340.1635.1	77.341.1635.0 77.341.1635.1	77.342.1635.0 77.342.1635.1	77.343.1635.0 77.343.1635.1
77.333.2435.0 77.333.2435.1	77.325.2428.0	77.340.2435.0 77.340.2435.1	77.341.2435.0 77.341.2435.1	77.342.2435.0 77.342.2435.1	77.343.2435.0 77.343.2435.1
	70.325.4828.0		70.341.4835.1 70.341.4835.3		
			70.344.4835.1		

Mounting dimensions for closed-bottom housings

Housing size	L5 (mm)	L6 (mm)	d2 (mm)	MII
10	82	40	5.5	M 5
16	105	45	5.5	M 5
24	132	45	5.5	M 5
48	111	106	6.5	M 6

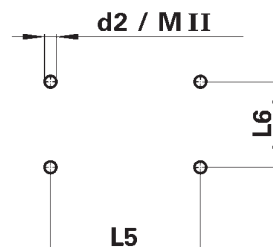

Industrial Multipole Connectors Hoods with double locking levers

revos BASIC



Hood type A

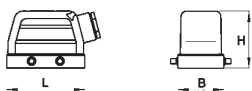

Hood type B



Hood type C



Degree of protection IP 55

Degree of protection IP 65 with matching cable glands

For inserts: **600 V** UL/CSA

For inserts: **690/400 V** IEC 61 984

Number of poles	Thread	Gland type	Dimensions in mm	L	W	H	Std. pack
Size 10 for connector 3pole + ground	M 20	0 with cable gland 1 with threaded collar 2 with intermediate support 3 with strain relief		73	43	53	1
	M 25	0 with cable gland 1 with threaded collar 2 with intermediate support 3 with strain relief		73	43	53	
Size 16 for connector 6pole + ground	M 25	0 with cable gland 1 with threaded collar 2 with intermediate support 3 with strain relief		93.5	43	60	1
	M 32	0 with cable gland 1 with threaded collar 2 with intermediate support 3 with strain relief		93.5	43	60	
Size 24 for connector 10-/ 16pole + ground	M 25	0 with cable gland 1 with threaded collar 2 with intermediate support 3 with strain relief		120	43	70	1
	M 32	0 with cable gland 1 with threaded collar 2 with intermediate support 3 with strain relief		120	43	70	1

revos

Hood type D

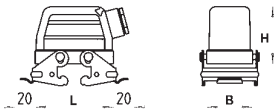

Hood type E

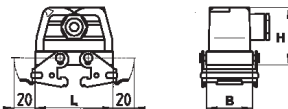

Hood type F

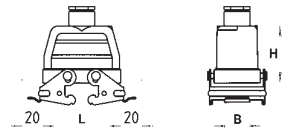

Hood type A	Hood type B	Hood type C	Hood type D	Hood type E	Hood type F
					
Part no.	Part no.	Part no.	Part no.	Part no.	Part no.
72.350.1035.0 72.350.1035.1 72.350.1035.2 72.350.1035.3	72.351.1035.0 72.351.1035.1 72.351.1035.2 72.351.1035.3	72.352.1035.0 72.352.1035.1 72.352.1035.2 72.352.1035.3	72.355.1035.0 72.355.1035.1 72.355.1035.2 72.355.1035.3	72.356.1035.0 72.356.1035.1 72.356.1035.2 72.356.1035.3	72.357.1035.0 72.357.1035.1 72.357.1035.2 72.357.1035.3
72.353.1035.0 72.353.1035.1 72.353.1035.2 72.353.1035.3		72.354.1035.0 72.354.1035.1 72.354.1035.2 72.354.1035.3	72.358.1035.0 72.358.1035.1 72.358.1035.2 72.358.1035.3		72.359.1035.0 72.359.1035.1 72.359.1035.2 72.359.1035.3
72.350.1635.0 72.350.1635.1 72.350.1635.2 72.350.1635.3	72.351.1635.0 72.351.1635.1 72.351.1635.2 72.351.1635.3	72.352.1635.0 72.352.1635.1 72.352.1635.2 72.352.1635.3	72.355.1635.0 72.355.1635.1 72.355.1635.2 72.355.1635.3	72.356.1635.0 72.356.1635.1 72.356.1635.2 72.356.1635.3	72.357.1635.0 72.357.1635.1 72.357.1635.2 72.357.1635.3
72.353.1635.0 72.353.1635.1 72.353.1635.2 72.353.1635.3		72.354.1635.0 72.354.1635.1 72.354.1635.2 72.354.1635.3	72.358.1635.0 72.358.1635.1 72.358.1635.2 72.358.1635.3		72.359.1635.0 72.359.1635.1 72.359.1635.2 72.359.1635.3
72.350.2435.0 72.350.2435.1 72.350.2435.2 72.350.2435.3	72.351.2435.0 72.351.2435.1 72.351.2435.2 72.351.2435.3	72.352.2435.0 72.352.2435.1 72.352.2435.2 72.352.2435.3	72.355.2435.0 72.355.2435.1 72.355.2435.2 72.355.2435.3	72.356.2435.0 72.356.2435.1 72.356.2435.2 72.356.2435.3	72.357.2435.0 72.357.2435.1 72.357.2435.2 72.357.2435.3
72.353.2435.0 72.353.2435.1 72.353.2435.2 72.353.2435.3		72.354.2435.0 72.354.2435.1 72.354.2435.2 72.354.2435.3	72.358.2435.0 72.358.2435.1 72.358.2435.2 72.358.2435.3		72.359.2435.0 72.359.2435.1 72.359.2435.2 72.359.2435.3

Industrial Multipole Connectors Housings with double locking levers

revos BASIC

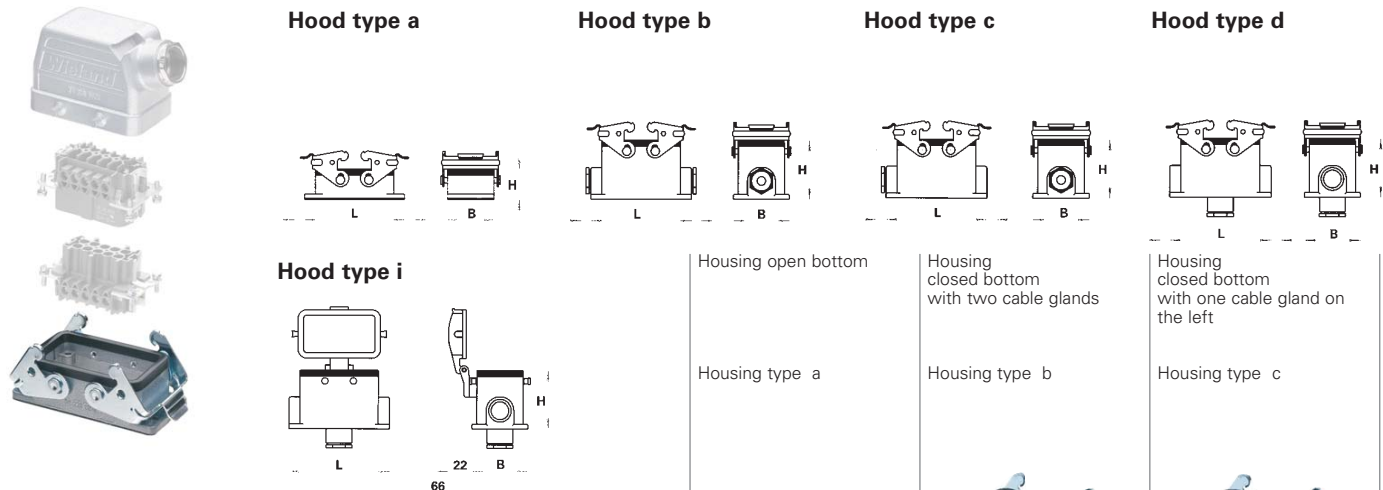

Degree of protection IP 55
Degree of protection IP 65 with matching cable glands (see accessories)
 For inserts: **600 V** UL/CSA
 For inserts: **690/400 V** IEC 61 984

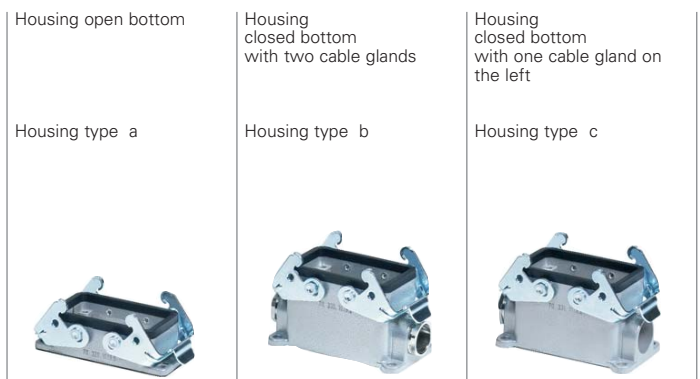

Number of poles	Thread	Gland type	L	W	H	Std. pack	Part no.	Part no.	Part no.
Size 10 for connector 3pole + ground	M 20	0 with cable gland	93	43	28	1	72.320.1028.0	72.330.1035.0	72.331.1035.0
		1 with threaded collar	94	52	54.5	1			
Size 16 for connector 6pole + ground	M 25	0 with cable gland	113	43	28	1	72.320.1628.0	72.330.1635.0	72.331.1635.0
		1 with threaded collar	117	52	56.5	1			
Size 24 for connector 10-/ 16pole + ground	M 25	0 with cable gland	140	43	28	1	72.320.2428.0	72.330.2435.0	72.331.2435.0
		1 with threaded collar	144	52	56.5	1			

Mounting dimensions for
open-bottom housings

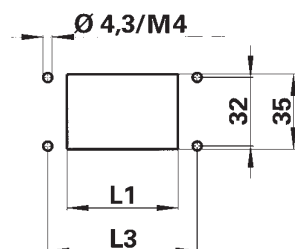

Housing size	L1 (mm)	L3 (mm)
10	65	83
16	85.5	103
24	112	130

revos

Hood type e

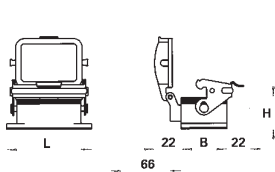

Hood type f

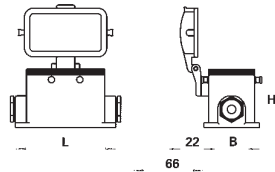

Hood type g

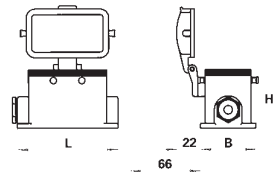

Hood type h

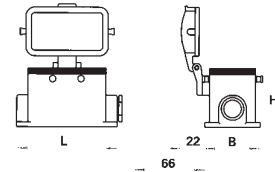

Housing closed bottom with cable gland at the bottom

Housing type d



Housing open bottom with protective cover

Housing type e



Housing closed bottom with two cable glands and protective cover

Housing type f



Housing closed bottom with cable gland on the left and protective cover

Housing type g



Housing closed bottom with cable gland on the right and protective cover

Housing type h



Housing closed bottom with cable gland at the bottom and protective cover

Housing type i



Part no.	Part no.	Part no.	Part no.	Part no.	Part no.
72.333.1035.0 72.333.1035.1	72.325.1028.0	72.340.1035.0 72.340.1035.1	72.341.1035.0 72.341.1035.1	72.342.1035.0 72.342.1035.1	72.343.1035.0 72.343.1035.1
72.333.1635.0 72.333.1635.1	72.325.1628.0	72.340.1635.0 72.340.1635.1	72.341.1635.0 72.341.1635.1	72.342.1635.0 72.342.1635.1	72.343.1635.0 72.343.1635.1
72.333.2435.0 72.333.2435.1	72.325.2428.0	72.340.2435.0 72.340.2435.1	72.341.2435.0 72.341.2435.1	72.342.2435.0 72.342.2435.1	72.343.2435.0 72.343.2435.1

Mounting dimensions for closed-bottom housings

Housing size	L5 (mm)	L6 (mm)
10	82	40
16	105	45
24	132	45

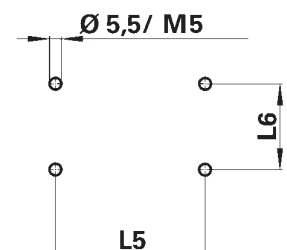

Industrial multipole connectors

revos BASIC

Technical information

■ Approvals	UL, CSA, MEEI, SEV
■ Applicable standards	IEC 61 984
■ Contact inserts	
Rated current	16 A
Rated voltage	690 V
Nominal voltage accord. to UL	600 V
Nominal voltage accord. to CSA	600 V
Pole configurations	6-, 10-, 16-, 24-, 32 (2x16), 48 (2x24), + ground
Screw connection	0.5 – 2.5 mm ² / 20 – 12 AWG
Crimp connection	0.5 – 4.0 mm ² / 20 – 12 AWG
Degree of pollution	3
Temperature range	–40 to +110 °C
■ Multipole adapter	
Rated current	16 A
Rated voltage	500 V
Nominal voltage accord. to UL	600 V
Nominal voltage accord. to CSA	600 V
Pole configurations	6, 10, 16, 24, + ground
Screw connection	0.5 – 4.0 mm ² / 20 – 12 AWG
Spring connection	0.5 – 2.5 mm ² / 20 – 12 AWG
Degree of pollution	3
Temperature range	–40 to +110 °C
■ Contacts	
Material	copper alloy
Surface (screw, crimp, multipole adapter contacts)	tin-plated
Surface (crimp contacts)	gold-plated
Surface (crimp contacts)	silver-plated
■ Hoods and housings	
Material	die cast aluminum alloy
Surface	silver gray, silicon-free finish
Locking levers	zinc-plated steel
Gaskets	NBR
Temperature range	–40 to +110 °C
Degree of protection accord. to DIN EN 60 529	
with latched locking levers	IP 55
with appropriate cable gland	IP 65



Industrial Multipole Connectors

revos

Industrial Multipole Connectors

Female/male inserts and multipole adapter

revos BASIC

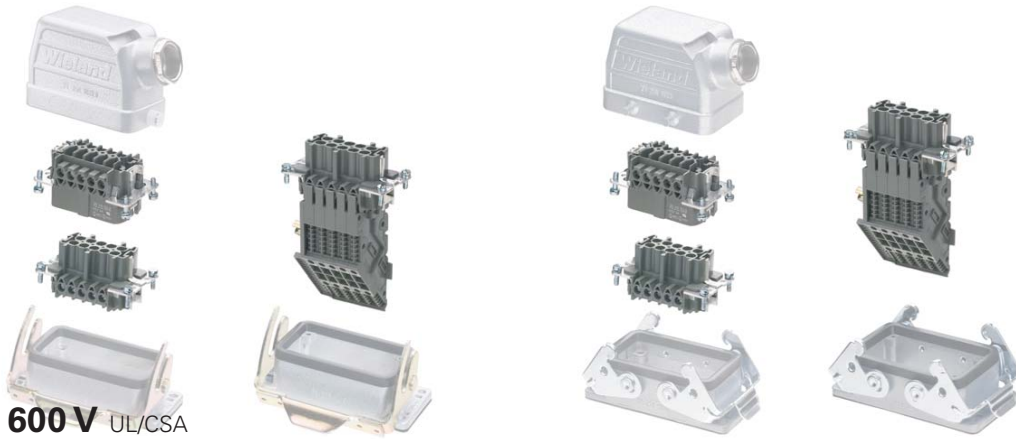

600 V UL/CSA
690 V, 16 A IEC 61 984

		Rated current	Cross section	Approvals	Wire strip length	Contacts	Std. pack
 Screw connection 	Female insert	16 A	0.5 – 2.5 mm ² 20 – 12 AWG	UL, CSA, CE	7 mm	tin-plated	10
	Male insert	16 A	0.5 – 2.5 mm ² 20 – 12 AWG	UL, CSA, CE	7 mm	tin-plated	10
 Crimp connection 	Female insert without crimp contacts	16 A	0.5 – 4 mm ² 20 – 12 AWG	CE	7 mm	tin-plated	10
	Male insert without crimp contacts	16 A	0.5 – 4 mm ² 20 – 12 AWG	CE	7 mm	tin-plated	10
 Screw connection Multipole adapter long design (6 marking fields)	Female insert, ground right	16 A/500 V	0.5 – 4 mm ² 20 – 12 AWG	UL, CSA, CE	12 mm	tin-plated	10
	Female insert, ground left	16 A/500 V	0.5 – 4 mm ² 20 – 12 AWG	UL, CSA, CE	12 mm	tin-plated	10
	Male insert, ground right	16 A/500 V	0.5 – 4 mm ² 20 – 12 AWG	UL, CSA, CE	12 mm	tin-plated	10
	Male insert, ground left	16 A/500 V	0.5 – 4 mm ² 20 – 12 AWG	UL, CSA, CE	12 mm	tin-plated	10
 Screw connection Multipole adapter short design (4 marking fields)	Female insert, ground right	16 A/500 V	0.5 – 4 mm ² 20 – 12 AWG	UL, CSA, CE	12 mm	tin-plated	10
	Female insert, ground left	16 A/500 V	0.5 – 4 mm ² 20 – 12 AWG	UL, CSA, CE	12 mm	tin-plated	10
	Male insert, ground right	16 A/500 V	0.5 – 4 mm ² 20 – 12 AWG	UL, CSA, CE	12 mm	tin-plated	10
	Male insert, ground left	16 A/500 V	0.5 – 4 mm ² 20 – 12 AWG	UL, CSA, CE	12 mm	tin-plated	10
 Spring connection Multipole adapter short design (6 marking fields)	Female insert, ground right	16 A/500 V	0.5 – 2.5 mm ² 20 – 12 AWG	UL, CSA	9 mm	tin-plated	10
	Female insert, ground left	16 A/500 V	0.5 – 2.5 mm ² 20 – 12 AWG	UL, CSA	9 mm	tin-plated	10
	Male insert, ground right	16 A/500 V	0.5 – 2.5 mm ² 20 – 12 AWG	UL, CSA	9 mm	tin-plated	10
	Male insert, ground left	16 A/500 V	0.5 – 2.5 mm ² 20 – 12 AWG	UL, CSA	9 mm	tin-plated	10

revos

Contacts for crimp version

Female contacts



Male contacts



gold-plated and silver-plated
upon request

Crimping tool
Crimping die „B“
Contact positioner „3“
Extraction tool

Cross section mm ²	Part no.	Std. pack	Cross section mm ²	Part no.	Std. pack
		tin-plated			
0.5	20 AWG	02.123.7021.0	200		
0.75 – 1	18 AWG	02.123.7121.0	200		
1.5	16 AWG	02.123.7221.0	200		
2.5	14 AWG	02.123.7321.0	200		
4	12 AWG	02.123.7421.0	200		
		Male switching contact (2 pcs. required)			
0.5	20 AWG	05.543.9021.0	200		
0.75 – 1	18 AWG	05.543.9121.0	200		
1.5	16 AWG	05.543.9221.0	200		
2.5	14 AWG	05.543.9321.0	200		
4	12 AWG	05.543.9421.0	200		
		95.101.0800.0	1		
		05.502.2100.0	1		
		05.502.3300.0	1		
		05.502.3500.0			

6pole + ground	10pole + ground	16pole + ground	24pole + ground	32pole + ground	48pole + ground
				2 inserts 1 – 16 poles 17 – 32 poles	2 inserts 1 – 24 poles 25 – 48 poles
Part no.	Part no.	Part no.	Part no.	Part no.	Part no.
72.300.0653.0	72.300.1053.0	72.300.1653.0	72.300.2453.0	72.300.3253.0	72.300.4853.0
72.310.0653.0	72.310.1053.0	72.310.1653.0	72.310.2453.0	72.310.3253.0	72.310.4853.0
72.700.0658.0	72.700.1058.0	72.700.1658.0	72.700.2458.0	72.700.3258.0	72.700.4858.0
72.710.0658.0	72.710.1058.0	72.710.1658.0	72.710.2458.0	72.710.3258.0	72.710.4858.0

Pole assignment
6pole + ground

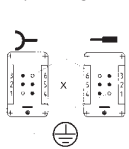

Pole assignment
10pole + ground

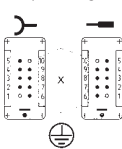

Pole assignment 16pole
+ ground

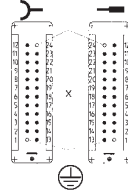
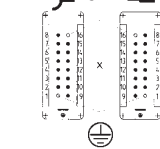

Pole assignment
24pole + ground

X = switching contacts (2 shortened male pins)

32pole: additional switching contacts 17 + 32
48pole: additional switching contacts 25 + 48

72.105.0653.0	72.105.1053.0	72.105.1653.0	72.105.2453.0	
72.100.0653.0	72.100.1053.0	72.100.1653.0	72.100.2453.0	
72.115.0653.0	72.115.1053.0	72.115.1653.0	72.115.2453.0	
72.110.0653.0	72.110.1053.0	72.110.1653.0	72.110.2453.0	
72.105.0653.4	72.105.1053.4	72.105.1653.4	72.105.2453.4	
72.100.0653.4	72.100.1053.4	72.100.1653.4	72.100.2453.4	
72.115.0653.4	72.115.1053.4	72.115.1653.4	72.115.2453.4	
72.110.0653.4	72.110.1053.4	72.110.1653.4	72.110.2453.4	
72.106.0653.0	72.106.1053.0	72.106.1653.0	72.106.2453.0	
72.101.0653.0	72.101.1053.0	72.101.1653.0	72.101.2453.0	
72.116.0653.0	72.116.1053.0	72.116.1653.0	72.116.2453.0	
72.111.0653.0	72.111.1053.0	72.111.1653.0	72.111.2453.0	

Industrial Multipole Connectors Hoods with a single locking lever

revos BASIC



Hood type A

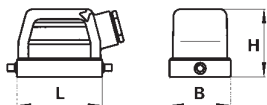

Hood type B



Hood type C

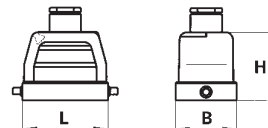

Degree of protection IP 55

Degree of protection IP 65 with matching cable glands (see accessories)

For inserts: **600 V** UL/CSA

For inserts: **690 V** IEC 61 984

Number of poles	Thread	Gland type	Dimensions in mm	L	W	H	Std. pack
Size 6 for connector 6pole + ground	M 20	0 with cable gland 1 with threaded collar 2 with intermediate support 3 with strain relief		60	43	47.5	1
	M 25	0 with cable gland 1 with threaded collar 2 with intermediate support 3 with strain relief		60	43	47.5	
Size 10 for connector 10pole + ground	M 20	0 with cable gland 1 with threaded collar 2 with intermediate support 3 with strain relief		73	43	53	1
	M 25	0 with cable gland 1 with threaded collar 2 with intermediate support 3 with strain relief		73	43	53	
Size 16 for connector 16pole + ground	M 25	0 with cable gland 1 with threaded collar 2 with intermediate support 3 with strain relief		93,5	43	60	1
	M 32	0 with cable gland 1 with threaded collar 2 with intermediate support 3 with strain relief		93,5	43	60	
Size 24 for connector 24pole + ground	M 25	0 with cable gland 1 with threaded collar 2 with intermediate support 3 with strain relief		120	43	70	1
	M 32	0 with cable gland 1 with threaded collar 2 with intermediate support 3 with strain relief		120	43	70	
Size 48 for connector 48pole + ground	M32	0 with cable gland 1 with threaded collar 2 with intermediate support 3 with strain relief		132	90	107	1
	M40	1 with threaded collar 2 with intermediate support		132	90	107	1

revos

Hood	Hood for 24pole = 2 x M 25	Hood	
Hood type A	Hood type B	Hood type C	
			
Part no.	Part no.	Part no.	
72.350.0635.0 72.350.0635.1 72.350.0635.2 72.350.0635.3	72.351.0635.0 72.351.0635.1 72.351.0635.2 72.351.0635.3	72.352.0635.0 72.352.0635.1 72.352.0635.2 72.352.0635.3	
72.353.0635.0 72.353.0635.1 72.353.0635.2 72.353.0635.3		72.354.0635.0 72.354.0635.1 72.354.0635.2 72.354.0635.3	
77.350.1035.0 77.350.1035.1 77.350.1035.2 77.350.1035.3	77.351.1035.0 77.351.1035.1 77.351.1035.2 77.351.1035.3	77.352.1035.0 77.352.1035.1 77.352.1035.2 77.352.1035.3	
77.353.1035.0 77.353.1035.1 77.353.1035.2 77.353.1035.3		77.354.1035.0 77.354.1035.1 77.354.1035.2 77.354.1035.3	
77.350.1635.0 77.350.1635.1 77.350.1635.2 77.350.1635.3	77.351.1635.0 77.351.1635.1 77.351.1635.2 77.351.1635.3	77.352.1635.0 77.352.1635.1 77.352.1635.2 77.352.1635.3	
77.353.1635.0 77.353.1635.1 77.353.1635.2 77.353.1635.3		77.354.1635.0 77.354.1635.1 77.354.1635.2 77.354.1635.3	
77.350.2435.0 77.350.2435.1 77.350.2435.2 77.350.2435.3	77.351.2435.0 77.351.2435.1 77.351.2435.2 77.351.2435.3	77.352.2435.0 77.352.2435.1 77.352.2435.2 77.352.2435.3	
77.353.2435.0 77.353.2435.1 77.353.2435.2 77.353.2435.3		77.354.2435.0 77.354.2435.1 77.354.2435.2 77.354.2435.3	
70.350.4835.0 70.350.4835.1 70.350.4835.2 70.350.4835.3		70.352.4835.0 70.352.4835.1 70.352.4835.2 70.352.4835.3	
70.353.4835.1 70.353.4835.2		70.354.4835.1 70.354.4835.2	

Industrial Multipole Connectors

Housings with a single locking lever

revos BASIC

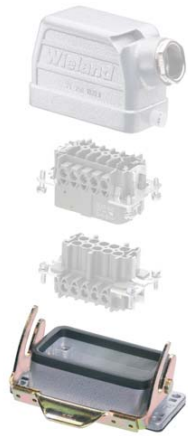

Housing type a

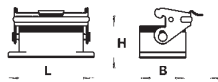

Housing type b

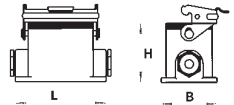

Housing type c

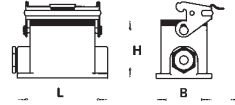

Housing type d

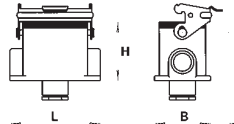

Housing type i

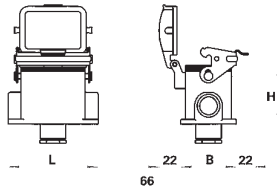

Housing open bottom

Housing type a



Housing closed bottom with two cable glands

Housing type b



Housing closed bottom with one cable gland on the left

Housing type c



Degree of protection IP 55

Degree of protection IP 65 with matching cable glands

For inserts: **600 V** UL/CSA

For inserts: **690 V** IEC 61 984

Number of poles	Thread	Gland type	L	W	H	Std. pack	Part no.	Part no.	Part no.	
Size 6 for connector 6pole + ground	M 20	0 with cable gland	80	43	28	1	72.320.0628.0	72.330.0635.0	72.331.0635.0	
		1 with threaded collar	84	52	54.5	1				72.330.0635.1
Size 10 for connector 10pole + ground	M 20	0 with cable gland	93	43	28	1	77.320.1028.0	77.330.1035.0	77.331.1035.0	
		1 with threaded collar	94	52	54.5	1				77.330.1035.1
Size 16 for connector 16pole + ground	M 25	0 with cable gland	113	43	28	1	77.320.1628.0	77.330.1635.0	77.331.1635.0	
		1 with threaded collar	117	52	56.5	1				77.330.1635.1
Size 24 for connector 24pole + ground	M25	0 with cable gland	140	43	28	1	77.320.2428.0	77.330.2435.0	77.331.2435.0	
		1 with threaded collar	144	52	56.5	1				77.330.2435.1
Size 48 for connector 48pole + ground	M32	0 with cable gland	165	90	44	1	70.320.4828.0		70.331.4835.0	
		1 with threaded collar	146	120	99	1				70.331.4835.1
		3 with strain relief	146	120	99	1				70.331.4835.3
	M 40	1 with threaded collar	146	120	99	1				

Mounting dimensions for open-bottom housings

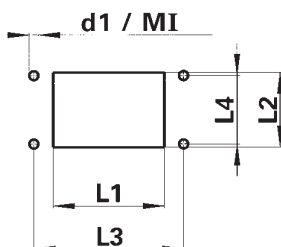

Housing size	Cut-out (mm)		Mounting holes (mm)		d1 (mm)	MI
	L1	L2	L3	L4		
6	52	35	70	32	4.3	M 4
10	65	35	83	32	4.3	M 4
16	85.5	35	103	32	4.3	M 4
24	112	35	130	32	4.3	M 4
48	117	81	148	70	6.4	M 6

revos

Housing type e

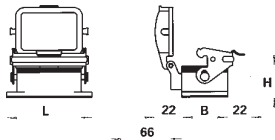

Housing type f

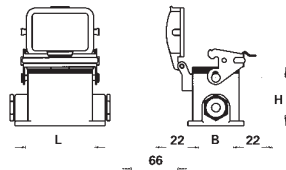

Housing type g

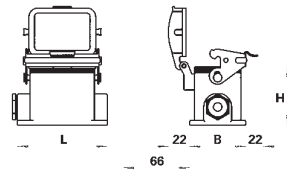

Housing type h

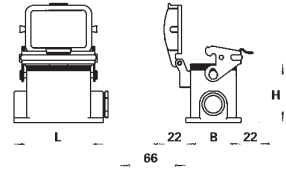

Housing closed bottom with cable gland at the bottom

Housing type d



Housing open bottom with protective cover

Housing type e



Housing closed bottom with two glands and protective cover

Housing type f



Housing closed bottom with cable gland on the left and protective cover

Housing type g



Housing closed bottom with cable gland on the right and protective cover

Housing type h



Housing closed bottom with cable gland at the bottom and protective cover

Housing type i



Part no.	Part no.	Part no.	Part no.	Part no.	Part no.
72.333.0635.0 72.333.0635.1	72.325.0628.0	72.340.0635.0 72.340.0635.1	72.341.0635.0 72.341.0635.1	72.342.0635.0 72.342.0635.1	72.343.0635.0 72.343.0635.1
77.333.1035.0 77.333.1035.1	77.325.1028.0	77.340.1035.0 77.340.1035.1	77.341.1035.0 77.341.1035.1	77.342.1035.0 77.342.1035.1	77.343.1035.0 77.343.1035.1
77.333.1635.0 77.333.1635.1	77.325.1628.0	77.340.1635.0 77.340.1635.1	77.341.1635.0 77.341.1635.1	77.342.1635.0 77.342.1635.1	77.343.1635.0 77.343.1635.1
77.333.2435.0 77.333.2435.1	77.325.2428.0	77.340.2435.0 77.340.2435.1	77.341.2435.0 77.341.2435.1	77.342.2435.0 77.342.2435.1	77.343.2435.0 77.343.2435.1
	70.325.4828.0		70.341.4835.1 70.341.4835.3		
			70.344.4835.1		

Mounting dimensions for closed-bottom housings

Mounting size	L5 (mm)	L6 (mm)	d2 (mm)	MII
6	70	40	5.5	M 5
10	82	40	5.5	M 5
16	105	45	5.5	M 5
24	132	45	5.5	M 5
48	111	106	6.5	M 6

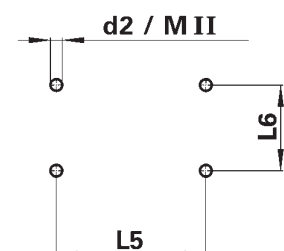

Industrial Multipole Connectors Hoods with double locking levers

revos BASIC

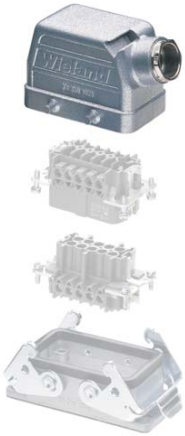

Hood type A

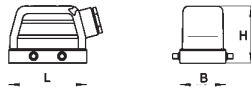

Hood type B



Hood type C

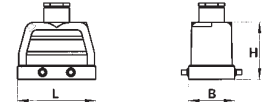

Degree of protection IP 55

Degree of protection IP 65 with matching cable glands (see accessories)

For inserts: **600 V** UL/CSA

For inserts: **690 V** IEC 61 984

Number of poles	Thread	Gland type	Dimensions in mm	L	W	H	Std. pack
Size 10 for connector 10pole + ground	M 20	0 with cable gland 1 with threaded collar 2 with intermediate support 3 with strain relief		73	43	53	1
	M 25	0 with cable gland 1 with threaded collar 2 with intermediate support 3 with strain relief		73	43	53	
Size 16 for connector 16pole + ground	M 25	0 with cable gland 1 with threaded collar 2 with intermediate support 3 with strain relief		93.5	43	60	1
	M 32	0 with cable gland 1 with threaded collar 2 with intermediate support 3 with strain relief		93.5	43	60	
Size 24 for connector 24pole + ground	M 25	0 with cable gland 1 with threaded collar 2 with intermediate support 3 with strain relief		120	43	70	1
	M 32	0 with cable gland 1 with threaded collar 2 with intermediate support 3 with strain relief		120	43	70	1
Size 32 for connector 32pole + ground	M 32	0 with cable gland 1 with threaded collar 2 with intermediate support 3 with strain relief		93.5	82.5	94	1
	M 40	1 with threaded collar 2 with intermediate support		93.5	82.5	94	1

revos

Hood type D

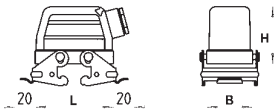

Hood type E

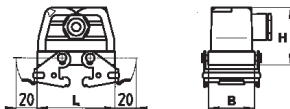

Hood type F

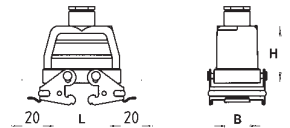

Hood	Hood for 24pole = 2 x M 25	Hood	Hood with locking levers	Hood with locking levers for 24pole = 2 x M 25	Hood with locking levers
Hood type A	Hood type B	Hood type C	Hood type D	Hood type E	Hood type F
					
Part no.	Part no.	Part no.	Part no.	Part no.	Part no.
72.350.1035.0 72.350.1035.1 72.350.1035.2 72.350.1035.3	72.351.1035.0 72.351.1035.1 72.351.1035.2 72.351.1035.3	72.352.1035.0 72.352.1035.1 72.352.1035.2 72.352.1035.3	72.355.1035.0 72.355.1035.1 72.355.1035.2 72.355.1035.3	72.356.1035.0 72.356.1035.1 72.356.1035.2 72.356.1035.3	72.357.1035.0 72.357.1035.1 72.357.1035.2 72.357.1035.3
72.353.1035.0 72.353.1035.1 72.353.1035.2 72.353.1035.3		72.354.1035.0 72.354.1035.1 72.354.1035.2 72.354.1035.3	72.358.1035.0 72.358.1035.1 72.358.1035.2 72.358.1035.3		72.359.1035.0 72.359.1035.1 72.359.1035.2 72.359.1035.3
72.350.1635.0 72.350.1635.1 72.350.1635.2 72.350.1635.3	72.351.1635.0 72.351.1635.1 72.351.1635.2 72.351.1635.3	72.352.1635.0 72.352.1635.1 72.352.1635.2 72.352.1635.3	72.355.1635.0 72.355.1635.1 72.355.1635.2 72.355.1635.3	72.356.1635.0 72.356.1635.1 72.356.1635.2 72.356.1635.3	72.357.1635.0 72.357.1635.1 72.357.1635.2 72.357.1635.3
72.353.1635.0 72.353.1635.1 72.353.1635.2 72.353.1635.3		72.354.1635.0 72.354.1635.1 72.354.1635.2 72.354.1635.3	72.358.1635.0 72.358.1635.1 72.358.1635.2 72.358.1635.3		72.359.1635.0 72.359.1635.1 72.359.1635.2 72.359.1635.3
72.350.2435.0 72.350.2435.1 72.350.2435.2 72.350.2435.3	72.351.2435.0 72.351.2435.1 72.351.2435.2 72.351.2435.3	72.352.2435.0 72.352.2435.1 72.352.2435.2 72.352.2435.3	72.355.2435.0 72.355.2435.1 72.355.2435.2 72.355.2435.3	72.356.2435.0 72.356.2435.1 72.356.2435.2 72.356.2435.3	72.357.2435.0 72.357.2435.1 72.357.2435.2 72.357.2435.3
72.353.2435.0 72.353.2435.1 72.353.2435.2 72.353.2435.3		72.354.2435.0 72.354.2435.1 72.354.2435.2 72.354.2435.3	72.358.2435.0 72.358.2435.1 72.358.2435.2 72.358.2435.3		72.359.2435.0 72.359.2435.1 72.359.2435.2 72.359.2435.3
70.350.3235.0 70.350.3235.1 70.350.3235.2 70.350.3235.3		70.352.3235.0 70.352.3235.1 70.352.3235.2 70.352.3235.3			
70.353.3235.1 70.353.3235.2		70.354.3235.1 70.354.3235.2			

Industrial Multipole Connectors

Housings with double locking levers

revos BASIC

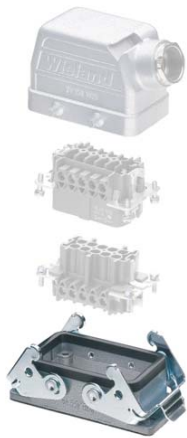

Hood type a

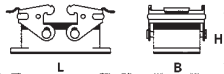

Hood type b

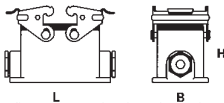

Hood type c

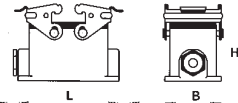

Hood type d

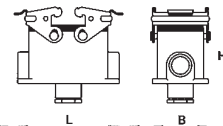

Housing type i

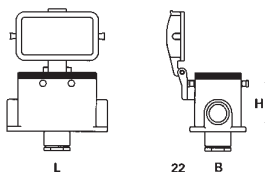

Housing open bottom

Housing type a



Housing closed bottom with two cable glands

Housing type b



Housing closed bottom with one cable gland on the left

Housing type c



Degree of protection IP 55

Degree of protection IP 65 with matching cable glands (see accessories)

For inserts: **600 V** UL/CSA

For inserts: **690 V** IEC 61 984

Number of poles	Thread	Gland type	L	W	H	Std. pack	Part no.	Part no.	Part no.
Size 10 for connector 10pole + ground	M 20	0 with cable gland	93	43	28	1	72.320.1028.0	72.330.1035.0 72.330.1035.1	72.331.1035.0 72.331.1035.1
		1 with threaded collar	94	52	54.5	1			
Size 16 for connector 16pole + ground	M 25	0 with cable gland	113	43	28	1	72.320.1628.0	72.330.1635.0 72.330.1635.1	72.331.1635.0 72.331.1635.1
		1 with threaded collar	117	52	56.5	1			
Size 24 for connector 24pole + ground	M 25	0 with cable gland	140	43	28	1	72.320.2428.0	72.330.2435.0 72.330.2435.1	72.331.2435.0 72.331.2435.1
		1 with threaded collar	144	52	56.5	1			
Size 32 for connector 32pole + ground			124	84	35	1	70.320.3228.0		

Mounting dimensions for open-bottom housings

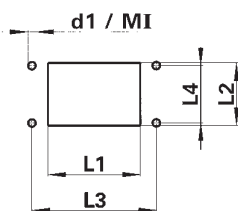

Housing size	Cut-out (mm)		Mounting holes (mm)		d1 (mm)	MI
	L1	L2	L3	L4		
10	65	35	83	32	4.3	M 4
16	85.5	35	103	32	4.3	M 4
24	112	35	130	32	4.3	M 4
32	117	81	148	70	6.4	M 6

revos

Hood type e

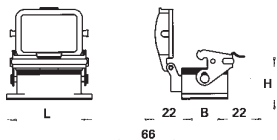

Housing type f

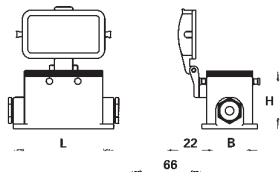

Housing type g

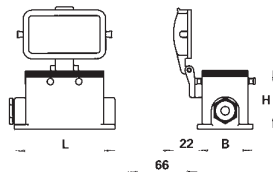

Housing type h

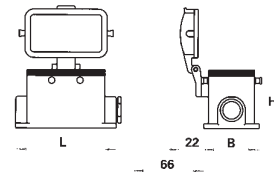

Housing closed bottom with cable gland at the bottom

Housing open bottom with protective cover

Housing closed bottom with two glands and protective cover

Housing closed bottom with cable gland on the left and protective cover

Housing closed bottom with cable gland on the right and protective cover

Housing closed bottom with cable gland at the bottom and protective cover

Housing type d

Housing type e

Housing type f

Housing type g

Housing type h

Housing type i



Part no.

Part no.

Part no.

Part no.

Part no.

Part no.

72.333.1035.0
72.333.1035.1

70.325.1028.0

72.340.1035.0
72.340.1035.1

72.341.1035.0
72.341.1035.1

72.342.1035.0
72.342.1035.1

72.343.1035.0
72.343.1035.1

72.333.1635.0
72.333.1635.1

70.325.1628.0

72.340.1635.0
72.340.1635.1

72.341.1635.0
72.341.1635.1

72.342.1635.0
72.342.1635.1

72.343.1635.0
72.343.1635.1

72.333.2435.0
72.333.2435.1

70.325.2428.0

72.340.2435.0
72.340.2435.1

72.341.2435.0
72.341.2435.1

72.342.2435.0
72.342.2435.1

72.343.2435.0
72.343.2435.1

Mounting dimensions for closed-bottom housings

Housing size	L5 (mm)	L6 (mm)
10	82	40
16	105	45
24	132	45

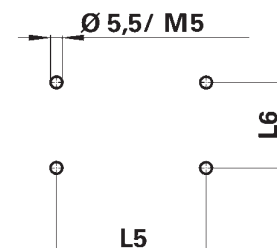

Industrial multipole connectors

Multiple multipole connectors

revos BASIC

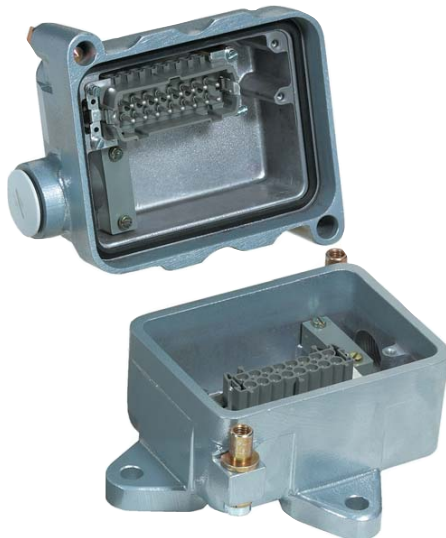

600 V UL/CSA
500 V, 16 A IEC 61 984

16pole and 24pole + ground

Degree of protection:
IP 65 with the appropriate cable glands

	Number of poles	Cable entry side	Thread	Part no.	Stand. pack
Housing		narrow side	M 25	75.900.0035.0	1
Hood		narrow side	M 25	75.900.0135.0	1
Female insert	16pole + ground			70.300.1640.0	10
Male insert	16pole + ground			70.310.1640.0	10
Female insert	24pole + ground			70.300.2440.0	10
Male insert	24pole + ground			70.310.2440.0	10
Housing with female insert	16pole	narrow side	M 25	75.931.1635.0	1
Housing with female insert	16pole	bottom	M 25	75.933.1635.0	1
Housing with male insert	16pole	narrow side	M 25	75.941.1635.0	1
Hood with male insert	16pole	narrow side	M 25	75.950.1635.0	1
Hood with female insert	16pole	narrow side	M 25	75.960.1635.0	1
Housing with female insert	24pole	narrow side	M 25	75.931.2435.0	1
Housing with female insert	24pole	bottom	M 25	75.933.2435.0	1
Housing with female insert	24pole	bottom/narrow side	M 25	75.934.2435.0	1
Housing with male insert	24pole	narrow side	M 25	75.941.2435.0	1
Hood with male insert	24pole	narrow side	M 25	75.950.2435.0	1
Hood with female insert	24pole	narrow side	M 25	75.960.2435.0	1
	Housings:	are delivered with M 25 threads With bottom entry threads, the side entry is sealed with a locking piece			
	Hoods:	are delivered with M25 threads and preassembled locking piece			

revos

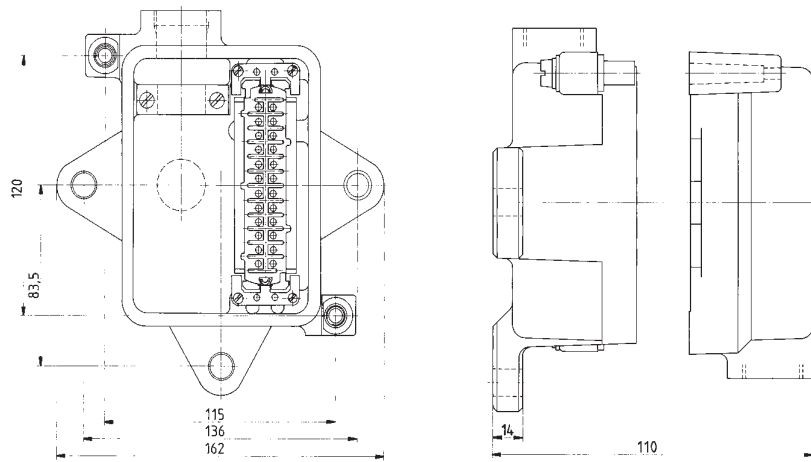

revos

Industrial multipole connectors, sets of 2 components

Housing with multipole adapter with single and double locking levers

revos BASIC

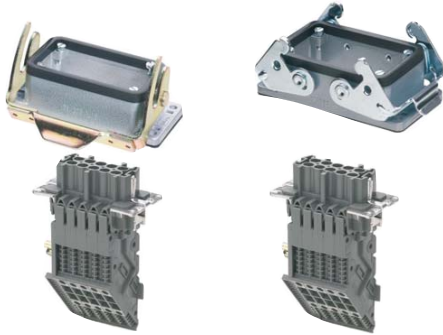

600 V UL/CSA

500 V, 16 A IEC 61 984

			Cross section	Approvals	Wire strip length	Stand. pack
 <p>Single locking lever</p>	<p>Screw connection Housing with multipole adapter, long design (6 marking fields), mounting from the rear, Multipole adapter in the housing, unassembled</p>	Multipole adapter in the housing	0.5 – 4 mm ² 20 – 12 AWG		12 mm	10
		Single locking lever Female adapter insert, ground right				10
		Female adapter insert, ground left				10
		Male adapter insert, ground right				10
 <p>Single locking lever</p>	<p>Screw connection Housing with multipole adapter, short design (4 marking fields), mounting from the rear, Multipole adapter in the housing, unassembled</p>	Multipole adapter in the housing	0.5 – 4 mm ² 20 – 12 AWG		12 mm	10
		Single locking lever				10
		Female adapter insert, ground right				10
		Female adapter insert, ground left				10
 <p>Double locking lever</p>	<p>Screw connection Housing with multipole adapter, long design (6 marking fields), mounting from the rear, Multipole adapter in the housing, unassembled</p>	Multipole adapter in the housing	0.5 – 4 mm ² 20 – 12 AWG		12 mm	10
		Double locking lever				10
		Female adapter insert, ground right				10
		Female adapter insert, ground left				10
 <p>Double locking lever</p>	<p>Screw connection Housing with multipole adapter, short design (4 marking fields), mounting from the rear, Multipole adapter in the housing, unassembled</p>	Multipole adapter in the housing	0.5 – 4 mm ² 20 – 12 AWG		12 mm	10
		Double locking lever				10
		Female adapter insert, ground right				10
		Female adapter insert, ground left				10

revos

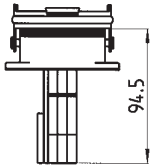
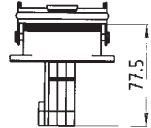
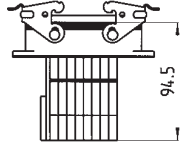
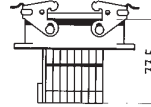
6pole + ground	10pole + ground	16pole + ground	24pole + ground	
Part no.	Part no.	Part no.	Part no.	
70.945.0653.3 70.940.0653.3	71.945.1053.3 71.940.1053.3	71.945.1653.3 71.940.1653.3	71.945.2453.3 71.940.2453.3	 <p>For hoods see page 633</p>
70.955.0653.3 70.950.0653.3	71.955.1053.3 71.950.1053.3	71.955.1653.3 71.950.1653.3	71.955.2453.3 71.950.2453.3	
70.945.0653.4 70.940.0653.4	71.945.1053.4 71.940.1053.4	71.945.1653.4 71.940.1653.4	71.945.2453.4 71.940.2453.4	 <p>For hoods see page 633</p>
70.955.0653.4 70.950.0653.4	71.955.1053.4 71.950.1053.4	71.955.1653.4 71.950.1653.4	71.955.2453.4 71.950.2453.4	
	70.945.1053.3 70.940.1053.3	70.945.1653.3 70.940.1653.3	70.945.2453.3 70.940.2453.3	 <p>For hoods see page 636</p>
	70.955.1053.3 70.950.1053.3	70.955.1653.3 70.950.1653.3	70.955.2453.3 70.950.2453.3	
	70.945.1053.4 70.940.1053.4	70.945.1653.4 70.940.1653.4	70.945.2453.4 70.940.2453.4	 <p>For hoods see page 636</p>
	70.955.1053.4 70.950.1053.4	70.955.1653.4 70.950.1653.4	70.955.2453.4 70.950.2453.4	
				For inserts and multipole adapters see page 630

Industrial multipole connectors, sets of 2 components

Housing with multipole adapter with single and double locking levers

revos BASIC

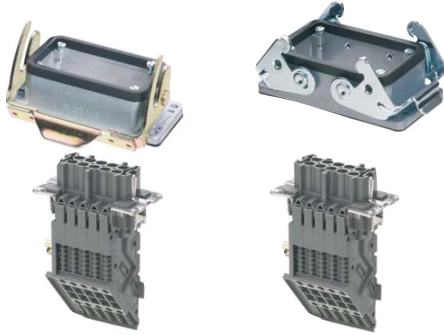

600 V UL/CSA

500 V, 16 A IEC 61 984

			Cross section	Approvals	Wire strip length	Stand. pack
Single locking lever 	Screw connection Housing with multipole adapter, long design (6 marking fields), mounting from the rear, Multipole adapter in the housing, unassembled	Multipole adapter in the housing	0.5 – 4 mm ² 20 – 12 AWG		12 mm	10
		Single locking lever				10
		Female adapter insert, ground right				10
		Female adapter insert, ground left				10
Single locking lever 	Screw connection Housing with multipole adapter, short design (4 marking fields), mounting from the rear, Multipole adapter in the housing, unassembled	Multipole adapter in the housing	0.5 – 4 mm ² 20 – 12 AWG		12 mm	10
		Single locking lever				10
		Female adapter insert, ground right				10
		Female adapter insert, ground left				10
Double locking lever 	Screw connection Housing with multipole adapter, long design (6 marking fields), mounting from the rear, Multipole adapter in the housing, unassembled	Multipole adapter in the housing	0.5 – 4 mm ² 20 – 12 AWG		12 mm	10
		Double locking lever				10
		Female adapter insert, ground right				10
		Female adapter insert, ground left				10
Double locking lever 	Screw connection Housing with multipole adapter, short design (4 marking fields), mounting from the rear, Multipole adapter in the housing, unassembled	Multipole adapter in the housing	0.5 – 4 mm ² 20 – 12 AWG		12 mm	10
		Double locking lever				10
		Female adapter insert, ground right				10
		Female adapter insert, ground left				10

revos

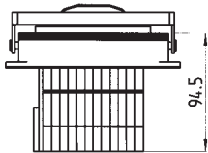
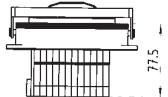
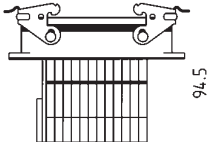
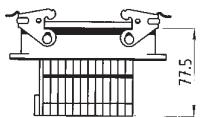
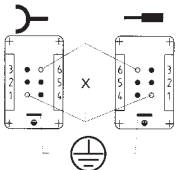
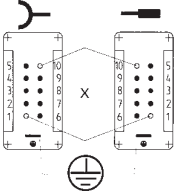
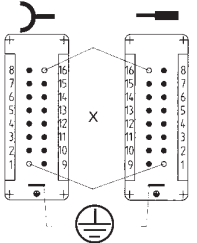
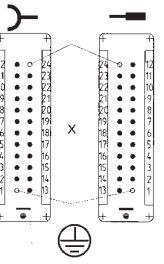
6pole + ground	10pole + ground	16pole + ground	24pole + ground	
Part no.	Part no.	Part no.	Part no.	
72.945.0653.0 72.940.0653.0	77.945.1053.0 77.940.1053.0	77.945.1653.0 77.940.1653.0	77.945.2453.0 77.940.2453.0	 For hoods see page 656
72.955.0653.0 72.950.0653.0	77.955.1053.0 77.950.1053.0	77.955.1653.0 77.950.1653.0	77.955.2453.0 77.950.2453.0	
72.945.0653.4 72.940.0653.4	77.945.1053.4 77.940.1053.4	77.945.1653.4 77.940.1653.4	77.945.2453.4 77.940.2453.4	 For hoods see page 656
72.955.0653.4 72.950.0653.4	77.955.1053.4 77.950.1053.4	77.955.1653.4 77.950.1653.4	77.955.2453.4 77.950.2453.4	
	72.945.1053.0 72.940.1053.0	72.945.1653.0 72.940.1653.0	72.945.2453.0 72.940.2453.0	 For hoods see page 660
	72.955.1053.0 72.950.1053.0	72.955.1653.0 72.950.1653.0	72.955.2453.0 72.950.2453.0	
	72.945.1053.4 72.940.1053.4	72.945.1653.4 72.940.1653.4	72.945.2453.4 72.940.2453.4	 For hoods see page 660
	72.955.1053.4 72.950.1053.4	72.955.1653.4 72.950.1653.4	72.955.2453.4 72.950.2453.4	
Pole configuration 6pole + ground	Pole assignment 10pole + ground	Pole assignment 16pole + ground	Pole assignment 24pole + ground	For inserts and multipole adapters see page 654 X = switching contacts (2 shortened male pins)
				

Industrial multipole connectors, sets of 2 components

Housing with multipole adapter with single and double locking levers

revos BASIC



600 V UL/CSA

690 V/400 V, 16 A IEC 61 984

			Cross section	Approvals	Wire strip length	Stand. pack
 <p>Single locking lever</p>	<p>Screw connection Housing with multipole adapter, long design (6 marking fields), mounting from the rear, Multipole adapter in the housing, unassembled</p>	Multipole adapter in the housing	0.5 – 4 mm ² 20 – 12 AWG			
		Single locking lever				
		Female adapter insert, ground right				
		Female adapter insert, ground left				
		Male adapter insert, ground right			12 mm	10
		Male adapter insert, ground left			12 mm	10
 <p>Single locking lever</p>	<p>Screw connection Housing with multipole adapter, short design (4 marking fields), mounting from the rear, Multipole adapter in the housing, unassembled</p>	Multipole adapter in the housing	0.5 – 4 mm ² 20 – 12 AWG			
		Single locking lever				
		Female adapter insert, ground right				
		Female adapter insert, ground left				
		Male adapter insert, ground right			12 mm	10
		Male adapter insert, ground left			12 mm	10
 <p>Double locking lever</p>	<p>Screw connection Housing with multipole adapter, long design (6 marking fields), mounting from the rear, Multipole adapter in the housing, unassembled</p>	Multipole adapter in the housing	0.5 – 4 mm ² 20 – 12 AWG			
		Double locking lever				
		Female adapter insert, ground right				
		Female adapter insert, ground left				
		Male adapter insert, ground right			12 mm	10
		Male adapter insert, ground left			12 mm	10
 <p>Double locking lever</p>	<p>Screw connection Housing with multipole adapter, short design (4 marking fields), mounting from the rear, Multipole adapter in the housing, unassembled</p>	Multipole adapter in the housing	0.5 – 4 mm ² 20 – 12 AWG			
		Double locking lever				
		Female adapter insert, ground right				
		Female adapter insert, ground left				
		Male adapter insert, ground right			12 mm	10
		Male adapter insert, ground left			12 mm	10

revos

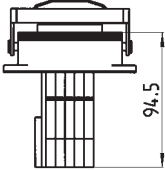
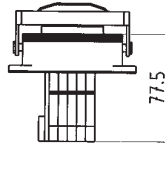
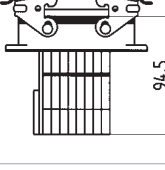
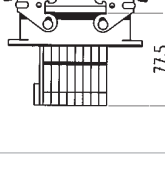
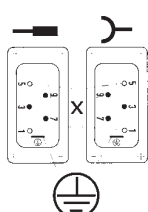
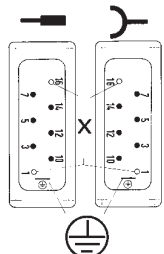
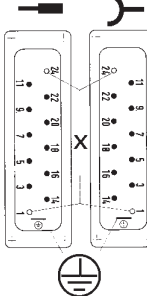
3pole + ground	6pole + ground	10pole + ground	
Part no.	Part no.	Part no.	
71.965.0353.3 71.960.0353.3	71.965.0653.3 71.960.0653.3	71.965.1053.3 71.960.1053.3	 <p>For hoods see page 644</p>
71.975.0353.3 71.970.0353.3	71.975.0653.3 71.970.0653.3	71.975.1053.3 71.970.1053.3	
71.965.0353.4 71.960.0353.4	71.965.0653.4 71.960.0653.4	71.965.1053.4 71.960.1053.4	 <p>For hoods see page 644</p>
71.975.0353.4 71.970.0353.4	71.975.0653.4 71.970.0653.4	71.975.1053.4 71.970.1053.4	
70.965.0353.3 70.960.0353.3	70.965.0653.3 70.960.0653.3	70.965.1053.3 70.960.1053.3	 <p>For hoods see page 648</p>
70.975.0353.3 70.970.0353.3	70.975.0653.3 70.970.0653.3	70.975.1053.3 70.970.1053.3	
70.965.0353.4 70.960.0353.4	70.965.0653.4 70.960.0653.4	70.965.1053.4 70.960.1053.4	 <p>For hoods see page 648</p>
70.975.0353.4 70.970.0353.4	70.975.0653.4 70.970.0653.4	70.975.1053.4 70.970.1053.4	
<p>Pole assignment 3pole + ground</p> 	<p>Pole assignment 6pole + ground</p> 	<p>Pole assignment 10pole + ground</p> 	<p>For inserts and multipole adapters see page 642</p> <p>X = switching contacts (2 shortened male pins)</p>

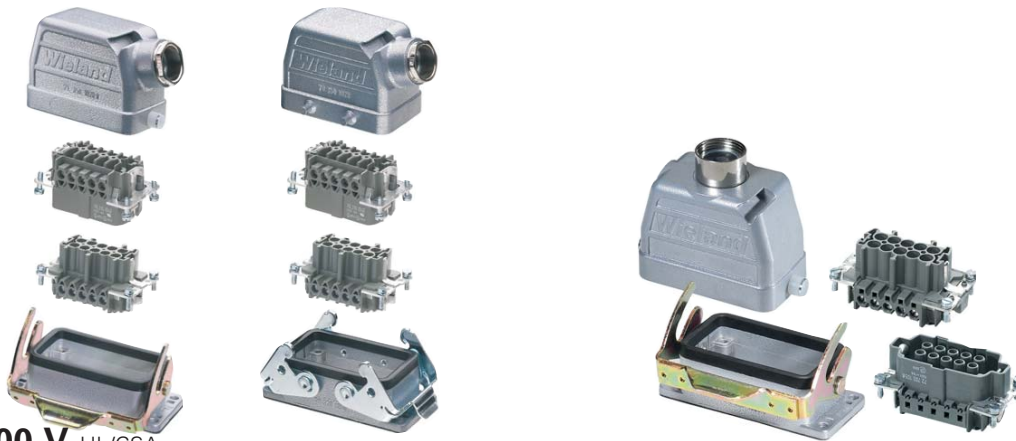

Industrial multipole connectors, sets of 4 components with double locking levers

revos BASIC



600 V UL/CSA

500 V, 16 A IEC 61 984





Hood/housing size	Number of poles	Thread	Stand. pack	Part no.	Female insert Screw connection	Male insert Screw connection
For technical information see the individual components					 70.300.xx40.0	 70.310.xx40.0
6	6pole + ground	M 20	1	99.700.0000.6	●	●
10	10pole + ground	M 20	1	99.701.0000.6	●	●
16	16pole + ground	M 25	1	99.702.0000.6	●	●
24	24pole + ground	M 25	1	99.703.0000.6	●	●
6	6pole + ground	M 25	1	99.706.0000.6	●	●
10	10pole + ground	M 25	1	99.707.0000.6	●	●
16	16pole + ground	M 32	1	99.708.0000.6	●	●
24	24pole + ground	M 32	1	99.709.0000.6	●	●
6	6pole + ground	M 25	1	99.718.0000.6	●	●
10	10pole + ground	M 25	1	99.719.0000.6	●	●
16	16pole + ground	M 32	1	99.720.0000.6	●	●
24	24pole + ground	M 32	1	99.721.0000.6	●	●
6	6pole + ground	M 20	1	99.724.0000.6	●	●
10	10pole + ground	M 20	1	99.725.0000.6	●	●
16	16pole + ground	M 25	1	99.726.0000.6	●	●
24	24pole + ground	M 25	1	99.727.0000.6	●	●

revos

● parts belonging to the set of 4 components

Connector set complete with:

Female and male inserts plugged together,
inserted in the mated hood and housing (unassembled), locked

<p>Hood with narrow-side entry metric cable gland</p>  <p>70.35x.xx35.0</p>	<p>Hood with top entry metric cable gland</p>  <p>70.352.xx35.0</p>	<p>Open-bottom housing</p>  <p>70.320.xx28.0</p>	<p>Closed-bottom housing with one metric cable gland</p>  <p>70.331.xx35.0</p>
● ● ● ●		● ● ● ●	
● ● ● ●		● ● ● ● ● ●	
	● ● ● ●	● ● ● ● ●	
● ● ● ●			● ● ● ●



Industrial multipole connectors

Multipole connector with latching frame

revos BASIC



600 V CSA
500 V, 16 A IEC 61 984

Latching frame to be inserted in sheet metal cut-out, and for use in cable to cable couplings.

Screw connection 0.5 – 2.5 mm² solid/fine stranded
 20 – 12 AWG
 Rated current 16 A
 Rated voltage VDE 500 V*
 Rated voltage CSA 600 V

* The mounting style might change the air and creepage distances and influence the rated voltage.

For accessories and marking facilities see page 788

		Approvals	Wire strip length	Stand. pack
 Latching frame with strain relief 	Female insert	☰	7 mm	10
	Male insert	☰	7 mm	10
 Latching frame 	Female insert	☰	7 mm	10
	Male insert	☰	7 mm	10
 Latching frame with strain relief and locking levers 	Female insert	☰	7 mm	10
	Male insert	☰	7 mm	10
 Latching frame with locking levers 	Female insert	☰	7 mm	10
	Male insert	☰	7 mm	10
 Multipole adapter with latching frame 	Female insert, ground right	☰	12 mm	10
	Female insert, ground right with U-foot	☰		
	Female insert, ground left	☰		
	Female insert, ground left with U-foot	☰		
 Multipole adapter with latching frame and locking levers 	Male insert, ground right	☰	12 mm	10
	Male insert, ground right with U-foot	☰		
	Male insert, ground left	☰		
	Male insert, ground left with U-foot	☰		

revos

6pole + ground	10pole + ground	16pole + ground	24pole + ground
Part no.	Part no.	Part no.	Part no.
Z5.570.0156.0	Z5.570.0256.0	Z5.570.0056.0	Z5.570.0356.0
Z5.571.0156.0	Z5.571.0256.0	Z5.571.0056.0	Z5.571.0356.0
Z5.570.1156.0	Z5.570.1256.0	Z5.570.1056.0	Z5.570.1356.0
Z5.571.1156.0	Z5.571.1256.0	Z5.571.1056.0	Z5.571.1356.0
Z5.570.2156.0	Z5.570.2256.0	Z5.570.2056.0	Z5.570.2356.0
Z5.571.2156.0	Z5.571.2256.0	Z5.571.2056.0	Z5.571.2356.0
Z5.570.3156.0	Z5.570.3256.0	Z5.570.3056.0	Z5.570.3356.0
Z5.571.3156.0	Z5.571.3256.0	Z5.571.3056.0	Z5.571.3356.0
Z5.572.1156.0 Z5.572.5156.0 Z5.572.0156.0 Z5.572.4156.0	Z5.572.1256.0 Z5.572.5256.0 Z5.572.0256.0 Z5.572.4256.0	Z5.572.1056.0 Z5.572.5056.0 Z5.572.0056.0 Z5.572.4056.0	Z5.572.1356.0 Z5.572.5356.0 Z5.572.0356.0 Z5.572.4356.0
Z5.573.1156.0 Z5.573.5156.0 Z5.573.0156.0 Z5.573.4156.0	Z5.573.1256.0 Z5.573.5256.0 Z5.573.0256.0 Z5.573.4256.0	Z5.573.1056.0 Z5.573.5056.0 Z5.573.0056.0 Z5.573.4056.0	Z5.573.1356.0 Z5.573.5356.0 Z5.573.0356.0 Z5.573.4356.0
Z5.572.3156.0 Z5.572.7156.0 Z5.572.2156.0 Z5.572.6156.0	Z5.572.3256.0 Z5.572.7256.0 Z5.572.2256.0 Z5.572.6256.0	Z5.572.3056.0 Z5.572.7056.0 Z5.572.2056.0 Z5.572.6056.0	Z5.572.3356.0 Z5.572.7356.0 Z5.572.2356.0 Z5.572.6356.0
Z5.573.3156.0 Z5.573.7156.0 Z5.573.2156.0 Z5.573.6156.0	Z5.573.3256.0 Z5.573.7256.0 Z5.573.2256.0 Z5.573.6256.0	Z5.573.3056.0 Z5.573.7056.0 Z5.573.2056.0 Z5.573.6056.0	Z5.573.3356.0 Z5.573.7356.0 Z5.573.2356.0 Z5.573.6356.0

Universal foot, 23 mm wide

05.583.0053.0

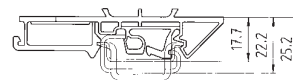

Delivered as standard component where indicated

Cut-out for latching frames

Sheet metal: 2 ± 0.05 mm thick

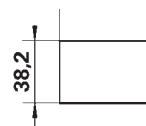

Housing size	L1 (mm)	L2 (mm)	L3 (mm)
6	67.5	74.1	62.5
10	80.9	87.5	75.9
16	101	106.5	96
24	127.8	134.4	122.8

revos

Industrial multipole connectors

Multipole connector with latching frame

revos BASIC



600 V CSA
500 V, 16 A IEC 61 984

Latching frame to be inserted in sheet metal cut-out, and for use in cable to cable couplings.

Crimp connection 0,5 – 4 mm² fine stranded
 20 – 12 AWG
 Rated current 16 A
 Rated voltage VDE 500 V*
 Rated voltage CSA 600 V

* The mounting style might change the air and creepage distances and influence the rated voltage.

For accessories and marking facilities see page 788

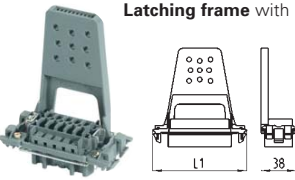
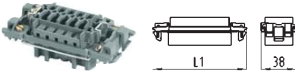
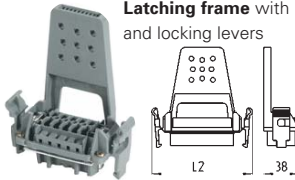
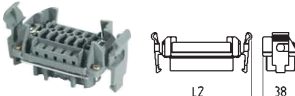
		Approvals	Wire strip length	Stand. pack
 <p>Latching frame with strain relief</p>	Female insert	CE	7 mm	10
	Male insert	CE	7 mm	10
 <p>Latching frame</p>	Female insert	CE	7 mm	10
	Male insert	CE	7 mm	10
 <p>Latching frame with strain relief and locking levers</p>	Female insert	CE	7 mm	10
	Male insert	CE	7 mm	10
 <p>Latching frame with locking levers</p>	Female insert	CE	7 mm	10
	Male insert	CE	7 mm	10

revos

Contacts for crimp version

Female contacts



Male contacts



Crimping tool
Crimping die "B"
Contact positioner "3"
Extraction tool

Ø mm ²	AWG	Part no.	Stand. pack	Ø mm ²	AWG	Part no.	Stand. pack
		tin-plated				gold-plated	
0.5	20 AWG	02.123.7021.0	200	0.5	20 AWG	02.123.7001.0	
0.75 - 1	18 AWG	02.123.7121.0	200	0.75 - 1	18 AWG	02.123.7101.0	
1.5	16 AWG	02.123.7221.0	200	1.5	16 AWG	02.123.7201.0	200
2.5	14 AWG	02.123.7321.0	200	2.5	14 AWG	02.123.7301.0	
4	12 WG	02.123.7421.0	200	4	12 WG	02.123.7401.0	
0.5	20 AWG	05.543.7021.0	200	0.5	20 AWG	05.543.7001.0	
0.75 - 1	18 AWG	05.543.7121.0	200	0.75 - 1	18 AWG	05.543.7101.0	
1.5	16 AWG	05.543.7221.0	200	1.5	16 AWG	05.543.7201.0	200
2.5	14 AWG	05.543.7321.0	200	2.5	14 AWG	05.543.7301.0	
4	12 AWG	05.543.7421.0	200	4	12 AWG	05.543.7401.0	
		95.101.0800.0	1			silver-plated upon request	
		05.502.2100.0	1				
		05.502.3300.0	1				
		05.502.3500.0	1				

6pole + ground 10pole + ground 16pole + ground 24pole + ground

Part no.	Part no.	Part no.	Part no.
Z5.570.4156.0	Z5.570.4256.0	Z5.570.4056.0	Z5.570.4356.0
Z5.571.4156.0	Z5.571.4256.0	Z5.571.4056.0	Z5.571.4356.0
Z5.570.5156.0	Z5.570.5256.0	Z5.570.5056.0	Z5.570.5356.0
Z5.571.5156.0	Z5.571.5256.0	Z5.571.5056.0	Z5.571.5356.0
Z5.570.6656.0	Z5.570.6756.0	Z5.570.6556.0	Z5.570.6856.0
Z5.571.6656.0	Z5.571.6756.0	Z5.571.6556.0	Z5.571.6856.0
Z5.570.8656.0	Z5.570.8756.0	Z5.570.8556.0	Z5.570.8856.0
Z5.571.8656.0	Z5.571.8756.0	Z5.571.8556.0	Z5.571.8856.0

Universal foot, 23 mm wide

05.583.0053.0

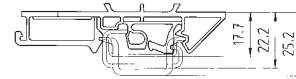

Delivered as standard component where indicated

Cut-out for latching frames

Sheet metal: 2 ± 0.05 mm thick

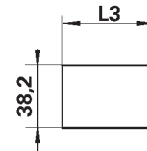

Housing size	L1 (mm)	L2 (mm)	L3 (mm)
6	67.5	74.1	62.5
10	80.9	87.5	75.9
16	101	106.5	96
24	127.8	134.4	122.8



Industrial multipole connectors

Multipole connector with latching frame

revos BASIC



600 V CSA
690 V, 16 A IEC 61 984

Latching frame to be inserted in sheet metal cut-out, and for use in cable to cable couplings.

Screw connection 0.5 – 2.5 mm² solid/fine stranded
 20 – 12 AWG
 Rated current 16 A
 Rated voltage VDE
 – multipole connector 690 V ~*
 – multipole adapter 500 V ~*
 Rated voltage CSA 600 V

* The mounting style might change the air and creepage distances and influence the rated voltage.

For accessories and marking facilities see page 788

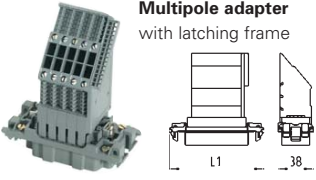
		Approvals	Wire strip length	Stand. pack
 <p>Latching frame with strain relief</p>	Female insert	☑	7 mm	10
	Male insert	☑	7 mm	10
 <p>Latching frame</p>	Female insert	☑	7 mm	10
	Male insert	☑	7 mm	10
 <p>Latching frame with strain relief and locking levers</p>	Female insert	☑	7 mm	10
	Male insert	☑	7 mm	10
 <p>Latching frame with locking levers</p>	Female insert	☑	7 mm	10
	Male insert	☑	7 mm	10
 <p>Multipole adapter with latching frame</p>	Female insert, ground right	☑	12 mm	10
	Female insert, ground right with U-foot	☑		
	Female insert, ground left	☑		
	Female insert, ground left with U-foot	☑		
 <p>Multipole adapter with latching frame and locking levers</p>	Male insert, ground right	☑	12 mm	10
	Male insert, ground right with U-foot	☑		
	Male insert, ground left	☑		
	Male insert, ground left with U-foot	☑		

revos

6pole + ground	10pole + ground	16pole + ground	24pole + ground
Part no.	Part no.	Part no.	Part no.
Z5.570.0656.0	Z5.570.0756.0	Z5.570.0556.0	Z5.570.0856.0
Z5.571.0656.0	Z5.571.0756.0	Z5.571.0556.0	Z5.571.0856.0
Z5.570.1656.0	Z5.570.1756.0	Z5.570.1556.0	Z5.570.1856.0
Z5.571.1656.0	Z5.571.1756.0	Z5.571.1556.0	Z5.571.1856.0
Z5.570.2656.0	Z5.570.2756.0	Z5.570.2556.0	Z5.570.2856.0
Z5.571.2656.0	Z5.571.2756.0	Z5.571.2556.0	Z5.571.2856.0
Z5.570.3656.0	Z5.570.3756.0	Z5.570.3556.0	Z5.570.3856.0
Z5.571.3656.0	Z5.571.3756.0	Z5.571.3556.0	Z5.571.3856.0
Z5.572.1656.0 Z5.572.5656.0 Z5.572.0656.0 Z5.572.4656.0	Z5.572.1756.0 Z5.572.5756.0 Z5.572.0756.0 Z5.572.4756.0	Z5.572.1556.0 Z5.572.5556.0 Z5.572.0556.0 Z5.572.4556.0	Z5.572.1856.0 Z5.572.5856.0 Z5.572.0856.0 Z5.572.4856.0
Z5.573.1656.0 Z5.573.5656.0 Z5.573.0656.0 Z5.573.4656.0	Z5.573.1756.0 Z5.573.5756.0 Z5.573.0756.0 Z5.573.4756.0	Z5.573.1556.0 Z5.573.5556.0 Z5.573.0556.0 Z5.573.4556.0	Z5.573.1856.0 Z5.573.5856.0 Z5.573.0856.0 Z5.573.4856.0
Z5.572.3656.0 Z5.572.7656.0 Z5.572.2656.0 Z5.572.6656.0	Z5.572.3756.0 Z5.572.7756.0 Z5.572.2756.0 Z5.572.6756.0	Z5.572.3556.0 Z5.572.7556.0 Z5.572.2556.0 Z5.572.6556.0	Z5.572.3856.0 Z5.572.7856.0 Z5.572.2856.0 Z5.572.6856.0
Z5.573.3656.0 Z5.573.7656.0 Z5.573.2656.0 Z5.573.6656.0	Z5.573.3756.0 Z5.573.7756.0 Z5.573.2756.0 Z5.573.6756.0	Z5.573.3556.0 Z5.573.7556.0 Z5.573.2556.0 Z5.573.6556.0	Z5.573.3856.0 Z5.573.7856.0 Z5.573.2856.0 Z5.573.6856.0

Universal foot, 23 mm wide
05.583.0053.0

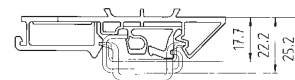

Delivered as standard component where indicated

Cut-out for latching frames

Sheet metal: 2 ± 0.05 mm thick

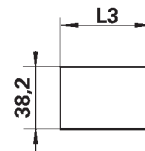

Housing size	L1 (mm)	L2 (mm)	L3 (mm)
6	67.5	74.1	62.5
10	80.9	87.5	75.9
16	101	106.5	96
24	127.8	134.4	122.8



Industrial multipole connectors

Multipole connector with latching frame

revos BASIC









600 V CSA
690 V, 16 A IEC 61 984

Latching frame to be inserted in sheet metal cut-out, and for use in cable to cable couplings.

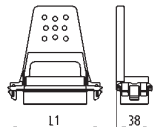
Crimp connection 0,5 – 4 mm² fine stranded
 20 – 12 AWG
 Rated current 16 A
 Rated voltage VDE 690 V ~*
 Rated voltage CSA 600 V

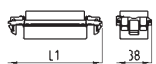
* The mounting style might change the air and creepage distances and influence the rated voltage.

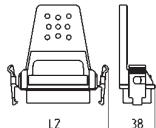
For accessories and marking facilities see page 788

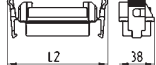
		Dimensions in mm			Approvals	Wire strip length	Stand. pack
		L	W	H			
 <p>Latching frame with strain relief</p> 	Female insert				CE	7 mm	10
	Male insert				CE	7 mm	10
 <p>Latching frame</p> 	Female insert				CE	7 mm	10
	Male insert				CE	7 mm	10
 <p>Latching frame with strain relief and locking levers</p> 	Female insert				CE	7 mm	10
	Male insert				CE	7 mm	10
 <p>Latching frame with locking levers</p> 	Female insert				CE	7 mm	10
	Male insert				CE	7 mm	10

revos

Contacts for crimp version

Female contacts



Male contacts



Crimping tool
Crimping die "B"
Contact positioner "3"
Extraction tool

Ø mm ²	AWG	Part no.	Stand. pack	Ø mm ²	AWG	Part no.	Stand. pack	
tin-plated				gold-plated				
0.5	20 AWG	02.123.7021.0	200	0.5	20 AWG	02.123.7001.0	200	
0.75 - 1	18 AWG	02.123.7121.0	200	0.75 - 1	18 AWG	02.123.7101.0		
1.5	16 AWG	02.123.7221.0	200	1.5	16 AWG	02.123.7201.0		
2.5	14 AWG	02.123.7321.0	200	2.5	14 AWG	02.123.7301.0		
4	12 WG	02.123.7421.0	200	4	12 WG	02.123.7401.0		
tin-plated				gold-plated				
0.5	20 AWG	05.543.7021.0	200	0.5	20 AWG	05.543.7001.0	200	
0.75 - 1	18 AWG	05.543.7121.0	200	0.75 - 1	18 AWG	05.543.7101.0		
1.5	16 AWG	05.543.7221.0	200	1.5	16 AWG	05.543.7201.0		
2.5	14 AWG	05.543.7321.0	200	2.5	14 AWG	05.543.7301.0		
4	12 AWG	05.543.7421.0	200	4	12 AWG	05.543.7401.0		
Crimping tool			95.101.0800.0	Crimping die "B"			05.502.2100.0	silver-plated upon request
Contact positioner "3"			05.502.3300.0	Extraction tool			05.502.3500.0	

6pole + ground 10pole + ground 16pole + ground 24pole + ground

Part no.	Part no.	Part no.	Part no.
Z5.570.4656.0	Z5.570.4756.0	Z5.570.4556.0	Z5.570.4856.0
Z5.571.4656.0	Z5.571.4756.0	Z5.571.4556.0	Z5.571.4856.0
Z5.570.5656.0	Z5.570.5756.0	Z5.570.5556.0	Z5.570.5856.0
Z5.571.5656.0	Z5.571.5756.0	Z5.571.5556.0	Z5.571.5856.0
Z5.570.7656.0	Z5.570.7756.0	Z5.570.7556.0	Z5.570.7856.0
Z5.571.7656.0	Z5.571.7756.0	Z5.571.7556.0	Z5.571.7856.0
Z5.570.9656.0	Z5.570.9756.0	Z5.570.9556.0	Z5.570.9856.0
Z5.571.9656.0	Z5.571.9756.0	Z5.571.9556.0	Z5.571.9856.0

Universal foot, 23 mm wide

05.583.0053.0

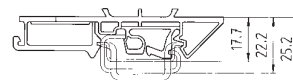

Delivered as standard component where indicated

Cut-out for latching frames

Sheet metal: 2 ± 0.05 mm thick

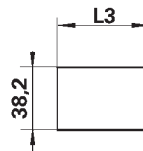

Housing size	L1 (mm)	L2 (mm)	L3 (mm)
6	67.5	74.1	62.5
10	80.9	87.5	75.9
16	101	106.5	96
24	127.8	134.4	122.8



Industrial multipole connectors

Multipole connector with latching frame

revos BASIC













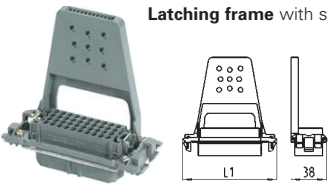

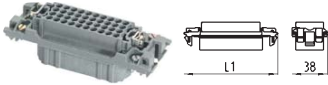

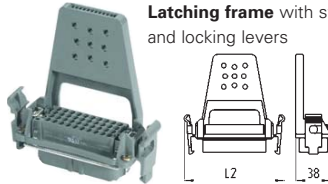

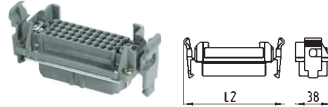
600 V CSA
250 V, 10 A IEC 61 984

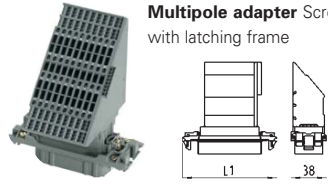
Latching frame to be inserted in sheet metal cut-out, and for use in cable to cable couplings.

Screw connection 0,5 – 2.5 mm² solid/fine stranded
 20 – 12 AWG
 Crimp connection 0,2 – 1.5 mm² fine stranded
 24 – 16 AWG
 Rated current 10 A
 Rated voltage VDE 250 V*
 Rated voltage CSA 600 V

* The mounting style might change the air and creepage distances and influence the rated voltage.

For accessories and marking facilities see page 788

		Approvals	Wire strip length	Stand. pack
 <p>Latching frame with strain relief</p>	Female insert in crimp version		4 mm	10
	Male insert in crimp version		4 mm	10
 <p>Latching frame</p>	Female insert in crimp version		4 mm	10
	Male insert in crimp version		4 mm	10
 <p>Latching frame with strain relief and locking levers</p>	Female insert in crimp version		4 mm	10
	Male insert in crimp version		4 mm	10
 <p>Latching frame with locking levers</p>	Female insert in crimp version		4 mm	10
	Male insert in crimp version		4 mm	10
 <p>Multipole adapter Screw version with latching frame</p>	Female insert, ground right		12 mm	4
	Female insert, ground right with U-foot			
	Female insert, ground left			
	Female insert, ground left with U-foot			
 <p>Multipole adapter Screw version with latching frame and locking levers</p>	Male insert, ground right		12 mm	4
	Male insert, ground right with U-foot			
	Male insert, ground left			
	Male insert, ground left with U-foot			

revos

Contacts for crimp version

Female contacts



Male contacts



Ø mm ²	AWG	Part no.	Stand. pack	Ø mm ²	AWG	Part no.	Stand. pack
0.2 – 0.56 mm ²	24 – 20	tin-plated		0.5 – 1.50 mm ²	20 – 16	gold-plated	
Reel contacts		02.124.0900.0	5000	Reel contacts		02.124.1400.0	5000
Single contacts		02.124.0929.0	200	Single contacts		02.124.1429.0	200
0.75 – 1.50 mm ²	18 – 16						
Reel contacts		02.124.1000.0	5000				
Single contacts		02.124.1029.0	200				
0.2 – 0.56 mm ²	24 – 20			0.5 – 1.50 mm ²	20 – 16		
Reel contacts		05.544.0900.0	5000	Reel contacts		05.544.1400.0	5000
Single contacts		05.544.0929.0	200	Single contacts		05.544.1429.0	200
0.75 – 1.50 mm ²	18 – 16						
Reel contacts		05.544.1000.0	5000				
Single contacts		05.544.1029.0	200				
				Crimping tool		95.101.0800.0	1
				Crimping die "E"		05.502.2400.0	1
				Contact positioner "2"		05.502.3200.0	1
				Extraction tool		05.502.0000.0	1

40pole + ground

64pole + ground

Part no.	Part no.
Z5.570.6056.0	Z5.570.6156.0
Z5.571.6056.0	Z5.571.6156.0
Z5.570.7056.0	Z5.570.7156.0
Z5.571.7056.0	Z5.571.7156.0
Z5.570.8056.0	Z5.570.8156.0
Z5.571.8056.0	Z5.571.8156.0
Z5.570.9056.0	Z5.570.9156.0
Z5.571.9056.0	Z5.571.9156.0
Z5.572.8356.0 Z5.572.9356.0 Z5.572.8056.0 Z5.572.9156.0	Z5.572.8456.0 Z5.572.9456.0 Z5.572.8156.0 Z5.572.9256.0
Z5.573.8356.0 Z5.573.9356.0 Z5.573.8056.0 Z5.573.9156.0	Z5.573.8456.0 Z5.573.9456.0 Z5.573.8156.0 Z5.573.9256.0
Z5.572.8956.0 Z5.572.9756.0 Z5.572.8656.0 Z5.572.9556.0	Z5.572.9056.0 Z5.572.9856.0 Z5.572.8756.0 Z5.572.9656.0
Z5.573.8956.0 Z5.573.9756.0 Z5.573.8656.0 Z5.573.9556.0	Z5.573.9056.0 Z5.573.9856.0 Z5.573.8756.0 Z5.573.9656.0

Universal foot, 23 mm wide

05.583.0053.0

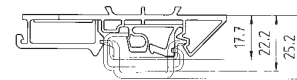

Delivered as standard component where indicated

Cut-out for latching frames

Sheet metal: 2 ± 0.05 mm thick

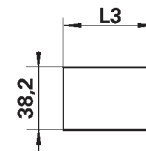

Housing size	L1 (mm)	L2 (mm)	L3 (mm)
40	101	106.5	96
64	127.8	134.4	122.8

Industrial Multipole Connector

EMC hoods and housings for multipole connectors

revos BASIC

Hood
10-/16-/24 pole



Open-bottom housing
10-/16-/24 pole

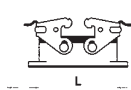

Hood
6 pole

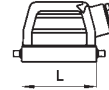

Open-bottom housing
6 pole

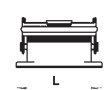

Suited for:
Multipole connector inserts
revos BASIC
revos FLEX

Hood

Picture only for
10-/16-/24 pole



Open-bottom
housing

Picture only for
10-/16-/24 pole



Number of poles	Thread	Cable gland type	L	W	H	Stand. pack	Part no.	Part no.
Housing size 6 for multipole connectors 6pole + ground single locking lever	M 20	1 with thread	80	48	30.3	1	70.350.0645.1	70.320.0638.0
	M 25	1 with thread	60	43	51		70.353.0645.1	
	M 32	1 with thread	60	43	70		73.353.0645.1	
Housing size 10 for multipole connectors 10pole + ground double locking levers	M 25	1 with thread	93	48	30.3	1	70.350.1045.1	70.320.1038.0
	M 32	1 with thread	73	43	51		73.353.1045.1	
Housing size 16 for multipole connectors 16pole + ground double locking levers	M 32	1 with thread	113	48	30.3	1	70.353.1645.1	70.320.1638.0
	M 32	1 with thread	93.5	43	62		73.353.4045.1	
Housing size 24 for multipole connectors 24pole + ground double locking levers	M 32	1 with thread	140	48	30.3	1	70.353.2445.1	70.320.2438.0
	M 32	1 with thread	120	43	62		73.353.6445.1	

Mounting dimensions
and cut-outs for
open-bottom housings

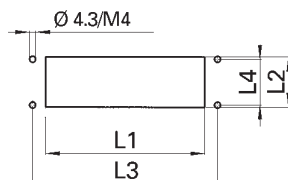

Housing size	Cut-out (mm)		Mounting dimensions (mm)	
	L1	L2	L3	L4
6	52	35	70	32
10	65	35	83	32
16	85,5	35	103	32
24	112	35	130	32

Cable gland for EMC hoods/housings

Z5.507.4821.0 M 20
Z5.507.5021.0 M 25
Z5.507.5221.0 M 32



EMC hoods and housings for multipole connectors

revos

Multipole connectors function as an interface between the individual system components and influence the function of the entire system.

For this reason, Wieland Electric GmbH offers electromagnetic compatible (EMC) hoods and housings which help to maintain the function of the entire system.

In former times we had to cope with the danger of interrupted cable shielding whenever they were connected via multipole connectors. The electrical signals could not sufficiently be shielded against electromagnetic fields.

The solution:

- ❑ Contact is made by putting an open shield over a special EMC cable gland for ground connection between the cable and the connector.
- ❑ Contact between the hood and the housing via a HF gasket (silver-plated contact zone). When the hood is plugged together with the housing, the unit forms a maze which guarantees the EMC protection on this interface.
- ❑ By means of screws, the housing is mounted to a metal partition plate for ground connection.
- ❑ Highly conductive surface plating of the EMC hoods and housings for improved contacting on the individual interfaces.

System advantages:

- ➔ High screening attenuation
- ➔ 360° HF overall protection
- ➔ Highly conductive surface of the hoods and housings
- ➔ 6/10/16/24pole hood and housing sizes in high and flat design
- ➔ Different hood and housing variants
- ➔ Degree of protection IP 65 with closed locking levers

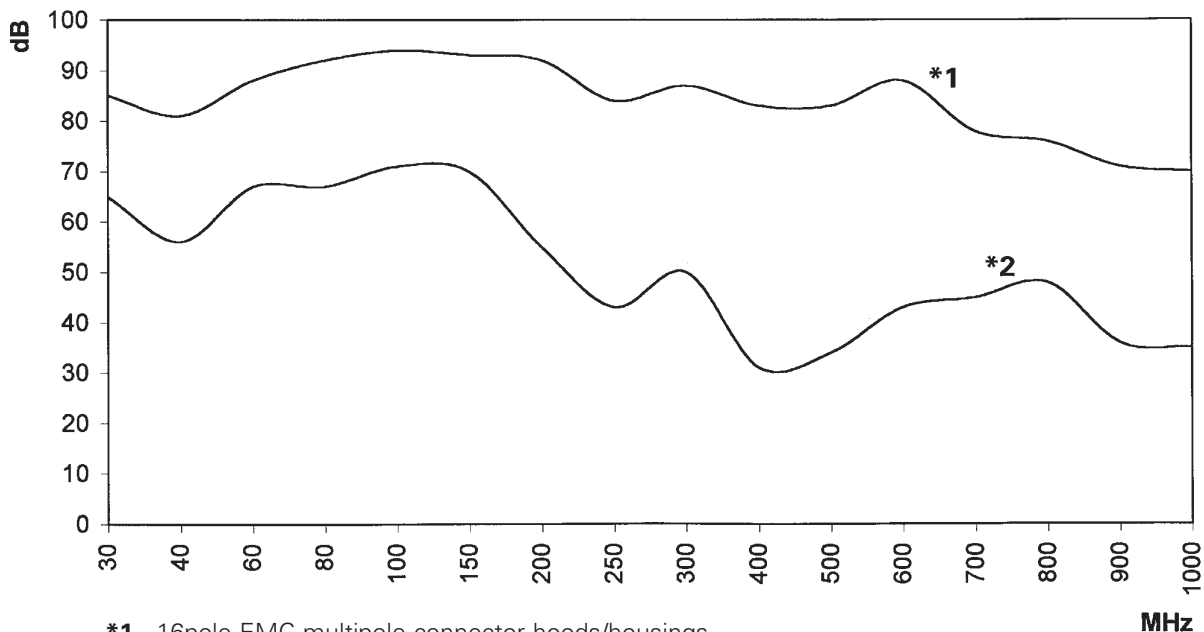

*1 16pole EMC multipole connector hoods/housings

*2 16pole standard multipole connector hoods/housings with EMC cable glands

Industrial multipole connectors

revos POWER S

Technical information

■ Approvals

UL, CSA, SEV, MEEI

■ Applicable standards

IEC 61 984

■ Contact inserts

Number of poles	6 + ground	/ 6 + ground	/ 4 + ground
Rated current	35 A	/ 35 A	/ 82 A
Rated voltage	400 V	/ 690 V	/ 690/400 V
Screw connection	2.5 – 6 mm ²	/ 2.5 – 6 mm ²	/ 6 – 16 mm ²
	14 – 8 AWG	/ 14 – 8 AWG	/ 10 – 4 AWG

Number of poles	4/6 + ground	/ 6/6 + ground
Rated current	35/16 A	/ 40/16 A
Rated voltage	690 V	/ 690/400 V + 400/230 V
Screw connection	4 x 2.5 – 6 mm ²	/ 6 x 4 – 10 mm ²
	4 x 14 – 8 AWG	/ 6 x 12 – 6 AWG
	6 x 1 – 2.5 mm ²	/ 6 x 1 – 2.5 mm ²
	6 x 16 – 12 AWG	/ 6 x 16 – 12 AWG

Number of poles	3/3/6 + ground	/ 4/2 + ground
Rated current	100/40/16 A	/ 82/16 A (70/16 A CSA)
Rated voltage	690/400 V	/ 690 V
	690/400 V	/ 400 V
	400/230 V	
Screw connection	3 x 10 – 25 mm ²	/ 4 x 6 – 16 mm ²
	3 x AWG 8 – 2	/ 4 x AWG 10 – 4
	3 x 4 – 10 mm ²	/ 2 x 1 – 2.5 mm ²
	3 x AWG 12 – 6	/ 2 x AWG 16 – 12
	6 x 1 – 2.5 mm ²	
	6 x AWG 16 – 12	

Nominal voltage accord. to UL	600 V
Nominal voltage accord. to CSA	600 V
Degree of pollution	3
Temperature range	–40 to +110 °C

■ Multipole adapters

Number of poles	6 + ground	/ 6 + ground	/ 4/6 + ground
Rated current	35 A	/ 35 A	/ 35/16 A
Rated voltage	400 V	/ 690 V	/ 500 V
Screw connection	2.5 – 6.0 mm ²	/ 2.5 – 6.0 mm ²	/ 4 x 2.5 – 6.0 mm ² / 6 x 1.5 – 4 mm ²
	14 – 8 AWG	/ 14 – 8 AWG	/ 4 x 14 – 8 AWG / 6 x 16 – 12 AWG

Nominal voltage accord. to UL	600 V
Nominal voltage accord. to CSA	600 V
Degree of pollution	3
Temperature range	–40 to +110 °C

■ Contacts

Material	copper alloy
Surface	tin-plated
Surface	silver-plated

■ Hoods and housings

Material	die cast aluminum alloy
Surface	silver gray, silicon-free finish
Locking levers	zinc-plated steel
Gaskets	NBR
Temperature range	–40 to +110 °C
Degree of protection accord. to DIN EN 60 529	
with latched locking levers	IP 55
with appropriate cable glands	IP 65

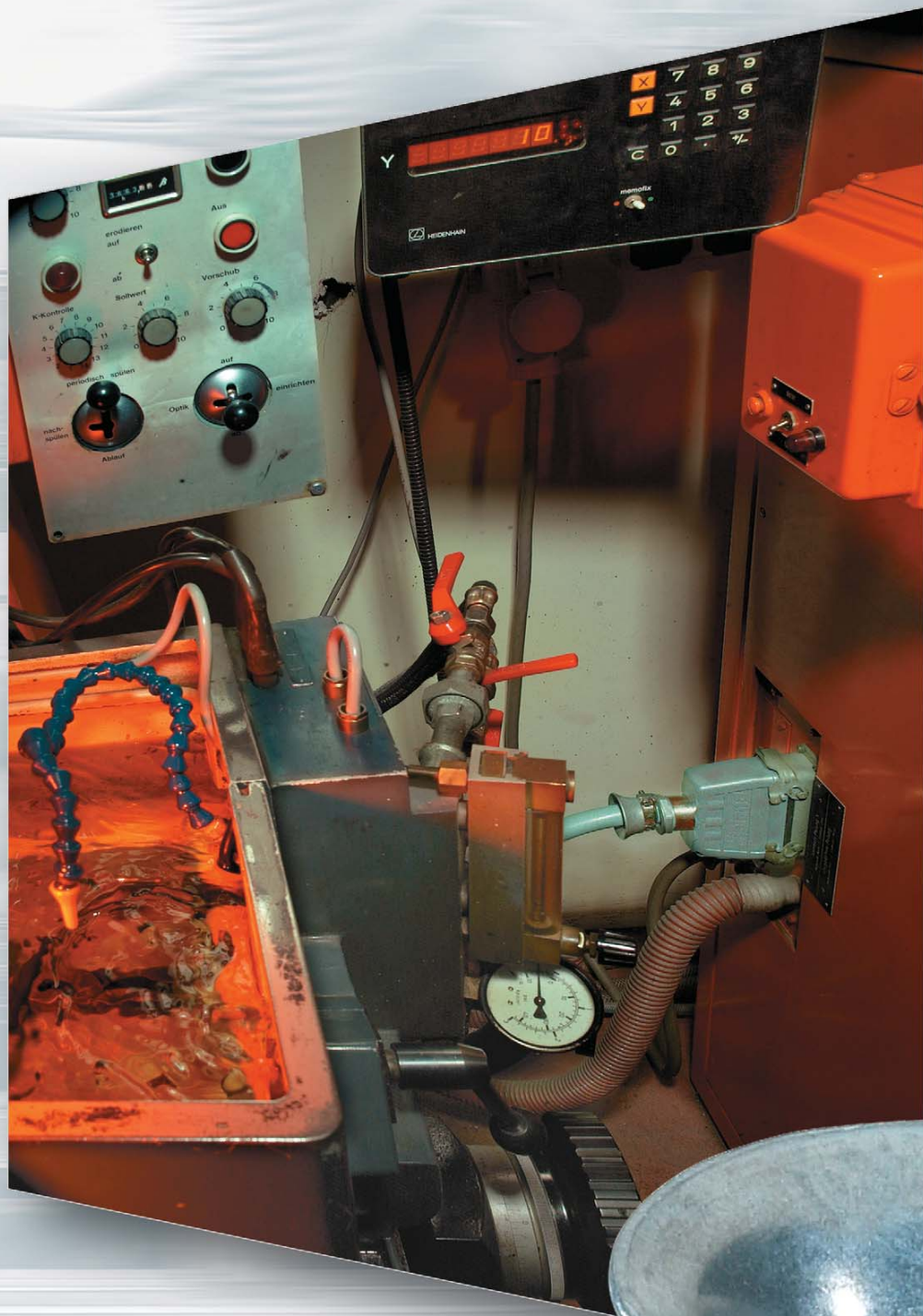

Industrial Multipole Connectors

Industrial multipole connectors, female and male inserts, multipole adapters, hoods and housings with single locking levers, 6pole











revos POWER



600 V UL/CSA

400 V, 35 A IEC 61 984

Degrees of protection: **IP 55; IP 65** with the appropriate cable glands

		Cross section	Approvals	Wire strip length	Material	Stand. pack
 <p>Screw connection</p>	Female insert	2.5 – 6 mm ² 14 – 8 AWG		10 mm	silver-plated	10
	Male insert	2.5 – 6 mm ² 14 – 8 AWG		10 mm	silver-plated	10
 <p>Screw connection Multipole adapters</p>	Female insert, ground right	2.5 – 6 mm ² 14 – 8 AWG		12 mm	silver-plated	10
	Female insert, ground left	2.5 – 6 mm ² 14 – 8 AWG		12 mm	silver-plated	10
	Male insert, ground right	2.5 – 6 mm ² 14 – 8 AWG		12 mm	silver-plated	10
	Male insert, ground left	2.5 – 6 mm ² 14 – 8 AWG		12 mm	silver-plated	10
<p>Number of poles</p> <p>Thread</p> <p>Cable gland type</p>						Stand. pack
<p>Housing size 16 for multipole connectors 6pole + ground</p>		<p>0 with cable gland 1 with thread 2 with intermediate support 3 with strain relief</p>				1
		<p>Open-bottom housing</p>		<p>Closed-bottom housing with two narrow-side entry cable glands</p>		<p>Closed bottom housing with one narrow-side entry cable gland on the left</p>
						
<p>Number of poles</p> <p>Thread</p> <p>Cable gland type</p> <p>Stand. pack</p>		<p>Part no.</p>		<p>Part no.</p>		<p>Part no.</p>
<p>Housing size 16 for multipole connectors 6pole + ground</p>		<p>0 with cable gland 1 with thread</p>		<p>71.320.1628.0 71.330.1635.0 71.330.1635.1</p>		<p>71.331.1635.0 71.331.1635.1</p>

revos

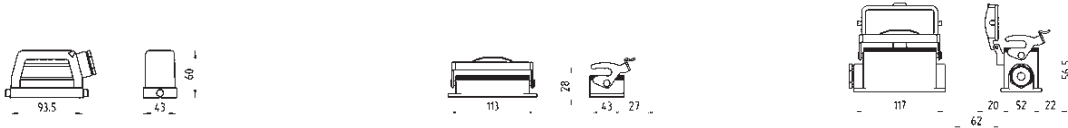

6pole + ground

Part no.

70.200.0653.0

70.210.0653.0

70.005.0653.0

70.000.0653.0

70.015.0653.0

70.010.0653.0

Pole assignment
 Male insert 6pole + ground
 Female insert 6pole + ground

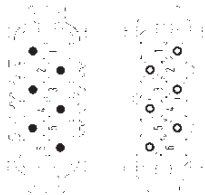

Dimensions of the multipole adapters

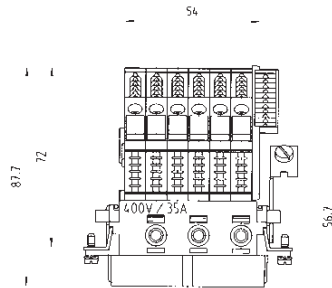

Mounting dimensions and cut-outs for open-bottom housings

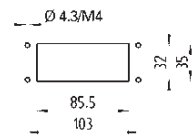

Mounting dimensions for closed-bottom housings

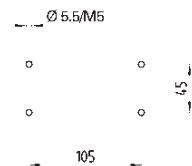

Part no.	Part no.	Part no.
71.350.1635.0 71.350.1635.1 71.350.1635.2 71.350.1635.3	71.351.1635.0 71.351.1635.1 71.351.1635.2 71.351.1635.3	71.352.1635.0 71.352.1635.1 71.352.1635.2 71.352.1635.3

Part no.	Part no.	Part no.	Part no.	Part no.	Part no.
Closed-bottom housing with two bottom entry cable glands	Open-bottom housing with protective cover	Closed-bottom housing with two narrow-side entry cable glands and protective cover	Closed-bottom housing with narrow-side entry cable gland on the left and protective cover	Closed-bottom housing with narrow-side entry cable gland on the left and protective cover	Closed-bottom housing with bottom entry cable gland and protective cover
71.333.1635.0 71.333.1635.1	71.325.1628.0	71.340.1635.0 71.340.1635.1	71.341.1635.0 71.341.1635.1	71.342.1635.0 71.342.1635.1	71.343.1635.0 71.343.1635.1



Industrial multipole connectors, female and male inserts, multipole adapters, hoods and housings with double locking levers, 6pole









revos POWER



600 V UL/CSA

400 V, 35 A IEC 61 984

Degree of protection: IP 55; IP 65 with the appropriate cable glands

		Cross section	Approvals	Wire strip length	Material	Stand. pack
 <p>Screw connection</p>	Female insert	2.5 – 6 mm ² 14 – 8 AWG		10 mm	silver-plated	10
	Male insert	2.5 – 6 mm ² 14 – 8 AWG		10 mm	silver-plated	10
 <p>Screw connection Multipole adapters</p>	Female insert, ground right	2.5 – 6 mm ² 14 – 8 AWG		12 mm	silver-plated	10
	Female insert, ground left	2.5 – 6 mm ² 14 – 8 AWG		12 mm	silver-plated	10
	Male insert, ground right	2.5 – 6 mm ² 14 – 8 AWG		12 mm	silver-plated	10
	Male insert, ground left	2.5 – 6 mm ² 14 – 8 AWG		12 mm	silver-plated	10
<p>Number of poles</p> <p>Thread</p> <p>Cable gland type</p> <p>Stand. pack</p>						
<p>Housing size 16 for multipole connectors 6pole + ground</p>		M 25	<p>0 with cable gland</p> <p>1 with thread</p> <p>2 with intermediate support</p> <p>3 with strain relief</p>	1		
			Open-bottom housing	Closed-bottom housing with two narrow-side entry cable glands	Closed bottom housing with one narrow-side entry cable gland on the left	
						
<p>Number of poles</p> <p>Thread</p> <p>Cable gland type</p> <p>Stand. pack</p>			Part no.	Part no.	Part no.	
<p>Housing size 16 for multipole connectors 6pole + ground</p>		M 25	<p>0 with cable gland</p> <p>1 with thread</p>	<p>70.320.1628.0</p>	<p>70.330.1635.0</p> <p>70.330.1635.1</p>	<p>70.331.1635.0</p> <p>70.331.1635.1</p>

revos

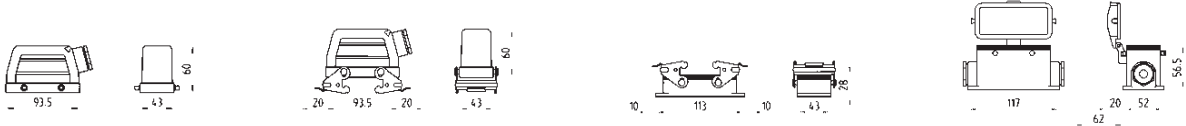

6pole + ground

Part no.	Pole assignment		Dimensions of the multipole adapters	Mounting dimensions and cut-outs for open-bottom housings
	Male insert 6pole + ground	Female insert 6pole + ground		
70.200.0653.0				
70.210.0653.0				
70.005.0653.0				
70.000.0653.0				
70.015.0653.0				
70.010.0653.0				

Part no.	Part no.	Part no.	Part no.	Part no.	Part no.
70.350.1635.0 70.350.1635.1 70.350.1635.2 70.350.1635.3	70.351.1635.0 70.351.1635.1 70.351.1635.2 70.351.1635.3	70.352.1635.0 70.352.1635.1 70.352.1635.2 70.352.1635.3	70.355.1635.0 70.355.1635.1 70.355.1635.2 70.355.1635.3	70.356.1635.0 70.356.1635.1 70.356.1635.2 70.356.1635.3	70.357.1635.0 70.357.1635.1 70.357.1635.2 70.357.1635.3
70.333.1635.0 70.333.1635.1	70.325.1628.0	70.340.1635.0 70.340.1635.1	70.341.1635.0 70.341.1635.1	70.342.1635.0 70.342.1635.1	70.343.1635.0 70.343.1635.1



Industrial multipole connectors, female and male inserts, multipole adapters, hoods and housings with single locking levers, 6pole











revos POWER



600 V UL/CSA

690 V, 35 A IEC 61 984

Degrees of protection: **IP 55; IP 65** with the appropriate cable glands

		Cross section	Approvals	Wire strip length	Material	Stand. pack
 <p>Screw connection</p>	Female insert	2.5 – 6 mm ² 14 – 8 AWG		10 mm	silver-plated	10
	Male insert	2.5 – 6 mm ² 14 – 8 AWG		10 mm	silver-plated	10
 <p>Screw connection Multipole adapters</p>	Female insert, ground right	2.5 – 6 mm ² 14 – 8 AWG		12 mm	silver-plated	10
	Female insert, ground left	2.5 – 6 mm ² 14 – 8 AWG		12 mm	silver-plated	10
	Male insert, ground right	2.5 – 6 mm ² 14 – 8 AWG		12 mm	silver-plated	10
	Male insert, ground left	2.5 – 6 mm ² 14 – 8 AWG		12 mm	silver-plated	10
<p>Number of poles</p> <p>Housing size 16 for multipole connectors 6pole + ground</p>		<p>Thread</p> <p>M 25</p>	<p>Cable gland type</p> <p>0 with cable gland 1 with thread 2 with intermediate support 3 with strain relief</p>	<p>Stand. pack</p> <p>1</p>		
			<p>Open-bottom housing</p> 	<p>Closed-bottom housing with two narrow-side entry cable glands</p> 	<p>Closed bottom housing with one narrow-side entry cable gland on the left</p> 	
<p>Number of poles</p> <p>Housing size 16 for multipole connectors 6pole + ground</p>		<p>Thread</p> <p>M 25</p>	<p>Cable gland type</p> <p>0 with cable gland 1 with thread</p>	<p>Stand. pack</p> <p>1 1 1</p>	<p>Part no.</p> <p>71.320.1628.0 71.330.1635.0 71.330.1635.1</p>	<p>Part no.</p> <p>71.331.1635.0 71.331.1635.1</p>

revos

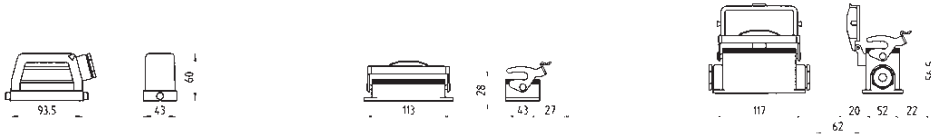

6pole + ground

Part no.

72.200.0653.0

72.210.0653.0

72.005.0653.0

72.000.0653.0

72.015.0653.0

72.010.0653.0

Pole assignment
 Male insert 6pole + ground
 Female insert 6pole + ground

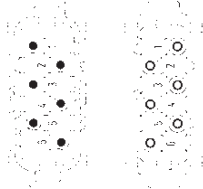

Dimensions of the multipole adapters

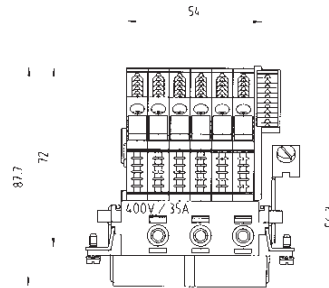

Mounting dimensions and cut-outs for open-bottom housings

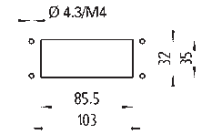

Mounting dimensions for closed-bottom housings

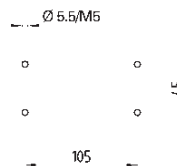

Part no.

71.350.1635.0
 71.350.1635.1
 71.350.1635.2
 71.350.1635.3

Part no.

71.351.1635.0
 71.351.1635.1
 71.351.1635.2
 71.351.1635.3

Part no.

71.352.1635.0
 71.352.1635.1
 71.352.1635.2
 71.352.1635.3

Closed-bottom housing with two bottom entry cable glands



Part no.

71.333.1635.0
 71.333.1635.1

Open-bottom housing with protective cover



Part no.

71.325.1628.0

Closed-bottom housing with two narrow-side entry cable glands and protective cover



Part no.

71.340.1635.0
 71.340.1635.1

Closed-bottom housing with narrow-side entry cable gland on the left and protective cover



Part no.

71.341.1635.0
 71.341.1635.1

Closed-bottom housing with narrow-side entry cable gland on the left and protective cover



Part no.

71.342.1635.0
 71.342.1635.1

Closed-bottom housing with bottom entry cable gland and protective cover



Part no.

71.343.1635.0
 71.343.1635.1



Industrie multipole connectors, female and male inserts, multipole adapters, hoods and housings with double locking levers, 6pole

revos POWER



600 V UL/CSA

690 V, 35 A IEC 61 984

Degrees of protection: **IP 55; IP 65** with the appropriate cable glands

		Cross section	Approvals	Wire strip length	Material	Stand. pack
 <p>Screw connection</p>	Female insert	2.5 – 6 mm ² 14 – 8 AWG		10 mm	tin-plated	10
	Male insert	2.5 – 6 mm ² 14 – 8 AWG		10 mm	tin-plated	10
 <p>Screw connection Multipole adapters</p>	Female insert, ground right	2.5 – 6 mm ² 14 – 8 AWG		12 mm	tin-plated	10
	Female insert, ground left	2.5 – 6 mm ² 14 – 8 AWG		12 mm	tin-plated	10
	Male insert, ground right	2.5 – 6 mm ² 14 – 8 AWG		12 mm	tin-plated	10
	Male insert, ground left	2.5 – 6 mm ² 14 – 8 AWG		12 mm	tin-plated	10
<p>Number of poles</p> <p>Thread</p> <p>Cable gland type</p> <p>Stand. pack</p>						
<p>Housing size 16 for multipole connectors 6pole + ground</p>		<p>0 with cable gland 1 with thread 2 with intermediate support 3 with strain relief</p>		<p>Stand. pack</p> <p>1</p>		
		Open-bottom housing	Closed-bottom housing with two narrow-side entry cable glands	Closed bottom housing with one narrow-side entry cable gland on the left		
						
<p>Number of poles</p> <p>Thread</p> <p>Cable gland type</p> <p>Stand. pack</p>		<p>Part no.</p>	<p>Part no.</p>	<p>Part no.</p>		
<p>Housing size 16 for multipole connectors 6pole + ground</p>		<p>0 with cable gland</p> <p>1 with thread</p>	<p>70.320.1628.0</p>	<p>70.330.1635.0</p> <p>70.330.1635.1</p>	<p>70.331.1635.0</p> <p>70.331.1635.1</p>	

revos



6pole + ground

Part no.

72.200.0653.0

72.210.0653.0

72.005.0653.0

72.000.0653.0

72.015.0653.0

72.010.0653.0

Pole assignment
Male insert 6pole + ground Female insert 6pole + ground

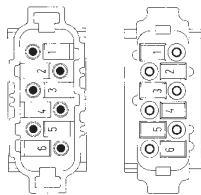

Dimensions of the multipole adapters

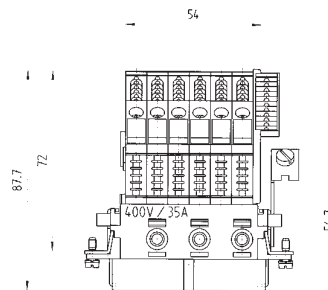

Mounting dimensions and cut-outs for open-bottom housings

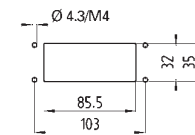

Mounting dimensions for closed-bottom housings

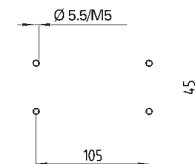

Hood	Hood	Hood	Hood with locking levers	Hood with locking levers	Hood with locking levers
Part no. 70.350.1635.0 70.350.1635.1 70.350.1635.2 70.350.1635.3	Part no. 70.351.1635.0 70.351.1635.1 70.351.1635.2 70.351.1635.3	Part no. 70.352.1635.0 70.352.1635.1 70.352.1635.2 70.352.1635.3	Part no. 70.355.1635.0 70.355.1635.1 70.355.1635.2 70.355.1635.3	Part no. 70.356.1635.0 70.356.1635.1 70.356.1635.2 70.356.1635.3	Part no. 70.357.1635.0 70.357.1635.1 70.357.1635.2 70.357.1635.3
Closed-bottom housing with two bottom entry cable glands	Open-bottom housing with protective cover	Closed-bottom housing with two narrow-side entry cable glands and protective cover	Closed-bottom housing with narrow-side entry cable gland on the left and protective cover	Closed-bottom housing with narrow-side entry cable gland on the left and protective cover	Closed-bottom housing with bottom entry cable gland and protective cover
Part no. 70.333.1635.0 70.333.1635.1	Part no. 70.325.1628.0	Part no. 70.340.1635.0 70.340.1635.1	Part no. 70.341.1635.0 70.341.1635.1	Part no. 70.342.1635.0 70.342.1635.1	Part no. 70.343.1635.0 70.343.1635.1



Industrial multipole connectors, female and male inserts, multipole adapters, hoods and housings with single locking levers, 4pole







revos POWER



600 V UL/CSA

690 V/400 V, 82 A IEC 61 984

Degrees of protection: **IP 55; IP 65** with the appropriate cable glands

		Cross section	Approvals	Wire strip length	Material	Stand. pack
 <p>Screw connection</p>	Female insert	6 – 16 mm ² 10 – 4 AWG		10 mm	silver-plated	10
	Male insert	6 – 16 mm ² 10 – 4 AWG		10 mm	silver-plated	10
<p>Number of poles</p> <p>Thread</p> <p>Cable gland type</p> <p>Stand. pack</p>						
<p>Housing size 16 for multipole connectors 4pole + ground</p>		<p>0 with cable gland 1 with thread 2 with intermediate support 3 with strain relief</p>		<p>1</p>		
		Open-bottom housing	Closed-bottom housing with two narrow-side entry cable glands	Closed bottom housing with one narrow-side entry cable gland on the left		
						
<p>Number of poles</p> <p>Thread</p> <p>Cable gland type</p> <p>Stand. pack</p>		Part no.	Part no.	Part no.		
<p>Housing size 16 for multipole connectors 4pole + ground</p>		71.320.1628.0	76.334.4035.0 76.334.4035.1	76.335.4035.0 76.335.4035.1		

revos

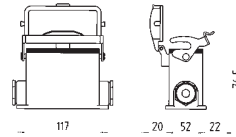
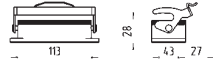
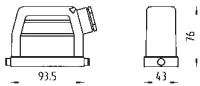

4pole + ground

Pole assignment
 Male insert 4pole + ground Female insert 4pole + ground

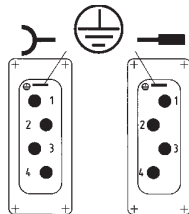

Part no.
72.208.0453.0





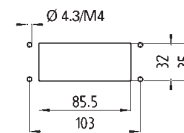

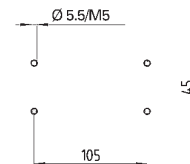

72.218.0453.0

Mounting dimensions and cut-outs for open-bottom housings



Mounting dimensions for closed-bottom housings



Hood	Hood				
					
Part no. 76.353.4035.0 76.353.4035.1 76.353.4035.2 76.353.4035.3	Part no. 76.352.4035.0 76.352.4035.1 76.352.4035.2 76.352.4035.3				
Closed-bottom housing with two bottom entry cable glands	Open-bottom housing with protective cover	Closed-bottom housing with two narrow-side entry cable glands and protective cover	Closed-bottom housing with narrow-side entry cable gland on the left and protective cover	Closed-bottom housing with narrow-side entry cable gland on the left and protective cover	Closed-bottom housing with bottom entry cable gland and protective cover
					
Part no. 76.337.4035.0 76.337.4035.1	Part no. 71.325.1628.0	Part no. 76.344.4035.0 76.344.4035.1	Part no. 76.345.4035.0 76.345.4035.1	Part no. 76.346.4035.0 76.346.4035.1	Part no. 76.347.4035.0 76.347.4035.1

revos

Industrial multipole connectors, female and male inserts, multipole adapters, hoods and housings with double locking levers, 4/6pole



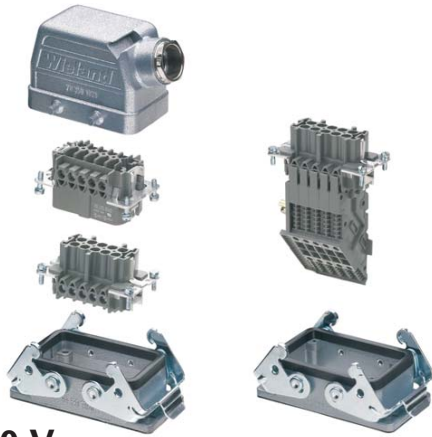



revos POWER



600 V UL/CSA

690 V, 35/16 A IEC 61 984

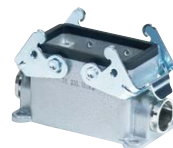
Degrees of protection: IP 55; IP 65 with the appropriate cable glands

		Cross section	Approvals	Wire strip length	Material	Stand. pack
 <p>Screw connection</p>	Female insert 4 poles silver-plated 6 poles tin-plated	2.5 – 6 mm ² 14 – 8 AWG 1 – 2.5 mm ² 16 – 12 AWG		10 mm 7 mm	silver-plated tin-plated	10
	Male insert 4 poles silver-plated 6 poles tin-plated	2.5 – 6 mm ² 14 – 8 AWG 1 – 2.5 mm ² 16 – 12 AWG		10 mm 7 mm	silver-plated tin-plated	10
 <p>Screw connection Multipole adapter 500 V, 35/16 A IEC 61 984</p>	Female insert, ground right 4 poles silver-plated 6 poles tin-plated	2.5 – 6 mm ² 14 – 8 AWG 1.5 – 4 mm ² 16 – 12 AWG		12 mm 12 mm	silver-plated tin-plated	10
	Male insert, ground right 4 poles silver-plated 6 poles tin-plated	2.5 – 6 mm ² 14 – 8 AWG 1.5 – 4 mm ² 16 – 12 AWG		12 mm 12 mm	silver-plated tin-plated	10
Number of poles	Thread	Cable gland type			Stand. pack	
Housing size 16 for multipole connectors 4/6pole + ground	M 25	0 with cable gland 1 with thread 2 with intermediate support 3 with strain relief			1	
		Open-bottom housing	Closed-bottom housing with two narrow-side entry cable glands	Closed bottom housing with one narrow-side entry cable gland on the left		
						
Number of poles	Thread	Cable gland type	Stand. pack	Part no.	Part no.	Part no.
Housing size 16 for multipole connectors 4/6pole + ground	M 25	0 with cable gland 1 with thread	1 1	72.320.1628.0	72.330.1635.0 72.330.1635.1	72.331.1635.0 72.331.1635.1

revos

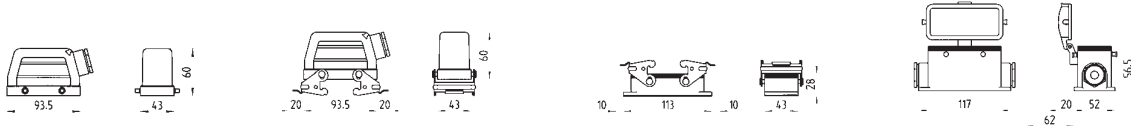

4/ 6pole + ground

Part no.

72.205.1053.0

72.215.1053.0

72.107.1053.0

72.117.1053.0

Pole assignment
 Male insert 4/6pole + ground
 Female insert 4/6pole + ground

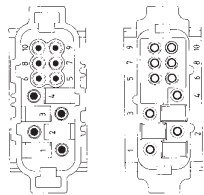

Dimensions of the multipole adapters

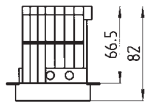
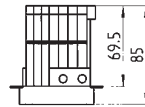

Mounting dimensions and cut-outs for open-bottom housings

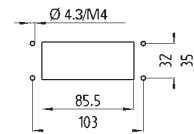

Mounting dimensions for closed-bottom housings

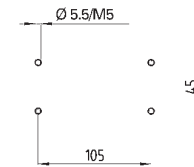

Hood	Hood	Hood with locking levers	Hood with locking levers

Part no.	Part no.	Part no.	Part no.
72.350.1635.0 72.350.1635.1 72.350.1635.2 72.350.1635.3	72.352.1635.0 72.352.1635.1 72.352.1635.2 72.352.1635.3	72.355.1635.0 72.355.1635.1 72.355.1635.2 72.355.1635.3	72.357.1635.0 72.357.1635.1 72.357.1635.2 72.357.1635.3

Closed-bottom housing with two bottom entry cable glands	Open-bottom housing with protective cover	Closed-bottom housing with two narrow-side entry cable glands and protective cover	Closed-bottom housing with narrow-side entry cable gland on the left and protective cover	Closed-bottom housing with narrow-side entry cable gland on the left and protective cover	Closed-bottom housing with bottom entry cable gland and protective cover

Part no.	Part no.	Part no.	Part no.	Part no.	Part no.
72.333.1635.0 72.333.1635.1	72.325.1628.0	72.340.1635.0 72.340.1635.1	72.341.1635.0 72.341.1635.1	72.342.1635.0 72.342.1635.1	72.343.1635.0 72.343.1635.1



Industrial multipole connectors, female and male inserts, multipole adapters, hoods and housings with single locking levers, 4/6pole



revos POWER



600 V UL/CSA

690 V, 35/16 A IEC 61 984

Degrees of protection: **IP 55; IP 65** with the appropriate cable glands

		Cross section	Approvals	Wire strip length	Material	Stand. pack
 <p>Screw connection</p>	Female insert	2.5 – 6 mm ² 14 – 8 AWG		10 mm	silver-plated	10
	4 poles silver-plated 6 poles tin-plated	1 – 2.5 mm ² 16 – 12 AWG		7 mm	tin-plated	
 <p>Screw connection</p>	Male insert	2.5 – 6 mm ² 14 – 8 AWG		10 mm	silver-plated	10
	4 poles silver-plated 6 poles tin-plated	1 – 2.5 mm ² 16 – 12 AWG		7 mm	tin-plated	
 <p>Screw connection Multipole adapter 500 V, 35/16 A 8 kV/3 VDE 0110</p>	Female insert, ground right	2.5 – 6 mm ² 14 – 8 AWG		12 mm	silver-plated	10
	4 poles silver-plated 6 poles tin-plated	1.5 – 4 mm ² 16 – 12 AWG		12 mm	tin-plated	
						10
Number of poles	Thread	Cable gland type	Stand. pack			
Housing size 16 for multipole connectors 4/6pole + ground	M 25	0 with cable gland 1 with thread 2 with intermediate support 3 with strain relief	1			
		Open-bottom housing	Closed-bottom housing with two narrow-side entry cable glands	Closed bottom housing with one narrow-side entry cable gland on the left		
						
Number of poles	Thread	Cable gland type	Stand. pack	Part no.	Part no.	Part no.
Housing size 16 for multipole connectors 4/6pole + ground	M 25	0 with cable gland 1 with thread	1 1	77.320.1628.0	77.330.1635.0 77.330.1635.1	77.331.1635.0 77.331.1635.1

revos

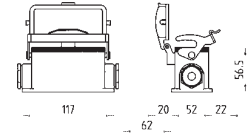
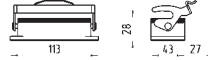
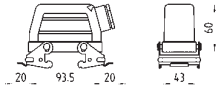

4/6pole + ground

Pole assignment
 Male insert 4/6pole + ground Female insert 4/6pole + ground

Dimensions of the multipole adapters (shown in mm)

Mounting dimensions and cut-outs for open-bottom housings (shown in mm)

Part no.

72.205.1053.0

72.215.1053.0

72.107.1053.0

72.117.1053.0

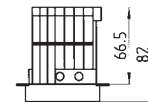
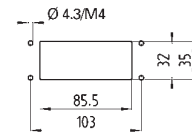
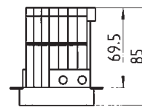
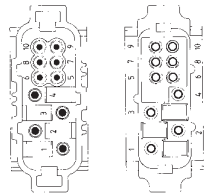

Mounting dimensions for closed-bottom housings

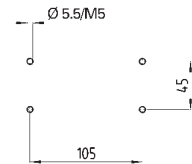

Hood

Hood



Part no.

77.350.1635.0
 77.350.1635.1
 77.350.1635.2
 77.350.1635.3

Part no.

77.352.1635.0
 77.352.1635.1
 77.352.1635.2
 77.352.1635.3

Closed-bottom housing with two bottom entry cable glands

Open-bottom housing with protective cover

Closed-bottom housing with two narrow-side entry cable glands and protective cover

Closed-bottom housing with narrow-side entry cable gland on the left and protective cover

Closed-bottom housing with narrow-side entry cable gland on the left and protective cover

Closed-bottom housing with bottom entry cable gland and protective cover



Part no.

77.333.1635.0
 77.333.1635.1

Part no.

77.325.1628.0

Part no.

77.340.1635.0
 77.340.1635.1

Part no.

77.341.1635.0
 77.341.1635.1

Part no.

77.342.1635.0
 77.342.1635.1

Part no.

77.343.1635.0
 77.343.1635.1

revos

Industrial multipole connectors, female and male inserts, multipole adapters, hoods and housings, 6/6pole

revos POWER







Multipole connectors 40/16 A, with mixed contacts

600 V UL/CSA

690/400 V, 40 A IEC 61 984

400/230 V, 16 A IEC 61 984

Degrees of protection: IP 55; IP 65 with the appropriate cable glands

	Rated current	Cross section	Approvals	Wire strip length	Material	Stand. pack
 <p>Screw connection</p>	Female insert					
	6 poles	40 A 4 – 10 mm ² 12 – 6 AWG		10 mm	silver-plated	10
	6 poles	16 A 1 – 2.5 mm ² 16 – 12 AWG		7 mm	tin-plated	
	Male insert					
	6 poles	40 A 4 – 10 mm ² 12 – 6 AWG	10 mm	silver-plated	10	
	6 poles	16 A 1 – 2.5 mm ² 16 – 12 AWG	7 mm	tin-plated		
 <p>Hood with intermediate support</p>						
Number of poles	Thread	Cable gland type				Stand. pack
Housing size 16 for multipole connectors 6/6pole + ground	M 40	2 with intermediate support				1
 <p>Open-bottom housing</p>						
Number of poles						Stand. pack
Housing size 16 for multipole connectors 6/ 6pole + ground						1

revos

6/6pole + ground

Part no.

72.205.1253.0

72.215.1253.0

Pole assignment
 Male insert 6/6pole + ground Female insert 6/6pole + ground

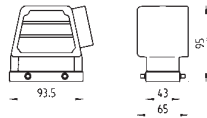
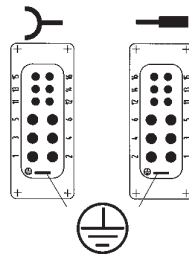

Part no.

72.250.1635.2

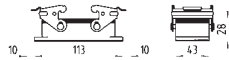

Part no.

72.320.1628.0

Mounting dimensions and cut-outs for open-bottom housings (shown in mm)

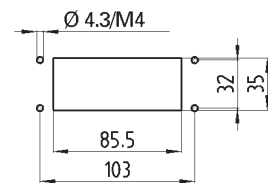

revos

Industrial multipole connectors, female and male inserts, multipole adapters, hoods and housings, 3/3/6pole

revos POWER









Multipole connectors 100/40/16 A, with mixed contacts

600 V UL/CSA
690/400 V

100 A IEC 61 984
40 A IEC 61 984
16 A IEC 61 984

Degrees of protection: IP 55; IP 65 with the appropriate cable glands

	Rated current	Cross section	Approvals	Wire strip length	Material	Stand. pack
 <p>Screw connection</p>	Female insert 3 poles 100 A 10 – 25 mm ² 8 – 2 AWG 3 poles 40 A 4 – 10 mm ² 12 – 6 AWG 6 poles 16 A 1 – 2.5 mm ² 16 – 12 AWG			14 mm	silver-plated	10
	10 mm	silver-plated				
	Male insert 3 poles 100 A 10 – 25 mm ² 8 – 2 AWG 3 poles 40 A 4 – 10 mm ² 12 – 6 AWG 6 poles 16 A 1 – 2.5 mm ² 16 – 12 AWG			7 mm	tin-plated	10
	10 mm	tin-plated				
 <p>Hood with intermediate support</p>						
Number of poles	Thread	Cable gland type	Stand. pack			
Housing size 24 for multipole connectors 3/3/6pole + ground	M 50	2 with intermediate support	1			
 <p>Open-bottom housing</p>						
Number of poles						Stand. pack
Housing size 24 for multipole connectors 3/3/6pole + ground						1

revos

3/3/6pole + ground

Part no.

72.203.1253.0

72.213.1253.0

Part no.

72.250.2435.2

Part no.

72.320.2428.0

Pole assignment
Male insert 3/3/6pole + ground Female insert 3/3/6pole + ground

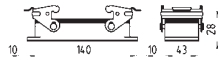
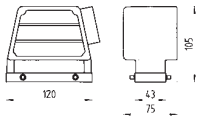
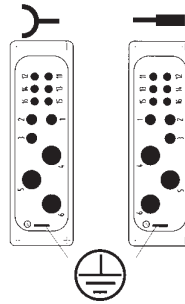

Mounting dimensions
and cut-outs for
open-bottom housings
(shown in mm)

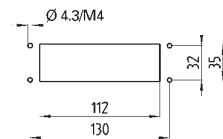

revos

Industrial multipole connectors, female and male inserts, hoods and housings with single locking levers, 4/2pole

revos POWER









Multipole connectors 82/16 A, with mixed contacts

600 V UL/CSA

690 V 82 A IEC 61 984 (70 A CSA)

400 V 16 A IEC 61 984

Degrees of protection: IP 55; IP 65 with the appropriate cable glands

		Rated current	Cross section	Approvals	Wire strip length	Material	Stand. pack
 <p>Screw connection</p>	Female insert						10
	4 poles	82 A (70 A CSA)	6 – 16 mm ²		10 – 4 AWG	15 mm	
	2 poles	16 A	1 – 2.5 mm ²	16 – 12 AWG	9 mm	tin-plated	
	Male insert						10
	4 poles	82 A (70 A CSA)	6 – 16 mm ²		10 – 4 AWG	15 mm	
	2 poles	16 A	1 – 2.5 mm ²	16 – 12 AWG	9 mm	tin-plated	
Number of poles	Thread	Cable gland type			Stand. pack		
Housing size 16 for multipole connectors 4/2pole + ground	M 32	0 with cable gland 1 with thread 2 with intermediate support 3 with strain relief			1		
		Open-bottom housing		Closed-bottom housing with two narrow-side entry cable glands	Closed bottom housing with one narrow-side entry cable gland on the left		
							
Number of poles	Thread	Cable gland type	Stand. pack	Part no.	Part no.	Part no.	
Housing size 16 for multipole connectors 4/2pole + ground	M 32	0 with cable gland	1	71.320.1628.0	76.334.4035.0	76.335.4035.0	
		1 with thread	1		76.334.4035.1	76.335.4035.1	

revos

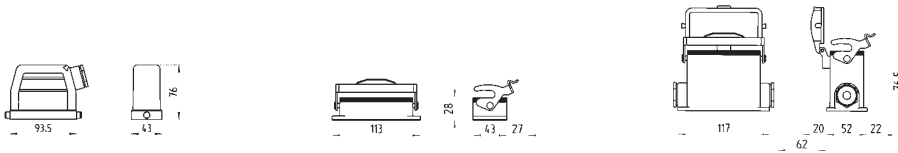

4/2pole + ground		Pole assignment		Mounting dimensions and cut-outs for open-bottom housings (shown in mm)	
		Male insert 4/2pole + ground	Female insert 4/2pole + ground		
Part no.					
72.205.0653.0	72.215.0653.0				
Hood	Hood				
Part no.	Part no.				
76.353.4035.0 76.353.4035.1 76.353.4035.2 76.353.4035.3	76.354.4035.0 76.354.4035.1 76.354.4035.2 76.354.4035.3				
Closed-bottom housing with two bottom entry cable glands	Open-bottom housing with protective cover	Closed-bottom housing with two narrow-side entry cable glands and protective cover	Closed-bottom housing with narrow-side entry cable gland on the left and protective cover	Closed-bottom housing with narrow-side entry cable gland on the left and protective cover	Closed-bottom housing with bottom entry cable gland and protective cover
Part no.	Part no.	Part no.	Part no.	Part no.	Part no.
76.337.4035.0 76.337.4035.1	71.325.1628.0	76.344.4035.0 76.344.4035.1	76.345.4035.0 76.345.4035.1	76.346.4035.0 76.346.4035.1	76.347.4035.0 76.347.4035.1







Industrial multipole connectors, female and male inserts, hoods and housings with double locking levers, 4/2pole

revos POWER



Multipole connectors 82/16 A, with mixed contacts
600 V UL/CSA
690 V 82 A IEC 61 984 (70 A CSA)
400 V 16 A IEC 61 984

Degrees of protection: IP 55; IP 65 with the appropriate cable glands

		Rated current	Cross section	Approvals	Wire strip length	Material	Stand. pack
 <p>Screw connection</p>	Female insert	4 poles 82 A (70 A CSA)	6 – 16 mm ² 10 – 4 AWG		15 mm	silver-plated	10
		2 poles	16 A 1 – 2.5 mm ² 16 – 12 AWG		9 mm	tin-plated	
	Male insert	4 poles 82 A (70 A CSA)	6 – 16 mm ² 10 – 4 AWG		15mm	silver-plated	10
	2 poles	16 A 1 – 2.5 mm ² 16 – 12 AWG	9 mm		tin-plated		
Number of poles	Thread	Cable gland type			Stand. pack		
Housing size 16 for multipole connectors 4/2pole + ground	M 32	0 with cable gland 1 with thread 2 with intermediate support 3 with strain relief			1		
		Open-bottom housing		Closed-bottom housing with two narrow-side entry cable glands	Closed bottom housing with one narrow-side entry cable gland on the left		
							
Number of poles	Thread	Cable gland type	Stand. pack	Part no.	Part no.	Part no.	
Housing size 16 for multipole connectors 4/2pole + ground	M 32	0 with cable gland	1	70.320.1628.0	73.334.4035.0	73.335.4035.0	
		1 with thread	1		73.334.4035.1	73.335.4035.1	

revos

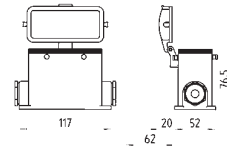
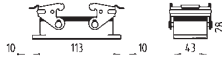
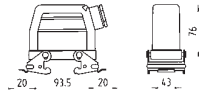
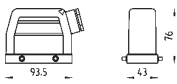

4/2pole + ground

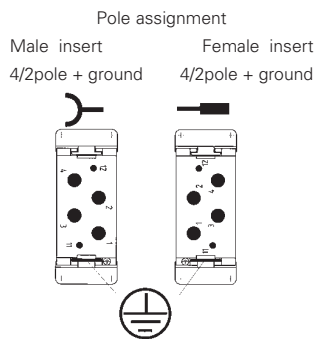

Part no.
72.205.0653.0

72.215.0653.0

Mounting dimensions and cut-outs for open-bottom housings (shown in mm)

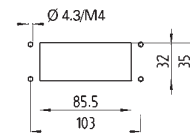

Mounting dimensions for closed-bottom housings (shown in mm)

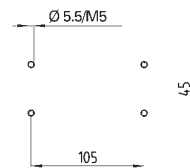

Part no. 73.353.4035.0 73.353.4035.1 73.353.4035.2 73.353.4035.3	Part no. 73.352.4035.0 73.352.4035.1 73.352.4035.2 73.352.4035.3	Part no. 73.358.4035.0 73.358.4035.1 73.358.4035.2 73.358.4035.3	Part no. 73.357.4035.0 73.357.4035.1 73.357.4035.2 73.357.4035.3
--	--	--	--

Closed-bottom housing with two bottom entry cable glands	Open-bottom housing with protective cover	Closed-bottom housing with two narrow-side entry cable glands and protective cover	Closed-bottom housing with narrow-side entry cable gland on the left and protective cover	Closed-bottom housing with narrow-side entry cable gland on the left and protective cover	Closed-bottom housing with bottom entry cable gland and protective cover
Part no. 73.337.4035.0 73.337.4035.1	Part no. 70.325.1628.0	Part no. 73.344.4035.0 73.344.4035.1	Part no. 73.345.4035.0 73.345.4035.1	Part no. 73.346.4035.0 73.346.4035.1	Part no. 73.347.4035.0 73.347.4035.1



Industrial multipole connectors

revos MINI S

Technical information

■ Approvals	UL, CSA, SEV
■ Applicable standards	IEC 61 984
■ Contact inserts	
Rated current	10 A
Rated voltage	
– 3pole + ground in plastic housing	400 V
– 3pole + ground in metal housing	250/400 V
– 4pole + ground (plastic and metal housing)	400 V
– 7pole + ground in plastic housing	250 V
– 7pole + ground in metal housing	50 V
– 8pole (plastic and metal housing)	50 V
Nominal voltage accord. to UL/CSA	
– 3/4pole + ground (plastic and metal housing)	600 V
– 7pole + ground in plastic housing	600 V
– 7pole + ground in metal housing	42 V
– 8pole + ground (plastic and metal housing)	42 V
Pole configurations	3, 4, 7 + ground, 8
Screw connection	0.5 – 2.5 mm ² / 22 – 12 AWG
Crimp connection	0.2 – 1.5 mm ² / 24 – 16 AWG
Degree of pollution	3
Temperature range	–40 to +110 °C
■ Contacts	
Material	copper alloy
Surface	tin-plated, gold-plated, silver-plated
■ Hoods and housings	
Material	die cast aluminum alloy Thermoplast
Surface	gray
Locking levers	zinc-plated steel
Gaskets	NBR
Temperature range	–40 to +110 °C
Degree of protection accord. to DIN EN 60 529	
with latched locking levers	IP 54
with suitable cable gland	IP 65



Industrial Multipole Connectors

Industrial multipole connectors

3/4/7pole + ground / 8pole













revos MINI



600 V UL/CSA

250 V, 10 A IEC 61 984

Degrees of protection: IP 54; IP 65 with the appropriate cable glands

		Cross section	Approvals	Wire strip length	Material	Stand. pack
 <p>Screw connection</p>	Female insert	0.5 – 2.5 mm ² 3pole 18 – 16 AWG UL 4pole 22 – 12 AWG UL 3-/4pole 22 – 12 AWG CSA		4 mm	tin-plated (3pole) silver-plated (4pole)	10
	Male insert	0.5 – 2.5 mm ² 3pole 18 – 16 AWG UL 4pole 22 – 12 AWG UL 3-/4pole 22 – 12 AWG CSA		4 mm	tin-plated (3pole) silver-plated (4pole)	10
 <p>Crimp connection</p>	Female insert without crimp contacts	0.2 – 1.5 mm ² 18 – 16 AWG UL 24 – 16 AWG CSA		4 mm		10
	Male insert without crimp contacts	0.2 – 1.5 mm ² 18 – 16 AWG UL 24 – 16 AWG CSA		4 mm		10
		Thread size	Cable gland type	Material	Stand. pack	
	M 20	Hood, angled	0 with cable gland 1 with thread 1 with thread	Metal Metal Plastic	10 10 10	
		M 20	Hood, straight	0 with cable gland 1 with thread 1 with thread	Metal Metal Plastic	10 10 10
		M 20	Hood, with clip for cable to cable couplings	0 with complete cable gland 1 with thread 1 with thread	Metal Metal Plastic	10 10 10
			Open-bottom housing		Metal Plastic	10 10
			Open-bottom housing, angled		Metal Plastic	10 10
		M 20	Closed-bottom housings The closed-bottom housing in plastic material is supplied without gland	0 with cable gland 1 with thread 1 with thread	Metal Metal Plastic	10 10 10

revos

Contacts for crimp version

Female contacts



Male contacts



Ø mm ²	AWG	Part no.	Stand. pack	Ø mm ²	AWG	Part no.	Stand. pack
0.2 – 0.56 mm ²	24 – 20	tin-plated		0.5 – 1.50 mm ²	24 – 20	gold-plated	
Reel contacts		02.124.0900.0	5000	Reel contacts		02.124.1400.0	5000
Single contacts		02.124.0929.0	200	Single contacts		02.124.1429.0	200
0.75 – 1.50 mm ²	18 – 16						
Reel contacts		02.124.1000.0	5000				
Single contacts		02.124.1029.0	200				
0.2 – 0.56 mm ²	24 – 20			0.5 – 1.50 mm ²	20 – 16		
Reel contacts		05.544.0900.0	5000	Reel contacts		05.544.1400.0	5000
Single contacts		05.544.0929.0	200	Single contacts		05.544.1429.0	200
0.75 – 1.50 mm ²	18 – 16						
Reel contacts		05.544.1000.0	5000				
Single contacts		05.544.1029.0	200				
				Crimping tool		95.101.0800.0	1
				Crimping die "E"		05.502.2400.0	1
				Contact positioner "2"		05.502.3200.0	1
				Extraction tool		05.502.0000.0	1

3pole + ground

Plastic housing UL/CSA
400 V/4 kV, 10 A 600 V
Metal housing
250 V/400 V/4 kV, 10 A 600V

4pole + ground

Plastic housing UL/CSA
250 V/4 kV, 10 A 600 V
Metal housing
250 V/4 kV, 10 A 600 V

7pole + ground

Plastic housing UL/CSA
250 V/4 kV, 10 A 600 V
Metal housing
50 V/0,8 kV, 10 A 42 V

8pole

Plastic housing UL/CSA
50 V/0,8 kV, 10 A 42 V
Metal housing
50 V/0,8 kV, 10 A 42 V

Accessories



Cover with locking-bolts for housing and hood with locking levers



Cover with locking-bolts for housing and hood with locking levers
with gasket for female insert

without gasket for male insert

Plastic
07.417.6753.0
Metal
07.417.6729.0

Plastic
07.417.6853.0
Metal
07.417.6829.0

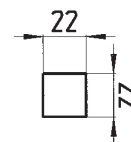

Mounting dimensions and cut-outs for open-bottom housings (shown in mm)

Part no.	Part no.	Part no.	Part no.	Part no.	Part no.
73.300.0353.0	73.300.0453.0				
73.310.0353.0	73.310.0453.0				
		73.700.0753.0	73.700.0853.0		
		73.710.0753.0	73.710.0853.0		
76.350.0736.0 76.350.0736.1 76.350.0760.1	76.350.0736.0 76.350.0736.1 76.350.0760.1	76.350.0736.0 76.350.0736.1 76.350.0760.1	76.350.0736.0 76.350.0736.1 76.350.0760.1		
76.352.0736.0 76.352.0736.1 76.352.0760.1	76.352.0736.0 76.352.0736.1 76.352.0760.1	76.352.0736.0 76.352.0736.1 76.352.0760.1	76.352.0736.0 76.352.0736.1 76.352.0760.1		
76.372.0736.0 76.372.0736.1 76.372.0760.1	76.372.0736.0 76.372.0736.1 76.372.0760.1	76.372.0736.0 76.372.0736.1 76.372.0760.1	76.372.0736.0 76.372.0736.1 76.372.0760.1		
76.320.0729.0 76.320.0753.0	76.320.0729.0 76.320.0753.0	76.320.0729.0 76.320.0753.0	76.320.0729.0 76.320.0753.0		
76.321.0729.0 76.321.0753.0	76.321.0729.0 76.321.0753.0	76.321.0729.0 76.321.0753.0	76.321.0729.0 76.321.0753.0		
76.322.0736.0 76.322.0736.1 76.322.0760.1	76.322.0736.0 76.322.0736.1 76.322.0760.1	76.322.0736.0 76.322.0736.1 76.322.0760.1	76.322.0736.0 76.322.0736.1 76.322.0760.1		



Industrial multipole connectors

revos HD OS

Technical information

■ Approvals	UL, CSA, MEEI, SEV
■ Applicable standards	IEC 61 984, DIN EN 175301-801
■ Contact inserts	
Rated current	10 A
Rated voltage	250 V
Nominal voltage accord. to UL	600 V
Nominal voltage accord. to CSA	600 V
Pole configurations	15, 25, 40, 64pole
Crimp connection	0.2 – 1.5 mm ² / 24 – 16 AWG
Degree of pollution	3
Temperature range	–40 to +110 °C
■ Multipole adapter	
Rated current	10 A
Rated voltage	250 V
Nominal voltage accord. to UL	600 V
Nominal voltage accord. to CSA	600 V
Pole configurations	40, 64pole + ground
Screw connection	0.5 – 4.0 mm ² / 20 – 14 AWG
Degree of pollution	3
Temperature range	–40 to +110 °C
■ Contacts	
Material	copper alloy
Surface	tin-plated, gold-plated, silver-plated
■ Hoods and housings	
Material	die cast aluminum alloy Thermoplast
Surface	silver gray, silicon-free finish
Locking levers	zinc-plated steel
Gaskets	NBR
Temperature range	–40 to +110 °C
Degree of protection accord. to DIN EN 60 529	
with latched locking levers	IP 55
with suitable cable gland	IP 65

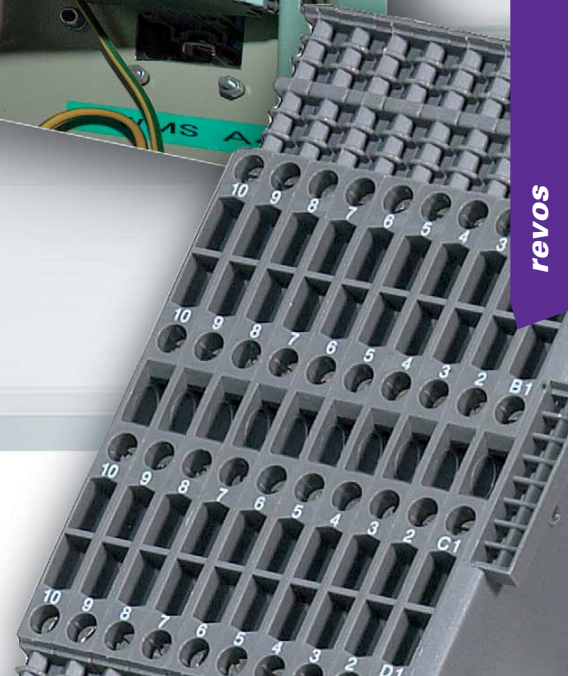
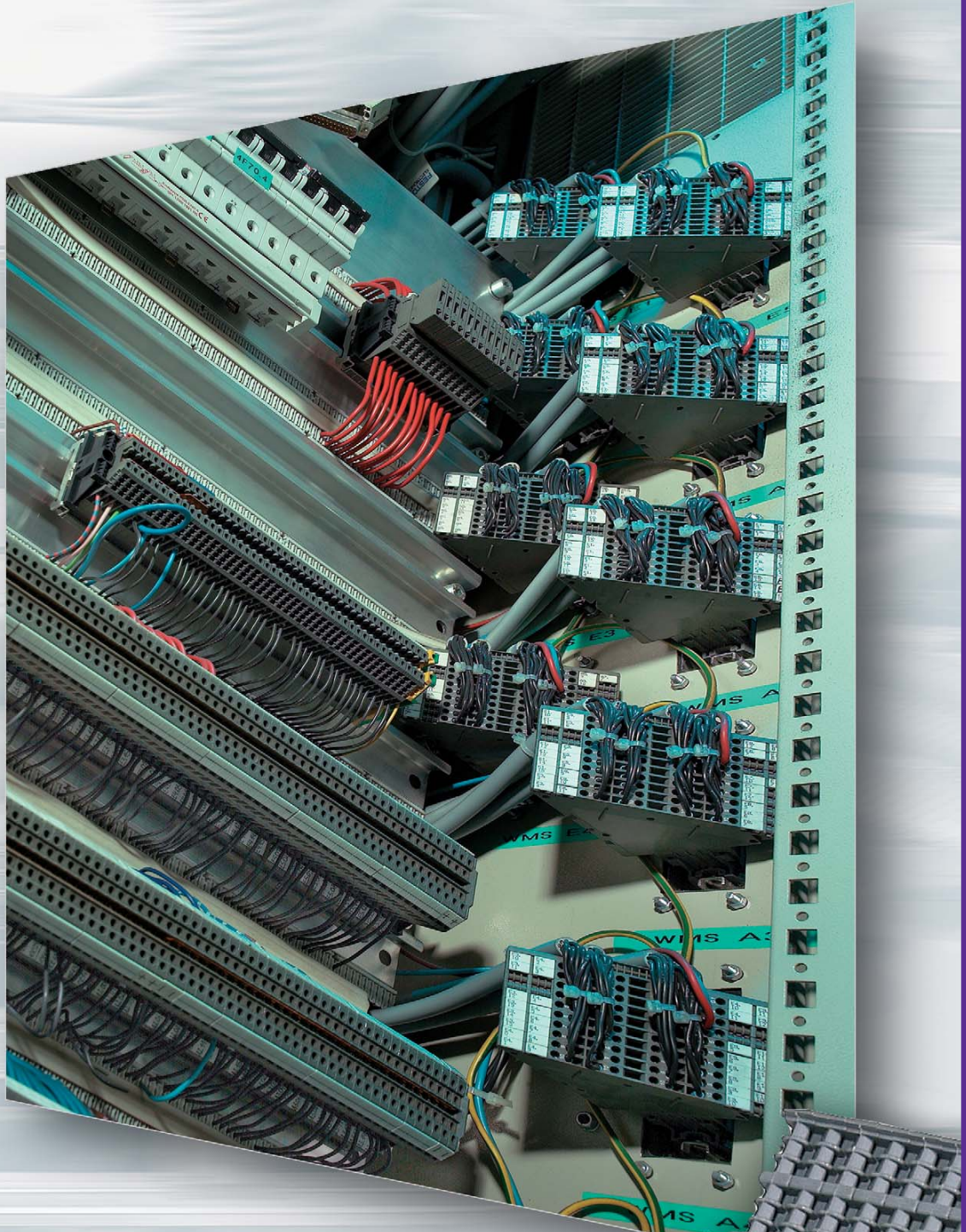

revos

Industrial Multipole Connectors

High density multipole connectors according to DIN EN 175301-801

revos HD



System description

- For use in machine construction, control and switchgear building
- Reliable connector elements for power and control current lines
- Outstanding feature: a robust die cast aluminum housing
- Protection of the internal contact-inserts against mechanical and hazardous industrial influences
- According to EN 60529 and IEC 60 529, the interlocked hoods and housings provide the following degrees of protection:
IP 65 (dust ingress and jet-water)
IP 55 (dust deposit and splashwater)
- High contact density

Multipole adapter

- Space-saving connection element for heavy industrial multipole connectors
- Consists of: Multipole connector, contact insert and attached feedthrough terminal
- Multipole adapters are available with female or male connector inserts
- Provided as preassembled unit which can be mounted to the control cabinet wall
- Easy handling: slide the multipole adapter to the housing and mount it with screws
- TOP connection design also available

- Clearly identified and easily accessible clamping points
- The angled connection zone and the TOP connection facility enable clamping and testing of all connections even when the components are plugged together
- Each connection can be marked with 4 or 6 digits

Further benefits:

- Safe and time-saving wiring
- Testing is possible even when the components are plugged together, meaning that the power circuit need not be interrupted for testing
- Small-sized components help to reduce control cabinet space
- Potential commoning due to an insulated jumper bar
- Variable marking facilities
- Coding by means of coding pieces and coding bolts
- No mismatched connections

Female and male connector inserts

- Mounted in the direction of the power flow (female insert is live)
- No mismatching due to the special design of the female and male inserts
- Consecutive numbers both on the contact and on the connection sides
- Mixed contacts possible
- Due to an integrated screwdriver guide, both electric and pneumatic screwdrivers can be used

Crimp connection

- Snap-in crimp contacts for high density applications
- Corrosion-resistant due to gas-tight connections (cold welding)
- Constant feed through resistance
- Rapid mounting
- Crimp contacts safely latch into the female and male inserts
- flared, closed cable entries protect the female contacts against possible damaging
- Connected contacts can only be released with a special tool
- Reel contacts available for automatic crimping machines

revos



Latching frames (see page 674)

- Housing: contact inserts to be latched in sheet metal cut-out
- Hood: contact inserts available either with or without strain relief with/without locking mechanism
- No metal housings
- Cable to cable couplings with two hoods
- Multipole adapter with contact insert can be latched in sheet metal cut-out or mounted to a rail by means of a universal foot

Technical information:

Female and male connector inserts

Screw connection: 2.5 mm²
12 AWG UL/CSA

Crimp connection: 0.5 - 4 mm²
20 - 12 AWG UL/CSA

Number of poles: 40, 64
Rated voltage VDE: 250 V
Rated voltage UL/CSA: 600 V
Rated current: 10 A

Crimping machine

- Wire stripping and crimping in one step
- Manual infeed of the cable material
- Automatic stripping and crimping
- Infeed of the female and male contacts on reels (0.2 - 1.5 mm² / 24 - 16 AWG)
- The machine can be used for various applications, as the tool inserts are exchanged easily
- Available tool inserts:
 - for ST 18-connectors
 - for industrial multipole connectors
 - for high density multipole connectors

The female and male contacts are available in cross sections between 0.2 mm² and 1.5 mm²
24 - 16 AWG

- Cross section is marked on the female and male contacts

For ordering see **facts** & DATA

Crimping tool

- Special crimping tool required for the high density Wieland contacts
- Interlock protects against inadvertent opening
- Contact positioner for female and male contacts available

For ordering see **facts** & DATA

Marking accessories

- 6digit marking tag carrier for open-bottom housings
- The connection points can be marked with single tags or via tear-off marking strips with 6 digits each

Material

Housing:

- Hood/housing: die cast aluminum alloy, silicon-free finish, silver gray

Female and male connector inserts:

- Insulating parts made from fiberglass reinforced Polyamide (technical information: see **facts** & DATA)

DQS certificates for all product families

- Quality standard as per DIN ISO 9001
- in Development, Production, Assembly
- Continued control of the quality standards by means of regular internal and external quality audits
- Compatible with certificates of other countries:
 - BSI Certificate, Great Britain
 - SQS Certificate, Switzerland
 - Aib-Vincotte Certificate, Belgium
 - ÖQS Certificate, Austria

Note:

The information regarding cross sectional area and connection types pertains to unprepared wires without ferrules.

The voltage ratings apply to the terminals in their intended application.

The official installation standards are to be followed. When the components are mounted into devices, the relevant device instructions apply.

Special installation conditions of the customers are not considered. For more detailed information on the specific component characteristics see **facts** & DATA.

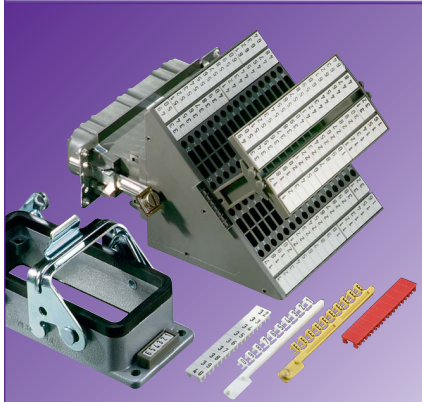







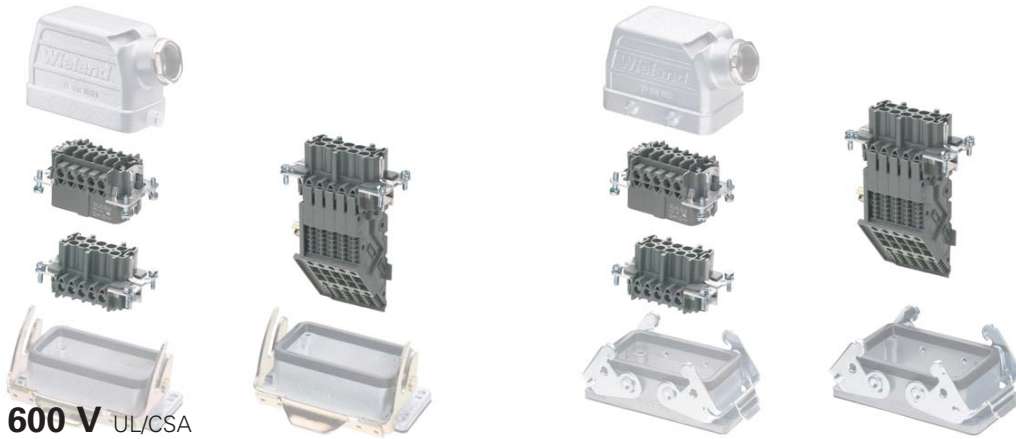

Industrial multipole connectors

Female/male inserts and multipole adapters

revos HD

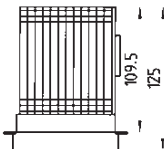

600 V UL/CSA
250 V, 10 A IEC 61 984

		Cross section	Approvals	Wire strip length	Material	Stand. pack
 <p>Crimp connection</p>	Female insert without crimp contacts	0.2 – 1.5 mm ² 24 – 16 AWG		4 mm		10
	Male insert without crimp contacts	0.2 – 1.5 mm ² 24 – 16 AWG		4 mm		10
 <p>Screw connection Multipole adapter</p> 	Female insert, ground right	0.5 – 2.5 mm ² 20 – 14 AWG		12 mm	tin-plated	4 2
	Female insert, ground left	0.5 – 2.5 mm ² 20 – 14 AWG		12 mm	tin-plated	4 2
	Male insert, ground right	0.5 – 2.5 mm ² 20 – 14 AWG		12 mm	tin-plated	4 2
	Male insert, ground left	0.5 – 2.5 mm ² 20 – 14 AWG		12 mm	tin-plated	4 2

revos

Contacts for crimp version

Female contacts



Male contacts



Crimping tool
Crimping die "E"
Contact positioner "2"
Extraction tool

Ø mm ²	AWG	Part no.	Stand. pack	Ø mm ²	AWG	Part no.	Stand. pack
0.2 – 0.56 mm ²	24 – 20	tin-plated		0.5 – 1.50 mm ²	20 – 16	gold-plated	
Reel contacts		02.124.0900.0	5000	Reel contacts		02.124.1400.0	5000
Single contacts		02.124.0929.0	200	Single contacts		02.124.1429.0	200
0.75 – 1.50 mm ²	18 – 16						
Reel contacts		02.124.1000.0	5000				
Single contacts		02.124.1029.0	200				
0.2 – 0.56 mm ²	24 – 20			0.5 – 1.50 mm ²	20 – 16		
Reel contacts		05.544.0900.0	5000	Reel contacts		05.544.1400.0	5000
Single contacts		05.544.0929.0	200	Single contacts		05.544.1429.0	200
0.75 – 1.50 mm ²	18 – 16						
Reel contacts		05.544.1000.0	5000				
Single contacts		05.544.1029.0	200				
				Crimping tool		95.101.0800.0	1
				Crimping die "E"		05.502.2400.0	1
				Contact positioner "2"		05.502.3200.0	1
				Extraction tool		05.502.0000.0	1

15pole + ground	25pole + ground	40pole + ground	64pole + ground
Part no.	Part no.	Part no.	Part no.
73.700.1553.0	73.700.2553.0	73.700.4058.0	73.700.6458.0
73.710.1553.0	73.710.2553.0	73.710.4058.0	73.710.6458.0
		73.105.4053.0	73.105.6453.0
		73.100.4053.0	73.100.6453.0
		73.115.4053.0	73.115.6453.0
		73.110.4053.0	73.110.6453.0

40pole multipole adapter

- a) = operating current
- b) = maximum operating current
- c) = ambient temperature
- d) = conductor cross section
- e) = number of loaded contacts

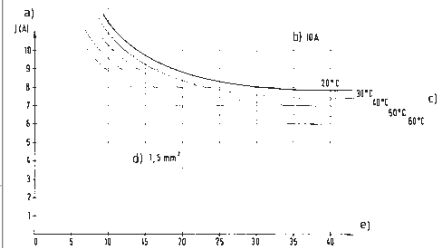

64pole multipole adapter

- a) = operating current
- b) = maximum operating current
- c) = ambient temperature
- d) = conductor cross section
- e) = number of loaded contacts

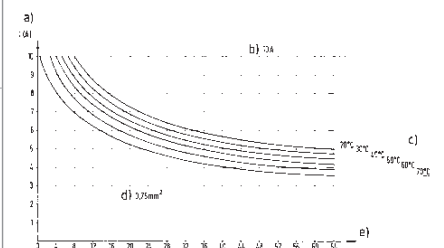

Industrial multipole connectors Hoods with single locking levers

revos HD

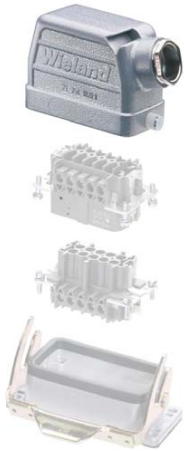

Version A

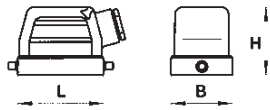

Version C

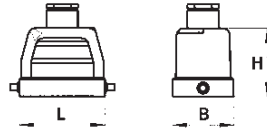

For inserts **600 V** UL/CSA

DIN EN 175301-801



For inserts **250 V** IEC 61 984

Degrees of protection: IP 55

IP 65 with the appropriate cable glands

Number of poles	Thread	Cable gland type	Dimensions in mm	L	W	H	Stand. pack
Size 15 for multipole connectors 15pole + ground	M 20	0 with cable gland 1 with threaded collar 2 with intermediate support		63	33	64	1
	M 25	0 with cable gland 1 with threaded collar 2 with intermediate support		63	33	64	1
Size 25 for multipole connectors 25pole + ground	M 20	0 with cable gland 1 with threaded collar 2 with intermediate support		79.5	33	70	1
	M 25	0 with cable gland 1 with threaded collar 2 with intermediate support		79.5	33	70	1
Size 16 for multipole connectors 40pole + ground	M 25	0 with cable gland 1 with threaded collar 2 with intermediate support 3 with strain relief		93.5	43	76	1
	M 32	0 with cable gland 1 with threaded collar 2 with intermediate support 3 with strain relief		93.5	43	76	1
Size 24 for multipole connectors 64pole + ground	M 25	0 with cable gland 1 with threaded collar 2 with intermediate support 3 with strain relief		120	43	76	1
	M 32	0 with cable gland 1 with threaded collar 2 with intermediate support 3 with strain relief		120	43	76	1

revos

Hood with cable gland	Hood with cable gland
Version A	Version C
	
Part no.	Part no.
76.350.1535.0 76.350.1535.2	76.352.1535.0 76.352.1535.1 76.352.1535.2
76.353.1535.0 76.353.1535.2	76.354.1535.0 76.354.1535.1 76.354.1535.2
76.350.2535.0 76.350.2535.2	76.352.2535.0 76.352.2535.1 76.352.2535.2
76.353.2535.0 76.353.2535.2	76.354.2535.0 76.354.2535.1 76.354.2535.2
76.350.4035.0 76.350.4035.1 76.350.4035.2 76.350.4035.3	76.352.4035.0 76.352.4035.1 76.352.4035.2 76.352.4035.3
76.353.4035.0 76.353.4035.1 76.353.4035.2 76.353.4035.3	76.354.4035.0 76.354.4035.1 76.354.4035.2 76.354.4035.3
76.350.6435.0 76.350.6435.1 76.350.6435.2 76.350.6435.3	76.352.6435.0 76.352.6435.1 76.352.6435.2 76.352.6435.3
76.353.6435.0 76.353.6435.1 76.353.6435.2 76.353.6435.3	76.354.6435.0 76.354.6435.1 76.354.6435.2 76.354.6435.3

Industrial multipole connectors

Housings with single locking levers, without protective cover

revos HD

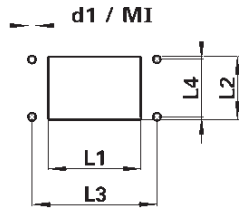
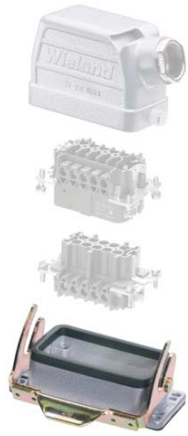

Mounting dimensions and cut-outs for open-bottom housings

Housing size	Cut-out (mm)		Mounting dimensions (mm)		d1 (mm)	MI
	L1	L2	L3	L4		
15	56	23	70	17.5	3.3	M 3
25	72	23	86	17.5	4.3	M 4
16	83.5	35	103	32	4.3	M 4
24	112	35	130	32	4.3	M 4

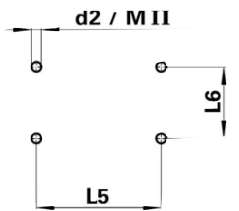

Mounting dimensions for closed-bottom housings

Housing size	L5 (mm)	L6 (mm)	d2 (mm)	MI I
15	48	40	4.3	M 4
25	64	40	5.5	M 5
16	105	45	5.5	M 5
24	132	45	5.5	M 5

For inserts **600 V** UL/CSA

For inserts **250 V** IEC 61 984

DIN EN 175301-801

Degrees of protection: IP 55

IP 65 with the appropriate cable glands

Number of poles	Thread	Cable gland type	Dimensions in mm	L	W	H	Stand. pack
Size 15 for multipole connectors	M 20	0 with cable gland		81	30	25.7	1
		1 with threaded collar		81	50	52.5	1
				81	50	52.5	1
15pole + ground	M 25	0 with cable gland		81	50	52.5	1
		1 with threaded collar		81	50	52.5	1
				81	50	52.5	1
Size 25 for multipole connectors	M 20	0 with cable gland		96	30	25.7	1
		1 with threaded collar		95.7	50	57.5	1
				95.7	50	57.5	1
25pole + ground	M 25	0 with cable gland		95.7	50	57.5	1
		1 with threaded collar		95.7	50	57.5	1
				95.7	50	57.5	1
Size 16 for multipole connectors	M 25	0 with cable gland		113	43	28	1
		1 with threaded collar		117	52	76.5	1
				117	52	76.5	1
40pole + ground	M 32	0 with cable gland		117	52	76.5	1
		1 with threaded collar		117	52	76.5	1
				117	52	76.5	1
Size 24 for multipole connectors	M 25	0 with cable gland		140	43	28	1
		1 with threaded collar		144	52	76.5	1
				144	52	76.5	1
64pole + ground	M 32	0 with cable gland		144	52	76.5	1
		1 with threaded collar		144	52	76.5	1
				144	52	76.5	1

revos

Version a



Version b

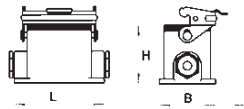

Version c

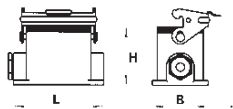

Version d

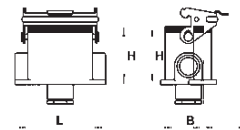

Open-bottom housing

Closed-bottom housing with two narrow-side entry cable glands

Closed bottom housing with one narrow-side entry cable gland on the left

Closed-bottom housing with bottom entry cable gland

Open-bottom housing with locking ridges for multipole adapters

Version a

Version b

Version c

Version d

Version a



Part no.

Part no.

Part no.

Part no.

Part no.

76.320.1528.0

76.330.1535.0
76.330.1535.1

76.331.1535.0
76.331.1535.1

76.334.1535.0
76.334.1535.1

76.335.1535.0
76.335.1535.1

76.320.2528.0

76.330.2535.0
76.330.2535.1

76.331.2535.0
76.331.2535.1

76.334.2535.0
76.334.2535.1

76.335.2535.0
76.335.2535.1

71.320.1628.0

76.330.4035.0
76.330.4035.1

76.331.4035.0
76.331.4035.1

76.333.4035.0
76.333.4035.1

76.326.4028.0

76.334.4035.0
76.334.4035.1

76.335.4035.0
76.335.4035.1

76.337.4035.0
76.337.4035.1

71.320.2428.0

76.330.6435.0
76.330.6435.1

76.331.6435.0
76.331.6435.1

76.333.6435.0
76.333.6435.1

76.326.6428.0

76.334.6435.0
76.334.6435.1

76.335.6435.0
76.335.6435.1

76.337.6435.0
76.337.6435.1



Industrial multipole connectors

Housings with single locking levers and protective cover

revos HD

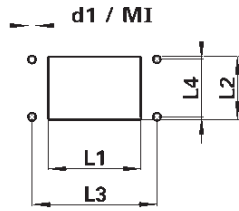
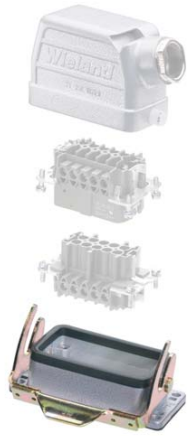

Mounting dimensions and cut-outs for open-bottom housings

Housing size	Cut-out (mm)		Mounting dimensions (mm)		d1 (mm)	MI
	L1	L2	L3	L4		
15	56	23	70	17.5	3.3	M 3
25	72	23	86	17.5	4.3	M 4
16	83.5	35	103	32	4.3	M 4
24	112	35	130	32	4.3	M 4

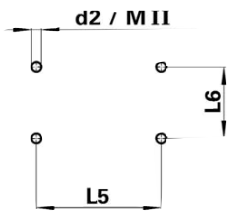

Mounting dimensions for closed-bottom housings

Housing size	L5 (mm)	L6 (mm)	d2 (mm)	MII
15	48	40	4.3	M 4
25	64	40	5.5	M 5
16	105	45	5.5	M 5
24	132	45	5.5	M 5

For inserts **600 V** UL/CSA

For inserts **250 V** IEC 61 984

DIN EN 175301-801

Degrees of protection: **IP 55**

IP 65 with the appropriate cable glands

Number of poles	Thread	Cable gland type	Dimensions in mm	L	W	H	Stand. pack
Size 15 for multipole connectors				81	30	25.7	1
15pole + ground							
Size 25 for multipole connectors				96	30	25.7	1
25pole + ground							
Size 16 for multipole connectors	M 25	0 with cable gland		113	43	28	1
		1 with threaded collar		117	52	76.5	1
		1 with threaded collar		117	52	76.5	1
40pole + ground	M 32	0 with cable gland		117	52	76.5	1
		1 with threaded collar		117	52	76.5	1
		1 with threaded collar		117	52	76.5	1
Size 24 for multipole connectors	M 25	0 with cable gland		140	43	28	1
		1 with threaded collar		144	52	76.5	1
		1 with threaded collar		144	52	76.5	1
64pole + ground	M 32	0 with cable gland		144	52	76.5	1
		1 with threaded collar		144	52	76.5	1
		1 with threaded collar		144	52	76.5	1

revos

Version e

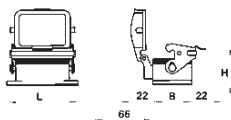

Version f

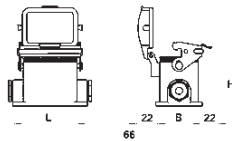

Version g

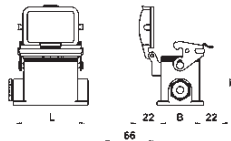

Version h

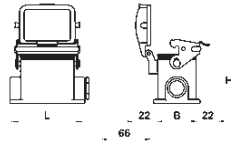

Version i

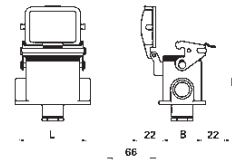

Open-bottom housing with protective cover for female and male inserts only

Version e



Closed-bottom housing with two narrow-side entry cable glands and protective cover

Version f



Closed bottom housing with one narrow-side entry cable gland on the left and protective cover

Version g



Closed bottom housing with one narrow-side entry cable gland on the right and protective cover

Version h



Closed bottom housing with one bottom entry cable gland and protective cover

Version i



Open-bottom housing with protective cover and locking ridges for multipole adapters

Version e



Part no.	Part no.	Part no.	Part no.	Part no.	Part no.
76.325.1528.0					
76.325.2528.0					
71.325.1628.0	76.340.4035.0 76.340.4035.1	76.341.4035.0 76.341.4035.1	76.342.4035.0 76.342.4035.1	76.343.4035.0 76.343.4035.1	76.327.4028.0
	76.344.4035.0 76.344.4035.1	76.345.4035.0 76.345.4035.1	76.346.4035.0 76.346.4035.1	76.347.4035.0 76.347.4035.1	
71.325.2428.0	76.340.6435.0 76.340.6435.1	76.341.6435.0 76.341.6435.1	76.342.6435.0 76.342.6435.1	76.343.6435.0 76.343.6435.1	76.327.6428.0
	76.344.6435.0 76.344.6435.1	76.345.6435.0 76.345.6435.1	76.346.6435.0 76.346.6435.1	76.347.6435.0 76.347.6435.1	



Industrial multipole connectors

Hoods with double locking levers,

revos HD

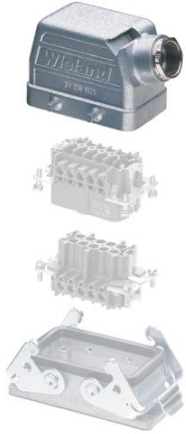

For inserts **600 V** UL/CSA

For inserts **250 V** IEC 61 984

DIN EN 175301-801
Degrees of protection: IP 55
IP 65 with the appropriate cable glands

Number of poles	Thread	Cable gland type	Dimensions in mm			
			L	W	H	Stand. pack
Size 16 for multipole connectors 40pole + ground	M 25	0 with cable gland	93.5	43	76	1
		1 with thread	93.5	43	76	1
		2 with intermediate support	93.5	43	76	1
		3 with strain relief	93.5	43	76	1
	M 32	0 with cable gland	93.5	43	76	1
		1 with threaded collar	93.5	43	76	1
		2 with intermediate support	93.5	43	76	1
		3 with strain relief	93.5	43	76	1
Size 24 for multipole connectors 64pole + ground	M 25	0 with cable gland	120	43	76	1
		1 with threaded collar	120	43	76	1
		2 with intermediate support	120	43	76	1
		3 with strain relief	120	43	76	1
	M 32	0 with cable gland	120	43	76	1
		1 with threaded collar	120	43	76	1
		2 with intermediate support	120	43	76	1
		3 with strain relief	120	43	76	1

revos

Version A

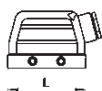

Version C

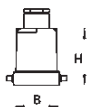
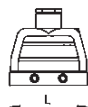

Version D

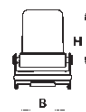
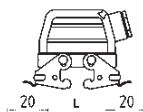

Version F

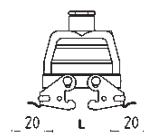

Hood with cable gland

Hood with cable gland

Hood with cable gland

Hood with cable gland

Version A

Version C

Version D

Version F



Part no.

Part no.

Part no.

Part no.

73.350.4035.0
73.350.4035.1
73.350.4035.2
73.350.4035.3

73.352.4035.0
73.352.4035.1
73.352.4035.2
73.352.4035.3

73.355.4035.0
73.355.4035.1
73.355.4035.2
73.355.4035.3

73.357.4035.0
73.357.4035.1
73.357.4035.2
73.357.4035.3

73.353.4035.0
73.353.4035.1
73.353.4035.2
73.353.4035.3

73.354.4035.0
73.354.4035.1
73.354.4035.2
73.354.4035.3

73.358.4035.0
73.358.4035.1
73.358.4035.2
73.358.4035.3

73.359.4035.0
73.359.4035.1
73.359.4035.2
73.359.4035.3

73.350.6435.0
73.350.6435.1
73.350.6435.2
73.350.6435.3

73.352.6435.0
73.352.6435.1
73.352.6435.2
73.352.6435.3

73.355.6435.0
73.355.6435.1
73.355.6435.2
73.355.6435.3

73.357.6435.0
73.357.6435.1
73.357.6435.2
73.357.6435.3

73.353.6435.0
73.353.6435.1
73.353.6435.2
73.353.6435.3

73.354.6435.0
73.354.6435.1
73.354.6435.2
73.354.6435.3

73.358.6435.0
73.358.6435.1
73.358.6435.2
73.358.6435.3

73.359.6435.0
73.359.6435.1
73.359.6435.2



Industrial multipole connectors

Housings with double locking levers, without protective cover

revos HD

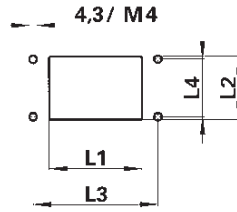
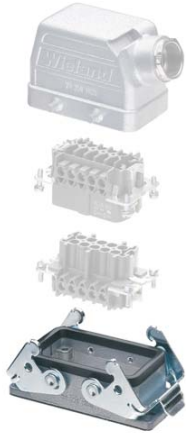

Mounting dimensions and cut-outs for open-bottom housings

Housing size	Cut-out (mm)		Mounting dimensions (mm)	
	L1	L2	L3	L4
16	83.5	103	32	35
24	112	130	32	35

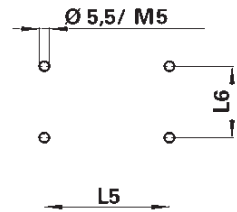

Mounting dimensions for closed-bottom housings

Housing size	L5 (mm)	L6 (mm)
16	105	45
24	132	45

For inserts **600 V** UL/CSA

DIN EN 175301-801

For inserts **250 V** IEC 61 984

Degrees of protection: **IP 55**
IP 65 with the appropriate cable glands

Number of poles	Thread	Cable gland type	Dimensions in mm	L	W	H	Stand. pack
Size 16 for multipole connectors	M 25	0 with cable gland		113	43	28	1
		1 with threaded collar		117	52	76.5	1
				117	52	76.5	1
40pole + ground	M 32	0 with cable gland		117	52	76.5	1
		1 with threaded collar		117	52	76.5	1
				117	52	76.5	1
Size 24 for multipole connectors	M 25	0 with cable gland		140	43	28	1
		1 with threaded collar		144	52	76.5	1
				144	52	76.5	1
64pole + ground	M 32	0 with cable gland		144	52	76.5	1
		1 with threaded collar		144	52	76.5	1
				144	52	76.5	1

revos

Version a



Version b

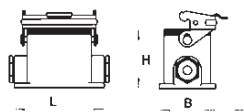

Version c



Version d

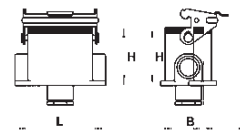

Open-bottom housing

Closed-bottom housing with two narrow-side entry cable glands

Closed bottom housing with one narrow-side entry cable gland on the left

Closed-bottom housing with bottom entry cable gland

Open-bottom housing with locking ridges for multiple adapters

Version a

Version b

Version c

Version d

Version a



Part no.

Part no.

Part no.

Part no.

Part no.

70.320.1628.0

73.330.4035.0
73.330.4035.1

73.331.4035.0
73.331.4035.1

73.333.4035.0
73.333.4035.1

73.326.4028.0

73.334.4035.0
73.334.4035.1

73.335.4035.0
73.335.4035.1

73.337.4035.0
73.337.4035.1

70.320.2428.0

73.330.6435.0
73.330.6435.1

73.331.6435.0
73.331.6435.1

73.333.6435.0
73.333.6435.1

73.326.6428.0

73.334.6435.0
73.334.6435.1

73.335.6435.0
73.335.6435.1

73.337.6435.0
73.337.6435.1



Industrial multipole connectors

Hoods with double locking levers with protective cover

revos HD

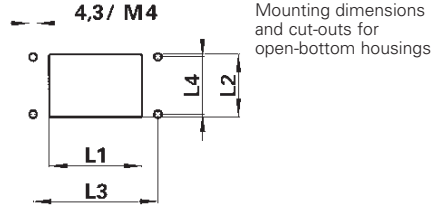
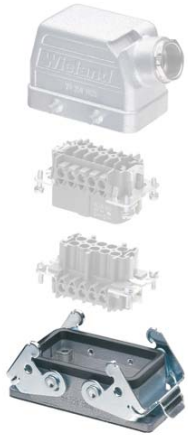

Housing size	Cut-out (mm)		Mounting dimensions (mm)	
	L1	L2	L3	L4
16	83.5	103	32	35
24	112	130	32	35

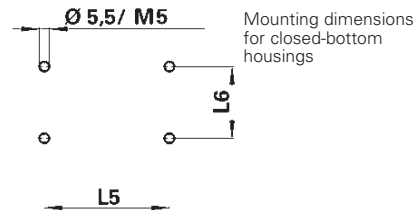

Housing size	L5 (mm)	L6 (mm)
16	105	45
24	132	45

For inserts **600 V** UL/CSA

For inserts **250 V** IEC 61 984

DIN EN 175301-801
Degrees of protection: IP 55
IP 65 with the appropriate cable glands

Number of poles	Thread	Cable gland type	Dimensions in mm	L	W	H	Stand. pack
Size 16 for multipole connectors	M 25	0 with cable gland		113	43	28	1
		1 with threaded collar		117	52	76.5	1
				117	52	76.5	1
40pole + ground	M 32	0 with cable gland		117	52	76.5	1
		1 with threaded collar		117	52	76.5	1
Size 24 for multipole connectors	M 25	0 with cable gland		140	43	28	1
		1 with threaded collar		144	52	76.5	1
				144	52	76.5	1
64pole + ground	M 32	0 with cable gland		144	52	76.5	1
		1 with threaded collar		144	52	76.5	1

revos

Version e

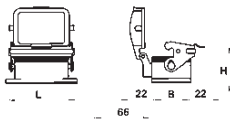

Version f

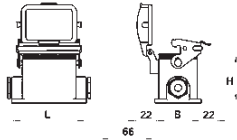

Version g

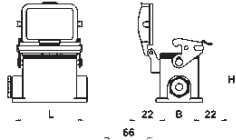

Version h

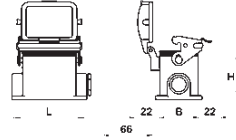

Version i

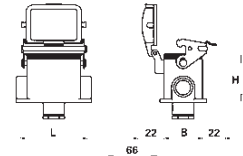

Open-bottom housing with protective cover for female and male inserts only

Version e



Closed-bottom housing with two narrow-side entry cable glands and protective cover

Version f



Closed bottom housing with one narrow-side entry cable gland on the left and protective cover

Version g



Closed bottom housing with one narrow-side entry cable gland on the right and protective cover

Version h



Closed bottom housing with one bottom entry cable gland and protective cover

Version i



Open-bottom housing with protective cover and locking ridges for multipole adapters

Version e



Part no.	Part no.	Part no.	Part no.	Part no.	Part no.
70.325.1628.0	73.340.4035.0 73.340.4035.1	73.341.4035.0 73.341.4035.1	73.342.4035.0 73.342.4035.1	73.343.4035.0 73.343.4035.1	73.327.4028.0
	73.344.4035.0 73.344.4035.1	73.345.4035.0 73.345.4035.1	73.346.4035.0 73.346.4035.1	73.347.4035.0 73.347.4035.1	
70.325.2428.0	73.340.6435.0 73.340.6435.1	73.341.6435.0 73.341.6435.1	73.342.6435.0 73.342.6435.1	73.343.6435.0 73.343.6435.1	73.327.6428.0
	73.344.6435.0 73.344.6435.1	73.345.6435.0 73.345.6435.1	73.346.6435.0 73.346.6435.1	73.347.6435.0 73.347.6435.1	

Industrial multipole connector for cable to cable couplings with double locking lever

revos



All hoods and housings can be supplied with an intermediate support and without metric cable glands. For this case please change the part number by adding a 2 in the end (e.g. 72.352.1035.2). If you want to order hoods or housings with metric thread only, please indicate a 1 at the end of the part number (e.g. 72.352.1035.1).

Other than shown in the figure, the 6pole and 48pole connectors in version 70.3, and the 20, 26 and 32pole connectors in version 70.4 only have one locking lever on the broad side!

For accessories and marking material for hoods and open-bottom housings please see the section Accessories for industrial multipole connectors

Female insert
with screw connection

Male insert
with screw connection



Degree of protection: IP 55 accord. to DIN EN 60 529

Degree of protection: IP 65 accord. to DIN EN 60 529 with appropriate cable glands

Rated current accord. to IEC 61 984

Type	Used cont.	Switch. cont.	ground	Cable entry	U	UL/CSA	I	Cross section	Stand. pack	Part no.	Part no.
70.3	6	-	1	M 20	500 V	600 V	16 A	2.5 mm ² 12 AWG	10	70.300.0640.0	70.310.0640.0
70.4	3	2	1	M 20	690/400 V	600 V	16 A	2.5 mm ² 12 AWG	10	70.400.0340.0	70.410.0340.0
70.4	6	2	1	M 25	690/400 V	600 V	16 A	2.5 mm ² 12 AWG	10	70.400.0640.0	70.410.0640.0
70.2	6	-	1	M 25	400 V	600 V	35 A	6.0 mm ² 8 AWG	10	70.200.0653.0	70.210.0653.0
70.3	10	-	1	M 20	500 V	600 V	16 A	2.5 mm ² 12 AWG	10	70.300.1040.0	70.310.1040.0
70.4	10	2	1	M 25	690/400 V	600 V	16 A	2.5 mm ² 12 AWG	10	70.400.1040.0	70.410.1040.0
70.3	16	-	1	M 32	500 V	600 V	16 A	2.5 mm ² 12 AWG	10	70.300.1640.0	70.310.1640.0
70.4	16	2	1	M 32	690/400 V	600 V	16 A	2.5 mm ² 12 AWG	10	70.400.1640.0	70.410.1640.0
70.4	20	2	1	M 32	690/400 V	600 V	16 A	2.5 mm ² 12 AWG	5	70.400.2040.0	70.410.2040.0
70.3	24	-	1	M 32	500 V	600 V	16 A	2.5 mm ² 12 AWG	10	70.300.2440.0	70.310.2440.0
70.4	26	2	1	M 32	690/400 V	600 V	16 A	2.5 mm ² 12 AWG	5	70.400.2640.0	70.410.2640.0
70.4	32	2	1	M 32	690/400 V	600 V	16 A	2.5 mm ² 12 AWG	5	70.400.3240.0	70.410.3240.0
70.3	48	-	1	M 32	500 V	600 V	16 A	2.5 mm ² 12 AWG	5	70.300.4840.0	70.310.4840.0

revos

	Hood with cable gland	Hood with cable gland with locking levers and gasket	Hood with strain relief	Hood with strain relief with locking levers and gasket
				
Std. pack	Part no.	Part no.	Part no.	Part no.
1	70.352.0635.0	70.372.0635.0	70.352.0635.3	70.372.0635.3
1	72.352.1035.0	72.372.1035.0	72.352.1035.3	72.372.1035.3
1	72.352.1635.0	72.372.1635.0	72.352.1635.3	72.372.1635.3
1	70.352.1635.0	70.372.1635.0	70.352.1635.3	70.372.1635.3
1	70.352.1035.0	70.372.1035.0	70.352.1035.3	70.372.1035.3
1	72.352.2435.0	72.372.2435.0	72.352.2435.3	72.372.2435.3
1	70.354.1635.0	70.374.1635.0	70.354.1635.3	70.374.1635.3
1	72.354.2435.0	72.374.2435.0	72.354.2435.3	72.374.2435.3
1			70.375.4835.3	70.372.4835.3
1	70.354.2435.0	70.374.2435.0	70.354.2435.3	70.374.2435.3
1			70.375.4835.3	70.372.4835.3
1			70.375.4835.3	70.372.4835.3
1			70.375.4835.3	70.372.4835.3

Examples:

10pole connection

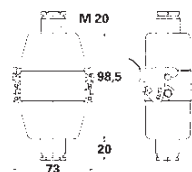

10pole connection

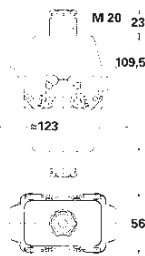

16pole connection

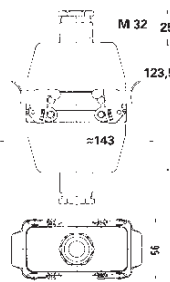

24pole connection

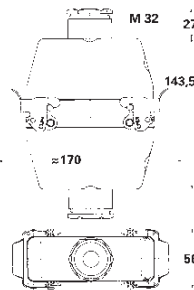

48pole connection

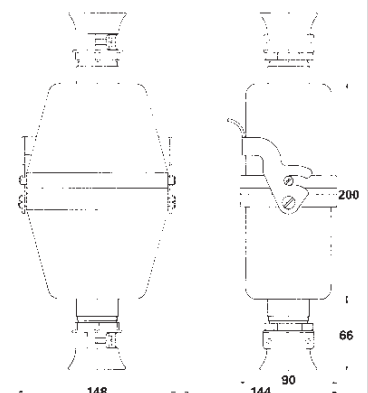

Industrial multipole connector for cable to cable couplings with single locking lever

revos





All hoods and housings can be supplied with an intermediate support and without metric cable glands. For this case please change the part number by adding a 2 in the end (e.g. 72.352.1035.2). If you want to order hoods or housings with metric cable gland only, please indicate a 1 at the end of the part number (e.g. 72.352.1035.1).

For accessories and marking material for hoods and open-bottom housings please see the section Accessories for industrial multipole connectors

Degree of protection: IP 55 accord.to DIN EN 60 529
Degree of protection: IP 65
 accord. to DIN EN 60 529 with appropriate cable glands

Rated current accord. to IEC 61 984

Type	Used cont.	Switch. cont.	Ground	Cable entry	U	UL/CSA	I	Cross section	Stand. pack	Part no.	Part no.
71.4	3	2	1	M 20	690/400 V	600 V	16 A	2.5 mm ² 12 AWG	10	70.400.0340.0	70.410.0340.0
71.4	6	2	1	M 25	690/400 V	600 V	16 A	2.5 mm ² 12 AWG	10	70.400.0640.0	70.410.0640.0
71.2	6	-	1	M 25	400 V	600 V	35 A	6.0 mm ² 8 AWG	10	70.200.0653.0	70.210.0653.0
71.3	10	-	1	M 20	500 V	600 V	16 A	2.5 mm ² 12 AWG	10	70.300.1040.0	70.310.1040.0
71.4	10	2	1	M 32	690/400 V	600 V	16 A	2.5 mm ² 12 AWG	10	70.400.1040.0	70.410.1040.0
71.3	16	-	1	M 25	500 V	600 V	16 A	2.5 mm ² 12 AWG	10	70.300.1640.0	70.310.1640.0
71.4	16	2	1	M 32	690/400 V	600 V	16 A	2.5 mm ² 12 AWG	10	70.400.1640.0	70.410.1640.0
71.3	24	-	1	M 32	500 V	600 V	16 A	2.5 mm ² 12 AWG	10	70.300.2440.0	70.310.2440.0
										Female insert with screw connection	Male insert with screw connection
											
										Male insert with crimp connection	Male insert with crimp connection
73.7	15	-	1	M 20	250 V	600 V	10 A	1.5 mm ² 16 AWG	10	73.700.1553.0	73.710.1553.0
73.7	15	-	1	M 25	250 V	600 V	10 A	1.5 mm ² 16 AWG	10	73.700.1553.0	73.710.1553.0
73.7	25	-	1	M 20	250 V	600 V	10 A	1.5 mm ² 16 AWG	10	73.700.2553.0	73.710.2553.0
73.7	25	-	1	M 25	250 V	600 V	10 A	1.5 mm ² 16 AWG	10	73.700.2553.0	73.710.2553.0

revos

	Hood with cable gland	Hood with cable gland with locking levers and gasket	Hood with strain relief	Hood with strain relief with locking levers and gasket
				
Std. pack	Part no.	Part no.	Part no.	Part no.
1	77.352.1035.0	77.372.1035.0	77.352.1035.3	77.372.1035.3
1	77.352.1635.0	77.372.1635.0	77.352.1635.3	77.372.1635.3
1	71.352.1635.0	71.372.1635.0	71.352.1635.3	71.372.1635.3
1	71.352.1035.0	71.372.1035.0	71.352.1035.3	71.372.1035.3
1	77.354.2435.0	77.374.2435.0	77.354.2435.3	77.374.2435.3
1	71.352.1635.0	71.372.1635.0	71.352.1635.3	71.372.1635.3
1	77.354.2435.0	77.374.2435.0	77.354.2435.3	77.374.2435.3
1	71.354.2435.0	71.374.2435.0	71.354.2435.3	71.374.2435.3
1	76.352.1535.0	76.372.1535.0		
1	76.354.1535.0	upon request		
1	76.352.2535.0	76.372.2535.0		
1	76.354.2535.0	upon request		

Examples:

10pole connection

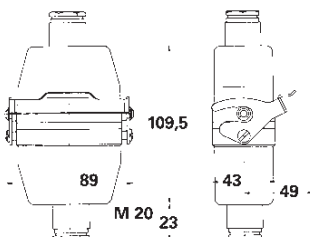

16pole connection

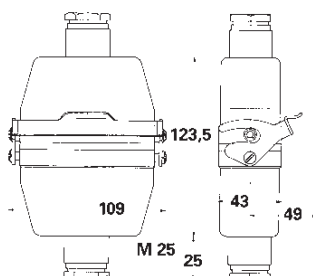

24pole connection

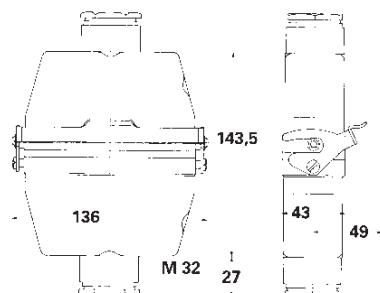

Modular industrial multipole connectors

revos FLEX

Technical Data

■ Approvals	UL, CSA
■ Applicable standards	IEC 61 984
■ Contact inserts	
3pole	
Rated current	max. 40 A
Rated current accord. to UL/CSA	40 A / 35 A
Rated voltage	630 V
Rated voltage accord. to UL/CSA	600 V
Mains voltage	690 V AC
Insulating material	PC, zero halogen
Color	pebble gray, RAL 7032
Flammability class	UL 94 V-0
Crimp connection	Ø 3.6 mm ² , turned contact
4pole + ground	
Rated current	max. 16 A
Rated voltage	1000 V
Insulating material	PA GF, zero halogen
Color	black
Flammability class	UL 94 V-0
Crimp connection	Ø 2.5 mm ² , stamped contact
5pole	
Rated current	max. 20 A
Rated current accord. to UL/CSA	20 A / 16 A
Rated voltage	250 V
Rated voltage accord. to UL/CSA	600 V
Insulating material	PC, zero halogen
Color	pebble gray, RAL 7032
Flammability class	UL 94 V-0
Crimp connection	Ø 2.5 mm ² , turned contact
10pole	
Rated current	max. 10 A
Rated current accord. to UL/CSA	10 A
Rated voltage	250 V
Rated voltage accord. to UL/CSA	600 V
Insulating material	PC, zero halogen
Color	pebble gray, RAL 7032
Flammability class	UL 94 V-0
Crimp connection	Ø 1.6 mm ² , turned contact
20pole	
Rated current	max. 4 A
Rated current accord. to UL/CSA	5 A
Rated voltage	630 V
Rated voltage accord. to UL/CSA	63 V/ 60 V
Insulating material	PC, zero halogen
Color	pebble gray, RAL 7032
Flammability class	UL 94 V-0
Crimp connection	Ø 1.0 mm ² , stamped contact
■ Contacts	
Material	copper alloy
Surface	silver-plated (3, 4, 5 and 10pole) gold-plated (20pole)

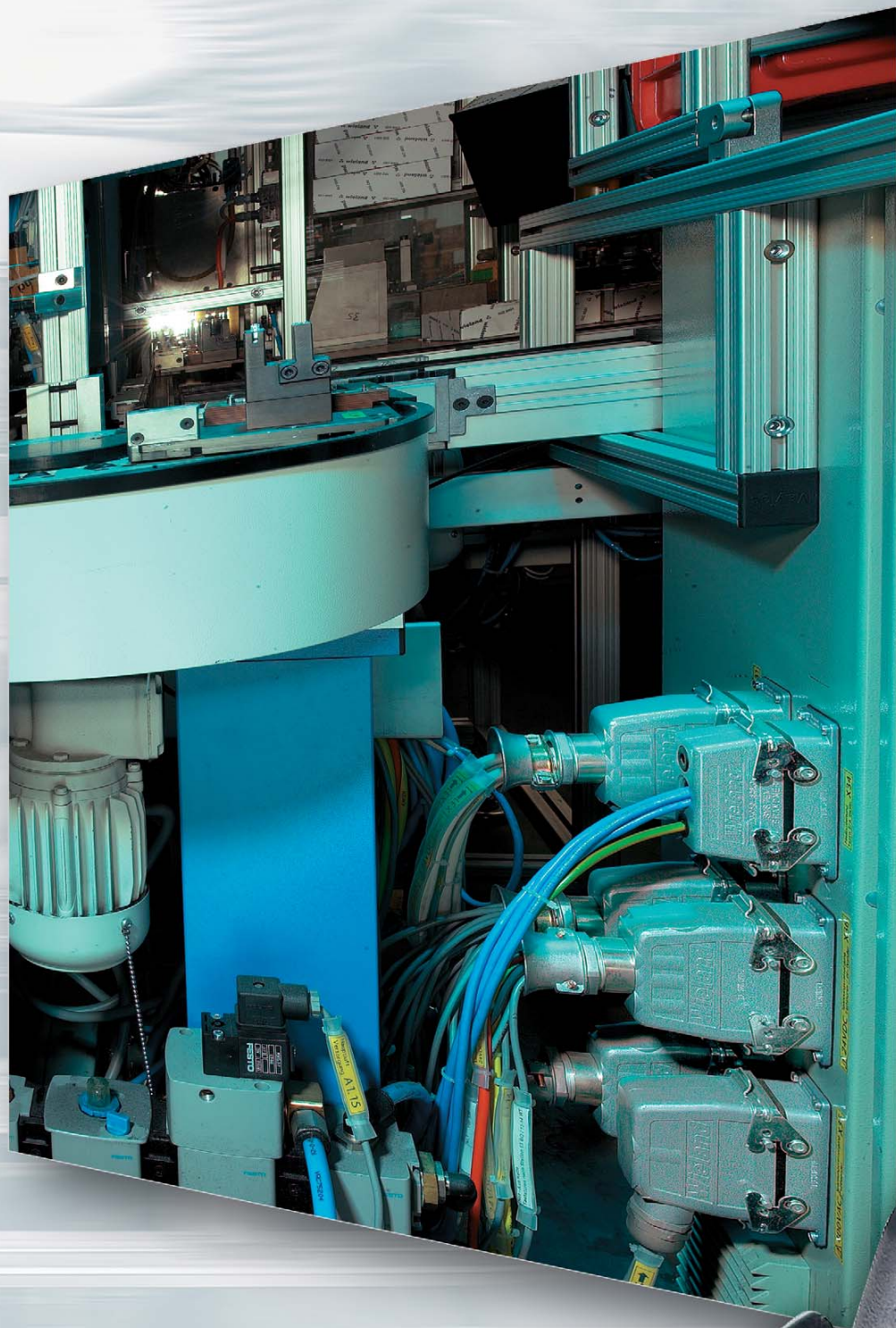

revos

Industrial Multipole Connectors

Modular industrial multipole connectors

revos FLEX

Manager in terms of performance and flexibility

Industrial multipole connectors function as electro-mechanical interfaces and enable an efficient connection between the power supply and control lines of industrial systems and devices. Their complexity, however, becomes more and more demanding and sets limits to standard connector systems.

Wieland Electric GmbH developed the modular multipole connector system **revos FLEX** to meet the requirements of highly complex applications.

The high flexibility of the connector system is characterized by its individual design options which can be adapted to the various applications. The module frames can be fitted with modular inserts of 3 to 20 poles in a voltage range between 100V and 1000V, and for electrical power between 4A and 40A. Flexibility also shows in the fact that the module frames can be fitted inverted, meaning female and male contacts on the same side.

The contacts for the 3, 5 and 10pole modular inserts are turned and silver-plated and can be used for the crimp connection technique. For high-voltage applications, the modular inserts are designed with 4 poles + ground with punched and silver-plated contacts. The contacts of the 20pole modular inserts are also punched, but gold-plated.

You can choose among four sizes of module frames which provide a ground connection at the front.

Die cast aluminum housings are available for 6, 10, 16 and 24pole standard inserts and provide sufficient protection against tough environmental conditions.

System design

- 4 frame sizes
- 5 different modules
- 17 contact variations
- 306 hood and housing options

System advantages

- Flexible usage
 - The modules can be used independently of the signal flow
 - Signal, control and power modules can be combined in one connector
 - Already existing modules can be combined with new modules
 - Future module designs can be used due to the system's modularity
- Safe handling
 - The modules are coded and can therefore not be mated in the frame
 - The connectors can be coded as per the module assignment
 - Easy contact recognition because of the markings
 - Gas-tight crimping
- Cost reduction
 - Small quantities of connectors can be implemented cost effectively
 - Reduced number of connectors
 - Low stock due to reduced product variety
 - Higher availability due to reduced product variety
- in quantities of 100 pieces or more, the frames can be fitted with empty modules according to your drawings.

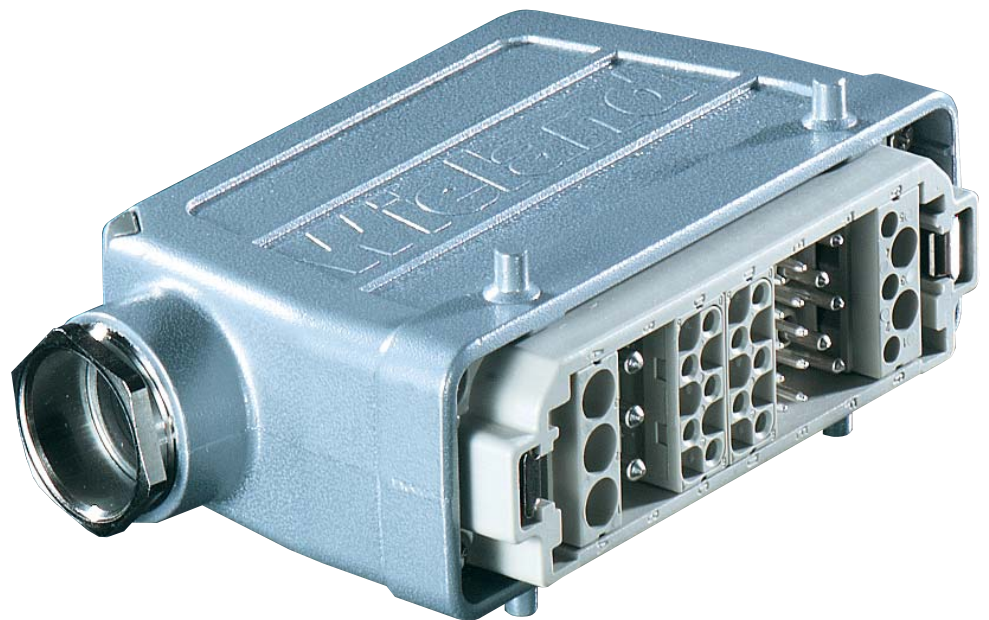

revos

See the following sequence list to design your own connector:

1 Determine the frame such as:
Male contact frame, size 10, for 3 modules 78.010.1053.0
Female contact frame, size 10, for 3 modules 78.000.1053.0

2 Determine the housing such as:
Hood 70.350.1035.0
Housings 70.320.1028.0

3 Select the modules such as:
Modular insert, 3pole, male 78.014.0353.0
Modular insert, 3pole, female 78.004.0353.0

4 Select the contacts such as:
Male contacts for 4 mm² 05.544.3129.8
Female contacts for 4 mm² 02.125.3129.8

5 Select the crimping tools such as:
Crimping tool 95.101.0800.0
Crimping die "D" 05.502.2300.0
Contact positioner "1" 05.502.3100.0

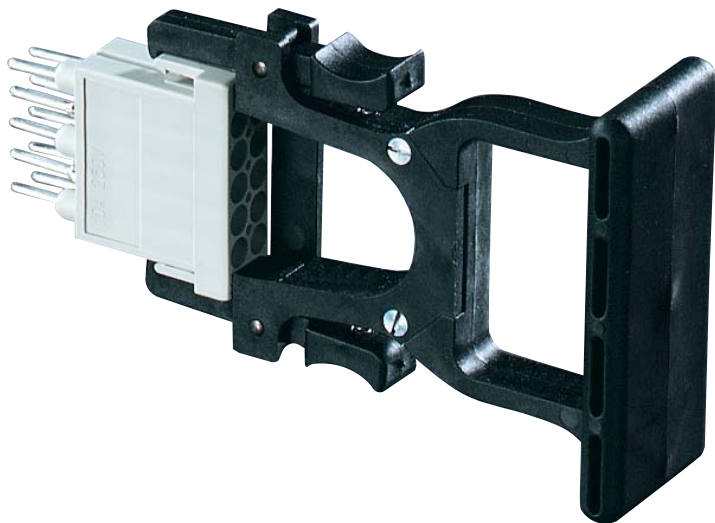
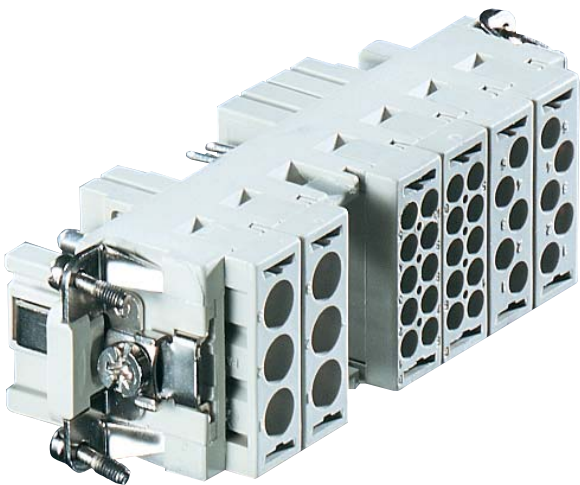

Modular industrial multipole connectors

Technical information

revos FLEX

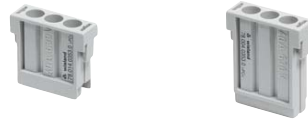

Modular inserts

Crimp contacts

Number of poles of the modular inserts	Part no.	Stand. pack	Approval/	mm ²	AWG	Part no.	Stand. pack
3pole turned contact Ø 3.6 mm Connection range see crimp contact Rated current / UL/CSA max. 40 A / 35 A Rated voltage 630 V/8 kV/3 Mains voltage / UL/CSA 690 V AC / 600 V Insulating material PC, halogen-free Color pebble gray, RAL 7032 Flammability class UL 94 V-0	 	Modular male insert 78.014.0353.0 10 Modular fem. insert 78.004.0353.0 10		Contact Ø 3.6 mm			
				Male contact 4.0 12 05.544.3129.8 100 contact 6.0 10 05.544.3229.8 100 10.0 8 05.544.3329.8 100 Female contact 4.0 12 02.125.3129.8 100 contact 6.0 10 02.125.3229.8 100 10.0 8 02.125.3329.8 100 Contact material copper alloy Contact surface Ag			
4pole + ground punched contact Ø 2.5 mm Connection range see crimp contact Rated current max. 16 A Rated voltage 1000 V/8 kV/3 Insulating material PA 6.6 GF, halogen-free Color black Flammability class UL 94 V-0	 	Mod. male insert 78.013.0453.0 10 Mod. fem. insert 78.003.0453.0 10		Contact Ø 2.5 mm			
				Male contact 0.5 – 1.5 20 – 16 05.544.3429.8 100 contact 1.5 – 2.5 16 – 14 05.544.3529.8 100 Female contact 0.5 – 1.5 20 – 16 02.125.3429.8 100 contact 1.5 – 2.5 16 – 14 02.125.3529.8 100 Contact material copper alloy Contact surface Ag			
5pole turned contact Ø 2.5 mm Connection range see crimp contact Rated current max. 20 A Rated voltage 250 V/6 kV/3 Insulating material PC, halogen-free Color pebble gray, RAL 7032 Flammability class UL 94 V-0	 	Mod. male insert 78.013.0553.0 10 Mod. fem. insert 78.003.0553.0 10		Contact Ø 2.5 mm			
				Male contact 0.5 20 05.544.3629.8 100 contact 0.75 – 1.0 18 05.544.3729.8 100 1.5 16 05.544.3829.8 100 2.5 14 05.544.3929.8 100 4.0 12 05.544.4029.8 100 Female contact 0.5 20 02.125.3629.8 100 contact 0.75 – 1.0 18 02.125.3729.8 100 1.5 16 02.125.3829.8 100 2.5 14 02.125.3929.8 100 4.0 12 02.125.4029.8 100 Contact material copper alloy Contact surface Ag			
10pole turned contact Ø 1.6 mm Connection range see crimp contact Rated current max. 10 A Rated voltage / UL/CSA 250 V/4 kV/3/ 240 V Insulating material PC, halogen-free Color pebble gray, RAL 7032 Flammability class UL 94 V-0	 	Mod. male insert 78.012.1053.0 10 Mod. fem. insert 78.002.1053.0 10		Contact Ø 1.6 mm			
				Male contact 0.14 – 0.37 26 – 22 05.544.4129.8 100 contact 0.5 20 05.544.4229.8 100 0.75 – 1.0 18 05.544.4329.8 100 1.5 16 05.544.4429.8 100 2.5 14 05.544.4529.8 100 Female contact 0.14 – 0.37 26 – 22 02.125.4129.8 100 contact 0.5 20 02.125.4229.8 100 0.75 – 1.0 18 02.125.4329.8 100 1.5 16 02.125.4429.8 100 2.5 14 02.125.4529.8 100 Contact material copper alloy Contact surface Ag			
20pole punched contact Ø 1.0 mm Connection range see crimp contact Rated current / UL/CSA max. 4 A / 5 A Rated voltage / UL/CSA 100 V/1.5 kV/3 / 60 V Insulating material PC, halogen-free Color pebble gray, RAL 7032 Flammability class UL 94 V-0	 	Male module Female 78.011.2053.0 10 module 78.001.2053.0 10		Contact Ø 1.0 mm			
				Male contact 0.09 – 0.25 28 – 24 05.544.4629.7 100 contact 0.25 – 0.5 24 – 20 05.544.4729.7 100 Female contact 0.09 – 0.25 28 – 24 02.125.4629.7 100 contact 0.25 – 0.5 24 – 20 02.125.4729.7 100 Contact material copper alloy Contact surface Au			

revos



Crimping tools



Extraction tool for contacts



Extraction tool for modular inserts

	Part no.	Stand. pack		Part no.	Stand. pack		Part no.	Stand. pack
Crimping tool in system kit	95.101.0800.0	1		05.502.0910.0	1		05.502.1010.0	1
Crimping die "D"	05.502.2300.0	1						
Contact positioner "1"	05.502.3100.0	1						
Crimping tool in system kit	95.101.0800.0	1		05.502.0610.0	1			
Crimping die "C"	05.502.2200.0	1						
Contact positioner "2"	05.502.3200.0	1						
Crimping tool in system kit	95.101.0800.0	1		05.502.0810.0	1			
Crimping die "B"	05.502.2100.0	1						
Contact positioner "1"	05.502.3100.0	1						
Crimping tool in system kit	95.101.0800.0	1		05.502.0710.0	1			
Crimping die "B"	05.502.2100.0	1						
Contact positioner "1"	05.502.3100.0	1						
Crimping tool in system kit	95.101.0800.0	1		05.502.0410.0	1			
Crimping die "A"	05.502.2000.0	1						
no contact positioner required								



Crimping tools for the modular connectors

For contact crimping we provide crimping tools in a modular system: This crimping tool system consists of a crimping tool for which you can select the crimping dies and contact positioners for your required contact type.

The crimping dies and the contact positioner are easily inserted in the tool and exchanged. You will require only one crimping tool for several contact types as you can use it with the corresponding crimping dies and contact positioners.



Modular industrial multipole connectors

revos FLEX



Male

Female

Insulating material PC, halogen-free
 Color pebble gray, RAL 7032
 Flammability class UL 94 V-0

Module frame

	Dimensions in mm	Part no.	Approvals	Stand. pack
Module frame size 6 for 2 modules 	Male module frame Female module frame 	Male module 78.010.0653.0 Female module frame 78.000.0653.0		10 10
Module frame size 10 for 3 modules 	Male module frame Female module frame 	Male module frame 78.010.1053.0 Female module frame 78.000.1053.0		10 10
Module frame size 16 for 5 modules 	Male module frame Female module frame 	Male module frame 78.010.1653.0 Female module frame 78.000.1653.0		10 10
Module frame size 24 for 7 modules 	Male module frame Female module frame 	Male module frame 78.010.2453.0 Female module frame 78.000.2453.0		10 10

revos

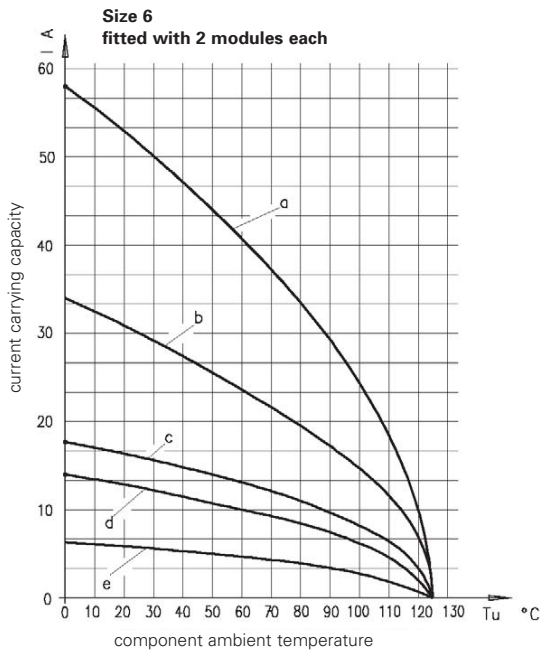

Curve	Num. of poles	Contact diameter	Connector cross section
a	6 (2x3)	3.6 mm, turned	6.0 mm ² / 10 AWG
b	10 (2x5)	2.5 mm, turned	2.5 mm ² / 14 AWG
c	20 (2x10)	1.6 mm, turned	1.5 mm ² / 16 AWG
e	40 (2x20)	1.0 mm, punched	0.5 mm ² / 20 AWG

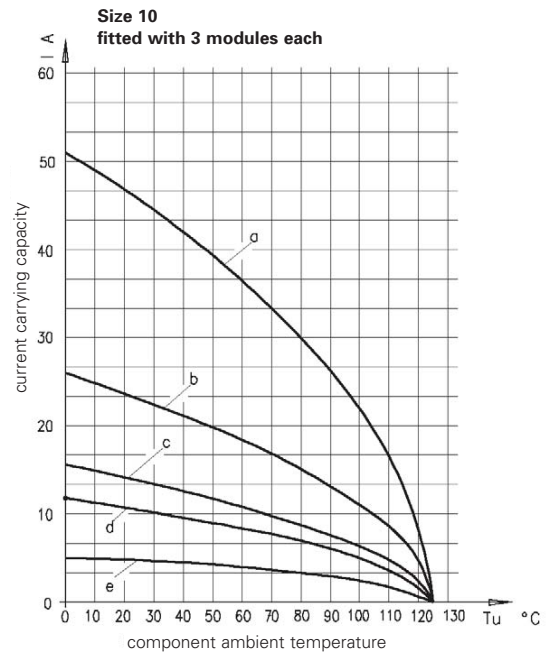

Curve	Num. of poles	Contact diameter	Connector cross section
a	9 (3x3)	3.6 mm, turned	6.0 mm ² / 10 AWG
b	15 (3x5)	2.5 mm, turned	2.5 mm ² / 14 AWG
c	30 (3x10)	1.6 mm, turned	1.5 mm ² / 16 AWG
e	60 (3x20)	1.0 mm, punched	0.5 mm ² / 20 AWG

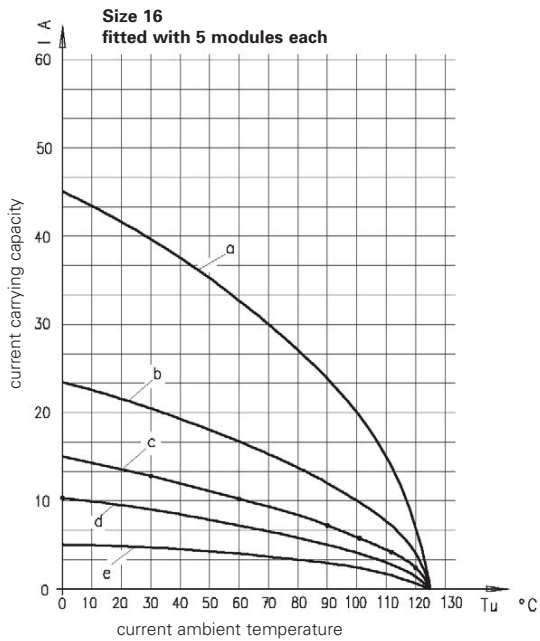

Curve	Num. of poles	Contact diameter	Connector cross section
a	15 (5x3)	3.6 mm, turned	6.0 mm ² / 10 AWG
b	25 (5x5)	2.5 mm, turned	2.5 mm ² / 14 AWG
c	50 (5x10)	1.6 mm, turned	1.5 mm ² / 16 AWG
e	100 (5x20)	1.0 mm, punched	0.5 mm ² / 20 AWG

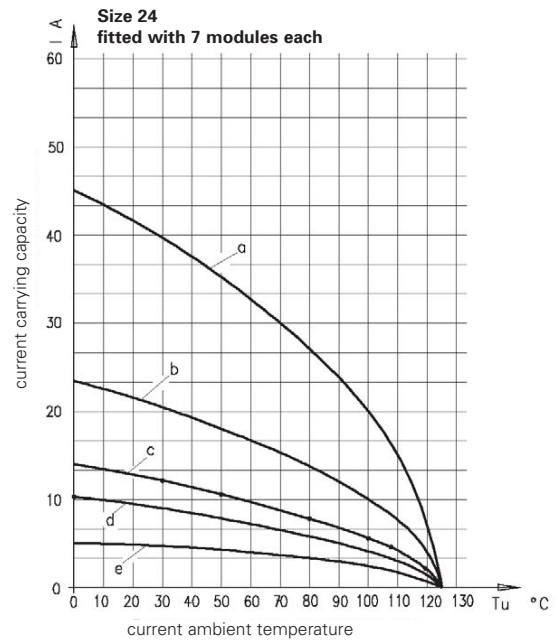

Curve	Num. of poles	Contact diameter	Connector cross section
a	21 (7x3)	3.6 mm, turned	6.0 mm ² / 10 AWG
b	35 (7x5)	2.5 mm, turned	2.5 mm ² / 14 AWG
c	70 (7x10)	1.6 mm, turned	1.5 mm ² / 16 AWG
e	140 (7x20)	1.0 mm, punched	0.5 mm ² / 20 AWG



Modular industrial multipole connector Hoods with single locking levers

revos FLEX

Version A

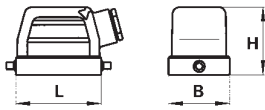

Version C

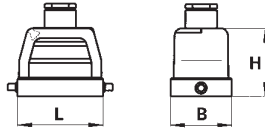

Degrees of protection: IP 55;
IP 65 with the appropriate cable glands (see the accessories)

Number of poles	Thread	Cable gland type	Dimensions in mm	L	W	H	Stand. pack
Size 6 for 2 modular inserts 6pole + ground	M 20	0 with cable gland 1 with threaded collar 2 with intermediate support 3 with strain relief		60	43	47.5	1
	M 25	0 with cable gland 1 with threaded collar 2 with intermediate support 3 with strain relief		60	43	47.5	1
Size 10 for 3 modular inserts 10pole + ground	M 20	0 with cable gland 1 with threaded collar 2 with intermediate support 3 with strain relief		73	43	53	1
	M 25	0 with cable gland 1 with threaded collar 2 with intermediate support 3 with strain relief		73	43	53	1
Size 16 for 5 modular inserts 16pole + ground	M 25	0 with cable gland 1 with threaded collar 2 with intermediate support 3 with strain relief		93.5	43	76	1
	M 32	0 with cable gland 1 with threaded collar 2 with intermediate support 3 with strain relief		93.5	43	76	1
Size 24 for 7 modular inserts 24pole + ground	M 25	0 with cable gland 1 with threaded collar 2 with intermediate support 3 with strain relief		120	43	76	1
	M 32	0 with cable gland 1 with threaded collar 2 with intermediate support 3 with strain relief		120	43	76	1

revos

Hood	Hood
Version A	Version C
	
Part no.	Part no.
70.350.0635.0 70.350.0635.1 70.350.0635.2 70.350.0635.3	70.352.0635.0 70.352.0635.1 70.352.0635.2 70.352.0635.3
70.353.0635.0 70.353.0635.1 70.353.0635.2 70.353.0635.3	70.354.0635.0 70.354.0635.1 70.354.0635.2 70.354.0635.3
71.350.1035.0 71.350.1035.1 71.350.1035.2 71.350.1035.3	71.352.1035.0 71.352.1035.1 71.352.1035.2 71.352.1035.3
71.353.1035.0 71.353.1035.1 71.353.1035.2 71.353.1035.3	71.354.1035.0 71.354.1035.1 71.354.1035.2 71.354.1035.3
76.350.4035.0 76.350.4035.1 76.350.4035.2 76.350.4035.3	76.352.4035.0 76.352.4035.1 76.352.4035.2 76.352.4035.3
76.353.4035.0 76.353.4035.1 76.353.4035.2 76.353.4035.3	76.354.4035.0 76.354.4035.1 76.354.4035.2 76.354.4035.3
76.350.6435.0 76.350.6435.1 76.350.6435.2 76.350.6435.3	76.352.6435.0 76.352.6435.1 76.352.6435.2 76.352.6435.3
76.353.6435.0 76.353.6435.1 76.353.6435.2 76.353.6435.3	76.354.6435.0 76.354.6435.1 76.354.6435.2 76.354.6435.3

Modular industrial multipole connectors

Housings with single locking levers

revos FLEX



Version a

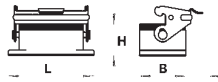

Version b

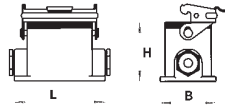

Version c

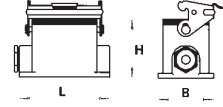

Version d

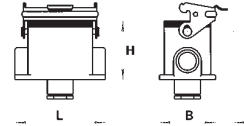

Version i

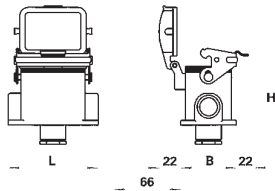

Degrees of protection: IP 55; IP 65
with the appropriate cable glands (see the accessories)

Open-bottom housing

Version a



Closed-bottom housing with two narrow-side entry cable glands

Version b



Closed bottom housing with one narrow-side entry cable gland on the left

Version c



Number of poles	Thread	Cable gland type	L	W	H	Std. pack	Part no.	Part no.	Part no.
Size 6 for 2 modular inserts	M 20	0 with cable gland	80	43	28	1	70.320.0628.0	70.330.0635.0	70.331.0635.0
		1 with threaded collar	84	52	54.5	1			
Size 10 for 3 modular inserts	M 20	0 with cable gland	93	43	28	1	71.320.1028.0	71.330.1035.0	71.331.1035.0
		1 with threaded collar	94	52	54.5	1			
Size 16 high design for 5 modular inserts	M 25	0 with cable gland	113	43	28	1	71.320.1628.0	76.330.4035.0	76.331.4035.0
		1 with threaded collar	117	52	76.5	1			
Size 24 high design for 7 modular inserts	M 25	0 with cable gland	140	43	28	1	71.320.2428.0	76.330.6435.0	76.331.6435.0
		1 with threaded collar	144	52	76.5	1			
Size 24 high design for 7 modular inserts	M 32	0 with cable gland	117	52	76.5	1	71.320.1628.0	76.334.4035.0	76.335.4035.0
		1 with threaded collar	117	52	76.5	1			
Size 24 high design for 7 modular inserts	M 32	0 with cable gland	144	52	76.5	1	71.320.2428.0	76.334.6435.0	76.335.6435.0
		1 with threaded collar	144	52	76.5	1			

Ø 4.3/M 4

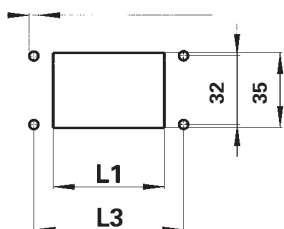

Mounting dimensions and cut-outs for open-bottom housings

Housing size	(mm)	
	L1	L3
6	52	70
10	65	83
16	85.5	103
24	112	130

revos

Version e

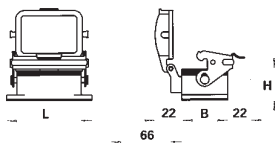

Version f

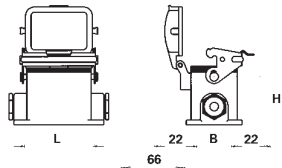

Version g

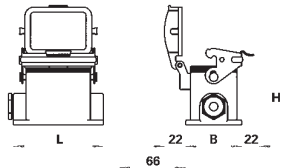

Version h

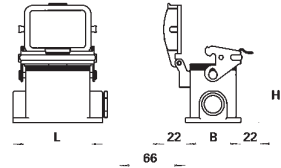

Closed-bottom housing with bottom entry cable gland

Version d



Open-bottom housing with protective cover

Version e



Closed-bottom housing with two narrow-side entry cable glands and protective cover

Version f



Closed bottom housing with one narrow-side entry cable gland on the left and protective cover

Version g



Closed bottom housing with one narrow-side entry cable gland on the right and protective cover

Version h



Closed bottom housing with bottom entry cable gland and protective cover

Version i



Part no.	Part no.	Part no.	Part no.	Part no.	Part no.
70.333.0635.0 70.333.0635.1	70.325.0628.0	70.340.0635.0 70.340.0635.1	70.341.0635.0 70.341.0635.1	70.342.0635.0 70.342.0635.1	70.343.0635.0 70.343.0635.1
71.333.1035.0 71.333.1035.1	71.325.1028.0	71.340.1035.0 71.340.1035.1	71.341.1035.0 71.341.1035.1	71.342.1035.0 71.342.1035.1	71.343.1035.0 71.343.1035.1
76.333.4035.0 76.333.4035.1	71.325.1628.0	76.340.4035.0 76.340.4035.1	76.341.4035.0 76.341.4035.1	76.342.4035.0 76.342.4035.1	76.343.4035.0 76.343.4035.1
76.337.4035.0 76.337.4035.1		76.344.4035.0 76.344.4035.1	76.345.4035.0 76.345.4035.1	76.346.4035.0 76.346.4035.1	76.347.4035.0 76.347.4035.1
76.333.6435.0 76.333.6435.1	71.325.2428.0	76.340.6435.0 76.340.6435.1	76.341.6435.0 76.341.6435.1	76.342.6435.0 76.342.6435.1	76.343.6435.0 76.343.6435.1
76.337.6435.0 76.337.6435.1		76.344.6435.0 76.344.6435.1	76.345.6435.0 76.345.6435.1	76.346.6435.0 76.346.6435.1	76.343.6435.0 76.343.6435.1

Housing size	L5 (mm)	L6 (mm)
6	70	40
10	82	40
16	105	45
24	132	45

Mounting dimensions for closed-bottom housings

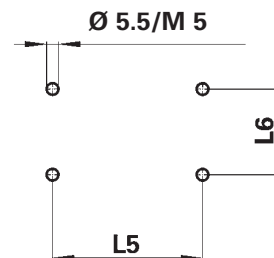

Modular industrial multipole connectors

Hoods with double locking levers

revos FLEX



Version A



Version C

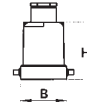

Degrees of protection: IP 55; IP 65
with the appropriate cable glands (see the accessories)

Number of poles	Thread	Cable gland type	Dimensions in mm	L	W	H	Stand. pack
Size 10 for 3 modular inserts	M 20	0 with cable gland 1 with threaded collar 2 with intermediate support 3 with strain relief		73	43	53	1
	M 32	0 with cable gland 1 with threaded collar 2 with intermediate support 3 with strain relief		73	43	76	1
Size 16 for 5 modular inserts	M 25	0 with cable gland 1 with threaded collar 2 with intermediate support 3 with strain relief		93.5	43	76	1
	M 32	0 with cable gland 1 with threaded collar 2 with intermediate support 3 with strain relief		93.5	43	76	1
Size 24 for 7 modular inserts	M 25	0 with cable gland 1 with threaded collar 2 with intermediate support 3 with strain relief		120	43	76	1
	M 32	0 with cable gland 1 with threaded collar 2 with intermediate support 3 with strain relief		120	43	76	1



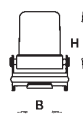
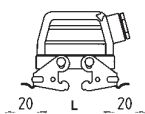

revos

Version D

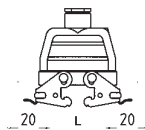

Version F



Hood	Hood	Hood with locking levers	Hood with locking levers	
Version A	Version C	Version D	Version F	
				
Part no.	Part no.	Part no.	Part no.	
70.350.1035.0 70.350.1035.1 70.350.1035.2 70.350.1035.3	70.352.1035.0 70.352.1035.1 70.352.1035.2 70.352.1035.3	70.355.1035.0 70.355.1035.1 70.355.1035.2 70.355.1035.3	70.357.1035.0 70.357.1035.1 70.357.1035.2 70.357.1035.3	
73.353.1035.0 73.353.1035.1 73.353.1035.2 73.353.1035.3	73.354.1035.0 73.354.1035.1 73.354.1035.2 73.354.1035.3			
73.350.4035.0 73.350.4035.1 73.350.4035.2 73.350.4035.3	73.352.4035.0 73.352.4035.1 73.352.4035.2 73.352.4035.3	73.355.4035.0 73.355.4035.1 73.355.4035.2 73.355.4035.3	73.357.4035.0 73.357.4035.1 73.357.4035.2 73.357.4035.3	
73.353.4035.0 73.353.4035.1 73.353.4035.2 73.353.4035.3	73.354.4035.0 73.354.4035.1 73.354.4035.2 73.354.4035.3	73.358.4035.0 73.358.4035.1 73.358.4035.2 73.358.4035.3	73.359.4035.0 73.359.4035.1 73.359.4035.2 73.359.4035.3	
73.350.6435.0 73.350.6435.1 73.350.6435.2 73.350.6435.3	73.352.6435.0 73.352.6435.1 73.352.6435.2 73.352.6435.3	73.355.6435.0 73.355.6435.1 73.355.6435.2 73.355.6435.3	73.357.6435.0 73.357.6435.1 73.357.6435.2 73.357.6435.3	
73.353.6435.0 73.353.6435.1 73.353.6435.2 73.353.6435.3	73.354.6435.0 73.354.6435.1 73.354.6435.2 73.354.6435.3	73.358.6435.0 73.358.6435.1 73.358.6435.2 73.358.6435.3	73.359.6435.0 73.359.6435.1 73.359.6435.2 73.359.6435.3	



Modular industrial multipole connectors

Housings with double locking levers

revos FLEX



Version a

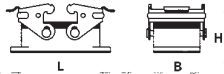

Version b

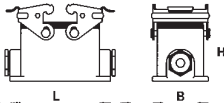

Version c

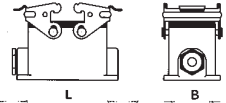

Version d

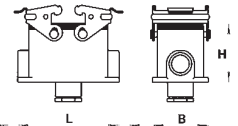

Version i

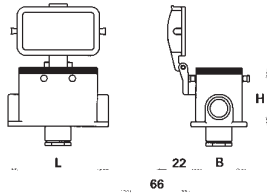

Degrees of protection:
IP 55
IP 65 with the appropriate cable glands (see the access.)

Open-bottom housing

Version a



Closed-bottom housing with two narrow-side entry cable glands

Version b



Closed bottom housing with one narrow-side entry cable gland on the left

Version c



Number of poles	Thread	Cable gland type	L	W	H	Stand. pack.	Part no.	Part no.	Part no.
Size 10 for 3 modular inserts	M 20	0 with cable gland	93	43	28	1	70.320.1028.0	70.330.1035.0	70.331.1035.0
		1 with threaded collar	94	52	54.5	1			
Size 16 high design for 5 modular inserts	M 25	0 with cable gland	113	43	28	1	70.320.1628.0	73.330.4035.0	73.331.4035.0
		1 with threaded collar	117	52	76.5	1			
Size 16 high design for 5 modular inserts	M 32	0 with cable gland	117	52	76.5	1		73.334.4035.0	73.335.6435.0
		1 with threaded collar	117	52	76.5	1			
Size 24 high design for 7 modular inserts	M 25	0 with cable gland	140	43	28	1	70.320.2428.0	73.330.6435.0	73.331.4035.0
		1 with threaded collar	144	52	76.5	1			
Size 24 high design for 7 modular inserts	M 32	0 with cable gland	140	43	28	1		73.334.6435.0	73.335.6435.0
		1 with threaded collar	144	52	76.5	1			

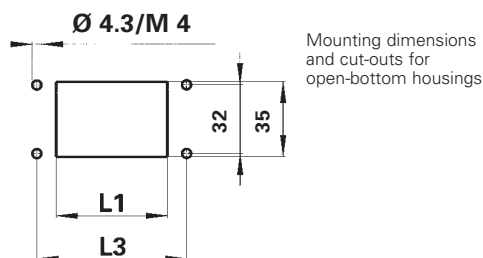

Housing size	(mm)	
	L1	L3
10	65	83
16	85.5	103
24	112	130

revos

Version e

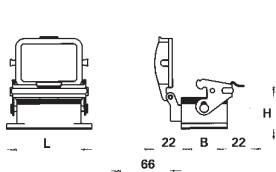

Version f

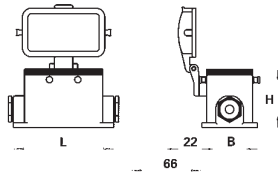

Version g

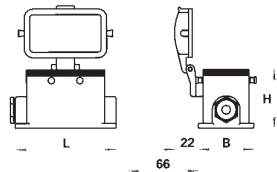

Version h

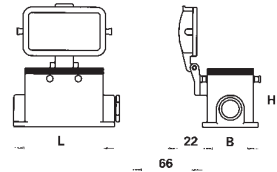

Closed-bottom housing with bottom entry cable gland

Version d



Open-bottom housing with protective cover

Version e



Closed-bottom housing with two narrow-side entry cable glands and protective cover

Version f



Closed bottom housing with one narrow-side entry cable gland on the left and protective cover

Version g



Closed bottom housing with one narrow-side entry cable gland on the right and protective cover

Version h



Closed bottom housing with bottom entry cable gland and protective cover

Version i



Part no.	Part no.	Part no.	Part no.	Part no.	Part no.
70.333.1035.0 70.333.1035.1	70.325.1028.0	70.340.1035.0 70.340.1035.1	70.341.1035.0 70.341.1035.1	70.342.1035.0 70.342.1035.1	70.343.1035.0 70.343.1035.1
73.333.4035.0 73.333.4035.1	70.325.1628.0	73.340.4035.0 73.340.4035.1	73.341.4035.0 73.341.4035.1	73.342.4035.0 73.342.4035.1	73.343.4035.0 73.343.4035.1
73.337.4035.0 73.337.4035.1		73.344.4035.0 73.344.4035.1	73.345.4035.0 73.345.4035.1	73.346.4035.0 73.346.4035.1	73.347.4035.0 73.347.4035.1
73.333.6435.0 73.333.6435.1	70.325.2428.0	73.340.6435.0 73.340.6435.1	73.341.6435.0 73.341.6435.1	73.342.6435.0 73.342.6435.1	73.343.6435.0 73.343.6435.1
73.337.6435.0 73.337.6435.1		73.344.6435.0 73.344.6435.1	73.345.6435.0 73.345.6435.1	73.346.6435.0 73.346.6435.1	73.347.6435.0 73.347.6435.1

Mounting dimensions for closed-bottom housings

Housing size	L5 (mm)	L6 (mm)
10	82	40
16	105	45
24	132	45

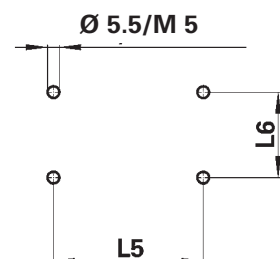

Industrial multipole connectors

revos IT

Technical information

■ **Applicable standards**

IEC 61 984

■ **Hoods and housings**

Material

die cast aluminum alloy

Surface

silver gray, silicon-free finish

Clamping screws

galvanically zinc-plated steel

Locking levers:

Steel, galvanically zinc-plated and dichromated

Gaskets

Neoprene (oil-resistant and anti-aging)

1 cable feed-through

Cable diameter: 2 – 10 mm

2 cable feed-throughs

Cable diameter: 9 - 15 mm

Temperature range

-40 to +100 °C

Degree of protection

accord. to DIN EN 60 529

with latched locking levers

IP 55

with appropriate cable glands

IP 65

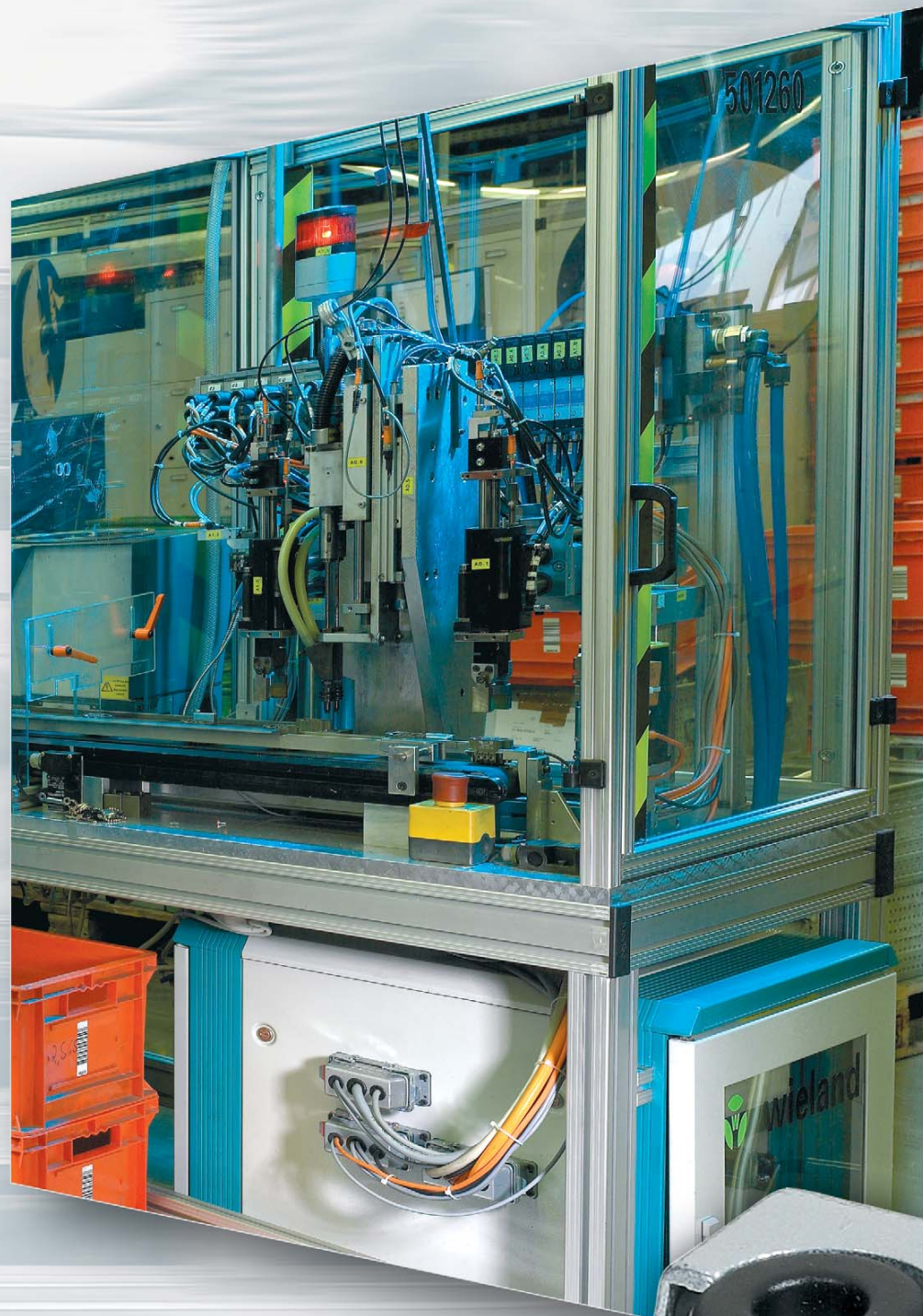

revos

Industrial Multipole Connectors

Industrial multipole connectors Data cable feed-through

revos IT

The data cable feed-through can be separated.

The two halves, one of which has ring-shaped rubber gaskets, are closed by means of two threaded screws.

Inside each of the two halves a special rubber clamping profile properly seals the cables. Three metal clips provide the strain relief.

The **data cable feed-through** was designed to insert cables into closed housings, tightly and with strain relief, without having to disassemble the connectors. It is the ideal technique for connection cables of PLCs, data cables, measuring and encoder lines.

Each data cable feed-through has three feed-through facilities for cables of different diameters. Feed-through holes which are not used can be sealed with plastic covers.

The data cable feed-through can be snapped onto a 16pole housing without an insert. These housings normally provide enough space to insert the connectors of data cables or measuring lines without a problem.

Technical information

Hood and housing

Die cast aluminum alloy with silicon-free finish in silver gray

Temperature range: -40°C bis +100°C

Clamping screws: galvanically zinc-plated steel

Locking levers: steel, galvanically zinc-plated and dichromated

Gaskets: Neoprene (oil-resistant and anti-aging)

They meet the degree of protection IP 65 accord. to EN 60 529: (IEC 60 529: 1989, 2nd edition)

2 cable feed-throughs for cable diameters of 2 mm – 10 mm

1 cable feed-through for cable diameters of 2 mm – 15 mm



revos



Type	Part no.	Stand. pack
Data cable feed-through	70.060.1628.0	10
Housing, 16pole	70.320.1628.0	1
Rubber gaskets can be ordered as replacement parts		
Rubber gasket for:		
Connection range 2 mm – 10 mm	05.562.3183.0	10
Connection range 9 mm – 15 mm	05.562.3283.0	10

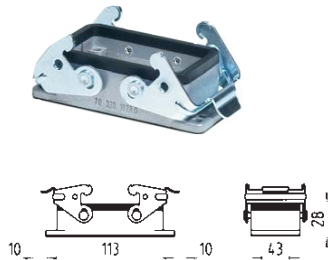

Mounting dimensions and cut-outs for open-bottom housings (mm)

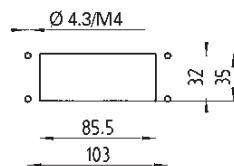

Industrial multipole connectors with single locking levers, 9 to 100pole

D-Sub connectors

revos IT



D-Sub connectors

Degrees of protection: IP 55
IP 65 with appropriate cable glands

Pole configuration	Part no.	Stand. pack	Part no.	Stand. pack	Size
	 <p>Housing with female connector</p>		 <p>Hood with male connector</p>		
9pole	Z7.415.0010.0		Z7.415.0235.0	10	6
2 x 9 = 18pole	Z7.415.0110.0		Z7.415.0335.0	10	6
15pole	Z7.415.0810.0		Z7.415.1035.0	10	6
2 x 15 = 30pole	Z7.415.0910.0		Z7.415.1135.0	10	6
25pole	Z7.415.1610.0		Z7.415.1935.0	10	10
15 + 25 = 40pole	Z7.415.1810.0		Z7.415.2135.0	10	10
2 x 25 = 50pole	Z7.415.1710.0		Z7.415.2035.0	10	10
37pole	Z7.415.2410.0		Z7.415.2635.0	10	16
2 x 37 = 74pole	Z7.415.2510.0		Z7.415.2735.0	10	16
50pole	Z7.415.3210.0		Z7.415.3335.0	10	16
2 x 50 = 100pole	Z7.415.3410.0		Z7.415.3535.0	10	16

revos

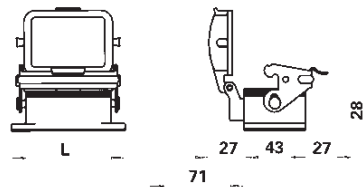
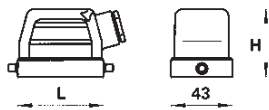

Housing size	L (mm)	H (mm)
6	60	47.5
10	73	53
16	93.5	60

Housing size	L (mm)
6	80
10	93
16	113

Delivery standard:

Hood/housing, D-Sub connector, mounting screws and mounting plates are delivered unassembled.

Hood with M 20 cable gland

The contacts are nickle-plated and hard-gold-plated in the contact area.

Current carrying capacity per contact with ambient temperatures of:

+ 20 °C	5 A
+ 70 °C	3 A
+ 100 °C	1.5 A

Solder connection

max. 0.5 mm²

Rated voltage

40 V/1 kV/2

Mounting dimensions and cut-outs for open-bottom housings (mm)

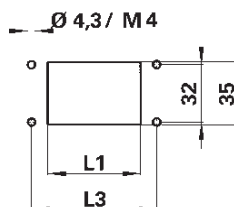

Housing size	L1 (mm)	L3 (mm)
6	52	70
10	65	83
16	85.5	103





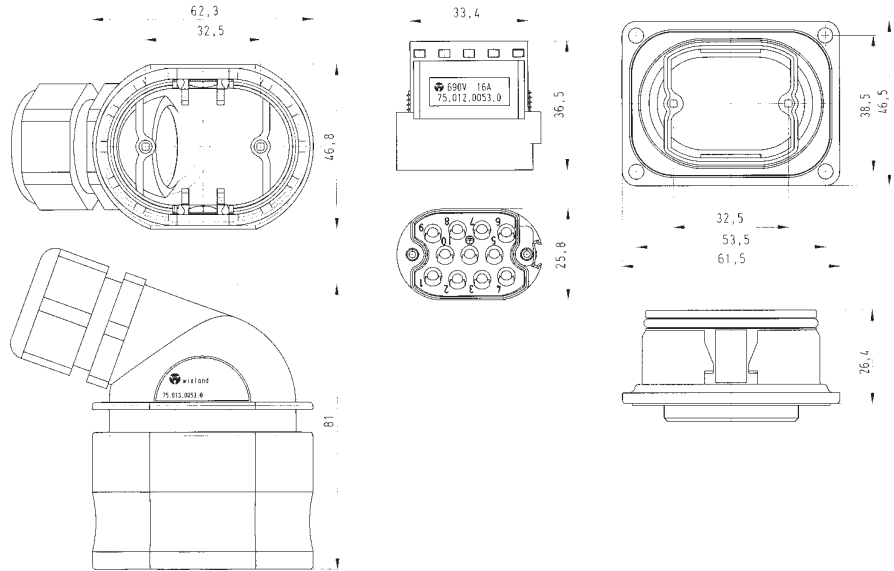



Industrial multipole connectors

revos MOT



600 V UL/CSA

690 V, 16 A IEC 61 984

Number of poles		Thread	Number of poles	>ØK in mm	Approvals	Cable entry side	Stand. pack	Part no.
	Hood with IP 65 cable gland	M 25	10pole			narrow side	10	75.013.0051.0
	Hood with compression gland	M 25	10pole			narrow side	10	75.013.0051.2
	Housing		10pole + ground			open-bottom	10	75.013.5051.0
	Female insert		10pole + ground				10	75.012.0053.0
	Male insert		10pole + ground				10	75.012.5053.0
	Cable gland, standard	M 25 x 1.5		9 – 16				Z5.507.1453.1
	Cable gland	M 25 x 1.5		13 – 18				Z5.507.1553.1

revos

Contacts for crimp version

Female contacts



Male contacts



Crimping tool
Crimping die "B"
Contact positioner "3"
Extraction tool

Ø in mm ²	Part no.	Stand. pack	Ø in mm ²	Part no.	Stand. pack
tin-plated			gold-plated		
0.5	20 AWG 02.123.7021.0	200	0.5	20 AWG 02.123.7001.0	upon request
0.75 - 1	18 AWG 02.123.7121.0	200	0.75 - 1	18 AWG 02.123.7101.0	upon request
1.5	16 AWG 02.123.7221.0	200	1.5	16 AWG 02.123.7201.0	upon request
2.5	14 AWG 02.123.7321.0	200	2.5	14 AWG 02.123.7301.0	upon request
4	12 AWG 02.123.7421.0	200	4	12 AWG 02.123.7401.0	upon request
0.5	20 AWG 05.543.7021.0	200	0.5	20 AWG 05.543.7001.0	upon request
0.75 - 1	18 AWG 05.543.7121.0	200	0.75 - 1	18 AWG 05.543.7101.0	upon request
1.5	16 AWG 05.543.7221.0	200	1.5	16 AWG 05.543.7201.0	upon request
2.5	14 AWG 05.543.7321.0	200	2.5	14 AWG 05.543.7301.0	upon request
4	12 AWG 05.543.7421.0	200	4	12 AWG 05.543.7401.0	upon request
	95.101.0800.0	1			
	05.502.2100.0	1			
	05.502.3300.0	1			
	05.502.3500.0	1			
				silver-plated upon request	

Technical information:

Rated current:	16 A
Rated voltage:	690 V
Nominal voltage accord. to UL:	600 V
Nominal voltage accord. to CSA:	600 V
Rated cross section:	0.5 - 4 mm ² 20 - 12 AWG
Pollution degree:	3
Rated peak voltage	8 kV
Temperature range:	-40 °C to +80 °C
Flammability accor. to UL 94:	V0
Inserts:	V0
hoods/housings:	V2
Connection range:	9 - 16 mm 13 - 18 mm
Connection style:	crimp connection
Degree of protection:	IP 65
Color:	inserts in gray RAL 7035 hoods/housings in black RAL 9005
Material:	Polyamide

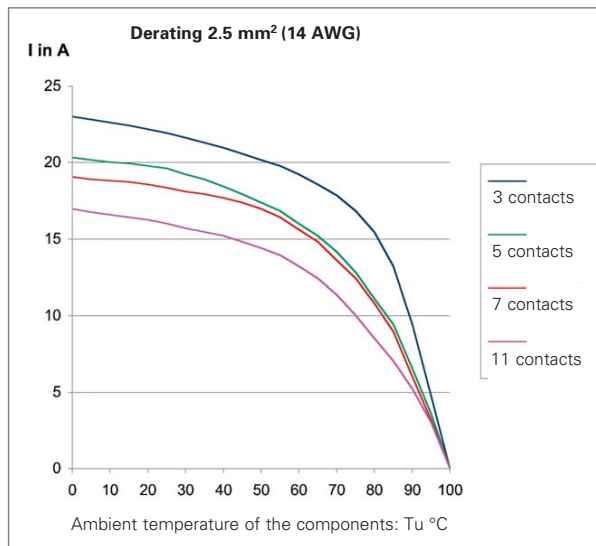



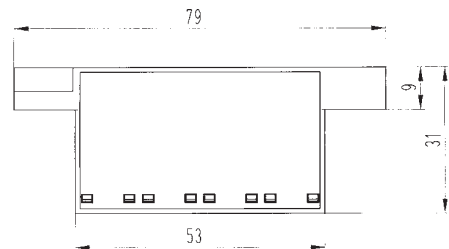
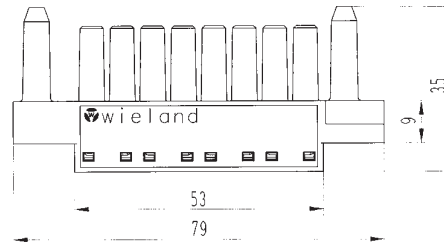
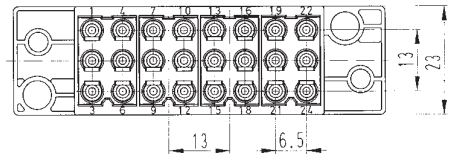
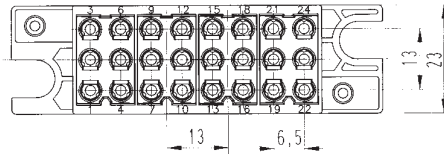

Industrial multipole connectors

24pole

revos SLIDE



250 V 10 A IEC 61 984

	Number of poles		Approvals	Stand. pack	Part no.
Female insert	24pole		 pending	100	99.700.6905.5
Male insert	24pole		 pending	100	99.701.6905.5

revos

Contacts for crimp version

Female contacts



Male contacts



Crimping tool
Crimping die "B"
Contact positioner "3"
Extraction tool for the contacts

Ø mm ²	Part no.	Stand. pack
1.5 mm ² 16 AWG	silver-plated 02.125.1121.0	100
1.5 mm ² 16 AWG	05.544.5621.0	100
	95.101.0800.0	1
	05.502.2100.0	1
	05.502.3300.0	1
	05.502.3500.0	1

Technical information:

Rated current:	10 A
Rated voltage:	250 V
Rated cross section:	1.5 mm ² 16 AWG
Pollution degree:	3
Rated peak voltage	4 kV
Temperature range:	-20 °C to +80 °C
Flammability accor. to UL 94:	V0 50 (80) °C see derating
Degree of protection:	IP 20
Connection style:	crimp connection
Material:	Polyamide
Approvals:	UL/CSA pending

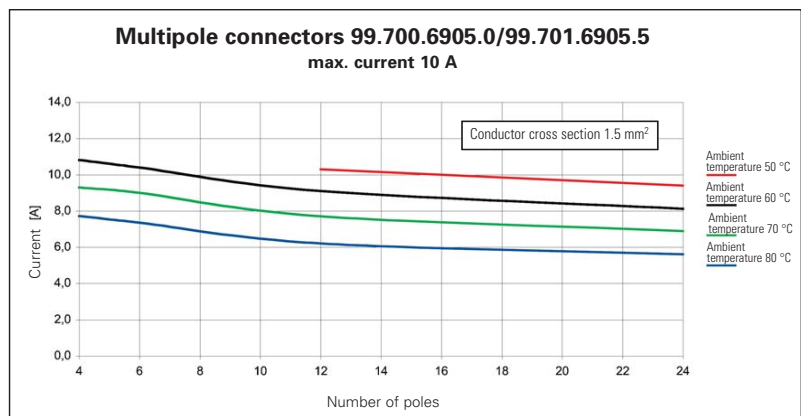
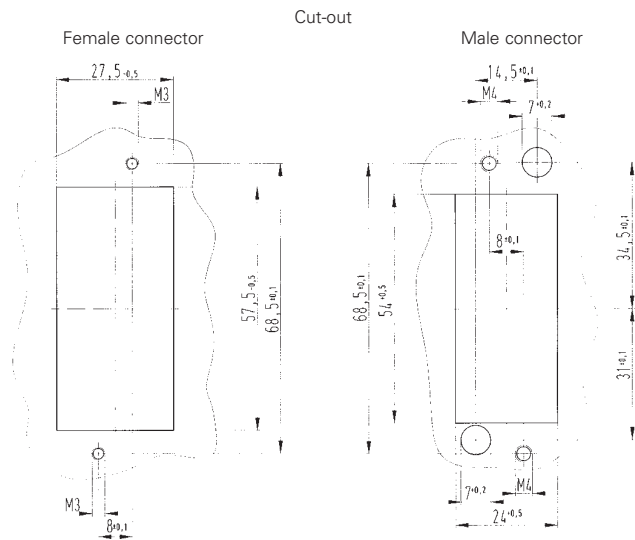

This curve does not apply for intermittent currents

Industrial multipole connectors

6/10/16/24/48pole

revos Ex

Technical information

■ Approvals	BVS
■ Applicable standards	IEC 61 984
■ Contact inserts	
Rated current	16 A
Rated voltage	90 V
Pole configurations	6-, 10-, 16-, 24-, 48pole (2x24), + ground
Screw connection	0.5 – 2.5 mm ² / 20 – 12 AWG
Degree of pollution	3
Temperature range	–40 to +110 °C
■ Contacts	
Material	copper alloy
Surface	tin-plated
■ Hoods and housings	
Material	die cast aluminum alloy
Surface	light blue, silicon-free finish
Locking levers	zinc-plated steel
Gaskets	NBR
Temperature range	–40 to +110 °C
Degree of protection accord. to DIN EN 60 529	IP 55



Industrial Multipole Connectors

Industrial multipole connectors

6/10/16/24/48pole

revos Ex

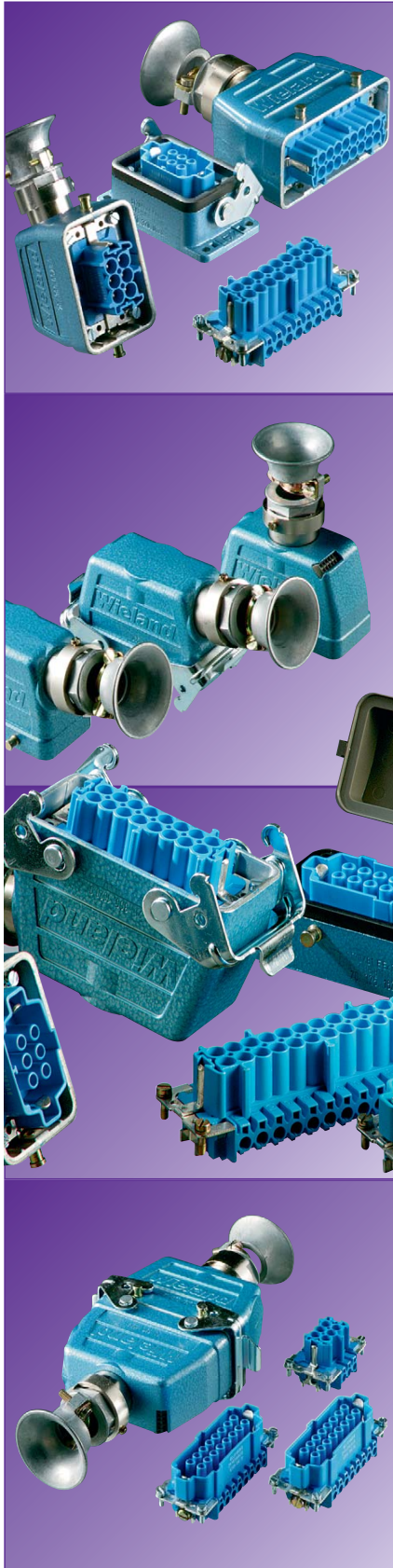

System description

- For applications in mining, machine construction, control and switchgear building, especially for use in intrinsic electrical systems
- BVS-tested and approved
- Reliable connector elements for power and control current lines
- Outstanding feature: a robust die cast zinc housing, color blue
- Protection of the internal contact-inserts against mechanical and hazardous industrial influences
- According to EN 60 529, IEC 60 529, the interlocked hoods and housings provide the degree of protection IP 55 (dust ingress and jet water)

Protective cover

- Hoods and housings with / without hinged protective cover

Cable to cable couplings

- low and high designs
- Locking with 1 lever on the broad side (6pole and 48pole)
- Locking with 2 levers on the narrow side (10, 16 and 24pole)

Female and male connector inserts:

- Insulating parts made from fiberglass reinforced Polyamide (technical information: see **facts & DATA**)

Material

Housing:

- Hoods/housings: die cast zinc alloy, with hammer finish in blue

Housing:

- with open-bottom housing: cable entry at the bottom
- with closed-bottom housing: narrow-side cable entry
- Connector with open-bottom housing; housing with protective cover attached by hinged joint
- Connector with closed-bottom housing; housing with protective cover attached by hinged joint
- Connector with compression gland

DQS certificates for all product families

- Quality standard as per DIN ISO 9001
- in Development, Production, Assembly
- Continued control of the quality standard by means of regular internal and external quality audits
- Compatible with certificates of other countries:
 - BSI Certificate, Great Britain
 - SQS Certificate, Switzerland
 - Aib-Vincotte Certificate, Belgium
 - ÖQS Certificate, Austria

revos



- ❑ Combination with flat open-bottom housing in die cast zinc alloy



- ❑ Combination with high closed-bottom housing in die cast zinc alloy



- ❑ Combination with low open-bottom housing in die cast zinc alloy with protective cover



- ❑ Combination with high closed-bottom housing in die cast zinc alloy with protective cover



- ❑ Combination of 2 hoods as cable to cable coupling, with narrow-side locking levers, die cast zinc alloy



revos

Industrial multipole connectors Female/male inserts



revos Ex



90 V

Degree of protection: IP 55

Multipole connectors for intrinsic systems EEx ia, color: blue

		Rated current	Cross section	Approvals	Wire strip length	Stand. pack
 <p>Screw connection</p>	Female insert	16 A	0.5 – 2.5 mm ² 20 – 12 AWG	EExia	7 mm	10
 <p>Screw connection</p>	Male insert	16 A	0.5 – 2.5 mm ² 20 – 12 AWG	EExia	7 mm	10

revos

6pole + ground	10pole + ground	16pole + ground	24pole + ground	48pole + ground	
Part no.	Part no.	Part no.	Part no.	Part no.	
72.300.0653.9	72.300.1053.9	72.300.1653.9	72.300.2453.9	72.300.4853.9	
72.310.0653.9	72.310.1053.9	72.310.1653.9	72.310.2453.9	72.310.4853.9	



Modular industrial multipole connectors

Hoods with single and double locking levers

revos Ex



Version A



Version C

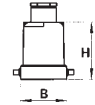
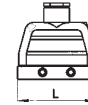

90 V

Degree of protection: IP 55

Multipole connectors for intrinsic systems EEx ia

Number of poles	Thread	Cable gland type	Dimensions in mm	L	W	H	Stand. pack
Size 6 for multipole connectors 6pole + ground	Pg 13.5	7 with Pg thread 9 with strain relief		60	43	47.5	1
	Pg 16	7 with Pg thread 9 with strain relief		60	43	47.5	1
Size 10 for multipole connectors 10pole + ground	Pg 16	7 with Pg thread 9 with strain relief		73	43	53	1
	Pg 21	7 with Pg thread 9 with strain relief		73	43	53	1
Size 16 for multipole connectors 16pole + ground	Pg 21	7 with Pg thread 9 with strain relief		93.5	43	60	1
	Pg 29	7 with Pg thread 9 with strain relief		93.5	43	60	1
Size 24 for multipole connectors 24pole + ground	Pg 21	7 with Pg thread 9 with strain relief		120	43	70	1
	Pg 29	7 with Pg thread 9 with strain relief		120	43	70	1
Size 48 for multipole connectors 48pole + ground	Pg 29	7 with Pg thread 9 with strain relief		132	90	107	1
	Pg 32	7 with Pg thread 9 with strain relief		132	90	107	1



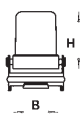
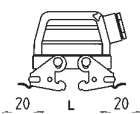

revos

Version D

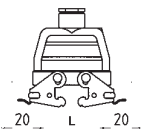

Version F



Hood with cable gland Version A	Hood with cable gland Version C	Hood with cable gland and locking levers Version D	Hood with cable gland and locking levers Version F	
				
Part no.	Part no.	Part no.	Part no.	
70.350.0628.7 70.360.0628.9	70.352.0628.7 70.362.0628.9			
70.363.0628.9	70.354.0628.7 70.364.0628.9			
70.350.1028.7 70.360.1028.9	70.352.1028.7 70.362.1028.9	70.355.1028.7 70.365.1028.9	70.367.1028.9	
70.363.1028.9	70.354.1028.7 70.364.1028.9	70.368.1028.9	70.369.1028.9	
70.350.1628.7 70.360.1628.9	70.352.1628.7 70.362.1628.9	70.355.1628.7 70.365.1628.9	70.367.1628.9	
70.363.1628.9	70.354.1628.7 70.364.1628.9	70.368.1628.9	70.359.1628.7 70.369.1628.9	
70.350.2428.7 70.360.2428.9		70.365.2428.9	70.367.2428.9	
70.363.2428.9	70.354.2428.7	70.358.2428.7 70.368.2428.9		
70.350.4828.7 70.360.4828.9	70.352.4828.7 70.362.4828.9			
70.353.4828.7	70.354.4828.7 70.364.4828.9			



Modular industrial multipole connectors

Housings with single and double locking levers

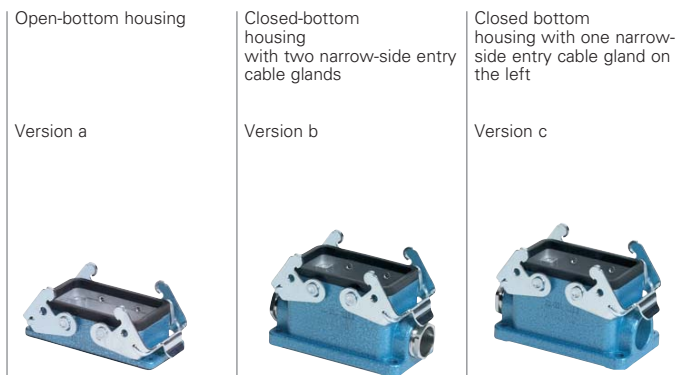
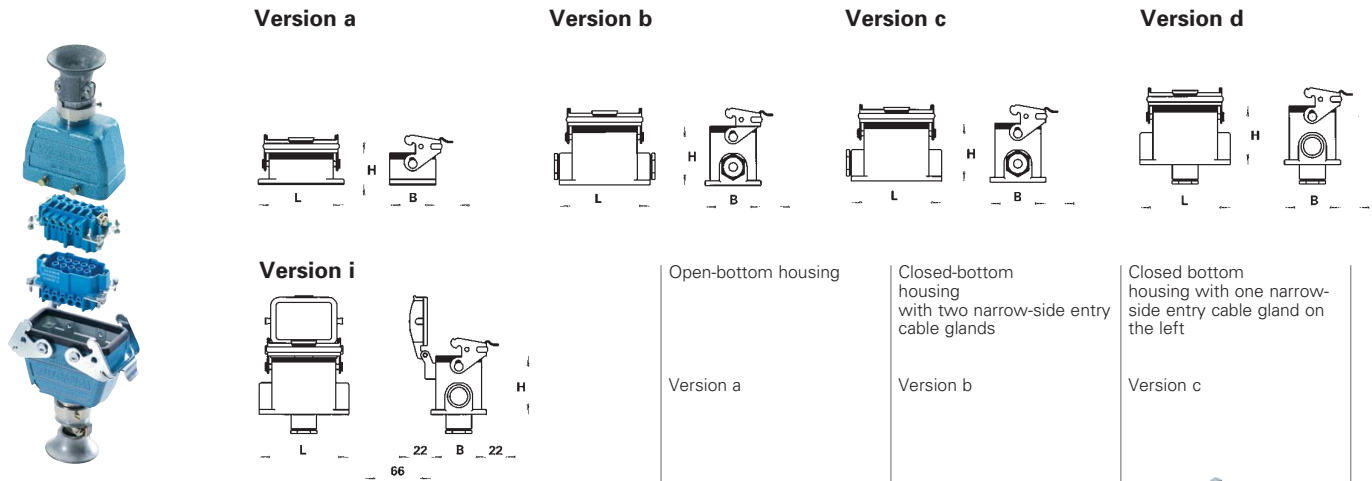
90 V

Degree of protection: IP 55
Multipole connectors for intrinsic systems EEx ia

Number of poles	Thread	Cable gland type	L	W	H	Stand. pack	Part no.	Part no.	Part no.
Housing size 6 for multipole connectors 6pole + ground		9 with cable gland	80	43	28	1	70.320.0628.9		
	Pg 16		84	52	54.5	1		70.330.0628.9	70.331.0628.9
Housing size 10 for multipole connectors 10pole + ground		9 with cable gland	93	43	28	1	70.320.1028.9		
	Pg 16		94	52	54.5	1		70.330.1028.9	70.331.1028.9
Housing size 16 for multipole connectors 16pole + ground			113	43	28	1	70.320.1628.9		
Housing size 24 for multipole connectors 24pole + ground		9 with cable gland	140	43	44	1	70.320.2428.9		
	Pg 21		144	52	56.5	1		70.330.2428.9	70.331.2428.9
Housing size 48 for multipole connectors 48pole + ground			165	90	44	1	70.320.4828.9		
	Pg 29	9 with cable gland	146	120	99	1			70.331.4828.9
	Pg 36	9 with strain relief	146	120	99	1			

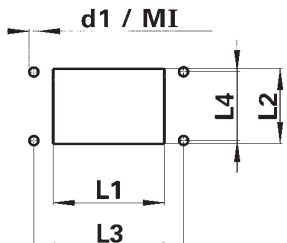

Mounting dimensions and cut-outs for open-bottom housings

Housing size	Cut-out (mm)		Mounting dimensions (mm)		d1 (mm)	MI
	L1	L2	L3	L4		
6	52	35	70	32	4.3	M 4
10	65	35	83	32	4.3	M 4
16	85.5	35	103	32	4.3	M 4
24	112	35	130	32	4.3	M 4
48	117	81	148	70	6.4	M 6

revos

Version e

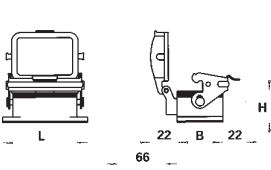

Version f

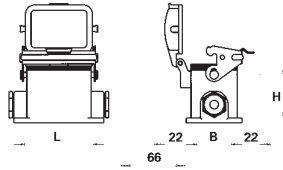

Version g

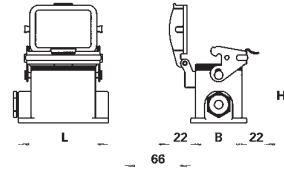

Version h

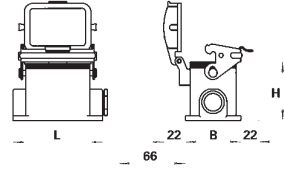

Closed-bottom housing with bottom entry cable gland

Version d



Open-bottom housing with protective cover

Version e



Closed-bottom housing with two narrow-side entry cable glands and protective cover

Version f



Closed bottom housing with one narrow-side entry cable gland on the left and protective cover

Version g



Closed bottom housing with one narrow-side entry cable gland on the right and protective cover

Version h



Closed bottom housing with bottom entry cable gland and protective cover

Version i



Part no.	Part no.	Part no.	Part no.	Part no.	Part no.
70.333.0628.9	70.325.0628.9	70.340.0628.9	70.341.0628.9	70.342.0628.9	70.343.0628.9
70.333.1028.9	70.325.1028.9	70.340.1028.9	70.341.1028.9	70.342.1028.9	70.343.1028.9
	70.325.1628.9				
70.333.2428.9	70.325.2428.9	70.340.2428.9	70.341.2428.9	70.342.2428.9	70.343.2428.9
	70.325.4828.9		70.341.4828.9		
			70.344.4828.9		

Housing size	L5 (mm)	L6 (mm)	d2 (mm)	MII
6	70	40	5.5	M 5
10	82	40	5.5	M 5
16	105	45	5.5	M 5
24	132	45	5.5	M 5
48	111	106	6.5	M 6

Mounting dimensions for closed-bottom housings

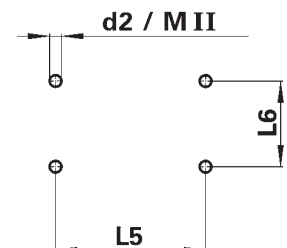

Special combinations for cable to cable couplings



		Female insert	Male insert	Hood with strain relief, with locking levers and gasket	Hood with strain relief without locking levers
				Pos. 1 	Pos. 2
Number of poles	Cable entry size	Part no.	Part no.	Part no.	Part no.
6 + ground	Pg 13.5	72.300.0653.9	72.310.0653.9	99.701.3329.7	70.362.0628.9
6 + ground	Pg 16	72.300.0653.9	72.310.0653.9	99.721.3329.7	70.364.0628.9
10 + ground	Pg 16	72.300.1053.9	72.310.1053.9	99.707.3329.7	70.362.1028.9
10 + ground	Pg 21	72.300.1053.9	72.310.1053.9	99.727.3329.7	70.364.1028.9
16 + ground	Pg 21	72.300.1653.9	72.310.1653.9	99.703.3329.7	70.362.1628.9
16 + ground	Pg 29	72.300.1653.9	72.310.1653.9	99.723.3329.7	70.364.1628.9
24 + ground	Pg 29	72.300.2453.9	72.310.2453.9	99.705.3329.7	70.362.2428.9
48 + ground	Pg 29	72.300.4853.9	72.310.4853.9	70.377.4828.9	70.375.4828.9

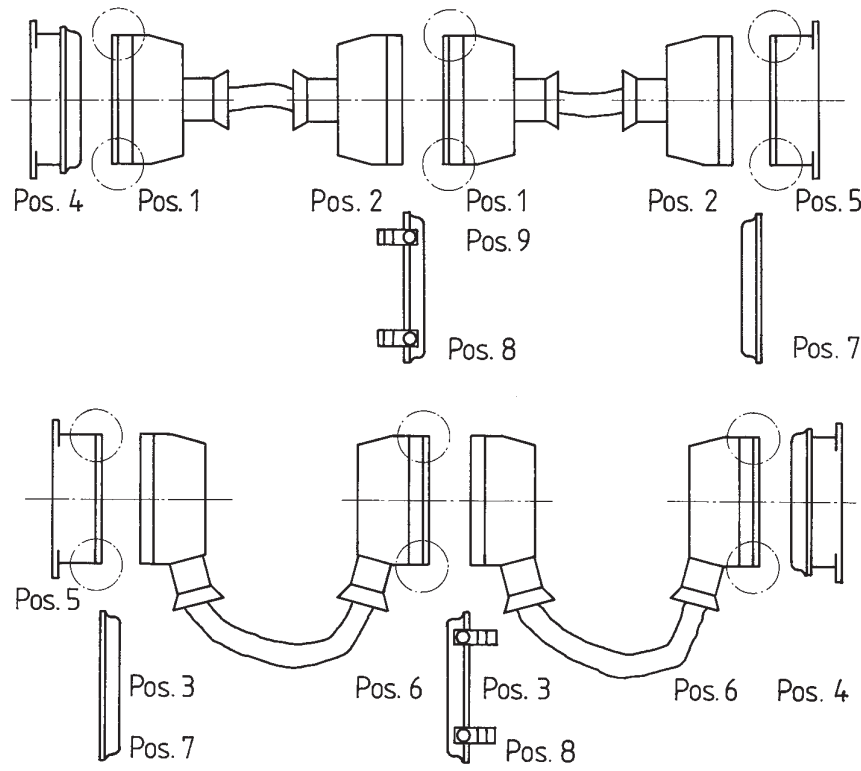

Mounting examples

revos

Hood with strain relief without locking levers

Pos. 3



Open-bottom housing with protective cover gasket in the cover

Pos. 4



Open-bottom housing with locking levers, with gasket

Pos. 5



Hood with strain relief with locking levers and gasket

Pos. 6



Hood with Pg thread only, with locking levers, with gasket

Pos. 9
(do not combine with pos. 4)



Hood with Pg thread only, without locking levers

Pos. 2



Part no.	Part no.	Part no.	Part no.	Part no.	Part no.
70.360.0628.9	99.700.3329.7	70.320.0628.9	99.710.3329.7	70.372.0628.7	70.352.0628.7
70.363.0628.9	99.700.3329.7	70.320.0628.9	99.711.3329.7	-	70.354.0628.7
70.360.1028.9	99.706.3329.7	70.320.1028.9	99.713.3329.7	70.372.1028.7	70.352.1028.7
70.363.1028.9	99.706.3329.7	70.320.1028.9	-	-	70.354.1028.7
70.360.1628.9	99.702.3329.7	70.320.1628.9	99.713.3329.7	70.372.1628.7	70.352.1628.7
70.363.1628.9	99.702.3329.7	70.320.1628.9	-	-	70.354.1628.7
70.360.2428.9	99.704.3329.7	70.320.2428.9	99.716.3329.7	70.372.2428.7	70.352.2428.7
70.360.4828.9		70.320.4828.9		70.372.4828.7	70.352.4828.7

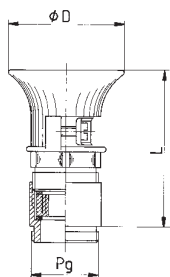

Strain relief screw with locking ring

Part no.	Cable entry sizes		ϕD
	L	Pg	
Z5.509.0529.0	44.6	13.5	35
Z5.508.8129.0	56.6	16	35
Z5.508.8229.0	63.1	21	35
Z5.508.8329.0	66.6	29	35
Z5.509.0829.0	89.6	36	81

Industrial multipole connectors

Accessories

revos



For hoods with cable glands or flared cable entries and strain reliefs we provide locking rings in the size of the various cable entries to lock the pressure screw.



Locking ring

After the pressure screw is tightened, the locking ring is slid over the hexagon head of the pressure screw and is fixed to the compression gland by means of a pan head screw. The pressure screw is now protected against accidental loosening.



If several connectors of the same pole configuration have to be mounted adjacent to each other, coding fixtures prevent them from being mismatched. Only matching female and male parts can be connected. (4 coding options). Coding pins enable six unique combinations.

Coding fixtures in combination with special coding pins provide 24 codings according to the following plan (part no. **Z5.593.4053**): (not applicable for the versions 72.3 and 72.7)



For part no. see page 788

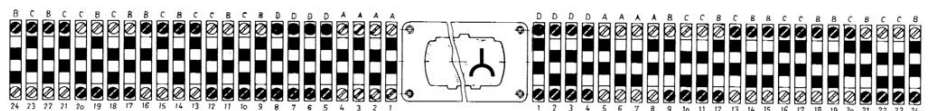
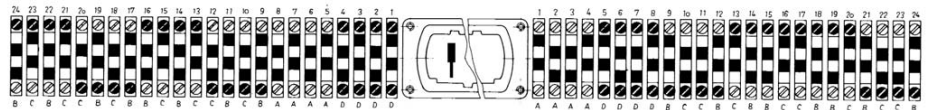
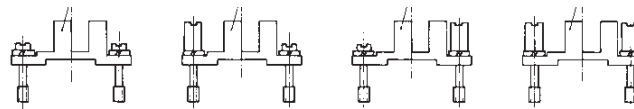

revos

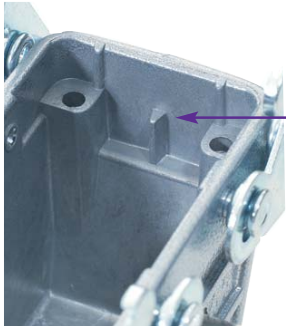

Coding

The hoods and housings for 400 V inserts are coded, so that the female and male inserts for the series of 690/400 V and 690 V cannot be mounted to them.

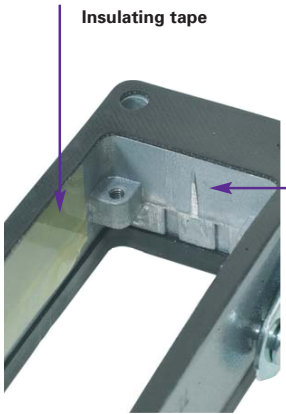

Insulating tape

Coding removed

The coding ribs of the hoods and housings of series 690/400 V and 690 V were removed. Additionally, two insulating tapes are attached inside these hoods and housings.



Coding angle

The female and male inserts of series 690/400 V and 690 V are equipped with coding angles. They prevent that the female and male inserts of this series are mounted to the hoods and housings for 400 V.

The 3pole, 6pole and 10pole inserts of series 690/400 V have a coding fixture which prevents that they are plugged together with 400 V male inserts.



Insulated jumper bar for multipole adapters (see page 781)



Marking tag carrier with 6 digits for open-bottom housings (see page 790) (without marking tags)

Accessories for multipole connectors and multipole adapters

Metric cable threads

revos

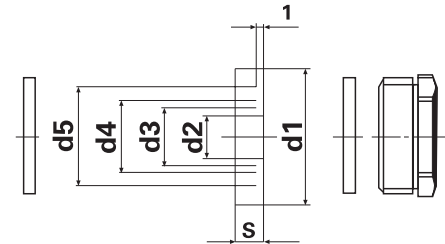

Cable gland nickel-plated brass, with circular compression gland, IP 54 degree of protection

Metric thread	d1	d2	>Øk in mm	d3	>Øk in mm	d4	>Øk in mm	d5	>Øk in mm	Part no.	Stand. pack
M 16	13.8	3	2.0 – 4.5	6	5.0 – 7.5	9	8.0 – 10.5	–	–	Z5.507.2121.0	10
M 20	17.6	4	3.0 – 5.5	7	6.0 – 8.5	10	9.0 – 11.5	13	12.0 – 14.5	Z5.507.2221.0	10
M 25	22.6	8.5	7.5 – 10.0	11.5	10.5 – 13.0	14.5	13.5 – 16.0	17.5	16.5 – 19.0	Z5.507.2321.0	10
M 32	29.6	16	15.0 – 17.5	19	18.0 – 20.5	22	21.0 – 23.5	25	24.0 – 26.5	Z5.507.2421.0	10



Cable gland nickel-plated brass, with internal strain relief and gasket on the connection thread IP 68 degree of protection

Metric thread	>Øk in mm	⌀ mm	Thread length in mm	Part no.	Stand. pack
M 20 x 1.5	8.0 – 13.0	22	6	Z5.507.1321.0	10
M 25 x 1.5	11.0 – 18.0	27	7	Z5.507.1521.0	10
M 32 x 1.5	15.0 – 21.0	34	8	Z5.507.1721.0	10
M 40 x 1.5	19.0 – 27.0	44	8	Z5.507.1921.0	10

Hoods and housings with a cable gland from brass and IP 68 degree of protection can be preassembled upon request and for minimum order quantities of 50 pieces.



Plastic cable gland Polyamide, gray (RAL 7035), with strain relief IP 68 degree of protection

Metric thread	>Øk in mm	⌀ mm	Thread length in mm	Part no.	Stand. pack
M 20 x 1.5	6.0 – 12.0	24	9	Z5.507.1353.0	10
M 25 x 1.5	7.0 – 16.0	28	11	Z5.507.1553.0	10
M 32 x 1.5	10.0 – 21.0	36	11	Z5.507.1753.0	10
M 40 x 1.5	16.0 – 28.0	46	11	Z5.507.1953.0	10

For the use of plastic glands, the housings of size 6 must have a compression gland.

revos



Cable gland nickel-plated brass, with hexagon port on the compression gland, pressure screw with strain relief and protection against bending, IP54 degree of protection

Metric thread	$\text{>}\varnothing\text{K}$ in mm	\varnothing gland mm	Thread length in mm	Part no.	Stand. pack
M 16 x 1.5	6.0 – 9.0	18	5	Z5.507.9521.0	10
M 20 x 1.5	9.0 – 13.5	22	6	Z5.507.9621.0	10
M 25 x 1.5	14.0 – 20.0	30	7	Z5.507.9721.0	10
M 32 x 1.5	19.0 – 29.0	39	8	Z5.507.9821.0	10



EMC cable gland nickel-plated brass, for shielded cables, with internal strain relief, consistently insulated by a gasket on the connection thread, IP 68 degree of protection

Metric thread	$\text{>}\varnothing\text{K}$ in mm	\varnothing mm	Thread length in mm	Part no.	Stand. pack
M 20 x 1.5	8.0 – 13.0	22	6	Z5.507.4821.0	10
M 25 x 1.5	11.0 – 18.0	30	7	Z5.507.5021.0	10
M 32 x 1.5	15.0 – 21.0	34	8	Z5.507.5221.0	10



Cable gland nickel-plated brass, with hexagon port on the compression gland, pressure screw with centric strain relief and protection against bending, with universal gasket

Metric thread	$\text{>}\varnothing\text{K}$ in mm	\varnothing mm	Thread length in mm	Part no.	Stand. pack
M 20 x 1.5	8.5 – 14.0	24	6	Z5.507.5821.0	10
M 25 x 1.5	12.0 – 20.0	34	7	Z5.507.6021.0	10
M 32 x 1.5	18.0 – 28.0	42	8	Z5.507.6221.0	10
M 40 x 1.5	24.0 – 34.0	52	8	Z5.507.6421.0	10

Hoods and housings with a cable gland from brass and IP 68 degree of protection can be preassembled upon request and for minimum order quantities of 50 pieces.

Accessories for multipole connectors and multipole adapters

revos

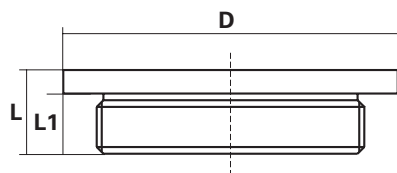

Reduction piece, nickel-plated brass

External thread	Internal thread	D	L1	L	Part no.	Stand. pack
M 20 x 1.5	M 16 x 1.5	22	6	9	05.507.9021.0	10
M 25 x 1.5	M 20 x 1.5	27	7	10	05.507.9121.0	10
M 32 x 1.5	M 25 x 1.5	34	8	11	05.507.9221.0	10
M 40 x 1.5	M 32 x 1.5	43	8	11.5	05.507.9321.0	10

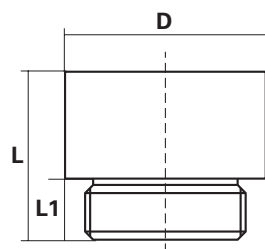

Extension piece, nickel-plated brass

External thread	Internal thread	D	L1	L	Part no.	Stand. pack
M 16 x 1.5	M 20 x 1.5	22	5	17,5	05.507.8621.0	10
M 20 x 1.5	M 25 x 1.5	27	6	20	05.507.8721.0	10
M 25 x 1.5	M 32 x 1.5	34	7	22,5	05.507.8821.0	10
M 32 x 1.5	M 40 x 1.5	42	8	24,5	05.507.8921.0	10

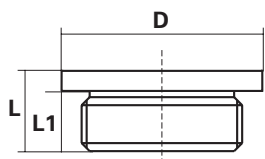

Adapter for PG-metric conversion, nickel-plated brass

External thread	Internal thread	D	L1	L	Part no.	Stand. pack
Pg 13.5	M 20 x 1.5	26	6.5	19	05.507.7621.0	10
Pg 16	M 20 x 1.5	24	6.5	9.5	05.507.7721.0	10
Pg 21	M 25 x 1.5	30	7	10	05.507.7821.0	10

revos

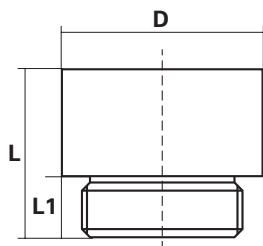

Adapter for metric-PG conversion, nickel-plated brass

External thread	Internal thread	D	L1	L	Part no.	Stand. pack
M 20 x 1.5	Pg 13.5	22	6	18.5	05.507.8121.0	10
M 20 x 1.5	Pg 16	24	6	19.5	05.507.8221.0	10
M 25 x 1.5	Pg 21	30	7	22	05.507.8321.0	10
M 32 x 1.5	Pg 29	39	8	24.5	05.507.8421.0	10

Adapter metric – NPT: Electroless nickel-plated aluminium

M 20 x 1.5 – 1/2" NPT	24	7	25	M20N02MA	10
M 20 x 1.5 – 3/4" NPT	30	7	25	M20N04MA	10
M 25 x 1.5 – 1/2" NPT	27	7	21	M25N02MA	10
M 25 x 1.5 – 3/4" NPT	30	7	25	M25N04MA	10
M 25 x 1.5 – 1" NPT	36	7	26.5	M25N06MA	10
M 32 x 1.5 – 1" NPT	36	7	26.5	M32N06MA	10

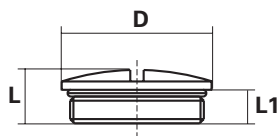

Blind piece,

metric, nickel-plated brass, with gasket from Perbunan

Metric thread	D	L1	L	Part no.	Stand. pack
M 20 x 1.5	22	6.5	9.5	05.507.4021.0	10
M 25 x 1.5	28	7	11	05.507.4121.0	10
M 32 x 1.5	35	8	12	05.507.4221.0	10
M 40 x 1.5	44	8.5	13	05.507.4321.0	10

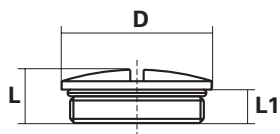

Blind piece,







metric, fibreglass reinforced Polyamide, gray

Metric thread	D	L1	L	Part no.	Stand. pack
M 20 x 1.5	24	6	9	05.507.4053.0	10
M 25 x 1.5	30	7	10.5	05.507.4153.0	10
M 32 x 1.5	38	8	12	05.507.4253.0	10
M 40 x 1.5	48	9	13	05.507.4353.0	10



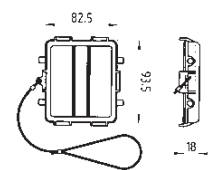

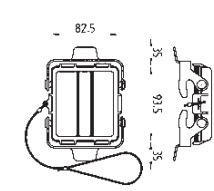
Accessories for multipole connectors and multipole adapters

Protective covers

revos

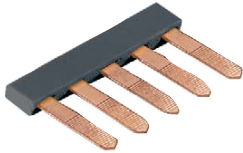
	for the housings	73.3xx.xxxx.x	70.3xx.xxxx.x	72.3xx.xxxx.x	Part no.	Stand. pack			
 <p>Protective Polyamide covers for hoods and housings with locking levers</p>		40pole	6pole 10pole 16pole 24pole	6pole 10pole 16pole 24pole	07.409.7056.0 07.409.7156.0 07.409.7256.0 07.409.7356.0	10 10 10 10			
	with tether cord	40pole 64pole	16pole 24pole	16pole 24pole	Z7.409.8856.0 Z7.409.8956.0	10			
	with tether cord and loop	40pole 64pole	10pole 16pole 24pole	10pole 16pole 24pole	Z7.416.1656.0 Z7.416.1756.0 Z7.416.1856.0	10 10 10			
	 <p>Protective cover from Polyamide with catch spring from spring steel, galvanically tin-plated for hoods and housings without locking lever</p>		40pole 64pole	6pole 10pole 16pole 24pole	6pole 10pole 16pole 24pole	Z7.409.7056.0 Z7.409.7156.0 Z7.409.7256.0 Z7.409.7356.0	10 10 10 10		
		 <p>Protective cover for 32pole housing</p>					32pole	Z7.419.6228.0	10
									
 <p>Protective cover for 32pole housing with locking lever</p>							32pole	Z7.419.6128.0	10
									
 <p>Cover with lockingbolts for housings and hoods with locking levers for revos MINI with gaskets for female inserts</p>					Plastic Metal		07.417.6853.0 07.417.6829.0		
	 <p>Cover with lockingbolts for housings and hoods with locking levers for revos MINI without gaskets for female inserts</p>					Plastic Metal	07.417.6753.0 07.417.6729.0		

revos

	Number of poles	Part no.	Stand. pack
 <p>Insulated jumper bar for multipole adapters of series xx.xxx.xxxx.3 and xx.xxx.xxxx.4</p>	2pole	Z7.256.0227.0	10
	3pole	Z7.256.0327.0	10
	4pole	Z7.256.0427.0	10
	5pole	Z7.256.0527.0	10
	6pole	Z7.256.0627.0	10
	7pole	Z7.256.0727.0	10
	8pole	Z7.256.0827.0	10
	9pole	Z7.256.0927.0	10
	10pole	Z7.256.1027.0	10
	11pole	Z7.256.1127.0	10
	12pole	Z7.256.1227.0	10
	 <p>Insulated jumper bar for high-density multipole adapters</p>	2pole	Z7.258.1225.0
3pole		Z7.258.1325.0	10
4pole		Z7.258.1425.0	10
5pole		Z7.258.1525.0	10
6pole		Z7.258.1625.0	10
7pole		Z7.258.1725.0	10
8pole		Z7.258.1825.0	10
9pole		Z7.258.1925.0	10
10pole		Z7.258.2025.0	10
 <p>Marking tag carrier for housings with 6 digits (without marking tags)</p>			04.242.4453.0
 <p>Marking tag carrier complete with carrier (without marking tags)</p>	40pole	Z4.242.3753.0	10
	64pole	Z4.242.4053.0	10
 <p>Marking tag carrier for hoods (without marking tags) to be driven in with a rubber mallet into the space on top of the hood</p>		04.242.3853.0	10





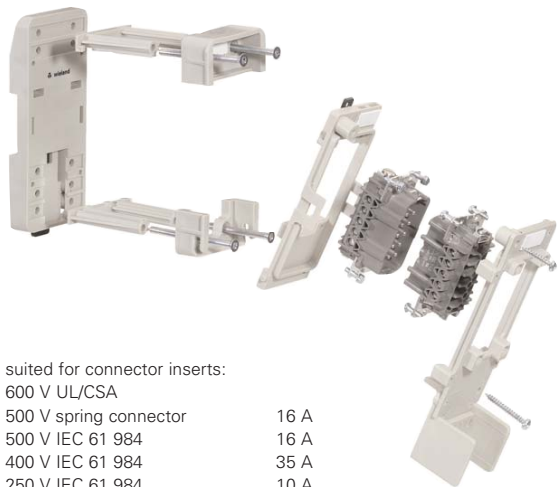

Accessories

Mounting frames for connector inserts

revos



suitable for connector inserts:
 600 V UL/CSA
 500 V spring connector 16 A
 500 V IEC 61 984 16 A
 400 V IEC 61 984 35 A
 250 V IEC 61 984 10 A

		Length	Part no.	Stand. pack
	Size 6 Mounting frame with strain relief	125	Z5.574.0653.0	1
	Size 10 Mounting frame with strain relief	125	Z5.574.1053.0	1
	Size 16 Mounting frame with strain relief	125	Z5.574.1653.0	1
	Size 24 Mounting frame with strain relief	150	Z5.574.2453.0	1
	Size 2 x 6 Mounting frame with strain relief	150	Z5.574.1253.0	1
	Sizes 6/10/16 Size 24 Mounting frame with base plate and fixing bolts for open-bottom housings	125	Z5.574.0053.0 Z5.574.0153.0	1 1

revos

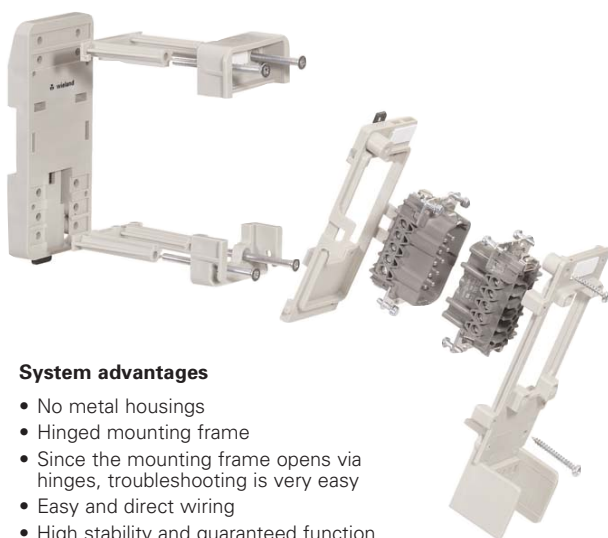

System advantages

- No metal housings
- Hinged mounting frame
- Since the mounting frame opens via hinges, troubleshooting is very easy
- Easy and direct wiring
- High stability and guaranteed function
- Degree of protection provided by the control cabinet
- Rewiring without disconnecting

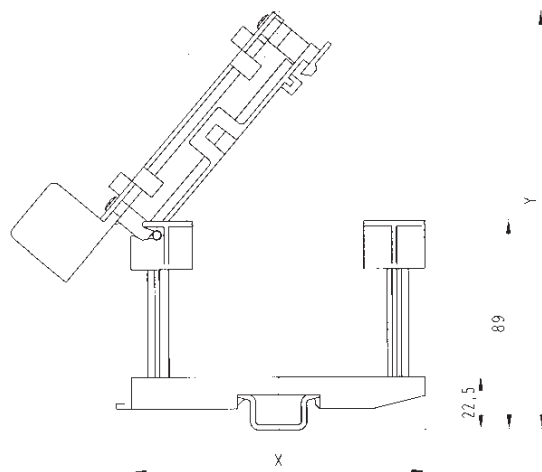

- Mounts to rail 35 x 15
- Swivels by 80° when connected
- Swivels by 120° when disconnected

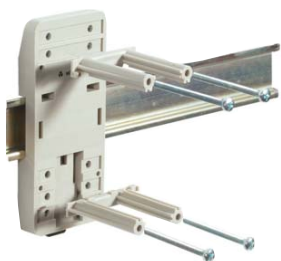

Mounting frame with base plate and fixing bolts for open housings

Accessories for multipole connectors and multipole adapters

Cover plates and reduction plates



	Housing size	Number of poles	Part no.	Stand. pack
Cover plates	6		07.416.6853.0	10
	10		07.416.6953.0	10
	16		07.416.7053.0	10
	24		07.416.7153.0	10
				
<p>Cover plates to close prefabricated cut-outs in bulkhead walls of control cabinets</p> <p>Material Polyamide, fiberglass reinforced Color RAL 7032 Degr. of prot. IP 65</p>				
Reduction plates		24/ 6	07.416.6353.0	10
		24/10	07.416.6453.0	10
		24/16	07.416.6553.0	10
				
<p>Reduction plates to reduce prefabricated cut-outs of size 24 in bulkhead walls of control cabinets</p> <p>Material Polyamide, fiberglass reinforced Color RAL 7032 Degree of prot. IP 65</p>				

Definition for multipole adapters Ground connection

revos

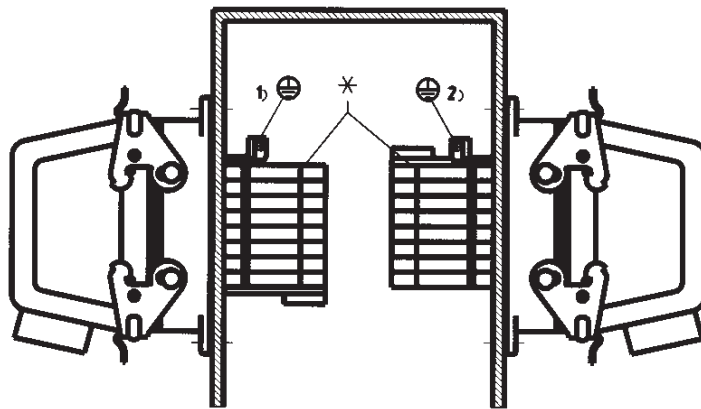

- * Start of the markings 1 through
- 1 Multipole adapter in the version: ground connection left
- 2 Multipole adapter in the version: ground connection right

Coding options with coding pins

revos

The coding pins of version A can be used for:

- Screw inserts with part no.:
 - 70.2XX.XXXX.X
 - 70.3XX.XXXX.X
 - 70.4XX.XXXX.X
 - 72.2XX.XXXX.X
 - 72.3XX.XXXX.X

- Crimping inserts with part no.:
 - 70.7XX.XXXX.X
 - 72.7XX.XXXX.X
 - 73.7XX.XXXX.X

- Spring clamp inserts with part no.:
 - 70.5XX.XXXX.X

- Multipole adapters (mounting to the front) with part no.:
 - 70.0XX.XXXX.X
 - 70.1XX.XXXX.X
 - 72.0XX.XXXX.X
 - 72.1XX.XXXX.X
 - 73.9XX.XXXX.X

Codings are possible even for combinations of screw and crimping inserts, and multipole adapters.

The coding pins of version B can be used for:

- Combinations of screw, crimping and spring clamp inserts, and multipole adapters, combined with multipole adapters (mounting to the rear of the housings) with part no.:
 - 70.9XX.XXXX.X
 - 72.9XX.XXXX.X
 - 73.1XX.XXXX.X

1) Six coding options with coding pins

Coding pins

Order no. for version A: 05.592.0621.0 100
05.513.4212.0 100

The use of coding pins enables six combinations for 3pole, 6pole, 10pole, 16pole and 24pole multipole connectors

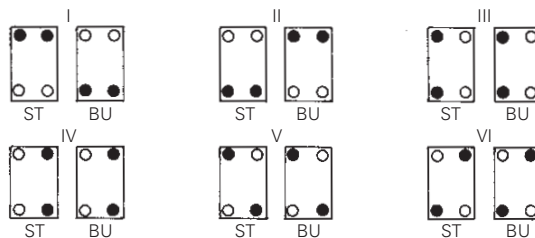

and six combinations for 20, 26, 32 and 48pole multipole connectors

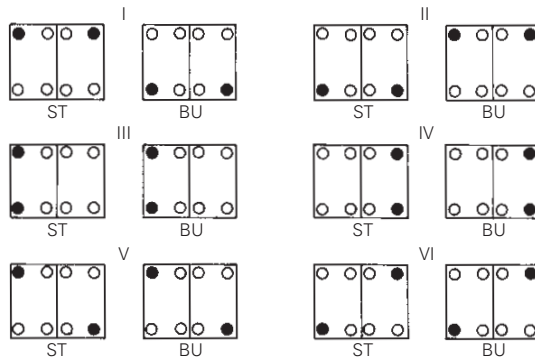



● Coding pins
○ Fixing screws

ST = male connector part
BU = female connector part



revos

2) 72) Coding options with coding pins

Part no. for version **A**:

	● Coding bolts	05.576.6912.0*
	• Coding pin	05.576.6612.0*
	◉ Female coding piece	05.576.6712.0*

Part no. for version **B**:

	● Coding bolts	05.576.8512.0
	• Coding pin	05.576.8312.0
	◉ Female coding piece	05.576.8412.0

*) for 15pole or 25pole connectors of series 73.7... we provide only 16 different codings, as the coding bolts cannot be used.

Coding

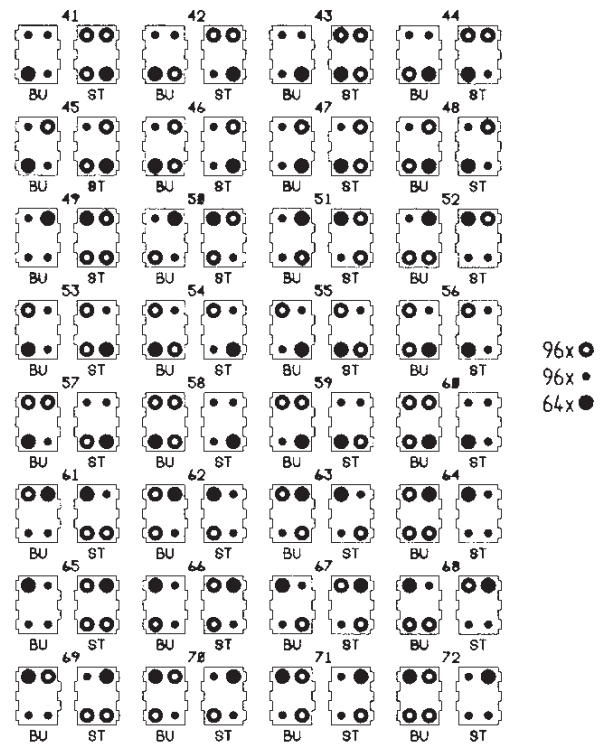
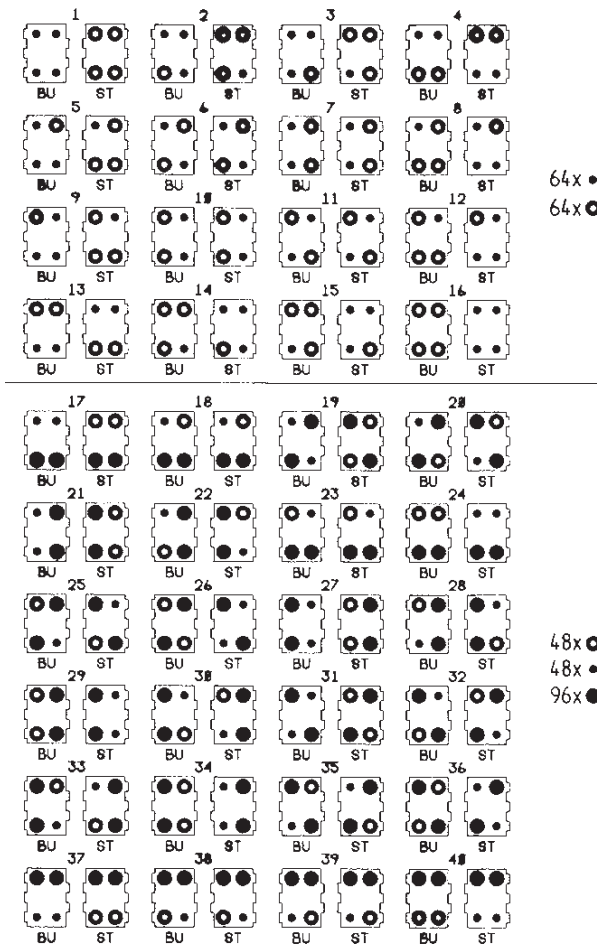

not pluggable

pluggable

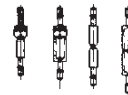

Accessories for multipole connectors and multipole adapters

Coding options with coding pieces

revos

Part no. Stand. pack

Coding with coding pieces for:

- Screw inserts with part no.: 70.3xx.xxxx.x und 70.4xx.xxxx.x
- Crimping inserts with part no.: 70.7xx.xxxx.x
- Multipole adapters (mounting to the front) with part no.: 70.1xx.xxxx.x

Codings are possible even for combinations of screw and crimping inserts, and multipole adapters.

1. Diagram for 4 codings with coding pieces

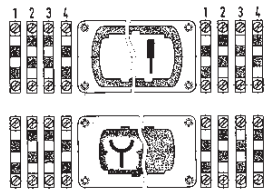

2. Diagram for 24 codings with coding pieces

16 25 593 3653 25 593 3763 25 593 3853 25 593 3953

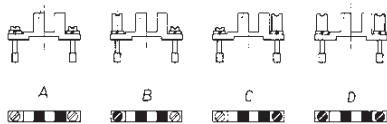

Material Coding pieces from Polyamide
 Fixing screws Steel, galvanically zinc-plated and dichromated



Z5.592.1252.0 50

When the coding pieces are attached to the connectors in a special order, you will get four different combinations, and only the matching inserts or multipole adapters can be connected.

Z5.593.4053.0 1

Coding pieces and special coding pins for 24 different codings

revos

Coding pieces and special coding pins for 24 different codings

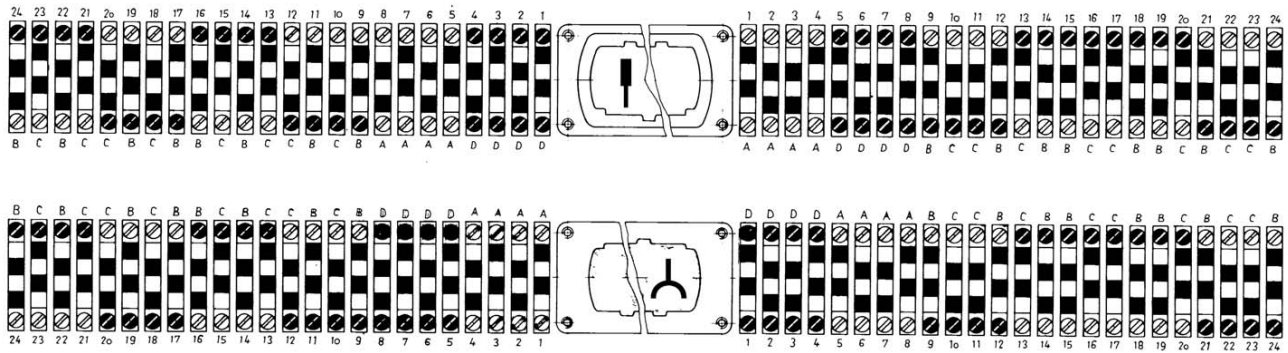

Accessories for multipole connectors and multipole adapters

Tear-off marking strips / marking tags

revos



Material: Polyamide 66/6 white, marking in black Marking per strip	Type	Part no.	Stand. pack
unmarked	9704 A	04.241.1150.0	25
marked with the same number	1 1 1 1 1 1 1 1 1 1	9704 A/1 B	04.841.1150.0 25
	2 2 2 2 2 2 2 2 2 2	9704 A/2 B	04.841.1250.0 25
	3 3 3 3 3 3 3 3 3 3	9704 A/3 B	04.841.1350.0 25
	4 4 4 4 4 4 4 4 4 4	9704 A/4 B	04.841.1450.0 25
	5 5 5 5 5 5 5 5 5 5	9704 A/5 B	04.841.1550.0 25
	6 6 6 6 6 6 6 6 6 6	9704 A/6 B	04.841.1650.0 25
	7 7 7 7 7 7 7 7 7 7	9704 A/7 B	04.841.1750.0 25
	8 8 8 8 8 8 8 8 8 8	9704 A/8 B	04.841.1850.0 25
	9 9 9 9 9 9 9 9 9 9	9704 A/9 B	04.841.1950.0 25
	0 0 0 0 0 0 0 0 0 0	9704 A/0 B	04.841.2050.0 25
	marked with consecutive numbers	9704 A/1-0 B	04.841.2150.0
marked with the same capital letters	A A A A A A A A A A	9704 A/AG B	04.841.2250.0 25
	B B B B B B B B B B	9704 A/BG B	04.841.2350.0 25
	C C C C C C C C C C	9704 A/CG B	04.841.2450.0 25
	D D D D D D D D D D	9704 A/DG B	04.841.2550.0 25
	E E E E E E E E E E	9704 A/EG B	04.841.2650.0 25
	F F F F F F F F F F	9704 A/FG B	04.841.2750.0 25
	G G G G G G G G G G	9704 A/GG B	04.841.2850.0 25
	H H H H H H H H H H	9704 A/HG B	04.841.2950.0 25
	I I I I I I I I I I	9704 A/IG B	04.841.3050.0 25
	J J J J J J J J J J	9704 A/JG B	04.841.3150.0 25
	K K K K K K K K K K	9704 A/KG B	04.841.3250.0 25
	L L L L L L L L L L	9704 A/LG B	04.841.3350.0 25
	M M M M M M M M M M	9704 A/MG B	04.841.3450.0 25
	N N N N N N N N N N	9704 A/NG B	04.841.3550.0 25
	O O O O O O O O O O	9704 A/OG B	04.841.3650.0 25
	P P P P P P P P P P	9704 A/PG B	04.841.3750.0 25
	Q Q Q Q Q Q Q Q Q Q	9704 A/QG B	04.841.3850.0 25
	R R R R R R R R R R	9704 A/RG B	04.841.3950.0 25
	S S S S S S S S S S	9704 A/SG B	04.841.4050.0 25
	T T T T T T T T T T	9704 A/TG B	04.841.4150.0 25
	U U U U U U U U U U	9704 A/UG B	04.841.4250.0 25
	V V V V V V V V V V	9704 A/VG B	04.841.4350.0 25
	W W W W W W W W W W	9704 A/WG B	04.841.4450.0 25
	X X X X X X X X X X	9704 A/XG B	04.841.4550.0 25
	Y Y Y Y Y Y Y Y Y Y	9704 A/YG B	04.841.4650.0 25
	Z Z Z Z Z Z Z Z Z Z	9704 A/ZG B	04.841.4750.0 25
marked with the same small letters	a a a a a a a a a a	9704 A/AK B	04.841.4850.0 25
	b b b b b b b b b b	9704 A/BK B	04.841.4950.0 25
	c c c c c c c c c c	9704 A/CK B	04.841.5050.0 25
	d d d d d d d d d d	9704 A/DK B	04.841.5150.0 25
	e e e e e e e e e e	9704 A/EK B	04.841.5250.0 25
	f f f f f f f f f f	9704 A/FK B	04.841.5350.0 25
	g g g g g g g g g g	9704 A/GK B	04.841.5450.0 25
	h h h h h h h h h h	9704 A/HK B	04.841.5550.0 25
	i i i i i i i i i i	9704 A/IK B	04.841.5650.0 25
	j j j j j j j j j j	9704 A/JK B	04.841.5750.0 25
	k k k k k k k k k k	9704 A/KK B	04.841.5850.0 25
	l l l l l l l l l l	9704 A/LK B	04.841.5950.0 25
	m m m m m m m m m m	9704 A/MK B	04.841.6050.0 25
	n n n n n n n n n n	9704 A/NK B	04.841.6150.0 25
	o o o o o o o o o o	9704 A/OK B	04.841.6250.0 25
	p p p p p p p p p p	9704 A/PK B	04.841.6350.0 25
	q q q q q q q q q q	9704 A/QK B	04.841.6450.0 25
	r r r r r r r r r r	9704 A/RK B	04.841.6550.0 25
	s s s s s s s s s s	9704 A/SK B	04.841.6650.0 25
	t t t t t t t t t t	9704 A/TK B	04.841.6750.0 25
	u u u u u u u u u u	9704 A/UK B	04.841.6850.0 25
	v v v v v v v v v v	9704 A/VK B	04.841.6950.0 25
	w w w w w w w w w w	9704 A/WK B	04.841.7050.0 25
	x x x x x x x x x x	9704 A/XK B	04.841.7150.0 25
	y y y y y y y y y y	9704 A/YK B	04.841.7250.0 25
	z z z z z z z z z z	9704 A/ZK B	04.841.7350.0 25
marked with the same symbols	+ + + + + + + + + +	9704 A/+ B	04.841.7450.0 25
	- - - - - - - - - -	9704 A/- B	04.841.7550.0 25
	/ / / / / / / / / /	9704 A// B	04.841.7650.0 25
	9704 A/. B	04.841.7750.0 25
1 set of the same numbers = 10 x 25 strips = 2500 numbers	1 1 1 ... 0 0 0	111 bis 000	04.841.9050.0 1
1 set of cap. letters = 26 x 25 strips = 6500 letters	A A A ... Z Z Z	A bis Z GB	04.841.9150.0 1
1 set of small letters = 26 x 25 strips = 6500 letters	a a a ... z z z	a bis z KB	04.841.9250.0 1

revos

Tools

facts & DATA

Technical explanations on:

Ferrules

Tools

Standards and certifications

facts structured in three main sections for:

- important accessories
- technical documentation and basic information in tables
- important standards and certifications

All Wieland Components which require CE general certification are CE certified, and identified with the CE logo.



Technical Explanations
Tools
Approvals

facts & DATA

Preparation of conductor ends

**Electric Automated
crimping machine**

Technical explanations

Approvals

CONTENTS

facts & DATA

	<ul style="list-style-type: none">• Ferrules according to DIN 46 228 p1 through p4 Page 796• Ferrules Page 797• Tools Page 798<ul style="list-style-type: none">– Crimp contact kit Page 798– Crimping dies and contact positioners Page 798– Crimping tools for ferrules Page 798– Stripping tool, screwdrivers Page 799
	<ul style="list-style-type: none">• Crimping machine Page 800• Disposable magazines with female and male contacts for industrial multipole connectors Page 801
	<ul style="list-style-type: none">• Types of mounting rails Page 802• Tables, technical information, explanations Page 804• DIN rail terminal blocks for increased safety (Ex terminal blocks) Page 824
	<ul style="list-style-type: none">• Approvals Page 834

Ferrules

facts & DATA

Ferrules with insulating sleeves for 0.5 to 25 mm² conductors

Materials:

Sleeve:
 – Polypropylene,
 temperature resistant
 up to 105 °C,
 tracking resistant

Tube:

E-Cu, galvanically tin-plated

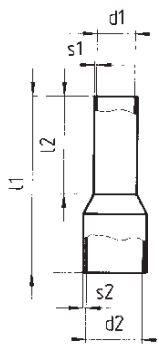

Cross section mm ² /AWG	Color	Part no.	Std. pack	s ₂	d ₂	l ₁	l ₂	d ₁	s ₁	
accord. to DIN 46 228 T4										
0.50/20	norm.	white	06.600.2027.0	100	0.25	2.6	14	8	1.0	0.15
0.75/18	norm.	gray	06.600.2127.0	100	0.25	2.8	14	8	1.2	0.15
1.00/18	norm.	red	06.600.2227.0	100	0.25	3.0	14	8	1.4	0.15
1.50/16	norm.	black	06.600.2327.0	100	0.25	3.5	14	8	1.7	0.15
1.50/16	long	black	06.600.2427.0	100	0.25	3.5	24	18	1.7	0.15
2.50/14	norm.	blue	06.600.2527.0	100	0.25	4.2	14	8	2.2	0.15
2.50/14	long	blue	06.600.2627.0	100	0.25	4.2	24	18	2.2	0.15
4.00/12	norm.	gray	06.600.2727.0	100	0.30	4.8	17	10	2.8	0.20
4.00/12	long	gray	06.600.2827.0	100	0.30	4.8	26	18	2.8	0.20
6.00/10	norm.	yellow	06.600.2927.0	100	0.30	6.3	20	12	3.5	0.20
6.00/10	long	yellow	06.600.3027.0	100	0.30	6.3	26	18	3.5	0.20
10.00/8	norm.	red	06.600.3127.0	100	0.40	7.6	22	12	4.5	0.20
10.00/8	long	red	06.600.3227.0	100	0.40	7.6	28	18	4.5	0.20
16.00/6	norm.	blue	06.600.3327.0	100	0.40	8.8	24	12	5.8	0.20
16.00/6	long	blue	06.600.3427.0	100	0.40	8.8	28	18	5.8	0.20
25.00/4	half long	yellow	06.600.3527.0	50	0.40	11.2	30	18	7.3	0.20

Ferrules without insulating sleeves for 0.5 to 16 mm² conductors

Material: E-Cu, galvanically tin-plated

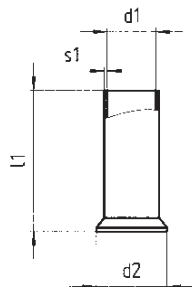

accord. to DIN 46 228 T1

0.50/20	norm.	06.600.4027.0	1000	2.1	6	1.0	0.15
0.75/18	norm.	06.600.4127.0	1000	2.3	6	1.2	0.15
1.00/18	norm.	06.600.4227.0	1000	2.5	6	1.4	0.15
1.50/16	norm.	06.600.4327.0	1000	2.8	7	1.7	0.15
2.50/14	norm.	06.600.4427.0	1000	3.4	7	2.2	0.15
4.00/12	norm.	06.600.4527.0	1000	4.0	9	2.8	0.20
6.00/10	norm.	06.600.4627.0	500	4.7	10	3.5	0.20
10.00/8	norm.	06.600.4727.0	500	5.8	12	4.5	0.20
16.00/6	norm.	06.600.4827.0	100	7.5	12	5.8	0.20
25.00/4	norm.	06.600.4927.0	100	9.5	15	7.3	0.20
35.00/2	norm.	06.600.5027.0	100	11.0	18	8.3	0.20

Ferrules

facts

Ferrules with insulating sleeves

for 0.36 to 25 mm² conductors

Materials:

Sleeve:

- Rilsan, temperature resistant up to 130 °C, tracking resistant

Tube:

E-Cu, galvanically tin-plated



Cross section mm ² /AWG	Color	Part no.	Std. pack	s ₂	d ₂	l ₁	l ₂	d ₁	s ₁
2.08/16	yellow	05.596.6127.0	1000	0.25	3.7	14.5	8.2	2.0	0.175

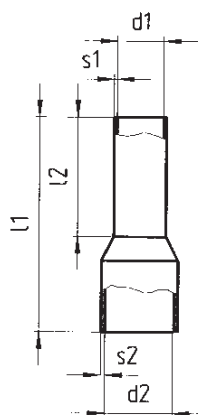

Twin ferrules with insulating sleeves

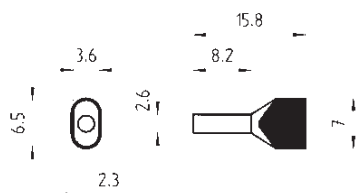

Cross section mm ² /AWG	Type	Part no.	Std. pack
2 x 1.5/16	AEI 1,5 Z-N	05.599.2027.0	500

facts & DATA

facts



Crimping tool

for ferrules
10 – 25 mm²

AWG 7 – 4

Crimping tool

for ferrules
35 – 50 mm²

AWG 2 – 1/0

Stripping tool

0.08 – 10 mm²

AWG 28 – 7

Screwdriver

Part no.	Std. pack	Part no.	Std. pack	Part no.	Std. pack	Part no.	Std. pack
total length: 203 mm 95.101.1100.0	1	total length: 203 mm 95.101.1200.0	1	total length: 197 mm 95.350.0100.0	1	06.502.4000.0	1
<ul style="list-style-type: none"> • parallel crimping • releasable latch • toggle ratio • compression adjustable 		<ul style="list-style-type: none"> • parallel crimping • releasable latch • toggle ratio • compression adjustable 		<ul style="list-style-type: none"> • adjustable length • integrated wire cutter • tool elements made from glass fibre reinforced Polyamide 		<ul style="list-style-type: none"> • blade 0.6 x 3.5 accord. to DIN 5264 B • for WKF DIN rail spring clamp terminal blocks • for WKC DIN rail IDC terminal blocks • for multipole connectors with spring connection • ergonomically shaped handle 	

Automated crimping machine to connect wires to female and male contacts for multipole connectors

facts & DATA

Automatic stripping and crimping machine

This machine enables wire stripping and crimping in one operation.

A sensor registers when a cable is inserted manually. Then the wire is automatically stripped and then crimped – for the user, this means a time-saving operation.

The female and male parts can be fed in on reels (0.75 – 1.5 mm²) or by means of a reusable magazine (for 0.5 – 4 mm² connectors).

The following easily exchangeable tool inserts are available for multi-purpose use of the crimping machine:

- for ST 18 connectors
- for industrial multipole connectors

Dimensions: H 570 mm, W 410 mm, D 510 mm; weight: 85 kg

Power supply: 220 V ~

Part no. **95.000.0005.0**



	Description	for cross sect. in mm ² /AWG	Part no.	Std. pack
for connector versions 70.700 ... 58.0 70.710 ... 58.0 72.700 ... 58.0 72.710 ... 58.0	Disposable magazine with 25 female contacts	0.5 / 20	Z2.123.7000.0	25
		0.75 – 1 / 18	Z2.123.7100.0	25
		1.5 / 16	Z2.123.7200.0	25
		2.5 / 14	Z2.123.7300.0	25
		4* / 12	Z2.123.7400.0	25
	Disposable magazine with 25 male contacts	0.5 / 20	Z5.543.7000.0	25
		0.75 – 1 / 18	Z5.543.7100.0	25
		1.5 / 16	Z5.543.7200.0	25
		2.5 / 14	Z5.543.7300.0	25
		4* / 12	Z5.543.7400.0	25

* not possible with machine!



Disposable magazines with female and male contacts for industrial multipole connectors

facts

Use of tool
when installed

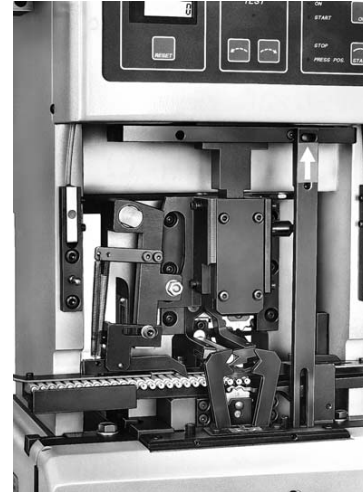

Use of tool with reels,
female and male contacts for:

multiple connectors Part no. **95.000.0007.0**

ST 18 connectors Part no. **95.000.0008.0**

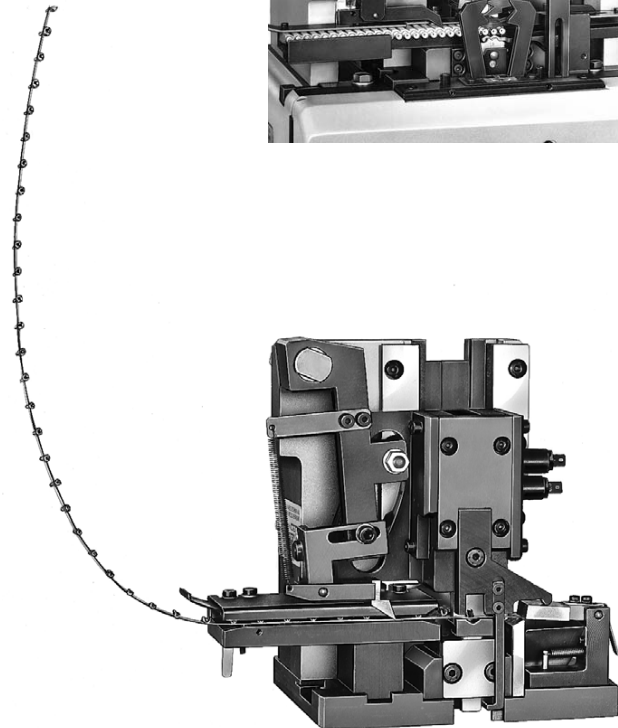

Use of tool for disposable magazines with
female and male contacts
for industrial multipole connectors

Part no. **95.000.0006.0**

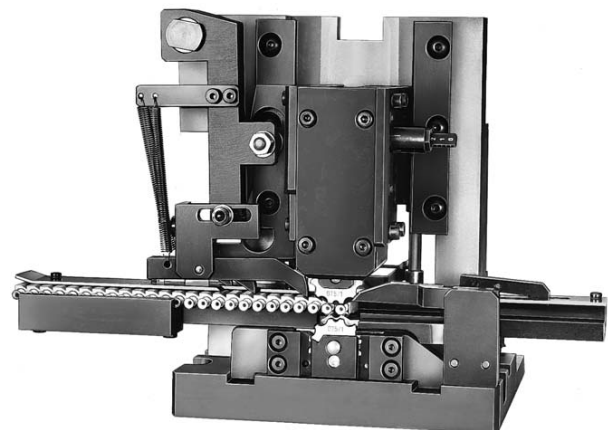

Mounting rails

facts & DATA

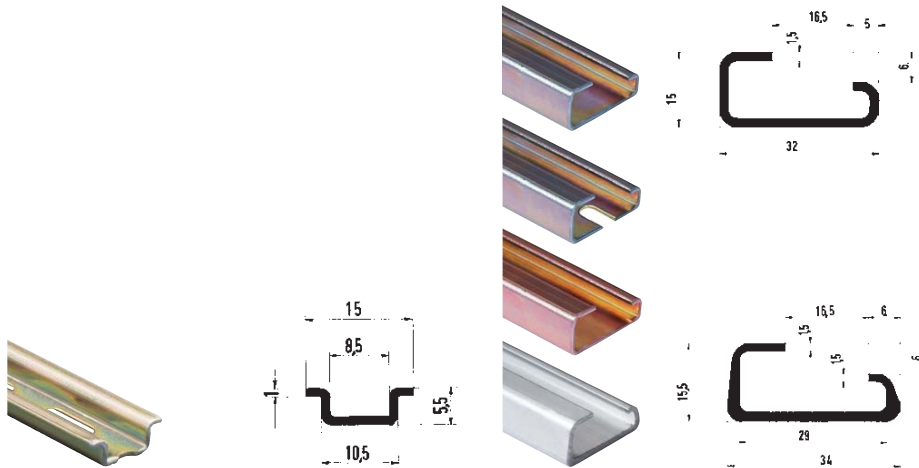

Mounting rail 15

accord. to DIN EN 60715

Mounting rail 32

accord. to DIN EN 60715

Type	Part no.	Std. pack	Type	Part no.	Std. pack		
Length: 1 m	98.090.0000.0	galvan. zinc-plated steel	Length: 2 m				
Length: 2 m	98.090.0015.0	galvan. zinc-plated steel	9006 EN 60715 G-32	98.190.0000.0	galvan. zinc-plated steel		
Length: 3 m	98.095.3000.0	galvan. zinc-plated steel	9006 CU EN 60715 G-32	98.220.0000.0	E-Cu		
			slotted	98.190.1000.0	galvan. zinc-plated steel		
			9006 AL 32	98.210.0000.0	AL		
Mounting rail accord. to DIN EN 60715 - 15 x 5.5 yellow chromated steel, slotted Length: 1 m	9021 15 x 5,5 EN 60715	98.090.0000.0	1	Mounting rail accord. to DIN EN 60715 – G-32 yellow chromated steel, unslotted Length: 2 m	9006 EN 60715 G-32	98.190.0000.0	1
Mounting rail same as above, but 2 m long	9021	98.090.0015.0	10	Mounting rail same as above, but slotted Length: 2 m	9006 slotted	98.190.1000.0	1
				Mounting rail similar to DIN EN 60715 – G-32, made from aluminum, unslotted Length: 2 m	9006 AL 32	98.210.0000.0	1
				Mounting rail similar to DIN EN 60715 – G-32, made from copper, unslotted Length: 2 m	9006 CU EN 60715 G-32	98.220.0000.0	10

facts

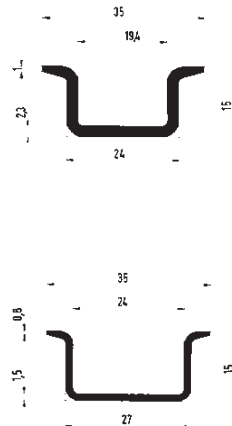
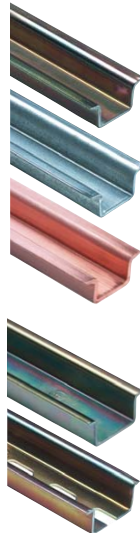
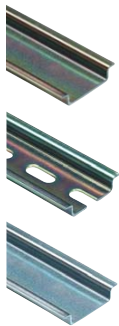

Mounting rail 35x7.5

accord. to DIN EN 60715

Mounting rail 35 x 15

accord. to DIN EN 60715

Type	Part no.	Std. pack	Type	Part no.	Std. pack
Length: 2 m			35 x 24 x 15 EN 60715	98.360.0000.0	galvan. zinc-plated steel
			35 x 24 x 15 EN 60715	98.380.0000.0	E-Cu
			similar to DIN EN 60715		
35 x 27 x 7.5	EN 60715	98.300.0000.0	galvan. zinc-plated steel		
35 x 27 x 7.5	1 m	98.305.1000.0	galvan. zinc-plated steel		
35 x 27 x 7.5	slotted	98.300.1000.0	galvan. zinc-plated steel		
Mounting rail accord. to DIN EN 60715 - 35 x 7.5 yellow chromated steel, low version, unslotted Length: 2 m			Mounting rail accord. to DIN EN 60715 - 35 x 15 yellow chromated steel, 2.3 mm thick high version, unslotted Length: 2 m		
	98.300.0000.0	1		98.360.0000.0	1
Mounting rail same as above, but 1 m long			Mounting rail similar to DIN EN 60715 - 35 x 15, yellow chromated steel, 1.5 mm thick high version, unslotted Length: 2 m		
	98.305.1000.0	1		98.370.0000.0	1
Mounting rail same as above, but slotted Length: 2 m			Mounting rail same as above, but slotted Length: 2 m		
	98.300.1000.0	1		98.370.1000.0	1
			Mounting rail same as above, but 1 m long		
				98.375.1000.0	10
			Mounting rail DIN EN 60715 - 35 x 15 copper, 2.3 mm thick, high version, unslotted Length: 2 m		
				98.380.0000.0	10

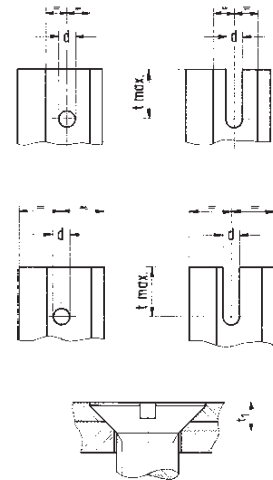

Mounting rails for OEM production

Mounting rails are generally supplied in lengths of 2 m. For OEM production we can supply mounting rails in all desired lengths, already punched with fastening holes as shown in the following table.

Version	Size of the fastening screws					
	M 4		M 5		M 6	
	d	t max	d	t max	d	t max
1	4.5		5.5		6.6	
2	4.5	24	5.5	22	6.6	22
3	4.5		5.5		6.6	
4	4.5	24	5.5	22	6.6	22

Countersunk holes accord. to DIN 75 must be specially indicated. It should be observed that the measuring unit t_1 of countersunk screws M 4 and larger exceeds the material thickness of the mounting rail for the entire countersunk section. For this reason, the fastening base must provide a countersunk section also.

Information on transition from Pg to metric threads

facts & DATA

**Pg threads
are available
upon request!**

1. Basic legal conditions

The European standard EN 50 262 "Metric Cable Glands for Electrical Installation" was ratified on April 01, 1989 by CENELEC (European Committee for Electrotechnical Standardization) and put into force.

A corresponding German standard DIN EN 50 262 published in March 1999 will replace the national standards:
VDE security standard 0619 quoting standards DIN 46 319 and
DIN 46 320, with a transition period until March 01, 2001.

EN 50 262 is valid in all EC countries and countries not belonging to the EC and cooperating in CENELEC will accept the standard.

The main difference in the new EN standard is its character as a security standard. As a building standard it only defines the metric thread and its lead.

2. Effects of the change

The changeover will affect all manufacturers of cable glands, cable entries and housings for rectangular connectors.

The ten Pg sizes :

Pg 7 / 9 / 11 / 13.5 / 16 / 21 / 29 / 36 / 42 and 48

are replaced by eight metric sizes :

M 12 / 16 / 20 / 25 / 32 / 40 / 50 and 63

3. Comparison of the Pg/metric cable gland sizes

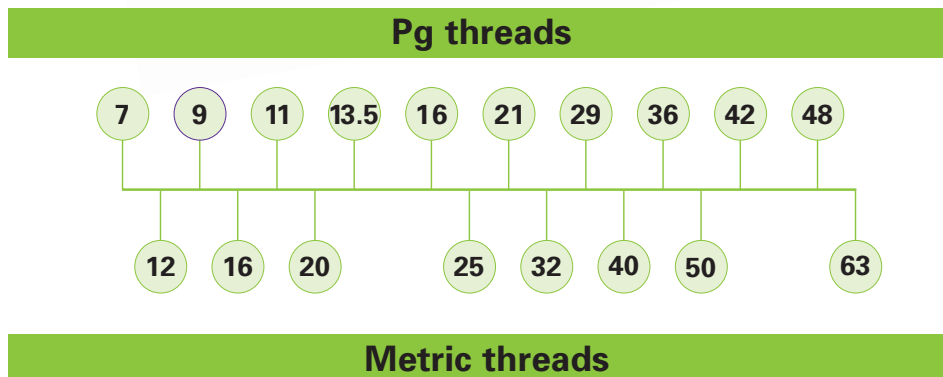

4. Assigning the Pg/metric cable glands

As the ten Pg sizes are replaced by eight metric threads, users will need to reassign the connection ranges of the cables to the metric thread sizes and housings.

facts

5. Conversion

5.1 Comparison between Pg thread and metric thread

Pg thread	Metric thread	Preferred types
Pg 7	M 12	
Pg 9	M 16	
Pg 11	M 20	X
Pg 13.5	M 20	X
Pg 16	M 20	X
Pg 21	M 25	X
Pg 29	M 32	X
Pg 36	M 40	
Pg 42	M 50	

Hoods of the revos BASIC series with Pg thread 13.5 and 16 are also available with M 25, while PG thread 21 is also available with M 32 thread.

If you require the Pg 16 and 24 housings in M 32, you will have to use the extended height housings.

5.2 Connection range for housing versions 7x.xxx.xxxx.0

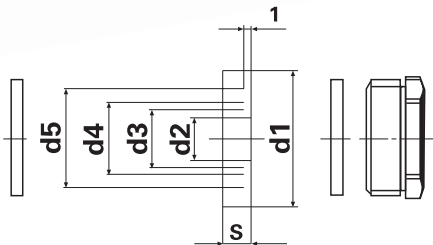

For more information visit us on the internet under www.wieland-electric.com

Please see the following table for the connection ranges of cable glands without strain relief:

Metric thread	d1	d2	Connection range in mm	d3	Connection range in mm	d4	Connection range in mm	d5	Connection range in mm
M 16	13.8	3	2 – 4.5	6	5 – 7.5	9	8 – 10.5		
M 20	17.6	4	3 – 5.5	7	6 – 8.5	10	9 – 11.5	13	12 – 14.5
M 25	22.6	8.5	7.5 – 10	11.5	10.5 – 13	14.5	13.5 – 16	17.5	16.5 – 19
M 32	29.6	16	15 – 17.5	19	18 – 20.5	22	21 – 23.5	25	24 – 26.5

5.3 Connection ranges for housing versions with flared gland 7x.xxx.xxxx.3

Metric thread	Connection range in mm
M 16	6 – 9
M 20	9 – 13.5
M 25	14 – 20
M 32	19 – 29

Information on hazardous location approval : Class I, Zone 2 Multipole Kits are available certified to CSA standard C22.2 182.3, E-79-15-95.

Please contact us to discuss your applications.

Tables, technical data, explanations

facts & DATA

Maximum short-time current capability assigned to mounting rails

DIN EN 60 947-7-2/VDE 0611 part 3: 1996-06

Rail profile	Material	Equivalent E-Cu cross section mm ²	Short-time current capability 1 s kA	Rated thermal current of a PEN busbar A
DIN rail TH 15 – 5.5 accord. to IEC 715	Steel	10	1.2	–
	Copper ¹⁾	25	3	101
	Aluminum ¹⁾	16	1.92	76
G rail G32 accord. to IEC 715	Steel	35	4.2	–
	Copper ¹⁾	120	14.4	269
	Aluminum ¹⁾	70	8.4	192
DIN rail TH 35 -7.5 accord. to IEC 715	Steel	16	1.92	–
	Copper ¹⁾	50	6	150
	Aluminum ¹⁾	35	4.2	125
DIN rail TH 35 -15 accord. to IEC 715 (made from 2.3 mm thick material)	Steel	50	6	–
	Copper ¹⁾	150	18	309
	Aluminum ¹⁾	95	11.4	232

¹⁾ Selected copper or aluminum alloys from the manufacturer of the terminal block layout were used to achieve the values in the table.

Electrical and thermal characteristics

Key figures / characteristics	Standard		Unit		Duroplast	Thermoplast							
					Typ 150	Polyamide						Polybutylen-terephthalate	Poly-carbonate
						PA 6	PA 6 GF	PA 66	PA 66 GF	PA 66/6	PA 66/6 GF		
Dielectric strength	VDE 0303-T21	IEC 243/1	kV / mm	tr/lf.	ca. 10	100 / 60	40 / 31	120 / 80	80 / 65	55 / 45	26 / 23	40	35
Dielectric loss tan _δ at 1 MHz	VDE 0303-T4	IEC 250		tr./lf.	0.3	0.03 / 0.3	0.015 / -	0.025 / 0.2	0.02 / 0.1	0.02 / 0.3	0.016 / -	0.017	0.01
Specific feed through resistance	VDE 0303-T30	IEC 93	Ω x cm	lf.	10 ¹⁰	10 ¹²	10 ¹¹	10 ¹²	10 ¹²	10 ¹²	10 ¹⁵	10 ¹⁶	10 ¹⁵
Surface resistance	VDE0303-T30	IEC 93	Ω	lf.	10 ¹⁰	10 ¹⁰	10 ¹⁰	10 ¹⁰	10 ¹⁰	10 ¹⁰	10 ¹⁴	10 ¹³	10 ¹⁵
Creepage	VDE0303-T1	IEC 112	CTI		600	600	550	600	550	600	325	200	225
Operating temperature RTI*	UL 746 B		°C at 1.5mm			130	140	125	115	120	140	140	130
Temperature index TI **	VDE0304 T.21	IEC 216-1	°C		120 / 80	100 / 80	185 / 160	118 / 101	157 / 139	123 / 107		130 / 120	
Lower operating temperature without mechanical stress			°C		-55	-40	-40	-40	-40	-40	-40	-40	-40
Flammability	UL 94		class/material thickness		V0	V2 / 1.5	V2 / 0.8	V2 / 0.4	V0 / 0.8	V0 / 0.4	V0 / 1.5	V0 / 0.5	V0 / 1.04
Suitability for tropical areas					good	good	good	good	good	good	good	good	good

* electrical value
** related to 50% strain resistance drop after 5,000/20,000 hours

facts

Rated connecting capacity and connectable conductor

Table 1 (IEC 60 999-1: 2000)

Rated connecting capacity	Connectable conductors and their theoretical diameters									
	Metric					AWG				
	rigid			flexible		rigid			flexible	
	mm ²	solid Ø mm	stranded Ø mm	mm ²	Ø mm	Gauge	¹⁾ solid Ø mm	¹⁾ Class B stranded Ø mm		²⁾ Class I, K, M stranded Ø mm
0.50	0.5	0.9	1.1	0.5	1.1	20	0.85	0.97	20	1.02
0.75	0.75	1.0	1.2	0.75	1.3	18	1.07	1.23	18	1.28
1.0	1.0	1.2	1.4	1.0	1.5	–	–	–	–	–
1.5	1.5	1.5	1.7	1.5	1.8	16	1.35	1.55	16	1.60
2.5	2.5	1.9	2.2	2.5	2.3*	14	1.71	1.95	14	2.08
4.0	4.0	2.4	2.7	4.0	2.9*	12	2.15	2.45	12	2.70
6.0	6.0	2.9	3.3	4.0	2.9*	10	2.72	3.09	–	–
10.0	10.0	3.7	4.2	6.0	3.9	8	3.43	3.89	10	3.36
16.0	16.0	4.6	5.3	10.0	5.1	6	4.32	4.91	8	4.32
25.0	25.0	–	6.6	16.0	6.3	4	5.45	6.18	6	5.73
35.0	35.0	–	7.9	25.0	7.8	2	6.87	7.78	4	7.26

* Measurement only for flexible conductors of Class 5 according to HD 383 (= IEC 228A, mod.), DIN VDE 0295

¹⁾ Nominal diameter + 5%

²⁾ Largest diameter for conductors of Class I, K, M, + 5%

The diameter of the largest rigid and flexible conductors are based on Table 1 of HD 383 (IEC 228A) and for AWG conductors are based on ASTM B172-71, ICEA Publ. S-19-81 and ICEA Publ. S-66-516.

Theoretical diameters of the largest conductor and ratio between the rated cross section and connectable conductors

Table 1 (IEC 60 999-2: 1995)

Rated cross section	Theoretical diameter of the largest conductor					Connectable conductor
	Metric		Gauge	AWG/Kcmil		
	rigid stranded mm	flexible Class 5 mm		rigid stranded mm	flexible mm	
35*	7.9	9.2	2	7.78	9.02	is to be indicated in the appropriate equipment specifications
–	–	–	1	8.85	10.61	
50	9.1	11.0	0	9.64	12.08	
70	11.0	13.1	00	11.17	13.54	
95	12.9	15.1	000	12.54	15.33	
–	–	–	0000	14.08	17.22	
120	14.5	17.0	250	15.34	19.01	
150	16.2	19.0	300	16.80	20.48	
185	18.0	21.0	350	18.16	22.05	
–	–	–	400	19.42	24.05	
240	20.6	24.0	500	21.68	26.57	
300	23.1	27.0	600	23.82	30.03	

* see IEC 60 999-1, table 1

**Tables, technical data,
explanations**

facts & DATA

Standard cross sections of round copper conductors

Metric size ISO mm ²	Comparison between AWG/kcmil und metric sizes			Metric size ISO mm ²	Comparison between AWG/kcmil und metric sizes		
	AWG	kcmil	mm ²		AWG	kcmil	mm ²
0.1*	28		0.081	16	6		13.3
0.14*	26		0.128	25	4		21.2
0.2	24		0.205	35	2		33.6
–	22		0.324	50	(1/0) 0		53.5
0.5	20		0.519	70	(2/0) 00		67.4
0.75	18		0.82	95	(3/0) 000		85
1	–		–	–	(4/0) 0000		107.2
1.5	16		1.3	120		250	127
2.5	14		2.1	150		300	152
4	12		3.3	185		350	177
6	10		5.3	240		500	253
10	8		8.4	300		600	304

* not standardized

Design and dimensions of solid, stranded, fine stranded and extra fine stranded copper conductors

Excerpt from DIN VDE 0295 (06.92)

Nominal cross section mm ²	solid		stranded		fine stranded	
	Diameter max. size	Number of wires	Diameter max. size	Number of wires	Diameter max. size	Number of wires Guide value
0.5	0.9	1	–	–	1.1	16
0.75	1.0	1	–	–	1.3	24
1	1.2	1	–	–	1.5	32
1.5	1.5	1	–	–	1.8	30
2.5	1.9	1	–	–	2.3	50
4	2.4	1	–	–	2.9	56
6	2.9	1	–	–	3.9	84
10	3.7	1	4.2	7	5.1	80
16	4.6	1	5.3	7	6.3	126
25	–	–	6.6	7	7.8	196
35	–	–	7.9	7	9.2	276
50	–	–	9.1	19	11	396
70	–	–	11	19	13.1	360
95	–	–	12.9	19	15.1	475
120	–	–	14.5	37	17	608
150	–	–	16.2	37	19	756
185	–	–	18	37	21	925
240	–	–	20.6	61	24	1224

Current carrying capacity of cables or wires

Recommended values for the current carrying capacity of cables or wires for fixed installation and external mounting have been taken from DIN VDE 0298 part 4/11.98 together with the modifications in draft DIN VDE 0298 part 4 A1/03.00 and are contained in supplement 1 to DIN VDE 0100 part 430, converted at 25 °C.

facts

Current carrying capacity of DIN rail terminal blocks

The following tables apply for DIN rail terminal blocks and copper conductors:
Test currents according to DIN EN 60 947-7-1/VDE 0611 part 1: 2000-05

Rated cross section mm ²	0.2	0.5	0.75	1	1.5	2.5	4	6	10	16	25	35	50	70	95	120	150	185	240	300
Test current A	4	6	9	13.5	17.5	24	32	41	57	76	101	125	150	192	232	269	309	353	415	520

The rated cross section of a DIN rail terminal block is the value indicated by the manufacturer of the connectable conductor cross section to which specific thermal, mechanical and electrical requirements refer.

The rated connecting capacity of a DIN rail terminal block is a range and/or a number of rated cross sections that the terminal block is intended for. It should be indicated for each terminal block separately.

The conductors can be rigid (solid or stranded) or flexible. The data pertains to unprepared conductor ends without ferrules and includes the largest and smallest connectable conductor cross sections.

In general it is possible to connect two conductors with the same cross section and design.

For DIN rail terminal blocks with special functions, the rated current from the manufacturer has been determined according to the requirements of the special functions. Special functions can be given by pluggable connections, isolating points, fuses, relays or electronic components. The current carrying capacity of other terminal blocks has been fixed and assessed following the above specifications according to nach EN 60 999/VDE 0609 part 1 or EN 60 998-1/VDE 0613 part 1 or

EN 60 335-1/DIN VDE 0700 part 1, as far as they are relevant.

The current carrying capacity for pluggable connectors (catalog sections **revos** and **wiecon** – for pluggable PC board connectors and headers) has been established and fixed according to DIN VDE 0627/06.86 and DIN 43 652, if applicable. Disconnect blocks, knife edged disconnect blocks and fuse blocks, cross connectors / jumper bars, jumpers and pluggable connectors should not be operated under load.

Torques

Excerpt from EN 60 947

Tightening torques for verification of mechanical stability of screw connections

Thread diameter (mm)		Tightening torque (Nm)		
Metric standard values	Diametrical range	I	II	III
2,5	≤ 2,8	0,2	0,4	0,4
3,0	> 2,8 through 3,0	0,25	0,5	0,5
–	> 3,0 through 3,2	0,3	0,6	0,6
3,5	> 3,2 through 3,6	0,4	0,8	0,8
4	> 3,6 through 4,1	0,7	1,2	1,2
4,5	> 4,1 through 4,7	0,8	1,8	1,8
5	> 4,7 through 5,3	0,8	2,0	2,0
6	> 5,3 through 6,0	1,2	2,5	3,0
8	> 6,0 through 8,0	2,5	3,5	6,0
10	> 8,0 through 10,0	–	4,0	10,0
12	> 10,0 through 12,0	–	–	14,0
14	> 12 through 15	–	–	19,0
16	> 15 through 20	–	–	25,0
20	> 20 through 24	–	–	36,0
24	> 24	–	–	50,0

Column I: Valid on for headless screws, that do not protrude from the threaded hole; also only for screws that are operated with screwdrivers having tisp smaller than the screws' thread core diameter.

Column II: applies for nuts and screws that are tightened with a screwdriver.

Column III: applies for nuts and screws that can be tightened with tools other than a screwdriver

The recommended torques were established so that within a conforming practical tolerance band, the optimal conditions are achieved for mechanical, thermal and electrical requirements.

A further increase in the tightening torque of the terminal screw does not improve the contact resistance significantly. It is therefore not advisable to tighten the terminal screws more than recommended, although the majority of the Wieland terminal blocks, especially the terminal blocks of the WK series, can withstand much higher torques.

In extreme cases, the conductor and/or terminal block can be damaged if the upper tolerance limit is exceeded.

Insulation coordination for equipment within low-voltage systems DIN VDE 0110-1/VDE 0110 part 1/04.97 (IEC 60 664-1: 1992, mod.) – Partly translated from German Version HD 625.1, S1: 1996

Main section – 1.1 Scope

1.1.1 This part of IEC 664 deals with insulation coordination for equipment within low-voltage systems . It applies to equipment for use up to 2,000 m above sea level, having a rated voltage up to AC 1,000 V with rated frequencies up to 30 kHz or a rated voltage up to DC 1,500 V.

It specifies the requirements for clearances, creepage distances and solid insulation for equipment based upon their performance criteria. It includes methods of electric testing with respect to insulation coordination.

The minimum clearances specified in this part do not apply where ionized gases occur. Special requirements for such situations may be specified at the discretion of the relevant Technical Committee.

This standard does not deal with distances
– through liquid insulation,
– through gases other than air,
– through compressed air.

NOTE 1: Extension of the scope up to 1 MHz is under consideration.

NOTE 2: Higher voltages may exist in internal circuits of the equipment.

NOTE 3: Requirements for altitudes exceeding 2,000 m can be derived from Table A.2 of Annex A.

1.1.2 The object of this basic safety standard is to guide Technical Committees responsible for different equipment in order to rationalize their requirements so that insulation coordination is achieved.

It provides the information necessary to give guidance to Technical Committees when specifying clearances in air, creepage distances and solid insulation for equipment.

facts

Product description and labelling

Currently there is still a range of device specifications, in which the regulations on insulation coordination have still not been incorporated. In addition, transition periods of up to 5 years apply for reworked standards in order to replace the older standards. Thus, for the foreseeable future, there are products existing side by side that have been developed and labelled following the old design rules and those that have already been designed according to the regulations for insulation coordination.

For this reason, wherever possible and applicable, the rating is given in the product descriptions according to the old and new regulations. The reassessment and conversion of the labelling of existing products is carried out in the framework of the transition periods in accordance with economical considerations.

The rating is given according to the new regulation in the format

Rated voltage/Rated impulse voltage/Degree of pollution
e. g. 800 V/8 kV/3

With this data, the rated impulse voltage is given priority over the overvoltage category. Therefore it is left to the users to decide which overvoltage category to select based on the requirements. If no rated voltage is indicated, the voltage data refer to overvoltage category III and degree of pollution 3.

It is imperative that the indicated wire strip lengths are observed. When connecting the wire, care must be taken that the insulation material is fed as closely as possible to the metal clamping body, as otherwise the creepage distances and clearances might be reduced.

2.2.2.1 Impulse withstand categories (overvoltage categories)

Impulse withstand categories are means to distinguish degrees of availability of equipment with regard to required expectations on continuity of service and on an acceptable risk of failure. By selection of impulse withstand levels of equipment, insulation coordination can be achieved in the whole installation, reducing the risk of failure to an acceptable level providing a basis for overvoltage control.

A higher characteristic numeral of an impulse withstand category indicates a higher specific impulse withstand of the equipment and offers a wider choice of methods for overvoltage control.

The concept of impulse withstand categories is used for equipment energised directly from the mains. The application of impulse withstand categories is based on the requirement with regard to additional protection against overvoltages as specified in IEC 364-4-443.

Note: Overvoltages of atmospheric origin are not significantly physically attenuated downstream in most installations. Investigations have shown that the concept of a probabilistic approach has proven reasonable and useful.

2.2.2.1.1 Equipment energized directly from the low-voltage

Technical Committees shall specify the overvoltage category as based on the following general explanation of overvoltage categories (see also IEC 364-4-443):

- Equipment of **overvoltage category IV** is for use at the origin of the installation.

Note: Examples of such equipment are electricity meters and primary overcurrent protection equipment

- Equipment of **overvoltage category III** is equipment in fixed installations and for cases where the reliability and the availability of the equipment is subject to special requirements.

Note: Examples of such equipment are switches, in the fixed installation and equipment for industrial use with permanent connection to the fixed installation.

- Equipment of **overvoltage category II** is energy-consuming equipment to be supplied from the fixed installation.

Note: Examples of such equipment are appliances, portable tools and other household and similar loads.

If such equipment is subjected to special requirements with regard to reliability and availability, overvoltage category III applies.

- Equipment of **overvoltage category I** is equipment for connection to circuits in which measures are taken to limit transient overvoltages to an appropriately low level.

Note: Examples are protected electronic circuits.

facts

2.5 Pollution

The micro-environment determines the effect of pollution on the insulation. The macro-environment, however, has to be taken into account when considering the micro-environment.

Means may be provided to reduce pollution at the insulation under consideration by effective use of enclosures, encapsulation or hermetic sealing. Such means to reduce pollution may not be effective when the equipment is subject to condensation or if, in normal operation, it generates pollutants itself.

Small clearances can be bridged completely by solid particles, dust and water and therefore minimum clearances are specified where pollution may be present in the micro-environment.

Note 1: Pollution will become conductive in the presence of humidity. Pollution caused by contaminated water, soot, metal or carbon dust is inherently conductive.

Note 2: Conductive pollution by ionized gases and metallic depositions occurs only in specific instances, for example in arc chambers of switchgear or controlgear, and is not covered by this part of IEC 664.

2.5.1 Degrees of pollution in the micro-environment

For the purpose of evaluating creepage distances and clearances, the following four degrees of pollution in the micro-environment are established:

- **Pollution degree 1**
No pollution or only dry, non-conductive pollution occurs. The pollution has no influence.
- **Pollution degree 2**
Only non-conductive pollution occurs except that occasionally a temporary conductivity caused by condensation is to be expected.
- **Pollution degree 3**
Conductive pollution occurs or dry, non-conductive pollution occurs which becomes conductive due to condensation which is to be expected.
- **Pollution degree 4**
The pollution generates persistent conductivity caused by conductive dust or by rain or snow.

2.5.2 Coordination with macro-environment

This sub-clause is under consideration.

2.7 Insulation material (excerpt)

The insulation material is divided into the following four groups according to their CTI (Comparative Tracking Index):

Insulation I: $600 \leq \text{CTI}$

Insulation II: $400 \leq \text{CTI} < 600$

Insulation III a: $175 \leq \text{CTI} < 400$

Insulation III b: $100 \leq \text{CTI} < 175$

The comparative tracking index must be defined according to DIN IEC 112/VDE 0303 part 1 on specimens made specially for this purpose with test solution A.

Note: The proof-tracking index (PTI) is also used to identify the tracking characteristics of materials. A material may be included in one of the four groups given above on the basis that its PTI, established by the methods of IEC 112 using solution A, is equal to or greater than the lower value specified for the group.

Tables, technical data, explanations

facts & DATA

Derivation of the rated impulse voltage from the overvoltage category and assignment of the nominal supply voltages to the rated impulse voltages for equipment

Excerpt from table 1 (IEC 60 664-1: 1992)

Nominal supply voltage for alternating voltage systems according to IEC 38 in V		Voltages wire to ground in V derived from the nominal supply voltage up to U_{eff} and U_-	Rated impulse voltage in V for overvoltage category			
3phase	1phase		I	II	III	IV
		50	330	500	800	1500
		100	500	800	1500	2500
	120-240	150	800	1500	2500	4000
230/400 277/480 ¹⁾		300	1500	2500	4000	6000
400/690		600	2500	4000	6000	8000
1000		1000	4000	6000	8000	12000

¹⁾ The nominal-supply voltage 500 V is included

facts

Dimensions of the clearances

DIN VDE 0110 part 1 section 3.1

Table 2: **Minimum clearances for the insulation coordination**

Required impulse voltage ¹⁾	Minimum clearances in heights up to 2000 m above sea level (NZ)							
	Case A (inhomogeneous field, see 1.3.15)				Case B (homogeneous field, see 1.3.14)			
	Degree of pollution				Degree of pollution			
	1	2	3	4	1	2	3	4
kV	mm	mm	mm	mm	mm	mm	mm	mm
0.33 ²⁾	0.01				0.01			
0.40	0.02				0.02			
0.50 ²⁾	0.04	³⁾			0.04	³⁾		
0.60	0.06	0.2 ⁴⁾			0.06	0.2 ⁴⁾		
0.80 ²⁾	0.10		0.8 ⁴⁾		0.1		0.8 ⁴⁾	
1.0	0.15			1.6 ⁴⁾	0.15			1.6 ⁴⁾
1.2	0.25	0.25			0.2			
1.5 ²⁾	0.5	0.5			0.3	0.3		
2.0	1.0	1.0			0.45	0.45		
2.5 ²⁾	1.5	1.5	1.5		0.6	0.6		
3.0	2	2	2	2	0.8	0.8		
4.0 ²⁾	3	3	3	3	1.2	1.2	1.2	
5.0	4	4	4	4	1.5	1.5	1.5	
6.0 ²⁾	5.5	5.5	5.5	5.5	2	2	2	2
8.0 ²⁾	8	8	8	8	3	3	3	3
10	11	11	11	11	3.5	3.5	3.5	3.5
12 ²⁾	14	14	14	14	4.5	4.5	4.5	4.5
15	18	18	18	18	5.5	5.5	5.5	5.5
20	25	25	25	25	8	8	8	8
25	33	33	33	33	10	10	10	10
30	40	40	40	40	12.5	12.5	12.5	12.5
40	60	60	60	60	17	17	17	17
50	75	75	75	75	22	22	22	22
60	90	90	90	90	27	27	27	27
80	130	130	130	130	35	35	35	35
100	170	170	170	170	45	45	45	45

¹⁾ This voltage is
 – for functional insulation: the highest impulse voltage to be expected on the clearance (see 3.1.4);
 – for base insulation, if directly or mainly influenced by transient overvoltages of the low-voltage network (see 2.2.2.2, 2.2.2.3.1 and 3.1.5):
 the rated impulse voltage of the equipment;
 – for other base insulation (see 2.2.2.3.2): the highest impulse voltage which may occur in the circuit
 – for reinforced insulation, see 3.1.5.

²⁾ Preferred values, as determined in 2.1.1.2

³⁾ For PC board connectors, the values of pollution degree 1 apply, except for the fact that the value must not be below 0.04 mm as determined in table 4

⁴⁾ The minimum clearances for the pollution degrees 2, 3 and 4 are based on experience, not on basic knowledge

Table A.2: **Height correction factors**

Height m	Normal air pressure kPa	Multiplication factor for clearances
2000	80.0	1.00
3000	70.0	1.14
4000	62.0	1.29
5000	54.0	1.48
6000	47.0	1.70
7000	41.0	1.95
8000	35.5	2.25
9000	30.5	2.62
10000	26.5	3.02
15000	12.0	6.67
20000	5.5	14.50

Tables, technical data, explanations

facts & DATA

Nominal voltage of the low-voltage network

Table 3a: **Single phase 3 or 2 wire alternating or direct voltage systems**

Nominal voltage of the power supply system (network) ^{*)}	Voltages for table 4	
	for insulation Wire – Wire ¹⁾	for insulation Wire – Ground ¹⁾
	All systems	3 wire systems center grounded
V	V	V
12.5	12.5	–
24 25	25	–
30	32	–
42 48 50,**)	50	–
60	63	–
30–60	63	32
100,**)	100	–
110 120	125	–
150,**)	160	–
220,	250	–
110–220 120–240	250	125
300,**)	320	–
220–440	500	250
600,**)	630	–
480–960	1000	500
1000,**)	1000	–

¹⁾ Wire-ground insulation level for ungrounded or impedance-grounded networks equal those of wire-wire, as the operating voltage of each wire to ground can in practice reach wire-wire voltage. The reason is that the actual voltage to ground is determined by the insulation resistance and the capacitive blind resistance of each wire to ground. That means that a low (but permissible) insulation resistance of a wire can practically ground it and increase the other two to wire-wire voltage to ground.

^{*)} For relation with the rated voltage see 2.2.1.

^{**)} (see national foot note)

Table 3b: **Three-phase 4 or 3 wire alternating voltage systems**

Nominal voltage of the power supply system (network) ¹⁾	Voltage for table 4		
	for insulation Wire – Wire	for insulation Wire – Ground	
	All systems	Three-phase 4 wire systems with grounded neutral ²⁾	Three-phase 3 wire systems ungrounded ¹⁾ or grounded wire
V	V	V	V
60	63	32	63
110 120 127	125	80	125
150,**)	160	–	160
208	200	125	200
220 230 240	250	160	250
300,**)	320	–	320
380 400 415	400	250	400
440	500	250	500
480 500	500	320	500
575	630	400	630
600,**)	630	–	630
660 690	630	400	630
720 830	800	500	800
960	1000	630	1000
1000,**)	1000	–	1000

¹⁾ Wire-ground insulation level for ungrounded or impedance grounded networks equal those of wire-wire, as the operating voltage of each wire to ground can in practice reach wire-wire voltage. The reason is that the actual voltage to ground is determined by the insulation resistance and the capacitive blind resistance of each wire to ground. That means that a low (but permissible) insulation resistance of a wire can practically ground it and increase the other two to wire-wire voltage to ground.

²⁾ For equipment which can be operated both in three-phase 4 wire and in three-phase 3 wire networks, grounded and also ungrounded, only the values for 3 wire systems are to be used.

^{*)} For relation with the rated voltage see 2.2.0.1.

^{**)} (see national foot note)

facts

Dimensions of the creepage distances

DIN VDE 0110 part 1 section 3.2

Table 4: **Minimum creepage distances for equipment under long-term voltage**

Effective voltage value ¹⁾ V	Creepage distances											
	Printed circuits		Degree of pollution									
	Pollution degree		1	2			3			4		
	1 ²⁾ mm	2 ³⁾ mm	2 ²⁾ mm	Insulation material			Insulation material			Insulation material		
			I mm	II mm	III mm	I mm	II mm	III ⁴⁾ mm	I mm	II mm	III ⁴⁾ mm	
10	0.025	0.04	0.08	0.4	0.4	0.4	1	1	1	1.6	1.6	1.6
12.5	0.025	0.04	0.09	0.42	0.42	0.42	1.05	1.05	1.05	1.6	1.6	1.6
16	0.025	0.04	0.1	0.45	0.45	0.45	1.1	1.1	1.1	1.6	1.6	1.6
20	0.025	0.04	0.11	0.48	0.48	0.48	1.2	1.2	1.2	1.6	1.6	1.6
25	0.025	0.04	0.125	0.5	0.5	0.5	1.25	1.25	1.25	1.7	1.7	1.7
32	0.025	0.04	0.14	0.53	0.53	0.53	1.3	1.3	1.3	1.8	1.8	1.8
40	0.025	0.04	0.16	0.56	0.8	1.1	1.4	1.6	1.8	1.9	2.4	3
50	0.025	0.04	0.18	0.6	0.85	1.2	1.5	1.7	1.9	2	2.5	3.2
63	0.04	0.063	0.2	0.63	0.9	1.25	1.6	1.8	2	2.1	2.6	3.4
80	0.063	0.1	0.22	0.67	0.95	1.3	1.7	1.9	2.1	2.2	2.8	3.6
100	0.1	0.16	0.25	0.71	1	1.4	1.8	2	2.2	2.4	3	3.8
125	0.16	0.25	0.28	0.75	1.05	1.5	1.9	2.1	2.4	2.5	3.2	4
160	0.25	0.4	0.32	0.8	1.1	1.6	2	2.2	2.5	3.2	4	5
200	0.4	0.63	0.42	1	1.4	2	2.5	2.8	3.2	4	5	6.3
250	0.56	1	0.56	1.25	1.8	2.5	3.2	3.6	4	5	6.3	8
320	0.75	1.6	0.75	1.6	2.2	3.2	4	4.5	5	6.3	8	10
400	1	2	1	2	2.8	4	5	5.6	6.3	8	10	12.5
500	1.3	2.5	1.3	2.5	3.6	5	6.3	7.1	8	10	12.5	16
630	1.8	3.2	1.8	3.2	4.5	6.3	8	9	10	12.5	16	20
800	2.4	4	2.4	4	5.6	8	10	11	12.5	16	20	25
1000	3.2	5	3.2	5	7.1	10	12.5	14	16	20	25	32
1250			4.2	6.3	9	12.5	16	18	20	25	32	40
1600			5.6	8	11	16	20	22	25	32	40	50
2000			7.5	10	14	20	25	28	32	40	50	63
2500			10	12.5	18	25	32	36	40	50	63	80
3200			12.5	16	22	32	40	45	50	63	80	100
4000			16	20	28	40	50	56	63	80	100	125
5000			20	25	36	50	63	71	80	100	125	160
6300			25	32	45	63	80	90	100	125	160	200
8000			32	40	56	80	100	110	125	160	200	250
10000			40	50	71	100	125	140	160	200	250	320

¹⁾ This voltage is

- for functional insulation: the operating voltage
- for base and additional insulation of a power circuit directly supplied by the low-voltage network (see 2.2.1.1.1): the voltage selected from table 3a or 3b based on the rated voltage of the equipment, or the rated insulation voltage
- for base and additional insulation of systems, equipment and internal circuits, which are not directly supplied by the low-voltage network (see 2.2.1.1.2): the highest effective voltage value, which may occur among the ratings in the network, equipment or internal circuit under rated voltage supply and under unfavorable combination of the operating conditions

²⁾ Insulation material groups I, II, IIIa and IIIb

³⁾ Insulation material groups I, II and IIIa

⁴⁾ Insulation material group IIIb is not recommended for pollution degree 3 at voltages above 630 V and also not for pollution degree 4.

Note:

In agreement with VDE 0110 for rated voltages 127, 208, 415, 660/690, 830 volt creepage distances must be rated according to the lower values of 125, 200, 400, 630, 800 Volts.

Creepage distances and clearances according to DIN VDE 0110b/02.79

Reference voltage (table 1) up to Alternating voltage (effective values) V	Direct voltage V	Insulation group A ₀		Insulation group A		Insulation group B			Insulation group C			Insulation group D		
		Clearance	Creepage distance	Clearance	Creepage distance	Clearance	Creepage distance		Clearance	Creepage distance		Clearance	Creepage distance	
		L mm	mm	L mm	mm	L mm	a mm	b mm	L mm	a mm	b mm	L mm	a mm	b mm
12	15	0.06	0.1	0.15	0.2	0.4	0.6	0.8	0.8	1.2	1.7	1.6	2.3	3.2
30	36	0.1	0.15	0.2	0.25	0.5	0.8	1	1	1.5	2	1.8	2.6	3.5
60	75	0.15	0.2	0.25	0.35	0.7	1	1.3	1.2	1.7	2.3	2	3	4
125	150	0.25	0.35	0.4	0.5	1	1.3	2	1.6	2.2	3	2.5	3.5	5
250	300	0.5	0.7	0.8	1	1.6	2	3	2.5	3	4	3.5	5	7.5
380	450	0.8	1.1	1.2	1.5	2.4	3	4	3.5	4.5	6	5	7	10
500	600	1.1	1.5	1.6	2	3	4	5.5	4.5	6	8	6.5	9	13
660	800	1.5	2	2.2	2.8	4	5.5	7	6	8	10.5	8	12	17
750	900	1.8	2.2	2.5	3.2	4.5	6	8	6.5	9	12	9	13	19
1000	1200	2.5	3	3.5	4.5	6	8	11	9	12	16	12	17	25
1500	1800	4	5	5.5	7	9	12	17	13	18	24	17	25	36
2000	2400	5.5 ¹⁾	7	7.5 ¹⁾	9.5	12	16	23	17	24	30	22	33	47
3000	3600	9 ¹⁾	11	12 ¹⁾	15	18 ¹⁾	25	36	26 ¹⁾	36	45	32 ¹⁾	48	70
6000	7200	20 ¹⁾	25	26 ¹⁾	32	36 ¹⁾	50	70	50 ¹⁾	70	90	60 ¹⁾	90	125
10000	12000	35 ¹⁾	45	45 ¹⁾	55	60 ¹⁾	90	120	80 ¹⁾	120	160	100 ¹⁾	150	200

¹⁾ To prevent continuous glow at operating voltage (reference voltage) sharp-edged metal components should be avoided.
(V. Herstein: Measuring clearances, especially for 50 Hz alternating voltage.
etz-a 90 (1969) 11, pages 251 to 255, 9B., 11 Qu)

- Insulation group A₀:** Lower-power equipment in air-conditioned or clean and dry rooms that is suitably protected and heats up minimally when short circuits occur
- Insulation group A:** Electrical equipment in air-conditioned or clean and dry rooms that is suitably protected
- Insulation group B:** Electrical equipment in households, stores and other commercial premises, in precision engineering workshops, laboratories, testing stations, in rooms for medical use etc.
- Insulation group C:** Electrical equipment used primarily in premises for industrial, commercial and agricultural use, in unheated warehouses, in workshops, in boiler rooms, machine tools etc.
- Insulation group D:** Electrical equipment for use in motor vehicles that are particularly subject to the effects of conductive brake dust and moisture (condensation water or snow) and cannot be sufficiently protected by casing.

Division of creepage distances

Table 3: Resistance to creepage

1	2	3	4
Group	Resistance to creepage ¹⁾ (minimum value)	Creepage distance without ripple	Creepage distance with ripple accord. to § 8a)
I	(minimum value) KB 100	b	$\frac{a+b}{2}$
II	(minimum value) KB 380	$\frac{a+b}{2}$	a
III	KB > 600	a	a

¹⁾ Steps of creepage resistance according to DIN 53 480, VDE 0303 part 1

Note:

The voltages given according to DIN VDE 0110b/02.79 refer, unless otherwise identified, to insulation group C.

facts

Degrees of protection according to DIN EN 60 529/ VDE 0470 part 1: 2000 – 09

Connecting devices such as modular terminals, connecting terminals, printed circuit board terminals and plug-in connectors etc., intended for mounting devices and installation that have no shock-protection housing in the sense of this standard. No IP protection category can thus be assigned to it. The insulating component is used in the first place for functional insulation, but can in addition offer protection against direct contact of active components e.g. safety finger contact and/or touch by the back of the hand. Its surface is not regarded as exposed. The definitive shock protection is secured by installation measures and by the external protective covering of the end device of the installation.

Identification examples using the IP code

Explanation of Alpha-numeric IP code system



A housing using this identification (IP code)

- 2 – protects people against access to dangerous components (touch-safe)
 - protects the equipment within the housing against ingress of solid foreign bodies with a diameter of 12.5 mm and larger
- 3 – protects the equipment within the housing against damaging effects of water that is sprayed from every direction against the housing
- C – protects people who are handling tools with a diameter of 2.5 mm and larger, and a length less than 100 mm, against access to dangerous components (the tool can be inserted into the housing at full length)
- S – is tested to provide protection against damaging effects of water ingress, while all components of the equipment are in standstill position

Tables, technical data, explanations

facts & DATA

Components of the IP code and its meaning

A short description of the IP code components is given in the following table:

Component	Figures or letter	Meaning for the protection of the equipment	Meaning for the protection of people:
Identification letter	IP	–	–
First identification number	0	against ingress of solid foreign bodies (unprotected)	against access to dangerous components with (unprotected)
	1	≥ 50 mm diameter	back of hand
	2	≥ 12.5 mm diameter	finger
	3	≥ 2.5 mm diameter	tool
	4	≥ 1.0 mm diameter	wire
	5	protected against dust	wire
	6	dustproof	wire
Second identification number		against ingress of water with damaging effects	
	0	(unprotected)	
	1	dripping water falling vertically	
	2	dripping water (15° slope)	
	3	spraying water	
	4	splashing water	
	5	jet water	
	6	powerful jet water	
	7	temporary submersion	
8	continuous submersion		

Table 1: **Degrees of protection against access to dangerous components, identified by the first identification number**

First identification number	Degree of protection	
	Brief description	Definition
0	unprotected	–
1	protected against access to dangerous components with the back of the hand	The access probe, 50 mm diameter sphere, must be a sufficient distance away from the dangerous components
2	protected against access to dangerous components with a finger	The jointed test finger, 12 mm in diameter, 80 mm in length, must be a sufficient distance away from the dangerous components
3	protected against access to dangerous components with a tool	The access probe with a diameter of 2.5 mm must not penetrate
4	protected against access to dangerous components with a wire	The access probe with a diameter of 1.0 mm must not penetrate
5	protected against access to dangerous components with a wire	The access probe with a diameter of 1.0 mm must not penetrate
6	protected against access to dangerous components with a wire	The access probe with a diameter of 1.0 mm must not penetrate
<p>Note: For the first identification numbers 3, 4, 5 and 6 protection against access to dangerous components is provided if a sufficient distance is maintained. Due to the simultaneously applicable requirement according to table 2, the definition "must not penetrate" was given in table 1.</p>		

facts

Table 2: Degrees of protection against solid foreign bodies

First identification number	Degree of protection	
	Brief description	Definition
0	unprotected	–
1	protected against solid foreign bodies of 50 mm and larger	Full penetration of spheres of 50 mm diameters or allowed*)
2	protected against solid foreign bodies of 12.5 mm and larger	Full penetration of spheres of 12.5 mm diameters or allowed*)
3	protected against solid foreign bodies of 2.5 mm and larger	Full penetration of 2.5 mm diameter sphere is not allowed at all*)
4	protected against solid foreign bodies of 1.0 mm and larger	Full penetration of 1.0 mm diameter sphere is not allowed at all*)
5	protected against dust	Penetration of dust is not fully prevented, but dust must not penetrate to such an extent that the satisfactory functioning of the device or safety is restricted in any way
6	protected against dust	No penetration of dust

*) **Note:** The full diameter of the object probe must not go through any opening in the housing

Table 4: Degrees of protection against access to dangerous components, identified by the additional letter

First identification number	Degree of protection		Test conditions see section
	Brief description	Definition	
A	protected against touch with the back of hand	The access probe, 50 mm diameter sphere, must be at a sufficient distance away from dangerous components	15.2
B	protected against touch with the finger	The jointed test finger, 12 mm in diameter, 80 mm in length, sufficient distance away from dangerous components	15.2
C	protected against access with a tool	The access probe with a diameter of 2.5 mm and a length of 100 mm must be a sufficient distance away from dangerous components	15.2
D	protected against access with a wire	The access probe with a diameter of 1.0 mm and a length of 100 mm must be a sufficient distance away from dangerous components	15.2

Table 3: **Degree of protection against water, identified by the second identification number**

Second identification number	Degree of protection	
	Brief description	Definition
0	unprotected	–
1	protected against dripping water	Dripping water falling vertically must not have a damaging effect
2	protected against dripping water if the housing is sloped up to 15°	Dripping water falling vertically must not have a damaging effect if the housing is sloped by an angle of up to 15° both sides of the vertical
3	protected against spraying water	Water that is sprayed at an angle of 60° both sides of the vertical must not have any damaging effect
4	protected against splashing water	Water that is sprayed from all directions against the housing must not have any damaging effect
5	protected against jet water	Water that is directed from all directions as a jet against the housing must not have any damaging effect
6	protected against powerful jet water	Water that is directed from all directions as a powerful jet against the housing must not have any damaging effect
7	protected against the effects of temporary immersion in water	Water must not penetrate in a quantity to cause damage if the housing is immersed temporarily in water under standard pressure and time conditions
8	protected against the effects of continuous immersion in water	Water must not penetrate in a quantity to cause damage if the housing is continuously immersed in water conditions that must be arranged between the manufacturer and the user. The conditions must however be more severe than for identification number 7.

Degree of protection against water, identified by the second identification number

The second identification number gives the protection category through housing in light of damaging influences on the electrical equipment following penetration of water.

Table 3 gives short descriptions and definitions for the degrees of protection that are represented by the second identification number .

Degrees of protection that are given in this table may only be determined by the second identification number and not by reference to the short description or definition. Until the second identification number 6, the designation means that the requirements for all the lower identification numbers have been fulfilled.

A housing that is identified only with the second identification number 7 or 8 is considered unsuitable for stress through jet water (identified with the second identification number 5 or 6) and does not need to meet the requirements of number 5 or 6. It should be provided with a double identification according to the following table:

facts

The housing complies with the test for			
jet water, second identification number	temporary/continuous immersion, second identification number	Identification and label	Field of application
5	7	IPX5 / IPX7	varied
6	7	IPX6 / IPX7	varied
5	8	IPX5 / IPX8	varied
6	8	IPX6 / IPX8	varied
	7	IPX7	limited
	8	IPX8	limited

Housings for “varied” use, as indicated in the last column, must meet the requirements both for exposure to jet water and temporary or continuous immersion in water.

Housings for “limited” use, as indicated in the last column, are only regarded as suitable for temporary or continuous immersion and as unsuitable for exposure to jet water.

Modular terminals for installations with explosion hazard (Ex terminals) Protection category "Increased safety EEx e"

Ex terminals are modular terminals that have been tested and certified by a European Ex test institute in accordance with

DIN EN 50 014 – VDE 0171 part 1
"General requirements" and

DIN EN 50 019 – VDE 0170/0171 part 6
"Protection category: Increased safety 'e' "

The protection category "Increased safety EEx e" applies to electrical equipment that resists sparks, electric arcing or hazardous surface temperatures during operation. Modular terminals thus fall into temperature category T6, in which electrical equipment at an ambient temperature of 40°C and being operated in compliance with regulations, does not exceed the maximum temperature (surface temperature) of 85°C. Certified test institutes are e.g. the Physikalisch Technische Bundesanstalt PTB in Germany, the Laboratoire Central des Industries Electrique LCIE in France, the Health and Safety Executive BASEEFA in England, the EX-Labor of ASEV in Switzerland amongst others.

However, for modular terminals used as incomplete electrical equipment, only a partial certification is issued. This certificate is the basis for the final inspection and certification of the complete installation before it is commissioned by an expert.

The certificate (partial certification) includes a description of the modular terminals, in which special requirements regarding the preparation of terminal strips are made e.g. installing separating end cover plates when modular terminals are connected in series.

Test Certificate

Certificates from LCIE and ASEV are available for feed through terminals of the WK... range and protective conductor terminals of the WK...SL.. range, if indicated. The certificates identify the relevant nominal data and include the accessories listed in the description. The areas of application are divided into:

Group I: Electrical equipment for mines with firedamp hazard

Group II: Electrical equipment for areas with explosion hazard except for mines with firedamp hazard (e.g. installations with explosion hazard for the chemical and petrochemical industries)

In accordance with a resolution of the DKE, Deutsche Elektrotechnische Kommission, terminals are also accepted as electrical equipment for Group I (firedamp protection EEx e I) for which only the increased safety protection type 'e' for Group II (explosion protection EEx e II) has been certified and vice versa.

Modular terminals with Ex protection are identified with the label EEx e I/II or EEx e II and with the approval number. The complete test certification with a description is available upon request.

facts

Protection category "Intrinsic safety Eex i"

According to the installation specification DIN VDE 0165, electrical equipment installed in areas with explosion hazard of group II, zone I (chemical and petrochemical industries) are excluded from the type test and obligatory marking, if they do not contain any voltage source and correspond to DIN EN 50020-VDE 0170/0171 part 7. This applies in particular to feed through terminals in the standard version, as DIN EN 50020 does not make any special demands on connector terminals of the protection category Eex i.

It has been generally accepted that feed through terminals in intrinsically safe circuits are clearly marked with the blue coloring of the insulated housing. For intrinsically safe circuits, feed through terminals can be used in the standard version and if required available with blue insulating housing.

EEx approvals according to the ATEX guideline – 94/9/EG

(ATEX = Atmospheres Explosibles) are currently being prepared.

This guideline aims at clarifying the procedures and applications of devices, components and protective systems to make them suitable for use in explosion hazard areas. Their proper use shall then help to eliminate the barriers and difficulties that occur in the free exchange of goods within the European Community.

The transition period between EEx approvals and the ATEX guideline will last until June 30, 2003.

DIN VDE 0106 part 100: 1983 – 03 Protection against electrical shock. Layout of operating devices near live components

The standard cited in the **Accident Prevention Regulation VBG 4** is seen as the basis for the layout of electrical equipment up to 1000 V \sim (1500 V \Rightarrow) as regards protection against direct contact, where operating devices are arranged near live components that are operated by at least electrotechnically instructed persons (occasional handling).

A protected zone is established for this purpose which must be reached into on "occasional handling" of the operating device (switch, push button, rotary button). A distance of

- 30 mm around the operating device "safety from finger touch" and
- 100 mm around the operating device "safety from touch by the back of the hand"

is designed and required.

The VBG 4 regulation is directed at the installer or user of electrical installations who must plan, build and finally operate the installation in accordance with accident prevention regulations. The installer has the task of selecting electrical equipment with the objective and if necessary making it safe to touch using accessories. Only he can confirm that his installation conforms to the accident prevention regulation VBG4.

Wieland develops, builds and tests its products according to the relevant equipment and safety regulations that are likewise cited in regulation VBG4 and moreover offers a range of accessories that takes this requirement into account.

Standards and specifications

facts & DATA

Range of standards DIN VDE 0100

Installation of power systems and equipment with nominal voltages up to 1,000 V

This VDE regulation is a regulation for installations but also contains important details for the manufacturer of equipment and components such as permissible loads for cables, the use of protective conductor terminals and neutral conductor isolating terminals.

DIN EN 50 110-1/VDE 0105 part 1: 10.97

Operation of power systems and equipment

DIN VDE 0106-100/VDE 0106 part 100: 03.83

Protection against electric shock;

Actuating members positioned close to parts liable to shock (VDE Specifications)

DIN VDE 0106-101/VDE 0106 part 101: 11.86

Protection against electric shock;

Basis requirements for protective separation in electrical equipment

DIN VDE 0108-1/VDE 0108 part 1: 10.89

Power systems and safety power supply in building installations for groups of people; general

DIN VDE 0110/11.72 und DIN VDE 0110 b/02.79 **withdrawn!**

Insulation coordination for electrical equipment in low-voltage installations

- Measurement of creepage distances and clearances

DIN VDE 0110-1/VDE 0110 part 1: 04.97

(IEC 60 664-1: 1992, modified)

HD 625.1 S1: 1996

- Basic principles, requirements and tests

DIN EN 60 204 1/VDE 0113 part 1: 11.98

(IEC 60 204-1: 1992, modified)

Electrical equipping of machines; part 1: general requirements

DIN EN 50 178/VDE 0160: 04.98

Equipping of power installations with electronic equipment

DIN VDE 0165: 02.91

Installation of electrical systems and equipment in areas with explosion hazard

DIN EN 60 079-14/VDE 0165 part 1: 08.98

EN 50 014: 1992/DIN VDE 0170/0171 part 1: 03.94 **withdrawn**

Electrical equipment for areas with explosion hazard; general specifications

DIN EN 50014/VDE 0170/0171 part 1: 02.00

DIN EN 50 019: VDE 0170/0171 part 6: 03.96

Electrical equipment for areas with explosion hazard; increased safety "e"

DIN EN 50 020: VDE 0170/0171 part 7: 04.96

Electrical equipment for areas with explosion hazard; intrinsic safety "i"

DIN EN 60 529: VDE 0470 part 1: 09.00

(IEC 60 529: 1989, +A: 1999)

Protection categories by housing (IP code)

DIN VDE 0606: 02.76 and DIN VDE 0606 b: 02.80 **withdrawn***

VDE specification for connecting devices up to 750 V

Installation consumer units and meter mounting boards up to 250 V

facts

DIN VDE 0606 part 1: 11.84 withdrawn*

Connecting devices up to 660 V; installation boxes for taking up devices and/or connecting terminals

DIN VDE 0609 part 1: 06.83 partly replaced by DIN EN 60999-1/VDE 0609 part 1: 12.00

Connecting points for screw terminals for connecting or linking copper conductors up to 240 mm²; general definitions

DIN EN 60 999: VDE 0609 part 1: 12.00

(IEC 60 999: 1999)

Connecting devices, safety requirements for screw terminal connections and screwless terminal connections for electrical copper conductors

DIN EN 60 947-7-1: VDE 0611 part 1: 05.00

(IEC 60 947-7-1: 1989)

Low-voltage switching devices

Part 7: Auxiliary equipment

Main section 1 – modular terminals for copper conductors

DIN EN 60 947-7-2: VDE 0611 part 3: 06.96

(IEC 60 947-7-2: 1995)

Low-voltage switching devices

Part 7: Auxiliary devices

Main section 2 – ground conductor terminals for copper conductors

DIN VDE 0611 part 3: 11.89

withdrawn, replaced by DIN EN 60 947-7-2/VDE 0611 part 3: 06.96

(transition period until 01.07.2001)

Modular terminals for connecting or linking copper conductors, protective conductive modular terminals up to 120 mm²

DIN VDE 0611-4/VDE 0611 part 4: 02.91

Modular terminals for connecting or linking copper conductors; multi-tier distribution board for modular terminals up to 6 mm²

E DIN VDE 0611-6/VDE 0611 part 6: 05.95

Modular terminals for copper conductors

Safety requirements for modular terminals for taking

up fuse units

DIN VDE 0611-20/VDE 0611 part 20: 12.87

Modular terminal blocks for connection of copper conductors up to 1000 V a.c. and up to 1200 V d.c.; test for flammability and flame propagation

DIN EN 60 998-1/VDE 0613-1: 04.94

(IEC 60 998-1: 1990, modified)

Connecting devices for low-voltage circuits for household and similar use

Part 1: General requirements

DIN EN 60 998-2-1/VDE 0613 part 2-1: 04.94

(IEC 60 998-2-1: 1990, modified)

Connecting devices for low-voltage circuits for household and similar use

Part 2-1: Special requirements for connecting devices as separate equipment and screw terminals

DIN EN 60 998-2-2/VDE 0613 part 2-2: 08.94

(IEC 60 998-2-2: 1991)

Connecting devices for low-voltage circuits for household and similar use

Part 2-2: Special requirements for connecting devices as separate equipment and screwless terminals

***replaced by DIN VDE 0606-1/VDE 0606 part 1: 10.00**

connecting devices up to 690 V – installation boxes for taking up devices and/or connecting terminals

Standards and specifications

facts & DATA

DIN EN 60 998-2-3/VDE 0613 part 2-3: 09.94

(IEC 60 998-2-3: 1991)

Connecting devices for low-voltage circuits for household and similar use

Part 2-3 : Special requirements for connecting devices as separate equipment and IDC terminals

DIN EN 61 210/VDE 0613 part 6: 09.95

(IEC 61 210: 1993 modified)

Connecting devices

Flat push-on connection for electrical copper conductors; safety requirements

DIN EN 50 262/VDE 0619: 04.99

Metric cable glands for electrical installations; German version EN 50262: 1998

DIN EN 60 320-1/VDE 0625 part 1: 07.97

(IEC 60 320-1: 1994, modified + A1: 1995)

Appliance couplers for household and and similar general use

DIN EN 60 320-1 A2/VDE 0625 part 1 A2: 10.98

(IEC 60 320-1: 1994/A2: 1996)

Modification no. 2

DIN EN 60 320-2-2/VDE 0625 part 2-2: 09.99

(IEC 60 320-2-2: 1990, modified)

Appliance couplers for household and and similar general use

Part 2: Remote connections for devices for household use and similar installations

DIN EN 60 799/VDE 0626: 06.99

(IEC 60 799: 1998)

Electrical accessories – Cord sets and interconnection cord sets (IEC 60 799: 1998);

German version EN 60 799: 1998

DIN VDE 0627 : 06.86

Plug-in connectors and plug and socket devices with rated voltages up to AC 1000 V,

up to DC 1200 V and rated currents up to 500 A per contact

DIN VDE 0628: 11.84

Plug-in connectors for nominal voltages up to AC 380 V with nominal current of 16 A

DIN IEC 23/221/CD/VDE 0606 part 1535: 07.96

Separable connecting devices intended for permanent connection – Part. 1 : General requirements;

IEC 23/221/CD: 1996

DIN EN 60 947-1/VDE 0660 part 100: 12.99

(IEC 60 947-1: 1996, modified + Corrigendum March 1998)

Low-voltage switching devices

Part 1: General definitions

DIN EN 60 439-1/VDE 0660 part 500: 08.00

(IEC 60 439-1: 1999)

Low- voltage switchgear and controlgear assemblies – Part 1:

Type-tested and partially type-tested assemblies

DIN EN 60 439-3/VDE 0660 part 504: 04.92

(IEC 60 439-3: 1990, modified)

Switching devices; low-voltage switchgear assembly;

Part 3: Special requirements of low-voltage switchgear assembly that laymen have access to operate,

– Distribution boards –

DIN EN 60 335-1/VDE 0700 part 1: 10.95

(IEC 60 335-1: 1991, modified)

Safety of electrical devices for household and similar use;

Part 1: General requirements

facts

**EN 60 335-1 A2: 1988, A5: 1989, A6: 1989 and A51:
1991/DIN VDE 0700 part 1 A6: 12.91**

Safety of electrical devices for household and similar use
Part 1: General requirements (modifications)

DIN EN 60 598-1/VDE 0711 part 1: 08.98

(IEC 60 598-1: 1996, modified)

Luminaires

Part 1: General requirements and tests

DIN EN 60 127-2/VDE 0820 part 2: 08.96

(IEC 60 127-2: 1989 + A1: 1995 + A2: 2000)

Miniature fuses Part 2: Cartridge fuse-links German version EN 60 127-2: 1989 + A1: 1995 + A2: 2000

DIN EN 60 127-6/VDE 0820 part 6: 12.96

(IEC 60 127-6: 1994 + A1996)

VDE specification for fuses (G fuses)

Specification for G fuse holder

EN 60 715: 2001/DIN EN 60 715: 09.2001

Dimensions of low-voltage switchgear and controlgear

Standardized mounting on rails for mechanical support of electrical devices in switchgear and controlgear installations

(IEC 60 715: 1981 + A1: 1995); German version EN 60 715: 2001

IEC 60 038: 1983/DIN IEC 38: 05.87

and supplement 1 to DIN IEC 38/12.92

IEC standard voltages

At the end of 1993, the international standard IEC 38 „IEC standard voltages“ was agreed.

In the framework of this standard it was not possible to standardize worldwide the applicable voltage values 220/380 V, 230/400 V and 240/415 V for 50 Hz low-voltage supply networks.

The supply nominal voltage should according to this standard not exceed the values 230/400 V + 6 %/–10 % during the transition period up to the year 2003.

Through these defined tolerances for the optional voltage of the networks, it is possible that 220/380 V rated electrical equipment, as indicated in DIN IEC 38, can be used safely until the end of their service life.

All the considerations indicated above should be used at the existing value of 380/660 V in light of the new value of 400/690 V.

Therefore, products that are tested, documented and labelled for 220/380 V have unlimited use in devices and installations for 230/400 V supply voltage until the end of the transition period.

DIN IEC 512 part 3: 05.94

Measurement and test procedures for electrical and mechanical components

Test 5b: Current carrying capacity (Derating curve)

DIN 43 652 part 1-3: 12.85 withdrawn

High-density connectors; square design

replaced by

DIN EN 175 301-801: 09.00

Detail Specification: High density rectangular connectors, round removable crimp contacts;

(German version EN 175 301-801: 1999)

Standards and specifications for electronic components

facts & DATA

The indicated standards and regulations are considered for the development and manufacturing of our products, as applicable.

The installation instructions are also to be followed when installing our products in devices and systems.

New nominal supply voltages 30/400 V worldwide

Since the publication of standard IEC 38 in 1983, 230/400 V has replaced 220/380 V as international value for public low-voltage networks.

The supply nominal voltage should according to this standard not exceed the values 230/400 V + 6 %/–10 %, i.e. the range between 244 V and 207 V, during the transition period up to the year 2003.

Through these defined tolerances for the optional voltage of the networks, it is possible that 220/380 V rated electrical equipment, as indicated in DIN IEC 38, can be used safely until the end of their service life.

All the considerations indicated above should be used at the existing value of 380/660 V in light of the new value of 400/690 V.

DIN VDE 0106-100/VDE 0106 part 100: 03.83

(DIN 57106-100)

Protection of electric shock;

Actuating members positioned close to parts liable to shock (VDE Specification)

DIN VDE 0106-101/ VDE 106 part 101: 11.86

Protection against electric shock;

basic requirements for protective separation

DIN EN 50 178/VDE 0160/: 04.98

Equipping of power installations with electronic equipment

EN 50 005: 1976/DIN EN 50 005: 1977-07

Low voltage switchgear and controlgear for industrial use;

Terminal marking; General rules

IEC 60 038: 1983/DIN IEC 60 038: 1987-05

(DIN 40 002)

IEC standard voltages

IEC 60 127-2: 1989/EN 60 127-2: 1991/

DIN EN 60 127-2 1996-08

Miniature fuses; part 2: cartridge fuse-links

IEC 60 255/DIN VDE 0435

(1999-01)

Electrical relays; terms and definitions

DIN EN 60529 /VDE 0470 part 1: 09.00

(IEC 61529: 1989)

Protection categories by housing (IP code)

IEC 60 742: 1983 + A1/EN 60 742: 1995/

DIN EN 60 742/VDE 0551: 1995-09

Isolating transformers and safety isolating transformers – Requirements

DIN EN 60 068-2-1: 1995-03 Environmental testing

EN 600 68-2-1: 1985-08

IEC 600 68-2-1: 1990-04

Part 2: Tests; Tests A: Cold

DIN EN 60 068-2-2: 1994-08 Basic environmental testing procedures

EN 600 68-2-2: 1993-0

IEC 600 68-2-2

Part 2: Tests – Tests B: Dry heat

facts

DIN EN 60 068-2-6: 1996-05 Environmental testing

EN 600 68-2-6: 1995-04/IEC 600 68-2-6: 1995-03

Part 2: Tests, Test Fc: Vibration (sinusoidal) (IEC 68-2-6: 1995 + Corrigendum 1995)
German version EN 60 068-2-6: 1995

DIN EN 60 068-2-32: 1995-03 Basic environmental testing procedures –

EN 600 68-2-32: 1993-04/IEC 600 68-2-32

Part 2: Tests; Test Ed: Free fall (IEC 68-2-32: 1975 + A1: 1982 + A2: 1990); German version EN 60 068-2-32: 1993

DIN EN 61 131-2/EN 61 131-2/

VDE 0411 part 500: 1995-05/IEC 61 131-2: 1992

Programmable controllers – Part 2: Equipment requirements and tests (IEC 61 131-2: 1992); German version
EN 61 131-2: 1994 + A11: 1996 + A12: 2000 + Corrigendum to EN 61 131-2: 1994 and its amendment A11: 1996

DIN EN 50 090-2-2/EN 50 090-2-2: 1996-06

VDE 0829 part 2-2: 1997-06

Home and building electronic systems (HBES) – Part 2-2: System overview – General technical requirements

DIN EN 50 170/2: 1997-07

EN 50 170: 1996-12

General purpose field communication system

EN 61 000-6-3 (2001-12) DIN EN 61 000-6-3/VDE 0839 part 6-3 (2001-12)

Electromagnetic compatibility (EMC) – Part 6-3: Generic standards; Emission standard for residential, commercial and light-industrial environments (IEC 61 000-6-3: 1996, modified)

EN 61 000-6-4 (2001-10) DIN EN 61 000-6-4/VDE 0839 part 6-4 (2001-12)

Electromagnetic compatibility (EMC) – Part 6-4: Generic standards; Emission standard for industrial environments, (IEC 61 000-6-4: 1997, modified); German version

EN 61 000-6-1 (2001-10) DIN EN 50 082-1/VDE 0839 part 82-1: 1997-11

Electromagnetic compatibility – Generic immunity standard – Part 1: Residential, commercial and light industry

IEC 61 000-6-2; 1999-01/EN 61 000-6-2 (2001-10)/DIN EN 61 000-6-2/

VDE 0839 part 6-2 (2001-12)

Electromagnetic compatibility (EMC) –
Part 6-2: Generic standards – Immunity for industrial environments (IEC 61 000-6-2: 1999)

IEC 61 000-4-2: 1995-01/EN 61 000-4-2: 1995-03/DIN EN 61 000-4-2/

VDE 0847 part 4-2: 2001-12

Electromagnetic compatibility (EMC) – Part 4: Testing and measuring techniques – Section 2: Electrostatic discharge immunity test, Basic EMC Publication (IEC 1000-4-2: 1995); German version EN 61 000-4-2: 1995

IEC 61 000-4-3: 1995/EN 61 000-4-3: 1996/DIN EN 61 000-4-3/

VDE 0847 part 4-3: 2001-12

Electromagnetic compatibility (EMC) – Part 4: Testing and measuring techniques –
Section 3: Radiated, radio-frequency electromagnetic field immunity test (IEC 1000-4-3: 1995, modified);
German version EN 61 000-4-3: 1996

IEC 61 000-4-4: 1995-01/EN 61 000-4-4: 1995-03/DIN EN 61 000-4-4/

VDE 0847 part 4-4: 2001-12

Electromagnetic compatibility (EMC) – Part 4: Testing and measuring techniques –
Section 4: Electrical test transient/burst immunity test, Basic EMC Publication (IEC 1000-4-4: 1995);
German version EN 61 000-4-4: 1995

IEC 61 000-4-5: 1995-02/EN 61 000-4-5: 1995-03/DIN EN 61 000-4-5/

VDE 0847 part 4-5: 2001-12

Electromagnetic compatibility (EMC) – Part 4: Testing and measurement techniques –
Section 5: Surge immunity test (IEC 1000-4-5: 1995);
German version EN 61 000-4-5: 1995

Standards and specifications for electronic components

facts & DATA

IEC 61 000-4-6 1996-03; EN 61 000-4-6 1996-07;

DIN EN 61 000-4-6/VDE 0847 part 4-6 2001-12

Electromagnetic compatibility (EMC) – Part 4: Testing and measuring techniques –
Section 6: Immunity to conducted disturbances, induced by radio-frequency fields (IEC 1000-4-6: 1996);
German version EN 61 000-4-6: 1996

IEC 61 000-4-11 (1994) EN 61 000-4-11 (1994-08)

DIN EN 61 000-4-11/VDE 0847 part 4-11

Electromagnetic compatibility (EMC) – Part 4: Testing and measuring techniques –
Section 11: Voltages dips, short interruptions and voltages variations immunity tests (IEC 1000-4-11: 1994);
German version EN 61 000-4-11: 1994

IEC 61 000-4-15 (1997-11) EN 61 000-4-15 (1998-04)

DIN EN 61 000-4-15/VDE 0847 part 4-15 (1998-11)

Electromagnetic compatibility (EMC) – Part 4: Testing and measurement techniques –
Section 15: Flickermeter – Functional and design specifications

IEC 61 000-3-3 (1994-12) EN 61 000-3-3 (1995-01)

DIN EN 61 000-3-3/VDE 0838 part 3 (1996-03)

Electromagnetic compatibility (EMC) – Part 3: Limits; section 3: Limitation of voltage fluctuations and
flicker in low-voltage supply systems for equipment with rated current $< \text{kleiner} \geq 16 \text{ A}$

IEC 61 000-3-2 (2000-08) EN 61 000-3-2 (1995-04)

DIN EN 61 000-3-2/VDE 0838 part 2 (1998-10)

Electromagnetic compatibility (EMC) – Part 3-2: Limits; Limits for harmonic current emissions
(equipment input current $< \text{kleiner} \geq 16 \text{ A}$ per phase)

EN 50 081-1 1992-01-00

DIN EN 50 081/VDE 0839 part 81-1 1993-03-00

Electromagnetic compatibility; generic emission standard; part 1: residential, commercial and light industry

DIN EN 55 011/VDE 0875 part 11: 2000-05

EN 55 011: 1998-03

IEC 60 255/DIN VDE 0435 (1999-01-00)

VDE 0551 = DIN EN 60742 (1995-09)

DIN EN 55 011/VDE 0875 part 11: 2000-05-00

Industrial, scientific and medical (ISM) radio-frequency equipment – Radio disturbance characteristics –
Limits and methods of measurement (IEC/CISPR 11: 1997, modified + A1: 1999);
German version EN 55 011: 1998 + A1: 1999

UL 94: 1996-10

Tests for flammability of plastic materials for parts in devices and appliances

VBG 4: 1979-04

Electric installation and equipment

COUNCIL DIRECTIVE

of 3 May 1989 on the approximation of the laws of the Member States relating to electromagnetic
compatibility (89/336/EEC)

facts

List of approval and test institutes and test laboratories

facts & DATA

BVS

BSI



BV



EPM



EIB



LCIE



LCIE-PrBer

LR

AVK-TV	Arbeitsgemeinschaft Verstärkte Kunststoffe-Techn. Vereinigung e. V., Germany
BVS	Bergbau Versuchstrecke (DMT), Germany
BSI	British Standards Institution, Great Britain
BBJ	Biuro Badawcze ds. Jakosci, Poland
BV	Bureau Veritas, France
CSA	Canadian Standards Association, Canada
CCA	CCA-NTR, CENELEC CERTIFICATION AGREEMENT-
AU	Chief Electrical Inspector, Victoria, Australia
CEBEC	Comite Electrotechnique Belge, Belgium
DEMKO	Danmarks Elektriske Materielkontrol, Denmark
DNV	Det Norske Veritas, Norway
AU-DFT	Department of Fair Trading, NSW Consumer Protection Agency, Australia
EPM	Elektrisches Prüfamt München, Germany
ESTI	Eidgenössisches Starkstrominspektorat, Switzerland
EIBA	European Installation Bus Association sc , Belgium
ELMAC	EMV Labor J. Bühne, Germany
FIMKO	Electrical Inspectorate, Finland
EZU	Electrotechnical Testing Institute, Czech Republic
DQS	Frankfurt, Germany
GL	Germanischer Lloyd, Germany
GS	Geprüfte Sicherheit, Germany
EMCC	Ingenieurbüro EMCC Dr. Rasek, Germany
MYJBP	IBU Pejabat, Jabatan Bomba dan Penyelamat, Malaysia
IMQ	Instituto Italiano del Marchio di Qualita, Italy
KEMA	Keuring van Elektrotechnische Materialen, Netherlands, KEMA-ATEX
IEL-Pr.Ber	Laboratorium Badawcze Oddz. Instyt. Elektrotechn. w Gdansk, Poland
LCIE-EEX	Laboratoire Central des Industries Electriques, France
LGA	Landesgewerbeanstalt Bayern, Germany
LCIE-PrBer	LCIE-Prüfbericht, France
LR	Lloyd's Register of Shipping, Great Britain

For more information visit us
on the internet under
www.wieland-electric.com

facts



MEEI Magyar Elektrotechnikai Ellenőrző Intézet, Hungary



NEMKO Norges Elektriske Materieellkontroll, Norway



ÖVE Österreichischer Verband für Elektrotechnik, Austria

PTB

PTB Physikalisch-Technische Bundesanstalt, Germany

BGFE Prüf-u. Zert.stelle der Berufsgen. der Feinmech. u. Elektrt., Germany

RINA

RINA Registro Italiano Navale, Italy

Belstandart White Russia

BKI-EEx

BKI-EEx Robbanásbiztos Villamos Berendezések Vizsgáló Allomása, Hungary

GOST R Russian Federation

Russ. Reg. Russ. Reg. of Shipping, Russia



SEV Schweizerischer Elektrotechnischer Verein, Switzerland

EMV-SIE Siemens AG, AUT GT 6, Germany

SEV-EEx

SEV-EEx SEV Ex-Labor „Explosionsschutz“, Switzerland



SKTC Slovak Testing Centre, Elektrotechnicky ustav a.s., Slovakia

SIQ Slovenian Institute of Quality and Metrology, Slovenia

MPA Staatliche Materialprüfungsanstalt Darmstadt, Germany



SEMKO Svenska Elektriska Materieellkontrollanstalten, Sweden

TÜV

TÜV Technischer Überwachungsverein, Germany

ASTA

ASTA The Association of Short Circuit Testing Authorities, Great Britain

Ukrdershst Ukrdershstandart, Ukraine



ULlist Underwriters Laboratories Inc.(UL Listed), USA



ULrec Underwriters Laboratories Inc.(UL Recogn.), USA

UTE Union Technique de l'Electricite, France



VDE-UG VDE Gutachten mit Fertigungsüberwachung, Germany

VDE-PB VDE Prüfbericht zur Information des Herstellers, Germany



VDE Verband Deutscher Elektrotechniker e.V., Germany

ZIK Zavod za Ispitivanje Kvalitete robe, Croatia

Approval marks for "special tests"



C UR US Underwr. Lab. Inc.(C-UL Recogn.-US), USA/Canada



C UL US Underwr. Lab. Inc.(C-UL Listed-US), USA/Canada

Table of contents, structured as per
type description and part number

contents TYPE/PART NUMBER

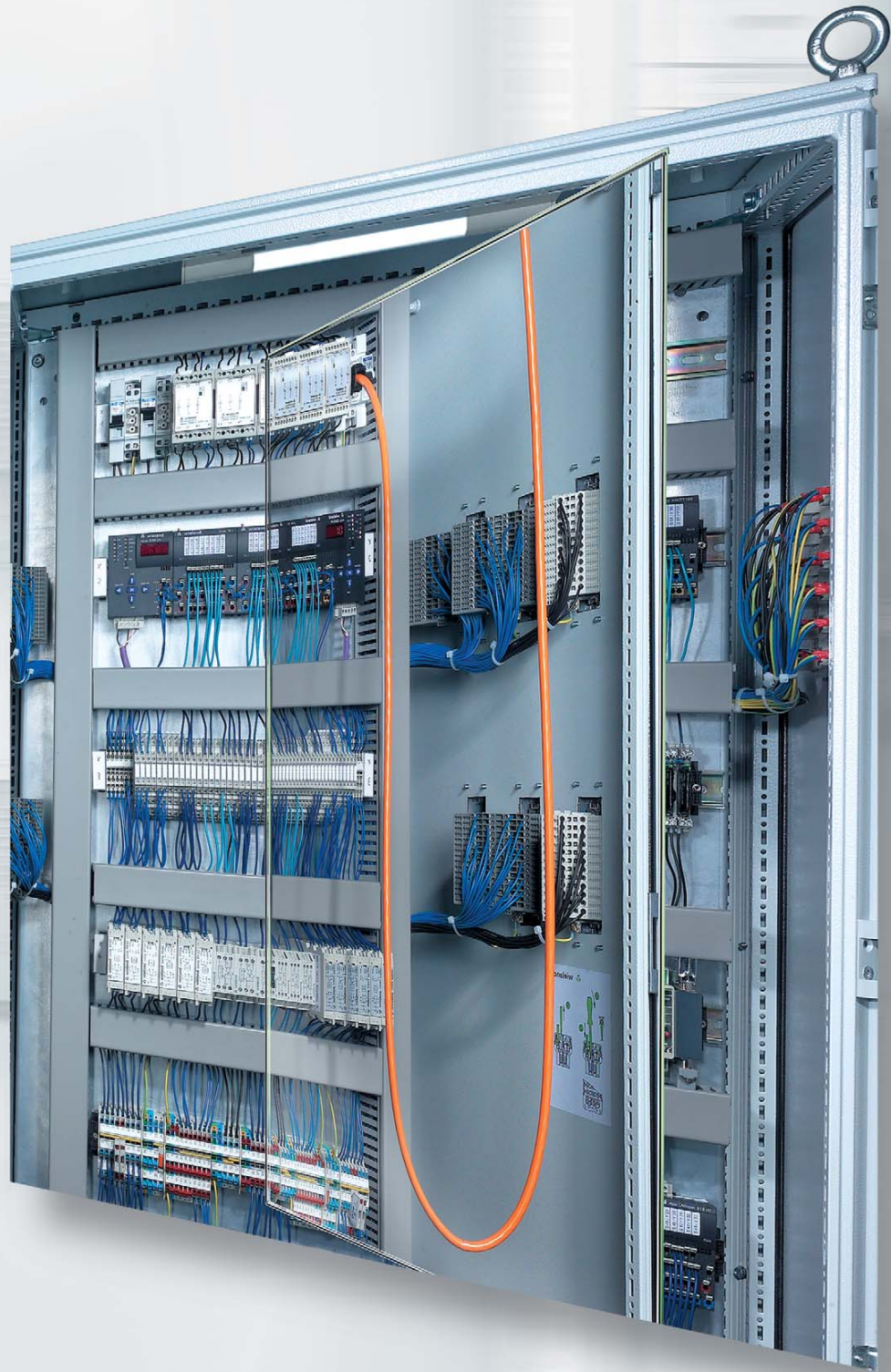

contents of
type description

contents

Type	Part no.	section / page	Type	Part no.	section / page	Type	Part no.	section / page
.0 BIS 11,0 MM	Z2.803.0228.0	210	16E / 9 DS	21.341.5953.0	259	35X27X 7,5 GELOCHT	98.300.1000.0	19
.0 BIS 11,0 MM	Z2.803.1428.0	212	16E / M BZ	04.090.1380.0	260	35X27X7,5 EN 60715 1M	98.305.1000.0	803
.5 BIS 13,5 MM	Z2.803.0328.0	210	16E / 10	21.340.6053.0	259	35X27X7,5 EN 60715 2M	98.300.0000.0	20
.5 BIS 6,5 MM	Z2.803.1328.0	212	16E / 10 DS	21.341.6053.0	259	35X27X7,5 EN 60715 2M	98.300.0000.0	308
.ADC 1 GELB	04.344.0153.8	232	16E / 12 BZ	04.090.1280.0	260	35X27X7,5 EN 60715 2M	98.300.0000.0	803
/ 70 E S35	Z2.302.0421.0	111	16E DS	21.341.6253.0	259	35X27X7,5 EN 60715 2M	98.300.0000.0	584
0.0 BIS 17,0 MM	Z2.803.1528.0	212	18 X 3 M SN 1000MM	98.291.1000.0	213	35x27x7,5 EN60715 BLANK	98.300.0010.0	46
0.2 -0.56 QMM	02.124.0900.0	683	1X 9P BUCHSE LOET	Z7.415.0010.0	756	4A	05.595.6000.0	128
0.2 -0.56 QMM	02.124.0929.0	683	1X 9P STECKER LOET	Z7.415.0235.0	756	4A	05.595.9300.0	128
0.2 -0.56 QMM	05.544.0900.0	683	1X15P BUCHSE LOET	Z7.415.0810.0	756	4E	21.304.1253.0	257
0.2 -0.56 QMM	05.544.0929.0	683	1X15P STECKER LOET	Z7.415.1035.0	756	4E / 1	21.304.0153.0	257
0.5 -0.15 QMM	02.124.1000.0	683	1X25-1X15P BUCHSE LOET	Z7.415.1810.0	756	4E / 1 DS	21.305.0153.0	257
0.5 -1.5 QMM	02.124.1029.0	683	1X25-1X15P STECKER LOET	Z7.415.2135.0	756	4E / 2	21.304.0253.0	257
0.5 -1.5 QMM	05.544.1000.0	683	1X25P BUCHSE LOET	Z7.415.1610.0	756	4E / 2 DS	21.305.0253.0	257
0.5 -1.5 QMM	05.544.1029.0	683	1X25P STECKER LOET	Z7.415.1935.0	756	4E / 3	21.304.0353.0	257
0.5 -1.5 QMM VERGOLDET	02.124.1400.0	683	1X37P BUCHSE LOET	Z7.415.2410.0	756	4E / 3 DS	21.305.0353.0	257
0.5 -1.5 QMM VERGOLDET	02.124.1429.0	683	1X37P STECKER LOET	Z7.415.2635.0	756	4E / 4	21.304.0453.0	257
0.5 -1.5 QMM VERGOLDET	05.544.1429.0	683	1X50P BUCHSE LOET	Z7.415.3210.0	756	4E / 4 DS	21.305.0453.0	257
0.5 -1.5 QMM VERGOLDET	05.544.1400.0	683	1X50P STECKER LOET	Z7.415.3335.0	756	4E / 5	21.304.0553.0	257
1027	14.230.0270.0	262	2 DIN 46284 ST	14.210.0270.0	262	4E / 5 DS	21.305.0553.0	257
1029	14.220.0370.0	262	2 D DIN 46284 ST	14.211.0270.0	262	4E / 6	21.304.0653.0	257
1031	14.220.0270.0	262	2.08 GELB	05.595.6127.0	797	4E / 6 DS	21.305.0653.0	257
1032	14.200.0270.0	262	2.5 BIS 16,5 MM	Z2.803.0428.0	210	4E / 7	21.304.0753.0	257
1032 DS	14.201.0270.0	262	2072 / 2	Z7.220.0227.0	141	4E / 7 DS	21.305.0753.0	257
1032 M 3.5	14.200.1270.0	262	2072 / 3	Z7.220.0327.0	164	4E / 8	21.304.0853.0	257
1033	14.200.0370.0	262	2072 / 4	Z7.220.0427.0	164	4E / 8 DS	21.305.0853.0	257
1033 DS	14.201.0370.0	262	2072 / 5	Z7.220.0527.0	164	4E / 9	21.304.0953.0	257
1033 A	14.200.0470.0	262	2072 / 6	Z7.220.0627.0	141	4E / 9 DS	21.305.0953.0	257
1033 A DS	14.201.0470.0	262	2072 M	Z7.210.1027.0	164	4E / 10	21.304.1053.0	257
1033 A M 3.5	14.200.1470.0	262	20A	05.595.6400.0	128	4E / 10 DS	21.305.1053.0	257
1033 AP KR	14.290.0440.0	262	20E	21.340.4253.0	259	4E / 11	21.304.1153.0	257
1033 AP DS KR	14.291.0440.0	262	20E / 1	21.340.3153.0	259	4E / 11 DS	21.305.1153.0	257
1033 M 3.5	14.200.1370.0	262	20E / 1 DS	21.341.3153.0	259	4E DS	21.305.1253.0	257
1036 R	05.590.3121.0	263	20E / 2	21.340.3253.0	259	4Q DC24V 2A	99.801.3900.9	538
1038 A	30.400.0675.0	263	20E / 2 DS	21.341.3253.0	259	50A	05.595.6700.0	128
1038 A DS	30.401.0475.0	263	20E / 3	21.340.3353.0	259	513 S / 13 W	25.647.1353.0	284
1038 B	30.400.1075.0	263	20E / 3 DS	21.341.3353.0	259	547	14.100.0170.0	261
1038 B DS	30.401.0675.0	263	20E / 4	21.340.3453.0	259	548	14.100.0270.0	261
1038 C	30.400.1675.0	263	20E / 4 DS	21.341.3453.0	259	549	14.100.0370.0	261
1038 C DS	30.401.1075.0	263	20E / 5	21.340.3553.0	259	6 X 6 1000MM	98.325.1000.0	216
1039 M	98.060.0000.0	263	20E / 5 DS	21.341.3553.0	259	6 X 6 2000MM	98.320.0000.0	716
1039 W	05.522.0725.0	263	20E / 6	21.340.3653.0	259	6/10/16 Gehaeuse-UT	25.574.0053.0	282
10A	05.595.6200.0	128	20E / 6 DS	21.341.3653.0	259	6A	05.595.6100.0	128
10A	05.595.9500.0	128	20E / 7	21.340.3753.0	259	6A	05.595.9400.0	128
10E	21.330.6253.0	259	20E / 7 DS	21.341.3753.0	259	6E	21.310.1253.0	258
10E / 1	21.330.5153.0	259	20E / 8	21.340.3853.0	259	6E / 1	21.310.0153.0	258
10E / 1 DS	21.331.5153.0	259	20E / 8 DS	21.341.3853.0	259	6E / 1 DS	21.311.0153.0	258
10E / 2	21.330.5253.0	259	20E / 9	21.340.3953.0	259	6E / 2	21.310.0253.0	258
10E / 2 BZ	04.070.0280.0	260	20E / 9 DS	21.341.3953.0	259	6E / 2 DS	21.311.0253.0	258
10E / 2 DS	21.331.5253.0	259	20E / 10	21.340.4053.0	259	6E / 3	21.310.0353.0	258
10E / 3	21.330.5353.0	259	20E / 10 DS	21.341.4053.0	259	6E / 3 DS	21.311.0353.0	258
10E / 3 BZ	04.070.0380.0	260	20E DS	21.341.4253.0	259	6E / 4	21.310.0453.0	258
10E / 3 DS	21.331.5353.0	259	2163	Z5.552.1923.0	215	6E / 4 DS	21.311.0453.0	258
10E / 4	21.330.5453.0	259	220 V AC 1 SCHLIESSER	57.800.0353.0	450	6E / 5 DS	21.311.0553.0	258
10E / 4 BZ	04.070.0480.0	260	24 Gehaeuse-UT	Z5.574.0153.0	782	6E / 6	21.310.0653.0	258
10E / 4 DS	21.331.5453.0	259	24 V 1 SCHLIESSER	57.800.0053.0	448	6E / 6 DS	21.311.0653.0	258
10E / 5	21.330.5553.0	259	24 V 2 UMSCHALTER	57.800.7053.0	449	6E / 7	21.310.0753.0	258
10E / 5 BZ	04.070.0580.0	260	24 VDC 1W	Z8.000.0056.9	454	6E / 7 DS	21.311.0753.0	258
10E / 5 DS	21.331.5553.0	259	24 VDC 2W	Z8.000.0035.5	455	6E / 8	21.310.0853.0	258
10E / 6	21.330.5653.0	259	24/48V 1 UMSCHALTER	57.800.5053.0	448	6E / 8 DS	21.311.0853.0	258
10E / 6 BZ	04.070.0680.0	260	25A	05.595.6500.0	128	6E / 9	21.310.0953.0	258
10E / 6 DS	21.331.5653.0	259	2A	05.595.5900.0	128	6E / 9 DS	21.311.0953.0	258
10E / 7	21.330.5753.0	259	2A	05.595.9200.0	128	6E / 10	21.310.1053.0	258
10E / 7 DS	21.331.5753.0	259	2X 9P BUCHSE LOET	Z7.415.0110.0	756	6E / 10 DS	21.311.1053.0	258
10E / 8	21.330.5853.0	259	2X 9P STECKER LOET	Z7.415.0335.0	756	6E DS	21.311.1253.0	258
10E / 8 DS	21.331.5853.0	259	2X15P BUCHSE LOET	Z7.415.0910.0	756	6E H	21.312.1253.0	257
10E / 9	21.330.5953.0	259	2X15P STECKER LOET	Z7.415.1135.0	756	6E H / 1	21.312.0153.0	257
10E / 9 DS	21.331.5953.0	259	2X25P BUCHSE LOET	Z7.415.1710.0	756	6E H / 1 DS	21.313.0153.0	257
10E / M BZ	04.070.1380.0	260	2X25P STECKER LOET	Z7.415.2035.0	756	6E H / 2	21.312.0253.0	257
10E / 10	21.330.6053.0	259	2X37P BUCHSE LOET	Z7.415.2510.0	756	6E H / 2 DS	21.313.0253.0	257
10E / 10 DS	21.331.6053.0	259	2X37P STECKER LOET	Z7.415.2735.0	756	6E H / 3	21.312.0353.0	257
10E / 12 BZ	04.070.1280.0	260	2X50P BUCHSE LOET	Z7.415.3410.0	756	6E H / 3 DS	21.313.0353.0	257
10E / 12 DBZ	04.071.1280.0	260	2X50P STECKER LOET	Z7.415.3535.0	756	6E H / 4	21.312.0453.0	257
10E DS	21.331.6253.0	259	3 DIN 46284 ST	14.210.0370.0	262	6E H / 4 DS	21.313.0453.0	257
110 VDC 1W	Z8.000.0181.0	456	3 D DIN 46284 ST	14.211.0370.0	262	6E H / 5	21.312.0553.0	257
110 VDC 2W	Z8.000.0176.2	458	300	90.100.0554.0	182	6E H / 5 DS	21.313.0553.0	257
110/220V 1 UMSCHALTER	57.800.5153.0	450	300 / 9708 / 2 S35	69.920.0553.0	47	6E H / 6	21.312.0653.0	257
111..BIS 000..	04.841.9050.0	395	300 B	90.100.1154.0	182	6E H / 6 DS	21.313.0653.0	257
111..BIS 000..	04.841.9050.0	791	300 B K	90.100.1354.0	182	6E H / 7	21.312.0753.0	257
111..BIS 000..	04.841.9050.0	181	300 K	90.100.1254.0	182	6E H / 7 DS	21.313.0753.0	257
13 BK / 4 TOP K OB	25.840.3453.0	292	301	90.100.0754.0	182	6E H / 8	21.312.0853.0	257
134 / 14	25.500.1453.0	360	301 K	90.100.1454.0	182	6E H / 8 DS	21.313.0853.0	257
16.0 BIS 24,0 MM	Z2.803.1628.0	212	303	90.100.0854.0	182	6E H / 9	21.312.0953.0	257
16A	05.595.6300.0	128	303 K	90.100.1554.0	182	6E H / 9 DS	21.313.0953.0	257
16E	21.340.6253.0	259	305	90.100.1054.0	182	6E H / 10	21.312.1053.0	257
16E / 1	21.340.5153.0	259	305 K	90.100.1654.0	182	6E H / 10 DS	21.313.1053.0	257
16E / 1 DS	21.341.5153.0	259	315 E	05.590.0052.0	182	6E H / 11	21.312.1153.0	257
16E / 2	21.340.5253.0	259	315 GC	90.810.3055.0	182	6E H / 11 DS	21.313.1153.0	257
16E / 2 BZ	04.090.0280.0	260	319 / 13.5 K ELFB.	90.800.1055.8	182	6E H DS	21.313.1253.0	257
16E / 2 DS	21.341.5253.0	259	319 / 13.5 K SCHW.	90.800.1055.1	182	6E SONDERA.	99.263.3521.9	258
16E / 3	21.340.5353.0	259	319 / 17.5 K ELFB.	90.800.2055.8	182	6E SONDERA.	99.263.3521.9	258
16E / 3 BZ	04.090.0380.0	260	319 / 17.5 K SCHW.	90.800.2055.1	182	6E SONDERA.	99.263.3521.9	258
16E / 3 DS	21.341.5353.0	259	35 X 24 X 15 EN 60715	98.360.0000.0	584	6E SONDERA.	99.263.3521.9	258
16E / 4	21.340.5453.0	259	35 X 24 X 15 EN 60715	98.360.0000.0	803	6E SONDERA.	99.263.3521.9	258
16E / 4 BZ	04.090.0480.0	260	35 X 24 X 15 EN 60715	98.360.0000.0	308	6E SONDERA.	99.263.3521.9	258
16E / 4 DS	21.341.5453.0	259	35 X 27 X 15	98.370.0000.0	20	6E SONDERA.	99.263.3521.9	258
16E / 5	21.340.5553.0	259	35 X 27 X 15	98.370.0000.0	803	6E SONDERA.	99.263.3521.9	258
16E / 5 BZ	04.090.0580.0	260	35 X 27 X 15	98.375.1000.0	803	6E SONDERA.	99.263.3521.9	258
16E / 5 DS	21.341.5553.0	259	35 X 27 X 15	98.370.1000.0	46	6E SONDERA.	99.263.3521.9	258
16E / 6	21.340.5653.0	259	35 X 27 X 15 GELOCHT 1M	98.370.1000.0	803	6E SONDERA.	99.263.3521.9	258
16E / 6 BZ	04.090.0680.0	260	35 X 27 X 15 GELOCHT 2M	98.370.1000.0	803	6E SONDERA.	99.263.3521.9	258
16E / 6 DS	21.341.5653.0	259	35A	05.595.6600.0	128	6E SONDERA.	99.263.3521.9	258
16E / 7								

contents

Type	Part no.	section / page	Type	Part no.	section / page	Type	Part no.	section / page
6ES / 10	22.310.1053.0	258	8105 B / 6 C1 VL OB	15.011.0653.0	383	8113 B / 5 VL	25.326.0553.0	289
7386 / 3 TOP H OB	27.714.0353.0	355	8105 B / 6 C1 VR OB	15.021.0653.0	382	8113 B / 5 VL OB	25.326.3553.0	289
7386 / 6 TOP H OB	27.714.0653.0	355	8105 B / 6 C2 OB GR	15.002.0653.0	382	8113 B / 5 VR	25.325.0553.0	289
7572 L2 / 2 OB	27.002.2253.0	376	8105 B / 6 C2 VL OB	15.012.0653.0	383	8113 B / 5 VR OB	25.325.3553.0	289
7572 L2 / 3 / 2 OB	27.002.4253.0	377	8105 B / 6 C2 VR OB	15.022.0653.0	382	8113 B / 6	25.320.0653.0	286
7572 L2 / 3 OB	27.002.2353.0	376	8105 B / 7 CO OB	15.000.0753.0	382	8113 B / 6 F	25.322.0653.0	286
7572 L2 / 5 / 3 OB	27.002.4353.0	377	8105 B / 7 CO VL OB	15.010.0753.0	383	8113 B / 6 F OB	25.322.3653.0	286
7572 L4 / 2 OB	27.002.0253.0	376	8105 B / 7 CO VR OB	15.020.0753.0	382	8113 B / 6 OB	25.320.3653.0	286
7572 L4 / 3 OB	27.002.0353.0	376	8105 B / 7 C1 OB	15.001.0753.0	382	8113 B / 6 TOP	25.220.0653.0	296
7573 L2 / 3 W OB	27.002.6353.0	375	8105 B / 7 C1 VL OB	15.011.0753.0	383	8113 B / 6 TOP LED OB	25.230.3653.0	296
7573 L2 / 4 W OB	27.002.6453.0	375	8105 B / 7 C1 VR OB	15.021.0753.0	382	8113 B / 6 TOP OB	25.220.3653.0	296
8006 / 2 BZ	04.030.0080.0	260	8105 B / 7 C2 OB	15.002.0753.0	382	8113 B / 6 VL	25.326.0653.0	289
8006 / 3 BZ	04.030.0180.0	260	8105 B / 7 C2 VL OB	15.012.0753.0	383	8113 B / 6 VL OB	25.326.3653.0	289
8006 / 4 BZ	04.030.0280.0	260	8105 B / 7 C2 VR OB	15.022.0753.0	382	8113 B / 6 VR	25.325.0653.0	289
8006 / 5 BZ	04.030.0380.0	260	8105 F / 2 G C1 OB NT	15.301.0258.9	383	8113 B / 6 VR OB	25.325.3653.0	289
8006 / 6 BZ	04.030.0480.0	260	8105 F / 2 G C2 OB NT	15.302.0258.9	383	8113 B / 7	25.320.0753.0	286
8006 / 12 BZ	04.030.1080.0	260	8105 F / 2 G C3 OB NT	15.303.0258.9	383	8113 B / 7 F	25.322.0753.0	286
8006 M BZ	04.030.1180.0	260	8105 F / 2 G C4 OB NT	15.304.0258.9	383	8113 B / 7 F OB	25.322.3753.0	286
8016 / 2 BZ	04.080.0080.0	260	8105 F / 2 G C5 OB NT	15.305.0258.9	383	8113 B / 7 OB	25.320.3753.0	286
8016 / 3 BZ	04.080.0180.0	260	8105 F / 2 G C6 OB NT	15.306.0258.9	383	8113 B / 7 TOP	25.220.0753.0	296
8016 / 4 BZ	04.080.0280.0	260	8105 F / 2 G C7 OB NT	15.307.0258.9	383	8113 B / 7 TOP LED OB	25.230.3753.0	296
8016 / 5 BZ	04.080.0380.0	260	8105 F / 2 W C1 OB NT	15.311.0258.9	383	8113 B / 7 TOP OB	25.220.3753.0	296
8016 / 6 BZ	04.080.0480.0	260	8105 F / 2 W C2 OB NT	15.312.0258.9	383	8113 B / 7 VL	25.326.0753.0	289
8016 / 12 BZ	04.080.1080.0	260	8105 F / 2 W C3 OB NT	15.313.0258.9	383	8113 B / 7 VL OB	25.326.3753.0	289
8016 M BZ	04.080.1180.0	260	8105 F / 2 W C4 OB NT	15.314.0258.9	383	8113 B / 7 VR	25.325.0753.0	289
8105 / B 2 CS VR OB	15.025.0253.0	382	8105 F / 2 W C5 OB NT	15.315.0258.9	383	8113 B / 7 VR OB	25.325.3753.0	289
8105 B / 2 CO OB	15.000.0253.0	382	8105 F / 2 W C6 OB NT	15.316.0258.9	383	8113 B / 8	25.320.0853.0	286
8105 B / 2 CO VL OB	15.010.0253.0	383	8105 F / 2 W C7 OB NT	15.317.0258.9	383	8113 B / 8 F	25.320.0853.0	286
8105 B / 2 CO VR OB	15.020.0253.0	382	8105 F / 3 G C1 OB NT	15.303.0358.9	383	8113 B / 8 F OB	25.322.3853.0	286
8105 B / 2 C1 OB	15.001.0253.0	382	8105 F / 3 G C2 OB NT	15.303.0358.9	383	8113 B / 8 OB	25.320.3853.0	286
8105 B / 2 C1 VL OB GR	15.011.0253.0	383	8105 F / 3 G C3 OB NT	15.304.0358.9	383	8113 B / 8 TOP	25.220.0853.0	296
8105 B / 2 C1 VR OB	15.021.0253.0	382	8105 F / 3 G C4 OB NT	15.305.0358.9	383	8113 B / 8 TOP LED OB	25.230.3853.0	296
8105 B / 2 C2 OB	15.002.0253.0	382	8105 F / 3 G C5 OB NT	15.306.0358.9	383	8113 B / 8 TOP OB	25.220.3853.0	296
8105 B / 2 C2 VL OB GR	15.012.0253.0	383	8105 F / 3 G C6 OB NT	15.307.0358.9	383	8113 B / 8 VL	25.326.0853.0	289
8105 B / 2 C2 VR OB GR	15.022.0253.0	382	8105 F / 3 G C7 OB NT	15.307.0358.9	383	8113 B / 8 VL OB	25.326.3853.0	289
8105 B / 2 C3 OB	15.003.0253.0	382	8105 F / 3 W C1 OB NT	15.311.0358.9	383	8113 B / 8 VR	25.325.0853.0	289
8105 B / 2 C3 VL OB	15.013.0253.0	383	8105 F / 3 W C2 OB NT	15.312.0358.9	383	8113 B / 8 VR OB	25.325.3853.0	289
8105 B / 2 C3 VR OB	15.023.0253.0	382	8105 F / 3 W C3 OB NT	15.313.0358.9	383	8113 B / 9	25.320.0953.0	286
8105 B / 2 C4 OB	15.004.0253.0	382	8105 F / 3 W C4 OB NT	15.314.0358.9	383	8113 B / 9 F	25.322.0953.0	286
8105 B / 2 C4 VL OB	15.014.0253.0	383	8105 F / 3 W C5 OB NT	15.315.0358.9	383	8113 B / 9 F OB	25.322.3953.0	286
8105 B / 2 C4 VR OB GR	15.024.0253.0	382	8105 F / 3 W C6 OB NT	15.316.0358.9	383	8113 B / 9 OB	25.320.3953.0	286
8105 B / 2 C5 OB	15.005.0253.0	382	8105 F / 3 W C7 OB NT	15.317.0358.9	383	8113 B / 9 TOP	25.220.0953.0	296
8105 B / 2 C5 VL OB	15.015.0253.0	383	8105 F / 4 G C1 OB NT	15.301.0458.9	382	8113 B / 9 TOP LED OB	25.230.3953.0	296
8105 B / 2 C5 VR OB	15.006.0253.0	382	8105 F / 4 G C2 OB NT	15.302.0458.9	382	8113 B / 9 TOP OB	25.220.3953.0	296
8105 B / 2 C6 OB	15.016.0253.0	383	8105 F / 4 G C3 OB NT	15.303.0458.9	382	8113 B / 9 VL	25.326.0953.0	289
8105 B / 2 C6 VR OB	15.026.0253.0	382	8105 F / 4 G C4 OB NT	15.304.0458.9	382	8113 B / 9 VL OB	25.326.3953.0	289
8105 B / 2 C7 OB	15.007.0253.0	382	8105 F / 4 G C5 OB NT	15.305.0458.9	382	8113 B / 9 VR	25.325.0953.0	289
8105 B / 2 C7 VL OB	15.017.0253.0	383	8105 F / 4 G C6 OB NT	15.306.0458.9	382	8113 B / 9 VR OB	25.325.3953.0	289
8105 B / 2 C7 VR OB GR	15.027.0253.0	382	8105 F / 4 W C1 OB NT	15.311.0458.9	382	8113 B / 9	25.320.1053.0	286
8105 B / 3 CO OB	15.000.0353.0	382	8105 F / 4 W C2 OB NT	15.312.0458.9	382	8113 B / 10 F	25.322.1053.0	286
8105 B / 3 CO VL OB	15.010.0353.0	383	8105 F / 4 W C3 OB NT	15.313.0458.9	382	8113 B / 10 F OB	25.322.4053.0	286
8105 B / 3 CO VR OB	15.020.0353.0	382	8105 F / 4 W C4 OB NT	15.314.0458.9	382	8113 B / 10 OB	25.320.4053.0	286
8105 B / 3 C1 OB	15.001.0353.0	382	8105 F / 4 W C5 OB NT	15.315.0458.9	382	8113 B / 10 TOP	25.220.1053.0	296
8105 B / 3 C1 VL OB	15.011.0353.0	383	8105 F / 4 W C6 OB NT	15.316.0458.9	382	8113 B / 10 TOP LED OB	25.230.4053.0	296
8105 B / 3 C1 VR OB	15.021.0353.0	382	8105 F / 5 G C1 OB NT	15.301.0558.9	382	8113 B / 10 TOP OB	25.220.4053.0	296
8105 B / 3 C2 OB	15.002.0353.0	382	8105 F / 5 G C2 OB NT	15.302.0558.9	382	8113 B / 10 VL	25.326.1053.0	289
8105 B / 3 C2 VL OB GR	15.012.0353.0	383	8105 F / 5 W C1 OB NT	15.311.0558.9	382	8113 B / 10 VL OB	25.326.4053.0	289
8105 B / 3 C2 VR OB GR	15.022.0353.0	382	8105 F / 5 W C2 OB NT	15.312.0558.9	382	8113 B / 10 VR	25.325.1053.0	289
8105 B / 3 C3 OB	15.003.0353.0	382	8105 F / 6 G C1 OB NT	15.301.0658.9	382	8113 B / 10 VR OB	25.325.4053.0	289
8105 B / 3 C3 VL OB	15.013.0353.0	383	8105 F / 6 G C2 OB NT	15.302.0658.9	382	8113 B / 11	25.320.1153.0	286
8105 B / 3 C3 VR OB GR	15.023.0353.0	382	8105 F / 6 W C1 OB NT	15.311.0658.9	382	8113 B / 11 F	25.322.1153.0	286
8105 B / 3 C4 OB	15.004.0353.0	382	8105 F / 6 W C2 OB NT	15.312.0658.9	382	8113 B / 11 F OB	25.322.4153.0	286
8105 B / 3 C4 VL OB	15.014.0353.0	383	8105 F / 7 G C1 OB NT	15.301.0758.9	382	8113 B / 11 OB	25.320.4153.0	286
8105 B / 3 C4 VR OB GR	15.024.0353.0	382	8105 F / 7 G C2 OB NT	15.302.0758.9	382	8113 B / 11 TOP	25.220.1153.0	296
8105 B / 3 C5 OB	15.005.0353.0	382	8105 F / 7 W C1 OB NT	15.311.0758.9	382	8113 B / 11 TOP LED OB	25.230.4153.0	296
8105 B / 3 C5 VL OB	15.015.0353.0	383	8105 F / 7 W C2 OB NT	15.312.0758.9	382	8113 B / 11 TOP OB	25.220.4153.0	296
8105 B / 3 C5 VR OB GR	15.025.0353.0	382	8105 F / Z W C7 OB NT	15.317.0258.9	383	8113 B / 11 VL	25.326.1153.0	289
8105 B / 3 C6 OB	15.016.0353.0	383	8113 / 16 WF OB	25.339.4653.0	299	8113 B / 11 VL OB	25.326.4153.0	289
8105 B / 3 C6 VR OB	15.006.0353.0	382	8113 B / 2	25.320.0253.0	286	8113 B / 11 VR	25.325.1153.0	289
8105 B / 3 C7 OB	15.007.0353.0	382	8113 B / 2 F	25.322.0253.0	286	8113 B / 11 VR OB	25.325.4153.0	289
8105 B / 3 C7 VL OB	15.017.0353.0	383	8113 B / 2 F OB	25.322.3253.0	286	8113 B / 12	25.320.1253.0	286
8105 B / 3 C7 VR OB	15.027.0353.0	382	8113 B / 2 OB	25.320.3253.0	286	8113 B / 12 F	25.322.1253.0	286
8105 B / 4 CO OB	15.000.0453.0	382	8113 B / 2 TOP	25.220.0253.0	296	8113 B / 12 F OB	25.322.4253.0	286
8105 B / 4 CO VL OB	15.010.0453.0	383	8113 B / 2 TOP LED OB	25.230.3253.0	296	8113 B / 12 OB	25.320.4253.0	286
8105 B / 4 CO VR OB	15.020.0453.0	382	8113 B / 2 TOP OB	25.220.3253.0	296	8113 B / 12 TOP	25.220.1253.0	296
8105 B / 4 C1 OB	15.001.0453.0	382	8113 B / 2 VL	25.326.0253.0	289	8113 B / 12 TOP LED OB	25.230.4253.0	296
8105 B / 4 C1 VL OB GR	15.011.0453.0	383	8113 B / 2 VR	25.326.3253.0	289	8113 B / 12 TOP OB	25.220.4253.0	296
8105 B / 4 C1 VR OB GR	15.021.0453.0	382	8113 B / 2 VR OB	25.325.3253.0	289	8113 B / 12 VL	25.326.1253.0	286
8105 B / 4 C2 OB	15.002.0453.0	382	8113 B / 3	25.320.0353.0	286	8113 B / 12 VL OB	25.326.4253.0	286
8105 B / 4 C2 VL OB	15.012.0453.0	383	8113 B / 3 F	25.322.0353.0	286	8113 B / 12 VR	25.325.1253.0	286
8105 B / 4 C2 VR OB	15.022.0453.0	382	8113 B / 3 F OB	25.322.3353.0	286	8113 B / 12 VR OB	25.325.4253.0	286
8105 B / 4 C3 OB	15.003.0453.0	382	8113 B / 3 OB	25.320.3353.0	286	8113 B / 13	25.320.1353.0	286
8105 B / 4 C3 VL OB	15.013.0453.0	383	8113 B / 3 TOP	25.220.0353.0	296	8113 B / 13 F	25.322.1353.0	286
8105 B / 4 C3 VR OB	15.023.0453.0	382	8113 B / 3 TOP LED OB	25.230.3353.0	296	8113 B / 13 F OB	25.322.4353.0	286
8105 B / 4 C4 OB	15.004.0453.0	382	8113 B / 3 TOP OB	25.220.3353.0	296	8113 B / 13 OB	25.320.4353.0	286
8105 B / 4 C4 VL OB	15.014.0453.0	383	8113 B / 3 VL	25.326.0353.0	289	8113 B / 13 TOP	25.220.1353.0	296
8105 B / 4 C4 VR OB GR	15.024.0453.0	382	8113 B / 3 VL OB	25.326.3353.0	289	8113 B / 13 TOP OB	25.220.4353.0	296
8105 B / 4 C5 OB	15.005.0453.0	382	8113 B / 3 VR	25.325.0353.0	289	8113 B / 13 VL	25.326.1353.0	286
8105 B / 4 C5 VL OB	15.015.0453.0	383	8113 B / 3 VR OB	25.325.3353.0	289	8113 B / 13 VL OB	25.326.4353.0	286
8105 B / 4 C5 VR OB GR	15.025.0453.0	382	8113 B / 4	25.320.0453.0	286	8113 B / 13 VR	25.325.1353.0	286
8105 B / 4 C6 OB	15.006.0453.0	382	8113 B / 4 F	25.322.0453.0	286	8113 B / 13 VR OB	25.325.4353.0	286
8105 B / 4 C6 VL OB	15.016.0453.0	383	8113 B / 4 F OB	25.322.3453.0	286	8113 B / 14	25.320.1453.0	286
8105 B / 4 C6 VR OB	15.026.0453.0	382	8113 B / 4 OB	25.320.3453.0	286	8113 B / 14 F	25.322.1453.0	286
8105 B / 5 CO OB	15.000.0553.0	382	8113 B / 4 TOP</					

contents of
type description

contents TYPE

Type	Part no.	section / page	Type	Part no.	section / page	Type	Part no.	section / page
8113 B / 15 TOP OB	25.220.4553.0	296	8113 BK / 16 OB	01.060.4653.0	291	8113 S / 15 G OB GR OF	99.215.9996.0	297
8113 B / 15 VL	25.326.1553.0	289	8113 BSK / 2 0,75 OB	25.399.9853.0	392	8113 S / 15 GF OB	25.338.4553.0	298
8113 B / 15 VL OB	25.326.4553.0	289	8113 S / 14 GOF OB	99.214.9996.0	297	8113 S / 15 S OB GR	25.394.4553.0	302
8113 B / 15 VR	25.325.1553.0	289	8113 S / 2 G OB	25.330.3253.0	297	8113 S / 15 S1 OB	25.395.4553.0	302
8113 B / 15 VR OB	25.325.4553.0	289	8113 S / 2 G OB GR OF	99.202.9996.0	297	8113 S / 15 W OB	25.332.4553.0	298
8113 B / 16	25.320.1653.0	286	8113 S / 2 GF OB	25.338.3253.0	298	8113 S / 15 W OB GR OF	99.275.9996.0	299
8113 B / 16 F	25.322.1653.0	286	8113 S / 2 S OB GR	25.394.3253.0	302	8113 S / 15 WF OB	25.339.4553.0	299
8113 B / 16 F OB	25.322.4653.0	286	8113 S / 2 S1 OB GR	25.395.3253.0	302	8113 S / 16 G OB	25.330.4653.0	297
8113 B / 16 OB	25.320.4653.0	286	8113 S / 2 W OB	25.332.3253.0	298	8113 S / 16 G OB GR OF	99.216.9996.0	297
8113 B / 16 TOP	25.220.1653.0	296	8113 S / 2 W OB GR OF	99.262.9996.0	299	8113 S / 16 GF OB	25.338.4653.0	298
8113 B / 16 TOP LED OB	25.230.4653.0	296	8113 S / 2 WF OB	25.339.3253.0	299	8113 S / 16 S OB GR	25.394.4653.0	302
8113 B / 16 TOP OB	25.220.4653.0	296	8113 S / 3 G OB	25.330.3353.0	297	8113 S / 16 S1 OB	25.395.4653.0	302
8113 B / 16 VL	25.326.1653.0	289	8113 S / 3 G OB GR OF	99.203.9996.0	297	8113 S / 16 W OB	25.332.4653.0	298
8113 B / 16 VL OB	25.326.4653.0	289	8113 S / 3 GF OB	25.338.3353.0	298	8113 S / 16 W OB GR OF	99.276.9996.0	299
8113 B / 16 VR	25.325.1653.0	289	8113 S / 3 S OB GR	25.394.3353.0	302	8113 S E / 2 G OB	25.334.3253.0	303
8113 B / 16 VR OB	25.325.4653.0	289	8113 S / 3 S1 OB	25.395.3353.0	302	8113 S E / 2 W OB	25.336.3253.0	303
8113 B / 2 SKO.75 OB	25.399.9853.8	392	8113 S / 3 W OB	25.332.3353.0	298	8113 S E / 3 G OB	25.334.3353.0	303
8113 B / 2 SKO.75 OB	25.399.9853.5	392	8113 S / 3 W OB GR OF	99.263.9996.0	299	8113 S E / 3 W OB	25.336.3353.0	303
8113 BFK / 2 TOP K	25.820.0253.0	37	8113 S / 3 WF OB	25.339.3353.0	299	8113 SEG / 5/10 G OB	27.334.0553.0	304
8113 BFK / 2 TOP K	25.820.0253.0	37	8113 S / 4 G OB	25.330.3453.0	297	8113 SEG / 5/10 W OB	27.336.0553.0	304
8113 BFK / 2 TOP K OB	25.820.3253.0	292	8113 S / 4 G OB GR OF	99.204.9996.0	297	8113 SEG / 10/20 G OB	27.334.1053.0	304
8113 BFK / 2 TOP K OB	25.820.3253.0	37	8113 S / 4 GF OB	25.338.3453.0	298	8113 SEG / 10/20 W OB	27.336.1053.0	304
8113 BFK / 3 TOP K	25.820.0353.0	292	8113 S / 4 S OB GR	25.394.3453.0	302	81195 W / 3/12 OB	25.154.2353.0	373
8113 BFK / 3 TOP K OB	25.820.3353.0	37	8113 S / 4 S1 OB	25.395.3453.0	302	8130 / 3 BZ	04.033.0180.0	260
8113 BFK / 3 TOP K OB	25.820.3353.0	292	8113 S / 4 W OB	25.332.3453.0	298	8130 / 4 BZ	04.033.0280.0	260
8113 BFK / 4 TOP K	25.820.0453.0	37	8113 S / 4 W OB GR OF	99.264.9996.0	299	8130 / 5 BZ	04.033.0380.0	260
8113 BFK / 4 TOP K OB	25.820.0453.0	292	8113 S / 4 WF OB	25.339.3453.0	299	8130 / 6 BZ	04.033.0480.0	260
8113 BFK / 4 TOP K OB	25.820.3453.0	37	8113 S / 5 G OB	25.330.3553.0	297	8130 / 12 BZ	04.033.1080.0	260
8113 BFK / 4 TOP K OB	25.820.3453.0	292	8113 S / 5 G OB GR OF	99.205.9996.0	297	8130 M BZ	04.033.1180.0	260
8113 BFK / 4 TOP K F OB	25.821.3453.0	292	8113 S / 5 GF OB	25.338.3553.0	298	8134 / 2	25.500.0253.0	360
8113 BFK / 5 TOP K	25.820.0553.0	37	8113 S / 5 S OB GR	25.394.3553.0	302	8134 / 2 OB	25.501.0253.0	360
8113 BFK / 5 TOP K OB	25.820.0553.0	292	8113 S / 5 S1 OB	25.395.3553.0	302	8134 / 2 ZN OB	25.500.6253.0	360
8113 BFK / 5 TOP K OB	25.820.3553.0	292	8113 S / 5 W OB	25.332.3553.0	298	8134 / 3	25.500.0353.0	360
8113 BFK / 5 TOP K OB	25.820.3553.0	37	8113 S / 5 W OB GR OF	99.265.9996.0	299	8134 / 3 OB	25.501.0353.0	360
8113 BFK / 6 TOP K	25.820.0653.0	292	8113 S / 5 WF OB	25.339.3553.0	299	8134 / 3 ZN	25.500.6353.0	360
8113 BFK / 6 TOP K OB	25.820.0653.0	37	8113 S / 6 G OB	25.330.3653.0	297	8134 / 3 ZN OB	25.501.6353.0	360
8113 BFK / 6 TOP K OB	25.820.3653.0	292	8113 S / 6 G OB GR OF	99.206.9996.0	297	8134 / 4	25.500.0453.0	360
8113 BFK / 6 TOP K OB	25.820.3653.0	37	8113 S / 6 GF OB	25.338.3653.0	298	8134 / 4 OB	25.501.0453.0	360
8113 BFK / 7 TOP K	25.820.0753.0	37	8113 S / 6 S OB GR	25.394.3653.0	302	8134 / 5	25.500.0553.0	360
8113 BFK / 7 TOP K OB	25.820.0753.0	292	8113 S / 6 S1 OB	25.395.3653.0	302	8134 / 5 OB	25.501.0553.0	360
8113 BFK / 7 TOP K OB	25.820.3753.0	37	8113 S / 6 W OB	25.332.3653.0	298	8134 / 6	25.500.0653.0	360
8113 BFK / 7 TOP K OB	25.820.3753.0	292	8113 S / 6 W OB GR OF	99.266.9996.0	299	8134 / 6 OB	25.501.0653.0	360
8113 BFK / 8 TOP K	25.820.0853.0	292	8113 S / 6 WF OB	25.339.3653.0	299	8134 / 7	25.500.0753.0	360
8113 BFK / 8 TOP K OB	25.820.0853.0	37	8113 S / 7 G OB	25.330.3753.0	297	8134 / 7 OB	25.501.0753.0	360
8113 BFK / 8 TOP K OB	25.820.3853.0	292	8113 S / 7 G OB GR OF	99.207.9996.0	297	8134 / 8	25.500.0853.0	360
8113 BFK / 8 TOP K OB	25.820.3853.0	37	8113 S / 7 GF OB	25.338.3753.0	298	8134 / 8 OB	25.501.0853.0	360
8113 BFK / 9 TOP K	25.820.0953.0	37	8113 S / 7 S OB GR	25.394.3753.0	302	8134 / 9	25.500.0953.0	360
8113 BFK / 9 TOP K OB	25.820.0953.0	292	8113 S / 7 S1 OB	25.395.3753.0	302	8134 / 9 OB	25.501.0953.0	360
8113 BFK / 9 TOP K OB	25.820.3953.0	292	8113 S / 7 W OB	25.332.3753.0	298	8134 / 10	25.500.1053.0	360
8113 BFK / 9 TOP K OB	25.820.3953.0	37	8113 S / 7 W OB GR OF	99.267.9996.0	299	8134 / 10 OB	25.501.1053.0	360
8113 BFK / 10 TOP K	25.820.1053.0	292	8113 S / 7 WF OB	25.339.3753.0	299	8134 / 11	25.500.1153.0	360
8113 BFK / 10 TOP K OB	25.820.1053.0	37	8113 S / 8 G OB	25.330.3853.0	297	8134 / 11 OB	25.501.1153.0	360
8113 BFK / 10 TOP K OB	25.820.4053.0	292	8113 S / 8 G OB GR OF	99.208.9996.0	297	8134 / 12	25.500.1253.0	360
8113 BFK / 11 TOP K	25.820.1153.0	37	8113 S / 8 GF OB	25.338.3853.0	298	8134 / 12 OB	25.501.1253.0	360
8113 BFK / 11 TOP K OB	25.820.1153.0	292	8113 S / 8 S OB GR	25.394.3853.0	302	8134 / 13	25.500.1353.0	360
8113 BFK / 11 TOP K OB	25.820.1153.0	292	8113 S / 8 S1 OB	25.395.3853.0	302	8134 / 13 OB	25.501.1353.0	360
8113 BFK / 11 TOP K OB	25.820.4153.0	292	8113 S / 8 W OB	25.332.3853.0	298	8134 / 14	25.500.1453.0	360
8113 BFK / 11 TOP K OB	25.820.4153.0	37	8113 S / 8 W OB GR OF	99.268.9996.0	299	8134 / 14 OB	25.501.1453.0	360
8113 BFK / 12 TOP K	25.820.1253.0	37	8113 S / 8 WF OB	25.339.3853.0	299	8134 / 15	25.500.1553.0	360
8113 BFK / 12 TOP K OB	25.820.1253.0	292	8113 S / 9 G OB	25.330.3953.0	297	8134 / 15 OB	25.501.1553.0	360
8113 BFK / 12 TOP K OB	25.820.4253.0	292	8113 S / 9 G OB GR OF	99.209.9996.0	297	8134 / 16	25.500.1653.0	360
8113 BFK / 12 TOP K OB	25.820.4253.0	37	8113 S / 9 GF OB	25.338.3953.0	298	8134 / 16 OB	25.501.1653.0	360
8113 BFK / 13 TOP K	25.820.1353.0	37	8113 S / 9 S OB GR	25.394.3953.0	302	8135 / 2	25.520.0253.0	362
8113 BFK / 13 TOP K OB	25.820.1353.0	292	8113 S / 9 S1 OB	25.395.3953.0	302	8135 / 2 OB	25.521.0253.0	362
8113 BFK / 13 TOP K OB	25.820.4353.0	37	8113 S / 9 W OB	25.332.3953.0	298	8135 / 2 ZN	25.520.6253.0	362
8113 BFK / 13 TOP K OB	25.820.4353.0	292	8113 S / 9 W OB GR OF	99.269.9996.0	299	8135 / 2 ZN OB	25.521.6253.0	362
8113 BFK / 14 TOP K	25.820.1453.0	292	8113 S / 9 WF OB	25.339.3953.0	299	8135 / 3	25.520.0353.0	362
8113 BFK / 14 TOP K OB	25.820.1453.0	37	8113 S / 10 G OB	25.330.4053.0	297	8135 / 3 OB	25.521.0353.0	362
8113 BFK / 14 TOP K OB	25.820.4453.0	292	8113 S / 10 G OB GR OF	99.210.9996.0	297	8135 / 3 ZN	25.520.6353.0	362
8113 BFK / 14 TOP K OB	25.820.4453.0	37	8113 S / 10 GF OB	25.338.4053.0	298	8135 / 3 ZN OB	25.521.6353.0	362
8113 BFK / 15 TOP K	25.820.1553.0	292	8113 S / 10 S OB GR	25.394.4053.0	302	8135 / 4	25.520.0453.0	362
8113 BFK / 15 TOP K OB	25.820.1553.0	292	8113 S / 10 S1 OB	25.395.4053.0	302	8135 / 4 OB	25.521.0453.0	362
8113 BFK / 15 TOP K OB	25.820.4553.0	292	8113 S / 10 W OB	25.332.4053.0	298	8135 / 5	25.520.0553.0	362
8113 BFK / 15 TOP K OB	25.820.4553.0	37	8113 S / 10 W OB GR OF	99.270.9996.0	299	8135 / 5 OB	25.521.0553.0	362
8113 BFK / 16 TOP K	25.820.1653.0	292	8113 S / 10 WF OB	25.339.4053.0	299	8135 / 6	25.520.0653.0	362
8113 BFK / 16 TOP K OB	25.820.1653.0	37	8113 S / 11 G OB	25.330.4153.0	297	8135 / 6 OB	25.521.0653.0	362
8113 BFK / 16 TOP K OB	25.820.4653.0	292	8113 S / 11 G OB GR OF	99.211.9996.0	297	8135 / 7	25.520.0753.0	362
8113 BFK / 16 TOP K OB	25.820.4653.0	37	8113 S / 11 GF OB	25.338.4153.0	298	8135 / 7 OB	25.521.0753.0	362
8113 BK / 2	01.060.0253.0	291	8113 S / 11 S OB GR	25.394.4153.0	302	8135 / 8	25.520.0853.0	362
8113 BK / 2 OB	01.060.3253.0	291	8113 S / 11 S1 OB	25.395.4153.0	302	8135 / 8 OB	25.521.0853.0	362
8113 BK / 3	01.060.0353.0	291	8113 S / 11 W OB	25.332.4153.0	298	8135 / 9	25.520.0953.0	362
8113 BK / 3 OB	01.060.3353.0	291	8113 S / 11 W OB GR OF	99.271.9996.0	299	8135 / 9 OB	25.521.0953.0	362
8113 BK / 4	01.060.0453.0	291	8113 S / 11 WF OB	25.339.4153.0	299	8135 / 10	25.520.1053.0	362
8113 BK / 4 OB	01.060.3453.0	291	8113 S / 12 G OB	25.330.4253.0	297	8135 / 10 OB	25.521.1053.0	362
8113 BK / 5	01.060.0553.0	291	8113 S / 12 G OB GR OF	99.212.9996.0	297	8135 / 11	25.520.1153.0	362
8113 BK / 5 OB	01.060.3553.0	291	8113 S / 12 GF OB	25.338.4253.0	298	8135 / 11 OB	25.521.1153.0	362
8113 BK / 6	01.060.0653.0	291	8113 S / 12 S OB GR	25.394.4253.0	302	8135 / 12	25.520.1253.0	362
8113 BK / 6 OB	01.060.3653.0	291	8113 S / 12 S1 OB GR	25.395.4253.0	302	8135 / 12 OB	25.521.1253.0	362
8113 BK / 7	01.060.0753.0	291	8113 S / 12 W OB	25.332.4253.0	298	8135 / 13	25.520.1353.0	362
8113 BK / 7 OB	01.060.3753.0	291	8113 S / 12 W OB GR OF	99.272.9996.0	299	8135 / 13 OB	25.521.1353.0	362
8113 BK / 8	01.060.0853.0	291	8113 S / 12 WF OB	25.339.4253.0	299	8135 / 14	25.520.1453.0	362
8113 BK / 8 OB	01.060.3853.0	291	8113 S / 13 G OB	25.330.4353.0	297	8135 / 14 OB	25.521.1453.0	362
8113 BK / 9	01.060.0953.0	291	8113 S / 13 G OB GR OF	99.213.9996.0	297	8135 / 15	25.520.1553.0	362
8113 BK / 9 OB	01.060.3953.0	291	8113 S / 13 GF OB	25.338.4353.0	298	8135 / 15 OB	25.521.1553.0	362
8113 BK / 10	01.0							

contents

Type	Part no.	section / page	Type	Part no.	section / page	Type	Part no.	section / page
8142 / 6	25.600.2653.0	318	8190 / 5	25.130.0553.0	358	8191 / 6 OB	25.161.0653.0	344
8142 / 6 OB	25.602.2653.0	318	8190 / 5 OB	25.131.0553.0	358	8191 / 6 ZW	25.160.6653.0	345
8142 / 6 / 3	25.601.1353.0	318	8190 / 6	25.130.0653.0	358	8191 / 6 ZW OB	25.161.6653.0	345
8142 / 6 / 3 OB	25.603.1353.0	318	8190 / 6 / 3	25.132.0353.0	358	8191 / 7	25.160.0753.0	344
8142 / 7	25.600.2753.0	318	8190 / 6 / 3 OB	25.133.0353.0	358	8191 / 7 OB	25.161.0753.0	344
8142 / 7 OB	25.602.2753.0	318	8190 / 6 OB	25.131.0653.0	358	8191 / 7 ZW	25.160.6753.0	345
8142 / 8	25.600.2853.0	318	8190 / 7	25.130.0753.0	358	8191 / 7 ZW OB	25.161.6753.0	345
8142 / 8 OB	25.602.2853.0	318	8190 / 7 OB	25.131.0753.0	358	8191 / 8	25.160.0853.0	344
8142 / 8 / 4	25.601.1453.0	318	8190 / 8	25.130.0853.0	358	8191 / 8 OB	25.161.0853.0	344
8142 / 8 / 4 OB	25.603.1453.0	318	8190 / 8 / 4	25.132.0453.0	358	8191 / 8 ZW	25.160.6853.0	345
8142 / 9 OB	25.602.2953.0	318	8190 / 8 / 4 OB	25.133.0453.0	358	8191 / 8 ZW OB	25.161.6853.0	345
8142 / 10	25.600.3053.0	318	8190 / 8 OB	25.131.0853.0	358	8191 / 9	25.160.0953.0	344
8142 / 10 OB	25.602.3053.0	318	8190 / 9	25.130.0953.0	358	8191 / 9 OB	25.161.0953.0	344
8142 / 10 / 5	25.601.1553.0	318	8190 / 9 OB	25.131.0953.0	358	8191 / 9 ZW	25.160.6953.0	345
8142 / 10 / 5 OB	25.603.1553.0	318	8190 / 10	25.130.1053.0	358	8191 / 9 ZW OB	25.161.6953.0	345
8142 / 11	25.600.3153.0	318	8190 / 10 / 5	25.132.0553.0	358	8191 / 10	25.160.1053.0	344
8142 / 11 OB	25.602.3153.0	318	8190 / 10 / 5 OB	25.133.0553.0	358	8191 / 10 OB	25.161.1053.0	344
8142 / 12	25.600.3253.0	318	8190 / 10 OB	25.131.1053.0	358	8191 / 10 ZW	25.160.7053.0	345
8142 / 12 OB	25.602.3253.0	318	8190 / 11	25.130.1153.0	358	8191 / 10 ZW OB	25.161.7053.0	345
8142 / 12 / 6	25.601.1653.0	318	8190 / 11 OB	25.131.1153.0	358	8191 / 11	25.160.1153.0	344
8142 / 12 / 6 OB	25.603.1653.0	318	8190 / 12	25.130.1253.0	358	8191 / 11 OB	25.161.1153.0	344
8142 / 13	25.600.3353.0	318	8190 / 12 / 6	25.132.0653.0	358	8191 / 11 ZW	25.160.7153.0	345
8142 / 13 OB	25.602.3353.0	318	8190 / 12 / 6 OB	25.133.0653.0	358	8191 / 11 ZW OB	25.161.7153.0	345
8142 / 14	25.600.3453.0	318	8190 / 12 OB	25.131.1253.0	358	8191 / 12	25.160.1253.0	344
8142 / 14 OB	25.602.3453.0	318	8190 / 13	25.130.1353.0	358	8191 / 12 OB	25.161.1253.0	344
8142 / 14 / 7	25.601.1753.0	318	8190 / 13 OB	25.131.1353.0	358	8191 / 12 ZW	25.160.7253.0	345
8142 / 14 / 7 OB	25.603.1753.0	318	8190 / 14	25.130.1453.0	358	8191 / 12 ZW OB	25.161.7253.0	345
8142 / 15	25.600.3553.0	318	8190 / 14 / 7	25.132.0753.0	358	8191 / 13	25.160.1353.0	344
8142 / 15 OB	25.602.3553.0	318	8190 / 14 / 7 OB	25.133.0753.0	358	8191 / 13 OB	25.161.1353.0	344
8142 / 16	25.600.3653.0	318	8190 / 14 OB	25.131.1453.0	358	8191 / 13 ZW	25.160.7353.0	345
8142 / 16 OB	25.602.3653.0	318	8190 / 15	25.130.1553.0	358	8191 / 13 ZW OB	25.161.7353.0	345
8142 / 16 / 8	25.601.1853.0	318	8190 / 15 OB	25.131.1553.0	358	8191 / 14	25.160.1453.0	344
8142 / 16 / 8 OB	25.603.1853.0	318	8190 / 16	25.130.1653.0	358	8191 / 14 OB	25.161.1453.0	344
8152 / 5 TOP H OB	27.730.0553.0	348	8190 / 16 / 8	25.132.0853.0	358	8191 / 14 ZW	25.160.7453.0	345
8152 / 5 TOP V OB	27.720.0553.0	348	8190 / 16 / 8 OB	25.133.0853.0	358	8191 / 14 ZW OB	25.161.7453.0	345
8152 / 10 TOP H OB	27.730.1053.0	348	8190 / 16 OB	25.131.1653.0	358	8191 / 15	25.160.1553.0	344
8152 / 10 TOP V OB	27.720.1053.0	348	8190 / 18 / 9	25.132.0953.0	358	8191 / 15 OB	25.161.1553.0	344
8158 / 2 TOP H OB	25.790.0253.0	353	8190 / 18 / 9 OB	25.133.0953.0	358	8191 / 15 ZW	25.160.7553.0	345
8158 / 2 TOP V OB	25.780.0253.0	353	8190 / 20 / 10	25.132.1053.0	358	8191 / 15 ZW OB	25.161.7553.0	345
8158 / 3 TOP H OB	25.790.0353.0	353	8190 / 20 / 10 OB	25.133.1053.0	358	8191 / 16	25.160.1653.0	344
8158 / 3 TOP V OB	25.780.0353.0	353	8190 / 22 / 11	25.132.1153.0	358	8191 / 16 OB	25.161.1653.0	344
8158 / 4 TOP H OB	25.790.0453.0	353	8190 / 22 / 11 OB	25.133.1153.0	358	8191 / 16 ZW	25.160.7653.0	345
8158 / 4 TOP V OB	25.780.0453.0	353	8190 / 24 / 12	25.132.1253.0	358	8191 / 16 ZW OB	25.161.7653.0	345
8158 / 5 TOP H OB	25.790.0553.0	353	8190 / 24 / 12 OB	25.133.1253.0	358	8191 D / 2 / 6	25.180.0253.0	370
8158 / 5 TOP V OB	25.780.0553.0	353	8190 E / 2 / 4	25.130.3253.0	368	8191 D / 2 / 6 OB	25.180.5253.0	370
8158 / 6 TOP H OB	25.790.0653.0	353	8190 E / 2 / 4 OB	25.131.3253.0	368	8191 D / 2 / 6 ZN	25.180.4253.0	370
8158 / 6 TOP V OB	25.780.0653.0	353	8190 E / 3 / 6	25.130.3353.0	368	8191 D / 2 / 6 ZN OB	25.180.9253.0	370
8158 / 7 TOP H OB	25.790.0753.0	353	8190 E / 3 / 6 OB	25.131.3353.0	368	8191 D / 3 / 9	25.180.0353.0	370
8158 / 7 TOP V OB	25.780.0753.0	353	8190 E / 4 / 8	25.130.3453.0	368	8191 D / 3 / 9 OB	25.180.5353.0	370
8158 / 8 TOP H OB	25.790.0853.0	353	8190 E / 4 / 8 OB	25.131.3453.0	368	8191 D / 3 / 9 ZN	25.180.4353.0	370
8158 / 8 TOP V OB	25.780.0853.0	353	8190 E / 5 / 10	25.130.3553.0	368	8191 D / 3 / 9 ZN OB	25.180.9353.0	370
8158 / 9 TOP H OB	25.790.0953.0	353	8190 E / 5 / 10 OB	25.131.3553.0	368	8191 D / 4 / 12	25.180.0453.0	370
8158 / 9 TOP V OB	25.780.0953.0	353	8190 E / 6 / 12	25.130.3653.0	368	8191 D / 4 / 12 OB	25.180.5453.0	370
8158 / 10 TOP H OB	25.790.1053.0	353	8190 E / 6 / 12 OB	25.131.3653.0	368	8191 D / 5 / 15	25.180.0553.0	370
8158 / 10 TOP V OB	25.780.1053.0	353	8190 E / 7 / 14	25.130.3753.0	368	8191 D / 5 / 15 OB	25.180.5553.0	370
8158 / 11 TOP H OB	25.790.1153.0	353	8190 E / 7 / 14 OB	25.131.3753.0	368	8191 D / 6 / 18	25.180.0653.0	370
8158 / 11 TOP V OB	25.780.1153.0	353	8190 E / 8 / 16	25.130.3853.0	368	8191 D / 6 / 18 OB	25.180.5653.0	370
8158 / 12 TOP H OB	25.790.1253.0	353	8190 E / 8 / 16 OB	25.131.3853.0	368	8191 D / 7 / 21	25.180.0753.0	370
8158 / 12 TOP V OB	25.780.1253.0	353	8190 E / 9 / 18	25.130.3953.0	368	8191 D / 7 / 21 OB	25.180.5753.0	370
8158 / 13 TOP H OB	25.790.1353.0	353	8190 E / 9 / 18 OB	25.131.3953.0	368	8191 D / 8 / 24	25.180.0853.0	370
8158 / 13 TOP V OB	25.780.1353.0	353	8190 E / 10 / 20	25.130.4053.0	368	8191 D / 8 / 24 OB	25.180.5853.0	370
8158 / 14 TOP H OB	25.790.1453.0	353	8190 E / 10 / 20 OB	25.131.4053.0	368	8191 D / 9 / 27 OB	25.180.5953.0	370
8158 / 14 TOP V OB	25.780.1453.0	353	8190 E / 11 / 22	25.130.4153.0	368	8191 D / 10 / 30	25.180.1053.0	370
8158 / 15 TOP H OB	25.790.1553.0	353	8190 E / 11 / 22 OB	25.131.4153.0	368	8191 D / 10 / 30 OB	25.180.6053.0	370
8158 / 15 TOP V OB	25.780.1553.0	353	8190 E / 12 / 24	25.130.4253.0	368	8191 D / 11 / 33	25.180.1153.0	370
8158 / 16 TOP H OB	25.790.1653.0	353	8190 E / 12 / 24 OB	25.131.4253.0	368	8191 D / 11 / 33 OB	25.180.6153.0	370
8158 / 16 TOP V OB	25.780.1653.0	353	8191 / 2	25.160.0253.0	344	8191 D / 12 / 36	25.180.1253.0	370
8185 TOP H	25.741.3953.0	350	8191 / 2 OB	25.161.0253.0	344	8191 D / 12 / 36 OB	25.180.6253.0	370
8185 TOP H	25.741.4153.0	350	8191 / 2 WVL OB	25.161.2853.0	594	8191 E / 2 / 4	25.178.0253.0	366
8185 TOP H	25.741.4353.0	350	8191 / 2 WVR OB	25.161.2553.0	594	8191 E / 2 / 4 OB	25.178.5253.0	366
8185 TOP H	25.741.4453.0	350	8191 / 2 ZN	25.170.0253.0	344	8191 E / 2 / 4 ZN	25.178.4253.0	366
8185 TOP H	25.741.4553.0	350	8191 / 2 ZN OB	25.171.0253.0	344	8191 E / 2 / 4 ZN OB	25.178.9253.0	366
8185 TOP V	25.741.1353.0	349	8191 / 2 ZW	25.160.6253.0	345	8191 E / 3 / 6	25.178.0353.0	366
8185 TOP V	25.741.1553.0	349	8191 / 2 ZW OB	25.161.6253.0	345	8191 E / 3 / 6 OB	25.178.5353.0	366
8185 / 1 TOP H	25.741.0153.0	350	8191 / 3	25.160.0353.0	344	8191 E / 3 / 6 ZN	25.178.4353.0	366
8185 / 1 TOP V	25.741.0053.0	349	8191 / 3 OB	25.161.0353.0	344	8191 E / 3 / 6 ZN OB	25.178.9353.0	366
8185 / 2 TOP H	25.741.3253.0	350	8191 / 3 WVL OB	25.161.2953.0	594	8191 E / 4 / 8	25.178.0453.0	366
8185 / 2 TOP V	25.741.0253.0	349	8191 / 3 WVR OB	25.161.2653.0	594	8191 E / 4 / 8 OB	25.178.5453.0	366
8185 / 3 TOP H	25.741.3353.0	350	8191 / 3 ZN	25.170.0353.0	344	8191 E / 5 / 10	25.178.0553.0	366
8185 / 3 TOP V	25.741.0353.0	349	8191 / 3 ZN OB	25.171.0353.0	344	8191 E / 5 / 10 OB	25.178.5553.0	366
8185 / 4 TOP H	25.741.3453.0	350	8191 / 3 ZW	25.160.6353.0	345	8191 E / 6 / 12	25.178.0653.0	366
8185 / 4 TOP V	25.741.0453.0	349	8191 / 3 ZW OB	25.161.6353.0	345	8191 E / 6 / 12 OB	25.178.5653.0	366
8185 / 5 TOP H	25.741.3553.0	350	8191 / 3 / 2	25.168.0253.0	344	8191 E / 7 / 14	25.178.0753.0	366
8185 / 5 TOP V	25.741.0553.0	349	8191 / 3 / 2 OB	25.169.0253.0	344	8191 E / 7 / 14 OB	25.178.5753.0	366
8185 / 6 TOP H	25.741.3653.0	350	8191 / 3 / 2 Z	25.168.2253.0	345	8191 E / 8 / 16	25.178.0853.0	366
8185 / 6 TOP V	25.741.0653.0	349	8191 / 3 / 2 Z OB	25.169.2253.0	345	8191 E / 8 / 16 OB	25.178.5853.0	366
8185 / 7 TOP H	25.741.3753.0	350	8191 / 3 / 2 ZN	25.168.6253.0	344	8191 E / 9 / 18	25.178.0953.0	366
8185 / 7 TOP V	25.741.0753.0	349	8191 / 3 / 2 ZN OB	25.169.6253.0	344	8191 E / 9 / 18 OB	25.178.5953.0	366
8185 / 8 TOP H	25.741.3853.0	350	8191 / 3 / 2 ZW	25.168.4253.0	345	8191 E / 10 / 20	25.178.1053.0	366
8185 / 8 TOP V	25.741.0853.0	349	8191 / 3 / 2 ZW OB	25.169.4253.0	345	8191 E / 10 / 20 OB	25.178.6053.0	366
8185 / 9 TOP H	25.741.0953.0	349	8191 / 4	25.160.0453.0	344	8191 E / 11 / 22	25.178.1153.0	366
8185 / 9 TOP V	25.741.4053.0	350	8191 / 4 OB	25.161.0453.0	344	8191 E / 11 / 22 OB	25.178.6153.0	366
8185 / 10 TOP H	25.741.1053.0	349	8191 / 4 ZW	25.160.6453.0	345	8191 E / 12 / 24	25.178.1253.0	366
8185 / 10 TOP V	25.741.1153.0	349	8191 / 4 ZW OB	25.161.6453.0	345	8191 E / 12 / 24 OB	25.178.6253.0	366
8185 / 11 TOP H	25.741.4253.0	350	8191 / 5	25.160.0553.0	344	8191 R / 2 / 2	25.	

contents of
type description

contents TYPE

Type	Part no.	section / page	Type	Part no.	section / page	Type	Part no.	section / page
8191 R / 6 Z OB	25.155.0653.0	342	8195 D / 3/9 VB1 OB	25.153.6353.0	372	8213 B / 6 F OB	25.323.3653.0	286
8191 R / 7 Z	25.155.2753.0	342	8195 D / 4/12	25.153.0453.0	372	8213 B / 6 OB	25.340.3653.0	286
8191 R / 7 Z OB	25.155.0753.0	342	8195 D / 4/12 OB	25.153.2453.0	372	8213 B / 6 TOP	25.240.0653.0	296
8191 R / 7/4 Z	25.157.1453.0	343	8195 D / 4/12 VB1	25.153.4453.0	372	8213 B / 6 TOP OB	25.240.3653.0	296
8191 R / 7/4 Z OB	25.157.0453.0	343	8195 D / 4/12 VB1 OB	25.153.6453.0	372	8213 B / 6 VL	25.346.0653.0	289
8191 R / 8 Z	25.155.2853.0	342	8195 D / 5/15	25.153.0553.0	372	8213 B / 6 VL OB	25.346.3653.0	289
8191 R / 8 Z OB	25.155.0853.0	342	8195 D / 5/15 OB	25.153.2553.0	372	8213 B / 6 VR	25.345.0653.0	289
8191 R / 9 Z	25.155.2953.0	342	8195 D / 5/15 VB1	25.153.4553.0	372	8213 B / 6 VR OB	25.345.3653.0	289
8191 R / 9 Z OB	25.155.0953.0	342	8195 D / 5/15 VB1 OB	25.153.6553.0	372	8213 B / 7	25.340.0753.0	286
8191 R / 9/5 Z	25.157.1553.0	343	8195 D / 6/18	25.153.0653.0	372	8213 B / 7 F	25.323.0753.0	286
8191 R / 9/5 Z OB	25.157.0553.0	343	8195 D / 6/18 OB	25.153.2653.0	372	8213 B / 7 F OB	25.323.3753.0	286
8191 R / 10 Z	25.155.3053.0	342	8195 D / 6/18 VB1	25.153.4653.0	372	8213 B / 7 OB	25.340.3753.0	286
8191 R / 10 Z OB	25.155.1053.0	342	8195 D / 6/18 VB1 OB	25.153.6653.0	372	8213 B / 7 TOP	25.240.0753.0	296
8191 R / 11 Z	25.155.3153.0	342	8195 D / 7/21	25.153.0753.0	372	8213 B / 7 TOP OB	25.240.3753.0	296
8191 R / 11 Z OB	25.155.1153.0	342	8195 D / 7/21 OB	25.153.2753.0	372	8213 B / 7 VL	25.346.0753.0	289
8191 R / 11/6 Z	25.157.1653.0	343	8195 D / 7/21 VB1	25.153.4753.0	372	8213 B / 7 VL OB	25.346.3753.0	289
8191 R / 11/6 Z OB	25.157.0653.0	343	8195 D / 7/21 VB1 OB	25.153.6753.0	372	8213 B / 7 VR OB	25.345.0753.0	289
8191 R / 12 Z	25.155.3253.0	342	8195 D / 8/24	25.153.0853.0	372	8213 B / 8	25.340.0853.0	286
8191 R / 12 Z OB	25.155.1253.0	342	8195 D / 8/24 OB	25.153.2853.0	372	8213 B / 8 F	25.323.0853.0	286
8191 R / 13 Z	25.155.3353.0	342	8195 D / 8/24 VB1	25.153.4853.0	372	8213 B / 8 F OB	25.323.3853.0	286
8191 R / 13 Z OB	25.155.1353.0	342	8195 D / 8/24 VB1 OB	25.153.6853.0	372	8213 B / 8 OB	25.340.3853.0	286
8191 R / 13/7 Z	25.157.1753.0	343	8195 D / 9/27	25.153.0953.0	372	8213 B / 8 TOP	25.240.0853.0	296
8191 R / 13/7 Z OB	25.157.0753.0	343	8195 D / 9/27 OB	25.153.2953.0	372	8213 B / 8 TOP OB	25.240.3853.0	296
8191 R / 14 Z	25.155.3453.0	342	8195 D / 9/27 VB1	25.153.4953.0	372	8213 B / 8 VL	25.346.0853.0	289
8191 R / 14 Z OB	25.155.1453.0	342	8195 D / 9/27 VB1 OB	25.153.6953.0	372	8213 B / 8 VL OB	25.346.3853.0	289
8192 / 2	25.190.0253.0	338	8195 D / 10/30	25.153.1053.0	372	8213 B / 8 VR	25.345.0853.0	289
8192 / 2 OB	25.191.0253.0	338	8195 D / 10/30 OB	25.153.3053.0	372	8213 B / 8 VR OB	25.345.3853.0	289
8192 / 2 ZN	25.190.9253.0	338	8195 D / 10/30 VB1	25.153.5053.0	372	8213 B / 9	25.340.0953.0	286
8192 / 2 ZN OB	25.191.9253.0	338	8195 D / 10/30 VB1 OB	25.153.7053.0	372	8213 B / 9 F	25.323.0953.0	286
8192 / 2 ZW OB	25.191.6253.0	338	8195 V / 2/8	25.154.0253.0	373	8213 B / 9 F OB	25.323.3953.0	286
8192 / 3	25.190.0353.0	338	8195 V / 2/8 OB	25.154.2253.0	373	8213 B / 9 OB	25.340.3953.0	286
8192 / 3 OB	25.191.0353.0	338	8195 V / 2/8 VB1	25.154.4253.0	373	8213 B / 9 TOP	25.240.0953.0	296
8192 / 3 ZN	25.190.9353.0	338	8195 V / 2/8 VB1 OB	25.154.6253.0	373	8213 B / 9 TOP OB	25.240.3953.0	296
8192 / 3 ZN OB	25.191.9353.0	338	8195 V / 3/12	25.154.0353.0	373	8213 B / 9 VL	25.346.0953.0	289
8192 / 3 ZW OB	25.191.6353.0	338	8195 V / 3/12 VB1	25.154.4353.0	373	8213 B / 9 VL OB	25.346.3953.0	289
8192 / 4	25.190.0453.0	338	8195 V / 3/12 VB1 OB	25.154.6353.0	373	8213 B / 9 VR	25.345.0953.0	289
8192 / 4 OB	25.191.0453.0	338	8195 V / 4/16	25.154.0453.0	373	8213 B / 9 VR OB	25.345.3953.0	289
8192 / 4 ZW OB	25.191.6453.0	338	8195 V / 4/16 OB	25.154.2453.0	373	8213 B / 10	25.340.1053.0	286
8192 / 5	25.190.0553.0	338	8195 V / 4/16 VB1	25.154.4453.0	373	8213 B / 10 F	25.323.1053.0	286
8192 / 5 OB	25.191.0553.0	338	8195 V / 4/16 VB1 OB	25.154.6453.0	373	8213 B / 10 F OB	25.323.4053.0	286
8192 / 5 ZW OB	25.191.6553.0	338	8195 V / 5/20	25.154.0553.0	373	8213 B / 10 OB	25.340.4053.0	286
8192 / 6	25.190.0653.0	338	8195 V / 5/20 OB	25.154.2553.0	373	8213 B / 10 S OB	27.341.4053.0	287
8192 / 6 OB	25.191.0653.0	338	8195 V / 5/20 VB1	25.154.4553.0	373	8213 B / 10 TOP	25.240.1053.0	296
8192 / 6 ZW OB	25.191.6653.0	338	8195 V / 5/20 VB1 OB	25.154.6553.0	373	8213 B / 10 TOP OB	25.240.4053.0	296
8192 / 7	25.190.0753.0	338	8195 V / 6/24	25.154.0653.0	373	8213 B / 10 VL	25.346.1053.0	289
8192 / 7 OB	25.191.0753.0	338	8195 V / 6/24 OB	25.154.2653.0	373	8213 B / 10 VL OB	25.346.4053.0	289
8192 / 7 ZW OB	25.191.6753.0	338	8195 V / 6/24 VB1	25.154.4653.0	373	8213 B / 10 VR	25.345.1053.0	289
8192 / 8	25.190.0853.0	339	8195 V / 6/24 VB1 OB	25.154.6653.0	373	8213 B / 10 VR OB	25.345.4053.0	289
8192 / 8 OB	25.191.0853.0	338	8195 V / 7/28	25.154.0753.0	373	8213 B / 11	25.340.1153.0	286
8192 / 8 ZW OB	25.191.6853.0	339	8195 V / 7/28 OB	25.154.2753.0	373	8213 B / 11 F	25.323.1153.0	286
8192 / 9	25.190.0953.0	338	8195 V / 7/28 VB1	25.154.4753.0	373	8213 B / 11 F OB	25.323.4153.0	286
8192 / 9 OB	25.191.0953.0	338	8195 V / 7/28 VB1 OB	25.154.6753.0	373	8213 B / 11 OB	25.340.4153.0	286
8192 / 9 ZW OB	25.191.6953.0	338	8195 V / 8/32	25.154.0853.0	373	8213 B / 11 TOP	25.240.1153.0	296
8192 / 10	25.190.1053.0	338	8195 V / 8/32 OB	25.154.2853.0	373	8213 B / 11 TOP OB	25.240.4153.0	296
8192 / 10 OB	25.191.1053.0	338	8195 V / 8/32 VB1	25.154.4853.0	373	8213 B / 11 VL	25.346.1153.0	289
8192 / 10 ZW OB	25.191.7053.0	339	8195 V / 8/32 VB1 OB	25.154.6853.0	373	8213 B / 11 VL OB	25.346.4153.0	289
8192 / 11	25.190.1153.0	338	8195 V / 9/36	25.154.0953.0	373	8213 B / 11 VR	25.345.1153.0	289
8192 / 11 OB	25.191.1153.0	338	8195 V / 9/36 OB	25.154.2953.0	373	8213 B / 11 VR OB	25.345.4153.0	289
8192 / 11 ZW OB	25.191.7153.0	339	8195 V / 9/36 VB1	25.154.4953.0	373	8213 B / 12	25.340.1253.0	286
8192 / 12	25.190.1253.0	338	8195 V / 9/36 VB1 OB	25.154.6953.0	373	8213 B / 12 F	25.323.1253.0	286
8192 / 12 OB	25.191.1253.0	338	8195 V / 10/40	25.154.1053.0	373	8213 B / 12 F OB	25.323.4253.0	286
8192 / 12 ZW OB	25.191.7253.0	339	8195 V / 10/40 OB	25.154.3053.0	373	8213 B / 12 OB	25.340.4253.0	286
8192 / 13	25.190.1353.0	338	8195 V / 10/40 VB1	25.154.5053.0	373	8213 B / 12 TOP	25.240.1253.0	296
8192 / 13 OB	25.191.1353.0	338	8213 B / 2	25.340.0253.0	286	8213 B / 12 TOP OB	25.240.4253.0	296
8192 / 13 ZW OB	25.191.7353.0	339	8213 B / 2 F	25.323.0253.0	286	8213 B / 12 VL	25.346.1253.0	289
8192 / 14	25.190.1453.0	338	8213 B / 2 F OB	25.323.3253.0	286	8213 B / 12 VL OB	25.346.4253.0	289
8192 / 14 OB	25.191.1453.0	338	8213 B / 2 OB	25.340.3253.0	286	8213 B / 12 VR	25.345.1253.0	289
8192 / 14 ZW OB	25.191.7453.0	339	8213 B / 2 TOP	25.240.0253.0	296	8213 B / 12 VR OB	25.345.4253.0	289
8192 / 15	25.190.1553.0	338	8213 B / 2 TOP OB	25.240.3253.0	296	8213 B / 13	25.340.1353.0	286
8192 / 15 OB	25.191.1553.0	338	8213 B / 2 VL	25.346.0253.0	289	8213 B / 13 F	25.323.1353.0	286
8192 / 15 ZW OB	25.191.7553.0	339	8213 B / 2 VL OB	25.346.3253.0	289	8213 B / 13 F OB	25.323.4353.0	286
8192 / 16	25.190.1653.0	338	8213 B / 2 VR	25.345.0253.0	289	8213 B / 13 OB	25.340.4353.0	286
8192 / 16 OB	25.191.1653.0	338	8213 B / 2 VR OB	25.345.3253.0	289	8213 B / 13 TOP	25.240.1353.0	296
8192 / 16 ZW OB	25.191.7653.0	339	8213 B / 3	25.340.0353.0	286	8213 B / 13 TOP OB	25.240.4353.0	296
8192 E / 12/24 OB	25.198.6253.0	364	8213 B / 3 F	25.323.0353.0	286	8213 B / 13 VL	25.346.1353.0	289
8192 E / 2/4	25.198.0253.0	364	8213 B / 3 F OB	25.323.3353.0	286	8213 B / 13 VL OB	25.346.4353.0	289
8192 E / 2/4 OB	25.198.5253.0	364	8213 B / 3 OB	25.340.3353.0	286	8213 B / 13 VR	25.345.1353.0	289
8192 E / 2/4 ZN	25.198.4253.0	364	8213 B / 3 TOP	25.240.0353.0	296	8213 B / 13 VR OB	25.345.4353.0	289
8192 E / 2/4 ZN OB	25.198.9253.0	364	8213 B / 3 TOP OB	25.240.3353.0	296	8213 B / 14	25.340.1453.0	286
8192 E / 3/6	25.198.0353.0	364	8213 B / 3 VL	25.346.0353.0	289	8213 B / 14 F	25.323.1453.0	286
8192 E / 3/6 OB	25.198.5353.0	364	8213 B / 3 VL OB	25.346.3353.0	289	8213 B / 14 F OB	25.323.4453.0	286
8192 E / 3/6 ZN	25.198.4353.0	364	8213 B / 3 VR	25.345.0353.0	289	8213 B / 14 OB	25.340.4453.0	286
8192 E / 3/6 ZN OB	25.198.9353.0	364	8213 B / 3 VR OB	25.345.3353.0	289	8213 B / 14 TOP	25.240.1453.0	296
8192 E / 4/8	25.198.0453.0	364	8213 B / 4	25.340.0453.0	286	8213 B / 14 TOP OB	25.240.4453.0	296
8192 E / 4/8 OB	25.198.5453.0	364	8213 B / 4 F	25.323.0453.0	286	8213 B / 14 VL	25.346.1453.0	289
8192 E / 5/10	25.198.0553.0	364	8213 B / 4 F OB	25.323.3453.0	286	8213 B / 14 VL OB	25.346.4453.0	289
8192 E / 5/10 OB	25.198.5553.0	364	8213 B / 4 OB	25.340.3453.0	286	8213 B / 14 VR	25.345.1453.0	289
8192 E / 6/12	25.198.0653.0	364	8213 B / 4 TOP	25.240.0453.0	296	8213 B / 14 VR OB	25.345.4453.0	289
8192 E / 6/12 OB	25.198.5653.0	364	8213 B / 4 TOP OB	25.240.3453.0	296	8213 B / 15	25.340.1553.0	286
8192 E / 7/14	25.198.0753.0	364	8213 B / 4 VL	25.346.0453.0	289	8213 B / 15 F	25.323.1553.0	286
8192 E / 7/14 OB	25.198.5753.0	364	8213 B / 4 VL OB	25.346.3453.0	289	8213 B / 15 F OB	25.323.4553.0	286
8192 E / 8/16	25.198.0853.0	364	8213 B / 4 VR	25.345.0453.0	289	8213 B / 15 OB	25.340.4553.0	286
8192 E / 8/16 OB	25.198.5853.0	364	8213 B / 4 VR OB	25.345.3453.0	289	8213 B / 15 TOP	25.240.1553.0	296
8192 E / 9/18	25.198.0953.0	364	8213 B / 5	25.340.0553.0	286	8213 B / 15 TOP OB	25.240.4553.0	296
8192 E / 9/18 OB								

contents

Type	Part no.	section / page	Type	Part no.	section / page	Type	Part no.	section / page
8213 B / 16 VR	25.345.1653.0	289	8213 S / 3 G OB	25.350.3353.0	297	8213 S / 12 G OB	25.350.4253.0	297
8213 B / 16 VR OB	25.345.4653.0	289	8213 S / 3 G OB GR OF	99.233.9996.1	297	8213 S / 12 G OB GR OF	99.242.9996.1	297
8213 BFK / 2 TOP K	25.840.0253.0	292	8213 S / 3 GF OB	25.359.3353.0	298	8213 S / 12 GF OB	25.359.4253.0	298
8213 BFK / 2 TOP K OB	25.840.3253.0	292	8213 S / 3 S OB GR	25.396.3353.0	302	8213 S / 12 S OB GR	25.396.4253.0	302
8213 BFK / 3 TOP K	25.840.0353.0	292	8213 S / 3 S1 OB GR	25.397.3353.0	302	8213 S / 12 S1 OB GR	25.397.4253.0	302
8213 BFK / 3 TOP K OB	25.840.3353.0	292	8213 S / 3 W OB	25.352.3353.0	298	8213 S / 12 W OB	25.352.4253.0	298
8213 BFK / 4 TOP K	25.840.0453.0	292	8213 S / 3 W OB GR OF	99.203.9996.2	299	8213 S / 12 W OB GR OF	99.212.9996.2	299
8213 BFK / 5 TOP K	25.840.0553.0	292	8213 S / 4 DFWS	25.358.3353.0	299	8213 S / 12 WF OB	25.358.4253.0	299
8213 BFK / 5 TOP K OB	25.840.3553.0	292	8213 S / 4 DFWS M	25.303.3453.0	305	8213 S / 13 DFLS	25.303.4353.0	305
8213 BFK / 6 TOP K	25.840.0653.0	292	8213 S / 4 DFWS M	25.313.3453.0	305	8213 S / 13 DFWS	25.313.4353.0	305
8213 BFK / 6 TOP K OB	25.840.3653.0	292	8213 S / 4 DFWW	25.303.0453.0	305	8213 S / 13 DFWW	25.303.1353.0	305
8213 BFK / 7 TOP K	25.840.0753.0	292	8213 S / 4 DFWW M	25.313.0453.0	305	8213 S / 13 DFWW M	25.313.1353.0	305
8213 BFK / 7 TOP K OB	25.840.3753.0	292	8213 S / 4 G OB	25.350.3453.0	297	8213 S / 13 G OB	25.350.4353.0	297
8213 BFK / 8 TOP K	25.840.0853.0	292	8213 S / 4 G OB GR OF	99.234.9996.1	297	8213 S / 13 G OB GR OF	99.243.9996.1	297
8213 BFK / 8 TOP K OB	25.840.3853.0	292	8213 S / 4 GF OB	25.359.3453.0	298	8213 S / 13 GF OB	25.359.4353.0	298
8213 BFK / 9 TOP K	25.840.0953.0	292	8213 S / 4 S OB GR	25.396.3453.0	302	8213 S / 13 S OB GR	25.396.4353.0	302
8213 BFK / 9 TOP K OB	25.840.3953.0	292	8213 S / 4 S1 OB GR	25.397.3453.0	302	8213 S / 13 S1 OB GR	25.397.4353.0	302
8213 BFK / 10 TOP K	25.840.1053.0	292	8213 S / 4 W OB	25.352.3453.0	298	8213 S / 13 W OB	25.352.4353.0	298
8213 BFK / 10 TOP K OB	25.840.4053.0	292	8213 S / 4 W OB GR OF	99.204.9996.2	299	8213 S / 13 W OB GR OF	99.213.9996.2	299
8213 BFK / 11 TOP K	25.840.1153.0	292	8213 S / 4 WF OB	25.358.3453.0	299	8213 S / 13 WF OB	25.358.4353.0	299
8213 BFK / 11 TOP K OB	25.840.4153.0	292	8213 S / 5 DFLS	25.303.3553.0	305	8213 S / 14 DFLS	25.303.4453.0	305
8213 BFK / 12 TOP K	25.840.1253.0	292	8213 S / 5 DFLS M	25.313.3553.0	305	8213 S / 14 DFLS M	25.313.4453.0	305
8213 BFK / 12 TOP K OB	25.840.4253.0	292	8213 S / 5 DFWW	25.303.0553.0	305	8213 S / 14 DFWW	25.303.1453.0	305
8213 BFK / 13 TOP K	25.840.1353.0	292	8213 S / 5 DFWW M	25.313.0553.0	305	8213 S / 14 DFWW M	25.313.1453.0	305
8213 BFK / 13 TOP K OB	25.840.4353.0	292	8213 S / 5 G OB	25.350.3553.0	297	8213 S / 14 G OB	25.350.4453.0	297
8213 BFK / 14 TOP K	25.840.1453.0	292	8213 S / 5 G OB GR OF	99.235.9996.1	297	8213 S / 14 G OB GR OF	99.244.9996.1	297
8213 BFK / 14 TOP K OB	25.840.4453.0	292	8213 S / 5 GF OB	25.359.3553.0	298	8213 S / 14 GF OB	25.359.4453.0	298
8213 BFK / 15 TOP K	25.840.1553.0	292	8213 S / 5 S OB GR	25.396.3553.0	302	8213 S / 14 S OB GR	25.396.4453.0	302
8213 BFK / 15 TOP K OB	25.840.4553.0	292	8213 S / 5 S1 OB GR	25.397.3553.0	302	8213 S / 14 S1 OB GR	25.397.4453.0	302
8213 BFK / 16 TOP K	25.840.1653.0	292	8213 S / 5 W OB	25.352.3553.0	298	8213 S / 14 W OB	25.352.4453.0	298
8213 BFK / 16 TOP K OB	25.840.4653.0	292	8213 S / 5 W OB GR OF	99.205.9996.2	299	8213 S / 14 W OB GR OF	99.214.9996.2	299
8213 BFK / 12 TOP K F	25.841.1253.0	292	8213 S / 5 WF OB	25.358.3553.0	299	8213 S / 14 WF OB	25.358.4453.0	299
8213 BL / 2 G	25.342.0253.0	295	8213 S / 6 DFLS	25.303.3653.0	305	8213 S / 15 DFLS	25.303.4553.0	305
8213 BL / 2 G OB	25.342.3253.0	295	8213 S / 6 DFLS M	25.313.3653.0	305	8213 S / 15 DFLS M	25.313.4553.0	305
8213 BL / 2 W	25.343.0253.0	295	8213 S / 6 DFWW	25.303.0653.0	305	8213 S / 15 DFWW	25.303.1553.0	305
8213 BL / 2 W OB	25.343.3253.0	295	8213 S / 6 DFWW M	25.313.0653.0	305	8213 S / 15 DFWW M	25.313.1553.0	305
8213 BL / 3 G	25.342.0353.0	295	8213 S / 6 G OB	25.350.3653.0	297	8213 S / 15 G OB	25.350.4553.0	297
8213 BL / 3 G OB	25.342.3353.0	295	8213 S / 6 G OB GR OF	99.236.9996.1	297	8213 S / 15 G OB GR OF	99.245.9996.1	297
8213 BL / 3 W	25.343.0353.0	295	8213 S / 6 GF OB	25.359.3653.0	298	8213 S / 15 GF OB	25.359.4553.0	298
8213 BL / 3 W OB	25.343.3353.0	295	8213 S / 6 S OB GR	25.396.3653.0	302	8213 S / 15 S OB GR	25.396.4553.0	302
8213 BL / 4 G	25.342.0453.0	295	8213 S / 6 S1 OB GR	25.397.3653.0	302	8213 S / 15 S1 OB GR	25.397.4553.0	302
8213 BL / 4 G OB	25.342.3453.0	295	8213 S / 6 W OB	25.352.3653.0	298	8213 S / 15 W OB	25.352.4553.0	298
8213 BL / 4 W	25.343.0453.0	295	8213 S / 6 W OB GR OF	99.206.9996.2	299	8213 S / 15 W OB GR OF	99.215.9996.2	299
8213 BL / 4 W OB	25.343.3453.0	295	8213 S / 6 WF OB	25.358.3653.0	299	8213 S / 15 WF OB	25.358.4553.0	299
8213 BL / 5 G	25.342.0553.0	295	8213 S / 7 DFLS	25.303.3753.0	305	8213 S / 16 DFLS	25.303.4653.0	305
8213 BL / 5 G OB	25.342.3553.0	295	8213 S / 7 DFLS M	25.313.3753.0	305	8213 S / 16 DFLS M	25.313.4653.0	305
8213 BL / 5 W	25.343.0553.0	295	8213 S / 7 DFWW	25.303.0753.0	305	8213 S / 16 DFWW	25.303.1653.0	305
8213 BL / 5 W OB	25.343.3553.0	295	8213 S / 7 DFWW M	25.313.0753.0	305	8213 S / 16 DFWW M	25.313.1653.0	305
8213 BL / 6 G	25.342.0653.0	295	8213 S / 7 G OB	25.350.3753.0	297	8213 S / 16 G OB	25.350.4653.0	297
8213 BL / 6 G OB	25.342.3653.0	295	8213 S / 7 G OB GR OF	99.237.9996.1	297	8213 S / 16 G OB GR OF	99.246.9996.1	297
8213 BL / 6 W	25.343.0653.0	295	8213 S / 7 GF OB	25.359.3753.0	298	8213 S / 16 GF OB	25.359.4653.0	298
8213 BL / 6 W OB	25.343.3653.0	295	8213 S / 7 S OB GR	25.396.3753.0	302	8213 S / 16 S OB GR	25.396.4653.0	302
8213 BL / 7 G OB	25.342.0753.0	295	8213 S / 7 S1 OB GR	25.397.3753.0	302	8213 S / 16 S1 OB GR	25.397.4653.0	302
8213 BL / 7 W	25.343.0753.0	295	8213 S / 7 W OB	25.352.3753.0	298	8213 S / 16 W OB	25.352.4653.0	298
8213 BL / 7 W OB	25.343.3753.0	295	8213 S / 7 W OB GR OF	99.207.9996.2	299	8213 S / 16 W OB GR OF	99.216.9996.2	299
8213 BL / 8 G	25.342.0853.0	295	8213 S / 7 WF OB	25.358.3753.0	299	8213 S / 16 WF OB	25.358.4653.0	299
8213 BL / 8 G OB	25.342.3853.0	295	8213 S / 8 DFLS	25.303.3853.0	305	8213 S / 16 WF OB GR OF	99.239.9996.1	299
8213 BL / 8 W	25.343.0853.0	295	8213 S / 8 DFLS M	25.313.3853.0	305	8213 S E / 2 G OB	25.354.3253.0	303
8213 BL / 8 W OB	25.343.3853.0	295	8213 S / 8 DFWW	25.303.0853.0	305	8213 S E / 2 W OB	25.356.3253.0	303
8213 BL / 9 G	25.342.0953.0	295	8213 S / 8 DFWW M	25.313.0853.0	305	8213 S E / 3 G OB	25.354.3353.0	303
8213 BL / 9 W	25.343.0953.0	295	8213 S / 8 G OB	25.350.3853.0	297	8213 S E / 3 W OB	25.356.3353.0	303
8213 BL / 9 W OB	25.343.3953.0	295	8213 S / 8 G OB GR OF	99.238.9996.1	297	8213 SEG / 5/10 G OB	27.354.0553.0	304
8213 BL / 10 G	25.342.1053.0	295	8213 S / 8 GF OB	25.359.3853.0	298	8213 SEG / 5/10 W OB	27.356.0553.0	304
8213 BL / 10 G OB	25.342.4053.0	295	8213 S / 8 S OB GR	25.396.3853.0	302	8213 SEG / 10/20 G OB	27.354.1053.0	304
8213 BL / 10 W	25.343.1053.0	295	8213 S / 8 S1 OB GR	25.397.3853.0	302	8213 SEG / 10/20 W OB	27.356.1053.0	304
8213 BL / 10 W OB	25.343.4053.0	295	8213 S / 8 W OB	25.352.3853.0	298	8213 SUFK / 2 TOP	25.857.0253.0	293
8213 BL / 11 G	25.342.1153.0	295	8213 S / 8 W OB GR OF	99.208.9996.2	299	8213 SUFK / 2 TOP OB	25.857.3253.0	293
8213 BL / 11 G OB	25.342.4153.0	295	8213 S / 8 WF OB	25.358.3853.0	299	8213 SUFK / 3 TOP	25.857.0353.0	293
8213 BL / 11 W	25.343.1153.0	295	8213 S / 9 DFLS	25.303.3953.0	305	8213 SUFK / 3 TOP OB	25.857.3353.0	293
8213 BL / 11 W OB	25.343.4153.0	295	8213 S / 9 DFLS M	25.313.3953.0	305	8213 SUFK / 4 TOP	25.857.0453.0	293
8213 BL / 12 G	25.342.1253.0	295	8213 S / 9 DFWW	25.303.0953.0	305	8213 SUFK / 4 TOP OB	25.857.3453.0	293
8213 BL / 12 G OB	25.342.4253.0	295	8213 S / 9 DFWW M	25.313.0953.0	305	8213 SUFK / 5 TOP	25.857.0553.0	293
8213 BL / 12 W	25.343.1253.0	295	8213 S / 9 G OB	25.350.3953.0	297	8213 SUFK / 5 TOP OB	25.857.3553.0	293
8213 BL / 12 W OB	25.343.4253.0	295	8213 S / 9 GF OB	25.359.3953.0	298	8213 SUFK / 6 TOP	25.857.0653.0	293
8213 BL / 13 G	25.342.1353.0	295	8213 S / 9 S OB GR	25.396.3953.0	302	8213 SUFK / 6 TOP OB	25.857.3653.0	293
8213 BL / 13 G OB	25.342.4353.0	295	8213 S / 9 S1 OB GR	25.397.3953.0	302	8213 SUFK / 7 TOP	25.857.0753.0	293
8213 BL / 13 W	25.343.1353.0	295	8213 S / 9 W OB	25.352.3953.0	298	8213 SUFK / 7 TOP OB	25.857.3753.0	293
8213 BL / 13 W OB	25.343.4353.0	295	8213 S / 9 W OB GR OF	99.209.9996.2	299	8213 SUFK / 8 TOP	25.857.0853.0	293
8213 BL / 14 G	25.342.1453.0	295	8213 S / 9 WF OB	25.358.3953.0	299	8213 SUFK / 8 TOP OB	25.857.3853.0	293
8213 BL / 14 G OB	25.342.4453.0	295	8213 S / 10 DFLS	25.303.4053.0	305	8213 SUFK / 9 TOP	25.857.0953.0	293
8213 BL / 14 W	25.343.1453.0	295	8213 S / 10 DFLS M	25.313.4053.0	305	8213 SUFK / 9 TOP OB	25.857.3953.0	293
8213 BL / 14 W OB	25.343.4453.0	295	8213 S / 10 DFWW	25.303.1053.0	305	8213 SUFK / 10 TOP	25.857.1053.0	293
8213 BL / 15 G	25.342.1553.0	295	8213 S / 10 DFWW M	25.313.1053.0	305	8213 SUFK / 10 TOP OB	25.857.4053.0	293
8213 BL / 15 G OB	25.342.4553.0	295	8213 S / 10 G OB	25.350.4053.0	297	8213 SUFK / 11 TOP	25.857.1153.0	293
8213 BL / 15 W	25.343.1553.0	295	8213 S / 10 G OB GR OF	99.240.9996.1	297	8213 SUFK / 11 TOP OB	25.857.4153.0	293
8213 BL / 15 W OB	25.343.4553.0	295	8213 S / 10 GF OB	25.359.4053.0	298	8213 SUFK / 12 TOP	25.857.1253.0	293
8213 BL / 16 G	25.342.1653.0	295	8213 S / 10 S OB GR	25.396.4053.0	302	8213 SUFK / 12 TOP OB	25.857.4253.0	293
8213 BL / 16 G OB	25.342.4653.0	295	8213 S / 10 S1 OB GR	25.397.4053.0	302	8213 SUFK / 13 TOP	25.857.1353.0	293
8213 BL / 16 W	25.343.1653.0	295	8213 S / 10 W OB	25.352.4053.0	298	8213 SUFK / 13 TOP OB	25.857.4353.0	293
8213 BL / 16 W OB	25.343.4653.0	295	8213 S / 10 W OB GR OF	99.210.9996.2	299	8213 SUFK / 14 TOP	25.857.1453.0	293
8213 S / 2 DFWW	25.303.0253.0	305	8213 S / 10 WF OB	25.358.4053.0	299	8213 SUFK / 14 TOP OB	25.857.4453.0	293
8213 S / 2 DFLS	25.303.3253.0	305	8213 S / 11 DFLS	25.303.4153.0	305	8213 SUFK / 15 TOP	25.857.1553.0	293
8213 S / 2 DFLS M	25.313.3253.0	305	8213 S / 11 DFLS M	25.313.4153.0	305	8213 SUFK / 15 TOP OB	25.857.4553.0	293
8213 S / 2 DFWW M	25.3							

contents of
type description

contents TYPE

Type	Part no.	section / page	Type	Part no.	section / page	Type	Part no.	section / page
8234 / 3 ZN OB	25.503.6353.0	360	8285/ 3 TOP H	25.751.3353.0	350	8291 E / 3 / 6	25.179.0353.0	366
8234 / 4	25.502.0453.0	360	8285/ 3 TOP V	25.751.0353.0	349	8291 E / 3 / 6 OB	25.179.5353.0	366
8234 / 4 OB	25.503.0453.0	360	8285/ 4 TOP H	25.751.3453.0	350	8291 E / 3 / 6 ZN	25.179.4353.0	366
8234 / 5	25.502.0553.0	360	8285/ 4 TOP V	25.751.0453.0	349	8291 E / 3 / 6 ZN OB	25.179.9353.0	366
8234 / 5 OB	25.503.0553.0	360	8285/ 5 TOP H	25.751.3553.0	350	8291 E / 4 / 8	25.179.0453.0	366
8234 / 6	25.502.0653.0	360	8285/ 5 TOP V	25.751.0553.0	349	8291 E / 4 / 8 OB	25.179.5453.0	366
8234 / 6 OB	25.503.0653.0	360	8285/ 6 TOP H	25.751.3653.0	350	8291 E / 5 / 10	25.179.0553.0	366
8234 / 7	25.502.0753.0	360	8285/ 6 TOP V	25.751.0653.0	349	8291 E / 5 / 10 OB	25.179.5553.0	366
8234 / 7 OB	25.503.0753.0	360	8285/ 8 TOP H	25.751.0853.0	349	8291 E / 6 / 12	25.179.0653.0	366
8234 / 8	25.502.0853.0	360	8285/ 10 TOP H	25.751.4053.0	350	8291 E / 6 / 12 OB	25.179.5653.0	366
8234 / 8 OB	25.503.0853.0	360	8285/ 10 TOP V	25.751.1053.0	349	8291 E / 7 / 12	25.179.0753.0	366
8234 / 9	25.502.0953.0	360	8285/ 12 TOP V	25.751.1253.0	349	8291 E / 7 / 14 OB	25.179.5753.0	366
8234 / 9 OB	25.503.0953.0	360	8285/ 15 TOP V	25.751.1553.0	349	8291 E / 8 / 16	25.179.0853.0	366
8234 / 10	25.502.1053.0	360	8285/ 16 TOP H	25.751.4653.0	350	8291 E / 9 / 18	25.179.0953.0	366
8234 / 10 OB	25.503.1053.0	360	8291 / 2	25.162.0253.0	344	8291 E / 10 / 20	25.179.1053.0	366
8234 / 11 OB	25.503.1153.0	360	8291 / 2 OB	25.163.0253.0	344	8291 E / 10 / 20 OB	25.179.6053.0	366
8234 / 12	25.502.1253.0	360	8291 / 2 ZN	25.172.0253.0	344	8291 E / 11 / 22	25.179.1153.0	366
8234 / 12 OB	25.503.1253.0	360	8291 / 2 ZN OB	25.173.0253.0	344	8291 E / 11 / 22 OB	25.179.6153.0	366
8234 / 13 OB	25.503.1353.0	360	8291 / 2 ZW	25.162.6253.0	345	8291 E / 12 / 24	25.179.1253.0	366
8234 / 14	25.502.1453.0	360	8291 / 2 ZW OB	25.163.6253.0	345	8291 E / 12 / 24 OB	25.179.6253.0	366
8234 / 14 OB	25.503.1453.0	360	8291 / 3	25.162.0353.0	344	8291 E / 8 / 16 OB	25.179.5853.0	366
8234 / 15 OB	25.503.1553.0	360	8291 / 3 OB	25.163.0353.0	344	8291 E / 9 / 18 OB	25.179.5953.0	366
8234 / 16 OB	25.503.1653.0	360	8291 / 3 ZN	25.172.0353.0	344	8291 R / 2 / 2	25.166.2253.0	342
8235 / 2	25.522.0253.0	362	8291 / 3 ZN OB	25.173.0353.0	344	8291 R / 2 / 2 OB	25.166.0253.0	342
8235 / 2 OB	25.523.0253.0	362	8291 / 3 ZW	25.162.6353.0	345	8291 R / 3 / 2	25.166.2353.0	342
8235 / 2 ZN	25.522.6253.0	362	8291 / 3 ZW OB	25.163.6353.0	345	8291 R / 3 / 2 OB	25.166.0353.0	342
8235 / 2 ZN OB	25.523.6253.0	362	8291 / 4	25.162.0453.0	344	8291 R / 3 / 2 Z	25.167.5253.0	343
8235 / 3	25.522.0353.0	362	8291 / 4 OB	25.163.0453.0	344	8291 R / 3 / 2 Z OB	25.167.4253.0	343
8235 / 3 OB	25.523.0353.0	362	8291 / 4 ZW	25.162.6453.0	345	8291 R / 4 / 2	25.166.2453.0	342
8235 / 3 ZN	25.522.6353.0	362	8291 / 4 ZW OB	25.163.6453.0	345	8291 R / 5 / 2	25.166.2553.0	342
8235 / 3 ZN OB	25.523.6353.0	362	8291 / 5	25.162.0553.0	344	8291 R / 5 / 2 OB	25.166.0553.0	342
8235 / 4	25.522.0453.0	362	8291 / 5 OB	25.163.0553.0	344	8291 R / 5 / 3 Z	25.157.5353.0	343
8235 / 4 OB	25.523.0453.0	362	8291 / 5 ZW	25.162.6553.0	345	8291 R / 5 / 3 Z OB	25.157.4353.0	343
8235 / 5	25.522.0553.0	362	8291 / 5 ZW OB	25.163.6553.0	345	8291 R / 6 / 2	25.166.2653.0	342
8235 / 5 OB	25.523.0553.0	362	8291 / 6	25.162.0653.0	344	8291 R / 6 / 2 OB	25.166.0653.0	342
8235 / 6	25.522.0653.0	362	8291 / 6 OB	25.163.0653.0	344	8291 R / 7 / 2	25.166.2753.0	342
8235 / 6 OB	25.523.0653.0	362	8291 / 6 ZW	25.162.6653.0	345	8291 R / 7 / 2 OB	25.166.0753.0	342
8235 / 7	25.522.0753.0	362	8291 / 6 ZW OB	25.163.6653.0	345	8291 R / 7 / 4 Z	25.157.5453.0	343
8235 / 7 OB	25.523.0753.0	362	8291 / 7	25.162.0753.0	344	8291 R / 7 / 4 Z OB	25.157.4453.0	343
8235 / 8	25.522.0853.0	362	8291 / 7 OB	25.163.0753.0	344	8291 R / 8 / 2	25.166.2853.0	342
8235 / 8 OB	25.523.0853.0	362	8291 / 7 ZW	25.162.6753.0	345	8291 R / 8 / 2 OB	25.166.0853.0	342
8235 / 9	25.522.0953.0	362	8291 / 7 ZW OB	25.163.6753.0	345	8291 R / 9 / 2	25.166.2953.0	342
8235 / 9 OB	25.523.0953.0	362	8291 / 8	25.162.0853.0	344	8291 R / 9 / 2 OB	25.166.0953.0	342
8235 / 10	25.522.1053.0	362	8291 / 8 OB	25.163.0853.0	344	8291 R / 9 / 5 Z	25.157.5553.0	343
8235 / 10 OB	25.523.1053.0	362	8291 / 8 ZW	25.162.6853.0	345	8291 R / 9 / 5 Z OB	25.157.4553.0	343
8235 / 11	25.522.1153.0	362	8291 / 8 ZW OB	25.163.6853.0	345	8291 R / 10 / 2	25.166.3053.0	342
8235 / 11 OB	25.523.1153.0	362	8291 / 9	25.162.0953.0	344	8291 R / 10 / 2 OB	25.166.1053.0	342
8235 / 12	25.522.1253.0	362	8291 / 9 OB	25.163.0953.0	344	8291 R / 11 / 2	25.166.3153.0	342
8235 / 12 OB	25.523.1253.0	362	8291 / 9 ZW	25.162.6953.0	345	8291 R / 11 / 2 OB	25.166.1153.0	342
8235 / 13	25.522.1353.0	362	8291 / 9 ZW OB	25.163.6953.0	345	8291 R / 11 / 6 Z	25.157.5653.0	343
8235 / 13 OB	25.523.1353.0	362	8291 / 10	25.162.1053.0	344	8291 R / 11 / 6 Z OB	25.157.4653.0	343
8235 / 14	25.522.1453.0	362	8291 / 10 OB	25.163.1053.0	344	8291 R / 12 / 2	25.166.3253.0	342
8235 / 14 OB	25.523.1453.0	362	8291 / 10 ZW	25.162.7053.0	345	8291 R / 12 / 2 OB	25.166.1253.0	342
8235 / 15	25.522.1553.0	362	8291 / 10 ZW OB	25.163.7053.0	345	8291 R / 13 / 2	25.166.3353.0	342
8235 / 15 OB	25.523.1553.0	362	8291 / 11	25.162.1153.0	344	8291 R / 13 / 2 OB	25.166.1353.0	342
8235 / 16	25.522.1653.0	362	8291 / 11 OB	25.163.1153.0	344	8291 R / 13 / 7 Z	25.157.5753.0	343
8235 / 16 OB	25.523.1653.0	362	8291 / 11 ZW	25.162.7153.0	345	8291 R / 14 / 2	25.166.3453.0	342
8258 / 2 TOP H OB	25.791.0253.0	353	8291 / 11 ZW OB	25.163.7153.0	345	8291 R / 14 / 2 OB	25.166.1453.0	342
8258 / 2 TOP V OB	25.781.0253.0	353	8291 / 12	25.162.1253.0	344	8291 R / 4 Z OB	25.166.0453.0	342
8258 / 3 TOP H OB	25.791.0353.0	353	8291 / 12 OB	25.163.1253.0	344	8291R / 13 / 7 Z OB	25.157.4753.0	343
8258 / 3 TOP V OB	25.781.0353.0	353	8291 / 12 ZW	25.162.7253.0	345	8292 / 2	25.192.0253.0	338
8258 / 4 TOP H OB	25.791.0453.0	353	8291 / 12 ZW OB	25.163.7253.0	345	8292 / 2 OB	25.193.0253.0	338
8258 / 4 TOP V OB	25.781.0453.0	353	8291 / 13	25.162.1353.0	344	8292 / 2 ZN	25.192.9253.0	338
8258 / 5 TOP H OB	25.791.0553.0	353	8291 / 13 OB	25.163.1353.0	344	8292 / 2 ZN OB	25.193.9253.0	338
8258 / 5 TOP V OB	25.791.0653.0	353	8291 / 13 ZW OB	25.163.7353.0	345	8292 / 2 ZW OB	25.193.6253.0	339
8258 / 7 TOP H OB	25.791.0753.0	353	8291 / 14	25.162.1453.0	344	8292 / 3	25.192.0353.0	338
8258 / 7 TOP V OB	25.781.0753.0	353	8291 / 14 OB	25.163.1453.0	344	8292 / 3 OB	25.193.0353.0	338
8258 / 8 TOP H OB	25.791.0853.0	353	8291 / 14 ZW	25.162.7453.0	345	8292 / 3 ZN	25.192.9353.0	338
8258 / 8 TOP V OB	25.781.0853.0	353	8291 / 14 ZW OB	25.163.7453.0	345	8292 / 3 ZN OB	25.193.9353.0	338
8258 / 9 TOP H OB	25.791.0953.0	353	8291 / 15	25.162.1553.0	344	8292 / 3 ZW OB	25.193.6353.0	339
8258 / 9 TOP V OB	25.781.0953.0	353	8291 / 15 OB	25.163.1553.0	344	8292 / 4	25.192.0453.0	338
8258 / 10 TOP H OB	25.791.1053.0	353	8291 / 15 ZW	25.162.7553.0	345	8292 / 4 OB	25.193.0453.0	338
8258 / 10 TOP V OB	25.781.1053.0	353	8291 / 15 ZW OB	25.163.7553.0	345	8292 / 4 ZW OB	25.193.6453.0	339
8258 / 11 TOP H OB	25.791.1153.0	353	8291 / 16	25.162.1653.0	344	8292 / 5	25.192.0553.0	338
8258 / 11 TOP V OB	25.781.1153.0	353	8291 / 16 OB	25.163.1653.0	344	8292 / 5 OB	25.193.0553.0	338
8258 / 12 TOP H OB	25.791.1253.0	353	8291 / 16 ZW	25.162.7653.0	345	8292 / 5 ZW OB	25.193.6553.0	339
8258 / 12 TOP V OB	25.781.1253.0	353	8291 / 16 ZW OB	25.163.7653.0	345	8292 / 6	25.192.0653.0	338
8258 / 13 TOP H OB	25.791.1353.0	353	8291 D / 2 / 6	25.181.0253.0	370	8292 / 6 OB	25.193.0653.0	338
8258 / 13 TOP V OB	25.781.1353.0	353	8291 D / 2 / 6 OB	25.181.5253.0	370	8292 / 6 ZW OB	25.193.6653.0	339
8258 / 14 TOP H OB	25.791.1453.0	353	8291 D / 2 / 6 ZN	25.181.4253.0	370	8292 / 7	25.192.0753.0	338
8258 / 14 TOP V OB	25.781.1453.0	353	8291 D / 2 / 6 ZN OB	25.181.9253.0	370	8292 / 7 OB	25.193.0753.0	338
8258 / 15 TOP H OB	25.791.1553.0	353	8291 D / 3 / 9	25.181.0353.0	370	8292 / 7 ZW OB	25.193.6753.0	339
8258 / 15 TOP V OB	25.781.1553.0	353	8291 D / 3 / 9 OB	25.181.5353.0	370	8292 / 8	25.192.0853.0	338
8258 / 16 TOP H OB	25.791.1653.0	353	8291 D / 3 / 9 ZN	25.181.4353.0	370	8292 / 8 OB	25.193.0853.0	338
8258 / 16 TOP V OB	25.781.1653.0	353	8291 D / 3 / 9 ZN OB	25.181.9353.0	370	8292 / 8 ZW OB	25.193.6853.0	339
8258 / 5 TOP V OB	25.781.0553.0	353	8291 D / 4 / 12	25.181.0453.0	370	8292 / 9	25.192.0953.0	338
8258 / 6 TOP V OB	25.781.0653.0	353	8291 D / 4 / 12 OB	25.181.5453.0	370	8292 / 9 OB	25.193.0953.0	338
8276	25.720.1353.0	378	8291 D / 5 / 15	25.181.0553.0	370	8292 / 9 ZW OB	25.193.6953.0	339
8276 TKS	25.720.1453.0	378	8291 D / 5 / 15 OB	25.181.5553.0	370	8292 / 10	25.192.1053.0	338
8285 TOP H	25.751.3753.0	350	8291 D / 6 / 18	25.181.0653.0	370	8292 / 10 OB	25.193.1053.0	338
8285 TOP H	25.751.3853.0	350	8291 D / 6 / 18 OB	25.181.5653.0	370	8292 / 10 ZW OB	25.193.7053.0	339
8285 TOP H	25.751.3953.0	350	8291 D / 7 / 21	25.181.0753.0	370	8292 / 11	25.192.1153.0	338
8285 TOP H	25.751.4153.0	350	8291 D / 7 / 21 OB	25.181.5753.0	370	8292 / 11 OB	25.193.1153.0	338
8285 TOP H	25.751.4253.0	350	8291 D / 8 / 24	25.181.0853.0	370	8292 / 11 ZW OB	25.193.7153.0	339
8285 TOP H	25.751.4353.0	350	8291 D / 8 / 24 OB	25.181.5853.0	370	8292 / 12	25.192.1253.0	338
8285 TOP H	25.751.4453.0	350	8291 D / 9 / 27	25.181.0953.0				

contents

Type	Part no.	section / page	Type	Part no.	section / page	Type	Part no.	section / page
8292 / 16 OB	25.193.1653.0	338	8313 S / 9 GF OB	25.374.6953.0	300	8413 B / 2 VR OB	25.385.2253.0	290
8292 / 16 ZW OB	25.193.7653.0	339	8313 S / 9 W OB	25.372.3953.0	301	8413 B / 3	25.380.0353.0	288
8292 DH / 2 OB	27.000.4253.0	340	8313 S / 9 WF OB	25.374.2953.0	301	8413 B / 3 F	25.324.4353.0	288
8292 DH / 3 OB	27.000.4353.0	340	8313 S / 10 G OB	25.370.4053.0	300	8413 B / 3 F OB	25.324.6353.0	288
8292 E / 2 / 4	25.199.0253.0	364	8313 S / 10 GF OB	25.374.7053.0	300	8413 B / 3 OB	25.380.3353.0	288
8292 E / 2 / 4 OB	25.199.5253.0	364	8313 S / 10 W OB	25.372.4053.0	301	8413 B / 3 VL	25.386.0353.0	290
8292 E / 2 / 4 ZN	25.199.4253.0	364	8313 S / 10 WF OB	25.374.3053.0	301	8413 B / 3 VL OB	25.386.2353.0	290
8292 E / 2 / 4 ZN OB	25.199.9253.0	364	8313 S / 11 G OB	25.370.4153.0	300	8413 B / 3 VR	25.385.0353.0	290
8292 E / 3 / 6	25.199.0353.0	364	8313 S / 11 GF OB	25.374.7153.0	300	8413 B / 3 VR OB	25.385.2353.0	290
8292 E / 3 / 6 OB	25.199.5353.0	364	8313 S / 11 W OB	25.372.4153.0	301	8413 B / 4	25.380.0453.0	288
8292 E / 3 / 6 ZN	25.199.4353.0	364	8313 S / 11 WF OB	25.374.3153.0	301	8413 B / 4 F	25.324.4453.0	288
8292 E / 3 / 6 ZN OB	25.199.9353.0	364	8313 S / 12 G OB	25.370.4253.0	300	8413 B / 4 F OB	25.324.6453.0	288
8292 E / 4 / 8	25.199.0453.0	364	8313 S / 12 GF OB	25.374.7253.0	300	8413 B / 4 OB	25.380.3453.0	288
8292 E / 4 / 8 OB	25.199.5453.0	364	8313 S / 12 W OB	25.372.4253.0	301	8413 B / 4 VL	25.386.0453.0	290
8292 E / 5 / 10	25.199.0553.0	364	8313 S / 12 WF OB	25.374.3253.0	301	8413 B / 4 VL OB	25.386.2453.0	290
8292 E / 5 / 10 OB	25.199.5553.0	364	8358 / 2 TOP H OB	25.792.0253.0	354	8413 B / 4 VR	25.385.0453.0	290
8292 E / 6 / 12	25.199.0653.0	364	8358 / 2 TOP V OB	25.782.0253.0	354	8413 B / 4 VR OB	25.385.2453.0	290
8292 E / 6 / 12 OB	25.199.5653.0	364	8358 / 3 TOP H OB	25.792.0353.0	354	8413 B / 5	25.380.0553.0	288
8292 E / 7 / 14	25.199.0753.0	364	8358 / 3 TOP V OB	25.782.0353.0	354	8413 B / 5 F	25.324.4553.0	288
8292 E / 7 / 14 OB	25.199.5753.0	364	8358 / 4 TOP H OB	25.792.0453.0	354	8413 B / 5 F OB	25.324.6553.0	288
8292 E / 8 / 16	25.199.0853.0	364	8358 / 4 TOP V OB	25.782.0453.0	354	8413 B / 5 OB	25.380.3553.0	288
8292 E / 8 / 16 OB	25.199.5853.0	364	8358 / 5 TOP H OB	25.792.0553.0	354	8413 B / 5 VL	25.386.0553.0	290
8292 E / 9 / 18	25.199.0953.0	364	8358 / 5 TOP V OB	25.782.0553.0	354	8413 B / 5 VL OB	25.386.2553.0	290
8292 E / 9 / 18 OB	25.199.5953.0	364	8358 / 6 TOP H OB	25.792.0653.0	354	8413 B / 5 VR	25.385.0553.0	290
8292 E / 10 / 20	25.199.1053.0	364	8358 / 6 TOP V OB	25.782.0653.0	354	8413 B / 5 VR OB	25.385.2553.0	290
8292 E / 10 / 20 OB	25.199.6053.0	364	8358 / 7 TOP H OB	25.792.0753.0	354	8413 B / 6	25.380.0653.0	288
8292 E / 11 / 22	25.199.1153.0	364	8358 / 7 TOP V OB	25.782.0753.0	354	8413 B / 6 F	25.324.4653.0	288
8292 E / 11 / 22 OB	25.199.6153.0	364	8358 / 8 TOP H OB	25.792.0853.0	354	8413 B / 6 F OB	25.324.6653.0	288
8292 E / 12 / 24	25.199.1253.0	364	8358 / 8 TOP V OB	25.782.0853.0	354	8413 B / 6 OB	25.380.3653.0	288
8292 E / 12 / 24 OB	25.199.6253.0	364	8358 / 9 TOP H OB	25.792.0953.0	354	8413 B / 6 VL	25.386.0653.0	290
8292 EH / 2 OB	27.000.2253.0	340	8358 / 9 TOP V OB	25.782.0953.0	354	8413 B / 6 VL OB	25.386.2653.0	290
8292 EH / 3 OB	27.000.2353.0	340	8358 / 10 TOP H OB	25.792.1053.0	354	8413 B / 6 VR	25.385.0653.0	290
8292 H / 2 OB	27.000.0253.0	341	8358 / 10 TOP V OB	25.782.1053.0	354	8413 B / 6 VR OB	25.385.2653.0	290
8292 H / 3 OB	27.000.0353.0	341	8358 / 11 TOP H OB	25.792.1153.0	354	8413 B / 7	25.380.0753.0	288
8313 B / 2	25.360.0253.0	288	8358 / 11 TOP V OB	25.782.1153.0	354	8413 B / 7 F	25.324.4753.0	288
8313 B / 2 F	25.324.0253.0	288	8358 / 12 TOP H OB	25.792.1253.0	354	8413 B / 7 F OB	25.324.6753.0	288
8313 B / 2 F OB	25.324.2253.0	288	8358 / 12 TOP V OB	25.782.1253.0	354	8413 B / 7 OB	25.380.3753.0	288
8313 B / 2 OB	25.360.3253.0	288	8358 / 13 TOP H OB	25.792.1353.0	354	8413 B / 7 VL	25.386.0753.0	290
8313 B / 3	25.360.0353.0	288	8358 / 13 TOP V OB	25.782.1353.0	354	8413 B / 7 VL OB	25.386.2753.0	290
8313 B / 3 F	25.324.0353.0	288	8358 / 14 TOP H OB	25.792.1453.0	354	8413 B / 7 VR	25.385.0753.0	290
8313 B / 3 F OB	25.324.2353.0	288	8358 / 14 TOP V OB	25.782.1453.0	354	8413 B / 7 VR OB	25.385.2753.0	290
8313 B / 3 OB	25.360.3353.0	288	8358 / 15 TOP H OB	25.792.1553.0	354	8413 B / 8	25.380.0853.0	288
8313 B / 4	25.360.0453.0	288	8358 / 15 TOP V OB	25.782.1553.0	354	8413 B / 8 F	25.324.4853.0	288
8313 B / 4 F	25.324.0453.0	288	8358 / 16 TOP H OB	25.792.1653.0	354	8413 B / 8 F OB	25.324.6853.0	288
8313 B / 4 F OB	25.324.2453.0	288	8358 / 16 TOP V OB	25.782.1653.0	354	8413 B / 8 OB	25.380.3853.0	288
8313 B / 4 OB	25.360.3453.0	288	8375 / 1 / 7,5	25.700.0153.0	374	8413 B / 8 VL	25.386.0853.0	290
8313 B / 5	25.360.0553.0	288	8385 TOP H	25.761.3253.0	352	8413 B / 8 VL OB	25.386.2853.0	288
8313 B / 5 F	25.324.0553.0	288	8385 TOP V	25.761.3453.0	352	8413 B / 8 VR	25.385.0853.0	290
8313 B / 5 F OB	25.324.2553.0	288	8385 TOP H	25.761.3553.0	352	8413 B / 8 VR OB	25.385.2853.0	288
8313 B / 5 OB	25.360.3553.0	288	8385 TOP V	25.761.3653.0	352	8413 B / 9	25.380.0953.0	288
8313 B / 6	25.360.0653.0	288	8385 TOP H	25.761.3753.0	352	8413 B / 9 F	25.324.4953.0	288
8313 B / 6 F	25.324.0653.0	288	8385 TOP V	25.761.3853.0	352	8413 B / 9 F OB	25.324.6953.0	288
8313 B / 6 F OB	25.324.2653.0	288	8385 TOP H	25.761.4053.0	351	8413 B / 9 OB	25.380.3953.0	288
8313 B / 6 OB	25.360.3653.0	288	8385 TOP V	25.761.0553.0	351	8413 B / 9 VL	25.386.0953.0	290
8313 B / 7	25.360.0753.0	288	8385 TOP H	25.761.0753.0	351	8413 B / 9 VL OB	25.386.2953.0	290
8313 B / 7 F	25.324.0753.0	288	8385 TOP V	25.761.0853.0	351	8413 B / 9 VR	25.385.0953.0	290
8313 B / 7 F OB	25.324.2753.0	288	8385 / 1 TOP H	25.761.0153.0	352	8413 B / 9 VR OB	25.385.2953.0	290
8313 B / 7 OB	25.360.3753.0	288	8385 / 1 TOP V	25.761.0053.0	351	8413 B / 10	25.380.1053.0	288
8313 B / 8	25.360.0853.0	288	8385 / 2 TOP V	25.761.0253.0	351	8413 B / 10 F	25.324.5053.0	288
8313 B / 8 F	25.324.0853.0	288	8385 / 3 TOP H	25.761.3353.0	352	8413 B / 10 F OB	25.324.7053.0	288
8313 B / 8 F OB	25.324.2853.0	288	8385 / 3 TOP V	25.761.0353.0	351	8413 B / 10 OB	25.380.4053.0	288
8313 B / 8 OB	25.360.3853.0	288	8385 / 6 TOP V	25.761.0653.0	351	8413 B / 10 VL	25.386.1053.0	290
8313 B / 9	25.360.0953.0	288	8390 / 2	25.150.0253.0	359	8413 B / 10 VL OB	25.386.3053.0	290
8313 B / 9 F	25.324.0953.0	288	8390 / 2 OB	25.151.0253.0	359	8413 B / 10 VR	25.385.1053.0	290
8313 B / 9 F OB	25.324.2953.0	288	8390 / 3	25.150.0353.0	359	8413 B / 10 VR OB	25.385.3053.0	290
8313 B / 9 OB	25.360.3953.0	288	8390 / 3 OB	25.151.0353.0	359	8413 B / 11	25.380.1153.0	288
8313 B / 10	25.360.1053.0	288	8390 / 4	25.150.0453.0	359	8413 B / 11 F	25.324.5153.0	288
8313 B / 10 F	25.324.1053.0	288	8390 / 4 OB	25.151.0453.0	359	8413 B / 11 F OB	25.324.7153.0	288
8313 B / 10 F OB	25.324.3053.0	288	8390 / 5	25.150.0553.0	359	8413 B / 11 OB	25.380.4153.0	288
8313 B / 10 OB	25.360.4053.0	288	8390 / 5 OB	25.151.0553.0	359	8413 B / 11 VL	25.386.1153.0	290
8313 B / 11	25.360.1153.0	288	8390 / 6	25.150.0653.0	359	8413 B / 11 VL OB	25.386.3153.0	290
8313 B / 11 F	25.324.1153.0	288	8390 / 6 OB	25.151.0653.0	359	8413 B / 11 VR	25.385.1153.0	290
8313 B / 11 F OB	25.324.3153.0	288	8390 / 7	25.150.0753.0	359	8413 B / 11 VR OB	25.385.3153.0	290
8313 B / 11 OB	25.360.4153.0	288	8390 / 7 OB	25.151.0753.0	359	8413 B / 12	25.380.1253.0	288
8313 B / 12	25.360.1253.0	288	8390 / 8	25.150.0853.0	359	8413 B / 12 F	25.324.5253.0	288
8313 B / 12 F	25.324.1253.0	288	8390 / 8 OB	25.151.0853.0	359	8413 B / 12 F OB	25.324.7253.0	288
8313 B / 12 F OB	25.324.3253.0	288	8390 / 9	25.150.0953.0	359	8413 B / 12 OB	25.380.4253.0	288
8313 B / 12 OB	25.360.4253.0	288	8390 / 9 OB	25.151.0953.0	359	8413 B / 12 VL	25.386.1253.0	290
8313 S / 2 G OB	25.370.3253.0	300	8390 / 10	25.150.1053.0	359	8413 B / 12 VL OB	25.386.3253.0	290
8313 S / 2 GF OB	25.374.6253.0	300	8390 / 10 OB	25.151.1053.0	359	8413 B / 12 VR	25.385.1253.0	290
8313 S / 2 W OB	25.372.3253.0	301	8390 / 11	25.150.1153.0	359	8413 B / 12 VR OB	25.385.3253.0	290
8313 S / 2 WF OB	25.374.2253.0	301	8390 / 11 OB	25.151.1153.0	359	8413 BFK / 2 TOP K	25.880.0253.0	294
8313 S / 3 G OB	25.370.3353.0	300	8390 / 12	25.150.1253.0	359	8413 BFK / 2 TOP K OB	25.880.3253.0	294
8313 S / 3 GF OB	25.374.6353.0	301	8390 / 12 OB	25.151.1253.0	359	8413 BFK / 2 TOP K F	25.881.0253.0	294
8313 S / 3 W OB	25.372.3353.0	301	8391 / 2	25.164.0253.0	346	8413 BFK / 2 TOP K F OB	25.881.3253.0	294
8313 S / 3 WF OB	25.374.2353.0	301	8391 / 2 OB	25.165.0253.0	346	8413 BFK / 3 TOP K	25.880.0353.0	294
8313 S / 4 G OB	25.370.3453.0	300	8391 / 2 Z	25.164.3253.0	347	8413 BFK / 3 TOP K OB	25.880.3353.0	294
8313 S / 4 GF OB	25.374.6453.0	301	8391 / 2 ZN	25.165.3253.0	346	8413 BFK / 3 TOP K F	25.881.0353.0	294
8313 S / 4 W OB	25.372.3453.0	301	8391 / 2 ZN OB	25.174.0253.0	347	8413 BFK / 3 TOP K F OB	25.881.3353.0	294
8313 S / 4 WF OB	25.374.2453.0	301	8391 / 3	25.175.0253.0	346	8413 BFK / 4 TOP K	25.880.0453.0	294
8313 S / 5 G OB	25.370.3553.0	300	8391 / 3 Z	25.165.6253.0	347	8413 BFK / 4 TOP K OB	25.880.3453.0	294
8313 S / 5 GF OB	25.374.6553.0	300	8391 / 3 ZN	25.165.6253.0	347	8413 BFK / 4 TOP K F	25.881.0453.0	294
8313 S / 5 W OB	25.372.3553.0	301	8391 / 3 ZN OB	25.164.0353.0	346	8413 BFK / 4 TOP K F OB	25.881.3453.0	294
8313 S / 5 WF OB	25.374.2553.0	301	8391 / 3 OB	25.165.0353.0	346	8413 BFK / 5 TOP K	25.880.0553.0	294
8313 S / 6 G OB	25.370.3653.0	300	8391 / 3 Z	25.164.3353.0	347	8413 BFK / 5 TOP K OB	25.880.3553.0	294
8313 S / 6 GF OB	25.374.6653.0	300	8391 / 3 Z OB	25.165.3353.0	346	8413 BFK / 5 TOP K F	25.881.0553.0	2

contents of
type description

contents TYPE

Type	Part no.	section / page	Type	Part no.	section / page	Type	Part no.	section / page
8413 BFK / 8 TOP K F	25.881.0853.0	294	8485/ 6 TOP H	25.771.3653.0	352	8513 BFK/15 TOP	25.630.1553.0	281
8413 BFK / 8 TOP K F OB	25.881.3853.0	294	8486 / 3 TOP H OB	27.713.0353.0	356	8513 BFK/15 TOP OB	25.630.4553.0	281
8413 BFK / 9 TOP K	25.880.0953.0	294	8486 / 3 TOP V OB	27.703.0353.0	356	8513 BFK/16 TOP	25.630.1653.0	281
8413 BFK / 9 TOP K OB	25.880.3953.0	294	8486 / 4 TOP H OB	27.713.0453.0	356	8513 BFK/16 TOP OB	25.630.4653.0	281
8413 BFK / 9 TOP K F	25.881.0953.0	294	8486 / 4 TOP V OB	27.703.0453.0	356	8513 S / 2 G	25.646.0253.0	284
8413 BFK / 9 TOP K F OB	25.881.3953.0	294	8491 / 2	25.166.0253.0	346	8513 S / 2 G F	25.646.3253.0	285
8413 BFK /10 TOP K	25.880.1053.0	294	8491 / 2 OB	25.167.0253.0	346	8513 S / 2 W	25.647.0253.0	284
8413 BFK /10 TOP K OB	25.880.4053.0	294	8491 / 2 Z	25.166.3253.0	347	8513 S / 2 W F	25.647.3253.0	285
8413 BFK /10 TOP K F	25.881.1053.0	294	8491 / 2 Z OB	25.167.3253.0	346	8513 S / 3 G	25.646.0353.0	284
8413 BFK /10 TOP K F OB	25.881.4053.0	294	8491 / 2 ZN	25.176.0253.0	347	8513 S / 3 GF	25.646.3353.0	285
8413 BFK /11 TOP K	25.880.1153.0	294	8491 / 2 ZN OB	25.177.0253.0	347	8513 S / 3 W	25.647.0353.0	284
8413 BFK /11 TOP K OB	25.880.4153.0	294	8491 / 2 ZW	25.166.6253.0	347	8513 S / 3 WF	25.647.3353.0	285
8413 BFK /11 TOP K F	25.881.1153.0	294	8491 / 2 ZW OB	25.167.6253.0	347	8513 S / 4 G	25.646.0453.0	284
8413 BFK /11 TOP K F OB	25.881.4153.0	294	8491 / 3	25.166.0353.0	346	8513 S / 4 GF	25.646.3453.0	285
8413 BFK /12 TOP K	25.880.1253.0	294	8491 / 3 OB	25.167.0353.0	346	8513 S / 4 W	25.647.0453.0	284
8413 BFK /12 TOP K OB	25.880.4253.0	294	8491 / 3 Z	25.166.3353.0	347	8513 S / 4 WF	25.647.3453.0	285
8413 BFK /12 TOP K F	25.881.1253.0	294	8491 / 3 Z OB	25.167.3353.0	346	8513 S / 5 G	25.646.0553.0	284
8413 BFK /12 TOP K F OB	25.881.4253.0	294	8491 / 3 ZN	25.176.0353.0	347	8513 S / 5 GF	25.646.3553.0	285
8413 S / 2 G OB	25.390.3253.0	300	8491 / 3 ZN OB	25.177.0353.0	347	8513 S / 5 W	25.647.0553.0	284
8413 S / 2 GF OB	25.398.6253.0	300	8491 / 3 ZW	25.166.6353.0	346	8513 S / 5 WF	25.647.3553.0	285
8413 S / 2 W OB	25.392.3253.0	301	8491 / 3 ZW OB	25.167.6353.0	347	8513 S / 6 G	25.646.0653.0	284
8413 S / 2 WF OB	25.398.2253.0	301	8513 B / 2	25.640.0253.0	280	8513 S / 6 GF	25.646.3653.0	285
8413 S / 3 G OB	25.390.3353.0	300	8513 B / 2 F	25.641.0253.0	280	8513 S / 6 W	25.647.0653.0	284
8413 S / 3 GF OB	25.398.6353.0	300	8513 B / 2 F OB	25.641.3253.0	280	8513 S / 6 WF	25.647.3653.0	285
8413 S / 3 W OB	25.392.3353.0	301	8513 B / 2 OB	25.640.3253.0	280	8513 S / 7 G	25.646.0753.0	284
8413 S / 3 WF OB	25.398.2353.0	301	8513 B / 3	25.640.0353.0	280	8513 S / 7 GF	25.646.3753.0	285
8413 S / 4 G OB	25.390.3453.0	300	8513 B / 3 F	25.641.0353.0	280	8513 S / 7 W	25.647.0753.0	284
8413 S / 4 GF OB	25.398.6453.0	300	8513 B / 3 F OB	25.641.3353.0	280	8513 S / 7 WF	25.647.3753.0	285
8413 S / 4 W OB	25.392.3453.0	301	8513 B / 3 OB	25.640.3353.0	280	8513 S / 8 G	25.646.0853.0	284
8413 S / 4 WF OB	25.398.2453.0	301	8513 B / 4	25.640.0453.0	280	8513 S / 8 GF	25.646.3853.0	285
8413 S / 5 G OB	25.390.3553.0	300	8513 B / 4 F	25.641.0453.0	280	8513 S / 8 W	25.647.0853.0	284
8413 S / 5 GF OB	25.398.6553.0	300	8513 B / 4 F OB	25.641.3453.0	280	8513 S / 8 WF	25.647.3853.0	285
8413 S / 5 W OB	25.392.3553.0	301	8513 B / 4 OB	25.640.3453.0	280	8513 S / 9 G	25.646.0953.0	284
8413 S / 5 WF OB	25.398.2553.0	301	8513 B / 5	25.640.0553.0	280	8513 S / 9 GF	25.646.3953.0	285
8413 S / 6 G OB	25.390.3653.0	300	8513 B / 5 F	25.641.0553.0	280	8513 S / 9 W	25.647.0953.0	284
8413 S / 6 GF OB	25.398.6653.0	300	8513 B / 5 F OB	25.641.3553.0	280	8513 S / 9 WF	25.647.3953.0	285
8413 S / 6 W OB	25.392.3653.0	301	8513 B / 5 OB	25.640.3553.0	280	8513 S / 10 G	25.646.1053.0	284
8413 S / 6 WF OB	25.398.2653.0	301	8513 B / 6	25.640.0653.0	280	8513 S / 10 GF	25.646.4053.0	285
8413 S / 7 G OB	25.390.3753.0	300	8513 B / 6 F	25.641.0653.0	280	8513 S / 10 W	25.647.1053.0	284
8413 S / 7 GF OB	25.398.6753.0	300	8513 B / 6 F OB	25.641.3653.0	280	8513 S / 10 WF	25.647.4053.0	285
8413 S / 7 W OB	25.392.3753.0	301	8513 B / 6 OB	25.640.3653.0	280	8513 S / 11 G	25.646.1153.0	284
8413 S / 7 WF OB	25.398.2753.0	301	8513 B / 7	25.640.0753.0	280	8513 S / 11 GF	25.646.4153.0	285
8413 S / 8 G OB	25.390.3853.0	300	8513 B / 7 F	25.641.0753.0	280	8513 S / 11 W	25.647.1153.0	284
8413 S / 8 GF OB	25.398.6853.0	300	8513 B / 7 F OB	25.641.3753.0	280	8513 S / 11 WF	25.647.4153.0	285
8413 S / 8 W OB	25.392.3853.0	301	8513 B / 7 OB	25.640.3753.0	280	8513 S / 12 G	25.646.1253.0	284
8413 S / 8 WF OB	25.398.2853.0	301	8513 B / 8	25.640.0853.0	280	8513 S / 12 GF	25.646.4253.0	285
8413 S / 9 G OB	25.390.3953.0	300	8513 B / 8 F	25.641.0853.0	280	8513 S / 12 W	25.647.1253.0	284
8413 S / 9 GF OB	25.398.6953.0	300	8513 B / 8 F OB	25.641.3853.0	280	8513 S / 12 WF	25.647.4253.0	285
8413 S / 9 W OB	25.392.3953.0	301	8513 B / 8 OB	25.640.3853.0	280	8513 S / 13 G	25.646.1353.0	284
8413 S / 9 WF OB	25.398.2953.0	301	8513 B / 9	25.640.0953.0	280	8513 S / 13 GF	25.646.4353.0	285
8413 S / 10 G OB	25.390.4053.0	300	8513 B / 9 F	25.641.0953.0	280	8513 S / 13 WF	25.647.4353.0	285
8413 S / 10 GF OB	25.398.7053.0	300	8513 B / 9 F OB	25.641.3953.0	280	8513 S / 14 G	25.646.1453.0	284
8413 S / 10 W OB	25.392.4053.0	301	8513 B / 9 OB	25.640.3953.0	280	8513 S / 14 GF	25.646.4453.0	285
8413 S / 10 WF OB	25.398.3053.0	301	8513 B / 10	25.640.1053.0	280	8513 S / 14 W	25.647.1453.0	284
8413 S / 11 G OB	25.390.4153.0	300	8513 B / 10 F	25.641.1053.0	280	8513 S / 14 WF	25.647.4453.0	285
8413 S / 11 GF OB	25.398.7153.0	300	8513 B / 10 F OB	25.641.4053.0	280	8513 S / 15 G	25.646.1553.0	284
8413 S / 11 W OB	25.392.4153.0	301	8513 B / 10 OB	25.640.4053.0	280	8513 S / 15 GF	25.646.4553.0	285
8413 S / 11 WF OB	25.398.3153.0	301	8513 B / 11	25.640.1153.0	280	8513 S / 15 W	25.647.1553.0	284
8413 S / 12 G OB	25.390.4253.0	300	8513 B / 11 F	25.641.1153.0	280	8513 S / 15 WF	25.647.4553.0	285
8413 S / 12 GF OB	25.398.7253.0	300	8513 B / 11 F OB	25.641.4153.0	280	8513 S / 16 G	25.646.1653.0	284
8413 S / 12 W OB	25.392.4253.0	301	8513 B / 11 OB	25.640.4153.0	280	8513 S / 16 GF	25.646.4653.0	285
8413 S / 12 WF OB	25.398.3253.0	301	8513 B / 12	25.640.1253.0	280	8513 S / 16 W	25.647.1653.0	284
8458 / 2 TOP H OB	25.793.0253.0	354	8513 B / 12 F	25.641.1253.0	280	8513 S / 16 WF	25.647.4653.0	285
8458 / 2 TOP V OB	25.783.0253.0	354	8513 B / 12 F OB	25.641.4253.0	280	8513 SUFK / 2 OB	25.642.3253.0	281
8458 / 3 TOP H OB	25.793.0353.0	354	8513 B / 12 OB	25.640.4253.0	280	8513 SUFK / 3 OB	25.642.3353.0	281
8458 / 3 TOP V OB	25.783.0353.0	354	8513 B / 13	25.640.1353.0	280	8513 SUFK / 4 OB	25.642.3453.0	281
8458 / 4 TOP H OB	25.793.0453.0	354	8513 B / 13 F	25.641.1353.0	280	8513 SUFK / 5 OB	25.642.3553.0	281
8458 / 4 TOP V OB	25.783.0453.0	354	8513 B / 13 F OB	25.641.4353.0	280	8513 SUFK / 6 OB	25.642.3653.0	281
8458 / 5 TOP H OB	25.793.0553.0	354	8513 B / 13 OB	25.640.4353.0	280	8513 SUFK / 7 OB	25.642.3753.0	281
8458 / 5 TOP V OB	25.783.0553.0	354	8513 B / 14	25.640.1453.0	280	8513 SUFK / 8 OB	25.642.3853.0	281
8458 / 6 TOP H OB	25.793.0653.0	354	8513 B / 14 F	25.641.1453.0	280	8513 SUFK / 9 OB	25.642.3953.0	281
8458 / 6 TOP V OB	25.783.0653.0	354	8513 B / 14 F OB	25.641.4453.0	280	8513 SUFK / 10 OB	25.642.4053.0	281
8458 / 7 TOP H OB	25.793.0753.0	354	8513 B / 14 OB	25.640.4453.0	280	8513 SUFK / 11 OB	25.642.4153.0	281
8458 / 7 TOP V OB	25.783.0753.0	354	8513 B / 15	25.640.1553.0	280	8513 SUFK / 12	25.642.1253.0	281
8458 / 8 TOP H OB	25.793.0853.0	354	8513 B / 15 F	25.641.1553.0	280	8513 SUFK / 12 OB	25.642.4253.0	281
8458 / 8 TOP V OB	25.783.0853.0	354	8513 B / 15 F OB	25.641.4553.0	280	8520 B / 2 OB	25.470.0253.0	324
8458 / 9 TOP H OB	25.793.0953.0	354	8513 B / 15 OB	25.640.4553.0	280	8520 B / 3	25.470.3353.0	324
8458 / 9 TOP V OB	25.783.0953.0	354	8513 B / 16	25.640.1653.0	280	8520 B / 3 OB	25.470.0353.0	324
8458 / 10 TOP H OB	25.793.1053.0	354	8513 B / 16 F	25.641.1653.0	280	8520 B / 4 OB	25.470.0453.0	324
8458 / 10 TOP V OB	25.783.1053.0	354	8513 B / 16 F OB	25.641.4653.0	280	8520 B / 5 OB	25.470.0553.0	324
8458 / 11 TOP H OB	25.793.1153.0	354	8513 B / 16 OB	25.640.4653.0	280	8520 B / 6 OB	25.470.0653.0	324
8458 / 11 TOP V OB	25.783.1153.0	354	8513 BDK/10 TOP	25.630.1053.0	281	8520 B / 7	25.470.3753.0	324
8458 / 12 TOP H OB	25.793.1253.0	354	8513 BFK/2 TOP	25.630.0253.0	281	8520 B / 7 OB	25.470.0753.0	324
8458 / 12 TOP V OB	25.783.1253.0	354	8513 BFK/2 TOP OB	25.630.3253.0	281	8520 B / 8	25.470.3853.0	324
8458 / 13 TOP H OB	25.793.1353.0	354	8513 BFK/3 TOP	25.630.0353.0	281	8520 B / 8 OB	25.470.0853.0	324
8458 / 13 TOP V OB	25.783.1353.0	354	8513 BFK/3 TOP OB	25.630.3353.0	281	8520 B / 9 OB	25.470.0953.0	324
8458 / 14 TOP H OB	25.793.1453.0	354	8513 BFK/4 TOP	25.630.0453.0	281	8520 B / 10 OB	25.470.1053.0	324
8458 / 14 TOP V OB	25.783.1453.0	354	8513 BFK/4 TOP OB	25.630.3453.0	281	8520 B / 11	25.470.4153.0	324
8458 / 15 TOP H OB	25.793.1553.0	354	8513 BFK/5 TOP	25.630.0553.0	281	8520 B / 11 OB	25.470.1153.0	324
8458 / 15 TOP V OB	25.783.1553.0	354	8513 BFK/5 TOP OB	25.630.3553.0	281	8520 B / 12 OB	25.470.1253.0	324
8458 / 16 TOP H OB	25.793.1653.0	354	8513 BFK/6 TOP	25.630.0653.0	281	8520 B / 13	25.470.4353.0	324
8458 / 16 TOP V OB	25.783.1653.0	354	8513 BFK/6 TOP OB	25.630.3653.0	281	8520 B / 13 OB	25.470.1353.0	324
8485 TOP H	25.771.3453.0	352	8513 BFK/7 TOP	25.630.0753.0	281	8520 B / 14	25.470.4453.0	324
8485 TOP H	25.771.3553.0	352	8513 BFK/7 TOP OB	25.630.3753.0	281	8520 B / 14 OB	25.470.1453.0	324
8485 TOP H	25.771.3753.0	352	8513 BFK/8 TOP	25.630.0853.0	281	8520 B / 15	25.470.4553.0	324
8485 TOP H	25.771.3853.0	352	8513 BFK/8 TOP OB	25.630.38				

contents

Type	Part no.	section / page	Type	Part no.	section / page	Type	Part no.	section / page
8520 BL / 7 W OB	25.471.0753	325	8593 / 14 OB	25.195.1453.0	336	8813 B / 10 VR OB	25.622.4053.0	282
8520 BL / 11 G	25.472.4153.0	325	8593 / 15 OB	25.194.1553.0	336	8813 B / 11	25.620.1153.0	280
8520 BL / 11 G OB	25.472.1153.0	325	8593 / 16 OB	25.195.1553.0	336	8813 B / 11 F	25.621.1153.0	280
8520 BL / 11 W	25.471.4153.0	325	8593 / 16 OB	25.194.1653.0	336	8813 B / 11 F OB	25.621.4153.0	280
8520 BL / 11 W OB	25.471.1153.0	325	8813 B / 2	25.195.1653.0	336	8813 B / 11 OB	25.620.1153.0	280
8520 BL / 13 G	25.472.4353.0	325	8813 B / 2 F	25.620.0253.0	280	8813 B / 11 VL	25.624.1153.0	282
8520 BL / 13 G OB	25.472.1353.0	325	8813 B / 2 OB	25.621.0253.0	280	8813 B / 11 VL F	25.625.1153.0	283
8520 BL / 13 W	25.471.4353.0	325	8813 B / 2 VR	25.620.3253.0	280	8813 B / 11 VL F OB	25.625.4153.0	283
8520 BL / 13 W OB	25.471.1353.0	325	8813 B / 2 VR OB	25.620.3253.0	280	8813 B / 11 VL OB	25.624.4153.0	282
8520 BL / 14 G	25.472.4453.0	325	8813 B / 2 VL	25.624.0253.0	282	8813 B / 11 VR	25.622.1153.0	282
8520 BL / 14 G OB	25.472.1453.0	325	8813 B / 2 VL F	25.625.0253.0	283	8813 B / 11 VR F	25.623.1153.0	283
8520 BL / 14 W	25.471.4453.0	325	8813 B / 2 VL F OB	25.625.3253.0	283	8813 B / 11 VR F OB	25.623.4153.0	283
8520 BL / 14 W OB	25.471.1453.0	325	8813 B / 2 VR	25.624.3253.0	282	8813 B / 11 VR OB	25.622.4153.0	282
8520 BL / 15 G	25.472.4553.0	325	8813 B / 2 VR F	25.622.0253.0	282	8813 B / 12	25.620.1253.0	280
8520 BL / 15 G OB	25.472.1553.0	325	8813 B / 2 VR F OB	25.623.0253.0	283	8813 B / 12 F	25.621.1253.0	280
8520 BL / 15 W	25.471.4553.0	325	8813 B / 2 VR OB	25.623.3253.0	283	8813 B / 12 F OB	25.621.4253.0	280
8520 BL / 15 W OB	25.471.1553.0	325	8813 B / 3	25.622.3253.0	282	8813 B / 12 OB	25.620.4253.0	280
8520 BL / 16 G	25.472.4653.0	325	8813 B / 3 F	25.620.0353.0	280	8813 B / 12 VL	25.624.1253.0	282
8520 BL / 16 W	25.471.4653.0	325	8813 B / 3 F OB	25.621.0353.0	280	8813 B / 12 VL F	25.625.1253.0	283
8520 S / 2 G 0.8	25.535.0225.0	324	8813 B / 3 OB	25.621.3353.0	280	8813 B / 12 VL F OB	25.625.4253.0	283
8520 S / 2 G 1.0	25.535.3225.0	324	8813 B / 3 OB	25.620.3353.0	280	8813 B / 12 VL OB	25.624.4253.0	282
8520 S / 3 G 0.8	25.535.0325.0	324	8813 B / 3 VL	25.624.0353.0	282	8813 B / 12 VR	25.622.1253.0	282
8520 S / 3 G 1.0	25.535.3325.0	324	8813 B / 3 VL F	25.625.0353.0	283	8813 B / 12 VR F	25.623.1253.0	283
8520 S / 4 G 0.8	25.535.0425.0	324	8813 B / 3 VL F OB	25.625.3353.0	283	8813 B / 12 VR F OB	25.623.4253.0	283
8520 S / 4 G 1.0	25.535.3425.0	324	8813 B / 3 VL OB	25.624.3353.0	282	8813 B / 12 VR OB	25.622.4253.0	282
8520 S / 5 G 0.8	25.535.0525.0	324	8813 B / 3 VR	25.623.0353.0	283	8813 B / 13	25.620.1353.0	280
8520 S / 5 G 1.0	25.535.3525.0	324	8813 B / 3 VR F	25.623.3353.0	283	8813 B / 13 F	25.621.1353.0	280
8520 S / 6 G 0.8	25.535.0625.0	324	8813 B / 3 VR F OB	25.622.3353.0	282	8813 B / 13 F OB	25.621.4353.0	280
8520 S / 6 G 1.0	25.535.3625.0	324	8813 B / 4	25.620.0453.0	280	8813 B / 13 OB	25.620.4353.0	280
8520 S / 7 G 0.8	25.535.0725.0	324	8813 B / 4 F	25.621.0453.0	280	8813 B / 13 VL	25.624.1353.0	282
8520 S / 7 G 1.0	25.535.3725.0	324	8813 B / 4 OB	25.621.3453.0	280	8813 B / 13 VL F	25.625.1353.0	283
8520 S / 8 G 0.8	25.535.0825.0	324	8813 B / 4 OB	25.620.3453.0	280	8813 B / 13 VL F OB	25.625.4353.0	283
8520 S / 8 G 1.0	25.535.3825.0	324	8813 B / 4 VL	25.624.0453.0	282	8813 B / 13 VL OB	25.624.4353.0	282
8520 S / 10 G 0.8	25.535.1025.0	324	8813 B / 4 VL F	25.625.0453.0	283	8813 B / 13 VR	25.622.1353.0	282
8520 S / 10 G 1.0	25.535.4025.0	324	8813 B / 4 VL F OB	25.625.3453.0	283	8813 B / 13 VR F	25.623.1353.0	283
8520 S / 11 G 0.8	25.535.1125.0	324	8813 B / 4 VL OB	25.624.3453.0	282	8813 B / 13 VR F OB	25.623.4353.0	283
8520 S / 11 G 1.0	25.535.4125.0	324	8813 B / 4 VR	25.623.0453.0	283	8813 B / 14	25.620.1453.0	280
8520 S / 12 G 0.8	25.535.1225.0	324	8813 B / 4 VR F	25.623.3453.0	283	8813 B / 14 F	25.621.1453.0	280
8520 S / 12 G 1.0	25.535.4225.0	324	8813 B / 4 VR OB	25.622.3453.0	282	8813 B / 14 F OB	25.621.4453.0	280
8520 S / 13 G 0.8	25.535.1325.0	324	8813 B / 5	25.620.0553.0	280	8813 B / 14 OB	25.620.4453.0	280
8520 S / 13 G 1.0	25.535.4325.0	324	8813 B / 5 F	25.621.0553.0	280	8813 B / 14 VL	25.624.1453.0	282
8520 S / 14 G 0.8	25.535.1425.0	324	8813 B / 5 F OB	25.621.3553.0	280	8813 B / 14 VL F	25.625.1453.0	283
8520 S / 14 G 1.0	25.535.4425.0	324	8813 B / 5 OB	25.620.3553.0	280	8813 B / 14 VL F OB	25.625.4453.0	283
8520 S / 15 G 0.8	25.535.1525.0	324	8813 B / 5 VL	25.624.0553.0	282	8813 B / 14 VL OB	25.624.4453.0	282
8520 S / 15 G 1.0	25.535.4525.0	324	8813 B / 5 VL F	25.625.0553.0	283	8813 B / 14 VR	25.622.1453.0	282
8520 S / 16 G 0.8	25.535.1625.0	324	8813 B / 5 VL F OB	25.625.3553.0	283	8813 B / 14 VR F	25.623.1453.0	283
8520 S / 16 G 1.0	25.535.4625.0	324	8813 B / 5 VL OB	25.624.3553.0	282	8813 B / 14 VR F OB	25.623.4453.0	283
8543 / 2	25.600.5253.0	316	8813 B / 5 VR	25.623.0553.0	282	8813 B / 14 VR OB	25.622.4453.0	282
8543 / 2 OB	25.602.5253.0	316	8813 B / 5 VR F	25.623.3553.0	283	8813 B / 15	25.620.1553.0	280
8543 / 3	25.600.5353.0	316	8813 B / 5 VR OB	25.622.3553.0	282	8813 B / 15 F	25.621.1553.0	280
8543 / 3 OB	25.602.5353.0	316	8813 B / 6	25.620.0653.0	280	8813 B / 15 F OB	25.621.4553.0	280
8543 / 4	25.600.5453.0	316	8813 B / 6 F	25.621.0653.0	280	8813 B / 15 OB	25.620.4553.0	280
8543 / 4 OB	25.602.5453.0	316	8813 B / 6 F OB	25.621.3653.0	280	8813 B / 15 VL	25.624.1553.0	282
8543 / 5	25.600.5553.0	316	8813 B / 6 OB	25.620.3653.0	280	8813 B / 15 VL F	25.625.1553.0	283
8543 / 5 OB	25.602.5553.0	316	8813 B / 6 VL	25.624.0653.0	282	8813 B / 15 VL F OB	25.625.4553.0	283
8543 / 6	25.600.5653.0	316	8813 B / 6 VL F	25.625.0653.0	283	8813 B / 15 VL OB	25.624.4553.0	282
8543 / 6 OB	25.602.5653.0	316	8813 B / 6 VL F OB	25.625.3653.0	283	8813 B / 15 VR	25.622.1553.0	282
8543 / 7	25.600.5753.0	316	8813 B / 6 VL OB	25.624.3653.0	282	8813 B / 15 VR F	25.623.1553.0	283
8543 / 7 OB	25.602.5753.0	316	8813 B / 6 VR	25.622.0653.0	282	8813 B / 15 VR F OB	25.623.4553.0	283
8543 / 8	25.600.5853.0	316	8813 B / 6 VR F	25.623.0653.0	283	8813 B / 15 VR OB	25.622.4553.0	282
8543 / 8 OB	25.602.5853.0	316	8813 B / 6 VR F OB	25.623.3653.0	283	8813 B / 16	25.620.1653.0	280
8543 / 9	25.600.5953.0	316	8813 B / 6 VR OB	25.622.3653.0	282	8813 B / 16 F	25.621.1653.0	280
8543 / 9 OB	25.602.5953.0	316	8813 B / 7	25.620.0753.0	280	8813 B / 16 F OB	25.621.4653.0	280
8543 / 10	25.600.6053.0	316	8813 B / 7 F	25.621.0753.0	280	8813 B / 16 OB	25.620.4653.0	280
8543 / 10 OB	25.602.6053.0	316	8813 B / 7 F OB	25.621.3753.0	281	8813 B / 16 VL	25.624.1653.0	282
8543 / 11	25.600.6153.0	316	8813 B / 7 OB	25.620.3753.0	280	8813 B / 16 VL F	25.625.1653.0	283
8543 / 11 OB	25.602.6153.0	316	8813 B / 7 VL	25.624.0753.0	282	8813 B / 16 VL F OB	25.625.4653.0	283
8543 / 12	25.600.6253.0	316	8813 B / 7 VL F	25.625.0753.0	283	8813 B / 16 VL OB	25.624.4653.0	282
8543 / 12 OB	25.602.6253.0	316	8813 B / 7 VL F OB	25.625.3753.0	283	8813 B / 16 VR	25.622.1653.0	282
8543 / 13	25.600.6353.0	316	8813 B / 7 VL OB	25.624.3753.0	282	8813 B / 16 VR F	25.623.1653.0	283
8543 / 13 OB	25.602.6353.0	316	8813 B / 7 VR	25.623.0753.0	283	8813 B / 16 VR OB	25.622.4653.0	282
8543 / 14	25.600.6453.0	316	8813 B / 7 VR F	25.623.3753.0	283	8813 B / 3 VR	25.622.0353.0	282
8543 / 14 OB	25.602.6453.0	316	8813 B / 7 VR OB	25.622.3753.0	282	8813 B / 4 VR	25.622.0453.0	282
8543 / 15	25.600.6553.0	316	8813 B / 8	25.620.0853.0	280	8813 B / 7 VR	25.622.0753.0	282
8543 / 15 OB	25.602.6553.0	316	8813 B / 8 F	25.621.0853.0	280	8813 B / 9 VR	25.622.0953.0	282
8543 / 16	25.600.6653.0	316	8813 B / 8 OB	25.621.3853.0	280	8813 B / 5 VR	25.622.0553.0	282
8543 / 16 OB	25.602.6653.0	316	8813 B / 8 OB	25.620.3853.0	280	8813 S / 2 G	25.626.0253.0	284
8591 W / 10/40 VB1 OB	25.154.7053.0	373	8813 B / 8 VL	25.624.0853.0	282	8813 S / 2 GF	25.626.3253.0	285
8593 / 2	25.194.0253.0	336	8813 B / 8 VL F	25.625.0853.0	283	8813 S / 2 W	25.627.0253.0	284
8593 / 2 OB	25.195.0253.0	336	8813 B / 8 VL F OB	25.625.3853.0	283	8813 S / 2 WF	25.627.3253.0	285
8593 / 2 ZN	25.194.9253.0	336	8813 B / 8 VL OB	25.624.3853.0	282	8813 S / 3 G	25.626.0353.0	284
8593 / 2 ZN OB	25.195.9253.0	336	8813 B / 8 VR	25.622.0853.0	282	8813 S / 3 GF	25.626.3353.0	285
8593 / 3	25.194.0353.0	336	8813 B / 8 VR F	25.623.0853.0	283	8813 S / 3 W	25.627.0353.0	284
8593 / 3 OB	25.195.0353.0	336	8813 B / 8 VR F OB	25.623.3853.0	283	8813 S / 3 WF	25.627.3353.0	285
8593 / 3 ZN	25.194.9353.0	336	8813 B / 9	25.622.3853.0	282	8813 S / 4 G	25.626.0453.0	284
8593 / 3 ZN OB	25.195.9353.0	336	8813 B / 9 F	25.620.0953.0	280	8813 S / 4 GF	25.626.3453.0	285
8593 / 4	25.194.0453.0	336	8813 B / 9 F OB	25.621.0953.0	280	8813 S / 4 W	25.627.0453.0	284
8593 / 4 OB	25.195.0453.0	336	8813 B / 9 OB	25.621.3953.0	280	8813 S / 4 WF	25.627.3453.0	285
8593 / 5	25.194.0553.0	336	8813 B / 9 VL	25.620.3953.0	280	8813 S / 5 G	25.626.0553.0	284
8593 / 5 OB	25.195.0553.0	336	8813 B / 9 VL F	25.624.0953.0	282	8813 S / 5 GF	25.626.3553.0	285
8593 / 6	25.194.0653.0	336	8813 B / 9 VL F OB	25.625.0953.0	283	8813 S / 5 W	25.627.0553.0	284
8593 / 6 OB	25.195.0653.0	336	8813 B / 9 VL OB	25.625.3953.0	283	8813 S / 5 WF	25.627.3553.0	285
8593 / 7	25.194.0753.0	336	8813 B / 9 VR	25.624.3953.0	282	8813 S / 6 G	25.626.0653.0	284
8593 / 7 OB	25.195.0753.0	336	8813 B / 9 VR F	25.623.0953.0	283	8813 S / 6 GF	25.626.3653.0	285
8593 / 8	25.194.0853.0	336	8813 B / 9 VR F OB	25.623.3953.0	283	8813 S / 6 W	25.627.0653.0	284
8593 / 8 OB	25.195.0853.0	336	8813 B / 9 VR OB	25.622.3				

contents of
type description

contents

Type	Part no.	section / page	Type	Part no.	section / page	Type	Part no.	section / page
8813 S / 9 WF	25.627.3953.0	285	9700 A / 5 S35 BLAU	54.003.7553.6	189	9704 A / 3 B	04.841.1350.0	181
8813 S / 10 G	25.626.1053.0	284	9700 A / 6 ETK S35	54.004.7753.0	189	9704 A / 4 B	04.841.1450.0	598
8813 S / 10 GF	25.626.4053.0	285	9700 A / 6 S35	54.004.7553.0	189	9704 A / 4 B	04.841.1450.0	791
8813 S / 10 W	25.627.1053.0	284	9700 A / 6 S35 BLAU	54.004.7553.6	181	9704 A / 4 B	04.841.1450.0	395
8813 S / 10 WF	25.627.4053.0	285	9700 A / 6 SL 2 S35	56.004.9053.0	189	9704 A / 4 B	04.841.1450.0	181
8813 S / 11 G	25.626.1153.0	284	9700 A / 8 ETK S35	54.010.7753.0	189	9704 A / 5 B	04.841.1550.0	395
8813 S / 11 GF	25.626.4153.0	285	9700 A / 8 S35	54.010.7553.0	189	9704 A / 5 B	04.841.1550.0	181
8813 S / 11 W	25.627.1153.0	284	9700 A / 8 S35 BLAU	54.010.7553.6	191	9704 A / 5 B	04.841.1550.0	598
8813 S / 11 WF	25.627.4153.0	285	9700 A / 8 SL 2 S35	56.010.9053.0	189	9704 A / 5 B	04.841.1550.0	791
8813 S / 12 G	25.626.1253.0	284	9700 A / 10 ETK S35	54.016.7753.0	189	9704 A / 6 B	04.841.1650.0	598
8813 S / 12 GF	25.626.4253.0	285	9700 A / 10 S35	54.016.7553.0	189	9704 A / 6 B	04.841.1650.0	791
8813 S / 12 W	25.627.1253.0	284	9700 A / 10 S35 BLAU	54.016.7553.6	191	9704 A / 6 B	04.841.1650.0	181
8813 S / 12 WF	25.627.4253.0	285	9700 A / 10 SL 2 S35	56.016.9053.0	189	9704 A / 6 B	04.841.1650.0	395
8813 S / 13 G	25.626.1353.0	284	9700 A / 12 S35	54.025.7553.0	191	9704 A / 7 B	04.841.1750.0	181
8813 S / 13 GF	25.626.4353.0	285	9700 A / 12 S35 BLAU	54.025.7553.6	191	9704 A / 7 B	04.841.1750.0	598
8813 S / 13 W	25.627.1353.0	284	9700 A / 16 PEN2 S35	56.035.9453.0	195	9704 A / 7 B	04.841.1750.0	791
8813 S / 13 WF	25.627.4353.0	285	9700 A / 16 S35	54.035.7553.0	189	9704 A / 7 B	04.841.1750.0	395
8813 S / 14 G	25.626.1453.0	284	9700 A / 16 S35 BLAU	54.035.7553.6	189	9704 A / 8 B	04.841.1850.0	791
8813 S / 14 GF	25.626.4453.0	285	9700 A / 16 SL 2 S35	56.035.9053.0	189	9704 A / 8 B	04.841.1850.0	181
8813 S / 14 W	25.627.1453.0	284	9700 A / 35 E S35	72.302.0621.0	111	9704 A / 8 B	04.841.1850.0	598
8813 S / 14 WF	25.627.4453.0	285	9700 B/30 SI E14/S32/V0	54.904.4055.0	129	9704 A / 8 B	04.841.1850.0	395
8813 S / 15 G	25.626.1553.0	284	9700 B/30 SI E14/S35/V0	56.904.4055.0	128	9704 A / 9 B	04.841.1950.0	181
8813 S / 15 GF	25.626.4553.0	285	9700 B/30 SI E18/S32/V0	54.925.4055.0	129	9704 A / 9 B	04.841.1950.0	598
8813 S / 15 W	25.627.1553.0	284	9700 B/30 SI E18/S35/V0	56.925.4055.0	128	9704 A / 9 B	04.841.1950.0	791
8813 S / 15 WF	25.627.4553.0	285	9701 / 6	07.310.3153.0	190	9704 A / 9 B	04.841.1950.0	395
8813 S / 16 G	25.626.1653.0	284	9701 / 6 BLAU	07.310.3153.6	190	9704 A / 9 B	04.841.1950.0	791
8813 S / 16 GF	25.626.4653.0	285	9701 / 6 ETK L	07.310.4553.0	193	9704 A / 9 B	04.841.1950.0	599
8813 S / 16 W	25.627.1653.0	284	9701 / 6 SL	07.312.0053.0	194	9704 A / 9 B	04.841.1950.0	181
8813 S / 16 WF	25.627.4653.0	285	9701 / 8	07.310.3253.0	191	9704 A / 9 B	04.841.1950.0	791
8813B / 13 VR OB	25.622.4353.0	282	9701 / 8 BLAU	07.310.3253.6	191	9704 A / 9 B	04.841.1950.0	181
8893 / 11	25.196.1153.0	336	9701 / 8 SL	07.312.0153.0	194	9704 A / 9 B	04.841.1950.0	599
8893 / 13	25.196.1353.0	336	9701 / 10	07.310.3953.0	191	9704 A / 9 B	04.841.1950.0	791
8893 / 14	25.196.1453.0	336	9701 / 10 BLAU	07.310.3953.6	191	9704 A / 9 B	04.841.1950.0	395
8893 / 15	25.196.1553.0	336	9701 / 10 SL	07.312.0253.0	195	9704 A / 9 B	04.841.1950.0	791
8893 / 2 OB	25.197.0253.0	336	9701 / 12	07.310.3353.0	191	9704 A / 9 B	04.841.1950.0	181
8893 / 2 ZN	25.196.9253.0	336	9701 / 12 BLAU	07.310.3353.6	191	9704 A / 9 B	04.841.1950.0	599
8893 / 2 ZN OB	25.197.9253.0	336	9701 / 16 SL	07.312.0353.0	189	9704 A / 9 B	04.841.1950.0	395
8893 / 3	25.196.0353.0	336	9701 A SH S35	01.112.1453.0	193	9704 A / 9 B	04.841.1950.0	181
8893 / 3 OB	25.197.0353.0	336	9701 A/6 1S KO TP 2/V0	07.310.5855.0	141	9704 A / 9 B	04.841.1950.0	599
8893 / 3 ZN	25.196.9353.0	336	9701 B / 8 ETK	07.310.5253.0	193	9704 A / 9 B	04.841.1950.0	395
8893 / 3 ZN OB	25.197.9353.0	336	9701 B / 10 ETK	07.310.5353.0	193	9704 A / 9 B	04.841.1950.0	791
8893 / 4	25.196.0453.0	336	9702 / 6	07.310.3453.0	190	9704 A / 9 B	04.841.1950.0	181
8893 / 4 OB	25.197.0453.0	336	9702 / 6 BLAU	07.310.3453.6	190	9704 A / 9 B	04.841.1950.0	598
8893 / 5	25.196.0553.0	336	9702 / 8	07.310.3553.0	191	9704 A / 9 B	04.841.1950.0	791
8893 / 5 OB	25.197.0553.0	336	9702 / 8 BLAU	07.310.3553.6	191	9704 A / 9 B	04.841.1950.0	395
8893 / 6	25.196.0653.0	336	9702 / 10	07.310.4053.0	191	9704 A / 9 B	04.841.1950.0	791
8893 / 6 OB	25.197.0653.0	336	9702 / 10 BLAU	07.310.4053.6	191	9704 A / 9 B	04.841.1950.0	598
8893 / 7	25.196.0753.0	336	9702 / 12	07.310.3653.0	191	9704 A / 9 B	04.841.1950.0	791
8893 / 7 OB	25.197.0753.0	336	9702 / 12 BLAU	07.310.3653.6	191	9704 A / 9 B	04.841.1950.0	395
8893 / 8	25.196.0853.0	336	9703 / 5 M	77.215.0027.0	190	9704 A / 9 B	04.841.1950.0	791
8893 / 8 OB	25.197.0853.0	336	9703 / 5-2	77.215.0227.0	189	9704 A / 9 B	04.841.1950.0	395
8893 / 9	25.196.0953.0	336	9703 / 5-3	77.215.0327.0	191	9704 A / 9 B	04.841.1950.0	791
8893 / 9 OB	25.197.0953.0	336	9703 / 5-4	77.215.0427.0	190	9704 A / 9 B	04.841.1950.0	395
8893 / 10 OB	25.197.1053.0	336	9703 / 5-5	77.215.0527.0	190	9704 A / 9 B	04.841.1950.0	791
8893 / 11 OB	25.197.1153.0	336	9703 / 5-6	77.215.0627.0	190	9704 A / 9 B	04.841.1950.0	395
8893 / 12	25.196.1253.0	336	9703 / 6 M-70	77.211.0027.0	72	9704 A / 9 B	04.841.1950.0	598
8893 / 12 OB	25.197.1253.0	336	9703 / 6-2	77.211.0227.0	72	9704 A / 9 B	04.841.1950.0	395
8893 / 13 OB	25.197.1353.0	336	9703 / 6-3	77.211.0327.0	86	9704 A / 9 B	04.841.1950.0	791
8893 / 14 OB	25.197.1453.0	336	9703 / 6-4	77.211.0427.0	86	9704 A / 9 B	04.841.1950.0	598
8893 / 15 OB	25.197.1553.0	336	9703 / 6-5	77.211.0527.0	86	9704 A / 9 B	04.841.1950.0	791
8893 / 16	25.196.1653.0	336	9703 / 6-6	77.211.0627.0	72	9704 A / 9 B	04.841.1950.0	395
8893 / 16 OB	25.197.1653.0	336	9703 / 8 M-50	77.212.0027.0	196	9704 A / 9 B	04.841.1950.0	791
8893 / 2	25.196.0253.0	336	9703 / 8-2	77.212.0227.0	191	9704 A / 9 B	04.841.1950.0	395
9003 C	04.241.0651.0	584	9703 / 8-3	77.212.0327.0	191	9704 A / 9 B	04.841.1950.0	791
9003 C / 4	04.242.1050.0	394	9703 / 8-4	77.212.0427.0	191	9704 A / 9 B	04.841.1950.0	395
9003 C / 4	04.242.1050.0	584	9703 / 8-5	77.212.0527.0	191	9704 A / 9 B	04.841.1950.0	791
9003 C B	04.841.0651.0	584	9703 / 8-6	77.212.0627.0	191	9704 A / 9 B	04.841.1950.0	395
9006 EN 60715 - G 32	98.190.0000.0	802	9703 / 10 M	77.214.0027.0	196	9704 A / 9 B	04.841.1950.0	598
9006 EN 60715 - G 32	98.190.0000.0	584	9703 / 10-2	77.214.0227.0	189	9704 A / 9 B	04.841.1950.0	791
9006 EN 60715 - G 32	98.190.0000.0	102	9703 / 10-3	77.214.0327.0	191	9704 A / 9 B	04.841.1950.0	395
9006 AL 32	98.210.0000.0	802	9703 / 10-4	77.214.0427.0	191	9704 A / 9 B	04.841.1950.0	791
9006 AL 32	98.210.0000.0	171	9703 / 10-5	77.214.0527.0	191	9704 A / 9 B	04.841.1950.0	395
9006 CU EN 60715 - G 32	98.220.0000.0	110	9703 / 10-6	77.214.0627.0	191	9704 A / 9 B	04.841.1950.0	791
9006 CU EN 60715 - G 32	98.220.0000.0	802	9703 / 12 M	77.213.0027.0	196	9704 A / 9 B	04.841.1950.0	395
9006 GELOCHT	98.190.1000.0	171	9703 / 12-2	77.213.0227.0	191	9704 A / 9 B	04.841.1950.0	791
9006 GELOCHT	98.190.1000.0	802	9703 / 12-4	77.213.0327.0	191	9704 A / 9 B	04.841.1950.0	395
9011 A	05.508.3121.0	191	9703 / 12-5	77.213.0427.0	191	9704 A / 9 B	04.841.1950.0	791
9011 B	05.508.3221.0	101	9703 / 12-6	77.213.0527.0	191	9704 A / 9 B	04.841.1950.0	395
9011 C	05.508.8821.0	176	9703 / 16 M	77.216.0027.0	196	9704 A / 9 B	04.841.1950.0	791
9011 D	05.508.8921.0	176	9703 / 16-2	77.216.0227.0	189	9704 A / 9 B	04.841.1950.0	395
9012	27.269.0723.0	197	9703 / 16-3	77.216.0327.0	192	9704 A / 9 B	04.841.1950.0	791
9012 / 2.5 UB	27.269.0623.0	161	9703 / 16-4	77.216.0427.0	192	9704 A / 9 B	04.841.1950.0	395
9012 / 6	27.269.0523.0	197	9703 / 16-5	77.216.0527.0	192	9704 A / 9 B	04.841.1950.0	791
9018 D	25.516.2511.0	169	9703 / 16-6	77.216.0627.0	192	9704 A / 9 B	04.841.1950.0	395
9018 H	25.516.2711.0	169	9704 A	04.241.1150.0	598	9704 A / 9 B	04.841.1950.0	791
9018 N	25.516.2811.0	169	9704 A	04.241.1150.0	791	9704 A / 9 B	04.841.1950.0	395
9021/15X5.5EN60715	98.090.0000.0	802	9704 A / 0 B	04.241.1150.0	181	9704 A / 9 B	04.841.1950.0	599
9021/15X5.5EN60715	98.090.0000.0	171	9704 A / 0 B	04.841.2050.0	791	9704 A / 9 B	04.841.1950.0	395
9021/15X5.5EN60715	98.090.0015.0	40	9704 A / 0 B	04.841.2050.0	598	9704 A / 9 B	04.841.1950.0	791
9021/15X5.5EN60715	98.090.0015.0	802	9704 A / 0 B	04.841.2050.0	395	9704 A / 9 B	04.841.1950.0	598
9208 / S15	75.522.7553.0	40	9704 A / 0 B	04.841.2050.0	181	9704 A / 9 B	04.841.1950.0	395
9215 - 2	77.210.3227.0	114	9704 A / 1 B	04.841.1150.0	598	9704 A / 9 B	04.841.1950.0	791
9215 - 3	77.210.3327.0	114	9704 A / 1 B	04.841.1150.0	791	9704 A / 9 B	04.841.1950.0	395
9215 - 4	77.210.3427.0	164	9704 A / 1 B	04.841.1150.0	181	9704 A / 9 B	04.841.1950.0	599
9215 - 5	77.210.3527.0	114	9704 A / 1 B	04.841.1150.0	395	9704 A / 9 B	04.841.1950.0	791
9215 - 6	77.210.3627.0	114	9704 A / 1 B	04.841.1150.0	598	9704 A / 9 B	04.841.1950.0	395
9215 M-70	77.210.3027.0	164						

contents

Type	Part no.	section / page	Type	Part no.	section / page	Type	Part no.	section / page
9704 A /LG B	04.841.3350.0	395	9705 A / 6 /10/11MARCOM	Z4.242.6053.0	49	9705A/8/10B L1L2L3NPE.	04.858.0853.0	201
9704 A /LK B	04.841.5950.0	395	9705 A / 6,7/6-90GRAD	04.242.3053.0	790	9705A/8/10B L2	04.858.0553.0	201
9704 A /LK B	04.841.5950.0	791	9705 A / 6,7/6-90GRAD 5	04.242.3453.0	790	9705A/8/10B L3	04.858.0653.0	201
9704 A /MG B	04.841.3450.0	791	9705 A / 6,7/6-90GRAD 8	04.242.3553.0	790	9705A/8/10B N	04.858.3253.0	201
9704 A /MG B	04.841.3450.0	395	9705 A / 6,7/6-90GRAD12	04.242.3653.0	395	9705A/8/10B PE	04.858.0753.0	201
9704 A /MG B	04.841.3450.0	598	9705 A / 6,7/9-90GRAD 3	04.242.3353.0	790	9705A/8/10B SL	04.858.3153.0	201
9704 A /MK B	04.841.6050.0	599	9705 A / 7,5 / 10	04.242.7553.0	351	9705A/8/10B SLZ	04.858.0053.0	201
9704 A /MK B	04.841.6050.0	791	9705 A / 7,5 / 10 B	04.842.7553.0	351	9708	25.522.7053.0	102
9704 A /MK B	04.841.6050.0	395	9705 A / 8 / 10	04.242.8053.0	201	9708 / 2 S 35	25.522.8553.0	19
9704 A /NG B	04.841.3550.0	791	9705 A / 8 / 10 / 5 B	04.842.8553.0	91	9708 / 2 S 35	25.522.8553.0	410
9704 A /NG B	04.841.3550.0	395	9705 A / 8 / 10 B	04.842.8053.0	189	9708 / 2 S 35	25.522.8553.0	308
9704 A /NG B	04.841.3550.0	598	9705 A B	04.842.0850.0	588	9708 / 3 S35	25.523.5153.0	173
9704 A /NK B	04.841.6150.0	395	9705 A B	04.842.0850.0	90	9760 U/8 TKE 48 V/V0	57.110.1655.0	133
9704 A /NK B	04.841.6150.0	791	9705 A B	04.842.0850.0	321	9760 U/8 TKE 220 V/V0	57.110.1555.0	133
9704 A /NK B	04.841.6150.0	599	9705 A B	04.842.0850.0	790	9785U/1 KOHM-SPT/V0	57.904.4655.0	130
9704 A /OG B	04.841.3650.0	598	9705 A L / 5 / 10	04.242.5153.0	596	9785U/1 KOHM/V0	57.904.0655.0	130
9704 A /OG B	04.841.3650.0	791	9705 A L / 5 / 10	04.242.5153.0	790	9785U/10 KOHM-SPT/V0	57.904.4955.0	130
9704 A /OG B	04.841.3650.0	395	9705 A L / 5 / 10	04.242.5153.0	394	9785U/10 KOHM/V0	57.904.0955.0	130
9704 A /OK B	04.841.6250.0	599	9705 A L / 5 / 10	04.242.5153.0	91	9785U/10 OHM-SPT/V0	57.904.3955.0	130
9704 A /OK B	04.841.6250.0	395	9705 A L / 5 / 10 B	04.842.5153.0	790	9785U/10 OHM/V0	57.904.0055.0	130
9704 A /OK B	04.841.6250.0	791	9705 A L / 6 / 10	04.242.6353.0	91	9785U/100 OHM-SPT/V0	57.904.4355.0	130
9704 A /PG B	04.841.3750.0	395	9705 AL	04.242.1553.0	410	9785U/100 OHM/V0	57.904.0355.0	130
9704 A /PG B	04.841.3750.0	791	9705 AL	04.242.1553.0	90	9785U/2 KOHM-SPT/V0	57.904.4755.0	130
9704 A /PG B	04.841.3750.0	598	9705 AL	04.242.1553.0	394	9785U/2 KOHM/V0	57.904.0755.0	130
9704 A /PK B	04.841.6350.0	395	9705 AL	04.242.1553.0	790	9785U/20 KOHM-SPT/V0	57.904.5055.0	130
9704 A /PK B	04.841.6350.0	791	9705 AL B	04.842.1553.0	394	9785U/20 KOHM/V0	57.904.1055.0	130
9704 A /PK B	04.841.6350.0	599	9705 AL B	04.842.1553.0	596	9785U/20 OHM-SPT/V0	57.904.4155.0	130
9704 A /OG B	04.841.3850.0	598	9705 AL B	04.842.1553.0	790	9785U/20 OHM/V0	57.904.0155.0	130
9704 A /OG B	04.841.3850.0	791	9705 AL B	04.842.1553.0	90	9785U/200 OHM-SPT/V0	57.904.4455.0	130
9704 A /OK B	04.841.6450.0	395	9705 AL 5 /10/ 6MARCOM	Z4.242.5153.0	442	9785U/200 OHM/V0	57.904.0455.0	130
9704 A /OK B	04.841.6450.0	791	9705 AL 5 /10/ 6MARCOM	Z4.242.5153.0	49	9785U/5 KOHM-SPT/V0	57.904.4855.0	130
9704 A /OK B	04.841.6450.0	395	9705A/5/ 9 B 1- 9	04.842.4953.0	596	9785U/5 KOHM/V0	57.904.0855.0	130
9704 A /OK B	04.841.6450.0	599	9705A/5/ 9 B 1- 9	04.842.4953.0	394	9785U/50 KOHM-SPT/V0	57.904.5155.0	130
9704 A /RG B	04.841.3950.0	395	9705A/5/ 10 B 1- 10	04.845.0153.0	91	9785U/50 KOHM/V0	57.904.1155.0	130
9704 A /RG B	04.841.3950.0	598	9705A/5/ 10 B 11- 20	04.845.0253.0	91	9785U/50 OHM-SPT/V0	57.904.4255.0	130
9704 A /RG B	04.841.3950.0	791	9705A/5/ 10 B 21- 30	04.845.0353.0	91	9785U/50 OHM/V0	57.904.0255.0	130
9704 A /RK B	04.841.6550.0	395	9705A/5/ 10 B 31- 40	04.845.0453.0	91	9785U/500 OHM-SPT/V0	57.904.4555.0	130
9704 A /RK B	04.841.6550.0	791	9705A/5/ 10 B 41- 50	04.845.0553.0	91	9785U/500 OHM/V0	57.904.0555.0	130
9704 A /RK B	04.841.6550.0	599	9705A/5/ 10 B 51- 60	04.845.0653.0	91	9786U/12/V0	57.904.2055.0	131
9704 A /SG B	04.841.4050.0	791	9705A/5/ 10 B 61- 70	04.845.0753.0	91	9786U/TSK CU-CUNI/V0	57.904.7355.0	132
9704 A /SG B	04.841.4050.0	598	9705A/5/ 10 B 71- 80	04.845.0853.0	91	9786U/TSK E-CU-A-CU/V0	57.904.7455.0	132
9704 A /SK B	04.841.6650.0	395	9705A/5/ 10 B 81- 90	04.845.0953.0	91	9786U/TSK FE-CUNI/V0	57.904.7155.0	132
9704 A /SK B	04.841.6650.0	791	9705A/5/ 10 B 91-100	04.845.1053.0	91	9786U/TSK NICKR-NI/V0	57.904.7055.0	132
9704 A /SK B	04.841.6650.0	599	9705A/5/ 10 B +	04.855.0253.0	91	9813 M 10X3 1000MM	98.290.0000.0	72
9704 A /TG B	04.841.4150.0	598	9705A/5/ 10 B + ROT	04.855.0253.5	120	9813 M SN 10X3 1000MM	98.290.1000.0	24
9704 A /TG B	04.841.4150.0	395	9705A/5/ 10 B -	04.855.0353.0	91	A BIS Z GB	04.841.9150.0	791
9704 A /TG B	04.841.4150.0	791	9705A/5/ 10 B - BLAU	04.855.0353.6	120	A BIS Z GB	04.841.9150.0	395
9704 A /TK B	04.841.6750.0	791	9705A/5/ 10B ERDZ	04.855.0153.0	91	A BIS Z GB	04.841.9150.0	181
9704 A /TK B	04.841.6750.0	395	9705A/5/ 10B F1	04.855.0953.0	91	A BIS Z KB	04.841.9250.0	395
9704 A /TK B	04.841.6750.0	599	9705A/5/ 10B F2	04.855.1053.0	91	A BIS Z KB	04.841.9250.0	181
9704 A /TK B	04.841.6750.0	598	9705A/5/ 10B L1	04.855.0453.0	91	A BIS Z KB	04.841.9250.0	791
9704 A /UG B	04.841.4250.0	598	9705A/5/ 10B L1L2L3NPE.	04.855.0853.0	91	ABDECKG M WARNZCH	04.343.5395.8	105
9704 A /UG B	04.841.4250.0	791	9705A/5/ 10B L2	04.855.0553.0	91	ABDECKG M WARNZCH	04.343.5495.8	105
9704 A /UK B	04.841.6850.0	791	9705A/5/ 10B L3	04.855.0653.0	91	ABDECKG M WARNZCH	04.325.1055.0	189
9704 A /UK B	04.841.6850.0	395	9705A/5/ 10B N	04.855.3253.0	91	ABDECKG M WARNZCH	04.325.1155.0	189
9704 A /UK B	04.841.6850.0	599	9705A/5/ 10B PE	04.855.0753.0	91	ABDECKG M WARNZCH	04.325.1255.0	189
9704 A /VG B	04.841.4350.0	598	9705A/5/ 10B SL	04.855.3153.0	91	ABDECKG M WARNZCH	04.325.1355.0	191
9704 A /VG B	04.841.4350.0	791	9705A/5/ 10B SLZ	04.855.0053.0	91	ABDECKG M WARNZCH	04.325.1455.0	189
9704 A /VG B	04.841.4350.0	395	9705A/6/ 7/ 12	04.242.6753.0	790	ABDECKG M WARNZCH	04.325.1655.0	189
9704 A /VK B	04.841.6950.0	791	9705A/6/ 7/ 12 B	04.842.6753.0	790	ABDECKG M WARNZCH	04.343.4755.8	102
9704 A /VK B	04.841.6950.0	395	9705A/6/ 7/ 12 B 1- 9	99.000.0920.8	790	ABDECKG M WARNZCH	04.343.4855.8	69
9704 A /VK B	04.841.6950.0	599	9705A/6/ 7/ 12 B 10- 10	99.003.0920.8	790	ABDECKG M WARNZCH	04.343.4955.8	103
9704 A /WG B	04.841.4450.0	395	9705A/6/ 7/ 2X12 B 1- 6	99.002.0920.8	790	ABDECKG M WARNZCH	04.343.5055.8	103
9704 A /WG B	04.841.4450.0	791	9705A/6/ 7/ 2X12 B 1-16	99.004.0920.8	790	ABDECKG M WARNZCH	04.343.5155.8	104
9704 A /WG B	04.841.4450.0	598	9705A/6/ 7/ 2X12 B 1-24	99.005.0920.8	790	ABDECKG M WARNZCH	04.343.5255.8	105
9704 A /WK B	04.841.7050.0	599	9705A/6/ 9 B 1- 9	04.842.5953.0	91	ABDECKG M WARNZCH	04.343.9155.8	312
9704 A /WK B	04.841.7050.0	395	9705A/6/ 10 B 1- 10	04.846.0153.0	91	ABDECKG M WARNZCH	04.343.9155.8	134
9704 A /WK B	04.841.7050.0	791	9705A/6/ 10 B 11- 20	04.846.0253.0	91	ABDECKPLATTE 10	07.416.6953.0	784
9704 A /XG B	04.841.4550.0	395	9705A/6/ 10 B 21- 30	04.846.0353.0	91	ABDECKPLATTE 16	07.416.7053.0	784
9704 A /XG B	04.841.4550.0	598	9705A/6/ 10 B 31- 40	04.846.0453.0	91	ABDECKPLATTE 24	07.416.7153.0	784
9704 A /XG B	04.841.4550.0	791	9705A/6/ 10 B 41- 50	04.846.0553.0	91	ABDECKPLATTE 6	07.416.6853.0	784
9704 A /XK B	04.841.7150.0	395	9705A/6/ 10 B 51- 60	04.846.0653.0	91	ABDECKSTREIFEN	04.343.9055.8	312
9704 A /XK B	04.841.7150.0	791	9705A/6/ 10 B 61- 70	04.846.0753.0	91	ABDECKSTREIFEN	04.343.9055.8	134
9704 A /XK B	04.841.7150.0	599	9705A/6/ 10 B 71- 80	04.846.0853.0	91	ABDECKUNG	04.312.0554.0	584
9704 A /YG B	04.841.4650.0	598	9705A/6/ 10 B 81- 90	04.846.0953.0	91	ABDECKUNG	04.312.0654.0	584
9704 A /YG B	04.841.4650.0	791	9705A/6/ 10 B 91-100	04.846.1053.0	91	ABDECKUNG	04.312.2056.0	125
9704 A /YG B	04.841.4650.0	395	9705A/6/ 10 B ERDZ	04.856.0153.0	91	ABDECKUNG	04.312.3054.0	585
9704 A /YK B	04.841.7250.0	395	9705A/6/ 10 B L1	04.856.0453.0	19	ABDECKUNG	04.312.3254.0	587
9704 A /YK B	04.841.7250.0	599	9705A/6/ 10 B L2	04.856.0553.0	91	ABDECKUNG	04.312.3354.0	585
9704 A /YK B	04.841.7250.0	791	9705A/6/ 10 B L3	04.856.0653.0	91	ABDECKUNG	04.312.3454.0	586
9704 A /ZG B	04.841.4750.0	395	9705A/6/ 10 B SLZ	04.856.0053.0	91	ABDECKUNG	04.312.3554.0	587
9704 A /ZG B	04.841.4750.0	791	9705A/6/ 10B +	04.856.0253.0	91	ABDECKUNG	04.326.0056.0	152
9704 A /ZG B	04.841.4750.0	598	9705A/6/ 10B -	04.856.0353.0	91	ABDECKUNG	04.326.1053.0	128
9704 A /ZK B	04.841.7350.0	599	9705A/6/ 10B F1	04.856.0953.0	91	ABDECKUNG	04.343.6853.8	308
9704 A /ZK B	04.841.7350.0	791	9705A/6/ 10B F2	04.856.1053.0	91	ABDECKUNG	04.343.6853.8	36
9704 A /ZK B	04.841.7350.0	395	9705A/6/ 10B L1L2L3NPE.	04.856.0853.0	91	ABDECKUNG	04.343.8353.8	33
9705 A	04.242.0850.0	598	9705A/6/ 10B N	04.856.3253.0	91	ABDECKUNG	27.409.5753.0	156
9705 A	04.242.0850.0	321	9705A/6/ 10B PE	04.856.0753.0	91	ABDECKUNG	27.409.5853.0	158
9705 A	04.242.0850.0	90	9705A/6/ 10B SL	04.856.3153.0	91	ABSCHLUSSTANGE	95.350.0100.0	799
9705 A	04.242.0850.0	790	9705A/8/ 9 B 1- 9	04.842.7953.0	201	ABSCHLUSSPLM BEZ	07.340.4153.0	152
9705 A / 4 W	04.242.2853.0	790	9705A/8/ 10 B 1- 10	04.848.0153.0	201	ABSCHLUSSPLM BEZ	07.340.4253.0	152
9705 A / 5 / 10	04.242.5053.0	349	9705A/8/ 10 B 11- 20	04.848.0253.0	201	ABSCHLUSSPLATTE	07.310.8453.0	584
9705 A / 5 / 10	04.242.5053.0	91	9705A/8/ 10 B 21- 30	04.848.0353.0	201	ABSCHLUSSPLATTE	07.310.8553.0	584
9705 A / 5 / 10	04.242.5053.0	596	9705A/8/ 10 B 31- 40	04.848.0453.0	201	ABSCHLUSSPLATTE	07.310.9653.0	591
9705 A / 5 / 1								

contents of
type description

contents

Type	Part no.	section / page	Type	Part no.	section / page	Type	Part no.	section / page
AD VB 6/10 P GELB	04.342.3656.8	103	ADA.I.GEH.ST.10WR	71.955.1053.3	667	APF 2,5/D2 /8113	07.312.4153.0	308
AD VB 8/10 P GELB	04.342.3856.8	103	ADA.I.GEH.ST.10WR	71.955.1053.4	667	APF 2,5/D2 /8113 BLAU	07.312.4153.6	36
AD VB 10 GELB	04.326.2353.8	82	ADA.I.GEH.ST.10WR	71.975.1053.3	671	APF 2,5/d2/8113 BLAU	07.312.4153.6	36
AD VB 10/10 GELB	04.342.1056.8	78	ADA.I.GEH.ST.10WR	71.975.1053.4	671	APF 2,5/d2/8113 BLAU	07.312.4153.6	308
AD VB 10/10 P GELB	04.342.4056.8	103	ADA.I.GEH.ST.10WR	72.955.1053.0	669	APF 4 E	07.312.5753.0	30
AD VB 16 GELB	04.326.2453.8	69	ADA.I.GEH.ST.10WR	77.955.1053.0	669	APF 4 E GRUEN	07.312.5753.7	31
AD VB 35 GELB	04.326.2553.8	105	ADA.I.GEH.ST.16WL	70.950.1653.3	667	APF 4 NT	07.312.5653.0	24
AD VB 70 GELB	04.326.2653.8	105	ADA.I.GEH.ST.16WL	70.950.1653.4	667	APF 4 TK	07.312.2853.0	38
AD VB WKM 2,5 / 15 GELB	04.326.3053.8	144	ADA.I.GEH.ST.16WL	71.950.1653.3	667	APF 4 TK	07.312.4353.0	39
AD VM-1,5/8 SCHWARZ	04.343.8053.0	45	ADA.I.GEH.ST.16WL	71.950.1653.4	667	APF4/D1/2	07.312.4853.0	27
ADA.I.GEH. 3WR	70.965.0353.4	671	ADA.I.GEH.ST.16WL	72.950.1653.0	669	APF4/D1/2 BLAU	07.312.4853.6	27
ADA.I.GEH.BU. 3WL	70.960.0353.3	671	ADA.I.GEH.ST.16WL	77.950.1653.0	669	APF4/D1/2 GRUEN	07.312.4853.7	29
ADA.I.GEH.BU. 3WL	70.960.0353.4	671	ADA.I.GEH.ST.16WR	70.955.1653.3	667	API 10 - 16 BLAU/V0	07.311.9455.6	78
ADA.I.GEH.BU. 3WL	71.960.0353.3	671	ADA.I.GEH.ST.16WR	70.955.1653.4	667	API 10 - 16 SL/V0	07.311.9555.0	82
ADA.I.GEH.BU. 3WL	71.960.0353.4	671	ADA.I.GEH.ST.16WR	71.955.1653.3	667	API 10 - 16/W0	07.311.9455.0	78
ADA.I.GEH.BU. 3WR	70.965.0353.3	671	ADA.I.GEH.ST.16WR	71.955.1653.4	667	API 10-16 ETK/1/V0	07.312.1955.0	80
ADA.I.GEH.BU. 3WR	71.965.0353.3	671	ADA.I.GEH.ST.16WR	72.955.1653.0	669	API 35 BLAU/V0	07.311.8855.6	79
ADA.I.GEH.BU. 3WR	71.965.0353.4	671	ADA.I.GEH.ST.16WR	72.955.1653.4	669	API 35/V0	07.311.8855.0	79
ADA.I.GEH.BU. 6WL	70.940.0653.3	667	ADA.I.GEH.ST.16WR	77.955.1653.0	669	API 4/2/V0	07.311.6555.0	69
ADA.I.GEH.BU. 6WL	70.960.0653.3	671	ADA.I.GEH.ST.24WL	70.950.2453.3	667	API 4/2/V0	07.311.6555.0	69
ADA.I.GEH.BU. 6WL	70.960.0653.4	671	ADA.I.GEH.ST.24WL	70.950.2453.4	667	APIF 2,5	07.311.8353.0	58
ADA.I.GEH.BU. 6WL	71.960.0653.3	671	ADA.I.GEH.ST.24WL	71.950.2453.3	667	APM 2,5 - 4 / 15	07.311.0853.0	145
ADA.I.GEH.BU. 6WL	71.960.0653.4	671	ADA.I.GEH.ST.24WL	71.950.2453.4	667	APM 2,5 - 4 / 15 BLAU	07.311.0853.6	145
ADA.I.GEH.BU. 6WR	72.940.0653.0	669	ADA.I.GEH.ST.24WL	72.950.2453.0	669	APM 2,5 F. / 15	07.311.0653.0	144
ADA.I.GEH.BU. 6WR	70.945.0653.3	667	ADA.I.GEH.ST.24WL	77.950.2453.0	669	APM 4 SL / 15	07.311.0753.0	145
ADA.I.GEH.BU. 6WR	70.945.0653.4	667	ADA.I.GEH.ST.24WR	70.955.2453.3	667	APN 4ETK /V0	07.312.1155.0	106
ADA.I.GEH.BU. 6WR	70.965.0653.3	671	ADA.I.GEH.ST.24WR	70.955.2453.4	667	APN 10 /V0	07.311.6655.0	103
ADA.I.GEH.BU. 6WR	70.965.0653.4	671	ADA.I.GEH.ST.24WR	71.955.2453.3	667	APN 10 BL/V0	07.311.6655.6	103
ADA.I.GEH.BU. 6WR	71.965.0653.4	671	ADA.I.GEH.ST.24WR	71.955.2453.4	667	APN 10ETK /V0	07.312.0955.0	106
ADA.I.GEH.BU. 6WR	72.945.0653.0	669	ADA.I.GEH.ST.24WR	72.955.2453.0	669	APN 16 /V0	07.311.6755.0	104
ADA.I.GEH.BU.06WL	70.940.0653.4	667	ADA.I.GEH.ST.24WR	77.955.2453.0	669	APN 16 BL/V0	07.311.6755.6	104
ADA.I.GEH.BU.10WL	70.940.1053.3	667	ADA.I.GEH.ST.3WL	70.970.0353.4	671	APN 16ETK /V0	07.312.0855.0	107
ADA.I.GEH.BU.10WL	70.940.1053.4	667	ADC 2,5 GELB	04.344.0353.8	231	APN2,5E	07.312.1755.0	116
ADA.I.GEH.BU.10WL	70.960.1053.3	671	ADF 2,5/4 GELB	04.343.6053.8	308	AUSDRUECKWERKZEUG	05.502.0200.0	207
ADA.I.GEH.BU.10WL	70.960.1053.4	671	ADF 2,5/4 GELB	04.343.6053.8	20	B EXP.BOARD WEG 6 POL	28.000.0123.1	592
ADA.I.GEH.BU.10WL	70.965.1053.4	667	ADF 4/4 GELB	04.343.6153.8	19	BEF.HALTER	05.522.7356.0	331
ADA.I.GEH.BU.10WL	71.940.1053.3	667	ADF 6/4 GELB	04.343.6253.8	21	BEF.HALTER	05.522.7756.0	331
ADA.I.GEH.BU.10WL	71.940.1053.4	667	ADF10/4 GELB	04.343.6453.8	21	BEF.HALTER	05.522.7856.0	331
ADA.I.GEH.BU.10WL	71.960.1053.3	671	ADF16/4 GELB	04.343.6653.8	21	BEF.HALTER	05.593.8853.0	331
ADA.I.GEH.BU.10WL	71.960.1053.4	671	AEI 1,5Z-N	05.599.2027.0	797	BEF.HALTER	05.599.2853.0	331
ADA.I.GEH.BU.10WL	72.940.1053.0	669	AKB 10 V / 20MA	57.806.0053.0	504	BEF.HALTER	05.599.2953.0	331
ADA.I.GEH.BU.10WL	77.940.1053.0	669	AKB 10 V /4-20MA	57.806.1553.0	504	BEF.HALTER	25.523.2453.0	297
ADA.I.GEH.BU.10WR	70.945.1053.3	667	AKB 20MA / 10 V	57.806.0253.0	504	BEF.HALTER	25.523.7753.0	295
ADA.I.GEH.BU.10WR	70.945.1053.4	667	AKB 4-20MA / 10 V	57.806.0353.0	504	BEF.HALTER	25.523.7853.0	295
ADA.I.GEH.BU.10WR	70.965.1053.3	671	AKT 10 V /4-20MA	57.806.0953.0	505	BEFEST.HALT.KOMPL	25.523.7653.0	319
ADA.I.GEH.BU.10WR	71.945.1053.3	667	AKT 10 V / 20MA	57.806.0653.0	505	BEZ - SCHILD	04.240.0950.0	392
ADA.I.GEH.BU.10WR	71.945.1053.4	667	AKT 20MA / 10 V	57.806.0753.0	505	BEZ BLATT PERF.	04.019.0289.0	47
ADA.I.GEH.BU.10WR	71.965.1053.4	671	AKT 20MA / 20MA	57.806.1153.0	505	BEZ BLATT PERF.	04.019.0889.0	183
ADA.I.GEH.BU.10WR	72.945.1053.0	669	AKT 20MA /4-20MA	57.806.1253.0	505	BEZ KLAPPSCHILD	04.210.0652.0	183
ADA.I.GEH.BU.10WR	77.945.1053.0	669	AKT 0-10 V /+10 V	57.806.2653.0	505	BEZ KLAPPSCHILD	04.210.0752.0	183
ADA.I.GEH.BU.16WL	70.940.1653.3	667	AKT 0-20MA /+10 V	57.806.2753.0	505	BEZ KLAPPSCHILD	24.210.0652.0	183
ADA.I.GEH.BU.16WL	70.940.1653.4	667	AKT 4-20MA / 10 V	57.806.0853.0	505	BEZ KLAPPSCHILD	24.210.1652.0	183
ADA.I.GEH.BU.16WL	71.940.1653.3	667	AKT 4-20MA / 20MA	57.806.1353.0	505	BEZ PLATTE	04.249.1053.0	499
ADA.I.GEH.BU.16WL	71.940.1653.4	667	AKT 4-20MA /+10 V	57.806.5553.0	505	BEZ PLATTE	04.249.1553.0	499
ADA.I.GEH.BU.16WL	72.940.1653.0	669	AKT + 10 V /+10 V	57.806.1053.0	505	BEZ PLATTE	04.249.2053.0	499
ADA.I.GEH.BU.16WL	72.940.1653.0	669	AKT + 10 V /0-10 V	57.806.2253.0	505	BEZ PLATTE	04.249.4053.0	499
ADA.I.GEH.BU.16WR	70.945.1653.3	667	AKT + 10 V /4-20MA	57.806.2153.0	505	BEZ PLATTE	07.340.2153.0	152
ADA.I.GEH.BU.16WR	70.945.1653.4	667	AM 5 X 12 D 933SZMS	06.065.0021.0	156	BEZ PLATTE	07.340.2353.0	152
ADA.I.GEH.BU.16WR	71.945.1653.3	667	ANKERSCHIENE 2M	98.400.0000.0	210	BEZ.SCHILD.TRAEGER	04.242.3853.0	781
ADA.I.GEH.BU.16WR	71.945.1653.4	667	AP 2,5 - 4 /V0	07.311.0155.0	78	BEZ.SCHILD.TRAEGER	04.242.4253.0	349
ADA.I.GEH.BU.16WR	72.945.1653.0	669	AP 2,5 - 4 BL/V0	07.311.0155.6	78	BEZ.SCHILD.TRAEGER	04.242.4453.0	781
ADA.I.GEH.BU.16WR	77.945.1653.0	669	AP 2,5 U/8113 S/V /V0	07.312.1555.0	136	BEZ.SCHILD.TRAEGER	04.242.4653.0	357
ADA.I.GEH.BU.24WL	70.940.2453.3	667	AP 2,5 U/8113 S/V /V0	07.312.1555.0	310	BEZ.SCHILD.TRAEGER	04.242.5853.0	349
ADA.I.GEH.BU.24WL	70.940.2453.4	667	AP 4 TK /V0	07.311.6155.0	123	BEZ.SCHILD.TRAEGER	24.242.3753.0	781
ADA.I.GEH.BU.24WL	71.940.2453.3	667	AP 4 TK BL /V0	07.311.6155.6	123	BEZ.SCHILD.TRAEGER	24.242.4053.0	781
ADA.I.GEH.BU.24WL	71.940.2453.4	667	AP 6 BL/V0	07.311.0255.0	103	BEZ.SCHILD.TRAEGER	24.242.3753.0	781
ADA.I.GEH.BU.24WL	72.940.2453.0	669	AP 6 BL/V0	07.311.0255.6	103	BEZEICHNUNGS-COMPUTER	95.500.0000.0	90
ADA.I.GEH.BU.24WL	77.940.2453.0	669	AP 1 - 2,5	07.312.5053.0	232	BGL-25VAC-2,5ADC	81.000.1000.0	526
ADA.I.GEH.BU.24WR	70.945.2453.3	667	AP 1 - 2,5 BLAU	07.312.5053.6	232	BGL-40VAC-3ADC	87.230.2053.0	526
ADA.I.GEH.BU.24WR	70.945.2453.4	667	AP 1 - 2,5 GRUEN	07.312.5053.7	233	BK M 8 / 32	32.650.0042.0	152
ADA.I.GEH.BU.24WR	71.945.2453.3	667	AP 10/Sl /V0	07.311.4155.0	125	BK M 6 / 32	32.630.0042.0	152
ADA.I.GEH.BU.24WR	71.945.2453.4	667	AP 2,5 U/8113 S/V BL/V0	07.312.1555.6	137	BU 70,3 /24 REV	25.570.1356.0	675
ADA.I.GEH.BU.24WR	72.945.2453.0	669	AP 2,5 U/D/8113 S/V/V0	07.311.9055.0	134	BU 70,1 / 6 REV WL	25.572.0156.0	675
ADA.I.GEH.BU.24WR	77.945.2453.0	669	AP 2,5 U/D/8113 S/V/V0	07.311.9055.0	312	BU 70,1 / 6 REV WR	25.572.1156.0	675
ADA.I.GEH.BU.24WR	70.970.0353.3	671	AP 2,5-4 K0/V0	07.310.9355.0	120	BU 70,1 / 6 REV U WL	25.572.4156.0	675
ADA.I.GEH.ST. 3WL	71.970.0353.4	671	AP 2,5U/8113 /V0	07.312.4655.0	136	BU 70,1 / 6 REV U WR	25.572.5156.0	675
ADA.I.GEH.ST. 3WR	70.975.0353.3	671	AP 2,5U/8113 /V0	07.312.4655.0	310	BU 70,1 / 6 REV WL	25.572.2156.0	675
ADA.I.GEH.ST. 3WR	70.975.0353.4	671	AP 2,5U/8113S/H/V0	07.311.9855.0	311	BU 70,1 / 6 REV WR	25.572.3156.0	675
ADA.I.GEH.ST. 6WL	70.950.0653.3	667	AP 3 S / IW/V0	07.311.4555.0	140	BU 70,1 / 6 REV U WL	25.572.6156.0	675
ADA.I.GEH.ST. 6WL	70.970.0653.3	671	AP 3 S/V0	07.311.4455.0	140	BU 70,1 / 6 REV U WR	25.572.7156.0	675
ADA.I.GEH.ST. 6WL	71.970.0653.3	671	AP 4 3S 1K / V0	07.311.3855.0	138	BU 70,1 / 10 REV WL	25.572.0256.0	675
ADA.I.GEH.ST. 6WL	71.970.0653.4	671	AP 4 E /V0	07.311.4055.0	114	BU 70,1 / 10 REV WR	25.572.1256.0	675
ADA.I.GEH.ST. 6WL	71.970.0653.4	671	AP 4 S / IW/V0	07.311.4355.0	141	BU 70,1 / 10 REV U WL	25.572.4256.0	675
ADA.I.GEH.ST. 6WL	71.970.0653.4	671	AP 4 S/V0	07.311.4255.0	141	BU 70,1 / 10 REV U WR	25.572.5256.0	675
ADA.I.GEH.ST. 6WR	72.950.0653.0	669	AP 4/D /V0	07.311.6355.0	112	BU 70,1 / 10 REV WL	25.572.2256.0	675
ADA.I.GEH.ST. 6WR	70.955.0653.3	667	AP 4/D BL /V0	07.311.6355.6	112	BU 70,1 / 10 REV WR	25.572.3256.0	675
ADA.I.GEH.ST. 6WR	70.955.0653.4	667	AP 5 S/V0	07.311.4655.0	139	BU 70,1 / 10 REV U WL	25.572.6256.0	675
ADA.I.GEH.ST. 6WR	70.975.0653.3	671	AP 8113 SE	07.310.9853.0	303	BU 70,1 / 10 REV U WR	25.572.7256.0	675
ADA.I.GEH.ST. 6WR	70.975.0653.4	671	AP 8185 TOP N	07.300.4753.0	349	BU 70,1 / 16 REV WL	25.572.0056.0	675
ADA.I.GEH.ST. 6WR	71.975.0653.3	671	AP2,5U/D/8113 S/V BL/V0	07.311.4055.6	313	BU 70,1 / 16 REV WR	25.572.1056.0	675
ADA.I.GEH.ST. 6WR	71.975.0653.4	671	AP4 /D1 /2 /V0	07.311.6455.0	112	BU 70,1 / 16 REV U WL	25.572.4056.0	675
ADA.I.GEH.ST. 6WR	72.955.0653.0	669	APC 1-2,5 D 2 /E. BLAU	07.312.5453.6	236	BU 70,1 / 16 REV U WR	25.572.5056.0	675
ADA.I.GEH.ST.06WL	70.950.0653.4	667	APC 1-2,5 D 2 /E. GRUEN	07.312.5453.7	237	BU 70,1 / 16 REV WL	25.572.2056.0	675
ADA.I.GEH.ST.10WL	70.950.1053.3	667	APC 1-2,5 D /TK	07.312.5253.0	234	BU 70,1 / 16 REV WR	25.572.3056.0	675
ADA.I.GEH.ST.10WL	70.950.1053.4	667	APC 1-2,5 D /TK. BLAU	07.312.5253.6	234	BU 70,1 / 16 REV U WL	25.572.6056.0	675
ADA.I.GEH.ST.10WL	70.970.1053.3	671	APC 1-2,5 D /TK. GRUEN	07.312.5253.7	235	BU 70,1 / 16 REV U WR	25.572.7056.0	675
ADA.I.GEH.ST.10WL	70.97							

contents

Type	Part no.	section / page	Type	Part no.	section / page	Type	Part no.	section / page
BU 70.3 / 6 RVZ	Z5.570.2156.0	675	BU 73.1 / 64 RV U WR	Z5.572.9856.0	683	BZ KL 16 / 6 Z	Z4.102.0680.0	256
BU 70.3 / 10 REV	Z5.570.1256.0	675	BU 73.7 / 40 REV	Z5.570.7056.0	683	BZ KL 16 / 8 Z	Z4.102.0880.0	256
BU 70.3 / 10 REVZ	Z5.570.0256.0	675	BU 73.7 / 40 REVZ	Z5.570.6056.0	683	BZ KL 16 / 12 Z	Z4.102.1280.0	256
BU 70.3 / 10 RV	Z5.570.3256.0	675	BU 73.7 / 40 RV	Z5.570.9056.0	683	BZ KL 16 / 16 Z	Z4.102.1680.0	256
BU 70.3 / 10 RVZ	Z5.570.2256.0	675	BU 73.7 / 40 RVZ	Z5.570.8056.0	683	BZ KL 16 / 20 Z	Z4.102.2080.0	256
BU 70.3 / 16 REV	Z5.570.1056.0	675	BU 73.7 / 64 REV	Z5.570.7156.0	683	BZ KL 16 / 20 Z B	Z4.802.2080.0	256
BU 70.3 / 16 REVZ	Z5.570.0056.0	675	BU 73.7 / 64 REVZ	Z5.570.6156.0	683	BZ KL 17 / 24	Z7.451.2480.0	267
BU 70.3 / 16 RV	Z5.570.3056.0	675	BU 73.7 / 64 RV	Z5.570.9156.0	683	BZ KL 28 / 1 - 99	04.007.1080.0	214
BU 70.3 / 16 RVZ	Z5.570.2056.0	675	BU 73.7 / 64 RVZ	Z5.570.8156.0	683	BZ KL 29 / 1 - 55	04.007.3080.0	214
BU 70.3 / 24 REV	Z5.570.0356.0	675	BU EIG ANL.	Z2.300.0653.9	767	CEMOS-SSAC3-400V-2A	80.020.6000.0	537
BU 70.3 / 24 RV	Z5.570.3356.0	675	BU EIG ANL.	Z2.300.1053.9	767	CEMOS-SSPHC-400V-2.5A	80.020.6003.0	537
BU 70.3 / 24 REVZ	Z5.570.2356.0	675	BU EIG ANL.	Z2.300.1653.9	767	CODIERAST BU.LST.	05.561.9153.0	286
BU 70.7 / 6 REV	Z5.570.5156.0	677	BU EIG ANL.	Z2.300.2453.9	767	CODIERAST BU.LST.	05.561.9153.0	37
BU 70.7 / 6 REVZ	Z5.570.4156.0	677	BU EIG ANL.	Z2.300.4853.9	767	CODIERAST STITFL.	05.561.0053.0	286
BU 70.7 / 6 RV	Z5.570.8656.0	677	BU EINSATZ 3/3/6	Z2.203.1253.0	705	CODIERAST STITFL.	05.561.0053.0	284
BU 70.7 / 6 RVZ	Z5.570.6656.0	677	BU EINSATZ 4/6	Z2.205.1053.0	699	CODIERAST	Z5.593.4053.0	798
BU 70.7 / 10 REV	Z5.570.5256.0	677	BU EINSATZ 6/6	Z2.205.1253.0	703	CODIERSTIFT-AST	05.561.9453.0	319
BU 70.7 / 10 REVZ	Z5.570.4256.0	677	BU EINSATZ 680V	Z0.400.0340.0	643	CODIERSTIFT-AST	05.561.9453.5	319
BU 70.7 / 10 RV	Z5.570.8756.0	677	BU EINSATZ 680V	Z0.400.0640.0	643	CODIERSTUECK-AST	05.584.0053.0	311
BU 70.7 / 10 RVZ	Z5.570.6756.0	677	BU EINSATZ 680V	Z0.400.1040.0	643	CODIERSTUECK-AST	05.584.0053.0	137
BU 70.7 / 16 REV	Z5.570.5056.0	677	BU EINSATZ 680V	Z0.400.1640.0	643	CODIERSTUECK-AST	05.594.5153.0	219
BU 70.7 / 16 REVZ	Z5.570.4056.0	677	BU EINSATZ 680V	Z0.400.2040.0	643	CODIERSTUECK-AST	05.599.8053.0	321
BU 70.7 / 16 RV	Z5.570.8556.0	677	BU EINSATZ 680V	Z0.400.2640.0	643	CODIERSTUECK-AST	05.599.8053.0	205
BU 70.7 / 16 RVZ	Z5.570.6556.0	677	BU EINSATZ 680V	Z0.400.3240.0	643	CRIMPBACKEN A	05.502.2000.0	798
BU 70.7 / 24 REV	Z5.570.5356.0	677	BU EINSATZ VERGOL	Z0.301.0640.0	631	CRIMPBACKEN A	05.502.2000.0	741
BU 70.7 / 24 REVZ	Z5.570.4356.0	677	BU EINSATZ VERGOL	Z0.301.1040.0	631	CRIMPBACKEN B	05.502.2100.0	631
BU 70.7 / 24 RV	Z5.570.8856.0	677	BU EINSATZ VERGOL	Z0.301.1640.0	631	CRIMPBACKEN B	05.502.2100.0	798
BU 70.7 / 24 RVZ	Z5.570.6856.0	677	BU EINSTAZ VERGOL	Z0.301.2440.0	631	CRIMPBACKEN C	05.502.2200.0	798
BU 72.1 / 6 REV WL	Z5.572.0656.0	679	BUCHSE D-SUB 9	87.200.2200.3	560	CRIMPBACKEN C	05.502.2200.0	741
BU 72.1 / 6 REV WR	Z5.572.1656.0	679	BUCHSE D-SUB 15	87.200.2201.3	560	CRIMPBACKEN C	05.502.2300.0	798
BU 72.1 / 6 REV U WL	Z5.572.4656.0	679	BUCHSE D-SUB 25	87.200.2202.3	560	CRIMPBACKEN D	05.502.2300.0	739
BU 72.1 / 6 REV U WR	Z5.572.5656.0	679	BUCHSE D-SUB 37	87.200.2203.3	560	CRIMPBACKEN E	05.502.2400.0	683
BU 72.1 / 6 RV WL	Z5.572.2656.0	679	BUCHSE D-SUB 50	87.200.2204.3	560	CRIMPBACKEN E	05.502.2400.0	798
BU 72.1 / 6 RV WR	Z5.572.3656.0	679	BUCHSENEINSATZ	Z0.200.0653.0	689	CZ 0.5 -2.5 MM2 F.RVZ/S	95.101.0612.0	207
BU 72.1 / 6 RV U WL	Z5.572.6656.0	679	BUCHSENEINSATZ	Z0.300.0640.0	631	DATENEINF.OT. 16P	Z0.060.1628.0	755
BU 72.1 / 6 RV U WR	Z5.572.7656.0	679	BUCHSENEINSATZ	Z0.300.1040.0	631	DECKEL	Z7.409.7056.0	780
BU 72.1 / 10 REV WL	Z5.572.0756.0	679	BUCHSENEINSATZ	Z0.300.1640.0	631	DECKEL	Z7.409.7156.0	780
BU 72.1 / 10 REV WR	Z5.572.1756.0	679	BUCHSENEINSATZ	Z0.300.2440.0	631	DECKEL	Z7.409.7256.0	780
BU 72.1 / 10 REV U WL	Z5.572.4756.0	679	BUCHSENEINSATZ	Z0.300.3253.0	631	DECKEL	Z7.409.7356.0	780
BU 72.1 / 10 REV U WR	Z5.572.5756.0	679	BUCHSENEINSATZ	Z0.300.4840.0	631	DECKEL	Z7.417.6729.0	713
BU 72.1 / 10 RV WL	Z5.572.2756.0	679	BUCHSENEINSATZ	Z0.500.0653.0	631	DECKEL	Z7.417.6753.0	713
BU 72.1 / 10 RV WR	Z5.572.3756.0	679	BUCHSENEINSATZ	Z0.500.1053.0	631	DECKEL	Z7.416.1656.0	780
BU 72.1 / 10 RV U WL	Z5.572.6756.0	679	BUCHSENEINSATZ	Z0.500.1653.0	631	DECKEL	Z7.416.1756.0	780
BU 72.1 / 10 RV U WR	Z5.572.7756.0	679	BUCHSENEINSATZ	Z0.500.2453.0	631	DECKEL	Z7.416.1856.0	780
BU 72.1 / 16 REV WL	Z5.572.0556.0	679	BUCHSENEINSATZ	Z0.500.3253.0	631	DECKEL	Z7.419.6228.0	780
BU 72.1 / 16 REV WR	Z5.572.1556.0	679	BUCHSENEINSATZ	Z0.500.4853.0	631	DECKEL M.DICHTUNG	Z7.417.6829.0	713
BU 72.1 / 16 REV U WL	Z5.572.4556.0	679	BUCHSENEINSATZ	Z0.700.0658.0	631	DECKEL M.VERRIEG.	Z7.419.6128.0	798
BU 72.1 / 16 REV U WR	Z5.572.5556.0	679	BUCHSENEINSATZ	Z0.700.1058.0	631	DIN 46228-A 0,5 - 6	06.600.4027.0	796
BU 72.1 / 16 RV WL	Z5.572.2556.0	679	BUCHSENEINSATZ	Z0.700.1658.0	631	DIN 46228-A 0,75 - 6	06.600.4127.0	796
BU 72.1 / 16 RV WR	Z5.572.3556.0	679	BUCHSENEINSATZ	Z0.700.2458.0	631	DIN 46228-A 1 - 6	06.600.4227.0	796
BU 72.1 / 16 RV U WL	Z5.572.6556.0	679	BUCHSENEINSATZ	Z0.700.3253.0	631	DIN 46228-A 1,5 - 7	06.600.4327.0	796
BU 72.1 / 16 RV U WR	Z5.572.7556.0	679	BUCHSENEINSATZ	Z0.700.4858.0	631	DIN 46228-A 2,5 - 7	06.600.4427.0	796
BU 72.1 / 24 REV WL	Z5.572.0856.0	679	BUCHSENEINSATZ	Z2.200.0653.0	693	DIN 46228-A 4 - 9	06.600.4527.0	796
BU 72.1 / 24 REV WR	Z5.572.1856.0	679	BUCHSENEINSATZ	Z2.200.0653.0	707	DIN 46228-A 6 - 10	06.600.4627.0	796
BU 72.1 / 24 REV U WL	Z5.572.4856.0	679	BUCHSENEINSATZ	Z2.300.0653.0	655	DIN 46228-A 10 - 12	06.600.4727.0	796
BU 72.1 / 24 REV U WR	Z5.572.5856.0	679	BUCHSENEINSATZ	Z2.300.1053.0	655	DIN 46228-A 16 - 12	06.600.4827.0	796
BU 72.1 / 24 RV WL	Z5.572.2856.0	679	BUCHSENEINSATZ	Z2.300.1653.0	655	DIN 46228-A 25 - 15	06.600.4927.0	796
BU 72.1 / 24 RV WR	Z5.572.3856.0	679	BUCHSENEINSATZ	Z2.300.2453.0	655	DIN 46228-E 0,5 - 8	06.600.2027.0	796
BU 72.1 / 24 RV U WL	Z5.572.6856.0	679	BUCHSENEINSATZ	Z2.300.3253.0	655	DIN 46228-E 0,75 - 8	06.600.2127.0	796
BU 72.1 / 24 RV U WR	Z5.572.7856.0	679	BUCHSENEINSATZ	Z2.300.4853.0	655	DIN 46228-E 1 - 8	06.600.2227.0	796
BU 72.3 / 6 REV	Z5.570.1656.0	679	BUCHSENEINSATZ	Z2.700.0658.0	655	DIN 46228-E 1,5 - 8	06.600.2327.0	796
BU 72.3 / 6 REVZ	Z5.570.0656.0	679	BUCHSENEINSATZ	Z2.700.1058.0	655	DIN 46228-E 1,5 - 18	06.600.2427.0	796
BU 72.3 / 6 RV	Z5.570.3656.0	679	BUCHSENEINSATZ	Z2.700.1658.0	655	DIN 46228-E 2,5 - 8	06.600.2527.0	796
BU 72.3 / 6 RVZ	Z5.570.2656.0	679	BUCHSENEINSATZ	Z2.700.2458.0	655	DIN 46228-E 2,5 - 18	06.600.2627.0	796
BU 72.3 / 10 REV	Z5.570.1756.0	679	BUCHSENEINSATZ	Z2.700.3258.0	655	DIN 46228-E 4 - 10	06.600.2727.0	796
BU 72.3 / 10 REVZ	Z5.570.0756.0	679	BUCHSENEINSATZ	Z2.700.4858.0	655	DIN 46228-E 4 - 18	06.600.2827.0	796
BU 72.3 / 16 REV	Z5.570.3756.0	679	BUCHSENEINSATZ	Z3.300.0353.0	713	DIN 46228-E 6 - 12	06.600.2927.0	796
BU 72.3 / 16 REVZ	Z5.570.2756.0	679	BUCHSENEINSATZ	Z3.300.0453.0	713	DIN 46228-E 6 - 18	06.600.3027.0	796
BU 72.3 / 16 RV	Z5.570.1556.0	679	BUCHSENEINSATZ	Z3.700.0753.0	713	DIN 46228-E 10 - 12	06.600.3127.0	796
BU 72.3 / 16 REVZ	Z5.570.0556.0	679	BUCHSENEINSATZ	Z3.700.0853.0	713	DIN 46228-E 10 - 18	06.600.3227.0	796
BU 72.3 / 16 RV	Z5.570.3556.0	679	BUCHSENEINSATZ	Z3.700.1553.0	719	DIN 46228-E 16 - 12	06.600.3327.0	796
BU 72.3 / 16 RVZ	Z5.570.2556.0	679	BUCHSENEINSATZ	Z3.700.2553.0	719	DIN 46228-E 16 - 18	06.600.3427.0	796
BU 72.3 / 24 REV	Z5.570.1856.0	679	BUCHSENEINSATZ	Z3.700.4058.0	719	DIN 46228-E 25 - 18	06.600.3527.0	796
BU 72.3 / 24 REVZ	Z5.570.0856.0	679	BUCHSENEINSATZ	Z3.700.6458.0	719	DIN 5264 A 0,4 X 2,5	06.502.4300.0	281
BU 72.3 / 24 RV	Z5.570.3856.0	679	BUCHSENKONTAKT	02.125.1121.0	761	DIN 5264 A 0,6 x 3,5	06.502.4000.0	799
BU 72.3 / 24 RVZ	Z5.570.2856.0	679	BUCHSENKONTAKT	02.125.3129.8	739	DIN 5264 A 0,6 x 3,5	06.502.4000.0	293
BU 72.7 / 6 REV	Z5.570.5656.0	681	BUCHSENKONTAKT	02.125.3229.8	740	DIN 5264 A 0,6 x 3,5	06.502.4000.0	20
BU 72.7 / 6 REVZ	Z5.570.4656.0	681	BUCHSENKONTAKT	02.125.3329.8	740	DIN 5264 A 0,8 x 4,0	06.502.4100.0	21
BU 72.7 / 6 RV	Z5.570.9656.0	681	BUCHSENKONTAKT	02.125.3429.8	740	DIN 5264 A 1,0 x 5,5	06.502.4200.0	21
BU 72.7 / 6 RVZ	Z5.570.7656.0	681	BUCHSENKONTAKT	02.125.3529.8	740	DIN 5264 B 0,6X3,5 M	06.502.5000.0	30
BU 72.7 / 10 REV	Z5.570.5756.0	681	BUCHSENKONTAKT	02.125.3629.8	740	dipos EM	80.061.0010.3	582
BU 72.7 / 10 REVZ	Z5.570.4756.0	681	BUCHSENKONTAKT	02.125.3729.8	740	DIPOS JB 4,3	Z8.000.0229.5	499
BU 72.7 / 10 RV	Z5.570.9756.0	681	BUCHSENKONTAKT	02.125.3829.8	740	DIPOS KODIERAST	Z5.563.0453.0	499
BU 72.7 / 10 RVZ	Z5.570.7756.0	681	BUCHSENKONTAKT	02.125.3929.8	740	DIPOS KSQ	80.060.0020.1	508
BU 72.7 / 16 REV	Z5.570.5556.0	681	BUCHSENKONTAKT	02.125.4029.8	740	DIPOS KSQ	80.060.0021.1	508
BU 72.7 / 16 REVZ	Z5.570.4556.0	681	BUCHSENKONTAKT	02.125.4129.8	740	DIPOS KSQ 9,5 .. 10.5V	82.081.0000.0	508
BU 72.7 / 16 RV	Z5.570.9556.0	681	BUCHSENKONTAKT	02.125.4229.8	740	DIPOS PT100	80.060.0010.1	499
BU 72.7 / 16 RVZ	Z5.570.7556.0	681	BUCHSENKONTAKT	02.125.4329.8	740	DIPOS PT100-3 0-400C	80.060.0011.1	499
BU 72.7 / 24 REV	Z5.570.5856.0	681	BUCHSENKONTAKT	02.125.4429.8	740	DIPOS TC	82.011.3004.0	499
BU 72.7 / 24 REVZ	Z5.570.4856.0	681	BUCHSENKONTAKT	02.125.4529.8	740	DIPOS TC	80.060.0030.1	500
BU 72.7 / 24 RV	Z5.570.9856.0	681	BUCHSENKONTAKT	02.125.4629.7	740	DIPOS TC	80.060.0031.1	500
BU 72.7 / 24 RVZ	Z5.570.7856.0	681	BUCHSENKONTAKT	02.125.4729.7	740	DIPOS TC-K 0-1200C	82.021.1812.0	500
BU 73.1 / 40 REV WL	Z5.572.8056.0	683	BUCHSENTEIL	Z5.012.0053.0	758	DIPOS UMC 12,5	80.060.0000.1	582
BU 73.1 / 40 REV WR	Z5.572.8356.0	683	BUCHSENTEIL	99.700.6905.5	760	DIPOS UMC 12,5	80.060.0001.1	582
BU 73.1 / 40 REV U WL	Z5.572.9156.0	683	BZ 12	04.232.0051.0	218	DIST-.. /VO	Z1.299.3055.0	38
BU 73.1 / 40 REV U WR	Z5.572.9356.0	683	BZ 12 B	04.832.0051.0	218	DIST-1N 4007-1 /VO	Z1.299.3155.0	38
BU 73.1 / 40 RV WL	Z5.572.8656.0	683	BZ 8190 / 1 - 12	04.007.4089.0	306	DIST-1N 4007-2 /VO	Z1.299.3355.0	38
BU 73.1 / 40 RV WR	Z5.572.8956.0	683	BZ 8190 / 13 - 24	04.007.4189.0				

contents of
type description

contents

Type	Part no.	section / page	Type	Part no.	section / page	Type	Part no.	section / page
DST85/ 5	25.002.0553.0	328	FUER 0,5 MM2	05.543.7021.0	631	GEHAEUSEOBERTEIL	70.352.0635.3	633
DST85/ 5 OB	25.003.0553.0	328	FUER 0,5 MM2 KURZ	05.543.9021.0	655	GEHAEUSEOBERTEIL	70.352.1035.0	637
DST85/ 6	25.002.0653.0	328	FUER 0,75-1 MM2	02.123.7121.0	631	GEHAEUSEOBERTEIL	70.352.1035.1	637
DST85/ 6 OB	25.003.0653.0	328	FUER 0,75-1 MM2	05.543.7121.0	631	GEHAEUSEOBERTEIL	70.352.1035.2	637
DST85/ 7	25.002.0753.0	328	FUER 0,75-1 MM2	05.543.9121.0	655	GEHAEUSEOBERTEIL	70.352.1035.3	637
DST85/ 7 OB	25.003.0753.0	328	FUER 1,5 MM2	02.123.7221.0	631	GEHAEUSEOBERTEIL	70.352.1628.7	769
DST85/ 8	25.002.0853.0	328	FUER 1,5 MM2	05.543.7221.0	631	GEHAEUSEOBERTEIL	70.352.1635.0	637
DST85/ 8 OB	25.003.0853.0	328	FUER 1,5 MM2 KURZ	05.543.9221.0	655	GEHAEUSEOBERTEIL	70.352.1635.1	637
DST85/ 9	25.002.0953.0	328	FUER 1,5 MM2 VERGOLD	02.123.7201.0	631	GEHAEUSEOBERTEIL	70.352.1635.2	637
DST85/ 9 OB	25.003.0953.0	328	FUER 1,5 MM2 VERGOLD	05.543.7201.0	631	GEHAEUSEOBERTEIL	70.352.1635.3	637
DST85/10	25.002.1053.0	328	FUER 2,5 MM2	02.123.7321.0	631	GEHAEUSEOBERTEIL	70.352.2428.7	773
DST85/10 OB	25.003.1053.0	328	FUER 2,5 MM2	05.543.7321.0	631	GEHAEUSEOBERTEIL	70.352.2435.0	637
DST85/11	25.002.1153.0	328	FUER 2,5 MM2 KURZ	05.543.9321.0	655	GEHAEUSEOBERTEIL	70.352.2435.1	637
DST85/11 OB	25.003.1153.0	328	FUER 4 MM2	02.123.7421.0	631	GEHAEUSEOBERTEIL	70.352.2435.2	637
DST85/12	25.002.1253.0	328	FUER 4 MM2	05.543.7421.0	631	GEHAEUSEOBERTEIL	70.352.2435.3	637
DST85/12 OB	25.003.1253.0	328	FUER 4 MM2	05.543.9421.0	655	GEHAEUSEOBERTEIL	70.352.3235.0	637
DSTLF85/ 2	25.004.0253.0	328	FUER 70ER KLEMMENADAPT.	Z7.256.0227.0	781	GEHAEUSEOBERTEIL	70.352.3235.1	637
DSTLF85/ 2 OB	25.005.0253.0	328	FUER 70ER KLEMMENADAPT.	Z7.256.0327.0	781	GEHAEUSEOBERTEIL	70.352.3235.2	637
DSTLF85/ 3	25.004.0353.0	328	FUER 70ER KLEMMENADAPT.	Z7.256.0427.0	781	GEHAEUSEOBERTEIL	70.352.3235.3	637
DSTLF85/ 3 OB	25.005.0353.0	328	FUER 70ER KLEMMENADAPT.	Z7.256.0527.0	781	GEHAEUSEOBERTEIL	70.352.4828.7	769
DSTLF85/ 4	25.004.0453.0	328	FUER 70ER KLEMMENADAPT.	Z7.256.0627.0	781	GEHAEUSEOBERTEIL	70.352.4835.0	633
DSTLF85/ 4 OB	25.005.0453.0	328	FUER 70ER KLEMMENADAPT.	Z7.256.0727.0	781	GEHAEUSEOBERTEIL	70.352.4835.1	633
DSTLF85/ 5	25.004.0553.0	328	FUER 70ER KLEMMENADAPT.	Z7.256.0827.0	781	GEHAEUSEOBERTEIL	70.352.4835.2	633
DSTLF85/ 5 OB	25.005.0553.0	328	FUER 70ER KLEMMENADAPT.	Z7.256.0927.0	781	GEHAEUSEOBERTEIL	70.352.4835.3	633
DSTLF85/ 6	25.004.0653.0	328	FUER 70ER KLEMMENADAPT.	Z7.256.1027.0	781	GEHAEUSEOBERTEIL	70.353.0635.0	633
DSTLF85/ 6 OB	25.005.0653.0	328	FUER 70ER KLEMMENADAPT.	Z7.256.1127.0	781	GEHAEUSEOBERTEIL	70.353.0635.2	633
DSTLF85/ 7	25.004.0753.0	328	FUER 70ER KLEMMENADAPT.	Z7.256.1227.0	781	GEHAEUSEOBERTEIL	70.353.0635.3	633
DSTLF85/ 7 OB	25.005.0753.0	328	FUER NYAF 1,5 MM2	05.592.7553.0	138	GEHAEUSEOBERTEIL	70.353.1035.0	637
DSTLF85/ 8	25.004.0853.0	328	FUER NYAF 2,5 MM2	05.592.7653.0	138	GEHAEUSEOBERTEIL	70.353.1035.1	637
DSTLF85/ 8 OB	25.005.0853.0	328	FUER WK 4E/U	Z1.299.9053.0	176	GEHAEUSEOBERTEIL	70.353.1035.2	637
DSTLF85/ 9	25.004.0953.0	328	FUER WK1 10/U	04.325.8553.8	69	GEHAEUSEOBERTEIL	70.353.1035.3	637
DSTLF85/ 9 OB	25.005.0953.0	328	FUER WK1 16/U	04.325.8653.8	79	GEHAEUSEOBERTEIL	70.353.1635.0	637
DSTLF85/10	25.004.1053.0	328	GEH.OT. TEIL L	75.900.0135.0	664	GEHAEUSEOBERTEIL	70.353.1635.1	637
DSTLF85/10 OB	25.005.1053.0	328	GEH.OT. TEIL L	75.950.1635.0	664	GEHAEUSEOBERTEIL	70.353.1635.2	637
DSTLF85/11	25.004.1153.0	328	GEH.OT. TEIL L	75.950.2435.0	664	GEHAEUSEOBERTEIL	70.353.1635.3	637
DSTLF85/11 OB	25.005.1153.0	328	GEH.OT. TEIL L	75.960.1635.0	664	GEHAEUSEOBERTEIL	70.353.2435.0	637
DSTLF85/12	25.004.1253.0	328	GEH.OT. TEIL L	75.960.2435.0	664	GEHAEUSEOBERTEIL	70.353.2435.1	637
DSTLF85/12 OB	25.005.1253.0	328	GEH.UT. 10 POL.	70.320.1038.0	684	GEHAEUSEOBERTEIL	70.353.2435.2	637
DSU-400V-250V4A	87.030.6453.0	542	GEH.UT. 16 POL.	70.320.1638.0	684	GEHAEUSEOBERTEIL	70.353.2435.3	637
EAS-UE / D-135	87.222.5953.0	564	GEH.UT. 24 POL.	70.320.2438.0	684	GEHAEUSEOBERTEIL	70.353.3235.0	637
EAS-UE / D-L-135	87.222.6053.0	564	GEH.UT. 6 POL.	70.320.0638.0	684	GEHAEUSEOBERTEIL	70.353.3235.2	637
EAS-UE/D-115	87.221.5953.0	562	GEH.UT. TEIL F	75.900.0035.0	664	GEHAEUSEOBERTEIL	70.353.4828.7	769
EAS-UE/D-L-115	87.221.6053.0	562	GEH.UT. TEIL F	75.931.1635.0	664	GEHAEUSEOBERTEIL	70.353.4835.1	633
EKAP BLAU	28.000.0202.2	442	GEH.UT. TEIL F	75.931.2435.0	664	GEHAEUSEOBERTEIL	70.353.4835.2	633
EKAP ROT	28.000.0202.1	442	GEH.UT. TEIL F	75.933.1635.0	664	GEHAEUSEOBERTEIL	70.354.0628.7	769
ETAGENKLEMMME	56.704.6953.1	30	GEH.UT. TEIL F	75.933.2435.0	664	GEHAEUSEOBERTEIL	70.354.1635.0	633
ETIKETTEN A4	05.591.3089.0	416	GEH.UT. TEIL F	75.934.2435.0	664	GEHAEUSEOBERTEIL	70.354.1635.1	633
EUROPAKLEMMMLST.1P	99.261.3521.9	258	GEH.UT. TEIL F	75.941.1635.0	664	GEHAEUSEOBERTEIL	70.354.1635.2	633
F. 400/690V-SER.	05.502.3500.0	631	GEH.UT. TEIL F	75.941.2435.0	664	GEHAEUSEOBERTEIL	70.354.1028.7	769
F.EIGSICH ANL.ZINKDRCKG	99.721.3329.7	772	GEHAEUSE-OBERTEIL	70.354.0635.3	633	GEHAEUSEOBERTEIL	70.354.1035.0	637
F.EIGSICH ANL.ZINKDRCKG	99.723.3329.7	772	GEHAEUSE-OBERTEIL	70.351.1035.1	637	GEHAEUSEOBERTEIL	70.354.1035.1	637
F.EIGSICH ANL.ZINKDRCKG	99.727.3329.7	772	GEHAEUSE-OBERTEIL	70.351.1635.1	637	GEHAEUSEOBERTEIL	70.354.1035.2	637
F.STCKHUELS.6.3 BIS2.5Q	05.562.8653.0	175	GEHAEUSE-OBERTEIL	70.351.2435.1	637	GEHAEUSEOBERTEIL	70.354.1035.3	637
FEDERKONTAKT	02.124.4028.0	207	GEHAEUSE-OBERTEIL	70.355.1035.1	637	GEHAEUSEOBERTEIL	70.354.1628.7	769
FEDERKONTAKT	02.124.4100.0	207	GEHAEUSE-OBERTEIL	70.355.1035.2	637	GEHAEUSEOBERTEIL	70.354.1635.0	637
FEDERKONTAKT	02.125.1629.0	291	GEHAEUSE-OBERTEIL	70.355.1635.1	637	GEHAEUSEOBERTEIL	70.354.1635.1	637
FEDERKONTAKT	02.125.1729.0	291	GEHAEUSE-OBERTEIL	70.355.1635.2	637	GEHAEUSEOBERTEIL	70.354.1635.2	637
FEDERKONTAKT BAND	02.125.1600.0	291	GEHAEUSE-OBERTEIL	70.355.2435.1	637	GEHAEUSEOBERTEIL	70.354.1635.3	637
FEDERKONTAKT BAND	02.125.1700.0	291	GEHAEUSE-OBERTEIL	70.355.2435.2	637	GEHAEUSEOBERTEIL	70.354.2435.0	637
FKK18 / 1	02.220.0121.0	217	GEHAEUSE-OBERTEIL	70.356.1035.1	637	GEHAEUSEOBERTEIL	70.354.2435.1	637
FKK18 / 1 Z	22.220.0121.0	217	GEHAEUSE-OBERTEIL	70.356.1635.1	637	GEHAEUSEOBERTEIL	70.354.2435.2	637
FKK18 / 2	02.220.0321.0	217	GEHAEUSE-OBERTEIL	70.356.2435.1	637	GEHAEUSEOBERTEIL	70.354.2435.3	637
FKK18 / 2 Z	22.220.0321.0	217	GEHAEUSE-OBERTEIL	70.357.1035.1	637	GEHAEUSEOBERTEIL	70.354.3235.0	637
FKK18 / 3	02.220.0421.0	217	GEHAEUSE-OBERTEIL	70.357.1635.1	637	GEHAEUSEOBERTEIL	70.354.3235.2	637
FKK18 / 3 Z	22.220.0421.0	217	GEHAEUSE-OBERTEIL	70.357.2435.1	637	GEHAEUSEOBERTEIL	70.354.4828.7	769
FLACHSTECKER	05.555.8521.0	584	GEHAEUSEOBERTEIL	70.350.0628.7	769	GEHAEUSEOBERTEIL	70.354.4835.1	633
FLACHSTECKER	05.555.8621.0	584	GEHAEUSEOBERTEIL	70.350.0635.0	633	GEHAEUSEOBERTEIL	70.354.4835.2	633
FLACHSTECKER	05.555.8721.0	584	GEHAEUSEOBERTEIL	70.350.0635.1	633	GEHAEUSEOBERTEIL	70.355.1028.7	769
FLACHSTECKER	05.555.8821.0	584	GEHAEUSEOBERTEIL	70.350.0635.2	633	GEHAEUSEOBERTEIL	70.355.1035.0	637
FLACHSTECKER	05.555.8921.0	584	GEHAEUSEOBERTEIL	70.350.0635.3	633	GEHAEUSEOBERTEIL	70.355.1035.3	637
FLACHSTECKER	05.555.9121.0	584	GEHAEUSEOBERTEIL	70.350.1028.7	769	GEHAEUSEOBERTEIL	70.355.1628.7	769
FLARE MOVE BM SERIE 38	80.063.4129.3	444	GEHAEUSEOBERTEIL	70.350.1035.0	637	GEHAEUSEOBERTEIL	70.355.1635.0	637
FLARE MOVE BZ SERIE 38	80.063.4029.3	444	GEHAEUSEOBERTEIL	70.350.1035.1	637	GEHAEUSEOBERTEIL	70.355.1635.3	637
FLARE-110V-1W-250V6A-F	80.010.4131.0	442	GEHAEUSEOBERTEIL	70.350.1035.3	637	GEHAEUSEOBERTEIL	70.355.2435.0	637
FLARE-115V/48VDC-0.5A	80.020.4102.0	478	GEHAEUSEOBERTEIL	70.350.1628.7	769	GEHAEUSEOBERTEIL	70.355.2435.3	637
FLARE-120C-1W-250V6A-F	80.010.4106.0	442	GEHAEUSEOBERTEIL	70.350.1635.0	637	GEHAEUSEOBERTEIL	70.356.1035.0	637
FLARE-230V-1W-250V6A-F	80.010.4141.0	442	GEHAEUSEOBERTEIL	70.350.1635.1	637	GEHAEUSEOBERTEIL	70.356.1035.2	637
FLARE-230VAC/48VDC-0.5A	80.020.4103.0	479	GEHAEUSEOBERTEIL	70.350.1635.3	637	GEHAEUSEOBERTEIL	70.356.1035.3	637
FLARE-240C-1W-250V6A-F	80.010.4100.0	442	GEHAEUSEOBERTEIL	70.350.2435.0	637	GEHAEUSEOBERTEIL	70.356.1635.0	637
FLARE-240C-2W-250V6A-F	80.010.4103.0	443	GEHAEUSEOBERTEIL	70.350.2435.1	637	GEHAEUSEOBERTEIL	70.356.1635.2	637
FLARE-24V-1S-250V6A-HA	80.010.4101.0	446	GEHAEUSEOBERTEIL	70.350.2435.2	637	GEHAEUSEOBERTEIL	70.356.1635.3	637
FLARE-24V-1W-250V6A-CUT	80.010.4120.0	446	GEHAEUSEOBERTEIL	70.350.3235.0	637	GEHAEUSEOBERTEIL	70.356.2435.0	637
FLARE-24V-1W-48V20M	80.010.4005.0	442	GEHAEUSEOBERTEIL	70.350.3235.1	637	GEHAEUSEOBERTEIL	70.356.2435.2	637
FLARE-24V-1W-48V20M-F	80.010.4105.0	442	GEHAEUSEOBERTEIL	70.350.3235.2	637	GEHAEUSEOBERTEIL	70.356.2435.3	637
FLARE-24VDC/230VAC-0.5A	80.020.4150.0	479	GEHAEUSEOBERTEIL	70.350.3235.3	637	GEHAEUSEOBERTEIL	70.357.1035.0	637
FLARE-24VDC/48VDC-0.5A	80.020.4100.0	478	GEHAEUSEOBERTEIL	70.350.3235.3	637	GEHAEUSEOBERTEIL	70.357.1035.2	637
FLARE-24VDC/48VDC-2A	80.020.4101.0	462	GEHAEUSEOBERTEIL	70.350.4835.0	633	GEHAEUSEOBERTEIL	70.357.1035.3	637
FLARE-PID/0060-S-250V6A	81.020.4102.0	462	GEHAEUSEOBERTEIL	70.350.4835.1	633	GEHAEUSEOBERTEIL	70.357.1635.0	637
FLARE-PID/0100-S-250V6A	81.020.4101.0	462	GEHAEUSEOBERTEIL	70.350.4835.2	633	GEHAEUSEOBERTEIL	70.357.1635.3	637
FLARE-TIMER-S-250V6A	81.020.4100.0	462	GEHAEUSEOBERTEIL	70.350.4835.3	633	GEHAEUSEOBERTEIL	70.357.2435.0	637
FLK-SR 10	87.210.2201.3	561	GEHAEUSEOBERTEIL	70.351.0635.0	633	GEHAEUSEOBERTEIL	70.357.2435.2	637
FLK-SR 14	87.210.2202.3	561	GEHAEUSEOBERTEIL	70.351.0635.1	633	GEHAEUSEOBERTEIL	70.357.2435.3	637
FLK-SR 16	87.210.2203.3	561	GEHAEUSEOBERTEIL	70.351.0635.2	633	GEHAEUSEOBERTEIL	70.358.1035.0	637
FLK-SR 20	87.210.2204.3	561	GEHAEUSEOBERTEIL	70.351.0635.3	633	GEHAEUSEOBERTEIL	70.358.1035.2	637
FLK-SR 26	87.210.2205.3	561	GEHAEUSEOBERTEIL	70.351.1035.0	637	GEHAEUSEOBERTEIL	70.358.1035.3	637
FLK-SR 34	87.210.2207.3	561	GEHAEUSEOBERTEIL	70.351.1035.2	637	GEHAEUSEOBERTEIL	70.358.1635.0	637
FLK-SR 40	87.210.2208.3	561	GEHAEUSEOBERTEIL	70.351.1035.3	637	GEHAEUSEOBERTEIL	70.358.1635.1	637
FLK-SR 50	87.210.2210.3	561	GEHAEUSEOBERTEIL	70.351.1635.0	637	GEHAEUSEOBERTEIL	70.358.1635.2	637
FLK-SR 60	87.210.2211.3	561	GEHAEUSEOBERTEIL	70.351.1635.2	637	GEHAEUSEOBERTEIL	70.358.	

contents

Type	Part no.	section / page	Type	Part no.	section / page	Type	Part no.	section / page
GEHAUSEUNTERTEIL	73.343.6435.1	639	GEHAUSEUNTERTEIL	77.330.2435.1	646	IVB WK 4/D.- 9	Z7.281.7927.0	162
GEHAUSEUNTERTEIL	73.344.4035.0	639	GEHAUSEUNTERTEIL	77.331.1035.0	646	IVB WK 4/D.-10	Z7.281.8027.0	162
GEHAUSEUNTERTEIL	73.344.4035.1	639	GEHAUSEUNTERTEIL	77.331.1035.1	646	IVB WK 4/D.-11	Z7.281.8127.0	162
GEHAUSEUNTERTEIL	73.344.6435.0	639	GEHAUSEUNTERTEIL	77.331.1635.0	646	IVB WK 4/D.-12	Z7.281.8227.0	112
GEHAUSEUNTERTEIL	73.344.6435.1	639	GEHAUSEUNTERTEIL	77.331.1635.1	646	IVB WK 4/DEU-2	Z7.271.0227.0	113
GEHAUSEUNTERTEIL	73.345.4035.0	639	GEHAUSEUNTERTEIL	77.331.2435.0	646	IVB WK 4/DEU-3	Z7.271.0327.0	113
GEHAUSEUNTERTEIL	73.345.4035.1	639	GEHAUSEUNTERTEIL	77.331.2435.1	646	IVB WK 4/DEU-4	Z7.271.0427.0	162
GEHAUSEUNTERTEIL	73.345.6435.0	639	GEHAUSEUNTERTEIL	77.333.1035.0	647	IVB WK 4/DEU-5	Z7.271.0527.0	162
GEHAUSEUNTERTEIL	73.345.6435.1	639	GEHAUSEUNTERTEIL	77.333.1035.1	647	IVB WK 4/DEU-6	Z7.271.0627.0	162
GEHAUSEUNTERTEIL	73.346.4035.0	639	GEHAUSEUNTERTEIL	77.333.1635.0	647	IVB WK 4/DEU-7	Z7.271.0727.0	162
GEHAUSEUNTERTEIL	73.346.4035.1	639	GEHAUSEUNTERTEIL	77.333.1635.1	647	IVB WK 4/DEU-8	Z7.271.0827.0	162
GEHAUSEUNTERTEIL	73.346.6435.0	639	GEHAUSEUNTERTEIL	77.333.2435.0	647	IVB WK 4/DEU-9	Z7.271.0927.0	162
GEHAUSEUNTERTEIL	73.346.6435.1	639	GEHAUSEUNTERTEIL	77.333.2435.1	647	IVB WK 4/DEU-10	Z7.271.1027.0	162
GEHAUSEUNTERTEIL	73.347.4035.0	639	GEHAUSEUNTERTEIL	77.340.1035.0	647	IVB WK 4/DEU-11	Z7.271.1127.0	162
GEHAUSEUNTERTEIL	73.347.4035.1	639	GEHAUSEUNTERTEIL	77.340.1035.1	647	IVB WK 4/DEU-12	Z7.271.1227.0	113
GEHAUSEUNTERTEIL	73.347.6435.0	639	GEHAUSEUNTERTEIL	77.340.1635.0	647	IVB WK 2.5-3D- 2	Z7.270.0227.0	118
GEHAUSEUNTERTEIL	73.347.6435.1	639	GEHAUSEUNTERTEIL	77.340.1635.1	647	IVB WK 2.5-3D- 3	Z7.270.0327.0	118
GEHAUSEUNTERTEIL	76.320.0729.0	713	GEHAUSEUNTERTEIL	77.340.2435.0	647	IVB WK 2.5-3D- 4	Z7.270.0427.0	162
GEHAUSEUNTERTEIL	76.320.0753.0	713	GEHAUSEUNTERTEIL	77.340.2435.1	647	IVB WK 2.5-3D- 5	Z7.270.0527.0	162
GEHAUSEUNTERTEIL	76.320.1528.0	723	GEHAUSEUNTERTEIL	77.341.1035.0	647	IVB WK 2.5-3D- 6	Z7.270.0627.0	162
GEHAUSEUNTERTEIL	76.320.2528.0	723	GEHAUSEUNTERTEIL	77.341.1035.1	647	IVB WK 2.5-3D- 7	Z7.270.0727.0	162
GEHAUSEUNTERTEIL	76.321.0729.0	713	GEHAUSEUNTERTEIL	77.341.1635.0	647	IVB WK 2.5-3D- 8	Z7.270.0827.0	162
GEHAUSEUNTERTEIL	76.321.0753.0	713	GEHAUSEUNTERTEIL	77.341.1635.1	647	IVB WK 2.5-3D- 9	Z7.270.0927.0	162
GEHAUSEUNTERTEIL	76.322.0736.0	713	GEHAUSEUNTERTEIL	77.341.2435.0	647	IVB WK 2.5-3D- 10	Z7.270.1027.0	162
GEHAUSEUNTERTEIL	76.322.0736.1	713	GEHAUSEUNTERTEIL	77.341.2435.1	647	IVB WK 2.5-3D- 11	Z7.270.1127.0	162
GEHAUSEUNTERTEIL	76.322.0760.1	713	GEHAUSEUNTERTEIL	77.342.1035.0	647	IVB WK 2.5-3D- 12	Z7.270.1227.0	118
GEHAUSEUNTERTEIL	76.325.1528.0	725	GEHAUSEUNTERTEIL	77.342.1035.1	647	IVB WK 2.5-3D- M-70	Z7.270.0027.0	162
GEHAUSEUNTERTEIL	76.325.2528.0	725	GEHAUSEUNTERTEIL	77.342.1635.0	647	IVB WK 2.5-K 6 BLAU	Z7.267.0627.6	160
GEHAUSEUNTERTEIL	76.326.4028.0	723	GEHAUSEUNTERTEIL	77.342.1635.1	647	IVB WK 2.5-K 6 BLAU	Z7.267.1127.6	160
GEHAUSEUNTERTEIL	76.326.6428.0	723	GEHAUSEUNTERTEIL	77.342.2435.0	647	IVB WK 2.5-K 6 ROT	Z7.267.0627.5	160
GEHAUSEUNTERTEIL	76.327.4028.0	725	GEHAUSEUNTERTEIL	77.342.2435.1	647	IVB WK 2.5-K 7 BLAU	Z7.267.0727.6	160
GEHAUSEUNTERTEIL	76.327.6428.0	725	GEHAUSEUNTERTEIL	77.343.1035.0	647	IVB WK 2.5-K 7 ROT	Z7.267.0727.5	160
GEHAUSEUNTERTEIL	76.330.1535.0	723	GEHAUSEUNTERTEIL	77.343.1035.1	647	IVB WK 2.5-K 9 BLAU	Z7.267.0927.6	160
GEHAUSEUNTERTEIL	76.330.1535.1	723	GEHAUSEUNTERTEIL	77.343.1635.0	647	IVB WK 2.5-K 9 ROT	Z7.267.0927.5	160
GEHAUSEUNTERTEIL	76.330.2535.0	723	GEHAUSEUNTERTEIL	77.343.1635.1	647	IVB WK 2.5-K 11 ROT	Z7.267.1127.6	160
GEHAUSEUNTERTEIL	76.330.2535.1	723	GEHAUSEUNTERTEIL	77.343.2435.0	647	IVB WK 2.5-K- 2 BLAU	Z7.267.0227.6	118
GEHAUSEUNTERTEIL	76.330.4035.0	723	GEHAUSEUNTERTEIL	77.343.2435.1	647	IVB WK 2.5-K- 2 ROT	Z7.267.0227.5	118
GEHAUSEUNTERTEIL	76.330.4035.1	723	GEHAUSEUNTERTEIL	99.700.3329.7	773	IVB WK 2.5-K- 3 BLAU	Z7.267.0327.6	160
GEHAUSEUNTERTEIL	76.330.6435.0	723	GEHAUSEUNTERTEIL	99.702.3329.7	773	IVB WK 2.5-K- 3 ROT	Z7.267.0327.5	160
GEHAUSEUNTERTEIL	76.330.6435.1	723	GEHAUSEUNTERTEIL	99.704.3329.7	773	IVB WK 2.5-K- 4 BLAU	Z7.267.0427.6	160
GEHAUSEUNTERTEIL	76.331.1535.0	723	GEHAUSEUNTERTEIL	99.706.3329.7	773	IVB WK 2.5-K- 4 ROT	Z7.267.0427.5	160
GEHAUSEUNTERTEIL	76.331.1535.1	723	GLEITMUTTER	05.516.9510.0	215	IVB WK 2.5-K- 5 BLAU	Z7.267.0527.6	160
GEHAUSEUNTERTEIL	76.331.2535.0	723	GRUNDZANGE	95.101.0800.0	291	IVB WK 2.5-K- 5 ROT	Z7.267.0527.5	160
GEHAUSEUNTERTEIL	76.331.2535.1	723	GRUNDZANGE	95.101.0800.1	631	IVB WK 2.5-K- 8 BLAU	Z7.267.0827.6	160
GEHAUSEUNTERTEIL	76.331.4035.0	723	GRUNDZANGE	95.101.0800.0	798	IVB WK 2.5-K- 8 ROT	Z7.267.0827.5	160
GEHAUSEUNTERTEIL	76.331.4035.1	723	GUMMISTOPFEN GR.	05.562.3283.0	755	IVB WK 2.5-K- 10 BLAU	Z7.267.1027.6	160
GEHAUSEUNTERTEIL	76.331.6435.0	723	GUMMISTOPFEN KL.	05.562.3183.0	755	IVB WK 2.5-K- 10 ROT	Z7.267.1027.5	160
GEHAUSEUNTERTEIL	76.331.6435.1	723	HALTFEDER	05.549.0500.0	128	IVB WK 2.5-K- 12 BLAU	Z7.267.1227.6	118
GEHAUSEUNTERTEIL	76.333.4035.0	723	HALTERAHMEN 10	25.574.1053.0	782	IVB WK 2.5-K- 12 ROT	Z7.267.1227.5	118
GEHAUSEUNTERTEIL	76.333.4035.1	723	HALTERAHMEN 16	25.574.1653.0	782	IVB WK 2.5-K-M-70 BLAU	Z7.267.0027.6	160
GEHAUSEUNTERTEIL	76.333.6435.0	723	HALTERAHMEN 24	25.574.2453.0	782	IVB WK 2.5-K-M-70 ROT	Z7.267.0027.5	160
GEHAUSEUNTERTEIL	76.334.1535.0	723	HALTERAHMEN 2x6	25.574.1253.0	782	IVB WK4 E- 2	Z7.255.2227.0	114
GEHAUSEUNTERTEIL	76.334.1535.1	723	HALTERAHMEN 6	25.574.0653.0	782	IVB WK4 E- 3	Z7.255.2327.0	160
GEHAUSEUNTERTEIL	76.334.2535.0	723	HOCHPOL	05.502.0000.0	683	IVB WK4 E- 4	Z7.255.2427.0	160
GEHAUSEUNTERTEIL	76.334.2535.1	723	IN 4E228-A35 -18	06.800.5027.0	796	IVB WK4 E- 5	Z7.255.2527.0	160
GEHAUSEUNTERTEIL	76.334.4035.0	634	ISOL.VERB.KAMM	Z7.258.1225.0	416	IVB WK4 E- 6	Z7.255.2627.0	114
GEHAUSEUNTERTEIL	76.334.4035.1	634	ISOL.VERB.KAMM	Z7.258.1225.1	786	IVB WK4 E- 7	Z7.255.2727.0	160
GEHAUSEUNTERTEIL	76.334.6435.0	634	ISOL.VERB.KAMM	Z7.258.1325.0	781	IVB WK4 E- 8	Z7.255.2827.0	160
GEHAUSEUNTERTEIL	76.334.6435.1	634	ISOL.VERB.KAMM	Z7.258.1425.0	781	IVB WK4 E- 9	Z7.255.2927.0	160
GEHAUSEUNTERTEIL	76.334.6435.1	634	ISOL.VERB.KAMM	Z7.258.1525.0	781	IVB WK4 E- 10	Z7.255.3027.0	160
GEHAUSEUNTERTEIL	76.335.1535.0	723	ISOL.VERB.KAMM	Z7.258.1625.0	781	IVB WK4 E- 11	Z7.255.3127.0	160
GEHAUSEUNTERTEIL	76.335.2535.0	723	ISOL.VERB.KAMM	Z7.258.1725.0	781	IVB WK4 E- 12	Z7.255.3227.0	160
GEHAUSEUNTERTEIL	76.335.2535.1	723	ISOL.VERB.KAMM	Z7.258.1825.0	781	IVB WK4 E/U- 2	Z7.271.2227.0	145
GEHAUSEUNTERTEIL	76.335.4035.0	634	ISOL.VERB.KAMM	Z7.258.1925.0	781	IVB WK4 E/U- 3	Z7.271.2327.0	145
GEHAUSEUNTERTEIL	76.335.4035.1	634	ISOL.VERB.KAMM	Z7.258.2025.0	781	IVB WK4 E/U- 4	Z7.271.2427.0	162
GEHAUSEUNTERTEIL	76.335.6435.0	634	ISOL.VERB.ST.	Z7.258.0225.0	204	IVB WK4 E/U- 5	Z7.271.2527.0	162
GEHAUSEUNTERTEIL	76.335.6435.1	634	ISOL.VERB.ST.	Z7.258.0325.0	204	IVB WK4 E/U- 6	Z7.271.2627.0	162
GEHAUSEUNTERTEIL	76.337.4035.0	635	ISOL.VERB.ST.	Z7.258.1025.0	204	IVB WK4 E/U- 7	Z7.271.2727.0	162
GEHAUSEUNTERTEIL	76.337.4035.1	635	ISOLIERGEHAUSE	01.001.5053.0	584	IVB WK4 E/U- 8	Z7.271.2827.0	162
GEHAUSEUNTERTEIL	76.337.6435.0	635	ISOLIERGEHAUSE	01.001.5153.0	584	IVB WK4 E/U- 9	Z7.271.2927.0	162
GEHAUSEUNTERTEIL	76.337.6435.1	635	ISOLIERGEHAUSE	01.001.5353.0	586	IVB WK4 E/U-10	Z7.271.3027.0	162
GEHAUSEUNTERTEIL	76.340.4035.0	725	ISOLIERGEHAUSE	01.001.5453.0	586	IVB WK4 E/U-11	Z7.271.3127.0	162
GEHAUSEUNTERTEIL	76.340.4035.1	725	ISOLIERGEHAUSE	01.001.5653.0	588	IVB WK4 E/U-12	Z7.271.3227.0	145
GEHAUSEUNTERTEIL	76.341.4035.0	725	ISOLIERGEHAUSE	01.001.5753.0	588	IVB WK14 - 2	Z7.271.4227.0	139
GEHAUSEUNTERTEIL	76.341.4035.1	725	ISOLIERGEHAUSE	01.001.5853.0	588	IVB WK14 - 3	Z7.271.4327.0	139
GEHAUSEUNTERTEIL	76.341.6435.0	725	ISOLIERGEHAUSE	01.001.6553.0	590	IVB WK14 -12	Z7.271.5227.0	69
GEHAUSEUNTERTEIL	76.342.4035.0	725	ISOLIERGEHAUSE	01.001.6653.0	590	IVB WK16-2	Z7.284.6227.0	25
GEHAUSEUNTERTEIL	76.342.4035.1	725	ISOLIERGEHAUSE	01.001.6753.0	590	NBS WK4 E- 2	Z7.256.4227.0	114
GEHAUSEUNTERTEIL	76.343.4035.0	725	IVB 0,5 WK4.- 2	Z7.255.0227.0	86	NBS WK4 E- 3	Z7.256.4327.0	160
GEHAUSEUNTERTEIL	76.343.4035.1	725	IVB 0,5 WK4.- 3	Z7.255.0327.0	86	NBS WK4 E- 4	Z7.256.4427.0	160
GEHAUSEUNTERTEIL	76.344.4035.0	635	IVB 0,5 WK4.- 4	Z7.255.0427.0	86	NBS WK4 E- 5	Z7.256.4527.0	160
GEHAUSEUNTERTEIL	76.344.4035.1	635	IVB 0,5 WK4.- 5	Z7.255.0527.0	86	NBS WK4 E- 6	Z7.256.4627.0	114
GEHAUSEUNTERTEIL	76.344.6435.0	635	IVB 0,5 WK4.- 6	Z7.255.0627.0	86	NBS WK4 E- 7	Z7.256.4727.0	160
GEHAUSEUNTERTEIL	76.344.6435.1	635	IVB 0,5 WK4.- 7	Z7.255.0727.0	86	NBS WK4 E- 8	Z7.256.4827.0	160
GEHAUSEUNTERTEIL	76.345.4035.0	635	IVB 0,5 WK4.- 8	Z7.255.0827.0	86	NBS WK4 E- 9	Z7.256.4927.0	160
GEHAUSEUNTERTEIL	76.345.4035.1	635	IVB 0,5 WK4.- 9	Z7.255.0927.0	86	NBS WK4 E- 10	Z7.256.5027.0	160
GEHAUSEUNTERTEIL	76.345.6435.0	635	IVB 0,5 WK4.- 10	Z7.255.1027.0	86	NBS WK4 E- 11	Z7.256.5127.0	160
GEHAUSEUNTERTEIL	76.345.6435.1	635	IVB 0,5 WK4.- 11	Z7.255.1127.0	86	NBS WK4 E- 12	Z7.256.5227.0	160
GEHAUSEUNTERTEIL	76.346.4035.0	635	IVB 0,5 WK4.- 12	Z7.255.1227.0	86	IBWVK 2.5 - 2	Z7.280.2227.0	102
GEHAUSEUNTERTEIL	76.346.4035.1	635	IVB 1 WK4.- 2	Z7.255.4227.0	86	IBWVK 2.5 - 3	Z7.280.2327.0	310
GEHAUSEUNTERTEIL	76.346.6435.0	635	IVB 1 WK4.- 3	Z7.255.4327.0	86	IBWVK 2.5 - 3	Z7.280.2327.0	310
GEHAUSEUNTERTEIL	76.346.6435.1	635	IVB 1 WK4.- 4	Z7.255.4427.0	86	IBWVK 2.5 - 3	Z7.280.2327.0	102
GEHAUSEUNTERTEIL	76.347.4035.0	635	IVB 1 WK4.- 5	Z7.255.4527.0	86	IBWVK 2.5 - 4	Z7.280.2427.0	162
GEHAUSEUNTERTEIL	76.347.4035.1	635	IVB 1 WK4.- 6	Z7.255.4627.0	86	IBWVK 2.5 - 5	Z7.280.2527.0	162
GEHAUSEUNTERTEIL	76.347.6435.0	635	IVB 1 WK4.- 7	Z7.255.4727.0	86	IBWVK 2.5 - 6	Z7.280.2627.0	162
GEHAUSEUNTERTEIL	76.347.6435.1	635	IVB 1 WK4.- 8	Z7.255.4827.0	86	IBWVK 2.5 - 7	Z7.280.2727.0	162
GEHAUSEUNTERTEIL	77.320.1028.0	646	IVB 1 WK4.- 9	Z7.255.4927.0	86	IBWVK 2.5 - 8	Z7.280.2827.0	162
GEHAUSEUNTERTEIL	77.320.1628.0	646	IVB 1 WK4.- 10	Z7.255.5027.0	86	IBWVK 2.5 - 9	Z7.280.2927.0	162
GEHAUSEUNTERTEIL	77.320.2428.0	646	IVB 1 WK4.- 11	Z7.255.5127.0	86	IBWVK 2.5 - 10	Z7.280.3027.0	162
GEHAUSEUNTERTEIL	77.325.1028.0	647	IVB 1 WK4.- 12	Z7.255.5227.0	86	IBWVK 2.5 -11	Z7.280.3127.0	162
GEHAUSEUNTERTEIL	77.325.1628.0	647	IVB WK 4/D.- 2	Z7.281.7227.0	112	IBWVK 2.5 -		

contents of
type description

contents TYPE

Type	Part no.	section / page	Type	Part no.	section / page	Type	Part no.	section / page
IBWBK 4 - 7	Z7.281.1727.0	87	KL 16 / 16 PA DS	29.401.1653.0	256	KL.ADA. ST. 6WR	70.135.0653.3	643
IBWBK 4 - 8	Z7.281.1827.0	87	KL 16 / 20 PA	29.400.2053.0	256	KL.ADA. ST. 6WR	70.135.0653.4	643
IBWBK 4 - 9	Z7.281.1927.0	87	KL 16 / 20 PA DS	29.401.2053.0	256	KL.ADA. ST. 6WR	72.015.0653.0	693
IBWBK 4 - 10	Z7.281.2027.0	87	KL 16 / 4 PA	29.400.0453.0	256	KL.ADA. ST. 6WR	72.115.0653.0	655
IBWBK 4 - 11	Z7.281.2127.0	87	KL 16 / 4 PA DS	29.401.0453.0	256	KL.ADA. ST. 6WR	72.115.0653.4	655
IBWBK 4 - 12	Z7.281.2227.0	87	KL 16 / 6 PA	29.400.0653.0	256	KL.ADA. ST.10WL	70.110.1053.3	631
IBWBK 6 - 2	Z7.282.2227.0	103	KL 16 / 6 PA DS	29.401.0653.0	256	KL.ADA. ST.10WL	70.110.1053.4	631
IBWBK 6 - 3	Z7.282.2327.0	101	KL 16 / 8 PA	29.400.0853.0	256	KL.ADA. ST.10WL	70.130.1053.3	643
IBWBK 6 - 4	Z7.282.2427.0	163	KL 16 / 8 PA DS	29.401.0853.0	256	KL.ADA. ST.10WL	70.130.1053.4	643
IBWBK 6 - 5	Z7.282.2527.0	163	KL 20 / 2 DS PA	29.500.1253.0	264	KL.ADA. ST.10WL	72.110.1053.0	655
IBWBK 6 - 6	Z7.282.2627.0	163	KL 20 / 2 PA	29.500.2053.0	264	KL.ADA. ST.10WL	72.110.1053.4	655
IBWBK 6 - 7	Z7.282.2727.0	163	KL 20 / 4 DS PA	29.500.1353.0	264	KL.ADA. ST.10WR	70.115.1053.3	631
IBWBK 6 - 8	Z7.282.2827.0	163	KL 20 / 4 PA	29.500.0353.0	264	KL.ADA. ST.10WR	70.115.1053.4	631
IBWBK 6 - 9	Z7.282.2927.0	163	KL 24 / 2	29.500.9253.0	265	KL.ADA. ST.10WR	70.135.1053.3	643
IBWBK 6 - 10	Z7.282.3027.0	163	KL 24 / 3	29.500.9353.0	265	KL.ADA. ST.10WR	70.135.1053.4	643
IBWBK 6 - 11	Z7.282.3127.0	163	KL 24 / 3 SL	29.502.9353.0	265	KL.ADA. ST.10WR	72.115.1053.0	655
IBWBK 6 - 12	Z7.282.3227.0	103	KL 24 / 4	29.500.9453.0	265	KL.ADA. ST.10WR	72.115.1053.4	655
IBWBK 10 - 4	Z7.283.2427.0	78	KL 24 / 5	29.500.9553.0	265	KL.ADA. ST.16WL	70.110.1653.3	631
IBWBK 2.5 - 2	Z7.280.6227.0	19	KL 24 / 5 SL	29.502.9553.0	265	KL.ADA. ST.16WL	70.110.1653.4	631
IBWBKF 2.5 - 2	Z7.280.6227.0	308	KL 28 / 6 DS PA	33.011.0653.0	214	KL.ADA. ST.16WL	72.110.1653.0	655
IBWBKF 2.5 - 3	Z7.280.6327.0	308	KL 28 / 6 DS PA	33.041.0653.0	214	KL.ADA. ST.16WL	72.110.1653.4	655
IBWBKF 2.5 - 3	Z7.280.6327.0	19	KL 30 / 3 DS PA	29.500.4053.0	265	KL.ADA. ST.16WR	70.115.1653.3	631
IBWBKF 2.5 - 4	Z7.280.6427.0	308	KL 30 / 3 PA	29.500.3053.0	265	KL.ADA. ST.16WR	70.115.1653.4	631
IBWBKF 2.5 - 4	Z7.280.6427.0	20	KL 58 / 3 / 1	29.130.1353.0	268	KL.ADA. ST.16WR	72.115.1653.0	655
IBWBKF 2.5 - 5	Z7.280.6527.0	20	KL 58 / 3 S / 1	29.131.1353.0	269	KL.ADA. ST.16WR	72.115.1653.4	655
IBWBKF 2.5 - 5	Z7.280.6527.0	308	KL 58 / 3 SR / 1	29.131.2353.0	269	KL.ADA. ST.24WL	70.110.2453.3	631
IBWBKF 2.5 - 6	Z7.280.6627.0	20	KL 58 / 5 / 1	29.130.1553.0	268	KL.ADA. ST.24WL	70.110.2453.4	631
IBWBKF 2.5 - 6	Z7.280.6627.0	308	KL 58 / 5 S / 1	29.131.1553.0	269	KL.ADA. ST.24WL	72.110.2453.0	655
IBWBKF 2.5 - 7	Z7.280.6727.0	308	KL 58 / 5 SR / 1	29.131.2553.0	269	KL.ADA. ST.24WL	72.110.2453.4	655
IBWBKF 2.5 - 7	Z7.280.6727.0	19	KL 58 / 6 / 1	29.130.1653.0	268	KL.ADA. ST.24WR	70.115.2453.3	631
IBWBKF 2.5 - 8	Z7.280.6827.0	308	KL 58 / 6 S / 1	29.131.1653.0	269	KL.ADA. ST.24WR	70.115.2453.4	631
IBWBKF 2.5 - 8	Z7.280.6827.0	20	KL 58 / 6 SR / 1	29.131.2653.0	269	KL.ADA. ST.24WR	72.115.2453.0	655
IBWBKF 2.5 - 9	Z7.280.6927.0	20	KL.ADA. BU. 3WL	70.120.0353.3	643	KL.ADA. ST.24WR	72.115.2453.4	655
IBWBKF 2.5 - 9	Z7.280.6927.0	308	KL.ADA. BU. 3WL	70.120.0353.4	643	KL.ADA. ST.40WL	73.110.4053.0	719
IBWBKF 2.5 - 10	Z7.280.7027.0	20	KL.ADA. BU. 3WR	70.125.0353.3	643	KL.ADA. ST.40WR	73.115.4053.0	719
IBWBKF 2.5 - 10	Z7.280.7027.0	308	KL.ADA. BU. 3WR	70.125.0353.4	643	KL.ADA. ST.64WL	73.110.6453.0	719
IBWBKF 4 - 2	Z7.261.1227.0	20	KL.ADA. BU. 6WL	70.000.0653.0	689	KL.ADA. ST.64WR	73.115.6453.0	719
IBWBKF 4 - 10	Z7.261.2027.0	20	KL.ADA. BU. 6WL	70.100.0653.3	631	KL.ADA. STF 6WL	70.111.0653.0	631
IBWBKF 10 - 2	Z7.283.8227.0	21	KL.ADA. BU. 6WL	70.100.0653.4	631	KL.ADA. STF 6WR	70.111.0653.0	631
IBWBKF 16 - 2	Z7.284.4227.0	21	KL.ADA. BU. 6WL	70.120.0653.3	643	KL.ADA. STF10WL	70.111.1053.0	631
IBWBKF 4 - 3	Z7.261.1327.0	20	KL.ADA. BU. 6WL	70.120.0653.4	643	KL.ADA. STF10WR	70.111.1653.0	631
IBWBKF 4 - 4	Z7.261.1427.0	20	KL.ADA. BU. 6WL	72.000.0653.0	693	KL.ADA. STF10WR	70.116.1053.0	631
IBWBKF 4 - 5	Z7.261.1527.0	20	KL.ADA. BU. 6WL	72.100.0653.0	655	KL.ADA. STF16WR	70.116.1653.0	631
IBWBKF 4 - 6	Z7.261.1627.0	20	KL.ADA. BU. 6WL	72.100.0653.4	655	KL.ADA. STF24WR	70.111.2453.0	631
IBWBKF 4 - 7	Z7.261.1727.0	20	KL.ADA. BU. 6WR	70.005.0653.0	689	KL.ADA. STF24WR	70.116.2453.0	631
IBWBKF 4 - 8	Z7.261.1827.0	20	KL.ADA. BU. 6WR	70.105.0653.3	631	KL.ADA. BU.4/6WR	72.107.1053.0	699
IBWBKF 4 - 9	Z7.261.1927.0	20	KL.ADA. BU. 6WR	70.105.0653.4	631	KL.ADA. ST.4/6WR	72.117.1053.0	699
IBWBKF 6 - 2	Z7.282.4227.0	21	KL.ADA. BU. 6WR	70.125.0653.3	643	KL.ADAP. BUF 3P WL	70.121.0353.0	643
IBWBK35 - 2	Z7.285.4227.0	79	KL.ADA. BU. 6WR	70.125.0653.4	643	KL.ADAP. BUF 3P WR	70.126.0353.0	643
IBWBK35 - 3	Z7.285.4327.0	79	KL.ADA. BU. 6WR	72.005.0653.0	693	KL.ADAP. BUF 3P WR	70.136.0653.0	643
IBWBK35 - 4	Z7.285.4427.0	79	KL.ADA. BU. 6WR	72.105.0653.0	655	KL.ADAP. BUF 3P WR	70.136.1053.0	643
IBWBK35 - 5	Z7.285.4527.0	79	KL.ADA. BU. 6WR	72.105.0653.4	655	KL.ADAP. BUF 6P WL	70.121.0653.0	643
IBWBK35 - 6	Z7.285.4627.0	79	KL.ADA. BU.10WL	70.100.1053.3	631	KL.ADAP. BUF 6P WL	70.121.0653.0	655
IBWBK10 - 2	Z7.283.2227.0	78	KL.ADA. BU.10WL	70.100.1053.4	631	KL.ADAP. BUF 6P WR	70.126.0653.0	643
IBWBK10 - 3	Z7.283.2327.0	78	KL.ADA. BU.10WL	70.120.1053.3	643	KL.ADAP. BUF 6P WR	72.106.0653.0	655
IBWBK10 - 5	Z7.283.2527.0	78	KL.ADA. BU.10WL	70.120.1053.4	643	KL.ADAP. BUF10P WL	70.121.1053.0	643
IBWBK10 - 6	Z7.283.2627.0	78	KL.ADA. BU.10WL	72.100.1053.0	655	KL.ADAP. BUF10P WL	72.101.1053.0	655
IBWBK10 - 7	Z7.283.2727.0	163	KL.ADA. BU.10WL	72.100.1053.4	655	KL.ADAP. BUF10P WR	70.126.1053.0	643
IBWBK10 - 8	Z7.283.2827.0	163	KL.ADA. BU.10WR	70.105.1053.3	631	KL.ADAP. BUF10P WR	72.106.1053.0	655
IBWBK10 - 9	Z7.283.2927.0	163	KL.ADA. BU.10WR	70.105.1053.4	631	KL.ADAP. BUF16P WL	72.101.1653.0	655
IBWBK10 - 10	Z7.283.3027.0	163	KL.ADA. BU.10WR	70.125.1053.3	643	KL.ADAP. BUF16P WR	72.106.1653.0	655
IBWBK10 - 11	Z7.283.3127.0	163	KL.ADA. BU.10WR	70.125.1053.4	643	KL.ADAP. BUF24P WL	72.101.2453.0	655
IBWBK10 - 12	Z7.283.3227.0	103	KL.ADA. BU.10WR	72.105.1053.0	655	KL.ADAP. BUF24P WR	72.106.2453.0	655
IBWBK16 - 2	Z7.284.2227.0	104	KL.ADA. BU.16WL	72.105.1053.4	655	KL.ADAP. STF 3P WL	70.131.0353.0	643
IBWBK16 - 3	Z7.284.2327.0	104	KL.ADA. BU.16WL	70.100.1653.3	631	KL.ADAP. STF 3P WR	70.136.0353.0	643
IBWBK16 - 4	Z7.284.2427.0	163	KL.ADA. BU.16WL	70.100.1653.4	631	KL.ADAP. STF 6P WL	70.131.0653.0	643
IBWBK16 - 5	Z7.284.2527.0	163	KL.ADA. BU.16WL	72.100.1653.0	655	KL.ADAP. STF 6P WL	72.111.0653.0	655
IBWBK16 - 6	Z7.284.2627.0	163	KL.ADA. BU.16WL	72.100.1653.4	655	KL.ADAP. STF 6P WR	72.116.0653.0	655
IBWBK16 - 7	Z7.284.2727.0	163	KL.ADA. BU.16WR	70.105.1653.3	631	KL.ADAP. STF10P WL	70.131.1053.0	643
IBWBK16 - 8	Z7.284.2827.0	163	KL.ADA. BU.16WR	70.105.1653.4	631	KL.ADAP. STF10P WL	72.111.1053.0	655
IBWBK16 - 9	Z7.284.2927.0	163	KL.ADA. BU.16WR	72.105.1653.0	655	KL.ADAP. STF10P WR	72.116.1053.0	655
IBWBK16 - M-30	Z7.284.2027.0	163	KL.ADA. BU.16WR	72.105.1653.4	655	KL.ADAP. STF16P WL	72.111.1653.0	655
IBWBK16 - 10	Z7.284.3027.0	163	KL.ADA. BU.24WL	70.100.2453.3	631	KL.ADAP. STF16P WR	72.116.1653.0	655
IBWBK16 - 11	Z7.284.3127.0	163	KL.ADA. BU.24WL	70.100.2453.4	631	KL.ADAP. STF24P WL	72.111.2453.0	655
IBWBK16 - 12	Z7.284.3227.0	104	KL.ADA. BU.24WL	72.100.2453.0	655	KL.ADAP. STF24P WR	72.116.2453.0	655
IBWBK35 - 2	Z7.285.2227.0	105	KL.ADA. BU.24WR	72.100.2453.4	655	KL.LST.BEZ. TS15	Z7.311.2753.0	167
IBWBK35 - 3	Z7.285.2327.0	105	KL.ADA. BU.24WR	70.105.2453.3	631	KL17 N / 1 / S6.3	29.608.0153.0	267
IBWBK35 - 4	Z7.285.2427.0	163	KL.ADA. BU.24WR	70.105.2453.4	631	KL17 N / 1 K / S6.3	29.608.3153.0	267
IBWBK35 - 5	Z7.285.2527.0	163	KL.ADA. BU.24WR	72.105.2453.0	655	KL17 N / 2 / S6.3	29.608.0253.0	267
IBWBK35 - 6	Z7.285.2627.0	163	KL.ADA. BU.24WR	72.105.2453.4	655	KL17 N / 2 K / S6.3	29.608.3253.0	267
IBWBK35 - 7	Z7.285.2727.0	163	KL.ADA. BU.40WL	73.100.4053.0	719	KL17 N / 3 / S6.3	29.608.0353.0	267
IBWBK35 - 8	Z7.285.2827.0	163	KL.ADA. BU.40WR	73.105.4053.0	719	KL17 N / 3 K / S6.3	29.608.3353.0	267
IBWBK35 - 9	Z7.285.2927.0	163	KL.ADA. BU.64WL	73.100.6453.0	719	KL17 N / 4 / S6.3	29.608.0453.0	267
IBWBK35 - M-20	Z7.285.2027.0	163	KL.ADA. BU.64WR	73.105.6453.0	719	KL17 N / 4 K / S6.3	29.608.3453.0	267
IBWBK35 - 10	Z7.285.3027.0	163	KL.ADA. BUF 6WL	70.101.0653.0	631	KL17 N / 5 / S6.3	29.608.0553.0	267
IBWBK35 - 11	Z7.285.3127.0	163	KL.ADA. BUF 6WR	70.106.0653.0	631	KL17 N / 5 K / S6.3	29.608.3553.0	267
IBWBK35 - 12	Z7.285.3227.0	105	KL.ADA. BUF10WL	70.101.1053.0	631	KL17 N / 6 / S6.3	29.608.0653.0	267
IVK WK 4/DEU-2	Z7.256.2227.0	112	KL.ADA. BUF10WR	70.106.1053.0	631	KL17 N / 6 K / S6.3	29.608.3653.0	267
IK WK 4/DEU-6	Z7.256.2627.0	112	KL.ADA. BUF16WL	70.101.1653.0	631	KL17 N / 7 / S6.3	29.608.0753.0	267
KL 15 - 20.5	Z2.803.2228.0	210	KL.ADA. BUF16WR	70.106.1653.0	631	KL17 N / 7 K / S6.3	29.608.3753.0	267
K 19 - 27	Z2.803.2328.0	210	KL.ADA. BUF24WL	70.101.2453.0	631	KL17 N / 8 / S6.3	29.608.0853.0	267
K 26 - 34	Z2.803.2428.0	210	KL.ADA. BUF24WR	70.106.2453.0	631	KL17 N / 8 K / S6.3	29.608.3853.0	267
KABELVERSCHR.B	Z5.507.1321.0	776	KL.ADA. ST. 3WL	70.130.0353.3	643	KL17 N / 9 / S6.3	29.608.0953.0	267
KABELVERSCHR.B	Z5.507.1521.0	776	KL.ADA. ST. 3WL	70.130.0353.4	643	KL17 N / 9 K / S6.3	29.608.3953.0	267
KABELVERSCHR.B	Z5.507.1721.0	776	KL.ADA. ST. 3WR	70.135.0353.3	643	KL17 N / 10 / S6.3	29.608.1053.0	267
KB 1 RM 5.08	Z8.000.0103.4	460	KL.ADA. ST. 3WR	70.135.0353.4	643	KL17 N / 10 K / S6.3	29.608.4053.0	267
KBD 1 / 2 KR	Z8.121.0240.0	266	KL.ADA. ST. 6WL	70.010.0653.0	689	KL17 N / 11 / S6.3	29.608.1153.0	267
KBD 1 / 3 KR	Z8.121.0340.0	266	KL.ADA. ST. 6WL	70.110.0653.3	631	KL17 N / 11 K / S6.3	29.608.4153.0	267
KBD 1 / 4								

contents

Type	Part no.	section / page	Type	Part no.	section / page	Type	Part no.	section / page
KL17 N/17 /S6,3	29.608.1753.0	267	LP.STIFBLEISTE	Z5.531.4125.0	316	LPST 1 / 14 OB	25.010.1456.0	330
KL17 N/18 /S6,3	29.608.1853.0	267	LP.STIFBLEISTE	Z5.531.4225.0	316	LPST 1 / 15	25.000.1556.0	330
KL17 N/19 /S6,3	29.608.1953.0	267	LP.STIFBLEISTE	Z5.531.4325.0	316	LPST 1 / 15 OB	25.010.1556.0	330
KL17 N/20 /S6,3	29.608.2053.0	267	LP.STIFBLEISTE	Z5.531.4425.0	316	LPST 1 / 16	25.000.1656.0	330
KL17 N/20 K/S6,3	29.608.5053.0	267	LP.STIFBLEISTE	Z5.531.4525.0	316	LPST 1 / 16 OB	25.010.1656.0	330
KL17 N/21 /S6,3	29.608.2153.0	267	LP.STIFBLEISTE	Z5.531.4625.0	316	LPSTL 1 / 2	25.001.0256.0	330
KL17 N/22 /S6,3	29.608.2253.0	267	LP.STIFBLEISTE	Z5.532.0225.0	317	LPSTL 1 / 3	25.001.0356.0	330
KL17 N/23 /S6,3	29.608.2353.0	267	LP.STIFBLEISTE	Z5.532.0325.0	317	LPSTL 1 / 4	25.001.0456.0	330
KL17 N/24 /S6,3	29.608.2453.0	267	LP.STIFBLEISTE	Z5.532.0425.0	317	LPSTL 1 / 5	25.001.0556.0	330
KL17N/15 /S6,3	29.608.1553.0	267	LP.STIFBLEISTE	Z5.532.0525.0	317	LPSTL 1 / 6	25.001.0656.0	330
KLINGE	05.502.0500.0	207	LP.STIFBLEISTE	Z5.532.0625.0	317	LPSTL 1 / 7	25.001.0756.0	330
KONT.AUFNAHME 1	05.502.3100.0	739	LP.STIFBLEISTE	Z5.532.0725.0	317	LPSTL 1 / 8	25.001.0856.0	330
KONT.AUFNAHME 1	05.502.3100.0	798	LP.STIFBLEISTE	Z5.532.0825.0	317	LPSTL 1 / 9	25.001.0956.0	330
KONT.AUFNAHME 2	05.502.3200.0	683	LP.STIFBLEISTE	Z5.532.0925.0	317	LPSTL 1 / 10	25.001.1056.0	330
KONT.AUFNAHME 2	05.502.3200.0	798	LP.STIFBLEISTE	Z5.532.1025.0	317	LPSTL 1 / 11	25.001.1156.0	330
KONT.AUFNAHME 3	05.502.3300.0	631	LP.STIFBLEISTE	Z5.532.1125.0	317	LPSTL 1 / 12	25.001.1256.0	330
KONT.AUFNAHME 3	05.502.3300.0	798	LP.STIFBLEISTE	Z5.532.1225.0	317	LPSTL 1 / 13	25.001.1356.0	330
KONTAKTFEDER	05.549.1200.0	177	LP.STIFBLEISTE	Z5.532.1325.0	317	LPSTL 1 / 14	25.001.1456.0	330
KSD 11 / 1 Z KR	19.230.0040.0	216	LP.STIFBLEISTE	Z5.532.1425.0	317	LPSTL 1 / 15	25.001.1556.0	330
KSD 10 V	57.803.8053.0	509	LP.STIFBLEISTE	Z5.532.1525.0	317	LPSTL 1 / 16	25.001.1656.0	330
KURZSCHLUSSTECKER	Z5.553.9400.0	176	LP.STIFBLEISTE	Z5.532.1625.0	317	M - PB 8 SP	87.220.0853.3	482
LEITERHALTER	07.470.2256.0	258	LP.STIFBLEISTE	Z5.532.3225.0	317	M - PB 1 SR	87.220.1353.3	482
LEITERHALTER	07.470.3256.0	258	LP.STIFBLEISTE	Z5.532.3325.0	317	M - PB 4 SG	87.220.1453.3	483
LEL 1,5/1 WEISS	05.562.2453.0	309	LP.STIFBLEISTE	Z5.532.3425.0	317	M - PB 4 SP	87.220.0753.3	482
LEL 1,5/1 WEISS	05.562.2453.0	33	LP.STIFBLEISTE	Z5.532.3525.0	317	M - PB 8 SG	87.220.1553.3	483
LEL 1,5/2 GRAU	05.562.2553.0	33	LP.STIFBLEISTE	Z5.532.3625.0	317	M 16 x 1,5	25.507.2121.0	776
LEL 1,5/2 GRAU	05.562.2553.0	309	LP.STIFBLEISTE	Z5.532.3725.0	317	M 16 x 1,5	25.507.9521.0	777
LEL 1,5/3 SCHWARZ	05.562.2653.0	309	LP.STIFBLEISTE	Z5.532.3825.0	317	M 16 x 1,5 - M 20 x 1,5	05.507.8621.0	778
LEL 1,5/3 SCHWARZ	05.562.2653.0	33	LP.STIFBLEISTE	Z5.532.3925.0	317	M 20 x 1,5	05.507.4021.0	779
LEL 2,5/1 WEISS	05.561.6553.0	19	LP.STIFBLEISTE	Z5.532.4025.0	317	M 20 x 1,5	05.507.4053.0	779
LEL 2,5/1 WEISS	05.561.6553.0	308	LP.STIFBLEISTE	Z5.532.4125.0	317	M 20 x 1,5	25.507.2221.0	776
LEL 2,5/2 GRAU	05.561.6653.0	308	LP.STIFBLEISTE	Z5.532.4225.0	317	M 20 x 1,5	25.507.4821.0	777
LEL 2,5/2 GRAU	05.561.6653.0	20	LP.STIFBLEISTE	Z5.532.4325.0	317	M 20 x 1,5	25.507.5821.0	777
LEL 2,5/3 SCHWARZ	05.561.6753.0	308	LP.STIFBLEISTE	Z5.532.4425.0	317	M 20 x 1,5	25.507.9621.0	777
LEL 2,5/3 SCHWARZ	05.561.6753.0	19	LP.STIFBLEISTE	Z5.532.4525.0	317	M 20 x 1,5 IP68	25.507.1353.0	776
LEL 4/1 WEISS	05.561.8553.0	20	LP.STIFBLEISTE	Z5.532.4625.0	317	M 20 x 1,5 - M 16 x 1,5	05.507.9021.0	778
LEL 4/2 GRAU	05.561.8653.0	20	LP.STIFBLEISTE	Z5.540.0225.0	319	M 20 x 1,5 - M 25 x 1,5	05.507.8721.0	778
LEL 4/3 SCHWARZ	05.561.8753.0	20	LP.STIFBLEISTE	Z5.540.0325.0	319	M 20 x 1,5 - PG 13,5	05.507.8121.0	779
LOCHSTREIFEN	07.413.3653.0	331	LP.STIFBLEISTE	Z5.540.0425.0	319	M 20 x 1,5 - PG 16	05.507.8221.0	779
LP.STIFBLEISTE	Z5.530.0225.0	318	LP.STIFBLEISTE	Z5.540.0525.0	319	M 25 x 1,5	05.507.4121.0	779
LP.STIFBLEISTE	Z5.530.0325.0	318	LP.STIFBLEISTE	Z5.540.0625.0	319	M 25 x 1,5	05.507.4153.0	779
LP.STIFBLEISTE	Z5.530.0425.0	318	LP.STIFBLEISTE	Z5.540.0825.0	319	M 25 x 1,5	25.507.2321.0	776
LP.STIFBLEISTE	Z5.530.0525.0	318	LP.STIFBLEISTE	Z5.540.0925.0	319	M 25 x 1,5	25.507.6021.0	777
LP.STIFBLEISTE	Z5.530.0625.0	318	LP.STIFBLEISTE	Z5.540.1025.0	319	M 25 x 1,5	25.507.9721.0	777
LP.STIFBLEISTE	Z5.530.0725.0	318	LP.STIFBLEISTE	Z5.540.1125.0	319	M 25 x 1,5 - M 20 x 1,5	05.507.9121.0	778
LP.STIFBLEISTE	Z5.530.0825.0	318	LP.STIFBLEISTE	Z5.540.1225.0	319	M 25 x 1,5 - M 32 x 1,5	05.507.8821.0	778
LP.STIFBLEISTE	Z5.530.0925.0	318	LP.STIFBLEISTE	Z5.540.1325.0	319	M 25 x 1,5 - PG 21	05.507.8321.0	779
LP.STIFBLEISTE	Z5.530.1025.0	318	LP.STIFBLEISTE	Z5.540.1425.0	319	M 25x1,5 IP68	25.507.1553.0	776
LP.STIFBLEISTE	Z5.530.1125.0	318	LP.STIFBLEISTE	Z5.540.1525.0	319	M 32 x 1,5	05.507.4221.0	779
LP.STIFBLEISTE	Z5.530.1225.0	318	LP.STIFBLEISTE	Z5.540.1625.0	319	M 32 x 1,5	05.507.4253.0	779
LP.STIFBLEISTE	Z5.530.1325.0	318	LP.STIFBLEISTE	Z5.540.3225.0	319	M 32 x 1,5	25.507.2421.0	776
LP.STIFBLEISTE	Z5.530.1425.0	318	LP.STIFBLEISTE	Z5.540.3325.0	319	M 32 x 1,5	25.507.5221.0	777
LP.STIFBLEISTE	Z5.530.1525.0	318	LP.STIFBLEISTE	Z5.540.3425.0	319	M 32 x 1,5	25.507.6221.0	777
LP.STIFBLEISTE	Z5.530.1625.0	318	LP.STIFBLEISTE	Z5.540.3525.0	319	M 32 x 1,5	25.507.9821.0	777
LP.STIFBLEISTE	Z5.530.3225.0	318	LP.STIFBLEISTE	Z5.540.3625.0	319	M 32 x 1,5 IP68	25.507.1753.0	776
LP.STIFBLEISTE	Z5.530.3325.0	318	LP.STIFBLEISTE	Z5.540.3725.0	319	M 32 x 1,5 - M 25 x 1,5	05.507.9221.0	778
LP.STIFBLEISTE	Z5.530.3425.0	318	LP.STIFBLEISTE	Z5.540.3825.0	319	M 32 x 1,5 - M 40 x 1,5	05.507.8921.0	778
LP.STIFBLEISTE	Z5.530.3525.0	318	LP.STIFBLEISTE	Z5.540.3925.0	319	M 32 x 1,5 - PG 29	05.507.8421.0	779
LP.STIFBLEISTE	Z5.530.3625.0	318	LP.STIFBLEISTE	Z5.540.4025.0	319	M 40 x 1,5	05.507.4321.0	779
LP.STIFBLEISTE	Z5.530.3725.0	318	LP.STIFBLEISTE	Z5.540.4125.0	319	M 40 x 1,5	05.507.4353.0	779
LP.STIFBLEISTE	Z5.530.3825.0	318	LP.STIFBLEISTE	Z5.540.4225.0	319	M 40 x 1,5	25.507.6421.0	777
LP.STIFBLEISTE	Z5.530.3925.0	318	LP.STIFBLEISTE	Z5.540.4325.0	319	M 40 x 1,5 IP68	25.507.1921.0	776
LP.STIFBLEISTE	Z5.530.4025.0	318	LP.STIFBLEISTE	Z5.540.4425.0	319	M 40 x 1,5 - M 32 x 1,5	05.507.9321.0	778
LP.STIFBLEISTE	Z5.530.4125.0	318	LP.STIFBLEISTE	Z5.540.4525.0	319	M 40x1,5 IP68	25.507.1953.0	776
LP.STIFBLEISTE	Z5.530.4225.0	318	LP.STIFBLEISTE	Z5.540.4625.0	319	M-IAC 24	25.580.7800.0	482
LP.STIFBLEISTE	Z5.530.4325.0	318	LP.STIFBLEISTE	Z5.540.6225.0	319	M-IDC 24	25.580.8100.0	482
LP.STIFBLEISTE	Z5.530.4425.0	318	LP.STIFBLEISTE	Z5.540.6325.0	319	M25 x 1,5	25.507.5021.0	777
LP.STIFBLEISTE	Z5.530.4525.0	318	LP.STIFBLEISTE	Z5.540.6425.0	319	MAGAZIN M.25 BUCHS.	22.123.7400.0	800
LP.STIFBLEISTE	Z5.530.4625.0	318	LP.STIFBLEISTE	Z5.540.6525.0	319	MAGAZIN M. 25 BU.	22.123.7000.0	800
LP.STIFBLEISTE	Z5.530.6225.0	318	LP.STIFBLEISTE	Z5.540.6625.0	319	MAGAZIN M. 25 BU.	22.123.7100.0	800
LP.STIFBLEISTE	Z5.530.6325.0	318	LP.STIFBLEISTE	Z5.540.6725.0	319	MAGAZIN M. 25 BU.	22.123.7200.0	800
LP.STIFBLEISTE	Z5.530.6425.0	318	LP.STIFBLEISTE	Z5.540.6825.0	319	MAGAZIN M. 25 BU.	22.123.7300.0	800
LP.STIFBLEISTE	Z5.530.6525.0	318	LP.STIFBLEISTE	Z5.540.8225.0	319	MAGAZIN M. 25 ST.	25.543.7000.0	800
LP.STIFBLEISTE	Z5.530.6625.0	318	LP.STIFBLEISTE	Z5.540.8325.0	319	MAGAZIN M. 25 ST.	25.543.7100.0	800
LP.STIFBLEISTE	Z5.530.6725.0	318	LP.STIFBLEISTE	Z5.540.8425.0	319	MAGAZIN M. 25 ST.	25.543.7200.0	800
LP.STIFBLEISTE	Z5.530.6825.0	318	LP.STIFBLEISTE	Z5.540.8525.0	319	MAGAZIN M. 25 ST.	25.543.7300.0	800
LP.STIFBLEISTE	Z5.530.8225.0	318	LP.STIFBLEISTE	Z5.540.8625.0	319	MAGAZIN M. 25 ST.	25.543.7400.0	800
LP.STIFBLEISTE	Z5.530.8325.0	318	LP.STIFBLEISTE	Z5.540.8725.0	319	MMLEISTEGE / 5	21.310.0553.0	258
LP.STIFBLEISTE	Z5.530.8425.0	318	LP.STIFBLEISTE	Z5.540.8825.0	319	MOD. 3POL	05.502.0910.0	741
LP.STIFBLEISTE	Z5.530.8525.0	318	LP.STIFBLEISTE	Z5.599.9025.0	320	MOD. 4POL	05.502.0610.0	741
LP.STIFBLEISTE	Z5.530.8625.0	318	LP.STIFBLEISTE	Z5.540.0725.0	319	MOD. 5POL	05.502.0810.0	741
LP.STIFBLEISTE	Z5.530.8725.0	318	LPB-14L-250VIA	87.400.3053.0	540	MOD. 10POL	05.502.0710.0	741
LP.STIFBLEISTE	Z5.530.8825.0	318	LPST 1 / 2	25.000.0256.0	330	MOD.20POL	05.502.0410.0	741
LP.STIFBLEISTE	Z5.531.0225.0	316	LPST 1 / 2 OB	25.010.0256.0	330	MODULLOESEWZ.	05.502.1010.0	741
LP.STIFBLEISTE	Z5.531.0325.0	316	LPST 1 / 3	25.000.0356.0	330	N SH/35/F	21.980.0153.0	213
LP.STIFBLEISTE	Z5.531.0425.0	316	LPST 1 / 3 OB	25.010.0356.0	330	OAC 3-32V/24-280V	28.000.0156.9	482
LP.STIFBLEISTE	Z5.531.0525.0	316	LPST 1 / 4	25.000.0456.0	330	OBerteil	75.013.0051.0	758
LP.STIFBLEISTE	Z5.531.0625.0	316	LPST 1 / 4 OB	25.010.0456.0	330	OBerteil	75.013.0051.2	758
LP.STIFBLEISTE	Z5.531.0725.0	316	LPST 1 / 5	25.000.0556.0	330	ODC 3-32V/3-200V	28.000.0169.9	482
LP.STIFBLEISTE	Z5.531.0825.0	316	LPST 1 / 5 OB	25.010.0556.0	330	ODC 3-32V/3-60V	28.000.0169.8	482
LP.STIFBLEISTE	Z5.531.0925.0	316	LPST 1 / 6	25.000.0656.0	330	PG 13,5 - M 20 x 1,5	05.507.7621.0	778
LP.STIFBLEISTE	Z5.531.1025.0	316	LPST 1 / 6 OB	25.010.0656.0	330	PG 16 - M 20 x 1,5	05.507.7721.0	778
LP.STIFBLEISTE	Z5.531.1125.0	316	LPST 1 / 7	25.000.0756.0	330	PG 21 - M 25 x 1,5	05.507.7821.0	778
LP.STIFBLEISTE	Z5.531.1225.0	316	LPST 1 / 7 OB	25.010.0756.0	330	PRESSWERKZEUG	95.101.0900.0	798
LP.STIFBLEISTE	Z5.531.1325.0	316	LPST 1 / 8	25.000.0856.0	330	PRESSWERKZEUG	95.101.1000.0	798
LP.STIFBLEISTE	Z5.531.1425.0	316	LPST 1 / 8 OB	25.010.0856.0	330	PRESSWERKZEUG	95.101.1100.0	799
LP.STIFBLEISTE	Z5.531.1525.0	316	LPST 1 / 9	25.000.0956.0	330	PRESSWERKZEUG	95.101.1200.0	799
LP.STIFBLEISTE	Z5.531.1625.0	316	LPST 1 / 9 OB	25.010.0956.0	330	PRUEFSTECKER	21.299.7153.0	189
LP.STIFBLEISTE	Z5.531.3225.0	316	LPST 1 / 10	25.000.1056.0	330	PRUEFSTECKER	21.299.8153.0	176
LP.STIFBLEISTE	Z5.531.3325.0	316	LPST 1 / 10 OB	25.010.1056.0	330	PRUEFSTECKER	25.533.7121.0	357
LP.STIFBLEISTE	Z5.531.3425.0	316	LPST 1 / 11	25.000.1156.0	330	PRUEFSTECKER	25.533.7221.0	357
LP.STIFBLEISTE	Z5.531.3525.0	316	LPST 1 / 11 OB	25.010.1156.0	330	PRUEFSTECKER	25.543.0153.0	358
LP.STIFBLEISTE	Z5.531.3625.0	316	LPST 1 / 12	25.000.1256.0	3			

contents of
type description

contents

Type	Part no.	section / page	Type	Part no.	section / page	Type	Part no.	section / page
QUERSCHALTASCHKE	Z7.269.2823.0	197	RICOS EC-DP	83.030.0001.1	414	ST 70.3 /10 RVZ	Z5.571.2256.0	675
QUERSCHALTASCHKE	Z7.269.2923.0	161	RICOS EC-S	83.031.0001.1	414	ST 70.3 /16 REV	Z5.571.1056.0	675
QUERSCHALTASCHKE	Z7.269.3023.0	189	RICOS MANUAL D	05.591.3389.0	410	ST 70.3 /16 REVZ	Z5.571.0056.0	675
QUERSCHALTASCHKE	Z7.269.3123.0	191	RICOS POSITION	83.035.5410.1	422	ST 70.3 /16 RV	Z5.571.3056.0	675
QUERSCHALTASCHKE	Z7.269.3223.0	191	RICOS S 16 I	83.031.1000.1	428	ST 70.3 /16 RVZ	Z5.571.2056.0	675
QUERSCHALTASCHKE	Z7.269.3423.0	192	RICOS S 16 O	83.031.1200.1	428	ST 70.3 /24 REVZ	Z5.571.0356.0	675
QUERSCHALTASCHKE	Z7.269.3523.0	190	RICOS S 8 I/O	83.031.1100.1	428	ST 70.3 /24 RV	Z5.571.3356.0	675
QUERSCHALTASCHKE	Z7.269.3623.0	161	RICOS S 8I 8/O	83.031.1300.1	428	ST 70.3 /24 RVZ	Z5.571.2356.0	675
QUERSCHALTASCHKE	Z7.269.4023.0	161	RICOS SOCKET FEMALE-S	83.031.0010.0	410	ST 70.7 / 6 REV	Z5.571.5156.0	677
QUERSCHALTASCHKE	Z7.269.4123.0	161	RICOS SOCKET FINAL-DP	83.030.0011.0	410	ST 70.7 / 6 REVZ	Z5.571.4156.0	677
QUERSCHALTASCHKE	Z7.269.4223.0	161	RICOS SOCKET KNOT-DP	83.030.0010.0	410	ST 70.7 / 6 RV	Z5.571.8656.0	677
R12- IZV-WLED	Z7.220.7553.0	454	RICOS SOCKET MALE-S	83.031.0011.0	410	ST 70.7 / 6 RVZ	Z5.571.6656.0	677
RAB - FS16 W A-S5	87.221.6653.0	566	RSV 2 BLAU	93.004.0056.6	207	ST 70.7 /10 REV	Z5.571.5256.0	677
RAB - FS16 W B-S5	87.221.6753.0	566	RSV 2 GRAU	93.004.0056.6	207	ST 70.7 /10 REVZ	Z5.571.4256.0	677
RAB - SS 4	87.220.1853.0	454	RV A/2 L BLAU	26.500.4453.0	208	ST 70.7 /10 RV	Z5.571.8756.0	677
RAB - SS 4/2	87.220.4753.3	455	RVZ A/2 TP1 BLAU	26.500.4553.0	209	ST 70.7 /10 RVZ	Z5.571.6756.0	677
RAB - SS 8/2	87.220.4853.3	455	RVZ A/3 L	26.500.4153.0	208	ST 70.7 /16 REV	Z5.571.5056.0	677
RAB - SS 4 M	87.221.5553.0	454	RVZ A/3 TP1	26.500.4253.0	209	ST 70.7 /16 REVZ	Z5.571.4056.0	677
RAB-FSS 16	87.220.2253.3	454	RVZ A/4 BLAU	26.500.4353.0	208	ST 70.7 /16 RV	Z5.571.8556.0	677
RAB-FSS 8	87.220.1953.3	454	RVZ A/6	26.500.4053.0	208	ST 70.7 /16 RVZ	Z5.571.6556.0	677
RASTHEBEL	05.594.3663.0	331	RVZ S/2 L BLAU	26.500.2453.0	206	ST 70.7 /24 REV	Z5.571.5356.0	677
REDUZIERPL. 24/10	07.416.6453.0	784	RVZ S/2 TP1 BLAU	26.500.2553.0	207	ST 70.7 /24 REVZ	Z5.571.4356.0	677
REDUZIERPL. 24/16	07.416.6553.0	784	RVZ S/3 L	26.500.2153.0	206	ST 70.7 /24 RV	Z5.571.8856.0	677
REDUZIERPL. 24/6	07.416.6353.0	784	RVZ S/3 TP1	26.500.2253.0	207	ST 70.7 /24 RVZ	Z5.571.6856.0	677
REVOS MOD. RAHM.BU	78.000.0653.0	742	RVZ S/4 BLAU	26.500.2353.0	206	ST 72.3 /10 REV	Z5.571.1756.0	679
REVOS MOD. RAHM.BU	78.000.1053.0	742	RVZ S/6	26.500.2053.0	206	ST 72.1 / 6 REV WL	Z5.573.0656.0	679
REVOS MOD. RAHM.BU	78.000.1653.0	742	SBS-ASH-230V6.3A	87.010.7453.0	540	ST 72.1 / 6 REV WR	Z5.573.1656.0	679
REVOS MOD. RAHM.BU	78.000.2453.0	742	SBS-ASH-24V6.3A	87.010.7653.0	540	ST 72.1 / 6 REV U WL	Z5.573.4656.0	679
REVOS MOD. RAHM.ST	78.010.0653.0	742	SCHIENENHALTER	Z5.519.0310.0	213	ST 72.1 / 6 REV U WR	Z5.573.5656.0	679
REVOS MOD. RAHM.ST	78.010.1053.0	742	SCHIENENHALTER	Z5.519.0410.0	213	ST 72.1 / 6 RV WL	Z5.573.2656.0	679
REVOS MOD. RAHM.ST	78.010.1653.0	742	SCHIENENTRAEGER	Z1.980.0040.0	211	ST 72.1 / 6 RV WR	Z5.573.3656.0	679
REVOS MOD. RAHM.ST	78.010.2453.0	742	SCHNELLMONT.GRIFF	05.582.8153.0	175	ST 72.1 / 6 RV U WL	Z5.573.6656.0	679
REVOS MODULBU. 3P	78.004.0353.0	739	SCHNELLMONT.GRIFF	05.593.4153.0	190	ST 72.1 / 6 RV U WR	Z5.573.7656.0	679
REVOS MODULBU. 4P	78.003.0453.0	740	SCHNELLMONT.GRIFF	05.593.5853.0	190	ST 72.1 /10 REV WL	Z5.573.0756.0	679
REVOS MODULBU. 5P	78.003.0553.0	740	SCHNELLMONT.GRIFF	05.593.5953.0	191	ST 72.1 /10 REV WR	Z5.573.1756.0	679
REVOS MODULBU.10P	78.002.1053.0	740	SCHNELLMONT.GRIFF	05.594.5853.0	175	ST 72.1 /10 REV U WL	Z5.573.4756.0	679
REVOS MODULBU.20P	78.001.2053.0	740	SCHNELLMONT.GRIFF	05.594.5953.0	175	ST 72.1 /10 REV U WR	Z5.573.5756.0	679
REVOS MODULST. 3P	78.014.0353.0	739	SCHNELLMONT.GRIFF	05.594.6053.0	175	ST 72.1 /10 RV WL	Z5.573.2756.0	679
REVOS MODULST. 4P	78.013.0453.0	740	SCHRAUBBUCHSE	05.508.8621.0	197	ST 72.1 /10 RV WR	Z5.573.3756.0	679
REVOS MODULST. 5P	78.013.0553.0	740	SCHRAUBBUCHSE	05.508.8721.0	197	ST 72.1 /10 RV U WL	Z5.573.6756.0	679
REVOS MODULST.10P	78.012.1053.0	740	SCHRAUBBUCHSE	05.508.9721.0	197	ST 72.1 /10 RV U WR	Z5.573.7756.0	679
REVOS MODULST.20P	78.011.2053.0	740	SCHRAUBENSATZ	Z6.012.0812.0	305	ST 72.1 /16 REV WL	Z5.573.0556.0	679
RFK 1 / 150 FK PA/V0	59.197.0255.0	157	SCHUTZDOECKEL	Z7.409.7056.0	780	ST 72.1 /16 REV WR	Z5.573.1556.0	679
RFK 1 / 150 FMK PA/V0	59.197.1255.0	157	SCHUTZDOECKEL	Z7.409.7156.0	780	ST 72.1 /16 REV U WL	Z5.573.4556.0	679
RFK 1 / 150 FMK S35/V0	56.397.1255.0	157	SCHUTZDOECKEL	Z7.409.7256.0	780	ST 72.1 /16 REV U WR	Z5.573.5556.0	679
RFK 1 / 185 F PA/V0	59.197.0155.0	157	SCHUTZDOECKEL	Z7.409.7356.0	780	ST 72.1 /16 RV WL	Z5.573.2556.0	679
RFK 1 / 185 F S35/V0	59.198.0055.0	158	SCHUTZDOECKEL	Z7.409.8856.0	780	ST 72.1 /16 RV WR	Z5.573.3556.0	679
RFK 1 / 185 FM PA/V0	56.398.0055.0	158	SCHUTZDOECKEL	Z7.409.8956.0	780	ST 72.1 /16 RV U WL	Z5.573.6556.0	679
RFK 1 / 185 FM S35/V0	59.198.1055.0	158	SELBSTKLEBESCHILD	05.584.9489.0	183	ST 72.1 /16 RV U WR	Z5.573.7556.0	679
RFK 1 / 240 F PA/V0	56.398.1055.0	158	SIST- GL /V0	Z1.299.4255.0	38	ST 72.1 /24 REV WL	Z5.573.0856.0	679
RFK 1 / 240 F S35/V0	59.199.0055.0	159	SIST- /V0	Z1.299.4055.0	38	ST 72.1 /24 REV WR	Z5.573.1856.0	679
RFK 1 / 240 FK PA/V0	56.399.0055.0	159	SIST-LED /V0	Z1.299.4155.0	38	ST 72.1 /24 REV U WL	Z5.573.4856.0	679
RFK 1 / 240 FK S35/V0	59.199.0255.0	159	SPERRBOLZ M.FEDRG	05.513.4212.0	786	ST 72.1 /24 REV U WR	Z5.573.5856.0	679
RFK 1 / 240 FM PA/V0	56.399.0255.0	159	SPERRBOLZ M.FEDRG	05.592.0621.0	786	ST 72.1 /24 RV WL	Z5.573.2856.0	679
RFK 1 / 240 FM S35/V0	59.199.1055.0	159	SPERSTUECK	05.592.7756.0	321	ST 72.1 /24 RV WR	Z5.573.3856.0	679
RFK 1 / 240 FMK PA/V0	56.399.1055.0	159	SPERSTUECK	Z5.592.1252.0	788	ST 72.1 /24 RV U WL	Z5.573.6856.0	679
RFK 1 / 240 FMK S35/V0	59.199.1255.0	159	SR - A 4	Z1.000.9153.0	485	ST 72.1 /24 RV U WR	Z5.573.7856.0	679
RFK 1 / 240 FMK PA/V0	56.399.1255.0	159	SR - 15	Z1.000.4753.0	485	ST 72.3 / 6 REV	Z5.571.1656.0	679
RFK 1 / 240 K PA/V0	59.199.0155.0	159	SR 4-20 MA/UE 9,5-40VDC	57.802.3053.0	452	ST 72.3 / 6 REVZ	Z5.571.0656.0	679
RFK 1 / 240 K S35/V0	56.399.0155.0	159	SSM-7E230V	87.010.2053.0	541	ST 72.3 / 6 RV	Z5.571.3656.0	679
RFK 1 / 95 F PA/V0	59.195.0055.0	156	SSM-7E230V-250V5A	87.030.1053.0	541	ST 72.3 / 6 RVZ	Z5.571.2656.0	679
RFK 1 / 95 F S35/V0	56.395.0055.0	156	SSW-V 24/RS422	57.007.0153.0	553	ST 72.3 /10 REVZ	Z5.571.0756.0	679
RFK 1 / 95 FK PA/V0	59.195.0255.0	156	SSW-V 24/RS485	57.007.0253.0	554	ST 72.3 /10 RV	Z5.571.3756.0	679
RFK 1 / 95 FK S35/V0	56.395.0255.0	156	SSW-V 24/TTY	57.007.0053.0	553	ST 72.3 /10 RVZ	Z5.571.2756.0	679
RFK 1 / 95 FM PA/V0	59.195.1055.0	156	ST 2 / 2,3 RKT	Z5.553.2921.0	353	ST 72.3 /16 REV	Z5.571.1556.0	679
RFK 1 / 95 FM S35/V0	56.395.1055.0	156	ST 2 / 2,3 ROT	Z5.553.2921.0	353	ST 72.3 /16 REVZ	Z5.571.0556.0	679
RFK 1 / 95 FMK PA/V0	59.195.1255.0	156	ST 2 / 4 SCHWARZ	Z5.553.3021.0	176	ST 72.3 /16 RV	Z5.571.3556.0	679
RFK 1 / 95 FMK S35/V0	56.395.1255.0	156	ST 70.3 /24 REV	Z5.571.1356.0	675	ST 72.3 /16 REVZ	Z5.571.2556.0	679
RFK 1 / 95 K PA/V0	59.195.0155.0	156	ST 70.1 / 6 REV WL	Z5.573.0156.0	675	ST 72.3 /24 REV	Z5.571.1856.0	679
RFK 1 / 95 K S35/V0	56.395.0155.0	156	ST 70.1 / 6 REV WR	Z5.573.1156.0	675	ST 72.3 /24 REVZ	Z5.571.0856.0	679
RICOS PV-A	83.039.0000.0	416	ST 70.1 / 6 REV U WL	Z5.573.4156.0	675	ST 72.3 /24 RV	Z5.571.3856.0	679
RICOS 16 I	83.035.3000.1	416	ST 70.1 / 6 REV U WR	Z5.573.5156.0	675	ST 72.3 /24 RVZ	Z5.571.2856.0	679
RICOS 16 O	83.035.3200.1	419	ST 70.1 / 6 RV WL	Z5.573.2156.0	675	ST 72.7 / 6 REV	Z5.571.5656.0	681
RICOS 4AI / +10V	83.035.4000.1	424	ST 70.1 / 6 RV WR	Z5.573.3156.0	675	ST 72.7 / 6 REVZ	Z5.571.4656.0	681
RICOS 4AI / 10V	83.035.4001.1	424	ST 70.1 / 6 RV U WL	Z5.573.6156.0	675	ST 72.7 / 6 RV	Z5.571.9656.0	681
RICOS 4AI / 20MA	83.035.4010.1	426	ST 70.1 / 6 RV U WR	Z5.573.7156.0	675	ST 72.7 / 6 REVZ	Z5.571.7656.0	681
RICOS 4AI / PT100	83.035.4040.1	423	ST 70.1 /10 REV WL	Z5.573.0256.0	675	ST 72.7 /10 REV	Z5.571.5756.0	681
RICOS 4AI / TC	83.035.4050.1	423	ST 70.1 /10 REV WR	Z5.573.1256.0	675	ST 72.7 /10 RVZ	Z5.571.4756.0	681
RICOS 4AI4A0 / +10V	83.035.4100.1	425	ST 70.1 /10 REV U WL	Z5.573.4256.0	675	ST 72.7 /10 RV	Z5.571.9756.0	681
RICOS 4AI4A0 / 10V	83.035.4101.1	425	ST 70.1 /10 REV U WR	Z5.573.5256.0	675	ST 72.7 /10 RVZ	Z5.571.7756.0	681
RICOS 4AI4A0 / 20MA	83.035.4110.1	427	ST 70.1 /10 RV WL	Z5.573.2256.0	675	ST 72.7 /16 REV	Z5.571.5556.0	681
RICOS 4AI4A0 / 4-20MA	83.035.4111.1	427	ST 70.1 /10 RV WR	Z5.573.3256.0	675	ST 72.7 /16 REVZ	Z5.571.4556.0	681
RICOS 4I AC 115V	83.035.5000.1	417	ST 70.1 /10 RV U WL	Z5.573.6256.0	675	ST 72.7 /16 RV	Z5.571.9556.0	681
RICOS 4I AC 230V	83.035.5005.1	417	ST 70.1 /10 RV U WR	Z5.573.7256.0	675	ST 72.7 /16 REVZ	Z5.571.7556.0	681
RICOS 40 RELAY	83.035.5200.1	418	ST 70.1 /16 REV WL	Z5.573.0056.0	675	ST 72.7 /24 REV	Z5.571.5856.0	681
RICOS 8 I/O	83.035.3100.1	416	ST 70.1 /16 REV WR	Z5.573.1056.0	675	ST 72.7 /24 REVZ	Z5.571.4856.0	681
RICOS 8I 8/O	83.035.3300.1	419	ST 70.1 /16 REV U WL	Z5.573.4056.0	675	ST 72.7 /24 RV	Z5.571.9856.0	681
RICOS BC-CAN-DN	83.032.0000.1	411	ST 70.1 /16 REV U WR	Z5.573.5056.0	675	ST 72.7 /24 RVZ	Z5.571.7856.0	681
RICOS BC-CANOPEN	83.033.0000.1	411	ST 70.1 /16 RV WL	Z5.573.2056.0	675	ST 73.1 /40 REV WL	Z5.573.8056.0	683
RICOS BC-CP	83.030.0000.1	410	ST 70.1 /16 RV WR	Z5.573.3056.0	675	ST 73.1 /40 REV WR	Z5.573.8356.0	683
RICOS BC-S	83.031.0000.1	410	ST 70.1 /16 RV U WL	Z5.573.6056.0	675	ST 73.1 /40 REV U WL	Z5.573.9356.0	683
RICOS CAN-DN 16 I	83.032.1000.1	429	ST 70.1 /16 RV U WR	Z5.573.7056.0	675	ST 73.1 /40 REV U WR	Z5.573.9156.0	683
RICOS CAN-DN 16 O	83.032.1200.1	429	ST 70.1 /24 REV WL	Z5.573.0356.0	675	ST 73.1 /40 RV WL	Z5.573.8656.0	683
RICOS CAN-DN 8 I/O	83.032.1100.1	429	ST 70.1 /24 REV WR	Z5.573.1356.0	675	ST 73.1 /40 RV WR	Z5.573.8956.0	683
RICOS CAN-DN 8I 8/O	83.032.1300.1	429	ST 70.1 /24 REV U WL	Z5.573.4356.0	675	ST 73.1 /40 RV U WL	Z5.573.9556.0	683
RICOS CANOPEN 16 I	83.033.1000.1	429	ST 70.1 /24 REV U WR	Z5.573.5356.0	675	ST 73.1 /40 RV U WR	Z5.573.9756.0	683
RICOS CANOPEN 16 O	83.033.1200.1	429	ST 70.1 /24 RV WL	Z5.573.2356.0	675	ST 73.1 /64 REV WL	Z5.573.8156.0	683
RICOS CANOPEN 8 I/O	83.033.1100.1							

contents

Type	Part no.	section / page	Type	Part no.	section / page	Type	Part no.	section / page
ST 73.7 /40 RVZ	25.571.8056.0	683	STVB. KOMPLETT	99.708.0000.6	672	VB 1 WK 4..- 2	07.255.4227.0	168
ST 73.7 /64 REV	25.571.7156.0	683	STVB. KOMPLETT	99.709.0000.6	672	VB 1 WK 4..- 3	07.255.4327.0	168
ST 73.7 /64 REVZ	25.571.6156.0	683	STVB. KOMPLETT	99.718.0000.6	672	VB 1 WK 4..- 4	07.255.4427.0	168
ST 73.7 /64 RV	25.571.9156.0	683	STVB. KOMPLETT	99.719.0000.6	672	VB 1 WK 4..- 5	07.255.4527.0	168
ST 73.7 /64 RVZ	25.571.8156.0	683	STVB. KOMPLETT	99.720.0000.6	672	VB 1 WK 4..- 6	07.255.4627.0	168
ST.EIG.ANL.	72.310.0653.9	767	STVB. KOMPLETT	99.721.0000.6	672	VB 1 WK 4..- 7	07.255.4727.0	168
ST.EIG.ANL.	72.310.1053.9	767	STVB. KOMPLETT	99.725.0000.6	672	VB 1 WK 4..- 8	07.255.4827.0	168
ST.EIG.ANL.	72.310.1653.9	767	STVB. KOMPLETT	99.726.0000.6	672	VB 1 WK 4..- 9	07.255.4927.0	168
ST.EIG.ANL.	72.310.2453.9	767	STVB. KOMPLETT	99.727.0000.6	672	VB 1 WK 4..- M-70	07.255.4027.0	168
ST.EIG.ANL.	72.310.4853.9	767	TE / RFK 1 / 95 PA/V0	07.340.0353.0	156	VB 1 WK 4..-10	07.255.5027.0	168
ST.EINSATZ 3/3/6	72.213.1253.0	705	TE/RFK 1/150-240 PA/V0	07.340.1053.0	157	VB 1 WK 4..-11	07.255.5127.0	168
ST.EINSATZ 4/6	72.215.1053.0	699	TMS-101-250V5A	87.110.6253.0	539	VB 1 WK 4..-12	07.255.5227.0	168
ST.EINSATZ 6/6	72.215.1253.0	703	TR-STUECK F.TS35	25.595.2153.0	584	VB 11 / 1 / 12	07.250.1027.0	258
ST.EINSATZ 660V	70.410.0340.0	643	TR-STUECK M. U-F	05.583.0053.0	584	VB 11 / 1 / 2	07.250.0227.0	258
ST.EINSATZ 660V	70.410.0640.0	643	TR-STUECK M. U-F	05.583.0053.0	675	VB 11 / 1 / 6	07.250.0627.0	258
ST.EINSATZ 660V	70.410.1040.0	643	TR-STUECK M. U-F	05.583.0153.0	586	VB 11 / 2	07.250.2527.0	218
ST.EINSATZ 660V	70.410.1640.0	643	TR-STUECK M. U-F	05.584.8853.0	590	VB 9786 2	07.253.0227.0	130
ST.EINSATZ 660V	70.410.2040.0	643	TR-STUECK M. U-F	05.584.8953.0	590	VB 9786 3	07.253.0327.0	130
ST.EINSATZ 660V	70.410.2640.0	643	TRAGBOCK	Z1.990.2030.0	215	VB 9786 6	07.253.0627.0	130
ST.EINSATZ 660V	70.410.3240.0	643	TRAGSCHIEBE 2M	98.310.0000.0	215	VB 9786 4	07.253.0427.0	168
ST.EINSATZ VERGOL	70.311.0640.0	631	TRENNSTUECK	05.592.1953.0	215	VB 9786 M	07.253.0027.0	259
ST.EINSATZ VERGOL	70.311.1040.0	631	TRENNWAND M.BEZ.	07.340.1153.0	152	VB RFK 1 / 95 / 2 / 32	07.205.1227.0	153
ST.EINSATZ VERGOL	70.311.1640.0	631	TRENNWAND M.BEZ.	07.340.1353.0	152	VB RFK 1 / 95 / 3 / 32	07.205.1327.0	153
ST.EINSATZ VERGOL	70.311.2440.0	631	TS 2.5 GELB	07.311.2053.8	312	VB RFK 1 / 95 / 4 / 32	07.205.1427.0	153
ST25/5 B/V0	93.031.2055.0	218	TS 2.5 GELB	07.311.2053.8	101	VB RFK 1 185 2	07.201.4227.0	157
ST25/5 S/V0	93.032.2055.0	218	TS 4 GELB	07.311.2153.8	78	VB RFK 1 185 3	07.201.4327.0	157
ST25/5 SV/V0	93.032.2455.0	218	TS 4 / 15 GELB	07.311.2953.8	112	VB RFK 1 185 4	07.201.4427.0	157
ST28/10 B/V0	93.001.1055.0	219	TS 6 GELB	07.311.2253.8	103	VB RFK 1 240 2	07.201.8227.0	159
ST28/10 BS/V0	93.003.1055.0	219	TS 10 GELB	07.311.2353.8	78	VB RFK 1 240 3	07.201.8327.0	159
ST28/10 S/V0	93.002.1055.0	219	TS 16 GELB	07.311.2453.8	69	VB RFK 1 240 4	07.201.8427.0	159
ST29/10 BC	93.101.2053.0	320	TS M3 S35	69.335.0253.0	219	VB WK 4 - 2	Z7.281.0227.0	87
ST29/10 S/V0	93.102.0055.0	205	TS M4 / M6-32	69.332.0000.0	219	VB WK 4 - 3	Z7.281.0327.0	87
STECKER D-SUB 9	87.200.2205.3	560	TS M4 S35	69.335.0453.0	219	VB WK 4 - 4	Z7.281.0427.0	87
STECKER D-SUB 15	87.200.2206.3	560	TS M5 S35	69.335.0553.0	219	VB WK 4 - 5	Z7.281.0527.0	87
STECKER D-SUB 25	87.200.2207.3	560	TS M6 S35	69.335.0653.0	219	VB WK 4 - 6	Z7.281.0627.0	87
STECKER D-SUB 37	87.200.2208.3	560	TSI 35 GELB	07.311.8653.6	79	VB WK 4 M-70	Z7.281.0027.0	87
STECKER D-SUB 50	87.200.2209.3	560	TSM 2.5 / 15 GELB	07.311.2853.8	144	VB WK 4/D..- 2	Z7.281.6227.0	164
STECKERBUCHSE	05.508.6521.8	191	TSN AD 16 GELB	07.311.8553.8	104	VB WK 4/D..- 3	Z7.281.6327.0	164
STECKERBUCHSE	05.509.6021.0	176	TSN16 GELB	07.311.8453.8	104	VB WK 4/D..- 4	Z7.281.6427.0	164
STECKEREINSATZ	70.210.0653.0	689	TUSCHESTIFT 0.25	95.502.0125.0	49	VB WK 4/D..- 5	Z7.281.6527.0	164
STECKEREINSATZ	70.310.0640.0	631	TUSCHESTIFT 0.35	95.502.0135.0	49	VB WK 4/D..- 6	Z7.281.6627.0	164
STECKEREINSATZ	70.310.1040.0	631	TW 2.5 - 4 /15 BLAU	07.311.1853.6	145	VB WK 4/D..M-70	Z7.281.6027.0	164
STECKEREINSATZ	70.310.1640.0	631	TW 2.5 - 4 /V0	07.311.1155.0	78	VB WK 10 / SI - 2	Z7.287.0227.0	125
STECKEREINSATZ	70.310.2440.0	631	TW 2.5 - 4 BL/V0	07.311.1155.6	78	VB WK 10 / SI - 3	Z7.287.0327.0	125
STECKEREINSATZ	70.310.3253.0	631	TW 4 TK.../V0	07.311.8155.0	122	VB WK 10 / SI - 4	Z7.287.0427.0	165
STECKEREINSATZ	70.310.4840.0	631	TW 6 BL/V0	07.311.1255.6	103	VB WK 10 / SI - 5	Z7.287.0527.0	165
STECKEREINSATZ	70.510.0653.0	631	TW 1 - 2.5	07.312.5153.0	232	VB WK 10 / SI - 6	Z7.287.0627.0	125
STECKEREINSATZ	70.510.1053.0	631	TW 1 - 2.5	07.312.5153.6	232	VB WK 10 / SI M-30	Z7.287.0027.0	165
STECKEREINSATZ	70.510.1653.0	631	TW 2.5-3 D/U /V0	07.312.1255.0	118	VB WK 2.5 - 2	Z7.280.0227.0	120
STECKEREINSATZ	70.510.2453.0	631	TW 2.5-4 K/U /V0	07.312.0555.0	118	VB WK 2.5 - 3	Z7.280.0327.0	120
STECKEREINSATZ	70.510.3253.0	631	TW 2.5-4 KO/V0	07.310.9455.0	120	VB WK 2.5 - 4	Z7.280.0427.0	164
STECKEREINSATZ	70.510.4853.0	631	TW 4 E /V0	07.311.5055.0	114	VB WK 2.5 - 5	Z7.280.0527.0	164
STECKEREINSATZ	70.710.0658.0	631	TW 6 /V0	07.311.1255.0	103	VB WK 2.5 - 6	Z7.280.0627.0	120
STECKEREINSATZ	70.710.1058.0	631	TWC 1 - 2.5 D1	07.312.5353.0	234	VB WK 2.5 M-80	Z7.280.0027.0	164
STECKEREINSATZ	70.710.1658.0	631	TWC 1 - 2.5 D1. BLAU	07.312.5353.6	234	VB WK 4E - 11	07.255.3127.0	168
STECKEREINSATZ	70.710.2458.0	631	TWC 1 - 2.5 D2 / E	07.312.5553.0	231	VB WK 6 - 2	Z7.282.0227.0	165
STECKEREINSATZ	70.710.3253.0	631	TWC 1 - 2.5 D2 / E BLAU	07.312.5553.6	236	VB WK 6 - 3	Z7.282.0327.0	165
STECKEREINSATZ	70.710.4858.0	631	TWF 1.5 E	07.312.3653.0	33	VB WK 6 - 4	Z7.282.0427.0	165
STECKEREINSATZ	72.210.0653.0	693	TWF 2.5 - 4	07.312.2253.0	19	VB WK 6 - 5	Z7.282.0527.0	165
STECKEREINSATZ	72.215.0653.0	707	TWF 2.5 - 4 BLAU	07.312.2253.6	20	VB WK 6 - 6	Z7.282.0627.0	165
STECKEREINSATZ	72.310.0653.0	655	TWF 2.5/D 1/2	07.312.2453.0	26	VB WK 6 M-40	Z7.282.0027.0	165
STECKEREINSATZ	72.310.1053.0	655	TWF 2.5/D 1/2 BLAU	07.312.2453.6	26	VB WK / S/W/UJ - 2	Z7.281.3227.0	140
STECKEREINSATZ	72.310.1653.0	655	TWF 2.5/D 2/2	07.312.2653.0	26	VB WK / S/W/UJ - 3	Z7.281.3327.0	140
STECKEREINSATZ	72.310.2453.0	655	TWF 2.5/D 2/2 BLAU	07.312.2653.6	26	VB WK / S/W/UJ - 4	Z7.281.3427.0	164
STECKEREINSATZ	72.310.3253.0	655	TWF 4 E	07.312.5853.0	30	VB WK / S/W/UJ - 5	Z7.281.3527.0	164
STECKEREINSATZ	72.310.4853.0	655	TWF 4/D1/2	07.312.4953.0	27	VB WK / S/W/UJ - 6	Z7.281.3627.0	140
STECKEREINSATZ	72.710.0658.0	655	TWF 4/D1/2 BLAU	07.312.4953.6	27	VB WK / S/W/UJ-20	Z7.281.3027.0	164
STECKEREINSATZ	72.710.1058.0	655	TWI 4/V0	07.311.6955.0	72	VB WK2.5 KO - 2	07.257.0227.0	120
STECKEREINSATZ	72.710.1658.0	655	TWM 2.5 - 4 /15	07.311.1853.0	145	VB WK2.5 KO - 3	07.257.0327.0	120
STECKEREINSATZ	72.710.2458.0	655	TWN 10 /V0	07.311.7655.0	103	VB WK2.5 KO - 20	07.257.2027.0	120
STECKEREINSATZ	72.710.3258.0	655	TWN 10 BL/V0	07.311.7655.6	103	VB WK4 E - 7	07.255.2727.0	168
STECKEREINSATZ	72.710.4858.0	655	TWN 16 /V0	07.311.7755.0	104	VB WK4 E - 8	07.255.2827.0	168
STECKEREINSATZ	73.310.0353.0	713	TWN 16 BL/V0	07.311.7755.6	104	VB WK4 E - 9	07.255.2927.0	168
STECKEREINSATZ	73.310.0453.0	713	TWN 35 /V0	07.311.7855.0	105	VB WK4 E - 10	07.255.3027.0	168
STECKEREINSATZ	73.710.0753.0	713	TWN 35 BL /V0	07.311.7855.6	105	VB WK4 E - 12	07.255.3227.0	168
STECKEREINSATZ	73.710.0853.0	713	TWN 70 /V0	07.311.7955.0	105	VB WK4 E - 2	07.255.2227.0	168
STECKEREINSATZ	73.710.1553.0	719	TWN 70 BL /V0	07.311.7955.6	105	VB WK4 E - 3	07.255.2327.0	168
STECKEREINSATZ	73.710.2553.0	719	TWN2.5E	07.312.1855.0	116	VB WK4 E - 4	07.255.2427.0	168
STECKEREINSATZ	73.710.4058.0	719	UEBERGABE UNIVERSAL-S5	87.221.6353.0	563	VB WK4 E - 5	07.255.2527.0	168
STECKEREINSATZ	73.710.6458.0	719	UEBERGABE UNIVERSAL-S5	87.222.6353.0	565	VB WK4 E - 6	07.255.2627.0	168
STECKERKONTAKT	05.544.3129.8	739	UET + 10 V	57.802.1053.0	506	VB WK4 E M	07.255.2027.0	168
STECKERKONTAKT	05.544.3229.8	740	UET-P + 10 MA	57.802.1153.0	507	VB WK1 10 - 2	Z7.288.0227.0	87
STECKERKONTAKT	05.544.3329.8	740	UET-P + 20 MA	57.802.1353.0	507	VB WK1 10 - 3	Z7.288.0327.0	87
STECKERKONTAKT	05.544.3429.8	740	UET-P + 199MV	57.802.1453.0	507	VB WK1 10 - 4	Z7.288.0427.0	87
STECKERKONTAKT	05.544.3529.8	740	UET-P/LCD +10 V	57.802.2153.0	507	VB WK1 10 - 5	Z7.288.0527.0	87
STECKERKONTAKT	05.544.3629.8	740	UET-P/LCD +20MA	57.802.2353.0	507	VB WK1 10 - 6	Z7.288.0627.0	87
STECKERKONTAKT	05.544.3729.8	740	UET/LCD + 10 V	57.802.2053.0	506	VB WK1 10 M-40	Z7.288.0027.0	87
STECKERKONTAKT	05.544.3829.8	740	UET/LCD + 20 MA	57.802.2253.0	506	VB WK1 16 - 2	Z7.289.0227.0	87
STECKERKONTAKT	05.544.3929.8	740	UNTERLEGLATTE	07.470.1380.0	259	VB WK1 16 - 3	Z7.289.0327.0	87
STECKERKONTAKT	05.544.4029.8	740	UNTERLEGLATTE	07.471.1380.0	259	VB WK1 16 - 4	Z7.289.0427.0	87
STECKERKONTAKT	05.544.4129.8	740	UNTERLEGLATTE	07.472.1380.0	259	VB WK1 18 - 5	Z7.289.0527.0	87
STECKERKONTAKT	05.544.4229.8	740	UNTERLEGLATTE	07.473.1380.0	259	VB WK1 18 - 6	Z7.289.0627.0	87
STECKERKONTAKT	05.544.4329.8	740	UNTERTEIL	75.013.5051.0	758	VB WK1 18 M-20	Z7.289.0027.0	87
STECKERKONTAKT	05.544.4429.8	740	VB 16 E / M	07.256.8027.0	259	VB WK1 18 M-20	Z7.289.0027.0	87
STECKERKONTAKT	05.544.4529.8	740	VB 16 E / 2 POLIG	07.256.8227.0	259	VB WK1 18 M-20	Z7.289.0027.0	87
STECKERKONTAKT	05.544.4629.8	740	VB 0.5 WK 4..- 2	07.255.0227.0	168	VB WK1 18 M-20	Z7.289.0027.0	87
STECKERKONTAKT	05.544.4729.8	740	VB 0.5 WK 4..- 3	07.255.0327.0	168	VB WK1 18 M-20	Z7.289.0027.0	87
STECKERKONTAKT	05.544.5621.0	761	VB 0.5 WK 4..- 4	07.255.0427.0	168	VB WK1 18 M-20	Z7.289.0027.0	87
STECKERLEISTE	25.533.8221.0	357	VB 0.5 WK 4..- 5	07.255.0527.0	168	VB WK1 18 M-20	Z7.289.0027.0	87
STECKERTEIL	75.012.5053.0	758	VB 0.5 WK 4..- 6	07.255.0627.0	168	VB WK1 18 M-20	Z7.289.0027.0	87
STECKERTEIL	99.701.6905.5	760	VB 0.5 WK 4..- 7	07.255.0727.0				

contents of
type description

contents TYPE

Type	Part no.	section / page	Type	Part no.	section / page	Type	Part no.	section / page
VBS WK4 E - 2	07.256.4227.0	168	WK / 3-6S / U/V0	57.504.6655.0	140	WKC 1 /35 BLAU	56.301.0053.6	231
VBS WK4 E - 3	07.256.4327.0	168	WK / 4-8S / IW / U/V0	57.504.6355.0	141	WKC 1 /D2/2/SL/35	56.301.9153.0	237
VBS WK4 E - 4	07.256.4427.0	168	WK / 4-8S / U/V0	57.504.6255.0	141	WKC 1 D1/2/35	56.301.5053.0	231
VBS WK4 E - 5	07.256.4527.0	168	WK / 5-10S / U/V0	57.504.3655.0	139	WKC 1 D1/2/35 BLAU	56.301.5053.6	234
VBS WK4 E - 6	07.256.4627.0	168	WK 2,5 / U/V0	57.503.0055.0	101	WKC 1 D1/2/SL/35	56.301.9353.0	235
VBS WK4 E - 7	07.256.4727.0	168	WK 2,5 / U BL / V0	57.503.0055.6	102	WKC 1 D2/2/35	56.301.5153.0	231
VBS WK4 E - 8	07.256.4827.0	168	WK 4 / 3-6S KO/U/V0	57.504.7355.0	141	WKC 1 D2/2/35 BLAU	56.301.5153.6	236
VBS WK4 E - 9	07.256.4927.0	168	WK 4 / D 1/2 U/V0 BLAU	57.504.5055.6	112	WKC 1 E/35	56.301.7053.0	231
VBS WK4 E - 10	07.256.5027.0	168	WK 4 / THS15 U/V0	57.904.5355.0	124	WKC 1 SL/35	56.301.9053.0	231
VBS WK4 E - 11	07.256.5127.0	168	WK 4 / U/V0	57.504.0055.0	69	WKC 1 TKG/35	56.301.4053.0	231
VBS WK4 E - 12	07.256.5227.0	168	WK 4 / U BL / V0	57.504.0055.6	69	WKC 1 TKM/35	56.301.2053.0	231
VBWKN 10 - 2	Z7.283.6227.0	165	WK 4 / U F1/V0	57.504.1055.0	142	WKC 1 TKM/35 BLAU	56.301.2053.6	240
VBWKN 10 - 3	Z7.283.6327.0	165	WK 4 / U F2/V0	57.504.1155.0	142	WKC 2,5 /35	56.303.0053.0	231
VBWKN 10 - 4	Z7.283.6427.0	165	WK 4 3-6 S 1K / U / V0	57.504.3755.0	138	WKC 2,5 /35 BLAU	56.303.0053.6	231
VBWKN 10 - 5	Z7.283.6527.0	165	WK 4 3-6 S 1K/IW/U/V0	57.504.2755.0	139	WKC 2,5 D1/2/35	56.303.5053.0	231
VBWKN 10 - 6	Z7.283.6627.0	165	WK 4 5S2,8 1K / U/V0	57.504.3855.0	138	WKC 2,5 D1/2/35 BLAU	56.303.5053.6	234
VBWKN 10 - M-40	Z7.283.6027.0	165	WK 4 5S2,8 1K/IW/U/V0	57.504.2855.0	139	WKC 2,5 D1/2/SL/35	56.303.9353.0	235
VBWKN150 - 2	Z7.287.1227.0	165	WK 4 E / U G-U/R/V0	57.404.8055.9	115	WKC 2,5 D2/2/35	56.303.5153.0	231
VBWKN150 - 3	Z7.287.1327.0	165	WK 4 E / U G-U/R/V0	57.404.8355.5	115	WKC 2,5 D2/2/35 BLAU	56.303.5153.6	236
VERB. SCHIENE	05.561.4125.0	310	WK 4 E / U G2/1/V0	57.404.8855.9	115	WKC 2,5 D2/2/SL/35	56.303.9153.0	231
VERB. SCHIENE	05.561.4125.0	134	WK 4 E / U G2/V0	57.404.7955.5	115	WKC 2,5 E/35	56.303.7053.0	231
VERBINDUNGSKAMM	07.250.3027.0	128	WK 4 E / U GO/V0	57.404.8255.5	115	WKC 2,5 E/35 G-U/R/L	56.303.8353.5	239
VERBINDUNGSKAMM #	07.250.1627.0	256	WK 4 E / U GU/V0	57.404.8155.9	115	WKC 2,5 E/35 G2	56.303.7953.5	239
VERBINDUNGSKAMM #	07.250.3127.0	128	WK 4 E / U LD 42V/V0	57.404.8455.5	115	WKC 2,5 E/35 G0	56.303.8253.5	239
VM WKF KO.18	69.700.1853.0	45	WK 4 SL / U/V0	57.504.9055.0	69	WKC 2,5 E/35 ORANGE	56.303.7553.9	239
VM WKF KO.9	69.700.0953.0	45	WK 4 TKG-TRST / U/V0	57.504.4555.0	123	WKC 2,5 E/35 ROT	56.303.7553.5	239
W.NR.0760796 6E SONDER	99.272.3521.9	258	WK 4 TKG-TRST P3/ U/V0	57.504.4855.0	123	WKC 2,5 E/35/1D/2G ROT	56.303.7153.5	239
WAK16/1	30.494.1010.0	216	WK 4 TKS D / U/V0	57.504.4455.0	123	WKC 2,5 SL/35	56.303.9053.0	231
WAK16/1 BL	30.494.1010.6	216	WK 6 / U/V0	57.506.0055.0	101	WKC 2,5 TKG/35	56.303.4053.0	231
WAK16/1 GN	30.494.1010.7	216	WK 6 / U BL / V0	57.506.0055.6	101	WKC 2,5 TKM/35	56.303.2053.0	231
WAK16/2 BL/V0	30.494.3021.6	24	WK 6 SL / U/V0	57.506.9055.0	101	WKC 2,5 TKM/35 BLAU	56.303.2053.6	240
WAK25/3	30.494.1110.0	216	WK 10/SI U 5 X 20 /V0	57.910.5055.0	101	WKC2,5E/35/1D/2G ORANGE	56.303.7153.9	239
WAK25/3 BL	30.494.1110.6	193	WK 10/SI U 5 X 25 /V0	57.910.5155.0	125	WKF 1,5 E / 35	56.702.7053.0	33
WAK25/3 GN	30.494.1110.7	216	WK 10/SI U 5 X 30 /V0	57.910.5255.0	125	WKF 1,5E/8113/35	07.312.4753.0	37
WAK35/2 BL/V0	30.494.4021.6	107	WK 10/SI U 5X20M.GLB/V0	57.910.5855.0	125	WKF 1,5E/8113/35	07.312.4753.0	37
WAK35/2 BLANK	30.494.4121.0	24	WK 10/SI U 5X20M.NGL/V0	57.910.5455.0	125	WKF 1,5E/8113/35	56.702.2053.0	309
WAK35/3	30.494.2510.0	216	WK 10/SI U 6,3 X 32 /V0	57.910.5355.0	125	WKF 1,5E/8113/35	56.702.2053.0	309
WAK35/3 BL	30.494.2510.6	193	WK 10/SI U D/V0	57.910.4955.0	125	WKF 1,5 KOA 2L/SL	37.702.7653.0	45
WAK35/3 GN	30.494.2510.7	216	WK 10/SIUE,3X32M.GLB/V0	57.910.6155.0	125	WKF 1,5 KOA 2L/SL	37.702.8653.0	45
WAK4/1	30.494.0010.0	216	WK 10/SIUE,3X32M.NGL/V0	57.910.5755.0	125	WKF 1,5 KOE	37.702.7753.0	45
WAK4/1 BL	30.494.0010.6	216	WK 2,5 U /8113 S-VS	05.576.5853.0	311	WKF 1,5 KOE-PGN	37.702.8753.0	45
WAK4/1 GN	30.494.0010.7	216	WK 2,5 U /8113 S-VS	05.576.5853.0	137	WKF 1,5 KOI 3L	37.702.7453.0	44
WAK4/3	30.494.0110.0	216	WK 2,5-3 D SL /V0	56.503.8355.0	119	WKF 1,5 KOI 3L-PGE	37.702.8453.0	44
WAK4/3 BL	30.494.0110.6	216	WK 2,5-3 D SL-NGN /V0	56.503.8455.0	119	WKF 1,5 KOI 3L/SL	37.702.7553.0	44
WAK4/3 GN	30.494.0110.7	216	WK 2,5-3 D SL-PGN /V0	56.503.8555.0	119	WKF 1,5 KOI 3L/SL-PGE	37.702.8553.0	44
WE 1/U	Z5.523.5753.0	101	WK 2,5-3 D/U /V0	57.503.8855.0	118	WKF 10/35	56.710.0053.0	21
WE 1/U	Z5.523.5753.0	584	WK 2,5-3 D/U-NGN /V0	57.503.8955.0	118	WKF 10/35 BLAU	56.710.0053.6	21
WE 2/U	Z5.523.5653.0	105	WK 2,5-3 D/U-PGN /V0	57.503.9055.0	118	WKF 10SL/35	56.710.9053.0	23
WE SH 1/35	Z5.515.3310.0	212	WK 2,5-4 KI SL /V0	56.503.7355.0	119	WKF 16/35	56.716.0053.0	21
WE SH 2/35	Z5.515.3410.0	212	WK 2,5-4 KI SL-NGN /V0	56.503.7455.0	119	WKF 16/35 BLAU	56.716.0053.6	21
WEB1001 LEERG B3	87.030.0053.0	585	WK 2,5-4 KI SL-PGN /V0	56.503.7555.0	119	WKF 16SL/35	56.716.9053.0	23
WEB1001 LEERG B1	86.010.0053.0	584	WK 2,5-4 KI SL-PRT /V0	56.503.7855.0	119	WKF 2,5 / 35 BLAU	56.703.0053.0	19
WEB1001 LEERG B1	87.010.0053.0	584	WK 2,5-4 KI/U /V0	57.503.7855.0	118	WKF 2,5 / 35 BLAU	56.703.0053.6	19
WEB1001 LEERG B2	86.020.0053.0	584	WK 2,5-4 KI/U-NGN /V0	57.503.7955.0	118	WKF 2,5 / D / 35	56.703.5253.0	27
WEB1001 LEERG B2	87.020.0053.0	584	WK 2,5-4 KOI /U /V0	57.503.7055.0	120	WKF 2,5 / D 1/2 / SL/25	56.703.9353.0	28
WEB1001 LEERG B3	86.030.0053.0	585	WK 2,5-4 KOI /U-NGN /V0	57.503.7155.0	120	WKF 2,5 / D 2/2 / SL/35	56.703.9153.0	19
WEB1001 LEERG B4	86.040.0053.0	585	WK 2,5-4 KOI /U-PGN /V0	57.503.7255.0	121	WKF 2,5 / D2/SL/35/8113	56.703.9253.0	36
WEB1001 LEERG B4	87.040.0053.0	585	WK 2,5U/8113S/H/V0	57.503.2055.0	137	WKF 2,5 / D2/SL/35/8113	56.703.9253.6	308
WEB1001 LEERG B6	87.060.0053.0	586	WK 2,5U/8113S/H/V0	57.503.2055.0	311	WKF 2,5 SL / 35	56.703.9053.0	19
WEB1001 LEERG B7	87.070.0053.0	586	WK 4 E/U LD -P 0 24/V0	57.404.7255.5	115	WKF 2,5 D1/2/35	56.703.5053.0	19
WEB1001 LEERG B8	87.080.0053.0	587	WK 4 E/U LD -P 0 24/V0	57.404.7455.9	115	WKF 2,5 D1/2/35 BLAU	56.703.5053.6	19
WEB1001 LEERG B9	87.090.0053.0	587	WK 4 E/U LDG +P 0 24/V0	57.404.8755.5	115	WKF 2,5 D2/ 35/8113	56.703.2053.0	308
WEF 1 BS/35	69.920.1053.0	47	WK 4 E/U LED-PO 24LD/V0	57.404.6255.9	115	WKF 2,5 D2/ 35/8113 BL	56.703.2053.6	308
WEF 1/35	Z5.523.9353.0	20	WK 4 S/D-5 X 20/V0	57.504.1755.0	126	WKF 2,5 D2/ 35/8113 BL	56.703.2053.6	308
WEF 1/35	Z5.523.9353.0	308	WK 4 S/D-5 X 25/V0	57.504.1655.0	126	WKF 2,5 D2/ 35/8113 BL	56.703.2053.6	308
WEG LEERG. F. 4A	57.801.0053.0	592	WK 4 TKG/U /V0	57.504.4055.0	101	WKF 2,5 D2/2/35	56.703.5153.0	19
WEG LEERG. F. 4A	57.801.5053.0	592	WK 4 TKM P3/U /V0	57.504.2355.0	101	WKF 2,5 D2/2/35 BLAU	56.703.5153.6	19
WEG LEERG. F. 6A	57.801.5153.0	593	WK 4 TKM/U /V0	57.504.2055.0	101	WKF 4 E/35	56.704.7053.0	30
WEG LEERG. F. 8A	57.801.5253.0	593	WK 4 TKM/U BL /V0	57.504.2055.6	103	WKF 4 / 35	56.704.0053.0	19
WIEBOX CN 19 DK	07.416.5353.0	594	WK 4 D E /U/V0	57.504.5255.0	113	WKF 4 / 35 BLAU	56.704.0053.6	30
WIEBOX CN 19 DU	07.416.5453.0	594	WK 4 D1/2U/V0	57.504.5055.0	112	WKF 4 E/SL/35	56.704.9253.0	31
WIEBOX CN 19 EP	07.416.4553.0	594	WK 4 D2/2SLU /V0	57.504.9155.0	113	WKF 4 NT / 35	56.704.8153.0	24
WIEBOX CN 19 FK	07.416.4853.0	594	WK 4 D2/2U BL/V0	57.504.5155.6	112	WKF 4 SL / 35/V0	56.704.9053.0	19
WIEBOX CN 19 FKG	07.416.4856.0	594	WK 4 D2/2U/V0	57.504.5155.0	112	WKF 4 TKG / 35	56.704.4053.0	38
WIEBOX CN 19 GK	Z1.296.3553.0	594	WK 4 THS15 /GL 250U /V0	57.904.5755.0	124	WKF 4 TKM / 35	56.704.2053.0	39
WIEBOX CN 19 GLK	Z1.296.3453.0	594	WK 4 THS15 5 GL 500U /V0	57.904.5855.0	124	WKF 4 D1/2/35	56.704.5053.0	27
WIEBOX CN 22 DK	07.416.5653.0	594	WK 4 THS15 5 LED 12U /V0	57.904.5455.0	124	WKF 4 D1/2/35 BLAU	56.704.9053.6	27
WIEBOX CN 22 DU	07.416.5753.0	594	WK 4 THS15 5 LED 24U /V0	57.904.5555.0	124	WKF 4 D1/2/SL/35	56.704.9353.0	29
WIEBOX CN 22 EP	07.416.4653.0	594	WK 4 THS15 5 LED 60U /V0	57.904.5655.0	124	WKF 6/35	56.706.0053.0	21
WIEBOX CN 22 FK	07.416.4953.0	594	WK 4 THS16,3 GL 250U/V0	57.904.6755.0	124	WKF 6/35 BLAU	56.706.0053.6	23
WIEBOX CN 22 FKG	07.416.4956.0	594	WK 4 THS16,3 GL 500U/V0	57.904.6855.0	124	WKF 6SL/35	56.706.9053.0	21
WIEBOX CN 22 GK	Z1.296.3953.0	594	WK 4 THS16,3 LED 12U/V0	57.904.6455.0	124	WKI 10 / U BLAU/V0	57.510.1155.6	78
WIEBOX CN 22 GLK	Z1.296.3853.0	594	WK 4 THS16,3 LED 24U/V0	57.904.6555.0	124	WKI 10 / U/V0	57.510.1155.0	78
WIEBOX CN 26 DK	07.416.5853.0	595	WK 4 THS16,3 LED 60U/V0	57.904.6655.0	124	WKI 10 ETK/U/V0	57.510.8255.0	80
WIEBOX CN 26 DU	07.416.5953.0	595	WK 4 THS16,3 U /V0	57.904.6355.0	124	WKI 10 PEN/35/V0	56.510.9455.0	84
WIEBOX CN 26 EP	07.416.4753.0	595	WK 4E SL/U /V0	57.504.9255.0	115	WKI 10 SL / 35/V0	56.510.9255.0	82
WIEBOX CN 26 FKG	07.416.5053.0	595	WK 4E/U SW/V0	57.404.7055.0	114	WKI 16 / U BLAU/V0	57.516.1155.6	69
WIEBOX CN 26 GK	07.416.5056.0	595	WK 4E/UVB SW/V0	57.404.6955.1	114	WKI 16 / U/V0	57.516.1155.0	69
WIEBOX CN 26 GLK	Z1.296.4353.0	595	WK2,5-4 KI/U-PGN /V0	57.503.8055.0	118	WKI 16 ETK/U/V0	57.516.8255.0	69
WIEBOX CN BL1	05.561.9553.0	594	WK2,5U /8113S/V... /V0	57.503.2655.0	136	WKI 16 PEN/35/V0	56.516.9455.0	84
WIEBOX CN BL2	05.561.9653.0	594	WK2,5U/8113S/LED25/V0	57.503.2755.0	310	WKI 16 SL / 35/V0	56.516.9255.0	69
WIEBOX CN BL3	05.561.9653.0	594	WK2,5U/8113S/LED25/V0	57.503.2755.0	136	WKI 35 / U BLAU/V0	57.535.1155.6	79
WIEBOX CN BZ	04.244.1853.0	502	WK2,5U/8113S/LED50/V0	57.503.2855.0	137	WKI 35 SL / V0	57.535.1155.0	79
WIEBOX CN DK	07.416.5153.0	594	WK2,5U/8113S/V/LED50/V0	57.503.2855.0				

contents

Type	Part no.	section / page	Type	Part no.	section / page	Type	Part no.	section / page
WKIF 16/35 GRAU	56.716.1153.0	25						
WKIF 2,5 D	56.703.9653.0	58						
WKIF 2,5 D-D	56.703.9753.0	55						
WKIF 2,5 D-D-SL	56.703.9853.0	55						
WKIF 2,5 N-D-SL	56.703.9453.0	55						
WKIF 2,5 NT-D-SL	56.703.9553.0	55						
WKIF/SH/35	01.108.7653.0	55						
WKM 2,5 / 15 BLAU/V0	55.503.1053.6	145						
WKM 2,5 / 15/V0	55.503.1053.0	145						
WKM 2,5 F1 / 15/V0	55.503.1253.0	144						
WKM 2,5 F2 / 15/V0	55.503.1353.0	144						
WKM 4 / 15/V0	55.504.1053.0	145						
WKM 4 SL / 15/V0	55.504.9153.0	145						
WKM 4 / 15 BLAU/V0	55.504.1053.6	145						
WKN 4ETK/U/V0	57.504.8155.0	69						
WKN 10/U /V0	57.510.0155.0	101						
WKN 10ETK/U/V0	57.510.8155.0	106						
WKN 16ETK/U/V0	57.516.8155.0	107						
WKN 70 SL/U	57.570.9055.0	110						
WKN10 / U BL / V0	57.510.0155.6	101						
WKN10 SL/U /V0	57.510.9055.0	101						
WKN150 / U /V0	57.597.0155.0	105						
WKN150/ U BL / V0	57.597.0155.6	105						
WKN16 / U /V0	57.516.0155.0	104						
WKN16 / U BL / V0	57.516.0155.6	104						
WKN16 SL/U /V0	57.516.9055.0	109						
WKN2.5E / U V0	57.403.7055.0	116						
WKN2.5E / U VB SW/V0	57.403.6955.1	116						
WKN35 / U /V0	57.535.0155.0	101						
WKN35 / U BL / V0	57.535.0155.6	101						
WKN35 SL/U / V0	57.535.9055.0	101						
WKN70 / U /V0	57.570.0155.0	105						
WKN70 / U BL / V0	57.570.0155.6	105						
WPS-115/230-24V1A	81.000.3010.0	524						
WPS-T115/230-60VA	87.230.1553.0	525						
WR1-230-1W-250V4A	80.010.0011.0	456						
WR1-DUO-2W-250V5A	80.010.1100.0	458						
WR4-115-1W-250V4A	80.010.1102.0	456						
WR4-115-2W-250V4A	80.010.1104.0	458						
WR4-230-1W-250V4A	80.010.1106.0	457						
WR4-230-2W-250V4A	80.010.1108.0	459						
WR8-115-1W-250V4A	80.010.1110.0	456						
WR8-115-2W-250V4A	80.010.1112.0	458						
WR8-230-1W-250V4A	80.010.1114.0	457						
WR8-230-2W-250V4A	80.010.1116.0	459						
WRS-REL-1S-250V5A	80.010.0005.0	460						
WRS-REL-1S-48V20M	80.010.0007.0	460						
WRS-REL-1W-250V16	80.010.0010.0	461						
WRS-REL-1W-250V5A	80.010.0008.0	460						
WRS-REL-1W-48V20M	80.010.0009.0	460						
WRS-REL-2W-250V5A	80.010.1003.0	461						
WRS-REL-2W-48V20M	80.010.1002.0	461						
WRS-SSAC1-250V4A	80.020.2001.0	481						
WRS-SSAC1-250V6A	80.020.0004.0	481						
WRS-SSDC-60V3A	80.020.2003.0	480						
WRS-SSDC-60V5A	80.020.2004.0	480						
WRS-T115/230-300M	81.000.3000.0	524						
WRS-TIMER-250V5A	81.020.3000.0	463						
X L= 1000 MIT SCHIRM	08.000.0106.0	569						
X L= 1000 OHNE SCHIRM	08.000.0107.4	569						
X L= 1500 MIT SCHIRM	08.000.0106.1	569						
X L= 1500 OHNE SCHIRM	08.000.0107.5	569						
X L= 2000 MIT SCHIRM	08.000.0106.2	569						
X L= 2000 OHNE SCHIRM	08.000.0107.6	569						
X L= 2500 MIT SCHIRM	08.000.0106.3	569						
X L= 2500 OHNE SCHIRM	08.000.0107.7	569						
X L= 3000 MIT SCHIRM	08.000.0106.4	569						
X L= 3000 OHNE SCHIRM	08.000.0107.8	569						
X L= 3500 MIT SCHIRM	08.000.0106.5	569						
X L= 4000 MIT SCHIRM	08.000.0106.6	569						
X L= 4000 OHNE SCHIRM	08.000.0108.0	569						
X L= 4500 MIT SCHIRM	08.000.0106.7	569						
X L= 4500 OHNE SCHIRM	08.000.0108.1	569						
X L= 5000 MIT SCHIRM	08.000.0106.8	569						
X L= 5000 OHNE SCHIRM	08.000.0108.2	569						
X L= 6000 MIT SCHIRM	08.000.0106.9	569						
X L= 6000 OHNE SCHIRM	08.000.0108.3	569						
X L= 7000 MIT SCHIRM	08.000.0107.0	569						
X L= 7000 OHNE SCHIRM	08.000.0108.4	569						
X L= 8000 MIT SCHIRM	08.000.0107.1	569						
X L= 8000 OHNE SCHIRM	08.000.0108.5	569						
X L= 9000 MIT SCHIRM	08.000.0107.2	569						
X L= 9000 OHNE SCHIRM	08.000.0108.6	569						
X L=10000 MIT SCHIRM	08.000.0107.3	569						
X L=10000 OHNE SCHIRM	08.000.0108.7	569						
Y BANDBREITE BIS 8M	08.000.0108.9	569						
ZP 2,5 U/8113 S/V/V0	07.312.1655.0	136						
ZP 2,5 U/8113 S/V/V0	07.312.1655.0	310						
ZP 2,5 U/8113 S/V BL/V0	07.312.1655.6	311						
ZP 2,5 U/8113 S/V BL/V0	07.312.1655.6	137						
ZP 2,5 U/D/8113 S/V/V0	07.311.9155.0	312						
ZP 2,5 U/D/8113 S/V/V0	07.311.9155.0	134						
ZP2.5U/D/8113 S/V BL/V0	07.311.9155.6	313						
ZWISCHENPLATTE	07.300.2753.0	374						

contents of
part number

contents PART NUMBER

Part no.	Type	section / page	Part no.	Type	section / page	Part no.	Type	section / page
01.001.5053.0	ISOLIERGEHAEUSE	584	04.007.4089.0	BZ 8190 / 1 - 12	306	04.242.6753.0	9705A/6,7/ 12	790
01.001.5153.0	ISOLIERGEHAEUSE	584	04.007.4189.0	BZ 8190 / 13 - 24	306	04.242.7553.0	9705 A / 7,5 / 10	351
01.001.5353.0	ISOLIERGEHAEUSE	586	04.007.4289.0	BZ 8190 / 25 - 36	306	04.242.8053.0	9705 A / 8 / 10	201
01.001.5453.0	ISOLIERGEHAEUSE	586	04.007.4389.0	BZ 8190 / 37 - 48	306	04.244.1853.0	WIEBOX CN BZ	502
01.001.5593.0		588	04.007.4489.0	BZ 8190 / 49 - 60	306	04.249.1053.0	BEZ.PLATTE	499
01.001.5653.0	ISOLIERGEHAEUSE	588	04.007.4589.0	BZ 8190 / 61 - 72	306	04.249.1553.0	BEZ.PLATTE	499
01.001.5753.0	ISOLIERGEHAEUSE	588	04.007.4689.0	BZ 8190 / 73 - 84	306	04.249.2053.0	BEZ.PLATTE	499
01.001.5853.0	ISOLIERGEHAEUSE	588	04.007.4789.0	BZ 8190 / 85 - 96	306	04.249.4053.0	BEZ.PLATTE	499
01.001.5993.0		588	04.007.4889.0	BZ 8190 / 97 - 108	306	04.312.0554.0	ABDECKUNG	584
01.001.6293.0		591	04.019.0289.0	BEZ.BLATT PERF.	47	04.312.0654.0	ABDECKUNG	584
01.001.6493.0		590	04.019.0889.0	BEZ.BLATT PERF.	183	04.312.2056.0	ABDECKUNG	125
01.001.6553.0	ISOLIERGEHAEUSE	590	04.030.0080.0	8006 / 2 BZ	260	04.312.3054.0	ABDECKUNG	585
01.001.6653.0	ISOLIERGEHAEUSE	590	04.030.0180.0	8006 / 3 BZ	260	04.312.3154.0		586
01.001.6753.0	ISOLIERGEHAEUSE	590	04.030.0280.0	8006 / 4 BZ	260	04.312.3254.0	ABDECKUNG	587
01.060.0253.0	8113 BK / 2	291	04.030.0380.0	8006 / 5 BZ	260	04.312.3354.0	ABDECKUNG	585
01.060.0353.0	8113 BK / 3	291	04.030.0480.0	8006 / 6 BZ	260	04.312.3454.0	ABDECKUNG	586
01.060.0453.0	8113 BK / 4	291	04.030.1080.0	8006 / 12 BZ	260	04.312.3554.0	ABDECKUNG	587
01.060.0553.0	8113 BK / 5	291	04.030.1180.0	8006 M BZ	260	04.325.1056.0	ABDECKG.M.WARNZCH	189
01.060.0653.0	8113 BK / 6	291	04.033.0080.0		260	04.325.1156.0	ABDECKG.M.WARNZCH	189
01.060.0753.0	8113 BK / 7	291	04.033.0180.0	8130 / 3 BZ	260	04.325.1256.0	ABDECKG.M.WARNZCH	189
01.060.0853.0	8113 BK / 8	291	04.033.0280.0	8130 / 4 BZ	260	04.325.1356.0	ABDECKG.M.WARNZCH	191
01.060.0953.0	8113 BK / 9	291	04.033.0380.0	8130 / 5 BZ	260	04.325.1456.0	ABDECKG.M.WARNZCH	189
01.060.1053.0	8113 BK / 10	291	04.033.0480.0	8130 / 6 BZ	260	04.325.1556.0	ABDECKG.M.WARNZCH	189
01.060.1153.0	8113 BK / 11	291	04.033.1080.0	8130 / 12 BZ	260	04.325.8553.8	FUER WKI 10/U	69
01.060.1253.0	8113 BK / 12	291	04.033.1180.0	8130 M BZ	260	04.325.8653.8	FUER WKI 16/U	79
01.060.1353.0	8113 BK / 13	291	04.070.0280.0	10E / 2 BZ	260	04.325.8753.0		86
01.060.1453.0	8113 BK / 14	291	04.070.0380.0	10E / 3 BZ	260	04.325.8753.8		79
01.060.1553.0	8113 BK / 15	291	04.070.0480.0	10E / 4 BZ	260	04.326.0056.0	ABDECKUNG	152
01.060.1653.0	8113 BK / 16	291	04.070.0580.0	10E / 5 BZ	260	04.326.1053.0	ABDECKUNG	128
01.060.3253.0	8113 BK / 2 OB	291	04.070.0680.0	10E / 6 BZ	260	04.326.2053.0		310
01.060.3353.0	8113 BK / 3 OB	291	04.070.1280.0	10E / 12 BZ	260	04.326.2053.8	AD VB 2,5 GELB	101
01.060.3453.0	8113 BK / 4 OB	291	04.070.1380.0	10E / M BZ	260	04.326.2053.8	AD VB 2,5 GELB	312
01.060.3553.0	8113 BK / 5 OB	291	04.071.0280.0		260	04.326.2153.8	AD VB 4 GELB	78
01.060.3653.0	8113 BK / 6 OB	291	04.071.0380.0		260	04.326.2253.8	AD VB 6 GELB	103
01.060.3753.0	8113 BK / 7 OB	291	04.071.0480.0		260	04.326.2353.8	AD VB 10 GELB	82
01.060.3853.0	8113 BK / 8 OB	291	04.071.0580.0		260	04.326.2453.8	AD VB 16 GELB	69
01.060.3953.0	8113 BK / 9 OB	291	04.071.0680.0		260	04.326.2553.8	AD VB 35 GELB	105
01.060.4053.0	8113 BK / 10 OB	291	04.071.1280.0	10E / 12 DBZ	260	04.326.2653.8	AD VB 70 GELB	105
01.060.4153.0	8113 BK / 11 OB	291	04.071.1380.0		260	04.326.2953.8	AD VB 4 / 15 GELB	114
01.060.4253.0	8113 BK / 12 OB	291	04.080.0080.0	8016 / 2 BZ	260	04.326.3053.8	AD VB WKM 2,5 / 15 GELB	144
01.060.4353.0	8113 BK / 13 OB	291	04.080.0180.0	8016 / 3 BZ	260	04.342.0556.0	AD VB 5 / 10	120
01.060.4453.0	8113 BK / 14 OB	291	04.080.0280.0	8016 / 4 BZ	260	04.342.0556.8	AD VB 5 / 10 GELB	116
01.060.4553.0	8113 BK / 15 OB	291	04.080.0380.0	8016 / 5 BZ	260	04.342.0653.8		140
01.060.4653.0	8113 BK / 16 OB	291	04.080.0480.0	8016 / 6 BZ	260	04.342.0656.8	AD VB 6/10 GELB	112
01.108.3255.0	WKI SH/U /V0	69	04.080.1080.0	8016 / 12 BZ	260	04.342.1056.8	AD VB 10/10 GELB	78
01.108.7653.0	WKIF/SH/25	55	04.080.1180.0	8016 M BZ	260	04.342.2656.8	AD VB 6 / 10 E GELB	114
01.112.1453.0	9701 A SH S35	193	04.090.0280.0	16E / 2 BZ	260	04.342.3556.8	AD VB 5 / 10 P GELB	102
01.299.9753.0		177	04.090.0380.0	16E / 3 BZ	260	04.342.3556.8	AD VB 5 / 10 P GELB	312
02.123.7001.0		631	04.090.0480.0	16E / 4 BZ	260	04.342.3656.8	AD VB 6/10 P GELB	103
02.123.7021.0	FUER 0,5 MM2	631	04.090.0580.0	16E / 5 BZ	260	04.342.3856.8	AD VB 8/10 P GELB	103
02.123.7101.0		631	04.090.0680.0	16E / 6 BZ	260	04.342.4056.8	AD VB 10/10 P GELB	103
02.123.7121.0	FUER 0,75-1 MM2	631	04.090.1280.0	16E / 12 BZ	260	04.342.5656.8	AD VB 6 / 10 E P GELB	174
02.123.7201.0	FUER 1,5 MM2 VERGOLD	631	04.090.1380.0	16E / M BZ	260	04.343.4756.8	ABDECKG.M.WARNZCH	102
02.123.7221.0	FUER 1,5 MM2	631	04.210.0652.0	BEZ.KLAPPSCHILD	183	04.343.4856.8	ABDECKG.M.WARNZCH	69
02.123.7301.0		631	04.210.0752.0	BEZ.KLAPPSCHILD	183	04.343.4956.8	ABDECKG.M.WARNZCH	103
02.123.7321.0	FUER 2,5 MM2	631	04.232.0051.0	BZ 12	218	04.343.5056.8	ABDECKG.M.WARNZCH	103
02.123.7401.0		631	04.240.0953.0	BEZ.-SCHILD	392	04.343.5156.8	ABDECKG.M.WARNZCH	104
02.123.7421.0	FUER 4 MM2	631	04.241.0651.0	9003 C	584	04.343.5256.8	ABDECKG.M.WARNZCH	105
02.124.0900.0	0,2-0,56 QMM	683	04.241.1150.0	9704 A	181	04.343.5356.8	ABDECKG M WARNZCH	105
02.124.0929.0	0,2-0,56 QMM	683	04.241.1150.0	9704 A	598	04.343.5456.8	ABDECKG M WARNZCH	105
02.124.1000.0	0,5-01,5 QMM	683	04.241.1150.0	9704 A	791	04.343.5856.8		86
02.124.1029.0	0,5-1,5 QMM	683	04.242.0651.0		592	04.343.5856.8		82
02.124.1400.0	0,5-1,5 QMM VERGOLDET	683	04.242.0800.0		349	04.343.6053.8	ADF 2,5/4 GELB	20
02.124.1429.0	0,5-1,5 QMM VERGOLDET	683	04.242.0850.0	9705 A	90	04.343.6053.8	ADF 2,5/4 GELB	308
02.124.4000.0		207	04.242.0850.0	9705 A	321	04.343.6153.8	ADF 4/4 GELB	19
02.124.4029.0	FEDERKONTAKT	207	04.242.0850.0	9705 A	588	04.343.6253.8	ADF 6/4 GELB	21
02.124.4100.0	FEDERKONTAKT	207	04.242.0850.0	9705 A	790	04.343.6453.8	ADF10/4 GELB	21
02.124.4129.0		207	04.242.1050.0	9003 C / 4	394	04.343.6653.8	ADF16/4 GELB	21
02.125.1121.0	BUCHSENKONTAKT	761	04.242.1050.0	9003 C / 4	584	04.343.6853.8	ABDECKUNG	36
02.125.1600.0	FEDERKONTAKT BAND	291	04.242.1553.0	9705 AL	90	04.343.6853.8	ABDECKUNG	308
02.125.1629.0	FEDERKONTAKT	291	04.242.1553.0	9705 AL	394	04.343.8053.0	AD VM-1,5/8 SCHWARZ	45
02.125.1700.0	FEDERKONTAKT BAND	291	04.242.1553.0	9705 AL	410	04.343.8353.8	ABDECKUNG	33
02.125.1729.0	FEDERKONTAKT	291	04.242.1553.0	9705 AL	790	04.343.9056.0		310
02.125.3129.8	BUCHSENKONTAKT	739	04.242.2853.0	9705 A / 4 W	790	04.343.9056.8	ABDECKSTREIFEN	134
02.125.3229.8	BUCHSENKONTAKT	740	04.242.3053.0	9705 A / 6,7/6-90GRAD	790	04.343.9056.8	ABDECKSTREIFEN	312
02.125.3329.8	BUCHSENKONTAKT	740	04.242.3253.0		204	04.343.9156.0		310
02.125.3429.8	BUCHSENKONTAKT	740	04.242.3353.0	9705 A / 6,7/9-90GRAD 3	790	04.343.9156.8	ABDECKG.M.WARNZCH	134
02.125.3529.8	BUCHSENKONTAKT	740	04.242.3453.0	9705 A / 6,7/6-90GRAD 5	790	04.343.9156.8	ABDECKG.M.WARNZCH	312
02.125.3629.8	BUCHSENKONTAKT	740	04.242.3553.0	9705 A / 6,7/6-90GRAD 8	790	04.344.0153.8	.ADC 1 GELB	232
02.125.3729.8	BUCHSENKONTAKT	740	04.242.3653.0	9705 A / 6,7/6-90GRAD 12	790	04.344.0353.8	ADC 2,5 GELB	231
02.125.3829.8	BUCHSENKONTAKT	740	04.242.3853.0	BEZ.SCHILDTRAEGER	781	04.832.0051.0	BZ 12 B	218
02.125.3929.8	BUCHSENKONTAKT	740	04.242.4253.0	BEZ.SCHILDTRAEGER	349	04.841.0651.0	9003 C B	584
02.125.4029.8	BUCHSENKONTAKT	740	04.242.4453.0	BEZ.SCHILDTRAEGER	781	04.841.1150.0	9704 A / 1 B	181
02.125.4129.8	BUCHSENKONTAKT	740	04.242.4653.0	BEZ.SCHILDTRAEGER	357	04.841.1150.0	9704 A / 1 B	395
02.125.4229.8	BUCHSENKONTAKT	740	04.242.5053.0	9705 A / 5 / 10	91	04.841.1150.0	9704 A / 1 B	598
02.125.4329.8	BUCHSENKONTAKT	740	04.242.5053.0	9705 A / 5 / 10	349	04.841.1150.0	9704 A / 1 B	791
02.125.4429.8	BUCHSENKONTAKT	740	04.242.5053.0	9705 A / 5 / 10	596	04.841.1250.0	9704 A / 2 B	181
02.125.4529.8	BUCHSENKONTAKT	740	04.242.5053.0	9705 A / 5 / 10	790	04.841.1250.0	9704 A / 2 B	395
02.125.4629.7	BUCHSENKONTAKT	740	04.242.5153.0	9705 A L / 5 / 10	91	04.841.1250.0	9704 A / 2 B	598
02.125.4729.7	BUCHSENKONTAKT	740	04.242.5153.0	9705 A L / 5 / 10	394	04.841.1250.0	9704 A / 2 B	791
02.220.0121.0	FKK18 / 1	217	04.242.5153.0	9705 A L / 5 / 10	596	04.841.1350.0	9704 A / 3 B	181
02.220.0321.0	FKK18 / 2	217	04.242.5153.0	9705 A L / 5 / 10	790	04.841.1350.0	9704 A / 3 B	395
02.220.0421.0	FKK18 / 3	217	04.242.5853.0	BEZ.SCHILDTRAEGER	349	04.841.1350.		

contents

Part no.	Type	section / page	Part no.	Type	section / page	Part no.	Type	section / page
04.841.1450.0	9704 A / 4 B	395	04.841.4350.0	9704 A /VG B	598	04.841.7550.0	9704 A /- B	599
04.841.1450.0	9704 A / 4 B	598	04.841.4350.0	9704 A /VG B	791	04.841.7550.0	9704 A /- B	791
04.841.1450.0	9704 A / 4 B	791	04.841.4450.0	9704 A /WG B	395	04.841.7650.0	9704 A // B	181
04.841.1550.0	9704 A / 5 B	181	04.841.4450.0	9704 A /WG B	598	04.841.7650.0	9704 A // B	395
04.841.1550.0	9704 A / 5 B	395	04.841.4450.0	9704 A /WG B	791	04.841.7650.0	9704 A // B	599
04.841.1550.0	9704 A / 5 B	598	04.841.4550.0	9704 A /XG B	395	04.841.7650.0	9704 A // B	791
04.841.1550.0	9704 A / 5 B	791	04.841.4550.0	9704 A /XG B	598	04.841.7750.0	9704 A / B	181
04.841.1650.0	9704 A / 6 B	181	04.841.4550.0	9704 A /XG B	791	04.841.7750.0	9704 A / B	395
04.841.1650.0	9704 A / 6 B	395	04.841.4650.0	9704 A /YG B	395	04.841.7750.0	9704 A / B	599
04.841.1650.0	9704 A / 6 B	598	04.841.4650.0	9704 A /YG B	598	04.841.7750.0	9704 A / B	791
04.841.1650.0	9704 A / 6 B	791	04.841.4650.0	9704 A /YG B	791	04.841.9050.0	111.BIS 000..	181
04.841.1750.0	9704 A / 7 B	181	04.841.4750.0	9704 A /ZG B	395	04.841.9050.0	111.BIS 000..	395
04.841.1750.0	9704 A / 7 B	395	04.841.4750.0	9704 A /ZG B	598	04.841.9050.0	111.BIS 000..	791
04.841.1750.0	9704 A / 7 B	598	04.841.4750.0	9704 A /ZG B	791	04.841.9150.0	A BIS Z GB	181
04.841.1750.0	9704 A / 7 B	791	04.841.4850.0	9704 A /AK B	395	04.841.9150.0	A BIS Z GB	395
04.841.1850.0	9704 A / 8 B	181	04.841.4850.0	9704 A /AK B	599	04.841.9150.0	A BIS Z GB	791
04.841.1850.0	9704 A / 8 B	395	04.841.4850.0	9704 A /AK B	791	04.841.9250.0	A BIS Z KB	181
04.841.1850.0	9704 A / 8 B	598	04.841.4950.0	9704 A /BK B	395	04.841.9250.0	A BIS Z KB	395
04.841.1850.0	9704 A / 8 B	791	04.841.4950.0	9704 A /BK B	599	04.841.9250.0	A BIS Z KB	791
04.841.1950.0	9704 A / 9 B	181	04.841.4950.0	9704 A /BK B	791	04.842.0153.0		101
04.841.1950.0	9704 A / 9 B	395	04.841.5050.0	9704 A /CK B	395	04.842.0651.0		592
04.841.1950.0	9704 A / 9 B	598	04.841.5050.0	9704 A /CK B	599	04.842.0850.0	9705 A B	90
04.841.1950.0	9704 A / 9 B	791	04.841.5050.0	9704 A /FK B	791	04.842.0850.0	9705 A B	321
04.841.2050.0	9704 A / 0 B	181	04.841.5150.0	9704 A /DK B	395	04.842.0850.0	9705 A B	588
04.841.2050.0	9704 A / 0 B	395	04.841.5150.0	9704 A /DK B	599	04.842.0850.0	9705 A B	790
04.841.2050.0	9704 A / 0 B	598	04.841.5150.0	9704 A /DK B	791	04.842.1553.0	9705 AL B	90
04.841.2050.0	9704 A / 0 B	791	04.841.5250.0	9704 A /EK B	395	04.842.1553.0	9705 AL B	394
04.841.2150.0	9704 A / 1-0 B	181	04.841.5250.0	9704 A /EK B	599	04.842.1553.0	9705 AL B	596
04.841.2150.0	9704 A / 1-0 B	349	04.841.5250.0	9704 A /EK B	791	04.842.1553.0	9705 AL B	790
04.841.2150.0	9704 A / 1-0 B	598	04.841.5350.0	9704 A /FK B	395	04.842.4953.0	9705A/5/ 9 B 1- 9	91
04.841.2150.0	9704 A / 1-0 B	791	04.841.5350.0	9704 A /FK B	599	04.842.4953.0	9705A/5/ 9 B 1- 9	394
04.841.2250.0	9704 A /AG B	395	04.841.5350.0	9704 A /FK B	791	04.842.4953.0	9705A/5/ 9 B 1- 9	596
04.841.2250.0	9704 A /AG B	598	04.841.5450.0	9704 A /GK B	395	04.842.5053.0	9705 A / 5 / 10 B	55
04.841.2250.0	9704 A /AG B	791	04.841.5450.0	9704 A /GK B	599	04.842.5053.0	9705 A / 5 / 10 B	349
04.841.2350.0	9704 A /BG B	395	04.841.5450.0	9704 A /GK B	791	04.842.5053.0	9705 A / 5 / 10 B	596
04.841.2350.0	9704 A /BG B	598	04.841.5550.0	9704 A /HK B	395	04.842.5053.0	9705 A / 5 / 10 B	790
04.841.2350.0	9704 A /BG B	791	04.841.5550.0	9704 A /HK B	599	04.842.5153.0	9705 AL / 5 / 10 B	790
04.841.2450.0	9704 A /CG B	395	04.841.5550.0	9704 A /HK B	791	04.842.5553.0	9705 A / 5 / 10 / 5 B	55
04.841.2450.0	9704 A /CG B	598	04.841.5650.0	9704 A /JK B	395	04.842.5553.0	9705 A / 5 / 10 / 5 B	394
04.841.2450.0	9704 A /CG B	791	04.841.5650.0	9704 A /JK B	599	04.842.5553.0	9705 A / 5 / 10 / 5 B	596
04.841.2550.0	9704 A /DG B	395	04.841.5650.0	9704 A /JK B	791	04.842.5953.0	9705A/6/ 9 B 1- 9	91
04.841.2550.0	9704 A /DG B	598	04.841.5750.0	9704 A /JK B	395	04.842.6053.0	9705 A / 6 / 10 B	69
04.841.2550.0	9704 A /DG B	791	04.841.5750.0	9704 A /JK B	599	04.842.6553.0	9705 A / 6 / 10 / 5 B	69
04.841.2650.0	9704 A /EG B	395	04.841.5850.0	9704 A /KK B	395	04.842.6753.0	9705A/6/7/ 12 B	790
04.841.2650.0	9704 A /EG B	598	04.841.5850.0	9704 A /KK B	791	04.842.7553.0	9705 A / 7,5 / 10 B	351
04.841.2650.0	9704 A /EG B	791	04.841.5950.0	9704 A /LK B	395	04.842.7953.0	9705A/8/ 9 B 1- 9	201
04.841.2750.0	9704 A /FG B	395	04.841.5950.0	9704 A /LK B	599	04.842.8053.0	9705 A / 8 / 10 B	189
04.841.2750.0	9704 A /FG B	598	04.841.6050.0	9704 A /MK B	395	04.842.8553.0	9705 A / 8 / 10 / 5 B	91
04.841.2750.0	9704 A /FG B	791	04.841.6050.0	9704 A /MK B	599	04.845.0153.0	9705A/5/10 B 1- 10	91
04.841.2850.0	9704 A /GG B	395	04.841.6050.0	9704 A /MK B	791	04.845.0253.0	9705A/5/10 B 11- 20	91
04.841.2850.0	9704 A /GG B	598	04.841.6150.0	9704 A /NK B	395	04.845.0353.0	9705A/5/10 B 21- 30	91
04.841.2850.0	9704 A /GG B	791	04.841.6150.0	9704 A /NK B	599	04.845.0453.0	9705A/5/10 B 31- 40	91
04.841.2950.0	9704 A /HG B	395	04.841.6150.0	9704 A /NK B	791	04.845.0553.0	9705A/5/10 B 41- 50	91
04.841.2950.0	9704 A /HG B	598	04.841.6250.0	9704 A /OK B	395	04.845.0653.0	9705A/5/10 B 51- 60	91
04.841.2950.0	9704 A /HG B	791	04.841.6250.0	9704 A /OK B	599	04.845.0753.0	9705A/5/10 B 61- 70	91
04.841.3050.0	9704 A /IG B	395	04.841.6250.0	9704 A /OK B	791	04.845.0853.0	9705A/5/10 B 71- 80	91
04.841.3050.0	9704 A /IG B	598	04.841.6350.0	9704 A /PK B	395	04.845.0953.0	9705A/5/10 B 81- 90	91
04.841.3050.0	9704 A /IG B	791	04.841.6350.0	9704 A /PK B	599	04.845.1053.0	9705A/5/10 B 91-100	91
04.841.3150.0	9704 A /JG B	395	04.841.6350.0	9704 A /PK B	791	04.846.0153.0	9705A/6/10 B 1- 10	91
04.841.3150.0	9704 A /JG B	598	04.841.6450.0	9704 A /QK B	395	04.846.0253.0	9705A/6/10 B 11- 20	91
04.841.3150.0	9704 A /JG B	791	04.841.6450.0	9704 A /QK B	599	04.846.0353.0	9705A/6/10 B 21- 30	91
04.841.3250.0	9704 A /KG B	395	04.841.6450.0	9704 A /QK B	791	04.846.0453.0	9705A/6/10 B 31- 40	91
04.841.3250.0	9704 A /KG B	598	04.841.6550.0	9704 A /RK B	395	04.846.0553.0	9705A/6/10 B 41- 50	91
04.841.3250.0	9704 A /KG B	791	04.841.6550.0	9704 A /RK B	599	04.846.0653.0	9705A/6/10 B 51- 60	91
04.841.3350.0	9704 A /LG B	395	04.841.6550.0	9704 A /RK B	791	04.846.0753.0	9705A/6/10 B 61- 70	91
04.841.3350.0	9704 A /LG B	598	04.841.6650.0	9704 A /SK B	395	04.846.0853.0	9705A/6/10 B 71- 80	91
04.841.3350.0	9704 A /LG B	791	04.841.6650.0	9704 A /SK B	599	04.846.0953.0	9705A/6/10 B 81- 90	91
04.841.3450.0	9704 A /MG B	395	04.841.6650.0	9704 A /SK B	791	04.846.1053.0	9705A/6/10 B 91-100	91
04.841.3450.0	9704 A /MG B	598	04.841.6750.0	9704 A /TK B	395	04.848.0153.0	9705A/8/10 B 1- 10	201
04.841.3450.0	9704 A /MG B	791	04.841.6750.0	9704 A /TK B	599	04.848.0253.0	9705A/8/10 B 11- 20	201
04.841.3550.0	9704 A /NG B	395	04.841.6750.0	9704 A /TK B	791	04.848.0353.0	9705A/8/10 B 21- 30	201
04.841.3550.0	9704 A /NG B	598	04.841.6850.0	9704 A /UK B	395	04.848.0453.0	9705A/8/10 B 31- 40	201
04.841.3550.0	9704 A /NG B	791	04.841.6850.0	9704 A /UK B	599	04.848.0553.0	9705A/8/10 B 41- 50	201
04.841.3650.0	9704 A /OG B	395	04.841.6850.0	9704 A /UK B	791	04.848.0653.0	9705A/8/10 B 51- 60	201
04.841.3650.0	9704 A /OG B	598	04.841.6950.0	9704 A /VK B	395	04.848.0753.0	9705A/8/10 B 61- 70	201
04.841.3650.0	9704 A /OG B	791	04.841.6950.0	9704 A /VK B	599	04.848.0853.0	9705A/8/10 B 71- 80	201
04.841.3750.0	9704 A /PG B	395	04.841.6950.0	9704 A /VK B	791	04.848.0953.0	9705A/8/10 B 81- 90	201
04.841.3750.0	9704 A /PG B	598	04.841.7050.0	9704 A /WK B	395	04.848.1053.0	9705A/8/10 B 91-100	201
04.841.3750.0	9704 A /PG B	791	04.841.7050.0	9704 A /WK B	599	04.855.0053.0	9705A/5/10B SLZ	91
04.841.3850.0	9704 A /QG B	395	04.841.7050.0	9704 A /WK B	791	04.855.0153.0	9705A/5/10B ERDZ	91
04.841.3850.0	9704 A /QG B	598	04.841.7150.0	9704 A /XK B	395	04.855.0253.0	9705A/5/10 B +	91
04.841.3850.0	9704 A /QG B	791	04.841.7150.0	9704 A /XK B	599	04.855.0253.5	9705A/5/10 B + ROT	120
04.841.3950.0	9704 A /RG B	395	04.841.7150.0	9704 A /XK B	791	04.855.0353.0	9705A/5/10 B -	91
04.841.3950.0	9704 A /RG B	598	04.841.7250.0	9704 A /YK B	395	04.855.0353.6	9705A/5/10 B - BLAU	120
04.841.3950.0	9704 A /RG B	791	04.841.7250.0	9704 A /YK B	599	04.855.0453.0	9705A/5/10B L1	91
04.841.4050.0	9704 A /SG B	395	04.841.7250.0	9704 A /YK B	791	04.855.0553.0	9705A/5/10B L2	91
04.841.4050.0	9704 A /SG B	598	04.841.7350.0	9704 A /ZK B	395	04.855.0653.0	9705A/5/10B L3	91
04.841.4050.0	9704 A /SG B	791	04.841.7350.0	9704 A /ZK B	599	04.855.0753.0	9705A/5/10B PE	91
04.841.4150.0	9704 A /TG B	395	04.841.7350.0	9704 A /ZK B	791	04.855.0853.0	9705A/5/10B L1L2L3NPE..	91
04.841.4150.0	9704 A /TG B	598	04.841.7450.0	9704 A /+ B	181	04.855.0953.0	9705A/5/10B F1	91
04.841.4150.0	9704 A /TG B	791	04.841.7450.0	9704 A /+ B	395	04.855.1053.0	9705A/5/10B F2	91
04.841.4250.0	9704 A /UG B	395	04.841.7450.0	9704 A /+ B	599	04.855.3153.0	9705A/5/10B SL	91
04.841.4250.0	9704 A /UG B	598	04.841.7450.0	9704 A /+ B	791	04.855.3253.0	9705A/5/10B N	91
04.841.4250.0	9704 A /UG B	791	04.841.7550.0	9704 A /- B	181	04.856.0053.0	9705A/6/10 B SLZ	91
04.841.4350.0	9704 A /VG B	395	04.841.7550.0	9704 A /- B	395	04.856.0153.0	9705A/6/10 B ERDZ	91

contents of
part number

contents PART NUMBER

Part no.	Type	section / page	Part no.	Type	section / page	Part no.	Type	section / page
04.856.0253.0	9705A/6/10B +	91	05.522.7856.0	BEF.HALTER	331	05.584.0053.0	CODIERSTUECK-AST	137
04.856.0353.0	9705A/6/10B -	91	05.523.1610.0	WINKEL RECHTS	204	05.584.0053.0	CODIERSTUECK-AST	311
04.856.0453.0	9705A/6/10 B L1	19	05.523.1710.0	WINKEL LINKS	204	05.584.8853.0	TR.STUECK M. U-F	590
04.856.0553.0	9705A/6/10 B L2	91	05.543.7001.0		631	05.584.8953.0	TR.STUECK M. U-F	590
04.856.0653.0	9705A/6/10 B L3	91	05.543.7021.0	FUER 0,5 MM2	631	05.584.9489.0	SELBSTKLEBESCHILD	183
04.856.0753.0	9705A/6/10B PE	91	05.543.7101.0		631	05.590.0052.0	315 E	182
04.856.0853.0	9705A/6/10B L1L2L3NPE..	91	05.543.7121.0	FUER 0,75-1 MM2	631	05.590.3121.0	1036 R	263
04.856.0953.0	9705A/6/10B F1	91	05.543.7201.0	FUER 1,5 MM2 VERGOLD	631	05.591.1255.0		410
04.856.1053.0	9705A/6/10B F2	91	05.543.7221.0	FUER 1,5 MM2	631	05.591.3089.0	ETIKETTEN A4	416
04.856.3153.0	9705A/6/10B SL	91	05.543.7301.0		631	05.591.3255.0	RICOS DISK BASE	410
04.856.3253.0	9705A/6/10B N	91	05.543.7321.0	FUER 2,5 MM2	631	05.591.3389.0	RICOS MANUAL D.	410
04.858.0053.0	9705A/6/10B SLZ	201	05.543.7401.0		631	05.592.0621.0	SPERRBOLZ M.FEDRG	786
04.858.0153.0	9705A/6/10B ERDZ	201	05.543.7421.0	FUER 4 MM2	631	05.592.1152.0		256
04.858.0253.0	9705A/6/10B +	201	05.543.9021.0	FUER 0,5 MM2 KURZ	655	05.592.1953.0	TRENNSTUECK	215
04.858.0353.0	9705A/6/10B -	201	05.543.9121.0	FUER 0,75-1 MM2	655	05.592.7553.0	FUER NYAF 1,5 MM2	138
04.858.0453.0	9705A/6/10B L1	201	05.543.9221.0	FUER 1,5 MM2 KURZ	655	05.592.7653.0	FUER NYAF 2,5 MM2	138
04.858.0553.0	9705A/6/10B L2	201	05.543.9321.0	FUER 2,5 MM2 KURZ	655	05.593.4153.0	SCHNELLMONT.GRIFF	190
04.858.0653.0	9705A/6/10B L3	201	05.543.9421.0	FUER 4 MM2	655	05.593.5853.0	SCHNELLMONT.GRIFF	190
04.858.0753.0	9705A/6/10B PE	201	05.544.0900.0	0,2 -0,56 QMM	683	05.593.5953.0	SCHNELLMONT.GRIFF	191
04.858.0853.0	9705A/6/10B L1L2L3NPE..	201	05.544.0929.0	0,2 -0,56 QMM	683	05.593.7756.0	SPERRSTUECK	331
04.858.0953.0	9705A/6/10B F1	201	05.544.1000.0	0,5 -1,5 QMM	683	05.593.8853.0	BEF.HALTER	331
04.858.1053.0	9705A/6/10B F2	201	05.544.1029.0	0,5 -1,5 QMM	683	05.594.3653.0	RASTHEBEL	331
04.858.3153.0	9705A/6/10B SL	201	05.544.1400.0	0,5 -1,5 ONN VERGOLDET	683	05.594.5153.0	CODIERSTUECK-AST	219
04.858.3253.0	9705A/6/10B N	201	05.544.1429.0	0,5 -1,5 QMM VERGOLDET	683	05.594.5853.0	SCHNELLMONT.GRIFF	175
05.084.0212.0		390	05.544.3129.8	STECKERKONTAKT	739	05.594.5953.0	SCHNELLMONT.GRIFF	175
05.091.0200.0		47	05.544.3229.8	STECKERKONTAKT	740	05.594.6053.0	SCHNELLMONT.GRIFF	175
05.502.0000.0	HOCHPOL.	683	05.544.3329.8	STECKERKONTAKT	740	05.595.5900.0	2A	128
05.502.0200.0	AUSDRUECKWERKZEUG	207	05.544.3429.8	STECKERKONTAKT	740	05.595.6000.0	4A	128
05.502.0410.0	MOD.20POL.	741	05.544.3529.8	STECKERKONTAKT	740	05.595.6100.0	6A	128
05.502.0500.0	KLINGE	207	05.544.3629.8	STECKERKONTAKT	740	05.595.6200.0	10A	128
05.502.0610.0	MOD. 4POL.	741	05.544.3729.8	STECKERKONTAKT	740	05.595.6300.0	16A	128
05.502.0710.0	MOD.10POL.	741	05.544.3829.8	STECKERKONTAKT	740	05.595.6400.0	20A	128
05.502.0810.0	MOD. 5POL.	741	05.544.3929.8	STECKERKONTAKT	740	05.595.6500.0	25A	128
05.502.0910.0	MOD. 3POL.	741	05.544.4029.8	STECKERKONTAKT	740	05.595.6600.0	35A	128
05.502.1010.0	MODULLOESEWZ.	741	05.544.4129.8	STECKERKONTAKT	740	05.595.6700.0	50A	128
05.502.2000.0	CRIMPBACKEN A	741	05.544.4229.8	STECKERKONTAKT	740	05.595.9200.0	2A	128
05.502.2000.0	CRIMPBACKEN B	798	05.544.4329.8	STECKERKONTAKT	740	05.595.9300.0	4A	128
05.502.2100.0	CRIMPBACKEN C	631	05.544.4429.8	STECKERKONTAKT	740	05.595.9400.0	6A	128
05.502.2100.0	CRIMPBACKEN D	798	05.544.4529.8	STECKERKONTAKT	740	05.595.9500.0	10A	128
05.502.2200.0	CRIMPBACKEN E	741	05.544.4629.7	STECKERKONTAKT	740	05.596.6127.0	2,08 GELB	797
05.502.2200.0	CRIMPBACKEN F	798	05.544.4729.7	STECKERKONTAKT	740	05.599.2027.0	AEI 1,5Z-N	797
05.502.2300.0	CRIMPBACKEN G	739	05.544.5621.0	STECKERKONTAKT	761	05.599.2853.0	BEF.HALTER	331
05.502.2300.0	CRIMPBACKEN H	798	05.549.0500.0	HALTEFEDER	128	05.599.2953.0	BEF.HALTER	331
05.502.2400.0	CRIMPBACKEN I	683	05.549.1200.0	KONTAKTFEDER	177	05.599.8053.0	CODIERSTUECK-AST	205
05.502.2400.0	CRIMPBACKEN J	798	05.555.8521.0	FLACHSTECKER	584	05.599.8053.0	CODIERSTUECK-AST	321
05.502.2500.0		291	05.555.8621.0	FLACHSTECKER	584	06.065.0021.0	AM 5 X 12 D 933SZMS	156
05.502.3100.0	KONT.AUFNAHME 1	739	05.555.8721.0	FLACHSTECKER	584	06.502.4000.0	DIN 5264 A 0,6 x 3,5	20
05.502.3100.0	KONT.AUFNAHME 2	798	05.555.8821.0	FLACHSTECKER	584	06.502.4000.0	DIN 5264 A 0,6 x 3,5	293
05.502.3200.0	KONT.AUFNAHME 3	683	05.555.8921.0	FLACHSTECKER	584	06.502.4000.0	DIN 5264 A 0,8 x 4,0	799
05.502.3200.0	KONT.AUFNAHME 4	798	05.555.9121.0	FLACHSTECKER	584	06.502.4100.0	DIN 5264 A 1,0 x 5,5	21
05.502.3300.0	KONT.AUFNAHME 5	631	05.561.0053.0	CODIERAST STIFTL.	36	06.502.4200.0	DIN 5264 A 1,0 x 5,5	21
05.502.3300.0	KONT.AUFNAHME 6	798	05.561.0053.0	CODIERAST STIFTL.	284	06.502.4300.0	DIN 5264 A 0,4 X 2,5	281
05.502.3500.0	F. 400/690V-SER.	631	05.561.1389.0		412	06.502.5000.0	DIN 5264 B 0,6X3,5 M	30
05.507.4021.0	M 20 x 1,5	779	05.561.4125.0	VERB.-SCHIENE	134	06.600.2027.0	DIN 46228-E 0,5 - 8	796
05.507.4053.0	M 20 x 1,5	779	05.561.4125.0	VERB.-SCHIENE	310	06.600.2127.0	DIN 46228-E 0,75 - 8	796
05.507.4121.0	M 25 x 1,5	779	05.561.6553.0	LEL 2,5/1 WEISS	19	06.600.2227.0	DIN 46228-E 1 - 8	796
05.507.4153.0	M 25 x 1,5	779	05.561.6553.0	LEL 2,5/1 WEISS	308	06.600.2327.0	DIN 46228-E 1,5 - 8	796
05.507.4221.0	M 32 x 1,5	779	05.561.6653.0	LEL 2,5/2 GRAU	20	06.600.2427.0	DIN 46228-E 1,5 - 18	796
05.507.4253.0	M 32 x 1,5	779	05.561.6653.0	LEL 2,5/2 GRAU	308	06.600.2527.0	DIN 46228-E 2,5 - 8	796
05.507.4321.0	M 40 x 1,5	779	05.561.6753.0	LEL 2,5/3 SCHWARZ	19	06.600.2627.0	DIN 46228-E 2,5 - 18	796
05.507.4353.0	M 40 x 1,5	779	05.561.6753.0	LEL 2,5/3 SCHWARZ	308	06.600.2727.0	DIN 46228-E 4 - 10	796
05.507.7621.0	PG 13,5 - M 20 x 1,5	778	05.561.8553.0	LEL 4/1 WEISS	20	06.600.2827.0	DIN 46228-E 4 - 18	796
05.507.7721.0	PG 16 - M 20 x 1,5	778	05.561.8653.0	LEL 4/2 GRAU	20	06.600.2927.0	DIN 46228-E 6 - 12	796
05.507.7821.0	PG 21 - M 25 x 1,5	778	05.561.8753.0	LEL 4/3 SCHWARZ	20	06.600.3027.0	DIN 46228-E 6 - 18	796
05.507.8121.0	M 20 x 1,5 - PG 13,5	779	05.561.9153.0	CODIERAST BU.LST.	37	06.600.3127.0	DIN 46228-E10 - 12	796
05.507.8221.0	M 20 x 1,5 - PG 16	779	05.561.9153.0	CODIERAST BU.LST.	286	06.600.3227.0	DIN 46228-E10 - 18	796
05.507.8321.0	M 25 x 1,5 - PG 21	779	05.561.9453.0	CODIERSTIFT-AST	319	06.600.3327.0	DIN 46228-E16 - 12	796
05.507.8421.0	M 32 x 1,5 - PG 29	779	05.561.9453.5	CODIERSTIFT-AST	319	06.600.3427.0	DIN 46228-E16 - 18	796
05.507.8621.0	M 16 x 1,5 - M 20 x 1,5	778	05.561.9553.0	WIEBOX CN BL1	594	06.600.3527.0	DIN 46228-E25 - 18	796
05.507.8721.0	M 20 x 1,5 - M 25 x 1,5	778	05.561.9653.0	WIEBOX CN BL2	594	06.600.4027.0	DIN 46228-A 0,5 - 6	796
05.507.8821.0	M 25 x 1,5 - M 32 x 1,5	778	05.562.1389.0		410	06.600.4127.0	DIN 46228-A 0,75 - 6	796
05.507.8921.0	M 32 x 1,5 - M 40 x 1,5	778	05.562.2453.0	LEL 1,5/1 WEISS	33	06.600.4227.0	DIN 46228-A 1 - 6	796
05.507.9021.0	M 20 x 1,5 - M 16 x 1,5	778	05.562.2453.0	LEL 1,5/1 WEISS	309	06.600.4327.0	DIN 46228-A 1,5 - 7	796
05.507.9121.0	M 25 x 1,5 - M 20 x 1,5	778	05.562.2553.0	LEL 1,5/2 GRAU	33	06.600.4427.0	DIN 46228-A 2,5 - 7	796
05.507.9221.0	M 32 x 1,5 - M 25 x 1,5	778	05.562.2553.0	LEL 1,5/2 GRAU	309	06.600.4527.0	DIN 46228-A 4 - 9	796
05.507.9321.0	M 40 x 1,5 - M 32 x 1,5	778	05.562.2653.0	LEL 1,5/3 SCHWARZ	33	06.600.4627.0	DIN 46228-A 6 - 10	796
05.508.3121.0	9011 A	191	05.562.2653.0	LEL 1,5/3 SCHWARZ	309	06.600.4727.0	DIN 46228-A10 - 12	796
05.508.3221.0	9011 B	101	05.562.3183.0	GUMMISTOPFEN KL.	755	06.600.4827.0	DIN 46228-A16 - 12	796
05.508.6521.0	STECKERBUCHSE	191	05.562.3283.0	GUMMISTOPFEN GR.	755	06.600.4927.0	DIN 46228-A25 - 15	796
05.508.8621.0	SCHRAUBBUCHSE	197	05.562.5957.1		389	06.600.5027.0	IN 46228-A35 - 18	796
05.508.8721.0	SCHRAUBBUCHSE	197	05.562.6557.1		389	07.201.4227.0	VB RFK 1 185 2	157
05.508.8821.0	9011 C	176	05.562.8257.1		389	07.201.4327.0	VB RFK 1 185 3	157
05.508.882100		197	05.563.5453.0		148	07.201.4427.0	VB RFK 1 185 4	157
05.508.8921.0		176	05.563.8053.0		124	07.201.8227.0	VB RFK 1 240 2	159
05.508.9721.0	SCHRAUBBUCHSE	197	05.576.5853.0	WK 2,5 U /8113 S-VS	137	07.201.8327.0	VB RFK 1 240 3	159
05.509.6021.0	STECKERBUCHSE	176	05.576.5853.0	WK 2,5 U /8113 S-VS	311	07.201.8427.0	VB RFK 1 240 4	159
05.511.2953.0		148	05.576.8312.0		787	07.205.1227.0	VB RFK 1 / 95 / 2 / 32	153
05.511.2953.7		148	05.576.8412.0		787	07.205.1327.0	VB RFK 1 / 95 / 3 / 32	153
05.511.2953.8		148	05.576.8512.0		787	07.205.1427.0	VB RFK 1 / 95 / 4 / 32	153
05.511.2953.9		148	05.582.8153.0		175	07.205.5227.0		154
05.513.4212.0	SPERRBOLZ M.FEDRG	786	05.582.8653.0	SCHNELLMONT.GRIFF	175	07.205.5327.0		154
05.516.9510.0	GLEITMUTTER	215</						

contents

Part no.	Type	section / page	Part no.	Type	section / page	Part no.	Type	section / page
07.205.9227.0		155	07.310.9853.0	AP 8113 SE	303	07.312.2253.6	TWF 2,5 - 4 BLAU	20
07.205.9327.0		155	07.311.0155.0	AP 2,5 - 4 /V0	78	07.312.2353.0	APF 2,5/D 1/2	26
07.250.0027.0		256	07.311.0155.6	AP 2,5 - 4 BL/V0	78	07.312.2353.6	APF 2,5/D 1/2 BLAU	26
07.250.0227.0	VB 11/ 1 / 2	258	07.311.0255.0	AP 6 /V0	103	07.312.2353.7	APF 2,5/D 2/2 GRUEN	28
07.250.0327.0		258	07.311.0255.6	AP 6 BL/V0	103	07.312.2453.0	TWF 2,5/D 1/2	26
07.250.0627.0	VB 11/ 1 / 6	258	07.311.0653.0	APM 2,5 F. / 15	144	07.312.2453.6	TWF 2,5/D 1/2 BLAU	26
07.250.1027.0	VB 11 / 1 / 12	258	07.311.0753.0	APM 4 SL / 15	145	07.312.2553.0	APF 2,5/D 2/2	26
07.250.1627.0	VERBINDUNGSKAMM #	256	07.311.0853.0	APM 2,5 - 4 / 15	145	07.312.2553.6	APF 2,5/D 2/2 BLAU	26
07.250.2527.0	VB 11/ 2	218	07.311.0853.6	APM 2,5 - 4 / 15 BLAU	145	07.312.2553.7	APF 2,5/D 2/2 GRUEN	28
07.250.3027.0	VERBINDUNGSKAMM	128	07.311.1155.0	TW 2,5 - 4 /V0	78	07.312.2653.0	TWF 2,5/D 2/2	26
07.250.3127.0	VERBINDUNGSKAMM #	128	07.311.1155.6	TW 2,5 - 4 BL/V0	78	07.312.2653.6	TWF 2,5/D 2/2 BLAU	26
07.253.0027.0	VB 9786 M	259	07.311.1255.0	TW 6 /V0	103	07.312.2853.0	APF 4 TK	38
07.253.0227.0	VB 9786 2	130	07.311.1255.6	TW 6 BL/V0	103	07.312.3553.0	APF 1,5 E	33
07.253.0327.0	VB 9786 3	130	07.311.1853.0	TWM 2,5 - 4 /15	145	07.312.3653.0	TWF 1,5 E	33
07.253.0427.0	VB 9786 4	168	07.311.1853.6	TW 2,5 - 4 /15 BLAU	145	07.312.4153.0	APF 2,5/D2 /8113	36
07.253.0627.0	VB 9786 6	130	07.311.2053.0		310	07.312.4153.6	APF 2,5/D2 /8113 BLAU	308
07.255.0027.0	VB 0,5 WK 4.- M-70	168	07.311.2053.8	TS 2,5 GELB	101	07.312.4153.6	APF 2,5/D2/8113 BLAU	36
07.255.0227.0	VB 0,5 WK 4.- 2	168	07.311.2053.8	TS 2,5 GELB	312	07.312.4153.6	APF 2,5/D2/8113 BLAU	308
07.255.0327.0	VB 0,5 WK 4.- 3	168	07.311.2153.8	TS 4 GELB	78	07.312.4353.0	APF 4 TK	39
07.255.0427.0	VB 0,5 WK 4.- 4	168	07.311.2253.8	TS 6 GELB	103	07.312.4655.0	AP 2,5U/8113../V0	136
07.255.0527.0	VB 0,5 WK 4.- 5	168	07.311.2353.8	TS 10 GELB	78	07.312.4655.0	AP 2,5U/8113../V0	310
07.255.0627.0	VB 0,5 WK 4.- 6	168	07.311.2453.8	TS 16 GELB	69	07.312.4753.0	WKF 1,5E/8113/35	37
07.255.0727.0	VB 0,5 WK 4.- 7	168	07.311.2853.8	TSM 2,5 / 15 GELB	144	07.312.4753.0	WKF 1,5E/8113/35	309
07.255.0827.0	VB 0,5 WK 4.- 8	168	07.311.2953.8	TS 4 / 15 GELB	112	07.312.4853.0	APF4/D1/2	27
07.255.0927.0	VB 0,5 WK 4.- 9	168	07.311.3853.0	AP 4 3S 1K / V0	138	07.312.4853.6	APF4/D1/2 BLAU	27
07.255.1027.0	VB 0,5 WK 4.-10	168	07.311.4055.0	AP 4 E /V0	114	07.312.4853.7	APF4/D1/2 GRUEN	29
07.255.1127.0	VB 0,5 WK 4.-11	168	07.311.4155.0	AP 10/SI /V0	125	07.312.4953.0	TWF 4/D1/2	27
07.255.1227.0	VB 0,5 WK 4.-12	168	07.311.4255.0	AP 4 S/V0	141	07.312.4953.6	TWF 4/D1/2 BLAU	27
07.255.2027.0	VB WK4 E M	168	07.311.4355.0	AP 4 S / IW/V0	141	07.312.5053.0	AP 1 - 2,5	232
07.255.2227.0	VB WK4 E - 2	168	07.311.4455.0	AP 3 S/V0	140	07.312.5053.6	AP 1 - 2,5 BLAU	232
07.255.2327.0	VB WK4 E - 3	168	07.311.4555.0	AP 3 S / IW/V0	140	07.312.5053.7	AP 1 - 2,5 GRUEN	233
07.255.2427.0	VB WK4 E - 4	168	07.311.4655.0	AP 5 S/V0	139	07.312.5153.0	TW 1 - 2,5	232
07.255.2527.0	VB WK4 E - 5	168	07.311.5055.0	TW 4 E /V0	114	07.312.5153.6	TW 1 - 2,5	232
07.255.2627.0	VB WK4 E - 6	168	07.311.6155.0	AP 4 TK /V0	122	07.312.5253.0	APC 1-2,5 D./TK.	234
07.255.2727.0	VB WK4 E - 7	168	07.311.6155.6	AP 4 TK BL /V0	123	07.312.5253.6	APC 1-2,5 D./TK. BLAU	234
07.255.2827.0	VB WK4 E - 8	168	07.311.6355.0	AP 4/D /V0	112	07.312.5253.7	APC 1-2,5 D./TK.GRUEN	235
07.255.2927.0	VB WK4 E - 9	168	07.311.6355.6	AP 4/D BL /V0	112	07.312.5353.0	TWC 1 - 2,5 D1.	234
07.255.3027.0	VB WK4 E - 10	168	07.311.6455.0	AP4 /D1 /2 /V0	112	07.312.5353.6	TWC 1 - 2,5 D1. BLAU	234
07.255.3127.0	VB WK 4E - 11	168	07.311.6455.6		112	07.312.5453.0	APC 1-2,5 D2./E	231
07.255.3227.0	VB WK4 E - 12	168	07.311.6555.0	API 4/2/V0	69	07.312.5453.6	APC 1-2,5 D./E. BLAU	236
07.255.4027.0	VB 1 WK 4.- M-70	168	07.311.6655.0	APN 10 /V0	103	07.312.5453.7	APC 1-2,5 D 2./E. GRUEN	237
07.255.4227.0	VB 1 WK 4.- 2	168	07.311.6655.6	APN 10 BL/V0	103	07.312.5553.0	TWC 1 - 2,5 D2./ E	231
07.255.4327.0	VB 1 WK 4.- 3	168	07.311.6755.0	APN 16 /V0	104	07.312.5553.6	TWC 1 - 2,5 D2./ E BLAU	236
07.255.4427.0	VB 1 WK 4.- 4	168	07.311.6755.6	APN 16 BL/V0	104	07.312.5653.0	APF 4 NT	24
07.255.4527.0	VB 1 WK 4.- 5	168	07.311.6855.0	API 4/3/V0	74	07.312.5753.0	APF 4 E	30
07.255.4627.0	VB 1 WK 4.- 6	168	07.311.6955.0	TWI 4/V0	72	07.312.5753.7	APF 4 E GRUEN	31
07.255.4727.0	VB 1 WK 4.- 7	168	07.311.7655.0	TWN 10 /V0	103	07.312.5853.0	TWF 4 E	30
07.255.4827.0	VB 1 WK 4.- 8	168	07.311.7655.6	TWN 10 BL/V0	103	07.312.5953.0		40
07.255.4927.0	VB 1 WK 4.- 9	168	07.311.7755.0	TWN 16 /V0	104	07.312.6053.0		177
07.255.5027.0	VB 1 WK 4.-10	168	07.311.7755.6	TWN 16 BL/V0	104	07.340.0353.0	TE /RFK 1 / 95 PA/V0	156
07.255.5127.0	VB 1 WK 4.-11	168	07.311.7855.0	TWN 35 /V0	105	07.340.1053.0	TE/RFK 1/150-240 PA/V0	157
07.255.5227.0	VB 1 WK 4.-12	168	07.311.7855.6	TWN 35 BL /V0	105	07.340.1153.0	TRENNWAND M.BEZ.	152
07.256.4227.0	VBS WK4 E - 2	168	07.311.7955.0	TWN 70 /V0	105	07.340.1353.0	TRENNWAND M.BEZ.	152
07.256.4327.0	VBS WK4 E - 3	168	07.311.7955.6	TWN 70 BL /V0	105	07.340.2153.0	BEZ.PLATTE	152
07.256.4427.0	VBS WK4 E - 4	168	07.311.8155.0	TW 4 TK... /V0	122	07.340.2353.0	BEZ.PLATTE	152
07.256.4527.0	VBS WK4 E - 5	168	07.311.8353.0	APIF 2,5	58	07.340.3553.0		154
07.256.4627.0	VBS WK4 E - 6	168	07.311.8453.8	TSN16 GELB	104	07.340.3653.0		154
07.256.4727.0	VBS WK4 E - 7	168	07.311.8553.8	TSN ad 16 GELB	104	07.340.3753.0		155
07.256.4827.0	VBS WK4 E - 8	168	07.311.8653.8	TSI 35 GELB	79	07.340.4153.0	ABSCHLUSSPL.M.BEZ	152
07.256.4927.0	VBS WK4 E - 9	168	07.311.8855.0	API 35/V0	79	07.340.4353.0	ABSCHLUSSPL.M.BEZ	152
07.256.5027.0	VBS WK4 E - 10	168	07.311.8855.6	API 35 BLAU/V0	79	07.409.7056.0	DECKEL	780
07.256.5127.0	VBS WK4 E - 11	168	07.311.9055.0	AP 2,5 U/D/8113 S/V/V0	134	07.409.7156.0	DECKEL	780
07.256.5227.0	VBS WK4 E - 12	168	07.311.9055.6	AP 2,5 U/D/8113 S/V/V0	312	07.409.7256.0	DECKEL	780
07.256.8027.0	VB 16 E / M	259	07.311.9055.6	AP2,5U/D/8113 S/V BL/V0	313	07.409.7356.0	DECKEL	780
07.256.8227.0	VB 16 E / 2 POLIG	259	07.311.9155.0	ZP 2,5 U/D/8113 S/V/V0	134	07.413.3653.0	LOCHSTREIFEN	331
07.257.0227.0	VB WK2,5 KO - 2	120	07.311.9155.0	ZP 2,5 U/D/8113 S/V/V0	312	07.416.4553.0	WIEBOX CN 19 EP	594
07.257.0327.0	VB WK2,5 KO - 3	120	07.311.9155.6	ZP2,5U/D/8113 S/V BL/V0	313	07.416.4653.0	WIEBOX CN 22 EP	594
07.257.2027.0	VB WK2,5 KO - 20	120	07.311.9455.0	API 10 - 16/V0	78	07.416.4753.0	WIEBOX CN 26 EP	595
07.300.2753.0	ZWISCHENPLATTE	374	07.311.9455.6	API 10 - 16 BLAU/V0	78	07.416.4853.0	WIEBOX CN 19 FK	594
07.300.4753.0	AP 8185 TOP N	349	07.311.9555.0	API 10 - 16 SL/V0	82	07.416.4856.0	WIEBOX CN 19 FK G	594
07.310.3153.0	9701 / 6	190	07.311.9853.0		137	07.416.4953.0	WIEBOX CN 22 FK	594
07.310.3153.6	9701 / 6 BLAU	190	07.311.9855.0	AP 2,5U/8113S/H/V0	311	07.416.4956.0	WIEBOX CN 22 FK G	594
07.310.3253.0	9701 / 8	191	07.312.0053.0	9701 / 6 SL	194	07.416.5053.0	WIEBOX CN 26 FK	595
07.310.3253.6	9701 / 8 BLAU	191	07.312.0153.0	9701 / 8 SL	194	07.416.5056.0	WIEBOX CN 26 FK G	595
07.310.3353.0	9701 / 12	191	07.312.0253.0	9701 / 10 SL	195	07.416.5153.0	WIEBOX CN DK	594
07.310.3353.6	9701 / 12 BLAU	191	07.312.0353.0	9701 / 16 SL	189	07.416.5253.0	WIEBOX CN DU	594
07.310.3453.0	9702 / 6	190	07.312.0555.0	TW 2,5-4 K/V0	118	07.416.5353.0	WIEBOX CN 19 DK	594
07.310.3453.6	9702 / 6 BLAU	190	07.312.0855.0	APN 16ETK /V0	107	07.416.5453.0	WIEBOX CN 19 DU	594
07.310.3553.0	9702 / 8	191	07.312.0955.0	APN 10ETK /V0	106	07.416.5653.0	WIEBOX CN 22 DK	594
07.310.3553.6	9702 / 8 BLAU	191	07.312.1155.0	APN 4ETK /V0	106	07.416.5753.0	WIEBOX CN 22 DU	594
07.310.3653.0	9702 / 12	191	07.312.1255.0	TW 2,5-3 D/U /V0	118	07.416.5853.0	WIEBOX CN 26 DK	595
07.310.3653.6	9702 / 12 BLAU	191	07.312.1555.0	AP 2,5 U/8113 S/V /V0	136	07.416.5953.0	WIEBOX CN 26 DU	595
07.310.3953.0	9701 / 10	191	07.312.1555.6	AP 2,5 U/8113 S/V /V0	310	07.416.6353.0	REDUZIERPL. 24/6	784
07.310.3953.6	9701 / 10 BLAU	191	07.312.1555.6	AP 2,5 U/8113 S/V BL/V0	137	07.416.6453.0	REDUZIERPL. 24/10	784
07.310.4053.0	9702 / 10	191	07.312.1655.0	ZP 2,5 U/8113 S/V/V0	136	07.416.6553.0	REDUZIERPL. 24/16	784
07.310.4053.6	9702 / 10 BLAU	191	07.312.1655.0	ZP 2,5 U/8113 S/V/V0	310	07.416.6853.0	ABDECKPLATTE 6	784
07.310.4553.0	9701 / 6 ETK L	193	07.312.1655.6	ZP 2,5 U/8113 S/V BL/V0	137	07.416.6953.0	ABDECKPLATTE 10	784
07.310.5253.0	9701 B / 8 ETK	193	07.312.1655.6	ZP 2,5 U/8113 S/V BL/V0	311	07.416.7053.0	ABDECKPLATTE 16	784
07.310.5353.0	9701 B / 10 ETK	193	07.312.1755.0	APN2,5E	116	07.416.7153.0	ABDECKPLATTE 24	784
07.310.5855.0	9701 A/6 1S KO TP 2/V0	141	07.312.1855.0	TWN2,5E	116	07.417.6729.0	DECKEL	713
07.310.8453.0	ABSCHLUSSPLATTE	584	07.312.1955.0	API 10-16 ETK/1/V0	80	07.417.6753.0	DECKEL	713
07.310.8553.0	ABSCHLUSSPLATTE	584	07.312.2153.0	APF 2,5 - 4	20	07.417.6829.0	DECKEL M.DICHTUNG	713
07.310.9355.0	AP 2,5-4 KO/V0	120	07.312.2153.6	APF 2,5 - 4 BLAU	20	07.417.6853.0		713
07.310.9455.0	TW 2,5-4 KO/V0	120	07.312.2153.7	APF 2,5 - 4 GRUEN	22	07.450.0187.0		267
07.310.9653.0	ABSCHLUSSPLATTE	591	07.312.2253.0	TWF 2,5 - 4	19	07.450.2487.0		267

contents of
part number

contents PART NUMBER

Part no.	Type	section / page	Part no.	Type	section / page	Part no.	Type	section / page
07.451.0180.0		267	15.011.0253.0	8105 B / 2 C1 VL OB GR	383	15.312.0758.9	8105 F / 7 W C2 OB NT	383
07.451.2480.0	BZ KL 17 / 24	267	15.011.0353.0	8105 B / 3 C1 VL OB	383	15.313.0258.9	8105 F / 2 W C3 OB NT	383
07.470.1380.0	UNTERLEGPLATTE	258	15.011.0453.0	8105 B / 4 C1 VL OB	383	15.313.0358.9	8105 F / 3 W C3 OB NT	383
07.470.2256.0	LEITERHALTER	258	15.011.0553.0	8105 B / 5 C1 VL OB	383	15.313.0458.9	8105 F / 4 W C3 OB NT	383
07.470.3256.0	LEITERHALTER	258	15.011.0653.0	8105 B / 6 C1 VL OB	383	15.314.0258.9	8105 F / 2 W C4 OB NT	383
07.471.1380.0	UNTERLEGPLATTE	259	15.011.0753.0	8105 B / 7 C1 VL OB	383	15.314.0358.9	8105 F / 3 W C4 OB NT	383
07.472.1380.0	UNTERLEGPLATTE	259	15.012.0253.0	8105 B / 2 C2 VL OB GR	383	15.314.0458.9	8105 F / 4 W C4 OB NT	383
07.473.1380.0	UNTERLEGPLATTE	259	15.012.0353.0	8105 B / 3 C2 VL OB GR	383	15.315.0258.9	8105 F / 2 W C5 OB NT	383
08.000.0106.0	X L= 1000 MIT SCHIRM	569	15.012.0453.0	8105 B / 4 C2 VL OB	383	15.315.0358.9	8105 F / 3 W C5 OB NT	383
08.000.0106.1	X L= 1500 MIT SCHIRM	569	15.012.0553.0	8105 B / 5 C2 VL OB	383	15.315.0458.9	8105 F / 4 W C5 OB NT	383
08.000.0106.2	X L= 2000 MIT SCHIRM	569	15.012.0653.0	8105 B / 6 C2 VL OB	383	15.316.0258.9	8105 F / 2 W C6 OB NT	383
08.000.0106.3	X L= 2500 MIT SCHIRM	569	15.012.0753.0	8105 B / 7 C2 VL OB	383	15.316.0358.9	8105 F / 3 W C6 OB NT	383
08.000.0106.4	X L= 3000 MIT SCHIRM	569	15.013.0253.0	8105 B / 2 C3 VL OB	383	15.316.0458.9	8105 F / 4 W C6 OB NT	383
08.000.0106.5	X L= 3500 MIT SCHIRM	569	15.013.0353.0	8105 B / 3 C3 VL OB	383	15.317.0253.0	8105 F / 2 W C7 OB NT	383
08.000.0106.6	X L= 4000 MIT SCHIRM	569	15.013.0453.0	8105 B / 4 C3 VL OB	383	15.317.0358.9	8105 F / 3 W C7 OB NT	383
08.000.0106.7	X L= 4500 MIT SCHIRM	569	15.014.0253.0	8105 B / 2 C4 VL OB	383	15.800.8856.0		391
08.000.0106.8	X L= 5000 MIT SCHIRM	569	15.014.0353.0	8105 B / 3 C4 VL OB	383	15.800.9956.0		389
08.000.0106.9	X L= 6000 MIT SCHIRM	569	15.014.0453.0	8105 B / 4 C4 VL OB	383	19.230.0040.0	KSO 11 / 1 Z KR	216
08.000.0107.0	X L= 7000 MIT SCHIRM	569	15.015.0253.0	8105 B / 2 C5 VL OB	383	21.304.0153.0	4E / 1	257
08.000.0107.1	X L= 8000 MIT SCHIRM	569	15.015.0353.0	8105 B / 3 C5 VL OB	383	21.304.0253.0	4E / 2	257
08.000.0107.2	X L= 9000 MIT SCHIRM	569	15.015.0453.0	8105 B / 4 C5 VL OB	383	21.304.0353.0	4E / 3	257
08.000.0107.3	X L= 10000 MIT SCHIRM	569	15.016.0253.0	8105 B / 2 C6 OB	383	21.304.0453.0	4E / 4	257
08.000.0107.4	X L= 1000 OHNE SCHIRM	569	15.016.0353.0	8105 B / 3 C6 OB	383	21.304.0553.0	4E / 5	257
08.000.0107.5	X L= 1500 OHNE SCHIRM	569	15.016.0453.0	8105 B / 4 C6 VL OB	383	21.304.0653.0	4E / 6	257
08.000.0107.6	X L= 2000 OHNE SCHIRM	569	15.017.0253.0	8105 B / 2 C7 VL OB	383	21.304.0753.0	4E / 7	257
08.000.0107.7	X L= 2500 OHNE SCHIRM	569	15.017.0353.0	8105 B / 3 C7 VL OB	383	21.304.0853.0	4E / 8	257
08.000.0107.8	X L= 3000 OHNE SCHIRM	569	15.020.0253.0	8105 B / 2 C0 VR OB	382	21.304.0953.0	4E / 9	257
08.000.0108.0	X L= 4000 OHNE SCHIRM	569	15.020.0353.0	8105 B / 3 C0 VR OB	382	21.304.1053.0	4E / 10	257
08.000.0108.1	X L= 4500 OHNE SCHIRM	569	15.020.0453.0	8105 B / 4 C0 VR OB	382	21.304.1153.0	4E / 11	257
08.000.0108.2	X L= 5000 OHNE SCHIRM	569	15.020.0553.0	8105 B / 5 C0 VR OB	382	21.304.1253.0	4E	257
08.000.0108.3	X L= 6000 OHNE SCHIRM	569	15.020.0653.0	8105 B / 6 C0 VR OB	382	21.305.0153.0	4E / 1 DS	257
08.000.0108.4	X L= 7000 OHNE SCHIRM	569	15.020.0753.0	8105 B / 7 C0 VR OB	382	21.305.0253.0	4E / 2 DS	257
08.000.0108.5	X L= 8000 OHNE SCHIRM	569	15.021.0253.0	8105 B / 2 C1 VR OB	382	21.305.0353.0	4E / 3 DS	257
08.000.0108.6	X L= 9000 OHNE SCHIRM	569	15.021.0353.0	8105 B / 3 C1 VR OB	382	21.305.0453.0	4E / 4 DS	257
08.000.0108.7	X L= 10000 OHNE SCHIRM	569	15.021.0453.0	8105 B / 4 C1 VR OB GR	382	21.305.0553.0	4E / 5 DS	257
08.000.0108.9	Y BANDBREITE BIS 8M	569	15.021.0553.0	8105 B / 5 C1 VR OB	382	21.305.0653.0	4E / 6 DS	257
14.100.0170.0	547	261	15.021.0653.0	8105 B / 6 C1 VR OB	382	21.305.0753.0	4E / 7 DS	257
14.100.0270.0	548	261	15.021.0753.0	8105 B / 7 C1 VR OB	382	21.305.0853.0	4E / 8 DS	257
14.100.0370.0	549	261	15.022.0253.0	8105 B / 2 C2 VR OB GR	382	21.305.0953.0	4E / 9 DS	257
14.200.0270.0	1032	262	15.022.0353.0	8105 B / 3 C2 VR OB GR	382	21.305.1053.0	4E / 10 DS	257
14.200.0370.0	1033	262	15.022.0453.0	8105 B / 4 C2 VR OB	382	21.305.1153.0	4E / 11 DS	257
14.200.0470.0	1033 A	262	15.022.0553.0	8105 B / 5 C2 VR OB	382	21.305.1253.0	4E DS	257
14.200.1270.0	1032 M 3.5	262	15.022.0653.0	8105 B / 6 C2 VR OB	382	21.310.0153.0	6E / 1	258
14.200.1370.0	1033 M 3.5	262	15.022.0753.0	8105 B / 7 C2 VR OB	382	21.310.0253.0	6E / 2	258
14.200.1470.0	1033 A M 3.5	262	15.023.0253.0	8105 B / 2 C3 VR OB	382	21.310.0353.0	6E / 3	258
14.201.0270.0	1032 DS	262	15.023.0353.0	8105 B / 3 C3 VR OB GR	382	21.310.0453.0	6E / 4	258
14.201.0370.0	1033 DS	262	15.023.0453.0	8105 B / 4 C3 VR OB	382	21.310.0553.0	MIMLEISTEGE / 5	258
14.201.0470.0	1033 A DS	262	15.024.0253.0	8105 B / 2 C4 VR OB GR	382	21.310.0653.0	6E / 6	258
14.210.0270.0	2 DIN 46284 ST	262	15.024.0353.0	8105 B / 3 C4 VR OB GR	382	21.310.0753.0	6E / 7	258
14.210.0370.0	3 DIN 46284 ST	262	15.024.0453.0	8105 B / 4 C4 VR OB GR	382	21.310.0853.0	6E / 8	258
14.211.0270.0	2 D DIN 46284 ST	262	15.025.0253.0	8105 B / 2 C5 VR OB	382	21.310.0953.0	6E / 9	258
14.211.0370.0	3 D DIN 46284 ST	262	15.025.0353.0	8105 B / 3 C5 VR OB GR	382	21.310.1053.0	6E / 10	258
14.220.0270.0	1031	262	15.025.0453.0	8105 B / 4 C5 VR OB GR	382	21.310.1253.0	6E	258
14.220.0370.0	1029	262	15.026.0253.0	8105 B / 2 C6 VR OB	382	21.311.0153.0	6E / 1 DS	258
14.230.0270.0	1027	262	15.026.0353.0	8105 B / 3 C6 VR OB	382	21.311.0253.0	6E / 2 DS	258
14.290.0440.0	1033 AP KR	262	15.026.0453.0	8105 B / 4 C6 VR OB	382	21.311.0353.0	6E / 3 DS	258
14.291.0440.0	1033 AP DS KR	262	15.027.0253.0	8105 B / 2 C7 VR OB GR	382	21.311.0453.0	6E / 4 DS	258
15.000.0253.0	8105 B / 2 C0 OB	382	15.027.0353.0	8105 B / 3 C7 VR OB	382	21.311.0553.0	6E / 5 DS	258
15.000.0353.0	8105 B / 3 C0 OB	382	15.301.0258.9	8105 F / 2 G C1 OB NT	383	21.311.0653.0	6E / 6 DS	258
15.000.0453.0	8105 B / 4 C0 OB	382	15.301.0358.9	8105 F / 3 G C1 OB NT	383	21.311.0753.0	6E / 7 DS	258
15.000.0553.0	8105 B / 5 C0 OB	382	15.301.0458.9	8105 F / 4 G C1 OB NT	383	21.311.0853.0	6E / 8 DS	258
15.000.0653.0	8105 B / 6 C0 OB	382	15.301.0558.9	8105 F / 5 G C1 OB NT	383	21.311.0953.0	6E / 9 DS	258
15.000.0753.0	8105 B / 7 C0 OB	382	15.301.0658.9	8105 F / 6 G C1 OB NT	383	21.311.1053.0	6E / 10 DS	258
15.001.0253.0	8105 B / 2 C1 OB	382	15.301.0758.9	8105 F / 7 G C1 OB NT	383	21.311.1253.0	6E DS	258
15.001.0353.0	8105 B / 3 C1 OB	382	15.302.0258.9	8105 F / 2 G C2 OB NT	383	21.312.0153.0	6E H / 1	257
15.001.0453.0	8105 B / 4 C1 OB	382	15.302.0358.9	8105 F / 3 G C2 OB NT	383	21.312.0253.0	6E H / 2	257
15.001.0553.0	8105 B / 5 C1 OB	382	15.302.0458.9	8105 F / 4 G C2 OB NT	383	21.312.0353.0	6E H / 3	257
15.001.0653.0	8105 B / 6 C0 OB	382	15.302.0558.9	8105 F / 5 G C2 OB NT	383	21.312.0453.0	6E H / 4	257
15.001.0753.0	8105 B / 7 C1 OB	382	15.302.0658.9	8105 F / 6 G C2 OB NT	383	21.312.0553.0	6E H / 5	257
15.002.0253.0	8105 B / 2 C2 OB	382	15.302.0758.9	8105 F / 7 G C2 OB NT	383	21.312.0653.0	6E H / 6	257
15.002.0353.0	8105 B / 3 C2 OB	382	15.303.0258.9	8105 F / 2 G C3 OB NT	383	21.312.0753.0	6E H / 7	257
15.002.0453.0	8105 B / 4 C2 OB	382	15.303.0358.9	8105 F / 3 G C3 OB NT	383	21.312.0853.0	6E H / 8	257
15.002.0553.0	8105 B / 5 C2 OB	382	15.303.0458.9	8105 F / 4 G C3 OB NT	383	21.312.0953.0	6E H / 9	257
15.002.0653.0	8105 B / 6 C2 OB GR	382	15.304.0258.9	8105 F / 2 G C4 OB NT	383	21.312.1053.0	6E H / 10	257
15.002.0753.0	8105 B / 7 C2 OB	382	15.304.0358.9	8105 F / 3 G C4 OB NT	383	21.312.1153.0	6E H / 11	257
15.003.0253.0	8105 B / 2 C3 OB	382	15.304.0458.9	8105 F / 4 G C4 OB NT	383	21.312.1253.0	6E H	257
15.003.0353.0	8105 B / 3 C3 OB	382	15.305.0258.9	8105 F / 2 G C5 OB NT	383	21.313.0153.0	6E H / 1 DS	257
15.003.0453.0	8105 B / 4 C3 OB	382	15.305.0358.9	8105 F / 3 G C5 OB NT	383	21.313.0253.0	6E H / 2 DS	257
15.004.0253.0	8105 B / 2 C4 OB	382	15.305.0458.9	8105 F / 4 G C5 OB NT	383	21.313.0353.0	6E H / 3 DS	257
15.004.0353.0	8105 B / 3 C4 OB	382	15.306.0258.9	8105 F / 2 G C6 OB NT	383	21.313.0453.0	6E H / 4 DS	257
15.004.0453.0	8105 B / 4 C4 OB	382	15.306.0358.9	8105 F / 3 G C6 OB NT	383	21.313.0553.0	6E H / 5 DS	257
15.005.0253.0	8105 B / 2 C5 OB	382	15.306.0458.9	8105 F / 4 G C6 OB NT	383	21.313.0653.0	6E H / 6 DS	257
15.005.0353.0	8105 B / 3 C5 OB	382	15.307.0258.9	8105 F / 2 G C7 OB NT	383	21.313.0753.0	6E H / 7 DS	257
15.005.0453.0	8105 B / 4 C5 OB	382	15.307.0358.9	8105 F / 3 G C7 OB NT	383	21.313.0853.0	6E H / 8 DS	257
15.006.0253.0	8105 B / 2 C6 OB	382	15.311.0258.9	8105 F / 2 W C1 OB NT	383	21.313.0953.0	6E H / 9 DS	257
15.006.0353.0	8105 B / 3 C6 OB GR	382	15.311.0358.9	8105 F / 3 W C1 OB NT	383	21.313.1053.0	6E H / 10 DS	257
15.006.0453.0	8105 B / 4 C6 OB	382	15.311.0458.9	8105 F / 4 W C1 OB NT	383	21.313.1153.0	6E H / 11 DS	257
15.007.0253.0	8105 B / 2 C7 OB	382	15.311.0558.9	8105 F / 5 W C1 OB NT	383	21.313.1253.0	6E H DS	257
15.007.0353.0	8105 B / 3 C7 OB	382	15.311.0658.9	8105 F / 6 W C1 OB NT	383	21.330.5153.0	10E / 1	259
15.010.0253.0	8105 B / 2 C0 VL OB	383	15.311.0758.9	8105 F / 7 W C1 OB NT	383	21.330.5253.0	10E / 2	259
15.010.0353.0	8105 B / 3 C0 VL OB	383	15.312.0258.9	8105 F / 2 W C2 OB NT	383	21.330.5353.0	10E / 3	259
15.010.0453.0	8105 B / 4 C0 VL OB	383	15.312.0358.9	8105 F / 3 W C2 OB NT	383	21.330.5453.0	10E / 4	259
15.010.0553.0	8105 B / 5 C0 VL OB	383	15.312.0458.9	8105 F / 4 W C2 OB NT	383	21.330.5553.0	10E / 5	259
15.010.0653.0	8105 B / 6 C0 VL OB	383	15.312.0558.9	8105 F / 5 W C2 OB NT	383	21.330.5653.0	10E / 6	259
15.010.0753.0	8105 B / 7 C0 VL OB	383	15.312.0658.9	8105 F / 6 W C2 OB NT	383	21.330.5753.0	10E / 7	259

contents

Part no.	Type	section / page	Part no.	Type	section / page	Part no.	Type	section / page
21.330.5853.0	10E / 8	259	25.001.1256.0	LPSTL 1 / 12	330	25.131.0753.0	8190 / 7 OB	358
21.330.5953.0	10E / 9	259	25.001.1356.0	LPSTL 1 / 13	330	25.131.0853.0	8190 / 8 OB	358
21.330.6053.0	10E / 10	259	25.001.1456.0	LPSTL 1 / 14	330	25.131.0953.0	8190 / 9 OB	358
21.330.6253.0	10E	259	25.001.1556.0	LPSTL 1 / 15	330	25.131.1053.0	8190 / 10 OB	358
21.331.5153.0	10E / 1 DS	259	25.001.1656.0	LPSTL 1 / 16	330	25.131.1153.0	8190 / 11 OB	358
21.331.5253.0	10E / 2 DS	259	25.002.0253.0	DST85/ 2	328	25.131.1253.0	8190 / 12 OB	358
21.331.5353.0	10E / 3 DS	259	25.002.0353.0	DST85/ 3	328	25.131.1353.0	8190 / 13 OB	358
21.331.5453.0	10E / 4 DS	259	25.002.0453.0	DST85/ 4	328	25.131.1453.0	8190 / 14 OB	358
21.331.5553.0	10E / 5 DS	259	25.002.0553.0	DST85/ 5	328	25.131.1553.0	8190 / 15 OB	358
21.331.5653.0	10E / 6 DS	259	25.002.0653.0	DST85/ 6	328	25.131.1653.0	8190 / 16 OB	358
21.331.5753.0	10E / 7 DS	259	25.002.0753.0	DST85/ 7	328	25.131.3253.0	8190 E / 2 / 4 OB	368
21.331.5853.0	10E / 8 DS	259	25.002.0853.0	DST85/ 8	328	25.131.3353.0	8190 E / 3 / 6 OB	368
21.331.5953.0	10E / 9 DS	259	25.002.0953.0	DST85/ 9	328	25.131.3453.0	8190 E / 4 / 8 OB	368
21.331.6053.0	10E / 10 DS	259	25.002.1053.0	DST85/10	328	25.131.3553.0	8190 E / 5 / 10 OB	368
21.331.6253.0	10E DS	259	25.002.1153.0	DST85/11	328	25.131.3653.0	8190 E / 6 / 12 OB	368
21.340.3153.0	20E / 1	259	25.002.1253.0	DST85/12	328	25.131.3753.0	8190 E / 7 / 14 OB	368
21.340.3253.0	20E / 2	259	25.003.0253.0	DST85/ 2 OB	328	25.131.3853.0	8190 E / 8 / 16 OB	368
21.340.3353.0	20E / 3	259	25.003.0353.0	DST85/ 3 OB	328	25.131.3953.0	8190 E / 9 / 18 OB	368
21.340.3453.0	20E / 4	259	25.003.0453.0	DST85/ 4 OB	328	25.131.4053.0	8190 E / 10 / 20 OB	368
21.340.3553.0	20E / 5	259	25.003.0553.0	DST85/ 5 OB	328	25.131.4153.0	8190 E / 11 / 22 OB	368
21.340.3653.0	20E / 6	259	25.003.0653.0	DST85/ 6 OB	328	25.131.4253.0	8190 E / 12 / 24 OB	368
21.340.3753.0	20E / 7	259	25.003.0753.0	DST85/ 7 OB	328	25.132.0253.0	8190 / 4 / 2	358
21.340.3853.0	20E / 8	259	25.003.0853.0	DST85/ 8 OB	328	25.132.0353.0	8190 / 6 / 3	358
21.340.3953.0	20E / 9	259	25.003.0953.0	DST85/ 9 OB	328	25.132.0453.0	8190 / 8 / 4	358
21.340.4053.0	20E / 10	259	25.003.1053.0	DST85/10 OB	328	25.132.0553.0	8190 / 10 / 5	358
21.340.4253.0	20E	259	25.003.1153.0	DST85/11 OB	328	25.132.0653.0	8190 / 12 / 6	358
21.340.5153.0	16E / 1	259	25.003.1253.0	DST85/12 OB	328	25.132.0753.0	8190 / 14 / 7	358
21.340.5253.0	16E / 2	259	25.004.0253.0	DSTLF85/ 2	328	25.132.0853.0	8190 / 16 / 8	358
21.340.5353.0	16E / 3	259	25.004.0353.0	DSTLF85/ 3	328	25.132.0953.0	8190 / 18 / 9	358
21.340.5453.0	16E / 4	259	25.004.0453.0	DSTLF85/ 4	328	25.132.1053.0	8190 / 20 / 10	358
21.340.5553.0	16E / 5	259	25.004.0553.0	DSTLF85/ 5	328	25.132.1153.0	8190 / 22 / 11	358
21.340.5653.0	16E / 6	259	25.004.0653.0	DSTLF85/ 6	328	25.132.1253.0	8190 / 24 / 12	358
21.340.5753.0	16E / 7	259	25.004.0753.0	DSTLF85/ 7	328	25.133.0253.0	8190 / 4 / 2 OB	358
21.340.5853.0	16E / 8	259	25.004.0853.0	DSTLF85/ 8	328	25.133.0353.0	8190 / 6 / 3 OB	358
21.340.5953.0	16E / 9	259	25.004.0953.0	DSTLF85/ 9	328	25.133.0453.0	8190 / 8 / 4 OB	358
21.340.6053.0	16E / 10	259	25.004.1053.0	DSTLF85/10	328	25.133.0553.0	8190 / 10 / 5 OB	358
21.340.6253.0	16E	259	25.004.1153.0	DSTLF85/11	328	25.133.0653.0	8190 / 12 / 6 OB	358
21.341.3153.0	20E / 1 DS	259	25.004.1253.0	DSTLF85/12	328	25.133.0753.0	8190 / 14 / 7 OB	358
21.341.3253.0	20E / 2 DS	259	25.005.0253.0	DSTLF85/ 2 OB	328	25.133.0853.0	8190 / 16 / 8 OB	358
21.341.3353.0	20E / 3 DS	259	25.005.0353.0	DSTLF85/ 3 OB	328	25.133.0953.0	8190 / 18 / 9 OB	358
21.341.3453.0	20E / 4 DS	259	25.005.0453.0	DSTLF85/ 4 OB	328	25.133.1053.0	8190 / 20 / 10 OB	358
21.341.3553.0	20E / 5 DS	259	25.005.0553.0	DSTLF85/ 5 OB	328	25.133.1153.0	8190 / 22 / 11 OB	358
21.341.3653.0	20E / 6 DS	259	25.005.0653.0	DSTLF85/ 6 OB	328	25.133.1253.0	8190 / 24 / 12 OB	358
21.341.3753.0	20E / 7 DS	259	25.005.0753.0	DSTLF85/ 7 OB	328	25.150.0253.0	8390 / 2	359
21.341.3853.0	20E / 8 DS	259	25.005.0853.0	DSTLF85/ 8 OB	328	25.150.0353.0	8390 / 3	359
21.341.3953.0	20E / 9 DS	259	25.005.0953.0	DSTLF85/ 9 OB	328	25.150.0453.0	8390 / 4	359
21.341.4053.0	20E / 10 DS	259	25.005.1053.0	DSTLF85/10 OB	328	25.150.0553.0	8390 / 5	359
21.341.4253.0	20E DS	259	25.005.1153.0	DSTLF85/11 OB	328	25.150.0653.0	8390 / 6	359
21.341.5153.0	16E / 1 DS	259	25.005.1253.0	DSTLF85/12 OB	328	25.150.0753.0	8390 / 7	359
21.341.5253.0	16E / 2 DS	259	25.010.0256.0	LPST 1 / 2 OB	330	25.150.0853.0	8390 / 8	359
21.341.5353.0	16E / 3 DS	259	25.010.0356.0	LPST 1 / 3 OB	330	25.150.0953.0	8390 / 9	359
21.341.5453.0	16E / 4 DS	259	25.010.0456.0	LPST 1 / 4 OB	330	25.150.1053.0	8390 / 10	359
21.341.5553.0	16E / 5 DS	259	25.010.0556.0	LPST 1 / 5 OB	330	25.150.1153.0	8390 / 11	359
21.341.5653.0	16E / 6 DS	259	25.010.0656.0	LPST 1 / 6 OB	330	25.150.1253.0	8390 / 12	359
21.341.5753.0	16E / 7 DS	259	25.010.0756.0	LPST 1 / 7 OB	330	25.151.0253.0	8390 / 2 OB	359
21.341.5853.0	16E / 8 DS	259	25.010.0856.0	LPST 1 / 8 OB	330	25.151.0353.0	8390 / 3 OB	359
21.341.5953.0	16E / 9 DS	259	25.010.0956.0	LPST 1 / 9 OB	330	25.151.0453.0	8390 / 4 OB	359
21.341.6053.0	16E / 10 DS	259	25.010.1056.0	LPST 1 / 10 OB	330	25.151.0553.0	8390 / 5 OB	359
21.341.6253.0	16E DS	259	25.010.1156.0	LPST 1 / 11 OB	330	25.151.0653.0	8390 / 6 OB	359
22.310.0153.0	6ES / 1	258	25.010.1256.0	LPST 1 / 12 OB	330	25.151.0753.0	8390 / 7 OB	359
22.310.0253.0	6ES / 2	258	25.010.1356.0	LPST 1 / 13 OB	330	25.151.0853.0	8390 / 8 OB	359
22.310.0353.0	6ES / 3	258	25.010.1456.0	LPST 1 / 14 OB	330	25.151.0953.0	8390 / 9 OB	359
22.310.0453.0	6ES / 4	258	25.010.1556.0	LPST 1 / 15 OB	330	25.151.1053.0	8390 / 10 OB	359
22.310.0553.0	6ES / 5	258	25.010.1656.0	LPST 1 / 16 OB	330	25.151.1153.0	8390 / 11 OB	359
22.310.0653.0	6ES / 6	258	25.130.0253.0	8190 / 2	358	25.151.1253.0	8390 / 12 OB	359
22.310.0753.0	6ES / 7	258	25.130.0353.0	8190 / 3	358	25.153.0253.0	8195 D/ 2/6	372
22.310.0853.0	6ES / 8	258	25.130.0453.0	8190 / 4	358	25.153.0353.0	8195 D/ 3/9	372
22.310.0953.0	6ES / 9	258	25.130.0553.0	8190 / 5	358	25.153.0453.0	8195 D/ 4/12	372
22.310.1053.0	6ES / 10	258	25.130.0653.0	8190 / 6	358	25.153.0553.0	8195 D/ 5/15	372
22.310.1253.0	6ES	258	25.130.0753.0	8190 / 7	358	25.153.0653.0	8195 D/ 6/18	372
25.000.0256.0	LPST 1 / 2	330	25.130.0853.0	8190 / 8	358	25.153.0753.0	8195 D/ 7/21	372
25.000.0356.0	LPST 1 / 3	330	25.130.0953.0	8190 / 9	358	25.153.0853.0	8195 D/ 8/24	372
25.000.0456.0	LPST 1 / 4	330	25.130.1053.0	8190 / 10	358	25.153.0953.0	8195 D/ 9/27	372
25.000.0556.0	LPST 1 / 5	330	25.130.1153.0	8190 / 11	358	25.153.1053.0	8195 D/ 10/30	372
25.000.0656.0	LPST 1 / 6	330	25.130.1253.0	8190 / 12	358	25.153.2253.0	8195 D/ 2/6 OB	372
25.000.0756.0	LPST 1 / 7	330	25.130.1353.0	8190 / 13	358	25.153.2353.0	8195 D/ 3/9 OB	372
25.000.0856.0	LPST 1 / 8	330	25.130.1453.0	8190 / 14	358	25.153.2453.0	8195 D/ 4/12 OB	372
25.000.0956.0	LPST 1 / 9	330	25.130.1553.0	8190 / 15	358	25.153.2553.0	8195 D/ 5/15 OB	372
25.000.1056.0	LPST 1 / 10	330	25.130.1653.0	8190 / 16	358	25.153.2653.0	8195 D/ 6/18 OB	372
25.000.1156.0	LPST 1 / 11	330	25.130.3253.0	8190 E / 2 / 4	368	25.153.2753.0	8195 D/ 7/21 OB	372
25.000.1256.0	LPST 1 / 12	330	25.130.3353.0	8190 E / 3 / 6	368	25.153.2853.0	8195 D/ 8/24 OB	372
25.000.1356.0	LPST 1 / 13	330	25.130.3453.0	8190 E / 4 / 8	368	25.153.2953.0	8195 D/ 9/27 OB	372
25.000.1456.0	LPST 1 / 14	330	25.130.3553.0	8190 E / 5 / 10	368	25.153.3053.0	8195 D/ 10/30 OB	372
25.000.1556.0	LPST 1 / 15	330	25.130.3653.0	8190 E / 6 / 12	368	25.153.4253.0	8195 D/ 2/6 V81	372
25.000.1656.0	LPST 1 / 16	330	25.130.3753.0	8190 E / 7 / 14	368	25.153.4353.0	8195 D/ 3/9 V81	372
25.001.0256.0	LPSTL 1 / 2	330	25.130.3853.0	8190 E / 8 / 16	368	25.153.4453.0	8195 D/ 4/12 V81	372
25.001.0356.0	LPSTL 1 / 3	330	25.130.3953.0	8190 E / 9 / 18	368	25.153.4553.0	8195 D/ 5/15 V81	372
25.001.0456.0	LPSTL 1 / 4	330	25.130.4053.0	8190 E / 10 / 20	368	25.153.4653.0	8195 D/ 6/18 V81	372
25.001.0556.0	LPSTL 1 / 5	330	25.130.4153.0	8190 E / 11 / 22	368	25.153.4753.0	8195 D/ 7/21 V81	372
25.001.0656.0	LPSTL 1 / 6	330	25.130.4253.0	8190 E / 12 / 24	368	25.153.4853.0	8195 D/ 8/24 V81	372
25.001.0756.0	LPSTL 1 / 7	330	25.131.0253.0	8190 / 2 OB	358	25.153.4953.0	8195 D/ 9/27 V81	372
25.001.0856.0	LPSTL 1 / 8	330	25.131.0353.0	8190 / 3 OB	358	25.153.5053.0	8195 D/ 10/30 V81	372
25.001.0956.0	LPSTL 1 / 9	330	25.131.0453.0	8190 / 4 OB	358	25.153.6253.0	8195 D/ 2/6 V81 OB	372
25.001.1056.0	LPSTL 1 / 10	330	25.131.0553.0	8190 / 5 OB	358	25.153.6353.0	8195 D/ 3/9 V81 OB	372
25.001.1156.0	LPSTL 1 / 11	330	25.131.0653.0	8190 / 6 OB	358	25.153.6453.0	8195 D/ 4/12 V81 OB	372

contents of
part number

contents PART NUMBER

Part no.	Type	section / page	Part no.	Type	section / page	Part no.	Type	section / page
25.153.6553.0	8195 D/ 5/15 VB1 OB	372	25.157.0353.0	8191 R / 5/3 Z OB	343	25.162.1053.0	8291 / 10	344
25.153.6653.0	8195 D/ 6/18 VB1 OB	372	25.157.0453.0	8191 R / 7/4 Z OB	343	25.162.1153.0	8291 / 11	344
25.153.6753.0	8195 D/ 7/21 VB1 OB	372	25.157.0553.0	8191 R / 9/5 Z OB	343	25.162.1253.0	8291 / 12	344
25.153.6853.0	8195 D/ 8/24 VB1 OB	372	25.157.0653.0	8191 R / 11/6 Z OB	343	25.162.1353.0	8291 / 13	344
25.153.6953.0	8195 D/ 9/27 VB1 OB	372	25.157.0753.0	8191 R / 13/7 Z OB	343	25.162.1453.0	8291 / 14	344
25.153.7053.0	8195 D/ 10/30 VB1 OB	372	25.157.1253.0	8191 R / 3/2 Z	343	25.162.1553.0	8291 / 15	344
25.154.0253.0	8195 V/ 2/8	373	25.157.1353.0	8191 R / 5/3 Z	343	25.162.1653.0	8291 / 16	344
25.154.0353.0	8195 V/ 3/12	373	25.157.1453.0	8191 R / 7/4 Z	343	25.162.6253.0	8291 / 2 ZW	345
25.154.0453.0	8195 V/ 4/16	373	25.157.1553.0	8191 R / 9/5 Z	343	25.162.6353.0	8291 / 3 ZW	345
25.154.0553.0	8195 V/ 5/20	373	25.157.1653.0	8191 R / 11/6 Z	343	25.162.6453.0	8291 / 4 ZW	345
25.154.0653.0	8195 V/ 6/24	373	25.157.1753.0	8191 R / 13/7 Z	343	25.162.6553.0	8291 / 5 ZW	345
25.154.0753.0	8195 V/ 7/28	373	25.157.4253.0	8291 R / 3/2 Z OB	343	25.162.6653.0	8291 / 6 ZW	345
25.154.0853.0	8195 V/ 8/32	373	25.157.4353.0	8291 R / 5/3 Z OB	343	25.162.6753.0	8291 / 7 ZW	345
25.154.0953.0	8195 V/ 9/36	373	25.157.4453.0	8291 R / 7/4 Z OB	343	25.162.6853.0	8291 / 8 ZW	345
25.154.1053.0	8195 V/ 10/40	373	25.157.4553.0	8291 R / 9/5 Z OB	343	25.162.6953.0	8291 / 9 ZW	345
25.154.2253.0	8195 V/ 2/8 OB	373	25.157.4653.0	8291 R / 11/6 Z OB	343	25.162.7053.0	8291 / 10 ZW	345
25.154.2353.0	81195 V/ 3/12 OB	373	25.157.4753.0	8291R / 13/7 Z OB	343	25.162.7153.0	8291 / 11 ZW	345
25.154.2453.0	8195 V/ 4/16 OB	373	25.157.5253.0	8291 R / 3/2 Z	343	25.162.7253.0	8291 / 12 ZW	345
25.154.2553.0	8195 V/ 5/20 OB	373	25.157.5353.0	8291 R / 5/3 Z	343	25.162.7353.0		345
25.154.2653.0	8195 V/ 6/24 OB	373	25.157.5453.0	8291 R / 7/4 Z	343	25.162.7453.0	8291 / 14 ZW	345
25.154.2753.0	8195 V/ 7/28 OB	373	25.157.5553.0	8291 R / 9/5 Z	343	25.162.7553.0	8291 / 15 ZW	345
25.154.2853.0	8195 V/ 8/32 OB	373	25.157.5653.0	8291 R / 11/6 Z	343	25.162.7653.0	8291 / 16 ZW	345
25.154.2953.0	8195 V/ 9/36 OB	373	25.157.5753.0	8291 R / 13/7 Z	343	25.163.0253.0	8291 / 2 OB	344
25.154.3053.0	8195 V/ 10/40 OB	373	25.160.0253.0	8191 / 2	344	25.163.0353.0	8291 / 3 OB	344
25.154.4253.0	8195 V/ 2/8 VB1	373	25.160.0353.0	8191 / 3	344	25.163.0453.0	8291 / 4 OB	344
25.154.4353.0	8195 V/ 3/12 VB1	373	25.160.0453.0	8191 / 4	344	25.163.0553.0	8291 / 5 OB	344
25.154.4453.0	8195 V/ 4/16 VB1	373	25.160.0553.0	8191 / 5	344	25.163.0653.0	8291 / 6 OB	344
25.154.4553.0	8195 V/ 5/20 VB1	373	25.160.0653.0	8191 / 6	344	25.163.0753.0	8291 / 7 OB	344
25.154.4653.0	8195 V/ 6/24 VB1	373	25.160.0753.0	8191 / 7	344	25.163.0853.0	8291 / 8 OB	344
25.154.4753.0	8195 V/ 7/28 VB1	373	25.160.0853.0	8191 / 8	344	25.163.0953.0	8291 / 9 OB	344
25.154.4853.0	8195 V/ 8/32 VB1	373	25.160.0953.0	8191 / 9	344	25.163.1053.0	8291 / 10 OB	344
25.154.4953.0	8195 V/ 9/36 VB1	373	25.160.1053.0	8191 / 10	344	25.163.1153.0	8291 / 11 OB	344
25.154.5053.0	8195 V/ 10/40 VB1	373	25.160.1153.0	8191 / 11	344	25.163.1253.0	8291 / 12 OB	344
25.154.6253.0	8195 V/ 2/8 VB1 OB	373	25.160.1253.0	8191 / 12	344	25.163.1353.0	8291 / 13 OB	344
25.154.6353.0	8195 V/ 3/12 VB1 OB	373	25.160.1353.0	8191 / 13	344	25.163.1453.0	8291 / 14 OB	344
25.154.6453.0	8195 V/ 4/16 VB1 OB	373	25.160.1453.0	8191 / 14	344	25.163.1553.0	8291 / 15 OB	344
25.154.6553.0	8195 V/ 5/20 VB1 OB	373	25.160.1553.0	8191 / 15	344	25.163.1653.0	8291 / 16 OB	344
25.154.6653.0	8195 V/ 6/24 VB1 OB	373	25.160.1653.0	8191 / 16	344	25.163.6253.0	8291 / 2 ZW OB	345
25.154.6753.0	8195 V/ 7/28 VP1 OB	373	25.160.6253.0	8191 / 2 ZW	345	25.163.6353.0	8291 / 3 ZW OB	345
25.154.6853.0	8195 V/ 8/32 VB1 OB	373	25.160.6353.0	8191 / 3 ZW	345	25.163.6453.0	8291 / 4 ZW OB	345
25.154.6953.0	8195 V/ 9/36 VB1 OB	373	25.160.6453.0	8191 / 4 ZW	345	25.163.6553.0	8291 / 5 ZW OB	345
25.154.7053.0	8591 V/ 10/40 VB1 OB	373	25.160.6553.0	8191 / 5 ZW	345	25.163.6653.0	8291 / 6 ZW OB	345
25.155.0253.0	8191 R / 2 Z OB	342	25.160.6653.0	8191 / 6 ZW	345	25.163.6753.0	8291 / 7 ZW OB	345
25.155.0353.0	8191 R / 3 Z OB	342	25.160.6753.0	8191 / 7 ZW	345	25.163.6853.0	8291 / 8 ZW OB	345
25.155.0453.0	8191 R / 4 Z OB	342	25.160.6853.0	8191 / 8 ZW	345	25.163.6953.0	8291 / 9 ZW OB	345
25.155.0553.0	8191 R / 5 Z OB	342	25.160.6953.0	8191 / 9 ZW	345	25.163.7053.0	8291 / 10 ZW OB	345
25.155.0653.0	8191 R / 6 Z OB	342	25.160.7053.0	8191 / 10 ZW	345	25.163.7153.0	8291 / 11 ZW OB	345
25.155.0753.0	8191 R / 7 Z OB	342	25.160.7153.0	8191 / 11 ZW	345	25.163.7253.0	8291 / 12 ZW OB	345
25.155.0853.0	8191 R / 8 Z OB	342	25.160.7253.0	8191 / 12 ZW	345	25.163.7353.0	8291 / 13 ZW OB	345
25.155.0953.0	8191 R / 9 Z OB	342	25.160.7353.0	8191 / 13 ZW	345	25.163.7453.0	8291 / 14 ZW OB	345
25.155.1053.0	8191 R / 10 Z OB	342	25.160.7453.0	8191 / 14 ZW	345	25.163.7553.0	8291 / 15 ZW OB	345
25.155.1153.0	8191 R / 11 Z OB	342	25.160.7553.0	8191 / 15 ZW	345	25.163.7653.0	8291 / 16 ZW OB	345
25.155.1253.0	8191 R / 12 Z OB	342	25.160.7653.0	8191 / 16 ZW	345	25.164.0253.0	8391 / 2	346
25.155.1353.0	8191 R / 13 Z OB	342	25.161.0253.0	8191 / 2 OB	344	25.164.0353.0	8391 / 3	346
25.155.1453.0	8191 R / 14 Z OB	342	25.161.0353.0	8191 / 3 OB	344	25.164.3253.0	8391 / 2 Z	347
25.155.2253.0	8191 R / 2 Z	342	25.161.0453.0	8191 / 4 OB	344	25.164.3353.0	8391 / 3 Z	347
25.155.2353.0	8191 R / 3 Z	342	25.161.0553.0	8191 / 5 OB	344	25.164.6253.0	8391 / 2 ZW	347
25.155.2453.0	8191 R / 4 Z	342	25.161.0653.0	8191 / 6 OB	344	25.164.6353.0	8391 / 3 ZW	347
25.155.2553.0	8191 R / 5 Z	342	25.161.0753.0	8191 / 7 OB	344	25.165.0253.0	8391 / 2 OB	346
25.155.2653.0	8191 R / 6 Z	342	25.161.0853.0	8191 / 8 OB	344	25.165.0353.0	8391 / 3 OB	346
25.155.2753.0	8191 R / 7 Z	342	25.161.0953.0	8191 / 9 OB	344	25.165.3253.0	8391 / 2 Z OB	346
25.155.2853.0	8191 R / 8 Z	342	25.161.1053.0	8191 / 10 OB	344	25.165.3353.0	8391 / 3 Z OB	346
25.155.2953.0	8191 R / 9 Z	342	25.161.1153.0	8191 / 11 OB	344	25.165.6253.0	8391 / 2 ZW OB	347
25.155.3053.0	8191 R / 10 Z	342	25.161.1253.0	8191 / 12 OB	344	25.165.6353.0	8391 / 3 ZW OB	347
25.155.3153.0	8191 R / 11 Z	342	25.161.1353.0	8191 / 13 OB	344	25.166.0253.0	8491 / 2	346
25.155.3253.0	8191 R / 12 Z	342	25.161.1453.0	8191 / 14 OB	344	25.166.0353.0	8491 / 3	346
25.155.3353.0	8191 R / 13 Z	342	25.161.1553.0	8191 / 15 OB	344	25.166.3253.0	8491 / 2 Z	347
25.155.3453.0	8191 R / 14 Z	342	25.161.1653.0	8191 / 16 OB	344	25.166.3353.0	8491 / 3 Z	347
25.156.0253.0	8291 R / 2 Z OB	342	25.161.2553.0	8191 / 2 WVR OB	594	25.166.6253.0	8491 / 2 ZW	347
25.156.0353.0	8291 R / 3 Z OB	342	25.161.2653.0	8191 / 3 WVR OB	594	25.166.6353.0	8491 / 3 ZW	347
25.156.0453.0	8291 R / 4 Z OB	342	25.161.2853.0	8191 / 2 WVL OB	594	25.167.0253.0	8491 / 2 OB	346
25.156.0553.0	8291 R / 5 Z OB	342	25.161.2953.0	8191 / 3 WVL OB	594	25.167.0353.0	8491 / 3 OB	346
25.156.0653.0	8291 R / 6 Z OB	342	25.161.6253.0	8191 / 2 ZW OB	345	25.167.3253.0	8491 / 2 Z OB	346
25.156.0753.0	8291 R / 7 Z OB	342	25.161.6353.0	8191 / 3 ZW OB	345	25.167.3353.0	8491 / 3 Z OB	346
25.156.0853.0	8291 R / 8 Z OB	342	25.161.6453.0	8191 / 4 ZW OB	345	25.167.6253.0	8491 / 2 ZW OB	347
25.156.0953.0	8291 R / 9 Z OB	342	25.161.6553.0	8191 / 5 ZW OB	345	25.167.6353.0	8491 / 3 ZW OB	347
25.156.1053.0	8291 R / 10 Z OB	342	25.161.6653.0	8191 / 6 ZW OB	345	25.168.0253.0	8191 / 3/ 2	344
25.156.1153.0	8291 R / 11 Z OB	342	25.161.6753.0	8191 / 7 ZW OB	345	25.168.0353.0	8191 / 5/ 3	344
25.156.1253.0	8291 R / 12 Z OB	342	25.161.6853.0	8191 / 8 ZW OB	345	25.168.2253.0	8191 / 3/ 2 Z	345
25.156.1353.0	8291 R / 13 Z OB	342	25.161.6953.0	8191 / 9 ZW OB	345	25.168.2353.0	8191 / 5/ 3 Z	345
25.156.1453.0	8291 R / 14 Z OB	342	25.161.7053.0	8191 / 10 ZW OB	345	25.168.4253.0	8191 / 3/ 2 ZW	345
25.156.2253.0	8291 R / 2 Z	342	25.161.7153.0	8191 / 11 ZW OB	345	25.168.4353.0	8191 / 5/ 3 ZW	345
25.156.2353.0	8291 R / 3 Z	342	25.161.7253.0	8191 / 12 ZW OB	345	25.168.6253.0	8191 / 3/ 2 ZW	344
25.156.2453.0	8291 R / 4 Z	342	25.161.7353.0	8191 / 13 ZW OB	345	25.168.6353.0	8191 / 5/ 3 ZW	344
25.156.2553.0	8291 R / 5 Z	342	25.161.7453.0	8191 / 14 ZW OB	345	25.169.0253.0	8191 / 3/ 2 OB	344
25.156.2653.0	8291 R / 6 Z	342	25.161.7553.0	8191 / 15 ZW OB	345	25.169.0353.0	8191 / 5/ 3 OB	344
25.156.2753.0	8291 R / 7 Z	342	25.161.7653.0	8191 / 16 ZW OB	345	25.169.2253.0	8191 / 3/ 2 Z OB	345
25.156.2853.0	8291 R / 8 Z	342	25.162.0253.0	8291 / 2	344	25.169.2353.0	8191 / 5/ 3 Z OB	345
25.156.2953.0	8291 R / 9 Z	342	25.162.0353.0	8291 / 3	344	25.169.4253.0	8191 / 3/ 2 ZW OB	345
25.156.3053.0	8291 R / 10 Z	342	25.162.0453.0	8291 / 4	344	25.169.4353.0	8191 / 5/ 3 ZW OB	345
25.156.3153.0	8291 R / 11 Z	342	25.162.0553.0	8291 / 5	344	25.169.6253.0	8191 / 3/ 2 ZW OB	344
25.156.3253.0	8291 R / 12 Z	342	25.162.0653.0	8291 / 6	344	25.169.6353.0	8191 / 5/ 3 ZW OB	344
25.156.3353.0	8291 R / 13 Z	342	25.162.0753.0	8291 / 7	344	25.170.0253.0	8191 / 2 ZN	344
25.156.3453.0	8291 R / 14 Z	342	25.162.0853.0	8291 / 8	344	25.170.0353.0	8191 / 3 ZN	344
25.157.0253.0	8191 R / 3/ 2 Z OB	343	25.162.0953.0	8291 / 9	344	25.171.0253.0	8191 / 2 ZN OB	344

contents

Part no.	Type	section / page	Part no.	Type	section / page	Part no.	Type	section / page
25.171.0353.0	8191 / 3 ZN OB	344	25.181.0653.0	8291 D / 6 / 18	370	25.193.0953.0	8292 / 9 OB	338
25.172.0253.0	8291 / 2 ZN	344	25.181.0753.0	8291 D / 7 / 21	370	25.193.1053.0	8292 / 10 OB	338
25.172.0353.0	8291 / 3 ZN	344	25.181.0853.0	8291 D / 8 / 24	370	25.193.1153.0	8292 / 11 OB	338
25.173.0253.0	8291 / 2 ZN OB	344	25.181.0953.0	8291 D / 9 / 27	370	25.193.1253.0	8292 / 12 OB	338
25.173.0353.0	8291 / 3 ZN OB	344	25.181.1053.0	8291 D / 10 / 30	370	25.193.1353.0	8292 / 13 OB	338
25.174.0253.0	8391 / 2 ZN	347	25.181.1153.0	8291 D / 11 / 33	370	25.193.1453.0	8292 / 14 OB	338
25.174.0353.0	8391 / 3 ZN	347	25.181.1253.0	8291 D / 12 / 36	370	25.193.1553.0	8292 / 15 OB	338
25.175.0253.0	8391 / 2 ZN OB	346	25.181.1253.0	8291 D / 2 / 6 ZN	370	25.193.1653.0	8292 / 16 OB	338
25.175.0353.0	8391 / 3 ZN OB	346	25.181.4353.0	8291 D / 3 / 9 ZN	370	25.193.6253.0	8292 / 2 ZW OB	339
25.176.0253.0	8491 / 2 ZN	347	25.181.5253.0	8291 D / 2 / 6 OB	370	25.193.6353.0	8292 / 3 ZW OB	339
25.176.0353.0	8491 / 3 ZN	347	25.181.5353.0	8291 D / 3 / 9 OB	370	25.193.6453.0	8292 / 4 ZW OB	339
25.177.0253.0	8491 / 2 ZN OB	346	25.181.5453.0	8291 D / 4 / 12 OB	370	25.193.6553.0	8292 / 5 ZW OB	339
25.177.0353.0	8491 / 3 ZN OB	346	25.181.5553.0	8291 D / 5 / 15 OB	370	25.193.6653.0	8292 / 6 ZW OB	339
25.178.0253.0	8191 E / 2 / 4	366	25.181.5653.0	8291 D / 6 / 18 OB	370	25.193.6753.0	8292 / 7 ZW OB	339
25.178.0353.0	8191 E / 3 / 6	366	25.181.5753.0	8291 D / 7 / 21 OB	370	25.193.6853.0	8292 / 8 ZW OB	339
25.178.0453.0	8191 E / 4 / 8	366	25.181.5853.0	8291 D / 8 / 24 OB	370	25.193.6953.0	8292 / 9 ZW OB	339
25.178.0553.0	8191 E / 5 / 10	366	25.181.5953.0	8291 D / 9 / 27 OB	370	25.193.7053.0	8292 / 10 ZW OB	339
25.178.0653.0	8191 E / 6 / 12	366	25.181.6053.0	8291 D / 10 / 30 OB	370	25.193.7153.0	8292 / 11 ZW OB	339
25.178.0753.0	8191 E / 7 / 14	366	25.181.6153.0	8291 D / 11 / 33 OB	370	25.193.7253.0	8292 / 12 ZW OB	339
25.178.0853.0	8191 E / 8 / 16	366	25.181.6253.0	8291 D / 12 / 36 OB	370	25.193.7353.0	8292 / 13 ZW OB	339
25.178.0953.0	8191 E / 9 / 18	366	25.181.9253.0	8291 D / 2 / 6 ZN OB	370	25.193.7453.0	8292 / 14 ZW OB	339
25.178.1053.0	8191 E / 10 / 20	366	25.181.9353.0	8291 D / 3 / 9 ZN OB	370	25.193.7553.0	8292 / 15 ZW OB	339
25.178.1153.0	8191 E / 11 / 22	366	25.190.0253.0	8192 / 2	338	25.193.7653.0	8292 / 16 ZW OB	339
25.178.1253.0	8191 E / 12 / 24	366	25.190.0353.0	8192 / 3	338	25.193.9253.0	8292 / 2 ZN OB	338
25.178.4253.0	8191 E / 2 / 4 ZN	366	25.190.0453.0	8192 / 4	338	25.193.9353.0	8292 / 3 ZN OB	338
25.178.4353.0	8191 E / 3 / 6 ZN	366	25.190.0553.0	8192 / 5	338	25.194.0253.0	8593 / 2	336
25.178.5253.0	8191 E / 2 / 4 OB	366	25.190.0653.0	8192 / 6	338	25.194.0353.0	8593 / 3	336
25.178.5353.0	8191 E / 3 / 6 OB	366	25.190.0753.0	8192 / 7	338	25.194.0453.0	8593 / 4	336
25.178.5453.0	8191 E / 4 / 8 OB	366	25.190.0853.0	8192 / 8	338	25.194.0553.0	8593 / 5	336
25.178.5553.0	8191 E / 5 / 10 OB	366	25.190.0953.0	8192 / 9	338	25.194.0653.0	8593 / 6	336
25.178.5653.0	8191 E / 6 / 12 OB	366	25.190.1053.0	8192 / 10	338	25.194.0753.0	8593 / 7	336
25.178.5753.0	8191 E / 7 / 14 OB	366	25.190.1153.0	8192 / 11	338	25.194.0853.0	8593 / 8	336
25.178.5853.0	8191 E / 8 / 16 OB	366	25.190.1253.0	8192 / 12	338	25.194.0953.0	8593 / 9	336
25.178.5953.0	8191 E / 9 / 18 OB	366	25.190.1353.0	8192 / 13	338	25.194.1053.0	8593 / 10	336
25.178.6053.0	8191 E / 10 / 20 OB	366	25.190.1453.0	8192 / 14	338	25.194.1153.0	8593 / 11	336
25.178.6153.0	8191 E / 11 / 22 OB	366	25.190.1553.0	8192 / 15	338	25.194.1253.0	8593 / 12	336
25.178.6253.0	8191 E / 12 / 24 OB	366	25.190.1653.0	8192 / 16	338	25.194.1353.0	8593 / 13	336
25.178.9253.0	8191 E / 2 / 4 ZN OB	366	25.190.9253.0	8192 / 2 ZN	338	25.194.1453.0	8593 / 14	336
25.178.9353.0	8191 E / 3 / 6 ZN OB	366	25.190.9353.0	8192 / 3 ZN	338	25.194.1553.0	8593 / 15	336
25.179.0253.0	8291 E / 2 / 4	366	25.191.0253.0	8192 / 2 OB	338	25.194.1653.0	8593 / 16	336
25.179.0353.0	8291 E / 3 / 6	366	25.191.0353.0	8192 / 3 OB	338	25.194.9253.0	8593 / 2 ZN	336
25.179.0453.0	8291 E / 4 / 8	366	25.191.0453.0	8192 / 4 OB	338	25.194.9353.0	8593 / 3 ZN	336
25.179.0553.0	8291 E / 5 / 10	366	25.191.0553.0	8192 / 5 OB	338	25.195.0253.0	8593 / 2 OB	336
25.179.0653.0	8291 E / 6 / 12	366	25.191.0653.0	8192 / 6 OB	338	25.195.0353.0	8593 / 3 OB	336
25.179.0753.0	8291 E / 7 / 12	366	25.191.0753.0	8192 / 7 OB	338	25.195.0453.0	8593 / 4 OB	336
25.179.0853.0	8291 E / 8 / 16	366	25.191.0853.0	8192 / 8 OB	338	25.195.0553.0	8593 / 5 OB	336
25.179.0953.0	8291 E / 9 / 18	366	25.191.0953.0	8192 / 9 OB	338	25.195.0653.0	8593 / 6 OB	336
25.179.1053.0	8291 E / 10 / 20	366	25.191.1053.0	8192 / 10 OB	338	25.195.0753.0	8593 / 7 OB	336
25.179.1153.0	8291 E / 11 / 22	366	25.191.1153.0	8192 / 11 OB	338	25.195.0853.0	8593 / 8 OB	336
25.179.1253.0	8291 E / 12 / 24	366	25.191.1253.0	8192 / 12 OB	338	25.195.0953.0	8593 / 9 OB	336
25.179.4253.0	8291 E / 2 / 4 ZN	366	25.191.1353.0	8192 / 13 OB	338	25.195.1053.0	8593 / 10 OB	336
25.179.4353.0	8291 E / 3 / 6 ZN	366	25.191.1453.0	8192 / 14 OB	338	25.195.1153.0	8593 / 11 OB	336
25.179.5253.0	8291 E / 2 / 4 OB	366	25.191.1553.0	8192 / 15 OB	338	25.195.1253.0	8593 / 12 OB	336
25.179.5353.0	8291 E / 3 / 6 OB	366	25.191.1653.0	8192 / 16 OB	338	25.195.1353.0	8593 / 13 OB	336
25.179.5453.0	8291 E / 4 / 8 OB	366	25.191.6253.0	8192 / 2 ZW OB	339	25.195.1453.0	8593 / 14 OB	336
25.179.5553.0	8291 E / 5 / 10 OB	366	25.191.6353.0	8192 / 3 ZW OB	339	25.195.1553.0	8593 / 15 OB	336
25.179.5653.0	8291 E / 6 / 12 OB	366	25.191.6453.0	8192 / 4 ZW OB	339	25.195.1653.0	8593 / 16 OB	336
25.179.5753.0	8291 E / 7 / 14 OB	366	25.191.6553.0	8192 / 5 ZW OB	339	25.195.9253.0	8593 / 2 ZN OB	336
25.179.5853.0	8291 E / 8 / 16 OB	366	25.191.6653.0	8192 / 6 ZW OB	339	25.195.9353.0	8593 / 3 ZN OB	336
25.179.5953.0	8291 E / 9 / 18 OB	366	25.191.6753.0	8192 / 7 ZW OB	339	25.196.0253.0	8893 / 2	336
25.179.6053.0	8291 E / 10 / 20 OB	366	25.191.6853.0	8192 / 8 ZW OB	339	25.196.0353.0	8893 / 3	336
25.179.6153.0	8291 E / 11 / 22 OB	366	25.191.6953.0	8192 / 9 ZW OB	339	25.196.0453.0	8893 / 4	336
25.179.6253.0	8291 E / 12 / 24 OB	366	25.191.7053.0	8192 / 10 ZW OB	339	25.196.0553.0	8893 / 5	336
25.179.9253.0	8291 E / 2 / 4 ZN OB	366	25.191.7153.0	8192 / 11 ZW OB	339	25.196.0653.0	8893 / 6	336
25.179.9353.0	8291 E / 3 / 6 ZN OB	366	25.191.7253.0	8192 / 12 ZW OB	339	25.196.0753.0	8893 / 7	336
25.180.0253.0	8191 D / 2 / 6	370	25.191.7353.0	8192 / 13 ZW OB	339	25.196.0853.0	8893 / 8	336
25.180.0353.0	8191 D / 3 / 9	370	25.191.7453.0	8192 / 14 ZW OB	339	25.196.0953.0	8893 / 9	336
25.180.0453.0	8191 D / 4 / 12	370	25.191.7553.0	8192 / 15 ZW OB	339	25.196.1053.0	8893 / 10	336
25.180.0553.0	8191 D / 5 / 15	370	25.191.7653.0	8192 / 16 ZW OB	339	25.196.1153.0	8893 / 11	336
25.180.0653.0	8191 D / 6 / 18	370	25.191.9253.0	8192 / 2 ZN OB	338	25.196.1253.0	8893 / 12	336
25.180.0753.0	8191 D / 7 / 21	370	25.191.9353.0	8192 / 3 ZN OB	338	25.196.1353.0	8893 / 13	336
25.180.0853.0	8191 D / 8 / 24	370	25.192.0253.0	8292 / 2	338	25.196.1453.0	8893 / 14	336
25.180.0953.0		370	25.192.0353.0	8292 / 3	338	25.196.1553.0	8893 / 15	336
25.180.1053.0	8191 D / 10 / 30	370	25.192.0453.0	8292 / 4	338	25.196.1653.0	8893 / 16	336
25.180.1153.0	8191 D / 11 / 33	370	25.192.0553.0	8292 / 5	338	25.196.9253.0	8893 / 2 ZN	336
25.180.1253.0	8191 D / 12 / 36	370	25.192.0653.0	8292 / 6	338	25.196.9353.0	8893 / 3 ZN	336
25.180.4253.0	8191 D / 2 / 6 ZN	370	25.192.0753.0	8292 / 7	338	25.197.0253.0	8893 / 2 OB	336
25.180.4353.0	8191 D / 3 / 9 ZN	370	25.192.0853.0	8292 / 8	338	25.197.0353.0	8893 / 3 OB	336
25.180.5253.0	8191 D / 2 / 6 OB	370	25.192.0953.0	8292 / 9	338	25.197.0453.0	8893 / 4 OB	336
25.180.5353.0	8191 D / 3 / 9 OB	370	25.192.1053.0	8292 / 10	338	25.197.0553.0	8893 / 5 OB	336
25.180.5453.0	8191 D / 4 / 12 OB	370	25.192.1153.0	8292 / 11	338	25.197.0653.0	8893 / 6 OB	336
25.180.5553.0	8191 D / 5 / 15 OB	370	25.192.1253.0	8292 / 12	338	25.197.0753.0	8893 / 7 OB	336
25.180.5653.0	8191 D / 6 / 18 OB	370	25.192.1353.0	8292 / 13	338	25.197.0853.0	8893 / 8 OB	336
25.180.5753.0	8191 D / 7 / 21 OB	370	25.192.1453.0	8292 / 14	338	25.197.0953.0	8893 / 9 OB	336
25.180.5853.0	8191 D / 8 / 24 OB	370	25.192.1553.0	8292 / 15	338	25.197.1053.0	8893 / 10 OB	336
25.180.5953.0	8191 D / 9 / 27 OB	370	25.192.1653.0	8292 / 16	338	25.197.1153.0	8893 / 11 OB	336
25.180.6053.0	8191 D / 10 / 30 OB	370	25.192.9253.0	8292 / 2 ZN	338	25.197.1253.0	8893 / 12 OB	336
25.180.6153.0	8191 D / 11 / 33 OB	370	25.192.9353.0	8292 / 3 ZN	338	25.197.1353.0	8893 / 13 OB	336
25.180.6253.0	8191 D / 12 / 36 OB	370	25.193.0253.0	8292 / 2 OB	338	25.197.1453.0	8893 / 14 OB	336
25.180.9253.0	8191 D / 2 / 6 ZN OB	370	25.193.0353.0	8292 / 3 OB	338	25.197.1553.0	8893 / 15 OB	336
25.180.9353.0	8191 D / 3 / 9 ZN OB	370	25.193.0453.0	8292 / 4 OB	338	25.197.1653.0	8893 / 16 OB	336
25.181.0253.0	8291 D / 2 / 6	370	25.193.0553.0	8292 / 5 OB	338	25.197.9253.0	8893 / 2 ZN OB	336
25.181.0353.0	8291 D / 3 / 9	370	25.193.0653.0	8292 / 6 OB	338	25.197.9353.0	8893 / 3 ZN OB	336
25.181.0453.0	8291 D / 4 / 12	370	25.193.0753.0	8292 / 7 OB	338	8192 E / 2 / 4	364	
25.181.0553.0	8291 D / 5 / 15	370	25.193.0853.0	8292 / 8 OB	338	8192 E / 3 / 6	364	

contents

Part no.	Type	section / page	Part no.	Type	section / page	Part no.	Type	section / page
25.396.4553.0	8113 S / 15 S1 OB	302	25.471.1053.0		325	25.502.1153.0	8234 / 11	360
25.396.4653.0	8113 S / 16 S1 OB	302	25.471.1153.0		325	25.502.1253.0	8234 / 12	360
25.396.3253.0	8213 S / 2 S OB GR	302	25.471.1253.0	8520 BL / 11 W OB	325	25.502.1353.0	8234 / 13	360
25.396.3353.0	8213 S / 3 S OB GR	302	25.471.1353.0	8520 BL / 13 W OB	325	25.502.1453.0	8234 / 14	360
25.396.3453.0	8213 S / 4 S OB GR	302	25.471.1453.0	8520 BL / 14 W OB	325	25.502.1553.0	8234 / 15	360
25.396.3553.0	8213 S / 5 S OB GR	302	25.471.1553.0	8520 BL / 15 W OB	325	25.502.1653.0	8234 / 16	360
25.396.3653.0	8213 S / 6 S OB GR	302	25.471.1653.0		325	25.502.6253.0	8234 / 2 ZN	360
25.396.3753.0	8213 S / 7 S OB GR	302	25.471.3253.0		325	25.502.6353.0	8234 / 3 ZN	360
25.396.3853.0	8213 S / 8 S OB GR	302	25.471.3353.0		325	25.503.0253.0	8234 / 2 OB	360
25.396.3953.0	8213 S / 9 S OB GR	302	25.471.3453.0		325	25.503.0353.0	8234 / 3 OB	360
25.396.4053.0	8213 S / 10 S OB GR	302	25.471.3553.0		325	25.503.0453.0	8234 / 4 OB	360
25.396.4153.0	8213 S / 11 S OB GR	302	25.471.3653.0	8520 BL / 6 W	325	25.503.0553.0	8234 / 5 OB	360
25.396.4253.0	8213 S / 12 S OB GR	302	25.471.3753.0	8520 BL / 7 W	325	25.503.0653.0	8234 / 6 OB	360
25.396.4353.0	8213 S / 13 S OB GR	302	25.471.3853.0		325	25.503.0753.0	8234 / 7 OB	360
25.396.4453.0	8213 S / 14 S OB GR	302	25.471.3953.0		325	25.503.0853.0	8234 / 8 OB	360
25.396.4553.0	8213 S / 15 S OB GR	302	25.471.4053.0		325	25.503.0953.0	8234 / 9 OB	360
25.396.4653.0	8213 S / 16 S OB GR	302	25.471.4153.0	8520 BL / 11 W	325	25.503.1053.0	8234 / 10 OB	360
25.397.3253.0	8213 S / 2 S1 OB GR	302	25.471.4253.0		325	25.503.1153.0	8234 / 11 OB	360
25.397.3353.0	8213 S / 3 S1 OB GR	302	25.471.4353.0	8520 BL / 13 W	325	25.503.1253.0	8234 / 12 OB	360
25.397.3453.0	8213 S / 4 S1 OB GR	302	25.471.4453.0	8520 BL / 14 W	325	25.503.1353.0	8234 / 13 OB	360
25.397.3553.0	8213 S / 5 S1 OB GR	302	25.471.4553.0	8520 BL / 15 W	325	25.503.1453.0	8234 / 14 OB	360
25.397.3653.0	8213 S / 6 S1 OB GR	302	25.471.4653.0	8520 BL / 16 W	325	25.503.1553.0	8234 / 15 OB	360
25.397.3753.0	8213 S / 7 S1 OB GR	302	25.472.0253.0		325	25.503.1653.0	8234 / 16 OB	360
25.397.3853.0	8213 S / 8 S1 OB GR	302	25.472.0353.0	8520 BL / 3 G OB	325	25.503.6253.0	8234 / 2 ZN OB	360
25.397.3953.0	8213 S / 9 S1 OB GR	302	25.472.0453.0	8520 BL / 4 G OB	325	25.503.6353.0	8234 / 3 ZN OB	360
25.397.4053.0	8213 S / 10 S1 OB GR	302	25.472.0553.0		325	25.520.0253.0	8135 / 2	362
25.397.4153.0	8213 S / 11 S1 OB GR	302	25.472.0653.0	8520 BL / 6 G OB	325	25.520.0353.0	8135 / 3	362
25.397.4253.0	8213 S / 12 S1 OB GR	302	25.472.0753.0	8520 BL / 7 G OB	325	25.520.0453.0	8135 / 4	362
25.397.4353.0	8213 S / 13 S1 OB GR	302	25.472.0853.0		325	25.520.0553.0	8135 / 5	362
25.397.4453.0	8213 S / 14 S1 OB GR	302	25.472.0953.0		325	25.520.0653.0	8135 / 6	362
25.397.4553.0	8213 S / 15 S1 OB GR	302	25.472.1053.0		325	25.520.0753.0	8135 / 7	362
25.397.4653.0	8213 S / 16 S1 OB GR	302	25.472.1153.0	8520 BL / 11 G OB	325	25.520.0853.0	8135 / 8	362
25.398.2253.0	8413 S / 2 WF OB	301	25.472.1253.0		325	25.520.0953.0	8135 / 9	362
25.398.2353.0	8413 S / 3 WF OB	301	25.472.1353.0	8520 BL / 13 G OB	325	25.520.1053.0	8135 / 10	362
25.398.2453.0	8413 S / 4 WF OB	301	25.472.1453.0	8520 BL / 14 G OB	325	25.520.1153.0	8135 / 11	362
25.398.2553.0	8413 S / 5 WF OB	301	25.472.1553.0	8520 BL / 15 G OB	325	25.520.1253.0	8135 / 12	362
25.398.2653.0	8413 S / 6 WF OB	301	25.472.1653.0		325	25.520.1353.0	8135 / 13	362
25.398.2753.0	8413 S / 7 WF OB	301	25.472.3253.0		325	25.520.1453.0	8135 / 14	362
25.398.2853.0	8413 S / 8 WF OB	301	25.472.3353.0		325	25.520.1553.0	8135 / 15	362
25.398.2953.0	8413 S / 9 WF OB	301	25.472.3453.0		325	25.520.1653.0	8135 / 16	362
25.398.3053.0	8413 S / 10 WF OB	301	25.472.3553.0		325	25.520.6253.0	8135 / 2 ZN	362
25.398.3153.0	8413 S / 11 WF OB	301	25.472.3653.0		325	25.520.6353.0	8135 / 3 ZN	362
25.398.3253.0	8413 S / 12 WF OB	301	25.472.3753.0	8520 BL / 7 G	325	25.521.0253.0	8135 / 2 OB	362
25.398.6253.0	8413 S / 2 GF OB	300	25.472.3853.0		325	25.521.0353.0	8135 / 3 OB	362
25.398.6353.0	8413 S / 3 GF OB	300	25.472.3953.0		325	25.521.0453.0	8135 / 4 OB	362
25.398.6453.0	8413 S / 4 GF OB	300	25.472.4053.0		325	25.521.0553.0	8135 / 5 OB	362
25.398.6553.0	8413 S / 5 GF OB	300	25.472.4153.0	8520 BL / 11 G	325	25.521.0653.0	8135 / 6 OB	362
25.398.6653.0	8413 S / 6 GF OB	300	25.472.4253.0		325	25.521.0753.0	8135 / 7 OB	362
25.398.6753.0	8413 S / 7 GF OB	300	25.472.4353.0	8520 BL / 13 G	325	25.521.0853.0	8135 / 8 OB	362
25.398.6853.0	8413 S / 8 GF OB	300	25.472.4453.0	8520 BL / 14 G	325	25.521.0953.0	8135 / 9 OB	362
25.398.6953.0	8413 S / 9 GF OB	300	25.472.4553.0	8520 BL / 15 G	325	25.521.1053.0	8135 / 10 OB	362
25.398.7053.0	8413 S / 10 GF OB	300	25.472.4653.0	8520 BL / 16 G	325	25.521.1153.0	8135 / 11 OB	362
25.398.7153.0	8413 S / 11 GF OB	300	25.500.0253.0	8134 / 2	360	25.521.1253.0	8135 / 12 OB	362
25.398.7253.0	8413 S / 12 GF OB	300	25.500.0353.0	8134 / 3	360	25.521.1353.0	8135 / 13 OB	362
25.399.9853.0	8113 BSK / 2 0,75 OB	392	25.500.0453.0	8134 / 4	360	25.521.1453.0	8135 / 14 OB	362
25.399.9853.5	8113 B / 2 SK0,75 OB	392	25.500.0553.0	8134 / 5	360	25.521.1553.0	8135 / 15 OB	362
25.399.9853.8	8113 B / 2 SK0,75 OB	392	25.500.0653.0	8134 / 6	360	25.521.1653.0	8135 / 16 OB	362
25.470.0253.0	8520 B / 2 OB	324	25.500.0753.0	8134 / 7	360	25.521.6253.0	8135 / 2 ZN OB	362
25.470.0353.0	8520 B / 3 OB	324	25.500.0853.0	8134 / 8	360	25.521.6353.0	8135 / 3 ZN OB	362
25.470.0453.0	8520 B / 4 OB	324	25.500.0953.0	8134 / 9	360	25.522.0253.0	8235 / 2	362
25.470.0553.0	8520 B / 5 OB	324	25.500.1053.0	8134 / 10	360	25.522.0353.0	8235 / 3	362
25.470.0653.0	8520 B / 6 OB	324	25.500.1153.0	8134 / 11	360	25.522.0453.0	8235 / 4	362
25.470.0753.0	8520 B / 7 OB	324	25.500.1253.0	8134 / 12	360	25.522.0553.0	8235 / 5	362
25.470.0853.0	8520 B / 8 OB	324	25.500.1353.0	8134 / 13	360	25.522.0653.0	8235 / 6	362
25.470.0953.0	8520 B / 9 OB	324	25.500.1453.0	134 / 14	360	25.522.0753.0	8235 / 7	362
25.470.1053.0	8520 B / 10 OB	324	25.500.1553.0	8134 / 15	360	25.522.0853.0	8235 / 8	362
25.470.1153.0	8520 B / 11 OB	324	25.500.1653.0	8134 / 16	360	25.522.0953.0	8235 / 9	362
25.470.1253.0	8520 B / 12 OB	324	25.500.6253.0	8134 / 2 ZN	360	25.522.1053.0	8235 / 10	362
25.470.1353.0	8520 B / 13 OB	324	25.500.6353.0	8134 / 3 ZN	360	25.522.1153.0	8235 / 11	362
25.470.1453.0	8520 B / 14 OB	324	25.501.0253.0	8134 / 2 OB	360	25.522.1253.0	8235 / 12	362
25.470.1553.0	8520 B / 15 OB	324	25.501.0353.0	8134 / 3 OB	360	25.522.1353.0	8235 / 13	362
25.470.1653.0	8520 B / 16 OB	324	25.501.0453.0	8134 / 4 OB	360	25.522.1453.0	8235 / 14	362
25.470.3253.0		324	25.501.0553.0	8134 / 5 OB	360	25.522.1553.0	8235 / 15	362
25.470.3353.0	8520 B / 3	324	25.501.0653.0	8134 / 6 OB	360	25.522.1653.0	8235 / 16	362
25.470.3453.0		324	25.501.0753.0	8134 / 7 OB	360	25.522.6253.0	8235 / 2 ZN	362
25.470.3553.0		324	25.501.0853.0	8134 / 8 OB	360	25.522.6353.0	8235 / 3 ZN	362
25.470.3653.0		324	25.501.0953.0	8134 / 9 OB	360	25.523.0253.0	8235 / 2 OB	362
25.470.3753.0	8520 B / 7	324	25.501.1053.0	8134 / 10 OB	360	25.523.0353.0	8235 / 3 OB	362
25.470.3853.0	8520 B / 8	324	25.501.1153.0	8134 / 11 OB	360	25.523.0453.0	8235 / 4 OB	362
25.470.3953.0		324	25.501.1253.0	8134 / 12 OB	360	25.523.0553.0	8235 / 5 OB	362
25.470.4053.0		324	25.501.1353.0	8134 / 13 OB	360	25.523.0653.0	8235 / 6 OB	362
25.470.4153.0	8520 B / 11	324	25.501.1453.0	8134 / 14 OB	360	25.523.0753.0	8235 / 7 OB	362
25.470.4253.0		324	25.501.1553.0	8134 / 15 OB	360	25.523.0853.0	8235 / 8 OB	362
25.470.4353.0	8520 B / 13	324	25.501.1653.0	8134 / 16 OB	360	25.523.0953.0	8235 / 9 OB	362
25.470.4453.0	8520 B / 14	324	25.501.6253.0	8134 / 2 ZN OB	360	25.523.1053.0	8235 / 10 OB	362
25.470.4553.0	8520 B / 15	324	25.501.6353.0	8134 / 3 ZN OB	360	25.523.1153.0	8235 / 11 OB	362
25.470.4653.0	8520 B / 16	324	25.502.0253.0	8234 / 2	360	25.523.1253.0	8235 / 12 OB	362
25.471.0253.0	8520 BL / 2 W OB	325	25.502.0353.0	8234 / 3	360	25.523.1353.0	8235 / 13 OB	362
25.471.0353.0	8520 BL / 3 W OB	325	25.502.0453.0	8234 / 4	360	25.523.1453.0	8235 / 14 OB	362
25.471.0453.0		325	25.502.0553.0	8234 / 5	360	25.523.1553.0	8235 / 15 OB	362
25.471.0553.0		325	25.502.0653.0	8234 / 6	360	25.523.1653.0	8235 / 16 OB	362
25.471.0653.0		325	25.502.0753.0	8234 / 7	360	25.523.6253.0	8235 / 2 ZN OB	362
25.471.0753.0	8520 BL / 7 W OB	325	25.502.0853.0	8234 / 8	360	25.523.6353.0	8235 / 3 ZN OB	362
25.471.0853.0		325	25.502.0953.0	8234 / 9	360	25.600.2253.0	8142 / 2	318
25.471.0953.0		325	25.502.1053.0	8234 / 10	360	25.600.2353.0	8142 / 3	318

contents of
part number

contents PART NUMBER

Part no.	Type	section / page	Part no.	Type	section / page	Part no.	Type	section / page
25.600.2453.0	8142 / 4	318	25.620.4053.0	8813 B / 10 OB	280	25.623.4653.0	8813 B / 16 VR F OB	283
25.600.2553.0	8142 / 5	318	25.620.4153.0	8813 B / 11 OB	280	25.624.0253.0	8813 B / 2 VL	282
25.600.2653.0	8142 / 6	318	25.620.4253.0	8813 B / 12 OB	280	25.624.0353.0	8813 B / 3 VL	282
25.600.2753.0	8142 / 7	318	25.620.4353.0	8813 B / 13 OB	280	25.624.0453.0	8813 B / 4 VL	282
25.600.2853.0	8142 / 8	318	25.620.4453.0	8813 B / 14 OB	280	25.624.0553.0	8813 B / 5 VL	282
25.600.2953.0	8142 / 9	318	25.620.4553.0	8813 B / 15 OB	280	25.624.0653.0	8813 B / 6 VL	282
25.600.3053.0	8142 / 10	318	25.620.4653.0	8813 B / 16 OB	280	25.624.0753.0	8813 B / 7 VL	282
25.600.3153.0	8142 / 11	318	25.621.0253.0	8813 B / 2 F	280	25.624.0853.0	8813 B / 8 VL	282
25.600.3253.0	8142 / 12	318	25.621.0353.0	8813 B / 3 F	280	25.624.0953.0	8813 B / 9 VL	282
25.600.3353.0	8142 / 13	318	25.621.0453.0	8813 B / 4 F	280	25.624.1053.0	8813 B / 10 VL	282
25.600.3453.0	8142 / 14	318	25.621.0553.0	8813 B / 5 F	280	25.624.1153.0	8813 B / 11 VL	282
25.600.3553.0	8142 / 15	318	25.621.0653.0	8813 B / 6 F	280	25.624.1253.0	8813 B / 12 VL	282
25.600.3653.0	8142 / 16	318	25.621.0753.0	8813 B / 7 F	280	25.624.1353.0	8813 B / 13 VL	282
25.600.6353.0	8543 / 2	316	25.621.0853.0	8813 B / 8 F	280	25.624.1453.0	8813 B / 14 VL	282
25.600.6353.0	8543 / 3	316	25.621.0953.0	8813 B / 9 F	280	25.624.1553.0	8813 B / 15 VL	282
25.600.5453.0	8543 / 4	316	25.621.1053.0	8813 B / 10 F	280	25.624.1653.0	8813 B / 16 VL	282
25.600.5553.0	8543 / 5	316	25.621.1153.0	8813 B / 11 F	280	25.624.3253.0	8813 B / 2 VL OB	282
25.600.5653.0	8543 / 6	316	25.621.1253.0	8813 B / 12 F	280	25.624.3353.0	8813 B / 3 VL OB	282
25.600.5753.0	8543 / 7	316	25.621.1353.0	8813 B / 13 F	280	25.624.3453.0	8813 B / 4 VL OB	282
25.600.5853.0	8543 / 8	316	25.621.1453.0	8813 B / 14 F	280	25.624.3553.0	8813 B / 5 VL OB	282
25.600.5953.0	8543 / 9	316	25.621.1553.0	8813 B / 15 F	280	25.624.3653.0	8813 B / 6 VL OB	282
25.600.6053.0	8543 / 10	316	25.621.1653.0	8813 B / 16 F	280	25.624.3753.0	8813 B / 7 VL OB	282
25.600.6153.0	8543 / 11	316	25.621.3253.0	8813 B / 2 F OB	280	25.624.3853.0	8813 B / 8 VL OB	282
25.600.6253.0	8543 / 12	316	25.621.3353.0	8813 B / 3 F OB	280	25.624.3953.0	8813 B / 9 VL OB	282
25.600.6353.0	8543 / 13	316	25.621.3453.0	8813 B / 4 F OB	280	25.624.4053.0	8813 B / 10 VL OB	282
25.600.6453.0	8543 / 14	316	25.621.3553.0	8813 B / 5 F OB	280	25.624.4153.0	8813 B / 11 VL OB	282
25.600.6553.0	8543 / 15	316	25.621.3653.0	8813 B / 6 F OB	280	25.624.4253.0	8813 B / 12 VL OB	282
25.600.6653.0	8543 / 16	316	25.621.3753.0	8813 B / 7 F OB	280	25.624.4353.0	8813 B / 13 VL OB	282
25.601.1253.0	8142 / 4 / 2	318	25.621.3853.0	8813 B / 8 F OB	280	25.624.4453.0	8813 B / 14 VL OB	282
25.601.1353.0	8142 / 6 / 3	318	25.621.3953.0	8813 B / 9 F OB	280	25.624.4553.0	8813 B / 15 VL OB	282
25.601.1453.0	8142 / 8 / 4	318	25.621.4053.0	8813 B / 10 F OB	280	25.624.4653.0	8813 B / 16 VL OB	282
25.601.1553.0	8142 / 10 / 5	318	25.621.4153.0	8813 B / 11 F OB	280	25.625.0253.0	8813 B / 2 VL F	283
25.601.1653.0	8142 / 12 / 6	318	25.621.4253.0	8813 B / 12 F OB	280	25.625.0353.0	8813 B / 3 VL F	283
25.601.1753.0	8142 / 14 / 7	318	25.621.4353.0	8813 B / 13 F OB	280	25.625.0453.0	8813 B / 4 VL F	283
25.601.1853.0	8142 / 16 / 8	318	25.621.4453.0	8813 B / 14 F OB	280	25.625.0553.0	8813 B / 5 VL F	283
25.602.2253.0	8142 / 2 OB	318	25.621.4553.0	8813 B / 15 F OB	280	25.625.0653.0	8813 B / 6 VL F	283
25.602.2353.0	8142 / 3 OB	318	25.621.4653.0	8813 B / 16 F OB	280	25.625.0753.0	8813 B / 7 VL F	283
25.602.2453.0	8142 / 4 OB	318	25.622.0253.0	8813 B / 2 VR	282	25.625.0853.0	8813 B / 8 VL F	283
25.602.2553.0	8142 / 5 OB	318	25.622.0353.0	8813 B / 3 VR	282	25.625.0953.0	8813 B / 9 VL F	283
25.602.2653.0	8142 / 6 OB	318	25.622.0453.0	8813 B / 4 VR	282	25.625.1053.0	8813 B / 10 VL F	283
25.602.2753.0	8142 / 7 OB	318	25.622.0553.0	8813 B / 5 VR	282	25.625.1153.0	8813 B / 11 VL F	283
25.602.2853.0	8142 / 8 OB	318	25.622.0653.0	8813 B / 6 VR	282	25.625.1253.0	8813 B / 12 VL F	283
25.602.2953.0	8142 / 9 OB	318	25.622.0753.0	8813 B / 7 VR	282	25.625.1353.0	8813 B / 13 VL F	283
25.602.3053.0	8142 / 10 OB	318	25.622.0853.0	8813 B / 8 VR	282	25.625.1453.0	8813 B / 14 VL F	283
25.602.3153.0	8142 / 11 OB	318	25.622.0953.0	8813 B / 9 VR	282	25.625.1553.0	8813 B / 15 VL F	283
25.602.3253.0	8142 / 12 OB	318	25.622.1053.0	8813 B / 10 VR	282	25.625.1653.0	8813 B / 16 VL F	283
25.602.3353.0	8142 / 13 OB	318	25.622.1153.0	8813 B / 11 VR	282	25.625.3253.0	8813 B / 2 VL F OB	283
25.602.3453.0	8142 / 14 OB	318	25.622.1253.0	8813 B / 12 VR	282	25.625.3353.0	8813 B / 3 VL F OB	283
25.602.3553.0	8142 / 15 OB	318	25.622.1353.0	8813 B / 13 VR	282	25.625.3453.0	8813 B / 4 VL F OB	283
25.602.3653.0	8142 / 16 OB	318	25.622.1453.0	8813 B / 14 VR	282	25.625.3553.0	8813 B / 5 VL F OB	283
25.602.5253.0	8543 / 2 OB	316	25.622.1553.0	8813 B / 15 VR	282	25.625.3653.0	8813 B / 6 VL F OB	283
25.602.5353.0	8543 / 3 OB	316	25.622.1653.0	8813 B / 16 VR	282	25.625.3753.0	8813 B / 7 VL F OB	283
25.602.5453.0	8543 / 4 OB	316	25.622.3253.0	8813 B / 2 VR OB	282	25.625.3853.0	8813 B / 8 VL F OB	283
25.602.5553.0	8543 / 5 OB	316	25.622.3353.0	8813 B / 3 VR OB	282	25.625.3953.0	8813 B / 9 VL F OB	283
25.602.5653.0	8543 / 6 OB	316	25.622.3453.0	8813 B / 4 VR OB	282	25.625.4053.0	8813 B / 10 VL F OB	283
25.602.5753.0	8543 / 7 OB	316	25.622.3553.0	8813 B / 5 VR OB	282	25.625.4153.0	8813 B / 11 VL F OB	283
25.602.5853.0	8543 / 8 OB	316	25.622.3653.0	8813 B / 6 VR OB	282	25.625.4253.0	8813 B / 12 VL F OB	283
25.602.5953.0	8543 / 9 OB	316	25.622.3753.0	8813 B / 7 VR OB	282	25.625.4353.0	8813 B / 13 VL F OB	283
25.602.6053.0	8543 / 10 OB	316	25.622.3853.0	8813 B / 8 VR OB	282	25.625.4453.0	8813 B / 14 VL F OB	283
25.602.6153.0	8543 / 11 OB	316	25.622.3953.0	8813 B / 9 VR OB	282	25.625.4553.0	8813 B / 15 VL F OB	283
25.602.6253.0	8543 / 12 OB	316	25.622.4053.0	8813 B / 10 VR OB	282	25.625.4653.0	8813 B / 16 VL F OB	283
25.602.6353.0	8543 / 13 OB	316	25.622.4153.0	8813 B / 11 VR OB	282	25.626.0253.0	8813 S / 2 G	284
25.602.6453.0	8543 / 14 OB	316	25.622.4253.0	8813 B / 12 VR OB	282	25.626.0353.0	8813 S / 3 G	284
25.602.6553.0	8543 / 15 OB	316	25.622.4353.0	8813B / 13 VR OB	282	25.626.0453.0	8813 S / 4 G	284
25.602.6653.0	8543 / 16 OB	316	25.622.4453.0	8813 B / 14 VR OB	282	25.626.0553.0	8813 S / 5 G	284
25.603.1253.0	8142 / 4 / 2 OB	318	25.622.4553.0	8813 B / 15 VR OB	282	25.626.0653.0	8813 S / 6 G	284
25.603.1353.0	8142 / 6 / 3 OB	318	25.622.4653.0	8813 B / 16 VR OB	282	25.626.0753.0	8813 S / 7 G	284
25.603.1453.0	8142 / 8 / 4 OB	318	25.623.0253.0	8813 B / 2 VR F	283	25.626.0853.0	8813 S / 8 G	284
25.603.1553.0	8142 / 10 / 5 OB	318	25.623.0353.0	8813 B / 3 VR F	283	25.626.0953.0	8813 S / 9 G	284
25.603.1653.0	8142 / 12 / 6 OB	318	25.623.0453.0	8813 B / 4 VR F	283	25.626.1053.0	8813 S / 10 G	284
25.603.1753.0	8142 / 14 / 7 OB	318	25.623.0553.0	8813 B / 5 VR F	283	25.626.1153.0	8813 S / 11 G	284
25.603.1853.0	8142 / 16 / 8 OB	318	25.623.0653.0	8813 B / 6 VR F	283	25.626.1253.0	8813 S / 12 G	284
25.620.0253.0	8813 B / 2	280	25.623.0753.0	8813 B / 7 VR F	283	25.626.1353.0	8813 S / 13 G	284
25.620.0353.0	8813 B / 3	280	25.623.0853.0	8813 B / 8 VR F	283	25.626.1453.0	8813 S / 14 G	284
25.620.0453.0	8813 B / 4	280	25.623.0953.0	8813 B / 9 VR F	283	25.626.1553.0	8813 S / 15 G	284
25.620.0553.0	8813 B / 5	280	25.623.1053.0	8813 B / 10 VR F	283	25.626.1653.0	8813 S / 16 G	284
25.620.0653.0	8813 B / 6	280	25.623.1153.0	8813 B / 11 VR F	283	25.626.3253.0	8813 S / 2 GF	285
25.620.0753.0	8813 B / 7	280	25.623.1253.0	8813 B / 12 VR F	283	25.626.3353.0	8813 S / 3 GF	285
25.620.0853.0	8813 B / 8	280	25.623.1353.0	8813 B / 13 VR F	283	25.626.3453.0	8813 S / 4 GF	285
25.620.0953.0	8813 B / 9	280	25.623.1453.0	8813 B / 14 VR F	283	25.626.3553.0	8813 S / 5 GF	285
25.620.1053.0	8813 B / 10	280	25.623.1553.0	8813 B / 15 VR F	283	25.626.3653.0	8813 S / 6 GF	285
25.620.1153.0	8813 B / 11	280	25.623.3253.0	8813 B / 2 VR F OB	283	25.626.3753.0	8813 S / 7 GF	285
25.620.1253.0	8813 B / 12	280	25.623.3353.0	8813 B / 3 VR F OB	283	25.626.3853.0	8813 S / 8 GF	285
25.620.1353.0	8813 B / 13	280	25.623.3453.0	8813 B / 4 VR F OB	283	25.626.3953.0	8813 S / 9 GF	285
25.620.1453.0	8813 B / 14	280	25.623.3553.0	8813 B / 5 VR F OB	283	25.626.4053.0	8813 S / 10 GF	285
25.620.1553.0	8813 B / 15	280	25.623.3653.0	8813 B / 6 VR F OB	283	25.626.4153.0	8813 S / 11 GF	285
25.620.1653.0	8813 B / 16	280	25.623.3753.0	8813 B / 7 VR F OB	283	25.626.4253.0	8813 S / 12 GF	285
25.620.3253.0	8813 B / 2 OB	280	25.623.3853.0	8813 B / 8 VR F OB	283	25.626.4353.0	8813 S / 13 GF	285
25.620.3353.0	8813 B / 3 OB	280	25.623.3953.0	8813 B / 9 VR F OB	283	25.626.4453.0	8813 S / 14 GF	285
25.620.3453.0	8813 B / 4 OB	280	25.623.4053.0	8813 B / 10 VR F OB	283	25.626.4553.0	8813 S / 15 GF	285
25.620.3553.0	8813 B / 5 OB	280	25.623.4153.0	8813 B / 11 VR F OB	283	25.626.4653.0	8813 S / 16 GF	285
25.620.3653.0	8813 B / 6 OB	280	25.623.4253.0	8813 B / 12 VR F OB	283	25.627.0253.0	8813 S / 2 W	284
25.620.3753.0	8813 B / 7 OB	280	25.623.4353.0	8813 B / 13 VR F OB	283	25.627.0353.0	8813 S / 3 W	284
25.620.3853.0	8813 B / 8 OB	280	25.623.4453.0	8813 B / 14 VR F OB	283	25.627.0453.0	8813 S / 4 W	284
25.620.3953.0	8813 B / 9 OB	280	25.623.4553.0	8813 B / 15 VR F OB	283	25.627.0553.0	8813 S / 5 W	284

contents of
part number

contents PART NUMBER

Part no.	Type	section / page	Part no.	Type	section / page	Part no.	Type	section / page
25.761.3553.0	8385 TOP H	352	25.791.0253.0	8258 / 2 TOP H OB	353	25.820.4253.0	8113 BFK /12 TOP K OB	292
25.761.3653.0	8385 TOP H	352	25.791.0353.0	8258 / 3 TOP H OB	353	25.820.4353.0	8113 BFK /13 TOP K OB	37
25.761.3753.0	8385 TOP H	352	25.791.0453.0	8258 / 4 TOP H OB	353	25.820.4353.0	8113 BFK /13 TOP K OB	292
25.761.3853.0	8385 TOP H	352	25.791.0553.0	8258 / 5 TOP H OB	353	25.820.4453.0	8113 BFK /14 TOP K OB	37
25.771.0053.0	8485 / 1 TOP V	351	25.791.0653.0	8258 / 6 TOP H OB	353	25.820.4453.0	8113 BFK /14 TOP K OB	292
25.771.0153.0	8485 / 1 TOP H	352	25.791.0753.0	8258 / 7 TOP H OB	353	25.820.4553.0	8113 BFK /15 TOP K OB	37
25.771.0253.0	8485 / 2 TOP V	351	25.791.0853.0	8258 / 8 TOP H OB	353	25.820.4553.0	8113 BFK /15 TOP K OB	292
25.771.0353.0	8485 / 3 TOP V	351	25.791.0953.0	8258 / 9 TOP H OB	353	25.820.4653.0	8113 BFK /16 TOP K OB	37
25.771.0453.0	8485 / 4 TOP V	351	25.791.1053.0	8258 / 10 TOP H OB	353	25.820.4653.0	8113 BFK /16 TOP K OB	292
25.771.0553.0	8485 / 5 TOP V	351	25.791.1153.0	8258 / 11 TOP H OB	353	25.821.0253.0		292
25.771.0653.0	8485 TOP V	351	25.791.1253.0	8258 / 12 TOP H OB	353	25.821.0353.0		292
25.771.0753.0	8485 TOP V	351	25.791.1353.0	8258 / 13 TOP H OB	353	25.821.0453.0		292
25.771.0853.0	8485 TOP V	351	25.791.1453.0	8258 / 14 TOP H OB	353	25.821.0553.0		292
25.771.3253.0	8485 / 2 TOP H	352	25.791.1553.0	8258 / 15 TOP H OB	353	25.821.0653.0		292
25.771.3353.0	8485 / 3 TOP H	352	25.791.1653.0	8258 / 16 TOP H OB	353	25.821.0753.0		292
25.771.3453.0	8485 TOP H	352	25.792.0253.0	8358 / 2 TOP H OB	354	25.821.0853.0		292
25.771.3553.0	8485 TOP H	352	25.792.0353.0	8358 / 3 TOP H OB	354	25.821.0953.0		292
25.771.3653.0	8485 / 6 TOP H	352	25.792.0453.0	8358 / 4 TOP H OB	354	25.821.1053.0		292
25.771.3753.0	8485 TOP H	352	25.792.0553.0	8358 / 5 TOP H OB	354	25.821.1153.0		292
25.771.3853.0	8485 TOP H	352	25.792.0653.0	8358 / 6 TOP H OB	354	25.821.1253.0		292
25.780.0253.0	8158 / 2 TOP V OB	353	25.792.0753.0	8358 / 7 TOP H OB	354	25.821.1353.0		292
25.780.0353.0	8158 / 3 TOP V OB	353	25.792.0853.0	8358 / 8 TOP H OB	354	25.821.1453.0		292
25.780.0453.0	8158 / 4 TOP V OB	353	25.792.0953.0	8358 / 9 TOP H OB	354	25.821.1553.0		292
25.780.0553.0	8158 / 5 TOP V OB	353	25.792.1053.0	8358 / 10 TOP H OB	354	25.821.1653.0		292
25.780.0653.0	8158 / 6 TOP V OB	353	25.792.1153.0	8358 / 11 TOP H OB	354	25.821.3253.0		292
25.780.0753.0	8158 / 7 TOP V OB	353	25.792.1253.0	8358 / 12 TOP H OB	354	25.821.3353.0		292
25.780.0853.0	8158 / 8 TOP V OB	353	25.792.1353.0	8358 / 13 TOP H OB	354	25.821.3453.0		292
25.780.0953.0	8158 / 9 TOP V OB	353	25.792.1453.0	8358 / 14 TOP H OB	354	25.821.3553.0		292
25.780.1053.0	8158 / 10 TOP V OB	353	25.792.1553.0	8358 / 15 TOP H OB	354	25.821.3653.0		292
25.780.1153.0	8158 / 11 TOP V OB	353	25.792.1653.0	8358 / 16 TOP H OB	354	25.821.3753.0		292
25.780.1253.0	8158 / 12 TOP V OB	353	25.793.0253.0	8458 / 2 TOP H OB	354	25.821.3853.0		292
25.780.1353.0	8158 / 13 TOP V OB	353	25.793.0353.0	8458 / 3 TOP H OB	354	25.821.3953.0		292
25.780.1453.0	8158 / 14 TOP V OB	353	25.793.0453.0	8458 / 4 TOP H OB	354	25.821.4053.0		292
25.780.1553.0	8158 / 15 TOP V OB	353	25.793.0553.0	8458 / 5 TOP H OB	354	25.821.4153.0		292
25.780.1653.0	8158 / 16 TOP V OB	353	25.793.0653.0	8458 / 6 TOP H OB	354	25.821.4253.0		292
25.781.0253.0	8258 / 2 TOP V OB	353	25.793.0753.0	8458 / 7 TOP H OB	354	25.821.4353.0		292
25.781.0353.0	8258 / 3 TOP V OB	353	25.793.0853.0	8458 / 8 TOP H OB	354	25.821.4453.0		292
25.781.0453.0	8258 / 4 TOP V OB	353	25.793.0953.0	8458 / 9 TOP H OB	354	25.821.4553.0		292
25.781.0553.0	8258 / 5 TOP V OB	353	25.793.1053.0	8458 / 10 TOP H OB	354	25.821.4653.0		292
25.781.0653.0	8258 / 6 TOP V OB	353	25.793.1153.0	8458 / 11 TOP H OB	354	25.840.0253.0	8213 BFK / 2 TOP K	292
25.781.0753.0	8258 / 7 TOP V OB	353	25.793.1253.0	8458 / 12 TOP H OB	354	25.840.0353.0	8213 BFK / 3 TOP K	292
25.781.0853.0	8258 / 8 TOP V OB	353	25.793.1353.0	8458 / 13 TOP H OB	354	25.840.0453.0	8213 BFK / 4 TOP K	292
25.781.0953.0	8258 / 9 TOP V OB	353	25.793.1453.0	8458 / 14 TOP H OB	354	25.840.0553.0	8213 BFK / 5 TOP K	292
25.781.1053.0	8258 / 10 TOP V OB	353	25.793.1553.0	8458 / 15 TOP H OB	354	25.840.0653.0	8213 BFK / 6 TOP K	292
25.781.1153.0	8258 / 11 TOP V OB	353	25.793.1653.0	8458 / 16 TOP H OB	354	25.840.0753.0	8213 BFK / 7 TOP K	292
25.781.1253.0	8258 / 12 TOP V OB	353	25.820.0253.0	8113 BFK / 2 TOP K	37	25.840.0853.0	8213 BFK / 8 TOP K	292
25.781.1353.0	8258 / 13 TOP V OB	353	25.820.0253.0	8113 BFK / 3 TOP K	292	25.840.0953.0	8213 BFK / 9 TOP K	292
25.781.1453.0	8258 / 14 TOP V OB	353	25.820.0353.0	8113 BFK / 4 TOP K	37	25.840.1053.0	8213 BFK / 10 TOP K	292
25.781.1553.0	8258 / 15 TOP V OB	353	25.820.0453.0	8113 BFK / 5 TOP K	37	25.840.1153.0	8213 BFK / 11 TOP K	292
25.781.1653.0	8258 / 16 TOP V OB	353	25.820.0453.0	8113 BFK / 6 TOP K	292	25.840.1253.0	8213 BFK / 12 TOP K	292
25.782.0253.0	8358 / 2 TOP V OB	354	25.820.0553.0	8113 BFK / 7 TOP K	37	25.840.1353.0	8213 BFK / 13 TOP K	292
25.782.0353.0	8358 / 3 TOP V OB	354	25.820.0653.0	8113 BFK / 8 TOP K	292	25.840.1453.0	8213 BFK / 14 TOP K	292
25.782.0453.0	8358 / 4 TOP V OB	354	25.820.0753.0	8113 BFK / 9 TOP K	37	25.840.1553.0	8213 BFK / 15 TOP K	292
25.782.0553.0	8358 / 5 TOP V OB	354	25.820.0853.0	8113 BFK / 10 TOP K	292	25.840.1653.0	8213 BFK / 16 TOP K	292
25.782.0653.0	8358 / 6 TOP V OB	354	25.820.0953.0	8113 BFK / 11 TOP K	292	25.840.3253.0	8213 BFK / 2 TOP K OB	292
25.782.0753.0	8358 / 7 TOP V OB	354	25.820.1053.0	8113 BFK / 12 TOP K	292	25.840.3353.0	8213 BFK / 3 TOP K OB	292
25.782.0853.0	8358 / 8 TOP V OB	354	25.820.1153.0	8113 BFK / 13 TOP K	37	25.840.3453.0	13 BFK / 4 TOP K OB	292
25.782.0953.0	8358 / 9 TOP V OB	354	25.820.1253.0	8113 BFK / 14 TOP K	292	25.840.3553.0	8213 BFK / 5 TOP K OB	292
25.782.1053.0	8358 / 10 TOP V OB	354	25.820.1353.0	8113 BFK / 15 TOP K	37	25.840.3653.0	8213 BFK / 6 TOP K OB	292
25.782.1153.0	8358 / 11 TOP V OB	354	25.820.1453.0	8113 BFK / 16 TOP K	292	25.840.3753.0	8213 BFK / 7 TOP K OB	292
25.782.1253.0	8358 / 12 TOP V OB	354	25.820.1553.0	8113 BFK / 17 TOP K	292	25.840.3853.0	8213 BFK / 8 TOP K OB	292
25.782.1353.0	8358 / 13 TOP V OB	354	25.820.1653.0	8113 BFK / 18 TOP K	292	25.840.3953.0	8213 BFK / 9 TOP K OB	292
25.782.1453.0	8358 / 14 TOP V OB	354	25.820.1753.0	8113 BFK / 19 TOP K	292	25.840.4053.0	8213 BFK / 10 TOP K OB	292
25.782.1553.0	8358 / 15 TOP V OB	354	25.820.1853.0	8113 BFK / 20 TOP K	292	25.840.4153.0	8213 BFK / 11 TOP K OB	292
25.782.1653.0	8358 / 16 TOP V OB	354	25.820.1953.0	8113 BFK / 21 TOP K	292	25.840.4253.0	8213 BFK / 12 TOP K OB	292
25.783.0253.0	8458 / 2 TOP V OB	354	25.820.2053.0	8113 BFK / 22 TOP K	292	25.840.4353.0	8213 BFK / 13 TOP K OB	292
25.783.0353.0	8458 / 3 TOP V OB	354	25.820.2153.0	8113 BFK / 23 TOP K	37	25.840.4453.0	8213 BFK / 14 TOP K OB	292
25.783.0453.0	8458 / 4 TOP V OB	354	25.820.2253.0	8113 BFK / 24 TOP K	292	25.840.4553.0	8213 BFK / 15 TOP K OB	292
25.783.0553.0	8458 / 5 TOP V OB	354	25.820.2353.0	8113 BFK / 25 TOP K	37	25.840.4653.0	8213 BFK / 16 TOP K OB	292
25.783.0653.0	8458 / 6 TOP V OB	354	25.820.2453.0	8113 BFK / 26 TOP K	292	25.841.0253.0		292
25.783.0753.0	8458 / 7 TOP V OB	354	25.820.2553.0	8113 BFK / 27 TOP K	292	25.841.0353.0		292
25.783.0853.0	8458 / 8 TOP V OB	354	25.820.2653.0	8113 BFK / 28 TOP K	292	25.841.0453.0		292
25.783.0953.0	8458 / 9 TOP V OB	354	25.820.2753.0	8113 BFK / 29 TOP K	292	25.841.0553.0		292
25.783.1053.0	8458 / 10 TOP V OB	354	25.820.2853.0	8113 BFK / 30 TOP K	292	25.841.0653.0		292
25.783.1153.0	8458 / 11 TOP V OB	354	25.820.2953.0	8113 BFK / 31 TOP K	37	25.841.0753.0		292
25.783.1253.0	8458 / 12 TOP V OB	354	25.820.3053.0	8113 BFK / 32 TOP K	292	25.841.0853.0		292
25.783.1353.0	8458 / 13 TOP V OB	354	25.820.3153.0	8113 BFK / 33 TOP K	37	25.841.0953.0		292
25.783.1453.0	8458 / 14 TOP V OB	354	25.820.3253.0	8113 BFK / 34 TOP K	292	25.841.1053.0		292
25.783.1553.0	8458 / 15 TOP V OB	354	25.820.3353.0	8113 BFK / 35 TOP K	37	25.841.1153.0		292
25.783.1653.0	8458 / 16 TOP V OB	354	25.820.3453.0	8113 BFK / 36 TOP K	292	25.841.1253.0		292
25.790.0253.0	8158 / 2 TOP H OB	353	25.820.3553.0	8113 BFK / 37 TOP K	37	25.841.1353.0	8213 BFK /12 TOP K F	292
25.790.0353.0	8158 / 3 TOP H OB	353	25.820.3653.0	8113 BFK / 38 TOP K	292	25.841.1453.0		292
25.790.0453.0	8158 / 4 TOP H OB	353	25.820.3753.0	8113 BFK / 39 TOP K	292	25.841.1553.0		292
25.790.0553.0	8158 / 5 TOP H OB	353	25.820.3853.0	8113 BFK / 40 TOP K	292	25.841.1653.0		292
25.790.0653.0	8158 / 6 TOP H OB	353	25.820.3953.0	8113 BFK / 41 TOP K	292	25.841.3253.0		292
25.790.0753.0	8158 / 7 TOP H OB	353	25.820.4053.0	8113 BFK / 42 TOP K	292	25.841.3353.0		292
25.790.0853.0	8158 / 8 TOP H OB	353	25.820.4153.0	8113 BFK / 43 TOP K	37	25.841.3453.0		292
25.790.0953.0	8158 / 9 TOP H OB	353	25.820.4253.0	8113 BFK / 44 TOP K	292	25.841.3553.0		292
25.790.1053.0	8158 / 10 TOP H OB	353	25.820.4353.0	8113 BFK / 45 TOP K	292	25.841.3653.0		292
25.790.1153.0	8158 / 11 TOP H OB	353	25.820.4453.0	8113 BFK / 46 TOP K	292	25.841.3753.0		292
25.790.1253.0	8158 / 12 TOP H OB	353	25.820.4553.0	8113 BFK / 47 TOP K	37	25.841.3853.0		292
25.790.1353.0	8158 / 13 TOP H OB	353	25.820.4653.0	8113 BFK / 48 TOP K	292	25.841.3953.0		292
25.790.1453.0	8158 / 14 TOP H OB	353	25.820.4753.0	8113 BFK / 49 TOP K	37	25.841.4053.0		292
25.790.1553.0	8158 / 15 TOP H OB	353	25.820.4853.0	8113 BFK / 50 TOP K	292	25.841.4153.0		292
25.790.1653.0	8158 / 16 TOP H OB	353	25.820.4953.0	8113 BFK / 51 TOP K	37	25.841.4253.0		292

contents

Part no.	Type	section / page	Part no.	Type	section / page	Part no.	Type	section / page
25.841.4353.0		■ 292	27.000.4353.0	8292 DH / 3 OB	■ 340	27.714.0653.0	7386 / 6 TOP H OB	■ 355
25.841.4453.0		■ 292	27.002.0253.0	7572 L4 / 2 OB	■ 376	27.714.0753.0		■ 355
25.841.4553.0		■ 292	27.002.0353.0	7572 L4 / 3 OB	■ 376	27.714.0853.0		■ 355
25.841.4653.0		■ 292	27.002.2253.0	7572 L2 / 2 OB	■ 376	27.720.0153.0		■ 348
25.857.0253.0	8213 SUFK/ 2 TOP	■ 293	27.002.2353.0	7572 L2 / 3 OB	■ 376	27.720.0253.0		■ 348
25.857.0353.0	8213 SUFK/ 3 TOP	■ 293	27.002.4253.0	7572 L2 / 3 / 2 OB	■ 377	27.720.0353.0		■ 348
25.857.0453.0	8213 SUFK/ 4 TOP	■ 293	27.002.4353.0	7572 L2 / 5 / 3 OB	■ 377	27.720.0453.0		■ 348
25.857.0553.0	8213 SUFK/ 5 TOP	■ 293	27.002.6153.0		■ 375	27.720.0553.0	8152 / 5 TOP V OB	■ 348
25.857.0653.0	8213 SUFK/ 6 TOP	■ 293	27.002.6353.0	7573 L2 / 3 W OB	■ 375	27.720.0653.0		■ 348
25.857.0753.0	8213 SUFK/ 7 TOP	■ 293	27.002.6453.0	7573 L2 / 4 W OB	■ 375	27.720.0753.0		■ 348
25.857.0853.0	8213 SUFK/ 8 TOP	■ 293	27.334.0253.0		■ 304	27.720.0853.0		■ 348
25.857.0953.0	8213 SUFK/ 9 TOP	■ 293	27.334.0353.0		■ 304	27.720.0953.0		■ 348
25.857.1053.0	8213 SUFK/10 TOP	■ 293	27.334.0453.0		■ 304	27.720.1053.0	8152 / 10 TOP V OB	■ 348
25.857.1153.0	8213 SUFK/11 TOP	■ 293	27.334.0553.0	8113 SEG/ 5/10 G OB	■ 304	27.730.0153.0		■ 348
25.857.1253.0	8213 SUFK/12 TOP	■ 293	27.334.0653.0		■ 304	27.730.0253.0		■ 348
25.857.1353.0	8213 SUFK/13 TOP	■ 293	27.334.0753.0		■ 304	27.730.0353.0		■ 348
25.857.1453.0	8213 SUFK/14 TOP	■ 293	27.334.0853.0		■ 304	27.730.0453.0		■ 348
25.857.1553.0	8213 SUFK/15 TOP	■ 293	27.334.0953.0		■ 304	27.730.0553.0	8152 / 5 TOP H OB	■ 348
25.857.1653.0	8213 SUFK/16 TOP	■ 293	27.334.1053.0	8113 SEG/10/20 G OB	■ 304	27.730.0653.0		■ 348
25.857.3253.0	8213 SUFK/ 2 TOP OB	■ 293	27.334.1153.0		■ 304	27.730.0753.0		■ 348
25.857.3353.0	8213 SUFK/ 3 TOP OB	■ 293	27.334.1253.0		■ 304	27.730.0853.0		■ 348
25.857.3453.0	8213 SUFK/ 4 TOP OB	■ 293	27.334.1353.0		■ 304	27.730.0953.0		■ 348
25.857.3553.0	8213 SUFK/ 5 TOP OB	■ 293	27.334.1453.0		■ 304	27.730.1053.0	8152 / 10 TOP H OB	■ 348
25.857.3653.0	8213 SUFK/ 6 TOP OB	■ 293	27.334.1553.0		■ 304	28.121.0240.0	KBD 1 / 2 KR	■ 266
25.857.3753.0	8213 SUFK/ 7 TOP OB	■ 293	27.334.1653.0		■ 304	28.121.0340.0	KBD 1 / 3 KR	■ 266
25.857.3853.0	8213 SUFK/ 8 TOP OB	■ 293	27.336.0253.0		■ 304	28.121.0440.0	KBD 1 / 4 KR	■ 266
25.857.3953.0	8213 SUFK/ 9 TOP OB	■ 293	27.336.0353.0		■ 304	28.121.0540.0	KBD 1 / 5 KR	■ 266
25.857.4053.0	8213 SUFK/10 TOP OB	■ 293	27.336.0453.0		■ 304	28.121.0640.0	KBD 1 / 6 KR	■ 266
25.857.4153.0	8213 SUFK/11 TOP OB	■ 293	27.336.0553.0	8113 SEG/ 5/10 W OB	■ 304	28.121.0740.0		■ 266
25.857.4253.0	8213 SUFK/12 TOP OB	■ 293	27.336.0653.0		■ 304	28.121.0840.0	KBD 1 / 8 KR	■ 266
25.857.4353.0	8213 SUFK/13 TOP OB	■ 293	27.336.0753.0		■ 304	28.121.1040.0	KBD 1 /10 KR	■ 266
25.857.4453.0	8213 SUFK/14 TOP OB	■ 293	27.336.0853.0		■ 304	28.121.1240.0	KBD 1 /12 KR	■ 266
25.857.4553.0	8213 SUFK/15 TOP OB	■ 293	27.336.0953.0		■ 304	29.130.1353.0	KL 58 / 3 / 1	■ 268
25.857.4653.0	8213 SUFK/16 TOP OB	■ 293	27.336.1053.0	8113 SEG/10/20 W OB	■ 304	29.130.1553.0	KL 58 / 5 / 1	■ 268
25.880.0253.0	8413 BFK / 2 TOP K	■ 294	27.336.1153.0		■ 304	29.130.1653.0	KL 58 / 6 / 1	■ 268
25.880.0353.0	8413 BFK / 3 TOP K	■ 294	27.336.1253.0		■ 304	29.130.2353.0		■ 268
25.880.0453.0	8413 BFK / 4 TOP K	■ 294	27.336.1353.0		■ 304	29.130.2553.0		■ 268
25.880.0553.0	8413 BFK / 5 TOP K	■ 294	27.336.1453.0		■ 304	29.130.2653.0		■ 268
25.880.0653.0	8413 BFK / 6 TOP K	■ 294	27.336.1553.0		■ 304	29.131.1353.0	KL 58 / 3 S / 1	■ 269
25.880.0753.0	8413 BFK / 7 TOP K	■ 294	27.336.1653.0		■ 304	29.131.1553.0	KL 58 / 5 S / 1	■ 269
25.880.0853.0	8413 BFK / 8 TOP K	■ 294	27.341.3253.0		■ 287	29.131.1653.0	KL 58 / 6 S / 1	■ 269
25.880.0953.0	8413 BFK / 9 TOP K	■ 294	27.341.3353.0		■ 287	29.131.2353.0	KL 58 / 3 S R / 1	■ 269
25.880.1053.0	8413 BFK /10 TOP K	■ 294	27.341.3453.0		■ 287	29.131.2553.0	KL 58 / 5 S R / 1	■ 269
25.880.1153.0	8413 BFK /11 TOP K	■ 294	27.341.3553.0	8213 B / 5 S OB	■ 287	29.131.2653.0	KL 58 / 6 S R / 1	■ 269
25.880.1253.0	8413 BFK /12 TOP K	■ 294	27.341.3653.0		■ 287	29.400.0453.0	KL 16 / 4 PA	■ 256
25.880.3253.0	8413 BFK / 2 TOP K OB	■ 294	27.341.3753.0		■ 287	29.400.0653.0	KL 16 / 6 PA	■ 256
25.880.3353.0	8413 BFK / 3 TOP K OB	■ 294	27.341.3853.0		■ 287	29.400.0853.0	KL 16 / 8 PA	■ 256
25.880.3453.0	8413 BFK / 4 TOP K OB	■ 294	27.341.3953.0		■ 287	29.400.1253.0	KL 16 / 12 PA	■ 256
25.880.3553.0	8413 BFK / 5 TOP K OB	■ 294	27.341.4053.0	8213 B / 10 S OB	■ 287	29.400.1653.0	KL 16 / 16 PA	■ 256
25.880.3653.0	8413 BFK / 6 TOP K OB	■ 294	27.341.4153.0		■ 287	29.400.2053.0	KL 16 / 20 PA	■ 256
25.880.3753.0	8413 BFK / 7 TOP K OB	■ 294	27.341.4253.0		■ 287	29.401.0453.0	KL 16 / 4 PA DS	■ 256
25.880.3853.0	8413 BFK / 8 TOP K OB	■ 294	27.341.4353.0		■ 287	29.401.0653.0	KL 16 / 6 PA DS	■ 256
25.880.3953.0	8413 BFK / 9 TOP K OB	■ 294	27.341.4453.0		■ 287	29.401.0853.0	KL 16 / 8 PA DS	■ 256
25.880.4053.0	8413 BFK /10 TOP K OB	■ 294	27.341.4553.0		■ 287	29.401.1253.0	KL 16 / 12 PA DS	■ 256
25.880.4153.0	8413 BFK /11 TOP K OB	■ 294	27.341.4653.0		■ 287	29.401.1653.0	KL 16 / 16 PA DS	■ 256
25.880.4253.0	8413 BFK /12 TOP K OB	■ 294	27.354.0253.0		■ 304	29.401.2053.0	KL 16 / 20 PA DS	■ 256
25.881.0253.0	8413 BFK / 2 TOP K F	■ 294	27.354.0353.0		■ 304	29.500.0253.0	KL 20 / 2 PA	■ 264
25.881.0353.0	8413 BFK / 3 TOP K F	■ 294	27.354.0453.0		■ 304	29.500.0353.0	KL 20 / 4 PA	■ 264
25.881.0453.0	8413 BFK / 4 TOP K F	■ 294	27.354.0553.0	8213 SEG/ 5/10 G OB	■ 304	29.500.1253.0	KL 20 / 2 DS PA	■ 264
25.881.0553.0	8413 BFK / 5 TOP K F	■ 294	27.354.0653.0		■ 304	29.500.1353.0	KL 20 / 4 DS PA	■ 264
25.881.0653.0	8413 BFK / 6 TOP K F	■ 294	27.354.0753.0		■ 304	29.500.3053.0	KL 30 / 3 PA	■ 265
25.881.0753.0	8413 BFK / 7 TOP K F	■ 294	27.354.0853.0		■ 304	29.500.4053.0	KL 30 / 3 DS PA	■ 265
25.881.0853.0	8413 BFK / 8 TOP K F	■ 294	27.354.0953.0		■ 304	29.500.9253.0	KL 24 / 2	■ 265
25.881.0953.0	8413 BFK / 9 TOP K F	■ 294	27.354.1053.0	8213 SEG/10/20 G OB	■ 304	29.500.9353.0	KL 24 / 3	■ 265
25.881.1053.0	8413 BFK /10 TOP K F	■ 294	27.354.1153.0		■ 304	29.500.9453.0	KL 24 / 4	■ 265
25.881.1153.0	8413 BFK /11 TOP K F	■ 294	27.354.1253.0		■ 304	29.500.9553.0	KL 24 / 5	■ 265
25.881.1253.0	8413 BFK /12 TOP K F	■ 294	27.354.1353.0		■ 304	29.502.9353.0	KL 24 / 3 SL	■ 265
25.881.3253.0	8413 BFK / 2 TOP K F OB	■ 294	27.354.1453.0		■ 304	29.502.9553.0	KL 24 / 5 SL	■ 265
25.881.3353.0	8413 BFK / 3 TOP K F OB	■ 294	27.354.1553.0		■ 304	29.608.0153.0	KL17 N / 1 /S6,3	■ 267
25.881.3453.0	8413 BFK / 4 TOP K F OB	■ 294	27.354.1653.0		■ 304	29.608.0253.0	KL17 N / 2 /S6,3	■ 267
25.881.3553.0	8413 BFK / 5 TOP K F OB	■ 294	27.356.0253.0		■ 304	29.608.0353.0	KL17 N / 3 /S6,3	■ 267
25.881.3653.0	8413 BFK / 6 TOP K F OB	■ 294	27.356.0353.0		■ 304	29.608.0453.0	KL17 N / 4 /S6,3	■ 267
25.881.3753.0	8413 BFK / 7 TOP K F OB	■ 294	27.356.0453.0		■ 304	29.608.0553.0	KL17 N / 5 /S6,3	■ 267
25.881.3853.0	8413 BFK / 8 TOP K F OB	■ 294	27.356.0553.0	8213 SEG/ 5/10 W OB	■ 304	29.608.0653.0	KL17 N / 6 /S6,3	■ 267
25.881.3953.0	8413 BFK / 9 TOP K F OB	■ 294	27.356.0653.0		■ 304	29.608.0753.0	KL17 N / 7 /S6,3	■ 267
25.881.4053.0	8413 BFK /10 TOP K F OB	■ 294	27.356.0753.0		■ 304	29.608.0853.0	KL17 N / 8 /S6,3	■ 267
25.881.4153.0	8413 BFK /11 TOP K F OB	■ 294	27.356.0853.0		■ 304	29.608.0953.0	KL17 N / 9 /S6,3	■ 267
25.881.4253.0	8413 BFK /12 TOP K F OB	■ 294	27.356.0953.0		■ 304	29.608.1053.0	KL17 N /10 /S6,3	■ 267
26.500.2053.0	RV2 S/6	■ 206	27.356.1053.0	8213 SEG/10/20 W OB	■ 304	29.608.1153.0	KL17 N /11 /S6,3	■ 267
26.500.2153.0	RV2 S/3 L	■ 206	27.356.1153.0		■ 304	29.608.1253.0	KL17 N /12 /S6,3	■ 267
26.500.2253.0	RV2 S/3 TP1	■ 207	27.356.1253.0		■ 304	29.608.1353.0	KL17 N /13 /S6,3	■ 267
26.500.2353.0	RV2 S/4 BLAU	■ 206	27.356.1353.0		■ 304	29.608.1453.0	KL17 N /14 /S6,3	■ 267
26.500.2453.0	RV2 S/2 L BLAU	■ 206	27.356.1453.0		■ 304	29.608.1553.0	KL17N /15 /S6,3	■ 267
26.500.2553.0	RV2 S/2 TP1 BLAU	■ 207	27.356.1553.0		■ 304	29.608.1653.0	KL17 N /16 /S6,3	■ 267
26.500.4053.0	RV2 A/6	■ 208	27.356.1653.0		■ 304	29.608.1753.0	KL17 N /17 /S6,3	■ 267
26.500.4153.0	RV2 A/3 L	■ 208	27.703.0253.0		■ 356	29.608.1853.0	KL17 N /18 /S6,3	■ 267
26.500.4253.0	RV2 A/3 TP1	■ 209	27.703.0353.0	8486 / 3 TOP V OB	■ 356	29.608.1953.0	KL17 N /19 /S6,3	■ 267
26.500.4353.0	RV2 A/4 BLAU	■ 208	27.703.0453.0	8486 / 4 TOP V OB	■ 356	29.608.2053.0	KL17 N /20 /S6,3	■ 267
26.500.4453.0	RV A/2 L BLAU	■ 209	27.713.0253.0		■ 356	29.608.2153.0	KL17 N /21 /S6,3	■ 267
26.500.4553.0	RV2 A/2 TP1 BLAU	■ 209	27.713.0353.0	8486 / 3 TOP H OB	■ 356	29.608.2253.0	KL17 N /22 /S6,3	■ 267
27.000.0253.0	8292 H / 2 OB	■ 341	27.713.0453.0	8486 / 4 TOP H OB	■ 356	29.608.2353.0	KL17 N /23 /S6,3	■ 267
27.000.0353.0	8292 H / 3 OB	■ 341	27.714.0253.0		■ 355	29.608.2453.0	KL17 N /24 /S6,3	■ 267
27.000.2253.0	8292 EH / 2 OB	■ 340	27.714.0353.0	7386 / 3 TOP H OB	■ 355	29.608.3153.0	KL17 N / 1 K/S6,3	■ 267
27.000.2353.0	8292 EH / 3 OB	■ 340	27.714.0453.0		■ 355	29.608.3253.0	KL17 N / 2 K/S6,3	■ 267
27.000.4253.0	8292 DH / 2 OB	■ 340	27.714.0553.0		■ 355	29.608.3353.0	KL17 N / 3 K/S6,3	■ 267

contents of
part number

contents PART NUMBER

Part no.	Type	section / page	Part no.	Type	section / page	Part no.	Type	section / page
29.608.3453.0	KL17 N/ 4 K/S6,3	267	56.035.9053.0	9700 A / 16 SL 2 S35	189	56.703.2053.6	WKF 2,5/D2/ 35/8113 BL	36
29.608.3553.0	KL17 N/ 5 K/S6,3	267	56.035.9453.0	9700 A / 16 PEN2 S35	195	56.703.2053.6	WKF 2,5/D2/ 35/8113 BL	308
29.608.3653.0	KL17 N/ 6 K/S6,3	267	56.106.0053.0		149	56.703.5053.0	WKF 2,5/D1/2/35	19
29.608.3753.0	KL17 N/ 7 K/S6,3	267	56.106.0553.0		148	56.703.5053.6	WKF 2,5/D1/2/35 BLAU	19
29.608.3853.0	KL17 N/ 8 K/S6,3	267	56.106.0653.0		148	56.703.5153.0	WKF 2,5/D2/2/35	19
29.608.3953.0	KL17 N/ 9 K/S6,3	267	56.301.0053.0	WKC 1 /35	231	56.703.5153.6	WKF 2,5/D2/2/35 BLAU	19
29.608.4053.0	KL17 N/10 K/S6,3	267	56.301.0053.6	WKC 1 /35 BLAU	231	56.703.5253.0	WKF 2,5 / D / D / 35	27
29.608.4153.0	KL17 N/11 K/S6,3	267	56.301.2053.0	WKC 1 TKM/35	231	56.703.9053.0	WKF 2,5 SL / 35	19
29.608.4253.0	KL17 N/12 K/S6,3	267	56.301.2053.6	WKC 1 TKM/35 BLAU	240	56.703.9153.0	WKF 2,5 / D 2/2 / SL/35	19
29.608.4353.0	KL17 N/13 K/S6,3	267	56.301.4053.0	WKC 1 TKG/35	231	56.703.9253.0	WKF 2,5 / D2/SL35/8113	36
29.608.4453.0	KL17 N/14 K/S6,3	267	56.301.5053.0	WKC 1 D1/2/35	231	56.703.9253.0	WKF 2,5 / D2/SL35/8113	308
29.608.4553.0	KL17 N/15 K/S6,3	267	56.301.5053.6	WKC 1 D1/2/35 BLAU	234	56.703.9353.0	WKF 2,5 / D 1/2 /SL/35	28
29.608.4653.0	KL17 N/16 K/S6,3	267	56.301.5153.0	WKC 1 D2/2/35	231	56.703.9453.0	WKIF 2,5 N-D-SL	55
29.608.4753.0		267	56.301.5153.6	WKC 1 D2/2/35 BLAU	236	56.703.9553.0	WKIF 2,5 NT-D-SL	55
29.608.4853.0		267	56.301.7053.0	WKC 1 E/35	231	56.703.9653.0	WKIF 2,5 D	58
29.608.4953.0		267	56.301.7053.6		238	56.703.9753.0	WKIF 2,5 D-D	55
29.608.5053.0	KL17 N/20 K/S6,3	267	56.301.9053.0	WKC 1 SL/35	231	56.703.9853.0	WKIF 2,5 D-D-SL	55
29.608.5153.0		267	56.301.9153.0	WKC 1 /D2/2/SL/35	237	56.704.0053.0	WKF 4 / 35	19
29.608.5253.0		267	56.301.9353.0	WKC 1 D1/2/SL/35	235	56.704.0053.6	WKF 4 / 35 BLAU	19
29.608.5353.0		267	56.303.0053.0	WKC 2,5 /35	231	56.704.2053.0	WKF 4 TKM / 35	39
29.608.5453.0		267	56.303.0053.6	WKC 2,5 /35 BLAU	231	56.704.4053.0	WKF 4 TKG / 35	38
30.400.0675.0	1038 A	263	56.303.2053.0	WKC 2,5 TKM/35	231	56.704.5053.0	WKF 4 D1/2/35	27
30.400.1075.0	1038 B	263	56.303.2053.6	WKC 2,5 TKM/35 BLAU	240	56.704.5053.6	WKF 4 D1/2/35 BLAU	27
30.400.1675.0	1038 C	263	56.303.4053.0	WKC 2,5 TKG/35	231	56.704.6953.1	ETAGENKLEMMLE	30
30.401.0475.0	1038 A DS	263	56.303.5053.0	WKC 2,5 D1/2/35	231	56.704.7053.0	WKF 4 E/35	30
30.401.0675.0	1038 B DS	263	56.303.5053.6	WKC 2,5 D1/2/35 BLAU	234	56.704.7153.5		32
30.401.1075.0	1038 C DS	263	56.303.5153.0	WKC 2,5 D2/2/35	231	56.704.7153.9		32
30.494.0010.0	WAK4/1	216	56.303.5153.6	WKC 2,5 D2/2/35 BLAU	236	56.704.7253.5		32
30.494.0010.6	WAK4/1 BL	216	56.303.7053.0	WKC 2,5 E/35	231	56.704.7353.5		32
30.494.0010.7	WAK4/1 GN	216	56.303.7053.6		238	56.704.7453.9		32
30.494.0110.0	WAK4/3	216	56.303.7153.5	WKC 2,5 E/35/1D/2G ROT	239	56.704.7553.5		32
30.494.0110.6	WAK4/3 BL	216	56.303.7153.9	WKC2,5E/35/1D/2G ORANGE	239	56.704.7553.9		32
30.494.0110.7	WAK4/3 GN	216	56.303.7253.5		239	56.704.7953.5		32
30.494.1010.0	WAK16/1	216	56.303.7353.5		239	56.704.8053.9		32
30.494.1010.6	WAK16/1 BL	216	56.303.7453.9		239	56.704.8153.0	WKF 4 NT / 35	24
30.494.1010.7	WAK16/1 GN	216	56.303.7553.5	WKC 2,5 E/35 ROT	239	56.704.8253.5		32
30.494.1110.0	WAK25/3	216	56.303.7553.9	WKC 2,5 E/35 ORANGE	239	56.704.8353.5		32
30.494.1110.6	WAK25/3 BL	193	56.303.7953.5	WKC 2,5 E/35 G2	239	56.704.9053.0	WKF 4 SL / 35/NO	19
30.494.1110.7	WAK25/3 GN	216	56.303.8053.9		239	56.704.9253.0	WKF 4 E/SL/35	31
30.494.2510.0	WAK35/3	216	56.303.8253.5	WKC 2,5 E/35 G0	239	56.704.9353.0	WKF 4 D1/2/SL/35	29
30.494.2510.6	WAK35/3 BL	193	56.303.8353.5	WKC 2,5 E/35 G-UURL	239	56.704.9953.0		31
30.494.2510.7	WAK35/3 GN	216	56.303.9053.0	WKC 2,5 SL/35	231	56.704.XX53.9		32
30.494.3021.0		80	56.303.9153.0	WKC 2,5 D2/2/SL/35	231	56.704.XX53.9		32
30.494.3021.6	WAK16/2 BL/VO	24	56.303.9353.0	WKC 2,5 D1/2/SL/35	235	56.706.0053.0	WKF 6/35	21
30.494.4021.6	WAK35/2 BL/VO	107	56.303.xx53.5		239	56.706.0053.6	WKF 6/35 BLAU	21
30.494.4121.0	WAK35/2 BLANK	24	56.303.xx53.9		239	56.706.9053.0	WKF 6SL/35	23
30.494.4121.6		81	56.351.0153.0		246	56.710.0053.0	WKF 10/35	21
30.494.4210.0		213	56.351.0153.6		246	56.710.0053.6	WKF 10/35 BLAU	21
32.530.0053.0		154	56.351.9053.0		247	56.710.9053.0	WKF 10SL/35	23
32.540.0053.0		154	56.353.0153.0		246	56.716.0053.0	WKF 16/35	21
32.550.0053.0		155	56.353.0153.6		246	56.716.0053.6	WKF 16/35 BLAU	21
32.560.0053.0		155	56.395.9053.0	RFK 1 / 95 F S35/VO	156	56.716.1153.0	WKIF 16/35 GRAU	25
32.630.0042.0	BK M 6 / 32	152	56.395.0055.0	RFK 1 / 95 F S35/VO	156	56.716.1153.6	WKIF 16/35 BLAU	25
32.640.0042.0	BK M 8 / 32	152	56.395.0155.0	RFK 1 / 95 F S35/VO	156	56.716.8153.0	WKIF 16 NT/35	25
32.650.0042.0	BK M 10 / 32	153	56.395.0255.0	RFK 1 / 95 FM S35/VO	156	56.716.9053.0	WKF 16SL/35	23
33.011.0653.0	KL 28 / 6 DS PA	214	56.395.1055.0	RFK 1 / 95 FM S35/VO	156	56.716.9153.0	WKIF 16 SL/35	25
33.041.0653.0	KL 29 / 6 DS PA	214	56.395.1255.0	RFK 1 / 95 FMK S35/VO	156	56.904.4055.0	9700 B/30 SI E14/S35/VO	128
37.702.7453.0	WKF 1,5 KOI 3L	44	56.397.0155.0		157	56.925.4055.0	9700 B/30 SI E18/S35/VO	128
37.702.7553.0	WKF 1,5 KOI 3L/SL	44	56.397.0255.0	RFK 1 / 150 FMK S35/VO	157	57.007.0053.0	SSW-V.24/TTY	553
37.702.7653.0	WKF 1,5 KOA 2L/SL	45	56.397.1255.0	RFK 1 / 185 F S35/VO	157	57.007.0153.0	SSW-V.24/RS422	553
37.702.7753.0	WKF 1,5 KOE	44	56.398.0055.0	RFK 1 / 185 FM S35/VO	158	57.007.0253.0	SSW-V.24/RS485	554
37.702.8453.0	WKF 1,5 KOI 3L-PGE	44	56.398.1055.0	RFK 1 / 240 F S35/VO	159	57.110.1555.0	9760 U/8 TKE 220 V/VO	133
37.702.8553.0	WKF 1,5 KOI 3L/SL-PGE	44	56.399.0055.0	RFK 1 / 240 F S35/VO	159	57.110.1655.0	9760 U/8 TKE 48 V/VO	133
37.702.8653.0	WKF 1,5 KOA 2L/SL-PGE	45	56.399.0155.0	RFK 1 / 240 KI S35/VO	159	57.403.6955.1	WKN2,5E / U VB SW/VO	116
37.702.8753.0	WKF 1,5 KOE-PGN	45	56.399.0255.0	RFK 1 / 240 KI S35/VO	159	57.403.7055.0	WKN2,5E / U VO	116
54.003.7553.0	9700 A / 5 S35	189	56.399.1055.0	RFK 1 / 240 FM S35/VO	159	57.404.6255.9	WK 4 EU LED+PO 24LD/VO	115
54.003.7553.6	9700 A / 5 S35 BLAU	189	56.399.1255.0	RFK 1 / 240 FMK S35/VO	159	57.404.6955.1	WK 4E/UVB SW/VO	114
54.004.7553.0	9700 A / 6 S35	189	56.404.8855.0	WKI 4 TKG-D-SL /VO	74	57.404.7055.0	WK 4E/UV /VO	114
54.004.7553.6	9700 A / 6 S35 BLAU	190	56.404.9155.0	WKI 4 NTN-D-SL /VO	74	57.404.7255.5	WK 4 EU LD +P O 24/VO	115
54.004.7753.0	9700 A / 6 ETK S35	189	56.404.9255.0	WKI 4 NT-D-SL GL/VO	73	57.404.7455.9	WK 4 EU LD -P O 24/VO	115
54.010.7553.0	9700 A / 8 S35	189	56.404.9455.0	WKI 4 N-D-SL /VO	69	57.404.7955.5	WK 4 E / U G2/VO	115
54.010.7553.6	9700 A / 8 S35 BLAU	191	56.404.9555.0	WKI 4 NT-D-SL /VO	69	57.404.8055.9	WK 4 E / U G-UJLR/VO	115
54.010.7753.0	9700 A / 8 ETK S35	189	56.404.9655.0	WKI 4 D-U /VO	72	57.404.8155.9	WK 4 E / U GU/VO	115
54.016.7753.0	9700 A / 10 S35	189	56.404.9755.0	WKI 4 D-D /VO	69	57.404.8255.5	WK 4 E / U GO/VO	115
54.016.7553.6	9700 A / 10 S35 BLAU	191	56.404.9855.0	WKI 4 D-D-SL /VO	69	57.404.8355.5	WK 4 E / U G-UJLR/VO	115
54.016.7753.6	9700 A / 10 ETK S35	189	56.503.7355.0	WKI 2,5 4 KI SL /VO	119	57.404.8455.5	WK 4 E / U LD 42V/VO	115
54.025.7553.0	9700 A / 12 S35	191	56.503.7455.0	WK 2,5 4 KI SL-NGN /VO	119	57.404.8755.5	WK 4 EU LDG +P O 24/VO	115
54.025.7553.6	9700 A / 12 S35 BLAU	191	56.503.7555.0	WK 2,5 4 KI SL-PGN /VO	119	57.404.8855.9	WK 4 E / U G2/1/VO	115
54.035.7553.0	9700 A / 16 S35	189	56.503.7655.0	WK 2,5 4 KI SL-PRT /VO	119	57.404.XX55.5		115
54.035.7553.6	9700 A / 16 S35 BLAU	189	56.503.8355.0	WK 2,5 3 D SL /VO	119	57.404.XX55.9		115
54.904.4055.0	9700 B/30 SI E14/S32/VO	129	56.503.8455.0	WK 2,5 3 D SL-NGN /VO	119	57.503.0055.0	WK 2,5 / U /VO	101
54.925.4055.0	9700 B/30 SI E18/S32/VO	129	56.503.8555.0	WK 2,5 3 D SL-PGN /VO	119	57.503.0055.6	WK 2,5 / U BL /VO	102
55.503.1053.0	WKM 2,5 / 15/VO	145	56.510.9255.0	WKI 10 SL / 35/VO	82	57.503.2055.0	WK 2,5U/8113S/H/VO	137
55.503.1053.6	WKM 2,5 / 15 BLAU/VO	145	56.510.9455.0	WKI 10 PEN/35/VO	84	57.503.2055.6	WK 2,5U/8113S/H/VO	311
55.503.1253.0	WKM 2,5 F1 / 15/VO	144	56.516.9255.0	WKI 16 SL / 35/VO	69	57.503.2155.0	WK2,5U/D/8113S/V.../VO	134
55.503.1353.0	WKM 2,5 F2 / 15/VO	144	56.516.9455.0	WKI 16 PEN/35/VO	84	57.503.2155.6	WK2,5U/D/8113S/V.../VO	312
55.504.1053.0	WKM 4 / 15/VO	145	56.535.9255.0	WKI 35 SL / 35/VO	83	57.503.2255.0	WK2,5U/D/8113S/V/LD25VO	134
55.504.1053.6	WKM 4 / 15 BLAU/VO	145	56.535.9455.0	WKI 35 PEN/35/VO	85	57.503.2255.6	WK2,5U/D/8113S/V/LD25VO	312
55.504.9153.0	WKM 4 SL / 15/VO	145	56.702.2053.0	WKF 1,5E/8113/35	37	57.503.2355.0	WK2,5U/D/8113S/V/LD50VO	135
55.703.0053.0		40	56.702.2053.6	WKF 1,5E/8113/35	309	57.503.2355.6	WK2,5U/D/8113S/V/LD50VO	313
55.703.9053.0		40	56.702.7053.0	WKF 1,5 E / 35	33	57.503.2555.6	WK2,5U/D/8113S/V/WK/VO	135
56.004.9053.0	9700 A / 6 SL 2 S35	189	56.703.0053.0	WKF 2,5 / 35	19	57.503.2555.6	WK2,5U/D/8113S/V/WK/VO	313
56.010.9053.0	9700 A / 8 SL 2 S35	189	56.703.0053.6	WKF 2,5 / 35 BLAU	19	57.503.2655.0	WK2,5U / 8113S/V.../VO	136
56.016.9053.0	9700 A / 10 SL 2 S35	189	56.703.2053.0	WKF 2,5/D2 35/8113	36	57.503.2655.6	WK2,5U / 8113S/V.../VO	310
			56.703.2053.6	WKF 2,5/D2 35/8113	308	57.503.2755.0	WK2,5U/8113S/V/LED25VO	136

contents

Part no.	Type	section / page	Part no.	Type	section / page	Part no.	Type	section / page
57.503.2755.0	WK2,5U/8113S/V/LED25/V0	310	57.806.0253.0	AKB 20MA / 10 V	504	69.920.1153.0	KL.ADA. BU. 6WL	47
57.503.2855.0	WK2,5U/8113S/V/LED50/V0	137	57.806.0353.0	AKB 4-20MA / 10 V	504	70.000.0653.0	KL.ADA. BU. 6WR	689
57.503.2855.0	WK2,5U/8113S/V/LED50/V0	311	57.806.0653.0	AKT 10 V / 20MA	505	70.005.0653.0	KL.ADA. BU. 6WR	689
57.503.3055.6	WK2,5U/8113S/V/VK/V0	137	57.806.0753.0	AKT 20MA / 10 V	505	70.010.0653.0	KL.ADA. ST. 6WL	689
57.503.3055.6	WK2,5U/8113S/V/VK/V0	311	57.806.0853.0	AKT 4-20MA / 10 V	505	70.015.0653.0	KL.ADA. ST. 6WR	689
57.503.7055.0	WK 2,5-4 KOI / U / V0	120	57.806.0953.0	AKT 10 V / 4-20MA	505	70.060.1628.0	DATENEIF. OT. 16P	755
57.503.7155.0	WK 2,5-4 KOI / U-NGN / V0	120	57.806.1053.0	AKT + 10 V / +10 V	505	70.100.0653.3	KL.ADA. BU. 6WL	631
57.503.7255.0	WK 2,5-4 KOI / U-PGN / V0	121	57.806.1153.0	AKT 20MA / 20MA	505	70.100.0653.4	KL.ADA. BU. 6WL	631
57.503.7855.0	WK 2,5-4 KI / U / V0	118	57.806.1253.0	AKT 20MA / 4-20MA	505	70.100.1053.3	KL.ADA. BU.10WL	631
57.503.7955.0	WK 2,5-4 KI / U-NGN / V0	118	57.806.1353.0	AKT 4-20MA / 20MA	505	70.100.1053.4	KL.ADA. BU.10WL	631
57.503.8055.0	WK2,5-4 KI / U-PGN / V0	118	57.806.1553.0	AKB 10 V / 4-20MA	504	70.100.1653.3	KL.ADA. BU.16WL	631
57.503.8855.0	WK 2,5-3 D / U / V0	118	57.806.2153.0	AKT + 10 V / 4-20MA	505	70.100.1653.4	KL.ADA. BU.16WL	631
57.503.8955.0	WK 2,5-3 D / U-NGN / V0	118	57.806.2253.0	AKT + 10 V / 0-10 V	505	70.100.2453.3	KL.ADA. BU.24WL	631
57.503.9055.0	WK 2,5-3 D / U-PGN / V0	118	57.806.2653.0	AKT 0-10 V / +10 V	505	70.100.2453.4	KL.ADA. BU.24WR	631
57.504.0055.0	WK 4 / U / V0	69	57.806.2753.0	AKT 0-20MA / +10 V	505	70.101.0653.0	KL.ADA. BUF 6WL	631
57.504.0055.6	WK 4 / U BL / V0	69	57.806.5553.0	AKT 4-20MA / +10 V	505	70.101.1053.0	KL.ADA. BUF10WL	631
57.504.1055.0	WK 4 / U F1 / V0	142	57.806.5653.0		505	70.101.1653.0	KL.ADA. BUF16WL	631
57.504.1155.0	WK 4 / U F2 / V0	142	57.904.0055.0	9785U/10 OHM/V0	130	70.101.2453.0	KL.ADA. BUF24WL	631
57.504.1655.0	WK 4 SI-D/U 5 X25/V0	126	57.904.0155.0	9785U/20 OHM/V0	130	70.105.0653.3	KL.ADA. BUF10WR	631
57.504.1755.0	WK 4 SI-D/U 5 X20/V0	126	57.904.0255.0	9785U/50 OHM/V0	130	70.105.0653.4	KL.ADA. BU. 6WR	631
57.504.2055.0	WK 4 TKM/U / V0	101	57.904.0355.0	9785U/100 OHM/V0	130	70.105.1053.3	KL.ADA. BU.10WR	631
57.504.2055.6	WK 4 TKM/U BL / V0	123	57.904.0455.0	9785U/200 OHM/V0	130	70.105.1053.4	KL.ADA. BU.10WR	631
57.504.2355.0	WK 4 TKM P3/U / V0	123	57.904.0555.0	9785U/500 OHM/V0	130	70.105.1653.3	KL.ADA. BU.16WR	631
57.504.2755.0	WK 4 3-6 S 1K / W / U / V0	139	57.904.0655.0	9785U/1 KOHM/V0	130	70.105.1653.4	KL.ADA. BU.16WR	631
57.504.2855.0	WK 4 3-6 S 1K / W / U / V0	139	57.904.0755.0	9785U/2 KOHM/V0	130	70.105.2453.3	KL.ADA. BU.24WR	631
57.504.3655.0	WK / 5-10S / U / V0	139	57.904.0855.0	9785U/5 KOHM/V0	130	70.105.2453.4	KL.ADA. BU.24WR	631
57.504.3755.0	WK 4 3-6 S 1K / U / V0	138	57.904.0955.0	9785U/10 KOHM/V0	130	70.106.0653.0	KL.ADA. BUF 6WR	631
57.504.3855.0	WK 4 5S2,8 1K / U / V0	138	57.904.1055.0	9785U/20 KOHM/V0	130	70.106.1053.0	KL.ADA. BUF10WR	631
57.504.4055.0	WK 4 TKG / U / V0	101	57.904.1155.0	9785U/50 KOHM/V0	130	70.106.1653.0	KL.ADA. BUF16WR	631
57.504.4455.0	WK 4 TKS D / U / V0	123	57.904.2055.0	9786U/12/V0	131	70.106.2453.0	KL.ADA. BUF24WR	631
57.504.4555.0	WK 4 TKG-TRST / U / V0	123	57.904.3955.0	9785U/10 OHM-SPT/V0	130	70.110.0653.3	KL.ADA. ST. 6WL	631
57.504.4855.0	WK 4 TKG-TRST P3 / U / V0	123	57.904.4155.0	9785U/20 OHM-SPT/V0	130	70.110.0653.4	KL.ADA. ST. 6WL	631
57.504.5055.0	WK 4/D1/2U/V0	112	57.904.4255.0	9785U/50 OHM-SPT/V0	130	70.110.1053.3	KL.ADA. ST.10WL	631
57.504.5055.6	WK 4 / D 1/2 U/V0 BLAU	112	57.904.4355.0	9785U/100 OHM-SPT/V0	130	70.110.1053.4	KL.ADA. ST.10WL	631
57.504.5155.0	WK 4/D2/2U/V0	112	57.904.4455.0	9785U/200 OHM-SPT/V0	130	70.110.1653.3	KL.ADA. ST.16WL	631
57.504.5155.6	WK 4/D2/2U BL/V0	112	57.904.4555.0	9785U/500 OHM-SPT/V0	130	70.110.1653.4	KL.ADA. ST.16WL	631
57.504.5255.0	WK 4/D E / U / V0	113	57.904.4655.0	9785U/1 KOHM-SPT/V0	130	70.110.2453.3	KL.ADA. ST.24WL	631
57.504.6255.0	WK / 4-8S / U / V0	141	57.904.4755.0	9785U/2 KOHM-SPT/V0	130	70.110.2453.4	KL.ADA. ST.24WL	631
57.504.6355.0	WK / 4-8S / W / U / V0	141	57.904.4855.0	9785U/5 KOHM-SPT/V0	130	70.111.0653.0	KL.ADA. STF 6WR	631
57.504.6655.0	WK / 3-6S / U / V0	140	57.904.4955.0	9785U/10 KOHM-SPT/V0	130	70.111.1053.0	KL.ADA. STF10WL	631
57.504.6755.0	WK / 3-6S / W / U / V0	140	57.904.5055.0	9785U/20 KOHM-SPT/V0	130	70.111.1653.0	KL.ADA. STF10WL	631
57.504.7355.0	WK 4 / 3-6S KO/U/V0	141	57.904.5155.0	9785U/50 KOHM-SPT/V0	130	70.111.2453.0	KL.ADA. STF24WL	631
57.504.8155.0	WKN 4ETK/U/V0	69	57.904.5355.0	WK 4 / THSI5 U/V0	124	70.115.0653.3	KL.ADA. ST. 6WR	631
57.504.9055.0	WK 4 SL / U / V0	69	57.904.5455.0	WK 4/THSI 5 LED 12U / V0	124	70.115.0653.4	KL.ADA. ST. 6WR	631
57.504.9155.0	WK 4/D2/2SLU / V0	113	57.904.5555.0	WK 4/THSI 5 LED 24U / V0	124	70.115.1053.3	KL.ADA. ST.10WR	631
57.504.9255.0	WK 4E SLU / V0	115	57.904.5655.0	WK 4/THSI 5 LED 60U / V0	124	70.115.1053.4	KL.ADA. ST.10WR	631
57.506.0055.0	WK 6 / U / V0	101	57.904.5755.0	WK 4/THSI 5 GL 250U / V0	124	70.115.1653.3	KL.ADA. ST.16WR	631
57.506.0055.6	WK 6 / U BL / V0	101	57.904.5855.0	WK 4/THSI 5 GL 500U / V0	124	70.115.1653.4	KL.ADA. ST.16WR	631
57.506.9055.0	WK 6 SL / U / V0	101	57.904.6355.0	WK 4/THSI6,3 U / V0	124	70.115.2453.3	KL.ADA. ST.24WR	631
57.510.0155.0	WKN 10 / U / V0	101	57.904.6455.0	WK 4/THSI6,3 LED 12U / V0	124	70.115.2453.4	KL.ADA. ST.24WR	631
57.510.0155.6	WKN10 / U BL / V0	101	57.904.6555.0	WK 4/THSI6,3 LED 24U / V0	124	70.116.0653.0	KL.ADA. STF 6WR	631
57.510.1155.0	WKI 10 / U / V0	78	57.904.6655.0	WK 4/THSI6,3 LED 60U / V0	124	70.116.1053.0	KL.ADA. STF10WR	631
57.510.1155.6	WKI 10 / U BLAU / V0	78	57.904.6755.0	WK 4/THSI6,3 GL 250U / V0	124	70.116.1653.0	KL.ADA. STF16WR	631
57.510.8155.0	WKN 10ETK/U/V0	106	57.904.6855.0	WK 4/THSI6,3 GL 500U / V0	124	70.116.2453.0	KL.ADA. STF24WR	631
57.510.8255.0	WKI 10 ETK/U/V0	80	57.904.7055.0	9786U/TSK NICH-CUNI/V0	132	70.120.0353.3	KL.ADA. BU. 3WL	643
57.510.9055.0	WKN10 SL/U / V0	101	57.904.7155.0	9786U/TSK FE-CUNI/V0	132	70.120.0353.4	KL.ADA. BU. 3WR	643
57.516.0155.0	WKN16 / U / V0	104	57.904.7255.0	9786U/TSK NICH-NI/V0	132	70.120.0653.3	KL.ADA. BU. 6WL	643
57.516.0155.6	WKN16 / U BL / V0	104	57.904.7355.0	9786U/TSK CU-CUNI/V0	132	70.120.0653.4	KL.ADA. BU. 6WL	643
57.516.1155.0	WKI 16 / U / V0	69	57.904.7455.0	9786U/TSK E-CU-A-CU/V0	132	70.120.1053.3	KL.ADA. BU.10WL	643
57.516.1155.6	WKI 16 / U BLAU / V0	69	57.910.4955.0	WK 10 / SI / U D / V0	125	70.120.1053.4	KL.ADA. BU.10WL	643
57.516.8155.0	WKN 16ETK/U/V0	107	57.910.5055.0	WK 10 / SI / U 5 X 20 / V0	101	70.121.0353.0	KL.ADAP.BUF 3P WR	643
57.516.8255.0	WKI 16 ETK/U/V0	69	57.910.5155.0	WK 10 / SI / U 5 X 25 / V0	125	70.121.0653.0	KL.ADAP.BUF 6P WR	643
57.516.9055.0	WKN16 SL/U / V0	109	57.910.5255.0	WK 10 / SI / U 5 X 30 / V0	125	70.121.1053.0	KL.ADAP.BUF10P WL	643
57.535.0155.0	WKN35 / U / V0	101	57.910.5355.0	WK 10 / SI / U 6,3 X 32 / V0	125	70.125.0353.3	KL.ADA. BU. 3WR	643
57.535.0155.6	WKN35 / U BL / V0	101	57.910.5455.0	WK 10 / SI / U 5X20M.NGL/V0	125	70.125.0353.4	KL.ADA. BU. 3WR	643
57.535.1155.0	WKI 35 / U / V0	79	57.910.5755.0	WK 10 / SIU6,3X32M.NGL/V0	125	70.125.0653.3	KL.ADA. BU. 6WR	643
57.535.1155.6	WKI 35 / U BLAU / V0	79	57.910.5855.0	WK 10 / SI / U 5X20M.GLB/V0	125	70.125.0653.4	KL.ADA. BU. 6WR	643
57.535.9055.0	WKN35 SL / U / V0	101	57.910.6155.0	WK 10 / SIU6,3X32M.GLB/V0	125	70.125.1053.3	KL.ADA. BU.10WR	643
57.570.0155.0	WKN70 / U / V0	105	59.195.0055.0	RFK 1 / 95 F PA/V0	156	70.125.1053.4	KL.ADA. BU.10WR	643
57.570.0155.6	WKN70 / U BL / V0	105	59.195.0155.0	RFK 1 / 95 K PA/V0	156	70.126.0353.0	KL.ADAP.BUF 3P WR	643
57.570.9055.0	WKN 70 SL / U	110	59.195.0255.0	RFK 1 / 95 FK PA/V0	156	70.126.0653.0	KL.ADAP.BUF 6P WR	643
57.597.0155.0	WKN150 / U / V0	105	59.195.1055.0	RFK 1 / 95 FM PA/V0	156	70.126.1053.0	KL.ADAP.BUF10P WR	643
57.597.0155.6	WKN150 / U BL / V0	105	59.195.1255.0	RFK 1 / 95 FMK PA/V0	156	70.130.0353.3	KL.ADA. ST. 3WL	643
57.603.0055.0	WKB 2,5 / U / V0	204	59.197.0155.0	RFK 1 / 150 K PA/V0	157	70.130.0353.4	KL.ADA. ST. 3WL	643
57.603.3555.0	WKB 2,5 / B / U / V0	205	59.197.0255.0	RFK 1 / 150 FK PA/V0	157	70.130.0653.3	KL.ADA. ST. 6WL	643
57.800.0053.0	24 V 1 SCHLIESSER	448	59.197.1255.0	RFK 1 / 150 FMK PA/V0	157	70.130.0653.4	KL.ADA. ST. 6WL	643
57.800.0353.0	220 V AC 1 SCHLIESSER	450	59.198.0055.0	RFK 1 / 185 F PA/V0	158	70.130.1053.3	KL.ADA. ST.10WL	643
57.800.5053.0	24/4BV 1 UMSCHALTER	448	59.198.1055.0	RFK 1 / 185 FM PA/V0	158	70.130.1053.4	KL.ADA. ST.10WL	643
57.800.5153.0	110/220V 1 UMSCHALTER	450	59.199.0055.0	RFK 1 / 240 F PA/V0	159	70.131.0353.0	KL.ADAP.STF 3P WL	643
57.800.7053.0	24 V 2 UMSCHALTER	449	59.199.0155.0	RFK 1 / 240 K PA/V0	159	70.131.0653.0	KL.ADAP.STF 6P WL	643
57.801.0053.0	WEG LEERG. F. 4A	592	59.199.0255.0	RFK 1 / 240 FK PA/V0	159	70.131.1053.0	KL.ADAP.STF10P WL	643
57.801.5053.0	WEG LEERG. F. 4A	592	59.199.1055.0	RFK 1 / 240 FM PA/V0	159	70.135.0353.3	KL.ADA. ST. 3WR	643
57.801.5153.0	WEG LEERG. F. 6A	593	59.199.1255.0	RFK 1 / 240 FMK PA/V0	159	70.135.0353.4	KL.ADA. ST. 3WR	643
57.801.5253.0	WEG LEERG. F. 8A	593	59.900.2052.0	9290 L	220	70.135.0653.3	KL.ADA. ST. 6WR	643
57.802.1053.0	UET + 10 V	506	59.900.2053.6	9290 S	220	70.135.0653.4	KL.ADA. ST. 6WR	643
57.802.1153.0	UET-P + 10 V	507	59.900.2552.0	9290 S</				

contents

Part no.	Type	section / page	Part no.	Type	section / page	Part no.	Type	section / page
70.357.1635.2	GEHAEUSEBERTEIL	637	70.500.1053.0	BUCHSENEINSATZ	631	71.331.2435.0	GEHAEUSEUNTERTEIL	634
70.357.1635.3	GEHAEUSEBERTEIL	637	70.500.1653.0	BUCHSENEINSATZ	631	71.331.2435.1	GEHAEUSEUNTERTEIL	634
70.357.2435.0	GEHAEUSEBERTEIL	637	70.500.2453.0	BUCHSENEINSATZ	631	71.333.1035.0	GEHAEUSEUNTERTEIL	635
70.357.2435.1	GEHAEUSE-OBERTEIL	637	70.500.3253.0	BUCHSENEINSATZ	631	71.333.1035.1	GEHAEUSEUNTERTEIL	635
70.357.2435.2	GEHAEUSEBERTEIL	637	70.500.4853.0	BUCHSENEINSATZ	631	71.333.1635.0	GEHAEUSEUNTERTEIL	635
70.357.2435.3	GEHAEUSEBERTEIL	637	70.510.0653.0	STECKEREINSATZ	631	71.333.1635.1	GEHAEUSEUNTERTEIL	635
70.358.1035.0	GEHAEUSEBERTEIL	637	70.510.1053.0	STECKEREINSATZ	631	71.333.2435.0	GEHAEUSEUNTERTEIL	635
70.358.1035.1	GEHAEUSEBERTEIL	637	70.510.1653.0	STECKEREINSATZ	631	71.333.2435.1	GEHAEUSEUNTERTEIL	635
70.358.1035.2	GEHAEUSEBERTEIL	637	70.510.2453.0	STECKEREINSATZ	631	71.340.1035.0	GEHAEUSEUNTERTEIL	635
70.358.1035.3	GEHAEUSEBERTEIL	637	70.510.3253.0	STECKEREINSATZ	631	71.340.1035.1	GEHAEUSEUNTERTEIL	635
70.358.1635.0	GEHAEUSEBERTEIL	637	70.510.4853.0	STECKEREINSATZ	631	71.340.1635.0	GEHAEUSEUNTERTEIL	635
70.358.1635.1	GEHAEUSEBERTEIL	637	70.700.0658.0	BUCHSENEINSATZ	631	71.340.1635.1	GEHAEUSEUNTERTEIL	635
70.358.1635.2	GEHAEUSEBERTEIL	637	70.700.1058.0	BUCHSENEINSATZ	631	71.340.2435.0	GEHAEUSEUNTERTEIL	635
70.358.1635.3	GEHAEUSEBERTEIL	637	70.700.1658.0	BUCHSENEINSATZ	631	71.340.2435.1	GEHAEUSEUNTERTEIL	635
70.358.2428.7	GEHAEUSEBERTEIL	769	70.700.2458.0	BUCHSENEINSATZ	631	71.341.1035.0	GEHAEUSEUNTERTEIL	635
70.358.2435.0	GEHAEUSEBERTEIL	637	70.700.3253.0	BUCHSENEINSATZ	631	71.341.1035.1	GEHAEUSEUNTERTEIL	635
70.358.2435.1	GEHAEUSEBERTEIL	637	70.700.4858.0	BUCHSENEINSATZ	631	71.341.1635.0	GEHAEUSEUNTERTEIL	635
70.358.2435.2	GEHAEUSEBERTEIL	637	70.710.0658.0	STECKEREINSATZ	631	71.341.1635.1	GEHAEUSEUNTERTEIL	635
70.358.2435.3	GEHAEUSEBERTEIL	637	70.710.1058.0	STECKEREINSATZ	631	71.341.2435.0	GEHAEUSEUNTERTEIL	635
70.359.1035.0	GEHAEUSEBERTEIL	637	70.710.1658.0	STECKEREINSATZ	631	71.341.2435.1	GEHAEUSEUNTERTEIL	635
70.359.1035.1	GEHAEUSEBERTEIL	637	70.710.2458.0	STECKEREINSATZ	631	71.342.1035.0	GEHAEUSEUNTERTEIL	635
70.359.1035.2	GEHAEUSEBERTEIL	637	70.710.3253.0	STECKEREINSATZ	631	71.342.1035.1	GEHAEUSEUNTERTEIL	635
70.359.1035.3	GEHAEUSEBERTEIL	637	70.710.4858.0	STECKEREINSATZ	631	71.342.1635.0	GEHAEUSEUNTERTEIL	635
70.359.1628.7	GEHAEUSEBERTEIL	769	70.940.0653.0	ADA.I.GEH.BU. 6WL	667	71.342.1635.1	GEHAEUSEUNTERTEIL	635
70.359.1635.0	GEHAEUSEBERTEIL	637	70.940.0653.4	ADA.I.GEH.BU. 06WL	667	71.342.2435.0	GEHAEUSEUNTERTEIL	635
70.359.1635.1	GEHAEUSEBERTEIL	637	70.940.1053.4	ADA.I.GEH.BU. 10WL	667	71.342.2435.1	GEHAEUSEUNTERTEIL	635
70.359.1635.2	GEHAEUSEBERTEIL	637	70.940.1053.4	ADA.I.GEH.BU. 10WL	667	71.343.1035.0	GEHAEUSEUNTERTEIL	635
70.359.1635.3	GEHAEUSEBERTEIL	637	70.940.1653.3	ADA.I.GEH.BU. 16WL	667	71.343.1035.1	GEHAEUSEUNTERTEIL	635
70.359.2435.0	GEHAEUSEBERTEIL	637	70.940.1653.4	ADA.I.GEH.BU. 16WL	667	71.343.1635.0	GEHAEUSEUNTERTEIL	635
70.359.2435.1	GEHAEUSEBERTEIL	637	70.940.2453.3	ADA.I.GEH.BU. 24WL	667	71.343.1635.1	GEHAEUSEUNTERTEIL	635
70.359.2435.2	GEHAEUSEBERTEIL	637	70.940.2453.4	ADA.I.GEH.BU. 24WL	667	71.343.2435.0	GEHAEUSEUNTERTEIL	635
70.359.2435.3	GEHAEUSEBERTEIL	637	70.945.0653.3	ADA.I.GEH.BU. 6WR	667	71.343.2435.1	GEHAEUSEUNTERTEIL	635
70.360.0628.9	GEHAEUSEBERTEIL	769	70.945.0653.4	ADA.I.GEH.BU. 6WR	667	71.350.1035.0	GEHAEUSEBERTEIL	633
70.360.1028.9	GEHAEUSEBERTEIL	769	70.945.1053.3	ADA.I.GEH.BU. 10WR	667	71.350.1035.1	GEHAEUSEBERTEIL	633
70.360.1628.9	GEHAEUSEBERTEIL	769	70.945.1053.4	ADA.I.GEH.BU. 10WR	667	71.350.1035.2	GEHAEUSEBERTEIL	633
70.360.2428.9	GEHAEUSEBERTEIL	769	70.945.1653.3	ADA.I.GEH.BU. 16WR	667	71.350.1035.3	GEHAEUSEBERTEIL	633
70.360.4828.9	GEHAEUSEBERTEIL	769	70.945.1653.4	ADA.I.GEH.BU. 16WR	667	71.350.1635.0	GEHAEUSEBERTEIL	633
70.362.0628.9	GEHAEUSEBERTEIL	769	70.945.2453.3	ADA.I.GEH.BU. 24WR	667	71.350.1635.1	GEHAEUSEBERTEIL	633
70.362.1028.9	GEHAEUSEBERTEIL	769	70.945.2453.4	ADA.I.GEH.BU. 24WR	667	71.350.1635.2	GEHAEUSEBERTEIL	633
70.362.1628.9	GEHAEUSEBERTEIL	769	70.950.0653.3	ADA.I.GEH.ST. 6WL	667	71.350.1635.3	GEHAEUSEBERTEIL	633
70.362.2428.9	GEHAEUSEBERTEIL	772	70.950.0653.4	ADA.I.GEH.ST. 06WL	667	71.350.2435.0	GEHAEUSEBERTEIL	633
70.362.4828.9	GEHAEUSEBERTEIL	769	70.950.1053.3	ADA.I.GEH.ST. 10WL	667	71.350.2435.1	GEHAEUSEBERTEIL	633
70.363.0628.9	GEHAEUSEBERTEIL	769	70.950.1053.4	ADA.I.GEH.ST. 10WL	667	71.350.2435.2	GEHAEUSEBERTEIL	633
70.363.1028.9	GEHAEUSEBERTEIL	769	70.950.1653.3	ADA.I.GEH.ST. 16WL	667	71.351.1035.0	GEHAEUSEBERTEIL	633
70.363.1628.9	GEHAEUSEBERTEIL	769	70.950.1653.4	ADA.I.GEH.ST. 16WL	667	71.351.1035.1	GEHAEUSEBERTEIL	633
70.363.2428.9	GEHAEUSEBERTEIL	769	70.950.2453.3	ADA.I.GEH.ST. 24WL	667	71.351.1035.2	GEHAEUSEBERTEIL	633
70.364.0628.9	GEHAEUSEBERTEIL	769	70.950.2453.4	ADA.I.GEH.ST. 24WL	667	71.351.1035.3	GEHAEUSEBERTEIL	633
70.364.1028.9	GEHAEUSEBERTEIL	769	70.955.0653.3	ADA.I.GEH.ST. 6WR	667	71.351.1635.0	GEHAEUSEBERTEIL	633
70.364.1628.9	GEHAEUSEBERTEIL	769	70.955.0653.4	ADA.I.GEH.ST. 6WR	667	71.351.1635.1	GEHAEUSEBERTEIL	633
70.364.4828.9	GEHAEUSEBERTEIL	769	70.955.1053.3	ADA.I.GEH.ST. 10WR	667	71.351.1635.2	GEHAEUSEBERTEIL	633
70.365.1028.9	GEHAEUSEBERTEIL	769	70.955.1053.4	ADA.I.GEH.ST. 10WR	667	71.351.1635.3	GEHAEUSEBERTEIL	633
70.365.1628.9	GEHAEUSEBERTEIL	769	70.955.1653.3	ADA.I.GEH.ST. 16WR	667	71.351.1635.0	GEHAEUSEBERTEIL	633
70.365.2428.9	GEHAEUSEBERTEIL	769	70.955.1653.4	ADA.I.GEH.ST. 16WR	667	71.351.2435.0	GEHAEUSEBERTEIL	633
70.367.1028.9	GEHAEUSEBERTEIL	769	70.955.2453.3	ADA.I.GEH.ST. 24WR	667	71.351.2435.1	GEHAEUSEBERTEIL	633
70.367.1628.9	GEHAEUSEBERTEIL	769	70.955.2453.4	ADA.I.GEH.ST. 24WR	667	71.351.2435.2	GEHAEUSEBERTEIL	633
70.367.2428.9	GEHAEUSEBERTEIL	769	70.960.0353.3	ADA.I.GEH.BU. 3WL	671	71.351.2435.3	GEHAEUSEBERTEIL	633
70.368.1028.9	GEHAEUSEBERTEIL	769	70.960.0353.4	ADA.I.GEH.BU. 3WL	671	71.352.1035.0	GEHAEUSEBERTEIL	633
70.368.1628.9	GEHAEUSEBERTEIL	769	70.960.0653.3	ADA.I.GEH.BU. 6WL	671	71.352.1035.1	GEHAEUSEBERTEIL	633
70.368.2428.9	GEHAEUSEBERTEIL	769	70.960.0653.4	ADA.I.GEH.BU. 6WL	671	71.352.1035.2	GEHAEUSEBERTEIL	633
70.369.1028.9	GEHAEUSEBERTEIL	769	70.960.1053.3	ADA.I.GEH.BU. 10WL	671	71.352.1035.3	GEHAEUSEBERTEIL	633
70.369.1628.9	GEHAEUSEBERTEIL	769	70.960.1053.4	ADA.I.GEH.BU. 10WL	671	71.352.1635.0	GEHAEUSEBERTEIL	633
70.372.0628.7	GEHAEUSEBERTEIL	773	70.965.0353.3	ADA.I.GEH.BU. 3WR	671	71.352.1635.1	GEHAEUSEBERTEIL	633
70.372.0635.0	GEHAEUSEBERTEIL	733	70.965.0353.4	ADA.I.GEH. 3WR	671	71.352.1635.2	GEHAEUSEBERTEIL	633
70.372.0635.3	GEHAEUSEBERTEIL	733	70.965.0653.3	ADA.I.GEH.BU. 6WR	671	71.352.1635.3	GEHAEUSEBERTEIL	633
70.372.1028.7	GEHAEUSEBERTEIL	773	70.965.0653.4	ADA.I.GEH.BU. 6WR	671	71.352.2435.0	GEHAEUSEBERTEIL	633
70.372.1035.0	GEHAEUSEBERTEIL	733	70.965.1053.3	ADA.I.GEH.BU. 10WR	671	71.352.2435.1	GEHAEUSEBERTEIL	633
70.372.1035.3	GEHAEUSEBERTEIL	733	70.965.1053.4	ADA.I.GEH.BU. 10WL	671	71.352.2435.2	GEHAEUSEBERTEIL	633
70.372.1628.7	GEHAEUSEBERTEIL	773	70.970.0353.3	ADA.I.GEH.ST. 3WL	671	71.352.2435.3	GEHAEUSEBERTEIL	633
70.372.1635.0	GEHAEUSEBERTEIL	733	70.970.0353.4	ADA.I.GEH.ST. 3WL	671	71.353.1035.0	GEHAEUSEBERTEIL	633
70.372.1635.3	GEHAEUSEBERTEIL	733	70.970.0653.3	ADA.I.GEH.ST. 6WL	671	71.353.1035.1	GEHAEUSEBERTEIL	633
70.372.2428.7	GEHAEUSEBERTEIL	773	70.970.0653.4	ADA.I.GEH.ST. 6WL	671	71.353.1035.2	GEHAEUSEBERTEIL	633
70.372.4828.7	GEHAEUSEBERTEIL	773	70.970.1053.3	ADA.I.GEH.ST. 10WL	671	71.353.1035.3	GEHAEUSEBERTEIL	633
70.372.4835.3	GEHAEUSEBERTEIL	733	70.970.1053.4	ADA.I.GEH.ST. 10WL	671	71.353.1635.0	GEHAEUSEBERTEIL	633
70.374.1635.0	GEHAEUSEBERTEIL	733	70.975.0353.3	ADA.I.GEH.ST. 3WR	671	71.353.1635.1	GEHAEUSEBERTEIL	633
70.374.1635.3	GEHAEUSEBERTEIL	733	70.975.0353.4	ADA.I.GEH.ST. 3WR	671	71.353.1635.2	GEHAEUSEBERTEIL	633
70.374.2435.0	GEHAEUSEBERTEIL	733	70.975.0653.3	ADA.I.GEH.ST. 6WR	671	71.353.1635.3	GEHAEUSEBERTEIL	633
70.374.2435.3	GEHAEUSEBERTEIL	733	70.975.0653.4	ADA.I.GEH.ST. 6WR	671	71.353.2435.0	GEHAEUSEBERTEIL	633
70.375.4828.9	GEHAEUSEBERTEIL	772	70.975.1053.3	ADA.I.GEH.ST. 10WR	671	71.353.2435.1	GEHAEUSEBERTEIL	633
70.375.4835.3	GEHAEUSEBERTEIL	733	70.975.1053.4	ADA.I.GEH.ST. 10WR	671	71.353.2435.2	GEHAEUSEBERTEIL	633
70.377.4828.9	GEHAEUSEBERTEIL	772	71.320.1028.0	GEHAEUSEUNTERTEIL	634	71.353.2435.3	GEHAEUSEBERTEIL	633
70.400.0340.0	BU.EINSATZ 660V	643	71.320.1628.0	GEHAEUSEUNTERTEIL	634	71.354.1035.0	GEHAEUSEBERTEIL	633
70.400.0640.0	BU.EINSATZ 660V	643	71.320.2428.0	GEHAEUSEUNTERTEIL	634	71.354.1035.1	GEHAEUSEBERTEIL	633
70.400.1040.0	BU.EINSATZ 660V	643	71.325.1028.0	GEHAEUSEUNTERTEIL	635	71.354.1035.2	GEHAEUSEBERTEIL	633
70.400.1640.0	BU.EINSATZ 660V	643	71.325.1628.0	GEHAEUSEUNTERTEIL	635	71.354.1035.3	GEHAEUSEBERTEIL	633
70.400.2040.0	BU.EINSATZ 660V	643	71.325.2428.0	GEHAEUSEUNTERTEIL	635	71.354.1635.0	GEHAEUSEBERTEIL	633
70.400.2640.0	BU.EINSATZ 660V	643	71.330.1035.0	GEHAEUSEUNTERTEIL	634	71.354.1635.1	GEHAEUSEBERTEIL	633
70.400.3240.0	BU.EINSATZ 660V	643	71.330.1035.1	GEHAEUSEUNTERTEIL	634	71.354.1635.2	GEHAEUSEBERTEIL	633
70.410.0340.0	ST.EINSATZ 660V	643	71.330.1635.0	GEHAEUSEUNTERTEIL	634	71.354.1635.3	GEHAEUSEBERTEIL	633
70.410.0640.0	ST.EINSATZ 660V	643	71.330.1635.1	GEHAEUSEUNTERTEIL	634	71.354.2435.0	GEHAEUSEBERTEIL	633
70.410.1040.0	ST.EINSATZ 660V	643	71.330.2435.0	GEHAEUSEUNTERTEIL	634	71.354.2435.1	GEHAEUSEBERTEIL	633
70.410.1640.0	ST.EINSATZ 660V	643	71.330.2435.1	GEHAEUSEUNTERTEIL	634	71.354.2435.2	GEHAEUSEBERTEIL	633
70.410.2040.0	ST.EINSATZ 660V	643	71.331.1035.0	GEHAEUSEUNTERTEIL	634	71.354.2435.3	GEHAEUSEBERTEIL	633
70.410.2640.0	ST.EINSATZ 660V	643	71.331.1035.1	GEHAEUSEUNTERTEIL	634	71.372.1035.0	GEHAEUSEBERTEIL	735
70.410.3240.0	ST.EINSATZ 660V	643	71.331.1635.0	GEHAEUSEUNTERTEIL	634	71.372.1035.1	GEHAEUSEBERTEIL	735
70.500.0653.0	BUCHSENEINSATZ	631	71.331.1635.1	GEHAEUSEUNTERTEIL	634	71.372.1635.0	GEHAEUSEBERTEIL	735

contents of
part number

contents PART NUMBER

Part no.	Type	section / page	Part no.	Type	section / page	Part no.	Type	section / page
71.372.1635.3		735	72.115.1053.4	KLADA ST.10WR	655	72.342.1035.1	GEHAUSEUNTERTEIL	651
71.374.2435.0		735	72.115.1653.0	KLADA ST.16WR	655	72.342.1635.0	GEHAUSEUNTERTEIL	651
71.374.2435.3		735	72.115.1653.4	KLADA ST.16WR	655	72.342.1635.1	GEHAUSEUNTERTEIL	651
71.940.1053.3		667	72.115.2453.0	KLADA ST.24WR	655	72.342.2435.0	GEHAUSEUNTERTEIL	651
71.940.1053.4	ADA.I.GEH.BU.10WL	667	72.115.2453.4	KLADA ST.24WR	655	72.342.2435.1	GEHAUSEUNTERTEIL	651
71.940.1653.3	ADA.I.GEH.BU.10WL	667	72.116.0653.0	KLADAP.STF.6P.WR	655	72.343.0635.0	GEHAUSEUNTERTEIL	659
71.940.1653.4	ADA.I.GEH.BU.16WL	667	72.116.1053.0	KLADAP.STF10P.WR	655	72.343.0635.1	GEHAUSEUNTERTEIL	659
71.940.2453.3	ADA.I.GEH.BU.24WL	667	72.116.1653.0	KLADAP.STF16P.WR	655	72.343.1035.0	GEHAUSEUNTERTEIL	651
71.940.2453.4	ADA.I.GEH.BU.24WL	667	72.116.2453.0	KLADAP.STF24P.WR	655	72.343.1035.1	GEHAUSEUNTERTEIL	651
71.945.1053.3	ADA.I.GEH.BU.10WR	667	72.117.1053.0	KLADA ST.4/6WR	699	72.343.1635.0	GEHAUSEUNTERTEIL	651
71.945.1053.4	ADA.I.GEH.BU.10WR	667	72.200.0653.0	BUCHSENEINSATZ	693	72.343.1635.1	GEHAUSEUNTERTEIL	651
71.945.1653.3	ADA.I.GEH.BU.16WR	667	72.203.1253.0	BU.EINSATZ.3/3/6	705	72.343.2435.0	GEHAUSEUNTERTEIL	651
71.945.1653.4	ADA.I.GEH.BU.16WR	667	72.205.0653.0	BUCHSENEINSATZ	697	72.343.2435.1	GEHAUSEUNTERTEIL	651
71.945.2453.3	ADA.I.GEH.BU.24WR	667	72.205.1053.0	BU.EINSATZ.4/6	699	72.350.0635.0	GEHAUSEBERTEIL	657
71.945.2453.4	ADA.I.GEH.BU.24WR	667	72.205.1253.0	BU.EINSATZ.6/6	703	72.350.0635.1	GEHAUSEBERTEIL	657
71.950.1053.3	ADA.I.GEH.ST.10WL	667	72.210.0653.0	ST.EINSATZ.3/3/6	705	72.350.0635.3	GEHAUSEBERTEIL	657
71.950.1053.4	ADA.I.GEH.ST.10WL	667	72.213.1253.0	ST.EINSATZ.4/6	707	72.350.1035.0	GEHAUSEBERTEIL	649
71.950.1653.3	ADA.I.GEH.ST.16WL	667	72.215.0653.0	ST.EINSATZ.4/6	699	72.350.1035.1	GEHAUSEBERTEIL	649
71.950.1653.4	ADA.I.GEH.ST.16WL	667	72.215.1053.0	ST.EINSATZ.6/6	703	72.350.1035.2	GEHAUSEBERTEIL	649
71.950.2453.3	ADA.I.GEH.ST.24WL	667	72.215.1253.0	GEHAUSEOBERTEIL	703	72.350.1035.3	GEHAUSEBERTEIL	649
71.950.2453.4	ADA.I.GEH.ST.24WL	667	72.250.1635.2	GEHAUSEOBERTEIL	705	72.350.1035.0	GEHAUSEBERTEIL	649
71.955.1053.3	ADA.I.GEH.ST.10WR	667	72.250.2435.2	BUCHSENEINSATZ	655	72.350.1635.0	GEHAUSEBERTEIL	649
71.955.1053.4	ADA.I.GEH.ST.10WR	667	72.300.0653.0	BU.EIG.ANL.	767	72.350.1635.1	GEHAUSEBERTEIL	649
71.955.1653.3	ADA.I.GEH.ST.16WR	667	72.300.0653.9	BUCHSENEINSATZ	655	72.350.1635.2	GEHAUSEBERTEIL	649
71.955.1653.4	ADA.I.GEH.ST.16WR	667	72.300.1053.0	BU.EIG.ANL.	767	72.350.1635.3	GEHAUSEBERTEIL	649
71.955.2453.3	ADA.I.GEH.ST.24WR	667	72.300.1053.9	BUCHSENEINSATZ	655	72.350.2435.0	GEHAUSEBERTEIL	649
71.955.2453.4	ADA.I.GEH.ST.24WR	667	72.300.1653.9	BU.EIG.ANL.	767	72.350.2435.1	GEHAUSEBERTEIL	649
71.960.0353.3	ADA.I.GEH.BU.3WL	671	72.300.2453.0	BUCHSENEINSATZ	655	72.350.2435.2	GEHAUSEBERTEIL	649
71.960.0353.4	ADA.I.GEH.BU.3WL	671	72.300.2453.9	BU.EIG.ANL.	767	72.350.2435.3	GEHAUSEBERTEIL	649
71.960.0653.3	ADA.I.GEH.BU.6WL	671	72.300.3253.0	BUCHSENEINSATZ	655	72.351.0635.0	GEHAUSEBERTEIL	657
71.960.0653.4	ADA.I.GEH.BU.6WL	671	72.300.4853.0	BUCHSENEINSATZ	655	72.351.0635.1	GEHAUSEBERTEIL	657
71.960.1053.3	ADA.I.GEH.BU.10WL	671	72.300.4853.9	BU.EIG.ANL.	767	72.351.0635.2	GEHAUSEBERTEIL	657
71.960.1053.4	ADA.I.GEH.BU.10WL	671	72.310.0653.0	ST.EIG.ANL.	767	72.351.0635.3	GEHAUSEBERTEIL	649
71.965.0353.3	ADA.I.GEH.BU.3WR	671	72.310.0653.9	ST.EIG.ANL.	767	72.351.1035.0	GEHAUSEBERTEIL	649
71.965.0353.4	ADA.I.GEH.BU.3WR	671	72.310.1053.0	ST.EIG.ANL.	767	72.351.1035.1	GEHAUSEBERTEIL	649
71.965.0653.3	ADA.I.GEH.BU.6WR	671	72.310.1053.9	ST.EIG.ANL.	767	72.351.1635.0	GEHAUSEBERTEIL	649
71.965.0653.4	ADA.I.GEH.BU.6WR	671	72.310.1653.9	ST.EIG.ANL.	767	72.351.1635.1	GEHAUSEBERTEIL	649
71.965.1053.3	ADA.I.GEH.BU.10WR	671	72.310.2453.0	ST.EIG.ANL.	767	72.351.1635.2	GEHAUSEBERTEIL	649
71.965.1053.4	ADA.I.GEH.BU.10WR	671	72.310.2453.9	ST.EIG.ANL.	767	72.351.1635.3	GEHAUSEBERTEIL	649
71.970.0353.3	ADA.I.GEH.ST.3WL	671	72.310.3253.0	ST.EIG.ANL.	767	72.351.2435.0	GEHAUSEBERTEIL	649
71.970.0353.4	ADA.I.GEH.ST.3WL	671	72.310.4853.0	ST.EIG.ANL.	767	72.351.2435.1	GEHAUSEBERTEIL	649
71.970.0653.3	ADA.I.GEH.ST.6WL	671	72.310.4853.9	ST.EIG.ANL.	767	72.351.2435.2	GEHAUSEBERTEIL	649
71.970.0653.4	ADA.I.GEH.ST.6WL	671	72.320.0628.0	GEHAUSEUNTERTEIL	650	72.351.2435.3	GEHAUSEBERTEIL	649
71.970.1053.3	ADA.I.GEH.ST.10WL	671	72.320.1028.0	GEHAUSEUNTERTEIL	650	72.352.0635.0	GEHAUSEBERTEIL	657
71.970.1053.4	ADA.I.GEH.ST.10WL	671	72.320.1628.0	GEHAUSEUNTERTEIL	650	72.352.0635.1	GEHAUSEBERTEIL	657
71.975.0353.3	ADA.I.GEH.ST.3WR	671	72.320.2428.0	GEHAUSEUNTERTEIL	650	72.352.0635.2	GEHAUSEBERTEIL	657
71.975.0353.4	ADA.I.GEH.ST.3WR	671	72.325.0628.0	GEHAUSEUNTERTEIL	659	72.352.0635.3	GEHAUSEBERTEIL	657
71.975.0653.3	ADA.I.GEH.ST.6WR	671	72.325.1028.0	GEHAUSEUNTERTEIL	651	72.352.1035.0	GEHAUSEBERTEIL	649
71.975.0653.4	ADA.I.GEH.ST.6WR	671	72.325.1628.0	GEHAUSEUNTERTEIL	651	72.352.1035.1	GEHAUSEBERTEIL	649
71.975.1053.3	ADA.I.GEH.ST.10WR	671	72.325.2428.0	GEHAUSEUNTERTEIL	651	72.352.1035.2	GEHAUSEBERTEIL	649
71.975.1053.4	ADA.I.GEH.ST.10WR	671	72.330.0635.0	GEHAUSEUNTERTEIL	658	72.352.1035.3	GEHAUSEBERTEIL	649
72.000.0653.0	KLADA BU.6WL	693	72.330.0635.1	GEHAUSEUNTERTEIL	658	72.352.1635.0	GEHAUSEBERTEIL	649
72.005.0653.0	KLADA BU.6WR	693	72.330.1035.0	GEHAUSEUNTERTEIL	650	72.352.1635.1	GEHAUSEBERTEIL	649
72.010.0653.0	KLADA ST.6WL	693	72.330.1035.1	GEHAUSEUNTERTEIL	650	72.352.1635.2	GEHAUSEBERTEIL	649
72.015.0653.0	KLADA ST.6WR	693	72.330.1635.0	GEHAUSEUNTERTEIL	650	72.352.1635.3	GEHAUSEBERTEIL	649
72.100.0653.0	KLADA BU.6WL	655	72.330.1635.1	GEHAUSEUNTERTEIL	650	72.352.2435.0	GEHAUSEBERTEIL	649
72.100.0653.4	KLADA BU.6WL	655	72.330.2435.0	GEHAUSEUNTERTEIL	650	72.352.2435.1	GEHAUSEBERTEIL	649
72.100.1053.0	KLADA BU.10WL	655	72.330.2435.1	GEHAUSEUNTERTEIL	650	72.352.2435.2	GEHAUSEBERTEIL	649
72.100.1053.4	KLADA BU.10WL	655	72.331.0635.0	GEHAUSEUNTERTEIL	658	72.352.2435.3	GEHAUSEBERTEIL	649
72.100.1653.0	KLADA BU.16WL	655	72.331.0635.1	GEHAUSEUNTERTEIL	658	72.353.0635.0	GEHAUSEBERTEIL	657
72.100.1653.4	KLADA BU.16WL	655	72.331.1035.0	GEHAUSEUNTERTEIL	650	72.353.0635.1	GEHAUSEBERTEIL	657
72.100.2453.0	KLADA BU.24WL	655	72.331.1035.1	GEHAUSEUNTERTEIL	650	72.353.0635.2	GEHAUSEBERTEIL	657
72.100.2453.4	KLADA BU.24WL	655	72.331.1635.0	GEHAUSEUNTERTEIL	650	72.353.0635.3	GEHAUSEBERTEIL	657
72.101.0653.0	KLADAP.BUF.6P.WL	655	72.331.1635.1	GEHAUSEUNTERTEIL	650	72.353.1035.0	GEHAUSEBERTEIL	649
72.101.1053.0	KLADAP.BUF10P.WL	655	72.331.2435.0	GEHAUSEUNTERTEIL	650	72.353.1035.1	GEHAUSEBERTEIL	649
72.101.1653.0	KLADAP.BUF16P.WL	655	72.331.2435.1	GEHAUSEUNTERTEIL	650	72.353.1035.2	GEHAUSEBERTEIL	649
72.101.2453.0	KLADAP.BUF24P.WL	655	72.333.0635.0	GEHAUSEUNTERTEIL	659	72.353.1035.3	GEHAUSEBERTEIL	649
72.105.0653.0	KLADA BU.6WR	655	72.333.1035.0	GEHAUSEUNTERTEIL	651	72.353.1635.0	GEHAUSEBERTEIL	649
72.105.0653.4	KLADA BU.6WR	655	72.333.1035.1	GEHAUSEUNTERTEIL	651	72.353.1635.1	GEHAUSEBERTEIL	649
72.105.1053.0	KLADA BU.10WR	655	72.333.1635.0	GEHAUSEUNTERTEIL	651	72.353.1635.2	GEHAUSEBERTEIL	649
72.105.1053.4	KLADA BU.10WR	655	72.333.1635.1	GEHAUSEUNTERTEIL	651	72.353.1635.3	GEHAUSEBERTEIL	649
72.105.1653.0	KLADA BU.16WR	655	72.333.2435.0	GEHAUSEUNTERTEIL	651	72.353.2435.0	GEHAUSEBERTEIL	649
72.105.1653.4	KLADA BU.16WR	655	72.333.2435.1	GEHAUSEUNTERTEIL	651	72.353.2435.1	GEHAUSEBERTEIL	649
72.105.2453.0	KLADA BU.24WR	655	72.340.0635.0	GEHAUSEUNTERTEIL	659	72.353.2435.2	GEHAUSEBERTEIL	649
72.105.2453.4	KLADA BU.24WR	655	72.340.0635.1	GEHAUSEUNTERTEIL	659	72.353.2435.3	GEHAUSEBERTEIL	649
72.106.0653.0	KLADAP.BUF.6P.WR	655	72.340.1035.0	GEHAUSEUNTERTEIL	651	72.354.0635.0	GEHAUSEBERTEIL	657
72.106.1053.0	KLADAP.BUF10P.WR	655	72.340.1035.1	GEHAUSEUNTERTEIL	651	72.354.0635.1	GEHAUSEBERTEIL	657
72.106.1653.0	KLADAP.BUF16P.WR	655	72.340.1635.0	GEHAUSEUNTERTEIL	651	72.354.0635.2	GEHAUSEBERTEIL	657
72.106.1653.4	KLADAP.BUF16P.WR	655	72.340.1635.1	GEHAUSEUNTERTEIL	651	72.354.1035.0	GEHAUSEBERTEIL	649
72.106.2453.0	KLADAP.BUF24P.WR	655	72.341.0635.0	GEHAUSEUNTERTEIL	659	72.354.1035.1	GEHAUSEBERTEIL	649
72.107.1053.0	KLADA BU.4/6WR	699	72.341.0635.1	GEHAUSEUNTERTEIL	659	72.354.1635.0	GEHAUSEBERTEIL	649
72.110.0653.0	KLADA ST.6WL	655	72.341.1635.0	GEHAUSEUNTERTEIL	651	72.354.1635.1	GEHAUSEBERTEIL	649
72.110.0653.4	KLADA ST.6WL	655	72.341.1635.1	GEHAUSEUNTERTEIL	651	72.354.1635.2	GEHAUSEBERTEIL	649
72.110.1053.0	KLADA ST.10WL	655	72.341.2435.0	GEHAUSEUNTERTEIL	651	72.354.1635.3	GEHAUSEBERTEIL	649
72.110.1053.4	KLADA ST.10WL	655	72.342.0635.0	GEHAUSEUNTERTEIL	659	72.355.1035.0	GEHAUSEBERTEIL	649
72.110.1653.0	KLADA ST.16WL	655	72.342.0635.1	GEHAUSEUNTERTEIL	659	72.355.1035.1	GEHAUSEBERTEIL	649
72.110.1653.4	KLADA ST.16WL	655	72.342.1035.0	GEHAUSEUNTERTEIL	651			
72.110.2453.0	KLADA ST.24WL	655	72.342.1035.1	GEHAUSEUNTERTEIL	651			
72.110.2453.4	KLADA ST.24WL	655						
72.111.0653.0	KLADAP.STF.6P.WL	655						
72.111.1053.0	KLADAP.STF10P.WL	655						
72.111.1653.0	KLADAP.STF16P.WL	655						
72.111.2453.0	KLADAP.STF24P.WL	655						
72.115.0653.0	KLADA ST.6WR	655						
72.115.0653.4	KLADA ST.6WR	655						
72.115.1053.0	KLADA ST.10WR	655						

contents

Part no.	Type	section / page	Part no.	Type	section / page	Part no.	Type	section / page
72.355.1035.2	GEHAEUSEBERTEIL	649	72.950.0653.4		669	73.352.4035.0	GEHAEUSEBERTEIL	709
72.355.1035.3	GEHAEUSEBERTEIL	649	72.950.1053.0	ADA.I.GEH.ST.10WL	669	73.352.4035.1	GEHAEUSEBERTEIL	709
72.355.1635.0	GEHAEUSEBERTEIL	649	72.950.1053.4		669	73.352.4035.2	GEHAEUSEBERTEIL	709
72.355.1635.1	GEHAEUSEBERTEIL	649	72.950.1653.0	ADA.I.GEH.ST.16WL	669	73.352.4035.3	GEHAEUSEBERTEIL	709
72.355.1635.2	GEHAEUSEBERTEIL	649	72.950.1653.4		669	73.352.6435.0	GEHAEUSEBERTEIL	727
72.355.1635.3	GEHAEUSEBERTEIL	649	72.950.2453.0	ADA.I.GEH.ST.24WL	669	73.352.6435.1	GEHAEUSEBERTEIL	727
72.355.2435.0	GEHAEUSEBERTEIL	649	72.950.2453.4		669	73.352.6435.2	GEHAEUSEBERTEIL	727
72.355.2435.1	GEHAEUSEBERTEIL	649	72.955.0653.0	ADA.I.GEH.ST. 6WR	669	73.352.6435.3	GEHAEUSEBERTEIL	727
72.355.2435.2	GEHAEUSEBERTEIL	649	72.955.0653.4		669	73.353.0645.1		684
72.355.2435.3	GEHAEUSEBERTEIL	649	72.955.1053.0	ADA.I.GEH.ST.10WR	669	73.353.1035.0	GEHAEUSEBERTEIL	749
72.356.1035.0	GEHAEUSEBERTEIL	649	72.955.1053.4		669	73.353.1035.1	GEHAEUSEBERTEIL	749
72.356.1035.1	GEHAEUSEBERTEIL	649	72.955.1653.0	ADA.I.GEH.ST.16WR	669	73.353.1035.2	GEHAEUSEBERTEIL	749
72.356.1035.2	GEHAEUSEBERTEIL	649	72.955.1653.4		669	73.353.1035.3	GEHAEUSEBERTEIL	749
72.356.1035.3	GEHAEUSEBERTEIL	649	72.955.2453.0	ADA.I.GEH.ST.24WR	669	73.353.1045.1		684
72.356.1635.0	GEHAEUSEBERTEIL	649	72.955.2453.4		669	73.353.4035.0	GEHAEUSEBERTEIL	709
72.356.1635.1	GEHAEUSEBERTEIL	649	73.100.4053.0	KL.ADA. BU.40WL	719	73.353.4035.1	GEHAEUSEBERTEIL	709
72.356.1635.2	GEHAEUSEBERTEIL	649	73.100.6453.0	KL.ADA. BU.64WL	719	73.353.4035.2	GEHAEUSEBERTEIL	709
72.356.1635.3	GEHAEUSEBERTEIL	649	73.105.4053.0	KL.ADA. BU.40WR	719	73.353.4035.3	GEHAEUSEBERTEIL	709
72.356.2435.0	GEHAEUSEBERTEIL	649	73.105.6453.0	KL.ADA. BU.64WR	719	73.353.4045.1		684
72.356.2435.1	GEHAEUSEBERTEIL	649	73.110.4053.0	KL.ADA. ST.40WL	719	73.353.6435.0	GEHAEUSEBERTEIL	727
72.356.2435.2	GEHAEUSEBERTEIL	649	73.110.6453.0	KL.ADA. ST.64WL	719	73.353.6435.1	GEHAEUSEBERTEIL	727
72.356.2435.3	GEHAEUSEBERTEIL	649	73.115.4053.0	KL.ADA. ST.40WR	719	73.353.6435.2	GEHAEUSEBERTEIL	727
72.357.1035.0	GEHAEUSEBERTEIL	649	73.115.6453.0	KL.ADA. ST.64WR	719	73.353.6435.3	GEHAEUSEBERTEIL	727
72.357.1035.1	GEHAEUSEBERTEIL	649	73.300.0353.0	BUCHSENEINSATZ	713	73.353.6445.1		684
72.357.1035.2	GEHAEUSEBERTEIL	649	73.300.0453.0	BUCHSENEINSATZ	713	73.354.1035.0	GEHAEUSEBERTEIL	749
72.357.1035.3	GEHAEUSEBERTEIL	649	73.310.0353.0	STECKEREINSATZ	713	73.354.1035.1	GEHAEUSEBERTEIL	749
72.357.1635.0	GEHAEUSEBERTEIL	649	73.310.0453.0	STECKEREINSATZ	713	73.354.1035.2	GEHAEUSEBERTEIL	749
72.357.1635.1	GEHAEUSEBERTEIL	649	73.326.4028.0	GEHAEUSEUNTERTEIL	729	73.354.1035.3	GEHAEUSEBERTEIL	749
72.357.1635.2	GEHAEUSEBERTEIL	649	73.326.6428.0	GEHAEUSEUNTERTEIL	729	73.354.4035.0	GEHAEUSEBERTEIL	727
72.357.1635.3	GEHAEUSEBERTEIL	649	73.327.4028.0	GEHAEUSEUNTERTEIL	731	73.354.4035.1		727
72.357.2435.0	GEHAEUSEBERTEIL	649	73.327.6428.0	GEHAEUSEUNTERTEIL	731	73.354.4035.2		727
72.357.2435.1	GEHAEUSEBERTEIL	649	73.330.4035.0	GEHAEUSEUNTERTEIL	729	73.354.4035.3		727
72.357.2435.2	GEHAEUSEBERTEIL	649	73.330.4035.1	GEHAEUSEUNTERTEIL	729	73.354.6435.0	GEHAEUSEBERTEIL	727
72.357.2435.3	GEHAEUSEBERTEIL	649	73.330.6435.0	GEHAEUSEUNTERTEIL	729	73.354.6435.1		727
72.358.1035.0	GEHAEUSEBERTEIL	649	73.330.6435.1	GEHAEUSEUNTERTEIL	729	73.354.6435.2		727
72.358.1035.1	GEHAEUSEBERTEIL	649	73.331.4035.0	GEHAEUSEUNTERTEIL	729	73.354.6435.3		727
72.358.1035.2	GEHAEUSEBERTEIL	649	73.331.4035.1	GEHAEUSEUNTERTEIL	729	73.355.4035.0	GEHAEUSEBERTEIL	727
72.358.1035.3	GEHAEUSEBERTEIL	649	73.331.6435.0	GEHAEUSEUNTERTEIL	729	73.355.4035.1	GEHAEUSEBERTEIL	727
72.358.1635.0	GEHAEUSEBERTEIL	649	73.331.6435.1	GEHAEUSEUNTERTEIL	729	73.355.4035.2	GEHAEUSEBERTEIL	727
72.358.1635.1	GEHAEUSEBERTEIL	649	73.333.4035.0	GEHAEUSEUNTERTEIL	729	73.355.4035.3	GEHAEUSEBERTEIL	727
72.358.1635.2	GEHAEUSEBERTEIL	649	73.333.4035.1	GEHAEUSEUNTERTEIL	729	73.355.6435.0	GEHAEUSEBERTEIL	727
72.358.1635.3	GEHAEUSEBERTEIL	649	73.333.6435.0	GEHAEUSEUNTERTEIL	729	73.355.6435.1	GEHAEUSEBERTEIL	727
72.358.2435.0	GEHAEUSEBERTEIL	649	73.333.6435.1	GEHAEUSEUNTERTEIL	729	73.355.6435.2	GEHAEUSEBERTEIL	727
72.358.2435.1	GEHAEUSEBERTEIL	649	73.334.4035.0	GEHAEUSEUNTERTEIL	638	73.355.6435.3	GEHAEUSEBERTEIL	727
72.358.2435.2	GEHAEUSEBERTEIL	649	73.334.4035.1	GEHAEUSEUNTERTEIL	638	73.357.4035.0	GEHAEUSEBERTEIL	709
72.358.2435.3	GEHAEUSEBERTEIL	649	73.334.6435.0	GEHAEUSEUNTERTEIL	638	73.357.4035.1	GEHAEUSEBERTEIL	709
72.359.1035.0	GEHAEUSEBERTEIL	649	73.334.6435.1	GEHAEUSEUNTERTEIL	638	73.357.4035.2	GEHAEUSEBERTEIL	709
72.359.1035.1	GEHAEUSEBERTEIL	649	73.335.4035.0	GEHAEUSEUNTERTEIL	638	73.357.4035.3	GEHAEUSEBERTEIL	709
72.359.1035.2	GEHAEUSEBERTEIL	649	73.335.4035.1	GEHAEUSEUNTERTEIL	638	73.357.6435.0	GEHAEUSEBERTEIL	727
72.359.1035.3	GEHAEUSEBERTEIL	649	73.335.6435.0	GEHAEUSEUNTERTEIL	638	73.357.6435.1	GEHAEUSEBERTEIL	727
72.359.1635.0	GEHAEUSEBERTEIL	649	73.335.6435.1	GEHAEUSEUNTERTEIL	638	73.357.6435.2	GEHAEUSEBERTEIL	727
72.359.1635.1	GEHAEUSEBERTEIL	649	73.337.4035.0	GEHAEUSEUNTERTEIL	639	73.357.6435.3	GEHAEUSEBERTEIL	727
72.359.1635.2	GEHAEUSEBERTEIL	649	73.337.4035.1	GEHAEUSEUNTERTEIL	639	73.358.4035.0	GEHAEUSEBERTEIL	709
72.359.1635.3	GEHAEUSEBERTEIL	649	73.337.6435.0	GEHAEUSEUNTERTEIL	639	73.358.4035.1	GEHAEUSEBERTEIL	709
72.359.2435.0	GEHAEUSEBERTEIL	649	73.337.6435.1	GEHAEUSEUNTERTEIL	639	73.358.4035.2	GEHAEUSEBERTEIL	709
72.359.2435.1	GEHAEUSEBERTEIL	649	73.340.4035.0	GEHAEUSEUNTERTEIL	731	73.358.4035.3	GEHAEUSEBERTEIL	709
72.359.2435.2	GEHAEUSEBERTEIL	649	73.340.4035.1	GEHAEUSEUNTERTEIL	731	73.358.6435.0	GEHAEUSEBERTEIL	727
72.359.2435.3	GEHAEUSEBERTEIL	649	73.340.6435.0	GEHAEUSEUNTERTEIL	731	73.358.6435.1	GEHAEUSEBERTEIL	727
72.372.1035.0	GEHAEUSEBERTEIL	733	73.340.6435.1	GEHAEUSEUNTERTEIL	731	73.358.6435.2	GEHAEUSEBERTEIL	727
72.372.1035.3	GEHAEUSEBERTEIL	733	73.341.4035.0	GEHAEUSEUNTERTEIL	731	73.358.6435.3	GEHAEUSEBERTEIL	727
72.372.1635.0	GEHAEUSEBERTEIL	733	73.341.4035.1	GEHAEUSEUNTERTEIL	731	73.359.4035.0	GEHAEUSEBERTEIL	727
72.372.1635.3	GEHAEUSEBERTEIL	733	73.341.6435.0	GEHAEUSEUNTERTEIL	731	73.359.4035.1		727
72.372.2435.0	GEHAEUSEBERTEIL	733	73.341.6435.1	GEHAEUSEUNTERTEIL	731	73.359.4035.2		727
72.372.2435.3	GEHAEUSEBERTEIL	733	73.342.4035.0	GEHAEUSEUNTERTEIL	731	73.359.4035.3		727
72.374.2435.0	GEHAEUSEBERTEIL	733	73.342.4035.1	GEHAEUSEUNTERTEIL	731	73.359.6435.0	GEHAEUSEBERTEIL	727
72.374.2435.3	GEHAEUSEBERTEIL	733	73.342.6435.0	GEHAEUSEUNTERTEIL	731	73.359.6435.1		727
72.700.0658.0	BUCHSENEINSATZ	655	73.342.6435.1	GEHAEUSEUNTERTEIL	731	73.359.6435.2		727
72.700.1058.0	BUCHSENEINSATZ	655	73.343.4035.0	GEHAEUSEUNTERTEIL	731	73.359.6435.3		749
72.700.1658.0	BUCHSENEINSATZ	655	73.343.4035.1	GEHAEUSEUNTERTEIL	731	73.700.0753.0	BUCHSENEINSATZ	713
72.700.2458.0	BUCHSENEINSATZ	655	73.343.6435.0	GEHAEUSEUNTERTEIL	731	73.700.0853.0	BUCHSENEINSATZ	719
72.700.3258.0	BUCHSENEINSATZ	655	73.343.6435.1	GEHAEUSEUNTERTEIL	731	73.700.1553.0	BUCHSENEINSATZ	719
72.700.4858.0	BUCHSENEINSATZ	655	73.344.4035.0	GEHAEUSEUNTERTEIL	639	73.700.2553.0	BUCHSENEINSATZ	719
72.710.0658.0	STECKEREINSATZ	655	73.344.4035.1	GEHAEUSEUNTERTEIL	639	73.700.4058.0	BUCHSENEINSATZ	719
72.710.1058.0	STECKEREINSATZ	655	73.344.6435.0	GEHAEUSEUNTERTEIL	639	73.700.6458.0	BUCHSENEINSATZ	719
72.710.1658.0	STECKEREINSATZ	655	73.344.6435.1	GEHAEUSEUNTERTEIL	639	73.710.0753.0	STECKEREINSATZ	713
72.710.2458.0	STECKEREINSATZ	655	73.345.4035.0	GEHAEUSEUNTERTEIL	639	73.710.0853.0	STECKEREINSATZ	713
72.710.3258.0	STECKEREINSATZ	655	73.345.4035.1	GEHAEUSEUNTERTEIL	639	73.710.1553.0	STECKEREINSATZ	719
72.710.4858.0	STECKEREINSATZ	655	73.345.6435.0	GEHAEUSEUNTERTEIL	639	73.710.2553.0	STECKEREINSATZ	719
72.940.0653.0	ADA.I.GEH.BU. 6WL	669	73.345.6435.1	GEHAEUSEUNTERTEIL	639	73.710.4058.0	STECKEREINSATZ	719
72.940.0653.4		669	73.346.4035.0	GEHAEUSEUNTERTEIL	639	73.710.6458.0	STECKEREINSATZ	719
72.940.1053.0	ADA.I.GEH.BU.10WL	669	73.346.4035.1	GEHAEUSEUNTERTEIL	639	75.012.0053.0	BUCHSENTEIL	758
72.940.1053.4		669	73.346.6435.0	GEHAEUSEUNTERTEIL	639	75.012.5053.0	STECKERTEIL	758
72.940.1653.0	ADA.I.GEH.BU.16WL	669	73.346.6435.1	GEHAEUSEUNTERTEIL	639	75.013.0051.0	OBERTEIL	758
72.940.1653.4		669	73.347.4035.0	GEHAEUSEUNTERTEIL	639	75.013.0051.2	OBERTEIL	758
72.940.2453.0	ADA.I.GEH.BU.24WL	669	73.347.4035.1	GEHAEUSEUNTERTEIL	639	75.013.5051.0	UNTERTEIL	758
72.940.2453.4		669	73.347.6435.0	GEHAEUSEUNTERTEIL	639	75.900.0035.0	GEH.UT. TEIL F	664
72.945.0653.0	ADA.I.GEH.BU. 6WR	669	73.347.6435.1	GEHAEUSEUNTERTEIL	639	75.900.0135.0	GEH.OT. TEIL L	664
72.945.0653.4		669	73.350.4035.0	GEHAEUSEBERTEIL	727	75.931.1635.0	GEH.UT. TEIL F	664
72.945.1053.0	ADA.I.GEH.BU.10WR	669	73.350.4035.1	GEHAEUSEBERTEIL	727	75.931.2435.0	GEH.UT. TEIL F	664
72.945.1053.4		669	73.350.4035.2	GEHAEUSEBERTEIL	727	75.933.1635.0	GEH.UT. TEIL F	664
72.945.1653.0	ADA.I.GEH.BU.16WR	669	73.350.4035.3	GEHAEUSEBERTEIL	727	75.933.2435.0	GEH.UT. TEIL F	664
72.945.1653.4		669	73.350.6435.0	GEHAEUSEBERTEIL	727	75.934.2435.0	GEH.UT. TEIL F	664
72.945.2453.0	ADA.I.GEH.BU.24WR	669	73.350.6435.1	GEHAEUSEBERTEIL	727	75.941.1635.0	GEH.UT. TEIL F	664
72.945.2453.4		669	73.350.6435.2	GEHAEUSEBERTEIL	727	75.941.2435.0	GEH.UT. TEIL F	664
72.950.0653.0	ADA.I.GEH.ST. 6WL	669	73.350.6435.3	GEHAEUSEBERTEIL	727	75.950.1635.0	GEH.OT. TEIL L	664

contents

Part no.	Type	section / page	Part no.	Type	section / page	Part no.	Type	section / page
77.955.1053.0	ADA.I.GEH.ST.10WR	669	81.000.6031.0	WIPOS 24VDC/5,0A 1PH H	520	87.090.0053.0	WEB1001 LEERG.B9	587
77.955.1053.4		669	81.000.6040.0	WIPOS 24VDC/10A 1PH V	519	87.110.6253.0	TMS-101-250V5A	539
77.955.1653.0	ADA.I.GEH.ST.16WR	669	81.000.6041.0	WIPOS 24VDC/10A 1PH H	520	87.200.2200.3	BUCHSE D-SUB 9	560
77.955.1653.4		669	81.000.6050.0	WIPOS 24VDC/20A 1PH V	519	87.200.2201.3	BUCHSE D-SUB 15	560
77.955.2453.0	ADA.I.GEH.ST.24WR	669	81.000.6051.0	WIPOS 24VDC/20A 1PH H	521	87.200.2202.3	BUCHSE D-SUB 25	560
77.955.2453.4		669	81.000.6053.0	WIPOS 24VDC/20A 3PH H	522	87.200.2203.3	BUCHSE D-SUB 37	560
78.000.0653.0	REVOS MOD.RAHM.BU	742	81.000.6063.0	WIPOS 24VDC/40A 3PH H	522	87.200.2204.3	BUCHSE D-SUB 50	560
78.000.1053.0	REVOS MOD.RAHM.BU	739	81.010.1000.0	DR-400V-250V3A	543	87.200.2205.3	STECKER D-SUB 9	560
78.000.1653.0	REVOS MOD.RAHM.BU	742	81.020.3000.0	WRS-TIMER-250V5A	463	87.200.2206.3	STECKER D-SUB 15	560
78.000.2453.0	REVOS MOD.RAHM.BU	742	81.020.4100.0	FLARE-TIMER-S-250V6A	462	87.200.2207.3	STECKER D-SUB 25	560
78.001.2053.0	REVOS MODULBU.20P	740	81.020.4101.0	FLARE-PID/0100-S-250V6A	462	87.200.2208.3	STECKER D-SUB 37	560
78.002.1053.0	REVOS MODULBU.10P	740	81.020.4102.0	FLARE-PID/0060-S-250V6A	462	87.200.2209.3	STECKER D-SUB 50	560
78.003.0453.0	REVOS MODULBU.4P	740	82.011.3004.0	DIPOS PT100-3 0-400C	499	87.210.2201.3	FLK-SR 10	561
78.003.0553.0	REVOS MODULBU.5P	740	82.011.30XX.0		499	87.210.2202.3	FLK-SR 14	561
78.004.0353.0	REVOS MODULBU.3P	739	82.011.37XX.0		499	87.210.2203.3	FLK-SR 16	561
78.010.0653.0	REVOS MOD.RAHM.ST	742	82.011.38XX.0		499	87.210.2204.3	FLK-SR 20	561
78.010.1053.0	REVOS MOD.RAHM.ST	739	82.011.40XX.0		499	87.210.2205.3	FLK-SR 26	561
78.010.1653.0	REVOS MOD.RAHM.ST	742	82.011.47XX.0		499	87.210.2207.3	FLK-SR 34	561
78.010.2453.0	REVOS MOD.RAHM.ST	742	82.011.48XX.0		499	87.210.2208.3	FLK-SR 40	561
78.011.2053.0	REVOS MODULST.20P	740	82.021.08XX.0		500	87.210.2210.3	FLK-SR 50	561
78.012.1053.0	REVOS MODULST.10P	740	82.021.1812.0	DIPOS TC-K 0-1200C	500	87.210.2211.3	FLK-SR 60	561
78.013.0453.0	REVOS MODULST.4P	740	82.021.18XX.0		500	87.210.2212.3	FLK-SR 64	561
78.013.0553.0	REVOS MODULST.5P	740	82.081.0000.0	DIPOS KSQ 9.5 .. 10.5V	508	87.220.0753.3	M - PB 4 SP	482
78.014.0353.0	REVOS MODULST.3P	739	83.030.0000.1	RICOS BC-DP	410	87.220.0853.3	M - PB 8 SP	482
80.010.0005.0	WRS-REL-1S-250V5A	460	83.030.0001.1	RICOS EC-DP	414	87.220.1353.3	M - PB 1 SR	482
80.010.0007.0	WRS-REL-1S-48V20M	460	83.030.0010.0	RICOS SOCKET KNOT-DP	410	87.220.1453.3	M - PB 4 SG	483
80.010.0008.0	WRS-REL-1W-250V5A	460	83.030.0011.0	RICOS SOCKET FINAL-DP	410	87.220.1553.3	M - PB 8 SG	483
80.010.0009.0	WRS-REL-1W-48V20M	460	83.030.0012.0		410	87.220.1853.0	RAB - SS 4	454
80.010.0010.0	WRS-REL-1W-250V16	461	83.030.1000.1	RICOS DP 16 I	428	87.220.1953.3	RAB-FSS 8	454
80.010.0011.0	WR1-230-1W-250V4A	456	83.030.1100.1	RICOS DP 8 I/0	428	87.220.2253.3	RAB-FSS 16	454
80.010.1002.0	WRS-REL-2W-48V20M	461	83.030.1200.1	RICOS DP 16 0	428	87.220.4753.3	RAB - SS 4/2	455
80.010.1003.0	WRS-REL-2W-250V5A	461	83.030.1300.1	RICOS DP 8I 8I/0	428	87.220.4853.3	RAB - SS 8/2	455
80.010.1100.0	WR1-DUO-2W-250V5A	458	83.031.0000.1	RICOS BC-S	410	87.220.7553.0	R12-12V-W-LED	454
80.010.1102.0	WR4-115-1W-250V4A	456	83.031.0001.1	RICOS EC-S	414	87.221.5553.0	RAB - SS 4 M	454
80.010.1104.0	WR4-115-2W-250V4A	458	83.031.0010.0	RICOS SOCKET FEMALE-S	410	87.221.5853.0	FRONTSTECKER 115	562
80.010.1106.0	WR4-230-1W-250V4A	457	83.031.0011.0	RICOS SOCKET MALE-S	410	87.221.5953.0	EAS-UE/D-115	562
80.010.1108.0	WR4-230-2W-250V4A	459	83.031.1000.1	RICOS S 16 I	428	87.221.6053.0	EAS-UE/D-L-115	562
80.010.1110.0	WR8-115-1W-250V4A	456	83.031.1100.1	RICOS S 8 I/0	428	87.221.6353.0	UEBERGABE UNIVERSAL-S5	563
80.010.1112.0	WR8-115-2W-250V4A	458	83.031.1200.1	RICOS S 16 0	428	87.221.6653.0	RAB - FS16 W A-S5	566
80.010.1114.0	WR8-230-1W-250V4A	457	83.031.1300.1	RICOS S 8I 8I/0	428	87.221.6753.0	RAB - FS16 W B-S5	566
80.010.1116.0	WR8-230-2W-250V4A	459	83.032.0000.1	RICOS BC-CAN-DN	411	87.222.5853.0	FRONTSTECKER 135/150	564
80.010.4005.0	FLARE-24V-1W-48V20M	442	83.032.0001.1	RICOS EC-CAN-DN	415	87.222.5953.0	EAS-UE / D-135	564
80.010.4100.0	FLARE-24DC-1W-250V6A-F	442	83.032.1000.1	RICOS CAN-DN 16 I	429	87.222.6053.0	EAS-UE / D-L-135	564
80.010.4101.0	FLARE-24V-1S-250V6A-HA	446	83.032.1100.1	RICOS CAN-DN 8 I/0	429	87.222.6353.0	UEBERGABE UNIVERSAL-S5	565
80.010.4103.0	FLARE-24DC-2W-250V6A-F	443	83.032.1200.1	RICOS CAN-DN 16 0	429	87.230.0453.0	FSR-25VAC-5V1A	528
80.010.4105.0	FLARE-24V-1W-48V20M-F	442	83.032.1300.1	RICOS CAN-DN 8I 8I/0	429	87.230.0553.0	FSR-25VAC-12V1A	528
80.010.4106.0	FLARE-12DC-1W-250V6A-F	442	83.033.0000.1	RICOS BC-CANOPEN	411	87.230.0653.0	FSR-25VAC-15V1A	528
80.010.4120.0	FLARE-24V-1W-250V6A-CJT	446	83.033.0001.1	RICOS EC-CANOPEN	415	87.230.0753.0	FSR-28VAC-24V1A	528
80.010.4131.0	FLARE-110V-1W-250V6A-F	442	83.033.1000.1	RICOS CANOPEN 16 I	429	87.230.1553.0	WPS-T115/230-60VA	525
80.010.4141.0	FLARE-230V-1W-250V6A-F	442	83.033.1100.1	RICOS CANOPEN 8 I/0	429	87.230.2053.0	BGL-40VAC-3ADC	526
80.020.0004.0	WRS-SSAC1-250V6A	481	83.033.1200.1	RICOS CANOPEN 16 0	429	90.100.0554.0	300	182
80.020.2001.0	WRS-SSAC1-250V4A	481	83.033.1300.1	RICOS CANOPEN 8I 8I/0	429	90.100.0754.0	301	182
80.020.2003.0	WRS-SSDC-60V3A	480	83.034.0000.1		412	90.100.0854.0	303	182
80.020.2004.0	WRS-SSDC-60V5A	480	83.035.1210.1		420	90.100.1054.0	305	182
80.020.4100.0	FLARE-24VDC/48VDC-0,5A	478	83.035.3000.1	RICOS 16 I	416	90.100.1154.0	300 B	182
80.020.4101.0	FLARE-24VDC/48VDC-2A	478	83.035.3005.1		420	90.100.1254.0	300 K	182
80.020.4102.0	FLARE-115V/48VDC-0,5A	478	83.035.3100.1	RICOS 8 I/0	416	90.100.1354.0	300 B K	182
80.020.4103.0	FLARE-230VAC/48VDC-0,5A	479	83.035.3200.1	RICOS 16 0	419	90.100.1454.0	301 K	182
80.020.4150.0	FLARE-24VDC/230VAC-0,5A	479	83.035.3300.1	RICOS 8I 8I/0	419	90.100.1554.0	303 K	182
80.020.6000.0	CEMOS-SSAC3-400V-2A	537	83.035.4000.1	RICOS 4A I / +10V	424	90.100.1654.0	305 K	182
80.020.6003.0	CEMOS-SSPHC-400V-2,5A	537	83.035.4001.1	RICOS 4A I / 10V	424	90.800.1055.1	319 / 13.5 K SCHW.	182
80.060.0000.1	DIPOS UMC 12,5	582	83.035.4010.1	RICOS 4A I / 20MA	426	90.800.1055.8	319 / 13.5 K ELFB.	182
80.060.0001.1	DIPOS UMC 12,5	582	83.035.4040.1	RICOS 4A I / PT100	423	90.800.2055.1	319 / 17.5 K SCHW.	182
80.060.0010.1	DIPOS PT100	499	83.035.4050.1	RICOS 4A I / TC	423	90.800.2055.8	319 / 17.5 K ELFB.	182
80.060.0011.1	DIPOS PT100	499	83.035.4100.1	RICOS 4A14A0 / +10V	425	90.810.3055.0	315 GK	182
80.060.0020.1	DIPOS KSQ	508	83.035.4101.1	RICOS 4A14A0 / 10V	425	90.811.3055.0	315 GC	182
80.060.0021.1	DIPOS KSQ	508	83.035.4110.1	RICOS 4A14A0 / 20MA	427	93.001.1055.0	ST28/10 B/V0	219
80.060.0030.1	DIPOS TC	500	83.035.4111.1	RICOS 4A14A0 / 4-20MA	427	93.002.1055.0	ST28/10 S/V0	219
80.060.0031.1	DIPOS TC	500	83.035.5000.1	RICOS 4I AC 115V	417	93.003.1055.0	ST28/10 BS/V0	219
80.060.1000.1		582	83.035.5005.1	RICOS 4I AC 230V	417	93.004.0056.0	RSV 2 GRAU	207
80.060.1001.1		582	83.035.5200.1	RICOS 40 RELAY	418	93.004.0056.6	RSV 2 BLAU	207
80.060.2000.1		583	83.035.5400.1	RICOS COUNTER	422	93.031.2055.0	ST25/5 B/V0	218
80.060.2001.1		583	83.035.5410.1	RICOS POSITION	422	93.032.2055.0	ST25/5 S/V0	218
80.061.0010.3	dipos EM	582	83.039.0000.0		416	93.032.2455.0	ST25/5 SV/V0	218
80.061.1010.3		582	83.039.0000.1	RICOS PV-A	416	93.101.2053.0	ST29/10 BC	320
80.061.2010.3		583	86.010.0053.0	WEB1001 LEERG.B1	584	93.102.0055.0	ST29/10 S/V0	205
80.063.4001.1		444	86.020.0053.0	WEB1001 LEERG.B2	584	95.000.0006.0		801
80.063.4009.1		444	86.030.0053.0	WEB1001 LEERG.B3	585	95.000.0007.0		801
80.063.4021.1		444	86.030.6353.0	DNU-H-400V-250V4A	542	95.000.0008.0		801
80.063.4023.1		444	87.010.0053.0	WEB1001 LEERG.B1	584	95.101.0612.0	CZ 0,5 -2,5 MM2 F.RV2/S	207
80.063.4025.1		444	87.010.2053.0	SSM-7E230V	541	95.101.0800.0	GRUNDZANGE	291
80.063.4026.1		444	87.010.7453.0	SBS-4SI-230V6,3A	540	95.101.0800.0	GRUNDZANGE	631
80.063.4029.3	FLARE MOVE BZ SERIE 38	444	87.010.7653.0	SBS-4SI-24V6,3A	540	95.101.0800.0	GRUNDZANGE	798
80.063.4031.0		444	87.020.0053.0	WEB1001 LEERG.B2	584	95.101.0900.0	PRESSWERKZEUG	798
80.063.4031.1		444	87.030.0053.0	WEB1001 LEERG.B3	585	95.101.1000.0	PRESSWERKZEUG	798
80.063.4032.0		444	87.030.1053.0	SSM-7E230V-250V5A	541	95.101.1100.0	PRESSWERKZEUG	799
80.063.4032.1		444	87.030.6353.0	DNU-U-400V-250V4A	542	95.101.1200.0	PRESSWERKZEUG	799
80.063.4034.0		445	87.030.6453.0	DSU-400V-250V4A	542	95.350.0100.0	ABISOLIERZANGE	799
80.063.4034.1		445	87.040.0053.0	WEB1001 LEERG.B4	585	95.502.0000.0	BEZEICHNUNGS-COMPUTER	90
80.063.4039.1	FLARE MOVE BM SERIE 38	444	87.040.3053.0	LPB-14L-250V1A	540	95.502.0100.0		49
81.000.1000.0	BGL-25VAC-2,5ADC	526	87.060.0053.0	WEB1001 LEERG.B6	586	95.502.0118.0	TUSCHSTIFT 0.25	49
81.000.3000.0	WPS-T115/230-300M	524	87.070.0053.0	WEB1				

contents of
part number

contents PART NUMBER

Part no.	Type	section / page	Part no.	Type	section / page	Part no.	Type	section / page
95.502.0197.0		49	99.234.9996.1	8213 S / 4 G OB GR OF	297	Z1.299.6153.0	PRUEFSTECKER VER.	176
95.502.0198.0		49	99.235.9996.1	8213 S / 5 G OB GR OF	297	Z1.299.7153.0	PRUEFSTECKER	189
95.502.0199.0		49	99.236.9996.1	8213 S / 6 G OB GR OF	297	Z1.299.8153.0	PRUEFSTECKER	176
95.502.0230.0		49	99.237.9996.1	8213 S / 7 G OB GR OF	297	Z1.299.9053.0	FUER WK 4E/U	176
95.502.0234.0		49	99.238.9996.1	8213 S / 8 G OB GR OF	297	Z1.299.9253.0	PST1-WK4	177
95.502.0270.0		49	99.239.3564.7	9526832	385	Z1.299.9453.0	PST1-WK4 MN	177
95.502.0274.0		49	99.239.9996.1	8213 S / 9 G OB GR OF	297	Z1.299.9553.0	PST10-WK4	177
95.502.0425.0		49	99.240.9996.1	8213 S / 10 G OB GR OF	297	Z1.299.9753.0		177
95.502.0435.0		49	99.241.9996.1	8213 S / 11 G OB GR OF	297	Z1.980.0040.0	SCHIENENTRAEGER	211
95.502.0450.0		49	99.242.9996.1	8213 S / 12 G OB GR OF	297	Z1.980.0153.0	N SH/35/F	213
95.502.0470.0		49	99.243.3564.7	9526826	385	Z1.990.2030.0	TRAGBOCK	215
95.502.0602.0		49	99.243.9996.1	8213 S / 13 G OB GR OF	297	Z2.123.7000.0	MAGAZIN M. 25 BU.	800
95.502.0621.0		49	99.244.9996.1	8213 S / 14 G OB GR OF	297	Z2.123.7100.0	MAGAZIN M. 25 BU.	800
95.502.0622.0		49	99.245.9996.1	8213 S / 15 G OB GR OF	297	Z2.123.7200.0	MAGAZIN M. 25 BU.	800
95.502.0623.0		49	99.246.9996.1	8213 S / 16 G OB GR OF	297	Z2.123.7300.0	MAGAZIN M. 25 BU.	800
95.502.0624.0		49	99.259.3564.7	9526833	385	Z2.123.7400.0	MAGAZIN M.25 BUCHS.	800
98.060.0000.0	1039 M	263	99.261.3521.9	EUROPAKLEMMLST.1P	258	Z2.220.0121.0	FKK18 / 1 Z	217
98.090.0000.0	9021/15X5.5EN60715	171	99.262.3521.9	6E SONDERA.	258	Z2.220.0321.0	FKK18 / 2 Z	217
98.090.0000.0	9021/15X5.5EN60715	802	99.262.9996.0	8113 S / 2 W OB GR OF	299	Z2.220.0421.0	FKK18 / 3 Z	217
98.090.0015.0	9021/15X5.5EN60715	40	99.263.3521.9	6E SONDERA.	258	Z2.302.0421.0	/ 70 E S35	111
98.090.0015.0	9021/15X5.5EN60715	802	99.263.9996.0	8113 S / 3 W OB GR OF	299	Z2.302.0621.0	9700 A / 35 E S35	111
98.095.3000.0		802	99.264.3521.9	6E SONDERA.	258	Z2.302.1321.0	9700 / 10 E / 1	211
98.190.0000.0	9006 EN 60715 - G 32	102	99.264.9996.0	8113 S / 4 W OB GR OF	299	Z2.803.0228.0	,0 BIS 11,0 MM	210
98.190.0000.0	9006 EN 60715 - G 32	584	99.265.3521.9	6E SONDERA.	258	Z2.803.0328.0	,5 BIS 13,5 MM	210
98.190.0000.0	9006 EN 60715 - G 32	802	99.265.9996.0	8113 S / 5 W OB GR OF	299	Z2.803.0428.0	2,5 BIS 16,5 MM	210
98.190.1000.0	9006 GELOCHT	171	99.266.3521.9	6E SONDERA.	258	Z2.803.1328.0	,5 BIS 6,5 MM	212
98.190.1000.0	9006 GELOCHT	802	99.266.9996.0	8113 S / 6 W OB GR OF	299	Z2.803.1428.0	,0 BIS 11,0 MM	212
98.210.0000.0	9006 AL 32	171	99.267.3521.9	6E SONDERA.	258	Z2.803.1528.0	0,0 BIS 17,0 MM	212
98.210.0000.0	9006 AL 32	802	99.267.9996.0	8113 S / 7 W OB GR OF	299	Z2.803.1628.0	16,0 BIS 24,0 MM	212
98.220.0000.0	9006 CU EN 60715 - G 32	110	99.268.3521.9	6E SONDERA.	258	Z2.803.2228.0	K 155 - 20,5	210
98.220.0000.0	9006 CU EN 60715 - G 32	802	99.268.9996.0	8113 S / 8 W OB GR OF	299	Z2.803.2328.0	K 19 - 27	210
98.290.0000.0	9813 M 10X 3 1000MM	72	99.269.3521.9	8113 S / 9 W OB GR OF	299	Z2.803.2428.0	K 26 - 34	210
98.290.1000.0	9813 M SN 10X3 1000MM	24	99.269.9996.0	6E SONDERA.	258	Z4.102.0480.0	BZ KL 16 / 4 Z	256
98.291.1000.0	18 X 3 M SN 1000MM	213	99.270.3521.9	8113 S / 10 W OB GR OF	299	Z4.102.0680.0	BZ KL 16 / 6 Z	256
98.300.0000.0	35X27X7,5 EN 60715 2M	20	99.270.9996.0	8113 S / 11 W OB GR OF	299	Z4.102.0880.0	BZ KL 16 / 8 Z	256
98.300.0000.0	35X27X7,5 EN 60715 2M	308	99.271.9996.0	8113 S / 12 W OB GR OF	299	Z4.102.1280.0	BZ KL 16 / 12 Z	256
98.300.0000.0	35X27X7,5 EN 60715 2M	584	99.272.3521.9	W.NR.07060796 6E SONDER	258	Z4.102.1680.0	BZ KL 16 / 16 Z	256
98.300.0000.0	35X27X7,5 EN 60715 2M	803	99.272.9996.0	8113 S / 12 W OB GR OF	299	Z4.102.2080.0	BZ KL 16 / 20 Z	256
98.300.0010.0	35x27x7,5 EN60715 BLANK	46	99.273.9996.0	8113 S / 13 W OB GR OF	299	Z4.210.0652.0	BEZ. KLAPPSCHILD	183
98.300.1000.0	35X27X 7,5 GELOCHT	19	99.274.9996.0	8113 S / 14 W OB GR OF	299	Z4.210.1652.0	BEZ. KLAPPSCHILD	183
98.300.1000.0	35X27X 7,5 GELOCHT	803	99.275.9996.0	8113 S / 15 W OB GR OF	299	Z4.242.3753.0	BEZ.SCHILDTRAEGER	781
98.305.1000.0	35X27X7,5 EN 60715 1M	803	99.276.9996.0	8113 S / 16 W OB GR OF	299	Z4.242.4053.0	BEZ.SCHILDTRAEGER	781
98.310.0000.0	TRAGSCHIENE 2M	215	99.483.0000.0			Z4.242.5053.0	9705 A / 5 /10/11MARC	49
98.320.0000.0	6 X 6 2000MM	216	99.700.0000.6	STVB. KOMPLETT	672	Z4.242.5153.0	9705 AL / 5 /10/ 6MARC	49
98.325.1000.0	6 X 6 1000MM	216	99.700.3329.7	GEHAEUSEUNTERTEIL	773	Z4.242.5153.0	9705 AL / 5 /10/ 6MARC	442
98.360.0000.0	35 X 24 X 15 EN 60715	20	99.700.6905.5	BUCHSENTEIL	760	Z4.242.6053.0	9705 A / 6 /10/11MARC	49
98.360.0000.0	35 X 24 X 15 EN 60715	308	99.701.0000.6	STVB. KOMPLETT	672	Z4.242.6153.0		179
98.360.0000.0	35 X 24 X 15 EN 60715	584	99.701.3329.7	GEHAEUSEOBERTEIL	772	Z4.242.6353.0		90
98.360.0000.0	35 X 24 X 15 EN 60715	803	99.701.6905.5	STECKERTEIL	760	Z4.242.6753.0		49
98.360.0004.0	35x24x15 EN 60715 FZN	46	99.702.0000.6	STVB. KOMPLETT	672	Z4.242.6853.0		49
98.370.0000.0	35 X 27 X 15	38	99.702.3329.7	GEHAEUSEUNTERTEIL	773	Z4.242.8053.0		49
98.370.0000.0	35 X 27 X 15	803	99.703.0000.6	STVB. KOMPLETT	672	Z4.243.8453.0		47
98.370.1000.0	35 X 27 X 15 GELOCHT 2M	46	99.703.3329.7	GEHAEUSEOBERTEIL	772	Z4.802.0480.0	BZ KL 16 / 4 Z B	256
98.370.1000.0	35 X 27 X 15 GELOCHT 2M	803	99.704.3329.7	GEHAEUSEUNTERTEIL	773	Z4.802.2080.0	BZ KL 16 / 20 Z B	256
98.375.1000.0	35 X 27 X 15 GELOCHT 1M	803	99.705.3329.7	GEHAEUSEOBERTEIL	772	Z5.507.1321.0	KABELVERSCHRB.	776
98.380.0000.0	35X24X15 EN60715 CU	47	99.706.0000.6	STVB. KOMPLETT	672	Z5.507.1353.0	M 20 x 1,5 IP68	776
98.380.0000.0	35X24X15 EN60715 CU	803	99.706.3329.7	GEHAEUSEUNTERTEIL	773	Z5.507.1453.1	KABELVERSCHRB.	758
98.400.0000.0	ANKERSCHIENE 2M	210	99.707.0000.6	STVB. KOMPLETT	672	Z5.507.1521.0	KABELVERSCHRB.	776
99.000.0920.8	9705A/6,7/ 12 B 1-9	790	99.707.3329.7	GEHAEUSEOBERTEIL	772	Z5.507.1553.0	M 25x1,5 IP68	776
99.002.0920.8	9705A/6,7/2X B 1-6	790	99.708.0000.6	STVB. KOMPLETT	672	Z5.507.1553.1		758
99.003.0920.8	9705A/6,7/ 12 B 1-10	790	99.709.0000.6	STVB. KOMPLETT	672	Z5.507.1721.0	KABELVERSCHRB.	776
99.004.0920.8	9705A/6,7/2X12 B 1-16	790	99.710.3329.7	GEHAEUSEOBERTEIL	773	Z5.507.1753.0	M 32 x 1,5 IP68	776
99.005.0920.8	9705A/6,7/2X12 B 1-24	790	99.711.3329.7	GEHAEUSEOBERTEIL	773	Z5.507.1921.0	M 40 x 1,5 IP68	776
99.202.9996.0	8113 S / 2 G OB GR OF	297	99.713.3329.7	GEHAEUSEOBERTEIL	773	Z5.507.1953.0	M 40x1,5 IP68	776
99.202.9996.2	8213 S / 2 W OB GR OF	299	99.716.3329.7	GEHAEUSEOBERTEIL	773	Z5.507.2121.0	M 16 x 1,5	776
99.203.9996.0	8113 S / 3 G OB GR OF	297	99.718.0000.6	STVB. KOMPLETT	672	Z5.507.2221.0	M 20 x 1,5	776
99.203.9996.2	8213 S / 3 W OB GR OF	299	99.719.0000.6	STVB. KOMPLETT	672	Z5.507.2321.0	M 25 x 1,5	776
99.204.9996.0	8113 S / 4 G OB GR OF	297	99.720.0000.6	STVB. KOMPLETT	672	Z5.507.2421.0	M 32 x 1,5	776
99.204.9996.2	8213 S / 4 W OB GR OF	299	99.721.0000.6	STVB. KOMPLETT	672	Z5.507.4821.0	M 20 x 1,5	777
99.205.9996.0	8113 S / 5 G OB GR OF	297	99.721.3329.7	F.EIGSICH.ANL.ZINKDRCKG	772	Z5.507.5021.0	M25 x 1,5	777
99.205.9996.2	8213 S / 5 W OB GR OF	299	99.723.3329.7	F.EIGSICH.ANL.ZINKDRCKG	772	Z5.507.5221.0	M 32 x 1,5	777
99.206.9996.0	8113 S / 6 G OB GR OF	297	99.724.0000.6			Z5.507.5821.0	M 20 x 1,5	777
99.206.9996.2	8213 S / 6 W OB GR OF	299	99.725.0000.6	STVB. KOMPLETT	672	Z5.507.6021.0	M 25 x 1,5	777
99.207.9996.0	8113 S / 7 G OB GR OF	297	99.726.0000.6	STVB. KOMPLETT	672	Z5.507.6221.0	M 32 x 1,5	777
99.207.9996.2	8213 S / 7 W OB GR OF	299	99.727.0000.6	STVB. KOMPLETT	672	Z5.507.6421.0	M 40 x 1,5	777
99.208.9996.0	8113 S / 8 G OB GR OF	297	99.727.3329.7	F.EIGSICH.ANL.ZINKDRCKG	772	Z5.507.9521.0	M 16 x 1,5	777
99.208.9996.2	8213 S / 8 W OB GR OF	299	99.801.3900.9	4Q DC24V 2A	538	Z5.507.9621.0	M 20 x 1,5	777
99.209.9996.0	8113 S / 9 G OB GR OF	297	Z1.000.4753.0	SR - I 5	485	Z5.507.9721.0	M 25 x 1,5	777
99.209.9996.2	8213 S / 9 W OB GR OF	299	Z1.000.9153.0	SR - A 4	485	Z5.507.9821.0	M 32 x 1,5	777
99.210.9996.0	8113 S / 10 G OB GR OF	297	Z1.108.8453.0			Z5.515.3310.0	WE SH 1/35	212
99.210.9996.2	8213 S / 10 W OB GR OF	299	Z1.296.3453.0	WIEBOX CN 19 GKL	594	Z5.515.3410.0	WE SH 2/35	212
99.211.9996.0	8113 S / 11 G OB GR OF	297	Z1.296.3553.0	WIEBOX CN 19 GK	594	Z5.516.2511.0	9018 D	169
99.211.9996.2	8213 S / 11 W OB GR OF	299	Z1.296.3853.0	WIEBOX CN 22 GKL	594	Z5.516.2711.0	9018 H	169
99.212.9996.0	8113 S / 12 G OB GR OF	297	Z1.296.3953.0	WIEBOX CN 22 GK	594	Z5.516.2811.0	9018 N	169
99.212.9996.2	8213 S / 12 W OB GR OF	299	Z1.296.4253.0	WIEBOX CN 26 GKL	595	Z5.519.0310.0	SCHIENENHALTER	213
99.213.9996.0	8113 S / 13 G OB GR OF	297	Z1.296.4353.0	WIEBOX CN 26 GK	595	Z5.519.0410.0	SCHIENENHALTER	213
99.213.9996.2	8213 S / 13 W OB GR OF	299	Z1.299.3053.0			Z5.522.1923.0	2163	215
99.214.9996.0	8113 S / 14 GF OB	297	Z1.299.3055.0	DIST-... / 0	38	Z5.522.5010.0	9222	40
99.214.9996.2	8213 S / 14 W OB GR OF	299	Z1.299.3155.0	DIST-1N 4007 -1 / 0	38	Z5.522.7053.0	9708	102
99.215.9996.0	8113 S / 15 G OB GR OF	297	Z1.299.3255.0	DIST-D / 0	38	Z5.522.7553.0	9208 / S15	40
99.215.9996.2	8213 S / 15 W OB GR OF	299	Z1.299.3355.0	DIST-1N 4007 -2 / 0	38	Z5.522.8553.0	9708 / 2 S 35	19
99.216.9996.0	8113 S / 16 G OB GR OF	297	Z1.299.4053.0			Z5.522.8553.0	9708 / 2 S 35	308
99.216.9996.2	8213 S / 16 W OB GR OF	299	Z1.299.4055.0	SIST-... / 0	38	Z5.522.8553.0	9708 / 2 S 35	410
99.232.9996.1	8213 S / 2 G OB GR OF	297	Z1.299.4155.0	SIST-LED / 0	38	Z5.523.2453.0	BEF.HALTER	297
99.233.9996.1	8213 S / 3 G OB GR OF	297	Z1.299.4255.0	SIST-GL / 0	38	Z5.523.5153.0	9708 / 3 S35	173

contents

Part no.	Type	section / page	Part no.	Type	section / page	Part no.	Type	section / page
Z5.523.5653.0	WE 2/U	105	Z5.532.1525.0	LP.STIFBLEISTE	317	Z5.543.0253.0	PRUEFSTECKER	358
Z5.523.5753.0	WE 1/U	101	Z5.532.1625.0	LP.STIFBLEISTE	317	Z5.543.7000.0	MAGAZIN M. 25 ST.	800
Z5.523.5753.0	WE 1/U	584	Z5.532.3225.0	LP.STIFBLEISTE	317	Z5.543.7100.0	MAGAZIN M. 25 ST.	800
Z5.523.7653.0	BEFEST.HALT.KOMPL	319	Z5.532.3325.0	LP.STIFBLEISTE	317	Z5.543.7200.0	MAGAZIN M. 25 ST.	800
Z5.523.7753.0	BEF.HALTER	295	Z5.532.3425.0	LP.STIFBLEISTE	317	Z5.543.7300.0	MAGAZIN M. 25 ST.	800
Z5.523.7853.0	BEF.HALTER	295	Z5.532.3525.0	LP.STIFBLEISTE	317	Z5.543.7400.0	MAGAZIN M. 25 ST.	800
Z5.523.9353.0	WEF 1/35	20	Z5.532.3625.0	LP.STIFBLEISTE	317	Z5.553.2921.0	ST 2 / 2,3 ROT	19
Z5.523.9353.0	WEF 1/35	308	Z5.532.3725.0	LP.STIFBLEISTE	317	Z5.553.2921.0	ST 2 / 2,3 ROT	353
Z5.530.0225.0	LP.STIFBLEISTE	318	Z5.532.3825.0	LP.STIFBLEISTE	317	Z5.553.3021.0	ST 2 / 4 SCHWARZ	176
Z5.530.0325.0	LP.STIFBLEISTE	318	Z5.532.3925.0	LP.STIFBLEISTE	317	Z5.553.9400.0	KURZSCHLUSSTECKER	176
Z5.530.0425.0	LP.STIFBLEISTE	318	Z5.532.4025.0	LP.STIFBLEISTE	317	Z5.563.0453.0	DIPOS KODIERAST	499
Z5.530.0525.0	LP.STIFBLEISTE	318	Z5.532.4125.0	LP.STIFBLEISTE	317	BU 70.3 / 6 REVZ	675	
Z5.530.0625.0	LP.STIFBLEISTE	318	Z5.532.4225.0	LP.STIFBLEISTE	317	BU 70.3 / 6 REVZ	675	
Z5.530.0725.0	LP.STIFBLEISTE	318	Z5.532.4325.0	LP.STIFBLEISTE	317	BU 70.3 / 10 REVZ	675	
Z5.530.0825.0	LP.STIFBLEISTE	318	Z5.532.4425.0	LP.STIFBLEISTE	317	BU 70.3 / 24 REVZ	675	
Z5.530.0925.0	LP.STIFBLEISTE	318	Z5.532.4525.0	LP.STIFBLEISTE	317	BU 72.3 / 16 REVZ	679	
Z5.530.1025.0	LP.STIFBLEISTE	318	Z5.532.4625.0	LP.STIFBLEISTE	317	BU 72.3 / 6 REVZ	679	
Z5.530.1125.0	LP.STIFBLEISTE	318	Z5.533.7121.0	PRUEFSTECKER	357	BU 72.3 / 10 REVZ	679	
Z5.530.1225.0	LP.STIFBLEISTE	318	Z5.533.7221.0	PRUEFSTECKER	357	BU 72.3 / 24 REVZ	679	
Z5.530.1325.0	LP.STIFBLEISTE	318	Z5.533.8221.0	STECERLEISTE	357	BU 70.3 / 16 REVZ	675	
Z5.530.1425.0	LP.STIFBLEISTE	318	Z5.535.0225.0	8520 S / 2 G 0,8	324	BU 70.3 / 6 REVZ	675	
Z5.530.1525.0	LP.STIFBLEISTE	318	Z5.535.0325.0	8520 S / 3 G 0,8	324	BU 70.3 / 10 REVZ	675	
Z5.530.1625.0	LP.STIFBLEISTE	318	Z5.535.0425.0	8520 S / 4 G 0,8	324	BU 70.3 / 24 REVZ	675	
Z5.530.3225.0	LP.STIFBLEISTE	318	Z5.535.0525.0	8520 S / 5 G 0,8	324	BU 72.3 / 16 REVZ	679	
Z5.530.3325.0	LP.STIFBLEISTE	318	Z5.535.0625.0	8520 S / 6 G 0,8	324	BU 72.3 / 6 REVZ	679	
Z5.530.3425.0	LP.STIFBLEISTE	318	Z5.535.0725.0	8520 S / 7 G 0,8	324	BU 72.3 / 10 REVZ	679	
Z5.530.3525.0	LP.STIFBLEISTE	318	Z5.535.0825.0	8520 S / 8 G 0,8	324	BU 72.3 / 24 REVZ	679	
Z5.530.3625.0	LP.STIFBLEISTE	318	Z5.535.0925.0	8520 S / 10 G 0,8	324	BU 70.3 / 16 REVZ	675	
Z5.530.3725.0	LP.STIFBLEISTE	318	Z5.535.1025.0	8520 S / 11 G 0,8	324	BU 70.3 / 10 REVZ	675	
Z5.530.3825.0	LP.STIFBLEISTE	318	Z5.535.1125.0	8520 S / 12 G 0,8	324	BU 70.3 / 24 REVZ	675	
Z5.530.3925.0	LP.STIFBLEISTE	318	Z5.535.1225.0	8520 S / 13 G 0,8	324	BU 72.3 / 16 REVZ	679	
Z5.530.4025.0	LP.STIFBLEISTE	318	Z5.535.1325.0	8520 S / 14 G 0,8	324	BU 72.3 / 6 REVZ	679	
Z5.530.4125.0	LP.STIFBLEISTE	318	Z5.535.1425.0	8520 S / 15 G 0,8	324	BU 72.3 / 10 REVZ	679	
Z5.530.4225.0	LP.STIFBLEISTE	318	Z5.535.1525.0	8520 S / 16 G 0,8	324	BU 70.3 / 16 REVZ	675	
Z5.530.4325.0	LP.STIFBLEISTE	318	Z5.535.1625.0	8520 S / 3 G 1,0	324	BU 70.3 / 6 REVZ	675	
Z5.530.4425.0	LP.STIFBLEISTE	318	Z5.535.3225.0	8520 S / 4 G 1,0	324	BU 70.3 / 24 REVZ	675	
Z5.530.4525.0	LP.STIFBLEISTE	318	Z5.535.3325.0	8520 S / 5 G 1,0	324	BU 72.3 / 16 REVZ	679	
Z5.530.4625.0	LP.STIFBLEISTE	318	Z5.535.3425.0	8520 S / 6 G 1,0	324	BU 72.3 / 6 REVZ	679	
Z5.530.6225.0	LP.STIFBLEISTE	318	Z5.535.3525.0	8520 S / 7 G 1,0	324	BU 72.3 / 10 REVZ	679	
Z5.530.6325.0	LP.STIFBLEISTE	318	Z5.535.3625.0	8520 S / 8 G 1,0	324	BU 72.3 / 24 REVZ	679	
Z5.530.6425.0	LP.STIFBLEISTE	318	Z5.535.3725.0	8520 S / 10 G 1,0	324	BU 70.7 / 16 REVZ	677	
Z5.530.6525.0	LP.STIFBLEISTE	318	Z5.535.3825.0	8520 S / 11 G 1,0	324	BU 70.7 / 6 REVZ	677	
Z5.530.6625.0	LP.STIFBLEISTE	318	Z5.535.3925.0	8520 S / 12 G 1,0	324	BU 70.7 / 10 REVZ	677	
Z5.530.6725.0	LP.STIFBLEISTE	318	Z5.535.4025.0	8520 S / 13 G 1,0	324	BU 70.7 / 24 REVZ	677	
Z5.530.6825.0	LP.STIFBLEISTE	318	Z5.535.4125.0	8520 S / 14 G 1,0	324	BU 72.7 / 16 REVZ	681	
Z5.530.8225.0	LP.STIFBLEISTE	318	Z5.535.4225.0	8520 S / 15 G 1,0	324	BU 72.7 / 6 REVZ	681	
Z5.530.8325.0	LP.STIFBLEISTE	318	Z5.535.4325.0	8520 S / 16 G 1,0	324	BU 72.7 / 10 REVZ	681	
Z5.530.8425.0	LP.STIFBLEISTE	318	Z5.535.4425.0	LP.STIFBLEISTE	319	BU 72.7 / 24 REVZ	681	
Z5.530.8525.0	LP.STIFBLEISTE	318	Z5.535.4525.0	LP.STIFBLEISTE	319	BU 70.7 / 16 REVZ	677	
Z5.530.8625.0	LP.STIFBLEISTE	318	Z5.535.4625.0	LP.STIFBLEISTE	319	BU 70.7 / 6 REVZ	677	
Z5.530.8725.0	LP.STIFBLEISTE	318	Z5.540.0225.0	LP.STIFBLEISTE	319	BU 70.7 / 10 REVZ	677	
Z5.530.8825.0	LP.STIFBLEISTE	318	Z5.540.0325.0	LP.STIFBLEISTE	319	BU 72.7 / 16 REVZ	681	
Z5.531.0225.0	LP.STIFBLEISTE	316	Z5.540.0425.0	LP.STIFBLEISTE	319	BU 70.7 / 6 REVZ	677	
Z5.531.0325.0	LP.STIFBLEISTE	316	Z5.540.0525.0	LP.STIFBLEISTE	319	BU 70.7 / 10 REVZ	677	
Z5.531.0425.0	LP.STIFBLEISTE	316	Z5.540.0625.0	LP.STIFBLEISTE	319	BU 72.7 / 24 REVZ	681	
Z5.531.0525.0	LP.STIFBLEISTE	316	Z5.540.0725.0	LP.STIFBLEISTE	319	BU 72.7 / 6 REVZ	681	
Z5.531.0625.0	LP.STIFBLEISTE	316	Z5.540.0825.0	LP.STIFBLEISTE	319	BU 72.7 / 10 REVZ	681	
Z5.531.0725.0	LP.STIFBLEISTE	316	Z5.540.0925.0	LP.STIFBLEISTE	319	BU 72.7 / 24 REVZ	681	
Z5.531.0825.0	LP.STIFBLEISTE	316	Z5.540.1025.0	LP.STIFBLEISTE	319	BU 73.7 / 40 REVZ	683	
Z5.531.0925.0	LP.STIFBLEISTE	316	Z5.540.1125.0	LP.STIFBLEISTE	319	BU 73.7 / 64 REVZ	683	
Z5.531.1025.0	LP.STIFBLEISTE	316	Z5.540.1225.0	LP.STIFBLEISTE	319	BU 70.7 / 16 REVZ	677	
Z5.531.1125.0	LP.STIFBLEISTE	316	Z5.540.1325.0	LP.STIFBLEISTE	319	BU 70.7 / 6 REVZ	677	
Z5.531.1225.0	LP.STIFBLEISTE	316	Z5.540.1425.0	LP.STIFBLEISTE	319	BU 70.7 / 10 REVZ	677	
Z5.531.1325.0	LP.STIFBLEISTE	316	Z5.540.1525.0	LP.STIFBLEISTE	319	BU 70.7 / 24 REVZ	681	
Z5.531.1425.0	LP.STIFBLEISTE	316	Z5.540.1625.0	LP.STIFBLEISTE	319	BU 73.7 / 40 REVZ	683	
Z5.531.1525.0	LP.STIFBLEISTE	316	Z5.540.3225.0	LP.STIFBLEISTE	319	BU 73.7 / 64 REVZ	683	
Z5.531.1625.0	LP.STIFBLEISTE	316	Z5.540.3325.0	LP.STIFBLEISTE	319	BU 72.7 / 16 REVZ	681	
Z5.531.3225.0	LP.STIFBLEISTE	316	Z5.540.3425.0	LP.STIFBLEISTE	319	BU 72.7 / 6 REVZ	681	
Z5.531.3325.0	LP.STIFBLEISTE	316	Z5.540.3525.0	LP.STIFBLEISTE	319	BU 72.7 / 10 REVZ	681	
Z5.531.3425.0	LP.STIFBLEISTE	316	Z5.540.3625.0	LP.STIFBLEISTE	319	BU 72.7 / 24 REVZ	681	
Z5.531.3525.0	LP.STIFBLEISTE	316	Z5.540.3725.0	LP.STIFBLEISTE	319	BU 73.7 / 40 REVZ	683	
Z5.531.3625.0	LP.STIFBLEISTE	316	Z5.540.3825.0	LP.STIFBLEISTE	319	BU 70.7 / 16 REVZ	677	
Z5.531.3725.0	LP.STIFBLEISTE	316	Z5.540.3925.0	LP.STIFBLEISTE	319	BU 73.7 / 64 REVZ	683	
Z5.531.3825.0	LP.STIFBLEISTE	316	Z5.540.4025.0	LP.STIFBLEISTE	319	BU 70.7 / 16 REVZ	677	
Z5.531.3925.0	LP.STIFBLEISTE	316	Z5.540.4125.0	LP.STIFBLEISTE	319	BU 70.7 / 6 REVZ	677	
Z5.531.4025.0	LP.STIFBLEISTE	316	Z5.540.4225.0	LP.STIFBLEISTE	319	BU 70.7 / 10 REVZ	677	
Z5.531.4125.0	LP.STIFBLEISTE	316	Z5.540.4325.0	LP.STIFBLEISTE	319	BU 70.7 / 24 REVZ	681	
Z5.531.4225.0	LP.STIFBLEISTE	316	Z5.540.4425.0	LP.STIFBLEISTE	319	BU 73.7 / 40 REVZ	683	
Z5.531.4325.0	LP.STIFBLEISTE	316	Z5.540.4525.0	LP.STIFBLEISTE	319	BU 73.7 / 64 REVZ	683	
Z5.531.4425.0	LP.STIFBLEISTE	316	Z5.540.4625.0	LP.STIFBLEISTE	319	BU 72.7 / 16 REVZ	681	
Z5.531.4525.0	LP.STIFBLEISTE	316	Z5.540.6225.0	LP.STIFBLEISTE	319	BU 72.7 / 6 REVZ	681	
Z5.531.4625.0	LP.STIFBLEISTE	316	Z5.540.6325.0	LP.STIFBLEISTE	319	BU 72.7 / 10 REVZ	681	
Z5.532.0225.0	LP.STIFBLEISTE	317	Z5.540.6425.0	LP.STIFBLEISTE	319	BU 72.7 / 24 REVZ	681	
Z5.532.0325.0	LP.STIFBLEISTE	317	Z5.540.6525.0	LP.STIFBLEISTE	319	ST 70.3 / 16 REVZ	675	
Z5.532.0425.0	LP.STIFBLEISTE	317	Z5.540.6625.0	LP.STIFBLEISTE	319	ST 70.3 / 6 REVZ	675	
Z5.532.0525.0	LP.STIFBLEISTE	317	Z5.540.6725.0	LP.STIFBLEISTE	319	ST 70.3 / 10 REVZ	675	
Z5.532.0625.0	LP.STIFBLEISTE	317	Z5.540.6825.0	LP.STIFBLEISTE	319	ST 70.3 / 24 REVZ	675	
Z5.532.0725.0	LP.STIFBLEISTE	317	Z5.540.8225.0	LP.STIFBLEISTE	319	ST 72.3 / 16 REVZ	679	
Z5.532.0825.0	LP.STIFBLEISTE	317	Z5.540.8325.0	LP.STIFBLEISTE	319	ST 72.3 / 6 REVZ	679	
Z5.532.0925.0	LP.STIFBLEISTE	317	Z5.540.8425.0	LP.STIFBLEISTE	319	ST 72.3 / 10 REVZ	679	
Z5.532.1025.0	LP.STIFBLEISTE	317	Z5.540.8525.0	LP.STIFBLEISTE	319	ST 72.3 / 24 REVZ	679	
Z5.532.1125.0	LP.STIFBLEISTE	317	Z5.540.8625.0	LP.STIFBLEISTE	319	ST 70.3 / 16 REVZ	675	
Z5.532.1225.0	LP.STIFBLEISTE	317	Z5.540.8725.0	LP.STIFBLEISTE	319	ST 70.3 / 6 REVZ	675	
Z5.532.1325.0	LP.STIFBLEISTE	317	Z5.540.8825.0	LP.STIFBLEISTE	319	ST 70.3 / 10 REVZ	675	
Z5.532.1425.0	LP.STIFBLEISTE	317	Z5.543.0153.0	PRUEFSTECKER	358	ST 70.3 / 24 REVZ	675	

contents of
part number

contents PART NUMBER

Part no.	Type	section / page	Part no.	Type	section / page	Part no.	Type	section / page
Z5.571.1556.0	ST 72.3 /16 REV	679	Z5.572.4356.0	BU 70.1 /24 REV U WL	675	Z5.573.6256.0	ST 70.1 /10 RV U WL	675
Z5.571.1656.0	ST 72.3 / 6 REV	679	Z5.572.4556.0	BU 72.1 /16 REV U WL	679	Z5.573.6356.0	ST 70.1 /24 RV U WL	675
Z5.571.1756.0	ST 72.3 /10 REV	679	Z5.572.4656.0	BU 72.1 / 6 REV U WL	679	Z5.573.6556.0	ST 72.1 /16 RV U WL	679
Z5.571.1856.0	ST 72.3 /24 REV	679	Z5.572.4756.0	BU 72.1 /10 REV U WL	679	Z5.573.6656.0	ST 72.1 / 6 RV U WL	679
Z5.571.2056.0	ST 70.3 /16 RVZ	675	Z5.572.4856.0	BU 72.1 /24 REV U WL	679	Z5.573.6756.0	ST 72.1 /10 RV U WL	679
Z5.571.2156.0	ST 70.3 / 6 RVZ	675	Z5.572.5056.0	BU 70.1 /16 REV U WR	675	Z5.573.6856.0	ST 72.1 /24 RV U WL	679
Z5.571.2256.0	ST 70.3 /10 RVZ	675	Z5.572.5156.0	BU 70.1 / 6 REV U WR	675	Z5.573.7056.0	ST 70.1 /16 RV U WR	675
Z5.571.2356.0	ST 70.3 /24 RVZ	675	Z5.572.5256.0	BU 70.1 /10 REV U WR	675	Z5.573.7156.0	ST 70.1 / 6 RV U WR	675
Z5.571.2556.0	ST 72.3 /16 RVZ	679	Z5.572.5356.0	BU 70.1 /24 REV U WR	675	Z5.573.7256.0	ST 70.1 /10 RV U WR	675
Z5.571.2656.0	ST 72.3 / 6 RVZ	679	Z5.572.5556.0	BU 72.1 /16 REV U WR	679	Z5.573.7356.0	ST 70.1 /24 RV U WR	675
Z5.571.2756.0	ST 72.3 /10 RVZ	679	Z5.572.5656.0	BU 72.1 / 6 REV U WR	679	Z5.573.7556.0	ST 72.1 /16 RV U WR	679
Z5.571.2856.0	ST 72.3 /24 RVZ	679	Z5.572.5756.0	BU 72.1 /10 REV U WR	679	Z5.573.7656.0	ST 72.1 / 6 RV U WR	679
Z5.571.3056.0	ST 70.3 /16 RV	675	Z5.572.5856.0	BU 72.1 /24 REV U WR	679	Z5.573.7756.0	ST 72.1 /10 RV U WR	679
Z5.571.3156.0	ST 70.3 / 6 RV	675	Z5.572.6056.0	BU 70.1 /16 RV U WL	675	Z5.573.7856.0	ST 72.1 /24 RV U WR	679
Z5.571.3256.0	ST 70.3 /10 RV	675	Z5.572.6156.0	BU 70.1 / 6 RV U WL	675	Z5.573.8056.0	ST 73.1 /40 REV WL	683
Z5.571.3356.0	ST 70.3 /24 RV	675	Z5.572.6256.0	BU 70.1 /10 RV U WL	675	Z5.573.8156.0	ST 73.1 /64 REV WL	683
Z5.571.3556.0	ST 72.3 /16 RV	679	Z5.572.6356.0	BU 70.1 /24 RV U WL	675	Z5.573.8356.0	ST 73.1 /40 REV WR	683
Z5.571.3656.0	ST 72.3 / 6 RV	679	Z5.572.6556.0	BU 72.1 /16 RV U WL	679	Z5.573.8456.0	ST 73.1 /64 REV WR	683
Z5.571.3756.0	ST 72.3 /10 RV	679	Z5.572.6656.0	BU 72.1 / 6 RV U WL	679	Z5.573.8656.0	ST 73.1 /40 RV WL	683
Z5.571.3856.0	ST 72.3 /24 RV	679	Z5.572.6756.0	BU 72.1 /10 RV U WL	679	Z5.573.8756.0	ST 73.1 /64 RV WL	683
Z5.571.4056.0	ST 70.7 /16 REVZ	677	Z5.572.6856.0	BU 72.1 /24 RV U WL	679	Z5.573.8956.0	ST 73.1 /40 RV WR	683
Z5.571.4156.0	ST 70.7 / 6 REVZ	677	Z5.572.7056.0	BU 70.1 /16 RV U WR	675	Z5.573.9056.0	ST 73.1 /64 RV WR	683
Z5.571.4256.0	ST 70.7 /10 REVZ	677	Z5.572.7156.0	BU 70.1 / 6 RV U WR	675	Z5.573.9156.0	ST 73.1 /40 REV U WL	683
Z5.571.4356.0	ST 70.7 /24 REVZ	677	Z5.572.7256.0	BU 70.1 /10 RV U WR	675	Z5.573.9256.0	ST 73.1 /64 REV U WL	683
Z5.571.4556.0	ST 72.7 /16 REVZ	681	Z5.572.7356.0	BU 70.1 /24 RV U WR	675	Z5.573.9356.0	ST 73.1 /40 REV U WR	683
Z5.571.4656.0	ST 72.7 / 6 REVZ	681	Z5.572.7556.0	BU 72.1 /16 RV U WR	679	Z5.573.9456.0	ST 73.1 /64 REV U WR	683
Z5.571.4756.0	ST 72.7 /10 REVZ	681	Z5.572.7656.0	BU 72.1 / 6 RV U WR	679	Z5.573.9556.0	ST 73.1 /40 RV U WL	683
Z5.571.4856.0	ST 72.7 /24 REVZ	681	Z5.572.7756.0	BU 72.1 /10 RV U WR	679	Z5.573.9656.0	ST 73.1 /64 RV U WL	683
Z5.571.5056.0	ST 70.7 /16 REV	677	Z5.572.7856.0	BU 72.1 /24 RV U WR	679	Z5.573.9756.0	ST 73.1 /40 RV U WR	683
Z5.571.5156.0	ST 70.7 / 6 REV	677	Z5.572.8056.0	BU 73.1 /40 REV WL	683	Z5.573.9856.0	ST 73.1 /64 RV U WR	683
Z5.571.5256.0	ST 70.7 /10 REV	677	Z5.572.8156.0	BU 73.1 /64 REV WL	683	Z5.574.0053.0	6/10/16 Gehaeuse-UT	782
Z5.571.5356.0	ST 70.7 /24 REV	677	Z5.572.8356.0	BU 73.1 /40 REV WR	683	Z5.574.0153.0	24 Gehaeuse-UT	782
Z5.571.5556.0	ST 72.7 /16 REV	681	Z5.572.8456.0	BU 73.1 /64 REV WR	683	Z5.574.0653.0	HALTERAHIMEN 6	782
Z5.571.5656.0	ST 72.7 / 6 REV	681	Z5.572.8656.0	BU 73.1 /40 RV WL	683	Z5.574.1053.0	HALTERAHIMEN 10	782
Z5.571.5756.0	ST 72.7 /10 REV	681	Z5.572.8756.0	BU 73.1 /64 RV WL	683	Z5.574.1253.0	HALTERAHIMEN 2x6	782
Z5.571.5856.0	ST 72.7 /24 REV	681	Z5.572.8956.0	BU 73.1 /40 RV WR	683	Z5.574.1653.0	HALTERAHIMEN 16	782
Z5.571.6056.0	ST 73.7 /40 REVZ	683	Z5.572.9056.0	BU 73.1 /64 RV WR	683	Z5.574.2453.0	HALTERAHIMEN 24	782
Z5.571.6156.0	ST 73.7 /64 REVZ	683	Z5.572.9156.0	BU 73.1 /40 REV U WL	683	Z5.580.7800.0	M-IAC 24	482
Z5.571.6556.0	ST 70.7 /16 RVZ	677	Z5.572.9256.0	BU 73.1 /64 REV U WL	683	Z5.580.8100.0	M-IDC 24	482
Z5.571.6656.0	ST 70.7 / 6 RVZ	677	Z5.572.9356.0	BU 73.1 /40 REV U WR	683	Z5.592.1252.0	SPERRSTUECK	788
Z5.571.6756.0	ST 70.7 /10 RVZ	677	Z5.572.9456.0	BU 73.1 /64 REV U WR	683	Z5.593.4053.0	CODIERSATZ	788
Z5.571.6856.0	ST 70.7 /24 RVZ	677	Z5.572.9556.0	BU 73.1 /40 RV U WL	683	Z5.596.2153.0	TR.-STUECK F.TS35	584
Z5.571.7056.0	ST 73.7 /40 REV	683	Z5.572.9656.0	BU 73.1 /64 RV U WL	683	Z5.599.9025.0	LP-STIFLLEITE	320
Z5.571.7156.0	ST 73.7 /64 REV	683	Z5.572.9756.0	BU 73.1 /40 RV U WR	683	Z6.012.0812.0	SCHRAUBENSATZ	305
Z5.571.7556.0	ST 72.7 /16 RVZ	681	Z5.572.9856.0	BU 73.1 /64 RV U WR	683	Z7.210.1027.0	2072 M	164
Z5.571.7656.0	ST 72.7 / 6 RVZ	681	Z5.573.0056.0	ST 70.1 /16 REV WL	675	Z7.210.3027.0	9215 M-70	164
Z5.571.7756.0	ST 72.7 /10 RVZ	681	Z5.573.0156.0	ST 70.1 / 6 REV WL	675	Z7.210.3227.0	9215 - 2	114
Z5.571.7856.0	ST 72.7 /24 RVZ	681	Z5.573.0256.0	ST 70.1 /10 REV WL	675	Z7.210.3327.0	9215 - 3	114
Z5.571.8056.0	ST 73.7 /40 RVZ	683	Z5.573.0356.0	ST 70.1 /24 REV WL	675	Z7.210.3427.0	9215 - 4	164
Z5.571.8156.0	ST 73.7 /64 RVZ	683	Z5.573.0556.0	ST 72.1 /16 REV WL	679	Z7.210.3527.0	9215 - 5	164
Z5.571.8556.0	ST 70.7 /16 RV	677	Z5.573.0656.0	ST 72.1 / 6 REV WL	679	Z7.210.3627.0	9215 - 6	114
Z5.571.8656.0	ST 70.7 / 6 RV	677	Z5.573.0756.0	ST 72.1 /10 REV WL	679	Z7.211.0027.0	9703 / 6 M-70	72
Z5.571.8756.0	ST 70.7 /10 RV	677	Z5.573.0856.0	ST 72.1 /24 REV WL	679	Z7.211.0227.0	9703 / 6-2	72
Z5.571.8856.0	ST 70.7 /24 RV	677	Z5.573.1056.0	ST 70.1 /16 REV WR	675	Z7.211.0327.0	9703 / 6-3	86
Z5.571.9056.0	ST 73.7 /40 RV	683	Z5.573.1156.0	ST 70.1 / 6 REV WR	675	Z7.211.0427.0	9703 / 6-4	86
Z5.571.9156.0	ST 73.7 /64 RV	683	Z5.573.1256.0	ST 70.1 /10 REV WR	675	Z7.211.0527.0	9703 / 6-5	86
Z5.571.9556.0	ST 72.7 /16 RV	681	Z5.573.1356.0	ST 70.1 /24 REV WR	675	Z7.211.0627.0	9703 / 6-6	72
Z5.571.9656.0	ST 72.7 / 6 RV	681	Z5.573.1556.0	ST 72.1 /16 REV WR	679	Z7.212.0027.0	9703 / 8 M-50	196
Z5.571.9756.0	ST 72.7 /10 RV	681	Z5.573.1656.0	ST 72.1 / 6 REV WR	679	Z7.212.0227.0	9703 / 8-2	191
Z5.571.9856.0	ST 72.7 /24 RV	681	Z5.573.1756.0	ST 72.1 /10 REV WR	679	Z7.212.0327.0	9703 / 8-3	191
Z5.572.0056.0	BU 70.1 /16 REV WL	675	Z5.573.1856.0	ST 72.1 /24 REV WR	679	Z7.212.0427.0	9703 / 8-4	191
Z5.572.0156.0	BU 70.1 / 6 REV WL	675	Z5.573.2056.0	ST 70.1 /16 RV WL	675	Z7.212.0527.0	9703 / 8-5	191
Z5.572.0256.0	BU 70.1 /10 REV WL	675	Z5.573.2156.0	ST 70.1 / 6 RV WL	675	Z7.212.0627.0	9703 / 8-6	191
Z5.572.0356.0	BU 70.1 /24 REV WL	675	Z5.573.2256.0	ST 70.1 /10 RV WL	675	Z7.212.1227.0		148
Z5.572.0556.0	BU 72.1 /16 REV WL	679	Z5.573.2356.0	ST 70.1 /24 RV WL	675	Z7.212.1327.0		148
Z5.572.0656.0	BU 72.1 / 6 REV WL	679	Z5.573.2556.0	ST 72.1 /16 RV WL	679	Z7.212.1427.0		148
Z5.572.0756.0	BU 72.1 /10 REV WL	679	Z5.573.2656.0	ST 72.1 / 6 RV WL	679	Z7.212.1527.0		148
Z5.572.0856.0	BU 72.1 /24 REV WL	679	Z5.573.2756.0	ST 72.1 /10 RV WL	679	Z7.212.2027.0		148
Z5.572.1056.0	BU 70.1 /16 REV WR	675	Z5.573.2856.0	ST 72.1 /24 RV WL	679	Z7.212.2227.0		148
Z5.572.1156.0	BU 70.1 / 6 REV WR	675	Z5.573.3056.0	ST 70.1 /16 RV WR	675	Z7.212.2327.0		148
Z5.572.1256.0	BU 70.1 /10 REV WR	675	Z5.573.3156.0	ST 70.1 / 6 RV WR	675	Z7.212.2427.0		148
Z5.572.1356.0	BU 70.1 /24 REV WR	675	Z5.573.3256.0	ST 70.1 /10 RV WR	675	Z7.213.0027.0	9703 / 12 M	196
Z5.572.1556.0	BU 72.1 /16 REV WR	679	Z5.573.3356.0	ST 70.1 /24 RV WR	675	Z7.213.0227.0	9703 / 12-2	191
Z5.572.1656.0	BU 72.1 / 6 REV WR	679	Z5.573.3556.0	ST 72.1 /16 RV WR	679	Z7.213.0327.0	9703 / 12-3	191
Z5.572.1756.0	BU 72.1 /10 REV WR	679	Z5.573.3656.0	ST 72.1 / 6 RV WR	679	Z7.213.0427.0	9703 / 12-4	191
Z5.572.1856.0	BU 72.1 /24 REV WR	679	Z5.573.3756.0	ST 72.1 /10 RV WR	679	Z7.213.0527.0	9703 / 12-5	191
Z5.572.2056.0	BU 70.1 /16 RV WL	675	Z5.573.3856.0	ST 72.1 /24 RV WR	679	Z7.213.0627.0	9703 / 12-6	191
Z5.572.2156.0	BU 70.1 / 6 RV WL	675	Z5.573.4056.0	ST 70.1 /16 REV U WL	675	Z7.214.0027.0	9703 / 10 M	196
Z5.572.2256.0	BU 70.1 /10 RV WL	675	Z5.573.4156.0	ST 70.1 / 6 REV U WL	675	Z7.214.0227.0	9703 / 10-2	189
Z5.572.2356.0	BU 70.1 /24 RV WL	675	Z5.573.4256.0	ST 70.1 /10 REV U WL	675	Z7.214.0327.0	9703 / 10-3	191
Z5.572.2556.0	BU 72.1 /16 RV WL	679	Z5.573.4356.0	ST 70.1 /24 REV U WL	675	Z7.214.0427.0	9703 / 10-4	191
Z5.572.2656.0	BU 72.1 / 6 RV WL	679	Z5.573.4556.0	ST 72.1 /16 REV U WL	679	Z7.214.0527.0	9703 / 10-5	191
Z5.572.2756.0	BU 72.1 /10 RV WL	679	Z5.573.4656.0	ST 72.1 / 6 REV U WL	679	Z7.214.0627.0	9703 / 10-6	191
Z5.572.2856.0	BU 72.1 /24 RV WL	679	Z5.573.4756.0	ST 72.1 /10 REV U WL	679	Z7.215.0027.0	9703 / 5 M	190
Z5.572.3056.0	BU 70.1 /16 RV WR	675	Z5.573.4856.0	ST 72.1 /24 REV U WL	679	Z7.215.0227.0	9703 / 5-2	189
Z5.572.3156.0	BU 70.1 / 6 RV WR	675	Z5.573.5056.0	ST 70.1 /16 REV U WR	675	Z7.215.0327.0	9703 / 5-3	190
Z5.572.3256.0	BU 70.1 /10 RV WR	675	Z5.573.5156.0	ST 70.1 / 6 REV U WR	675	Z7.215.0427.0	9703 / 5-4	190
Z5.572.3356.0	BU 70.1 /24 RV WR	675	Z5.573.5256.0	ST 70.1 /10 REV U WR	675	Z7.215.0527.0	9703 / 5-5	190
Z5.572.3556.0	BU 72.1 /16 RV WR	679	Z5.573.5356.0	ST 70.1 /24 REV U WR	675	Z7.215.0627.0	9703 / 5-6	190
Z5.572.3656.0	BU 72.1 / 6 RV WR	679	Z5.573.5556.0	ST 72.1 /16 REV U WR	679	Z7.215.4027.0	VB WKM 2,5 / 15 M-60	164
Z5.572.3756.0	BU 72.1 /10 RV WR	679	Z5.573.5656.0	ST 72.1 / 6 REV U WR	679	Z7.215.4227.0	VB WKM 2,5 / 15 - 2	164
Z5.572.3856.0	BU 72.1 /24 RV WR	679	Z5.573.5756.0	ST 72.1 /10 REV U WR	679	Z7.215.4327.0	VB WKM 2,5 / 15 - 3	164
Z5.572.4056.0	BU 70.1 /16 REV U WL	675	Z5.573.5856.0	ST 72.1 /24 REV U WR	679	Z7.215.4427.0	VB WKM 2,5 / 15 - 4	164
Z5.572.4156.0	BU 70.1 / 6 REV U WL	675	Z5.573.6056.0	ST 70.1 /16 RV U WL	675	Z7.215.4527.0	VB WKM 2,5 / 15 - 5	164
Z5.572.4256.0	BU 70.1 /10 REV U WL	675	Z5.573.6156.0	ST 70.1 / 6 RV U WL	675	Z7.215.4627.0	VB WKM 2,5 / 15 - 6	164

contents

Part no.	Type	section / page	Part no.	Type	section / page	Part no.	Type	section / page
Z7.216.0027.0	9703 / 16 M	196	Z7.261.1527.0	IVBWK 4 - 5	20	Z7.280.2827.0	IVBWK 2,5 - 8	162
Z7.216.0227.0	9703 / 16- 2	189	Z7.261.1627.0	IVBWK 4 - 6	20	Z7.280.2927.0	IVBWK 2,5 - 9	162
Z7.216.0327.0	9703 / 16- 3	192	Z7.261.1727.0	IVBWK 4 - 7	20	Z7.280.3027.0	IVBWK 2,5 - 10	162
Z7.216.0427.0	9703 / 16- 4	192	Z7.261.1827.0	IVBWK 4 - 8	20	Z7.280.3127.0	IVBWK 2,5 - 11	162
Z7.216.0527.0	9703 / 16- 5	192	Z7.261.1927.0	IVBWK 4 - 9	20	Z7.280.3227.0	IVBWK 2,5 - 12	102
Z7.216.0627.0	9703 / 16- 6	192	Z7.261.2027.0	IVBWK 4 - 10	20	Z7.280.3327.0	IVBWK 2,5 - 12	310
Z7.220.0227.0	2072 / 2	141	Z7.267.0027.5	IVB WK 2,5-K-M-70 ROT	160	Z7.280.6227.0	IVBWK 2,5 - 2	19
Z7.220.0327.0	2072 / 3	164	Z7.267.0027.6	IVB WK 2,5-K-M-70 BLAU	160	Z7.280.6227.0	IVBWK 2,5 - 2	308
Z7.220.0427.0	2072 / 4	164	Z7.267.0227.5	IVB WK 2,5-K- 2 ROT	118	Z7.280.6327.0	IVBWK 2,5 - 3	19
Z7.220.0527.0	2072 / 5	164	Z7.267.0227.6	IVB WK 2,5-K- 2 BLAU	118	Z7.280.6327.0	IVBWK 2,5 - 3	308
Z7.220.0627.0	2072 / 6	141	Z7.267.0327.5	IVB WK 2,5-K- 3 ROT	160	Z7.280.6427.0	IVBWK 2,5 - 4	20
Z7.255.0227.0	IVB 0,5 WK4. - 2	86	Z7.267.0327.6	IVB WK 2,5-K- 3 BLAU	160	Z7.280.6427.0	IVBWK 2,5 - 4	308
Z7.255.0327.0	IVB 0,5 WK4. - 3	86	Z7.267.0427.5	IVB WK 2,5-K- 4 ROT	160	Z7.280.6527.0	IVBWK 2,5 - 5	20
Z7.255.0427.0	IVB 0,5 WK4. - 4	86	Z7.267.0427.6	IVB WK 2,5-K- 4 BLAU	160	Z7.280.6527.0	IVBWK 2,5 - 5	308
Z7.255.0527.0	IVB 0,5 WK4. - 5	86	Z7.267.0527.5	IVB WK 2,5-K- 5 ROT	160	Z7.280.6627.0	IVBWK 2,5 - 6	20
Z7.255.0627.0	IVB 0,5 WK4. - 6	86	Z7.267.0527.6	IVB WK 2,5-K- 5 BLAU	160	Z7.280.6627.0	IVBWK 2,5 - 6	308
Z7.255.0727.0	IVB 0,5 WK4. - 7	86	Z7.267.0627.5	IVB WK 2,5-K- 6 ROT	160	Z7.280.6727.0	IVBWK 2,5 - 7	19
Z7.255.0827.0	IVB 0,5 WK4. - 8	86	Z7.267.0627.6	IVB WK 2,5-K- 6 BLAU	160	Z7.280.6727.0	IVBWK 2,5 - 7	308
Z7.255.0927.0	IVB 0,5 WK4. - 9	86	Z7.267.0727.5	IVB WK 2,5-K- 7 ROT	160	Z7.280.6827.0	IVBWK 2,5 - 8	20
Z7.255.1027.0	IVB 0,5 WK4. - 10	86	Z7.267.0727.6	IVB WK 2,5-K- 7 BLAU	160	Z7.280.6827.0	IVBWK 2,5 - 8	308
Z7.255.1127.0	IVB 0,5 WK4. - 11	86	Z7.267.0827.5	IVB WK 2,5-K- 8 ROT	160	Z7.280.6927.0	IVBWK 2,5 - 9	20
Z7.255.1227.0	IVB 0,5 WK4. - 12	86	Z7.267.0827.6	IVB WK 2,5-K- 8 BLAU	160	Z7.280.6927.0	IVBWK 2,5 - 9	308
Z7.255.2227.0	IVB WK4 E - 2	114	Z7.267.0927.5	IVB WK 2,5-K- 9 ROT	160	Z7.280.7027.0	IVBWK 2,5 - 10	20
Z7.255.2327.0	IVB WK4 E - 3	160	Z7.267.0927.6	IVB WK 2,5-K- 9 BLAU	160	Z7.280.7027.0	IVBWK 2,5 - 10	308
Z7.255.2427.0	IVB WK4 E - 4	160	Z7.267.1027.5	IVB WK 2,5-K- 10 ROT	160	Z7.281.0027.0	VB WK 4 M-70	87
Z7.255.2527.0	IVB WK4 E - 5	160	Z7.267.1027.6	IVB WK 2,5-K- 10 BLAU	160	Z7.281.0227.0	VB WK 4 - 2	87
Z7.255.2627.0	IVB WK4 E - 6	114	Z7.267.1127.5	IVB WK 2,5-K- 11 ROT	160	Z7.281.0327.0	VB WK 4 - 3	87
Z7.255.2727.0	IVB WK4 E - 7	160	Z7.267.1127.6	IVB WK 2,5-K- 6 BLAU	160	Z7.281.0427.0	VB WK 4 - 4	87
Z7.255.2827.0	IVB WK4 E - 8	160	Z7.267.1227.5	IVB WK 2,5-K- 12 ROT	118	Z7.281.0527.0	VB WK 4 - 5	87
Z7.255.2927.0	IVB WK4 E - 9	160	Z7.267.1227.6	IVB WK 2,5-K- 12 BLAU	118	Z7.281.0627.0	VB WK 4 - 6	87
Z7.255.3027.0	IVB WK4 E - 10	160	Z7.269.0523.0	9012 / 6	197	Z7.281.1227.0	IVBWK 4 - 2	78
Z7.255.3127.0	IVB WK4 E - 11	160	Z7.269.0623.0	9012 / 2,5 UB	161	Z7.281.1327.0	IVBWK 4 - 3	78
Z7.255.3227.0	IVB WK4 E - 12	160	Z7.269.0723.0	9012	197	Z7.281.1427.0	IVBWK 4 - 4	78
Z7.255.4227.0	IVB 1 WK4. - 2	86	Z7.269.2823.0	QUERSCHALTASCH	197	Z7.281.1527.0	IVBWK 4 - 5	78
Z7.255.4327.0	IVB 1 WK4. - 3	86	Z7.269.2923.0	QUERSCHALTASCH	161	Z7.281.1627.0	IVBWK 4 - 6	78
Z7.255.4427.0	IVB 1 WK4. - 4	86	Z7.269.3023.0	QUERSCHALTASCH	189	Z7.281.1727.0	IVBWK 4 - 7	87
Z7.255.4527.0	IVB 1 WK4. - 5	86	Z7.269.3123.0	QUERSCHALTASCH	191	Z7.281.1827.0	IVBWK 4 - 8	87
Z7.255.4627.0	IVB 1 WK4. - 6	86	Z7.269.3223.0	QUERSCHALTASCH	191	Z7.281.1927.0	IVBWK 4 - 9	87
Z7.255.4727.0	IVB 1 WK4. - 7	86	Z7.269.3423.0	QUERSCHALTASCH	192	Z7.281.2027.0	IVBWK 4 - 10	87
Z7.255.4827.0	IVB 1 WK4. - 8	86	Z7.269.3523.0	QUERSCHALTASCH	190	Z7.281.2127.0	IVBWK 4 - 11	87
Z7.255.4927.0	IVB 1 WK4. - 9	86	Z7.269.3623.0	QUERSCHALTASCH	161	Z7.281.2227.0	IVBWK 4 - 12	87
Z7.255.5027.0	IVB 1 WK4. - 10	86	Z7.269.4023.0	QUERSCHALTASCH	161	Z7.281.3027.0	VB WK/.S/WW/U-20	164
Z7.255.5127.0	IVB 1 WK4. - 11	86	Z7.269.4123.0	QUERSCHALTASCH	161	Z7.281.3227.0	VB WK/.S/WW/U- 2	140
Z7.255.5227.0	IVB 1 WK4. - 12	86	Z7.269.4223.0	QUERSCHALTASCH	161	Z7.281.3327.0	VB WK/.S/WW/U- 3	140
Z7.256.0227.0	FUER 70ER KLEMMENADAPT.	781	Z7.270.0027.0	IVB WK 2,5-3D- M-70	162	Z7.281.3427.0	VB WK/.S/WW/U- 4	164
Z7.256.0327.0	FUER 70ER KLEMMENADAPT.	781	Z7.270.0227.0	IVB WK 2,5-3D- 2	118	Z7.281.3527.0	VB WK/.S/WW/U- 5	164
Z7.256.0427.0	FUER 70ER KLEMMENADAPT.	781	Z7.270.0327.0	IVB WK 2,5-3D- 3	118	Z7.281.3627.0	VB WK/.S/WW/U- 6	140
Z7.256.0527.0	FUER 70ER KLEMMENADAPT.	781	Z7.270.0427.0	IVB WK 2,5-3D- 4	162	Z7.281.6027.0	VB WK 4/D.-M-70	164
Z7.256.0627.0	FUER 70ER KLEMMENADAPT.	781	Z7.270.0527.0	IVB WK 2,5-3D- 5	162	Z7.281.6227.0	VB WK 4/D.-2	164
Z7.256.0727.0	FUER 70ER KLEMMENADAPT.	781	Z7.270.0627.0	IVB WK 2,5-3D- 6	162	Z7.281.6327.0	VB WK 4/D.-3	164
Z7.256.0827.0	FUER 70ER KLEMMENADAPT.	781	Z7.270.0727.0	IVB WK 2,5-3D- 7	162	Z7.281.6427.0	VB WK 4/D.-4	164
Z7.256.0927.0	FUER 70ER KLEMMENADAPT.	781	Z7.270.0827.0	IVB WK 2,5-3D- 8	162	Z7.281.6527.0	VB WK 4/D.-5	164
Z7.256.1027.0	FUER 70ER KLEMMENADAPT.	781	Z7.270.0927.0	IVB WK 2,5-3D- 9	162	Z7.281.6627.0	VB WK 4/D.-6	164
Z7.256.1127.0	FUER 70ER KLEMMENADAPT.	781	Z7.270.1027.0	IVB WK 2,5-3D- 10	162	Z7.281.7227.0	IVB WK 4/D.-2	112
Z7.256.1227.0	FUER 70ER KLEMMENADAPT.	781	Z7.270.1127.0	IVB WK 2,5-3D- 11	162	Z7.281.7327.0	IVB WK 4/D.-3	112
Z7.256.2227.0	IVK WK 4/DEU- 2	112	Z7.270.1227.0	IVB WK 2,5-3D- 12	118	Z7.281.7427.0	IVB WK 4/D.-4	162
Z7.256.2627.0	IVK WK 4/DEU- 6	112	Z7.271.0227.0	IVB WK 4/DEU- 2	113	Z7.281.7527.0	IVB WK 4/D.-5	162
Z7.256.4227.0	IVBS WK4 E - 2	114	Z7.271.0327.0	IVB WK 4/DEU- 3	113	Z7.281.7627.0	IVB WK 4/D.-6	162
Z7.256.4327.0	IVBS WK4 E - 3	160	Z7.271.0427.0	IVB WK 4/DEU- 4	162	Z7.281.7727.0	IVB WK 4/D.-7	162
Z7.256.4427.0	IVBS WK4 E - 4	160	Z7.271.0527.0	IVB WK 4/DEU- 5	162	Z7.281.7827.0	IVB WK 4/D.-8	162
Z7.256.4527.0	IVBS WK4 E - 5	160	Z7.271.0627.0	IVB WK 4/DEU- 6	162	Z7.281.7927.0	IVB WK 4/D.-9	162
Z7.256.4627.0	IVBS WK4 E - 6	114	Z7.271.0727.0	IVB WK 4/DEU- 7	162	Z7.281.8027.0	IVB WK 4/D.-10	162
Z7.256.4727.0	IVBS WK4 E - 7	160	Z7.271.0827.0	IVB WK 4/DEU- 8	162	Z7.281.8127.0	IVB WK 4/D.-11	162
Z7.256.4827.0	IVBS WK4 E - 8	160	Z7.271.0927.0	IVB WK 4/DEU- 9	162	Z7.281.8227.0	IVB WK 4/D.-12	112
Z7.256.4927.0	IVBS WK4 E - 9	160	Z7.271.1027.0	IVB WK 4/DEU- 10	162	Z7.282.0027.0	VB WK 6 M-40	165
Z7.256.5027.0	IVBS WK4 E - 10	160	Z7.271.1127.0	IVB WK 4/DEU- 11	162	Z7.282.0227.0	VB WK 6 - 2	165
Z7.256.5127.0	IVBS WK4 E - 11	160	Z7.271.1227.0	IVB WK 4/DEU- 12	113	Z7.282.0327.0	VB WK 6 - 3	165
Z7.256.5227.0	IVBS WK4 E - 12	160	Z7.271.2227.0	IVB WK4 E/U- 2	145	Z7.282.0427.0	VB WK 6 - 4	165
Z7.258.0225.0	ISOL.VERB.ST.	204	Z7.271.2327.0	IVB WK4 E/U- 3	145	Z7.282.0527.0	VB WK 6 - 5	165
Z7.258.0325.0	ISOL.VERB.ST.	204	Z7.271.2427.0	IVB WK4 E/U- 4	162	Z7.282.0627.0	VB WK 6 - 6	165
Z7.258.1025.0	ISOL.VERB.ST.	204	Z7.271.2527.0	IVB WK4 E/U- 5	162	Z7.282.2227.0	IVBWK 6 - 2	103
Z7.258.1225.0	ISOL.VERB.KAMM	416	Z7.271.2627.0	IVB WK4 E/U- 6	162	Z7.282.2327.0	IVBWK 6 - 3	101
Z7.258.1225.0	ISOL.VERB.KAMM	781	Z7.271.2727.0	IVB WK4 E/U- 7	162	Z7.282.2427.0	IVBWK 6 - 4	163
Z7.258.1325.0	ISOL.VERB.KAMM	781	Z7.271.2827.0	IVB WK4 E/U- 8	162	Z7.282.2527.0	IVBWK 6 - 5	163
Z7.258.1425.0	ISOL.VERB.KAMM	781	Z7.271.2927.0	IVB WK4 E/U- 9	162	Z7.282.2627.0	IVBWK 6 - 6	163
Z7.258.1525.0	ISOL.VERB.KAMM	781	Z7.271.3027.0	IVB WK4 E/U- 10	162	Z7.282.2727.0	IVBWK 6 - 7	163
Z7.258.1625.0	ISOL.VERB.KAMM	781	Z7.271.3127.0	IVB WK4 E/U- 11	162	Z7.282.2827.0	IVBWK 6 - 8	163
Z7.258.1725.0	ISOL.VERB.KAMM	781	Z7.271.3227.0	IVB WK4 E/U- 12	145	Z7.282.2927.0	IVBWK 6 - 9	163
Z7.258.1825.0	ISOL.VERB.KAMM	781	Z7.271.4227.0	IVB WK14 - 2	139	Z7.282.3027.0	IVBWK 6-10	163
Z7.258.1925.0	ISOL.VERB.KAMM	781	Z7.271.4327.0	IVB WK14 - 3	139	Z7.282.3127.0	IVBWK 6-11	163
Z7.258.2025.0	ISOL.VERB.KAMM	781	Z7.271.5227.0	IVB WK14 - 12	69	Z7.282.3227.0	IVBWK 6-12	103
Z7.260.0029.0		40	Z7.280.0027.0	VB WK 2,5 M-80	164	Z7.282.4227.0	IVBWK 6-2	21
Z7.260.0229.0		40	Z7.280.0227.0	VB WK 2,5 - 2	120	Z7.283.2227.0	IVBWK 10 - 2	78
Z7.260.0329.0		40	Z7.280.0327.0	VB WK 2,5 - 3	120	Z7.283.2327.0	IVBWK 10 - 3	78
Z7.260.0429.0		40	Z7.280.0427.0	VB WK 2,5 - 4	164	Z7.283.2427.0	IVBWK 10 - 4	78
Z7.260.0529.0		40	Z7.280.0527.0	VB WK 2,5 - 5	164	Z7.283.2527.0	IVBWK 10 - 5	78
Z7.260.0629.0		40	Z7.280.0627.0	VB WK 2,5 - 6	120	Z7.283.2627.0	IVBWK 10 - 6	78
Z7.260.0729.0		40	Z7.280.2227.0	IVBWK 2,5 - 2	102	Z7.283.2727.0	IVBWK 10 - 7	163
Z7.260.0829.0		40	Z7.280.2227.0	IVBWK 2,5 - 2	310	Z7.283.2827.0	IVBWK 10 - 8	163
Z7.260.0929.0		40	Z7.280.2327.0	IVBWK 2,5 - 3	102	Z7.283.2927.0	IVBWK 10 - 9	163
Z7.260.1029.0		40	Z7.280.2327.0	IVBWK 2,5 - 3	310	Z7.283.3027.0	IVBWK 10 - 10	163
Z7.261.1127.0		30	Z7.280.2427.0	IVBWK 2,5 - 4	162	Z7.283.3127.0	IVBWK 10 - 11	163
Z7.261.1227.0	IVBWK 4 - 2	20	Z7.280.2527.0	IVBWK 2,5 - 5	162	Z7.283.3227.0	IVBWK 10 - 12	103
Z7.261.1327.0	IVBWK 4 - 3	20	Z7.280.2627.0	IVBWK 2,5 - 6	162	Z7.283.6027.0	VBWKN 10 - M-40	165
Z7.261.1427.0	IVBWK 4 - 4	20	Z7.280.2727.0	IVBWK 2,5 - 7	162	Z7.283.6227.0	VBWKN 10 - 2	165

contents of
part number

contents PART NUMBER

Part no.	Type	section / page	Part no.	Type	section / page	Part no.	Type	section / page
Z7.283.6327.0	VBWKN 10 - 3	165	Z7.415.3335.0	1X50P STECKER LOET	756			
Z7.283.6427.0	VBWKN 10 - 4	165	Z7.415.3410.0	2X50P BUCHSE LOET	756			
Z7.283.6527.0	VBWKN 10 - 5	165	Z7.415.3535.0	2X50P STECKER LOET	756			
Z7.283.6627.0	VBWKN 10 - 6	165	Z7.416.1656.0	DECKEL	780			
Z7.283.8227.0	IBWVKF 10- 2	21	Z7.416.1756.0	DECKEL	780			
Z7.284.2027.0	IBWKN16 - M-30	163	Z7.416.1856.0	DECKEL	780			
Z7.284.2227.0	IBWKN16 - 2	104	Z7.419.6128.0	DECKEL M.VERRIEG.	780			
Z7.284.2327.0	IBWKN16 - 3	104	Z7.419.6228.0	DECKEL	780			
Z7.284.2427.0	IBWKN16 - 4	163	Z8.000.0035.5	24 VDC 2W	455			
Z7.284.2527.0	IBWKN16 - 5	163	Z8.000.0056.9	24 VDC 1W	454			
Z7.284.2627.0	IBWKN16 - 6	163	Z8.000.0103.4	KB 1 RM 5.08	460			
Z7.284.2727.0	IBWKN16 - 7	163	Z8.000.0123.1	B EXP. BOARD WEG 6 POL	592			
Z7.284.2827.0	IBWKN16 - 8	163	Z8.000.0156.9	OAC 3-32V/24-280V	482			
Z7.284.2927.0	IBWKN16 - 9	163	Z8.000.0169.8	ODC 3-32V/3-60V	482			
Z7.284.3027.0	IBWKN16 - 10	163	Z8.000.0169.9	ODC 3-32V/3-200V	482			
Z7.284.3127.0	IBWKN16 - 11	163	Z8.000.0176.2	110 VDC 2W	458			
Z7.284.3227.0	IBWKN16 - 12	104	Z8.000.0181.0	110 VDC 1W	456			
Z7.284.4227.0	IBWVKF 16- 2	21	Z8.000.0200.8	VBRM3.3	442			
Z7.284.6227.0	IVB WKIF 16-2	25	Z8.000.0202.1	EKAP ROT	442			
Z7.284.9227.0		79	Z8.000.0202.2	EKAP BLAU	442			
Z7.284.9327.0		79	Z8.000.0202.3	VBK6.2 ROT	442			
Z7.284.9427.0		79	Z8.000.0202.4	VBK6.2 BLAU	442			
Z7.284.9527.0		79	Z8.000.0229.5	DIPOS JB 4,3	499			
Z7.284.9627.0		79						
Z7.285.2027.0	IBWKN35 - M-20	163						
Z7.285.2227.0	IBWKN35 - 2	105						
Z7.285.2327.0	IBWKN35 - 3	105						
Z7.285.2427.0	IBWKN35 - 4	163						
Z7.285.2527.0	IBWKN35 - 5	163						
Z7.285.2627.0	IBWKN35 - 6	163						
Z7.285.2727.0	IBWKN35 - 7	163						
Z7.285.2827.0	IBWKN35 - 8	163						
Z7.285.2927.0	IBWKN35 - 9	163						
Z7.285.3027.0	IBWKN35 - 10	163						
Z7.285.3127.0	IBWKN35 - 11	163						
Z7.285.3227.0	IBWKN35 - 12	105						
Z7.285.4227.0	IBWKI35 - 2	79						
Z7.285.4327.0	IBWKI35 - 3	79						
Z7.285.4427.0	IBWKI35 - 4	79						
Z7.285.4527.0	IBWKI35 - 5	79						
Z7.285.4627.0	IBWKI35 - 6	79						
Z7.286.3227.0	VB WKN70 - 2	165						
Z7.286.3327.0	VB WKN70 - 3	165						
Z7.286.3427.0	VB WKN70 - 4	165						
Z7.286.3527.0	VB WKN70 - 5	165						
Z7.286.3627.0	VB WKN70 - 6	165						
Z7.287.0027.0	VB WK 10 / SI M-30	165						
Z7.287.0227.0	VB WK 10 / SI - 2	125						
Z7.287.0327.0	VB WK 10 / SI - 3	125						
Z7.287.0427.0	VB WK 10 / SI - 4	165						
Z7.287.0527.0	VB WK 10 / SI - 5	165						
Z7.287.0627.0	VB WK 10 / SI - 6	125						
Z7.287.1227.0	VBWKN150 - 2	165						
Z7.287.1327.0	VBWKN150 - 3	165						
Z7.288.0027.0	VB WKI 10 M-40	87						
Z7.288.0227.0	VB WKI 10 - 2	87						
Z7.288.0327.0	VB WKI 10 - 3	87						
Z7.288.0427.0	VB WKI 10 - 4	87						
Z7.288.0527.0	VB WKI 10 - 5	87						
Z7.288.0627.0	VB WKI 10 - 6	87						
Z7.289.0027.0	VB WKI 16 M-20	87						
Z7.289.0227.0	VB WKI 16 - 2	87						
Z7.289.0327.0	VB WKI 16 - 3	69						
Z7.289.0427.0	VB WKI 16 - 4	87						
Z7.289.0527.0	VB WKI 16 - 5	87						
Z7.289.0627.0	VB WKI 16 - 6	87						
Z7.311.1753.0		167						
Z7.311.2753.0	KL.LST.BEZ. TS15	167						
Z7.409.5753.0	ABDECKUNG	156						
Z7.409.5853.0	ABDECKUNG	158						
Z7.409.7056.0	SCHUTZDECKEL	780						
Z7.409.7156.0	SCHUTZDECKEL	780						
Z7.409.7256.0	SCHUTZDECKEL	780						
Z7.409.7356.0	SCHUTZDECKEL	780						
Z7.409.8856.0	SCHUTZDECKEL	780						
Z7.409.8956.0	SCHUTZDECKEL	780						
Z7.415.0010.0	1X 9P BUCHSE LOET	756						
Z7.415.0110.0	2X 9P BUCHSE LOET	756						
Z7.415.0235.0	1X 9P STECKER LOET	756						
Z7.415.0335.0	2X 9P STECKER LOET	756						
Z7.415.0810.0	1X15P BUCHSE LOET	756						
Z7.415.0910.0	2X15P BUCHSE LOET	756						
Z7.415.1035.0	1X15P STECKER LOET	756						
Z7.415.1135.0	2X15P STECKER LOET	756						
Z7.415.1610.0	1X25P BUCHSE LOET	756						
Z7.415.1710.0	2X25P BUCHSE LOET	756						
Z7.415.1810.0	1X25+1X15P BUCHSE LOET	756						
Z7.415.1935.0	1X25P STECKER LOET	756						
Z7.415.2035.0	2X25P STECKER LOET	756						
Z7.415.2135.0	1X25+1X15P STECKER LOET	756						
Z7.415.2410.0	1X37P BUCHSE LOET	756						
Z7.415.2510.0	2X37P BUCHSE LOET	756						
Z7.415.2635.0	1X37P STECKER LOET	756						
Z7.415.2735.0	2X37P STECKER LOET	756						
Z7.415.3210.0	1X50P BUCHSE LOET	756						

contents

Part no.	Type	section / page	Part no.	Type	section / page	Part no.	Type	section / page
----------	------	----------------	----------	------	----------------	----------	------	----------------

notice



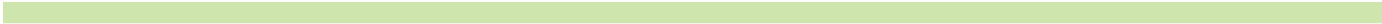

notice



notice

notice





wieland

Electrical
Connections

USA

Wieland Electric Inc.
49 International Road
Burgaw, NC 28425
Phone: (910) 259-5050
Fax: (910) 259-3691
e-mail: sales@wielandinc.com

Canada

Wieland Electric Inc.
2889 Brighton Road
Oakville, Ontario L6H 6C9
Phone: (905) 829-8414
Fax: (905) 829-8413
e-mail: oakville@wielandinc.com

On the Internet:

www.wielandinc.com

Toll Free 1-800-wieland

DIN rail terminal blocks

- with screw connection
- with spring connection
- with IDC connection

Terminal blocks for electrical installations

- with screw connection
- with spring connection

Lighting and appliance terminals
Terminal strips

PC board connectors

- modular/pluggable
- insulated headers
- rising cage clamp/
plug connectors
- TOP connection
- Spring connection
- electronics housings

Electronics components

- relay modules
- solid-state modules
- interface modules
- function modules
- Power Supplies

Fieldbus components

- motor starter
- power bus
- distributed I/Os

Systems for electrical installation

- Mains connectors
- Bus connectors
- Compact connectors
- Low voltage connectors
- Flat cable systems
- Distribution systems
- EIB switching devices

Multipole connectors
Multipole adapter
EExi
Data cablefeed-through
Connectors with mixed contacts



Product Range