

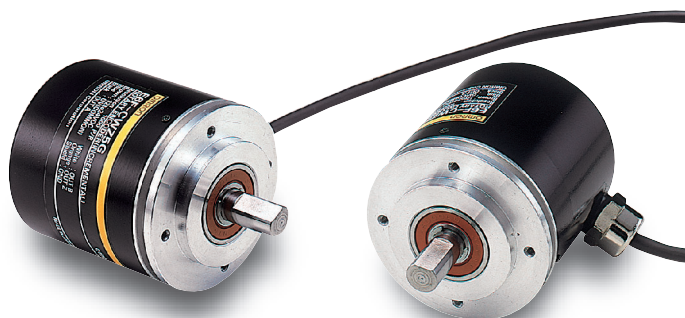

E6F-C

Rugged Encoder with the Strongest Shaft

- Rugged construction with the highest shaft loading.
Radial: 120 N, Thrust: 50 N
- IP65 oil resistant construction.
- Complementary output for longer cable length extension.
- Output load short-circuit protection to reduce risks from incorrect wiring.
- NPN open-collector output added



 Be sure to read *Safety Precautions* on page 3.

Ordering Information

Encoders [\[Refer to Dimensions on page 4.\]](#)

Power supply voltage	Output configuration	Resolution (pulses/rotation)	Model
12 to 24 VDC	Complementary output	100, 200, 360, 500, 600	E6F-CWZ5G (resolution) 2M
		1,000	Example: E6F-CWZ5G (100P/R) 2M
	NPN open-collector output	1,000	E6F-CWZ5C (1000P/R) 2M

Accessories (Order Separately) [\[Refer to Dimensions on page 4 for servo mounting bracket and to Accessories for coupling dimensions.\]](#)

Name	Model	Remarks
Couplings	E69-C10B	---
	E69-C610B	Different end diameter
	E69-C10M	Metal construction
Servo Mounting Bracket	E69-2	(Three brackets in a set.)

Refer to *Accessories* for details.

Ratings and Specifications

Item	Model	E6F-CWZ5G	E6F-CWZ5C
Power supply voltage		12 VDC -10% to 24 VDC $+15\%$, ripple (p-p): 5% max.	
Current consumption*1		100 mA max.	
Resolution (pulses/rotation)		100, 200, 360, 500, 600, 1,000	1,000
Output configuration		Complementary outputs*2	NPN open-collector output
Output capacity		Output voltage: $V_H = V_{CC} - 3 \text{ V min.}$ ($I_o = 30 \text{ mA}$), $V_L = 2 \text{ V max.}$ ($I_o = -30 \text{ mA}$) Output current: $\pm 30 \text{ mA}$	Applied voltage: 30 VDC max. Sink current: 35 mA max. Residual voltage: 0.4 V max. (at sink current of 35 mA)
Maximum response frequency		83 kHz	
Phase difference between outputs		$90^\circ \pm 45^\circ$ between A and B ($1/4 \text{ T} \pm 1/8 \text{ T}$)	
Rise and fall times of output		1 μs max. (Cable length: 2 m, Output current: 30 mA)	1 μs max. (Cable length: 2 m, Control output voltage: 5 V, Load resistance: 1 k Ω)
Starting torque		10 mN·m max. at room temperature, 15 mN·m max. at low temperature	
Moment of inertia		$3 \times 10^{-6} \text{ kg}\cdot\text{m}^2$ max.; $1.5 \times 10^{-6} \text{ kg}\cdot\text{m}^2$ max. at 600 P/R max.	
Shaft loading	Radial	120 N	
	Thrust	50 N	
Maximum permissible speed		5,000 r/min	
Protection circuits		Power supply reverse polarity protection, Output load short-circuit protection	
Ambient temperature range		Operating: -10 to 70°C (with no icing), Storage: -25 to 85°C (with no icing)	
Ambient humidity range		Operating/Storage: 35% to 85% (with no condensation)	
Insulation resistance		20 M Ω min. (at 500 VDC) between current-carrying parts and case	
Dielectric strength		500 VAC, 50/60 Hz for 1 min between current-carrying parts and case	
Vibration resistance		Destruction: 10 to 500 Hz, 150 m/s ² or 2-mm double amplitude for 11 min 3 times each in X, Y, and Z directions	
Shock resistance		Destruction: 1,000 m/s ² 3 times each in X, Y, and Z directions	
Degree of protection		IEC 60529 IP65, in-house standards: oilproof	
Connection method		Pre-wired Models (Standard cable length: 2 m)	
Material		Case: Zinc alloy, Main unit: Aluminum, Shaft: SUS420J2	
Weight (packed state)		Approx. 500 g	
Accessories		Instruction manual	

*1. An inrush current of approximately 9 A will flow for approximately 5 μs when the power is turned ON.

*2. Complementary Outputs

The complementary output has two output transistors (NPN and PNP) as shown at the right. These two output transistors alternately turn ON and OFF depending on the high or low output signal. When using them, pull up to the positive power supply voltage level or pull down to 0 V. The complementary output allows flow-in or flow-out of the output current and thus the rising and falling speeds of signals are fast. This allows a long cable distance. They can be connected to open-collector input devices (NPN, PNP).

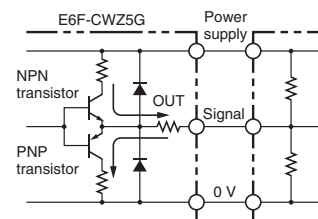

I/O Circuit Diagrams

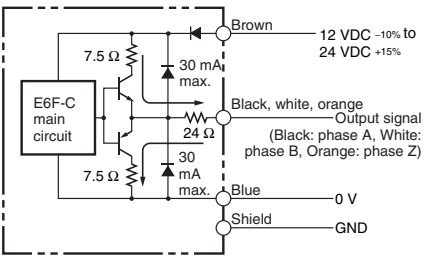
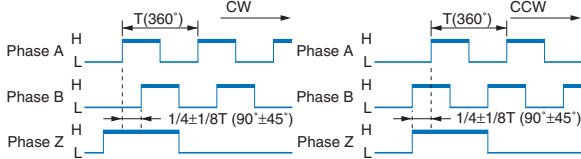
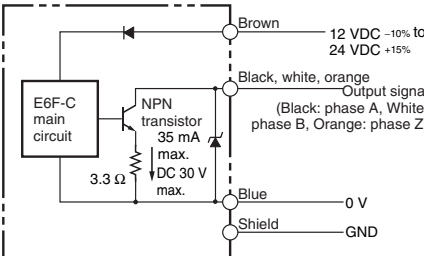
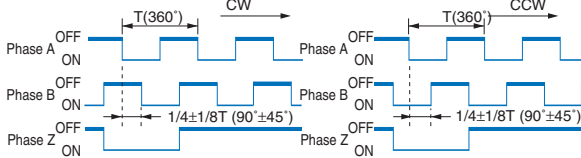
Output Circuits	Output mode	Connection												
<p>E6F-CWZ5G</p> 	<p>Direction of rotation: CW (as viewed from end of shaft) Direction of rotation: CCW (as viewed from end of shaft)</p>  <p>Note: Phase A is $1/4 T \pm 1/8 T$ faster than phase B. Note: Phase A is $1/4 T \pm 1/8 T$ slower than phase B.</p>	<table border="1"> <thead> <tr> <th>Color</th> <th>Terminal</th> </tr> </thead> <tbody> <tr> <td>Brown</td> <td>Power supply (+Vcc)</td> </tr> <tr> <td>Black</td> <td>Output phase A</td> </tr> <tr> <td>White</td> <td>Output phase B</td> </tr> <tr> <td>Orange</td> <td>Output phase Z</td> </tr> <tr> <td>Blue</td> <td>0 V (common)</td> </tr> </tbody> </table>	Color	Terminal	Brown	Power supply (+Vcc)	Black	Output phase A	White	Output phase B	Orange	Output phase Z	Blue	0 V (common)
Color	Terminal													
Brown	Power supply (+Vcc)													
Black	Output phase A													
White	Output phase B													
Orange	Output phase Z													
Blue	0 V (common)													
<p>E6F-CWZ5C</p> 	<p>Direction of rotation: CW (as viewed from end of shaft) Direction of rotation: CCW (as viewed from end of shaft)</p>  <p>Note: Phase A is $1/4 T \pm 1/8 T$ faster than phase B. Note: Phase A is $1/4 T \pm 1/8 T$ slower than phase B.</p>													

Note: 1. The shielded cable outer core (shield) is not connected to the inner area or to the case.
 2. The phase A, phase B, and phase Z circuits are all identical.
 3. Normally, connect GND to 0 V or to an external ground.

Safety Precautions

Refer to *Warranty and Limitations of Liability*.

⚠ WARNING

This product is not designed or rated for ensuring safety of persons either directly or indirectly. Do not use it for such purposes.



Precautions for Correct Use

Do not use the Encoder under ambient conditions that exceed the ratings.

● **Wiring**

Cable Extension Characteristics

- When the cable length is extended, the output waveform startup time is lengthened and it affects the phase difference characteristics of phases A and B.
- * Recommended Cable
 Conductor cross section: 0.2 mm²
 Spiral shield
 Conductor resistance: 92 Ω/km max. (20°C)
 Insulation resistance: 5 Ω/km min. (20°C)
- The output waveform startup time changes not only according to the length of the cable, but also according to the load resistance and the cable type.
- Extending the cable length not only changes the startup time, but also increases the output residual voltage.

● **Connection**

- Spurious pulses may be generated when power is turned ON and OFF. Wait at least 0.1 s after turning ON the power to the Encoder before using the connected device, and stop using the connected device at least 0.1 s before turning OFF the power to the Encoder. Also, turn ON the power to the load only after turning ON the power to the Encoder.
- When the complementary output is used, the output will turn OFF when the load short-circuit protection circuit operates. To clear this condition, turn OFF the power supply, check the condition of the load wiring, and then turn ON the power supply again at least 0.2 s after turning it OFF.

Dimensions

Tolerance class IT16 applies to dimensions in this datasheet unless otherwise specified.

Encoder

E6F-CWZ5G

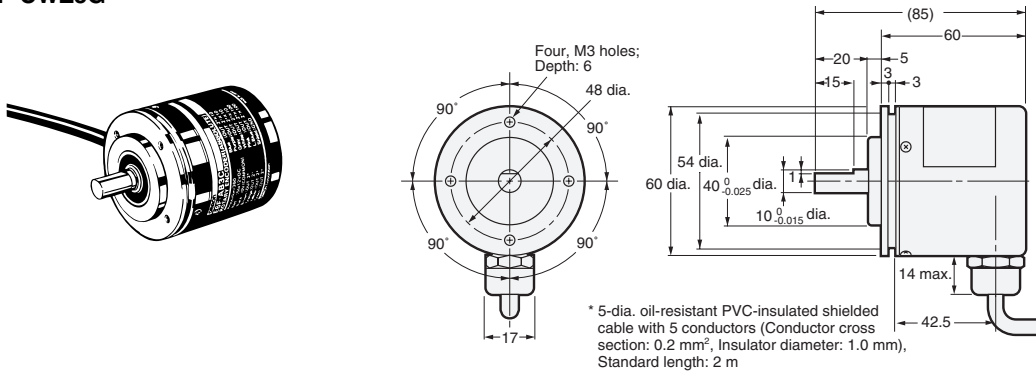

Accessories (Order Separately)

Servo Mounting Bracket

E69-2

Mounting Bracket Installation

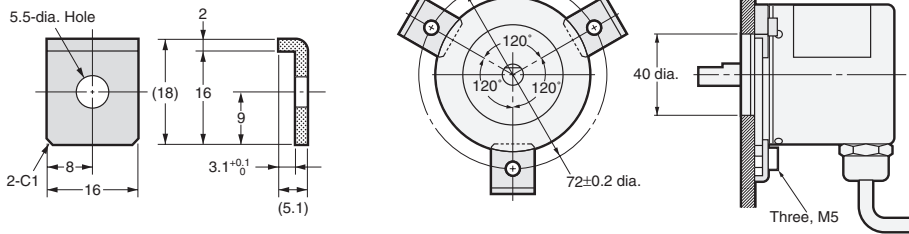

Couplings

E69-C10B

E69-C610B

E69-C10M

Refer to *Accessories* for details.

Read and Understand This Catalog

Please read and understand this catalog before purchasing the products. Please consult your OMRON representative if you have any questions or comments.

Warranty and Limitations of Liability

WARRANTY

OMRON's exclusive warranty is that the products are free from defects in materials and workmanship for a period of one year (or other period if specified) from date of sale by OMRON.

OMRON MAKES NO WARRANTY OR REPRESENTATION, EXPRESS OR IMPLIED, REGARDING NON-INFRINGEMENT, MERCHANTABILITY, OR FITNESS FOR PARTICULAR PURPOSE OF THE PRODUCTS. ANY BUYER OR USER ACKNOWLEDGES THAT THE BUYER OR USER ALONE HAS DETERMINED THAT THE PRODUCTS WILL SUITABLY MEET THE REQUIREMENTS OF THEIR INTENDED USE. OMRON DISCLAIMS ALL OTHER WARRANTIES, EXPRESS OR IMPLIED.

LIMITATIONS OF LIABILITY

OMRON SHALL NOT BE RESPONSIBLE FOR SPECIAL, INDIRECT, OR CONSEQUENTIAL DAMAGES, LOSS OF PROFITS OR COMMERCIAL LOSS IN ANY WAY CONNECTED WITH THE PRODUCTS, WHETHER SUCH CLAIM IS BASED ON CONTRACT, WARRANTY, NEGLIGENCE, OR STRICT LIABILITY.

In no event shall the responsibility of OMRON for any act exceed the individual price of the product on which liability is asserted.

IN NO EVENT SHALL OMRON BE RESPONSIBLE FOR WARRANTY, REPAIR, OR OTHER CLAIMS REGARDING THE PRODUCTS UNLESS OMRON'S ANALYSIS CONFIRMS THAT THE PRODUCTS WERE PROPERLY HANDLED, STORED, INSTALLED, AND MAINTAINED AND NOT SUBJECT TO CONTAMINATION, ABUSE, MISUSE, OR INAPPROPRIATE MODIFICATION OR REPAIR.

Application Considerations

SUITABILITY FOR USE

OMRON shall not be responsible for conformity with any standards, codes, or regulations that apply to the combination of products in the customer's application or use of the products.

At the customer's request, OMRON will provide applicable third party certification documents identifying ratings and limitations of use that apply to the products. This information by itself is not sufficient for a complete determination of the suitability of the products in combination with the end product, machine, system, or other application or use.

The following are some examples of applications for which particular attention must be given. This is not intended to be an exhaustive list of all possible uses of the products, nor is it intended to imply that the uses listed may be suitable for the products:

- Outdoor use, uses involving potential chemical contamination or electrical interference, or conditions or uses not described in this catalog.
- Nuclear energy control systems, combustion systems, railroad systems, aviation systems, medical equipment, amusement machines, vehicles, safety equipment, and installations subject to separate industry or government regulations.
- Systems, machines, and equipment that could present a risk to life or property.

Please know and observe all prohibitions of use applicable to the products.

NEVER USE THE PRODUCTS FOR AN APPLICATION INVOLVING SERIOUS RISK TO LIFE OR PROPERTY WITHOUT ENSURING THAT THE SYSTEM AS A WHOLE HAS BEEN DESIGNED TO ADDRESS THE RISKS, AND THAT THE OMRON PRODUCTS ARE PROPERLY RATED AND INSTALLED FOR THE INTENDED USE WITHIN THE OVERALL EQUIPMENT OR SYSTEM.

PROGRAMMABLE PRODUCTS

OMRON shall not be responsible for the user's programming of a programmable product, or any consequence thereof.

Disclaimers

CHANGE IN SPECIFICATIONS

Product specifications and accessories may be changed at any time based on improvements and other reasons.

It is our practice to change model numbers when published ratings or features are changed, or when significant construction changes are made. However, some specifications of the products may be changed without any notice. When in doubt, special model numbers may be assigned to fix or establish key specifications for your application on your request. Please consult with your OMRON representative at any time to confirm actual specifications of purchased products.

DIMENSIONS AND WEIGHTS

Dimensions and weights are nominal and are not to be used for manufacturing purposes, even when tolerances are shown.

PERFORMANCE DATA

Performance data given in this catalog is provided as a guide for the user in determining suitability and does not constitute a warranty. It may represent the result of OMRON's test conditions, and the users must correlate it to actual application requirements. Actual performance is subject to the OMRON Warranty and Limitations of Liability.

ERRORS AND OMISSIONS

The information in this document has been carefully checked and is believed to be accurate; however, no responsibility is assumed for clerical, typographical, or proofreading errors, or omissions.

2008.11

In the interest of product improvement, specifications are subject to change without notice.

OMRON Corporation
Industrial Automation Company

<http://www.ia.omron.com/>

(c)Copyright OMRON Corporation 2008 All Right Reserved.